

## NEED MORE HELP?

For all support go to [jabra.com/support](https://jabra.com/support)



QUICK START



FAQ



VIDEOS



DOWNLOADS



TROUBLESHOOTING



CONTACT SUPPORT

[jabra.com/streamer](https://jabra.com/streamer)

JABRA STREAMER

**Jabra**<sup>®</sup>  
YOU'RE ON

**GET STARTED IN UNDER**

**5**  
**MINUTES**

[jabra.com/streamer](https://jabra.com/streamer)

A BRAND BY

**GN Netcom**

---

© 2014 GN Netcom A/S (North America: GN Netcom US, Inc.). All rights reserved. Jabra® is a registered trademark of GN Netcom A/S. All other trademarks included herein are the property of their respective owners. The Bluetooth® word mark and logos are owned by the Bluetooth SIG, Inc. and any use of such marks by GN Netcom A/S is under license. (Design and specifications subject to change without notice).

---

MADE IN CHINA  
MODEL: HFS005



**Bluetooth®**

---

Declaration of Conformity can be found on  
[www.jabra.com/CP/US/declarations-of-conformity](http://www.jabra.com/CP/US/declarations-of-conformity)

ENGLISH .....	1
FRANÇAIS .....	7
DEUTSCH .....	13
NEDERLANDS .....	19
ITALIANO .....	25
ESPAÑOL.....	31
MAGYAR.....	37
ROMÂNĂ.....	43
DANSK/SVENSKA .....	49
РУССКИЙ .....	55

# WHAT'S IN THE BOX

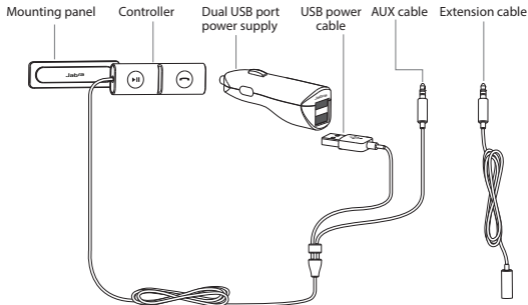

# 1 DASHBOARD SETUP

ENGLISH

1. Peel off the back sticker of the mounting panel, and attach it to an optimal location on the dashboard.

Avoid air vents and speakers.

2. Attach the controller to the mounting panel.
3. Plug the USB power cable into the USB power supply, and the AUX cable into the dashboard AUX port.
4. Turn on the car stereo, and ensure the input is set to AUX.

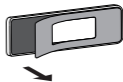

- Optimal mounting locations

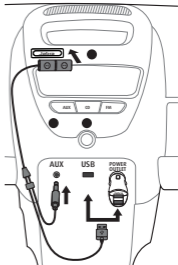

## 2 CONNECT TO MOBILE DEVICE

1. The first time the Jabra Streamer is connected to power it will attempt to connect to your mobile device.
2. Simply select the Jabra Streamer in the Bluetooth pairing list on your mobile device to connect and begin streaming your music.

The Jabra Streamer turns on and off with your car.

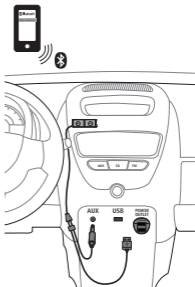

## CONNECT TO ANOTHER MOBILE DEVICE

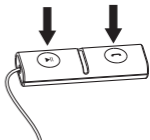

1. Press and hold (3 secs) both the **Answer/End** button and the **Play/Pause** button on the controller to begin the Bluetooth connection.
2. Select the Jabra Streamer in the Bluetooth pairing list on your mobile device.



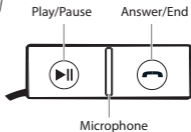
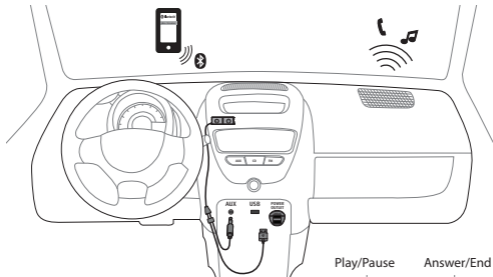

# 3 HOW TO USE



	<b>FUNCTION</b>	<b>ACTION</b>
	Play/pause music	Tap the <b>Play/Pause</b> button
	Skip track	Double-tap the <b>Play/Pause</b> button to skip forward. To skip back, triple-tap the <b>Play/Pause</b> button
	Answer/end call	Tap the <b>Answer/End</b> button
	Reject call	Double-tap the <b>Answer/End</b> button
	Redial last number	Double-tap the <b>Answer/End</b> button when not on a call
	Voice controls	Tap the <b>Answer/End</b> button when not on a call to access your phone's voice controls
	Adjust volume	Use the phone's volume controls, or the car speaker volume controls