

USER GUIDE

BEHIND-THE-EAR (BTE) MODELS:

STANDARD TUBE

THIN TUBE



ReSound



rediscover hearing

Statement:

This device complies with Part 15 of the FCC Rules.

Operation is subject to the following two conditions: (1) this device may not cause harmful interference, and (2) this device must accept any interference received, including interference that may cause undesired operation.

Note: This equipment has been tested and found to comply with the limits for a Class B digital device, pursuant to part 15 of the FCC Rules. These limits are designed to provide reasonable protection against harmful interference in a residential installation. This equipment generates, uses and can radiate radio frequency energy and, if not installed and used in accordance with the instructions, may cause harmful interference to radio communications. However, there is no guarantee that

interference will not occur in a particular installation. If this equipment does cause harmful interference to radio or television reception, which can be determined by turning the equipment off and on, the user is encouraged to try to correct the interference by one or more of the following measures:

- Reorient or relocate the receiving antenna.
- Increase the separation between the equipment and receiver.
- Connect the equipment into an outlet on a circuit different from the one in which the receiver is connected.
- Consult the dealer or an experienced radio/TV technician for help.

Changes or modifications can void the user's authority to operate the equipment

Intended use

Hearing Instruments are intended for hearing impaired people to improve their hearing. The essential purpose of the hearing instruments is to receive, amplify and transfer sound to the ear drum of a person with hearing loss.

List of countries:

Products without wireless functionality are intended for worldwide sales.

Products with wireless functionality are intended for sale in countries within the European Economic Area as well as Switzerland.

Specification of restrictions: You are not allowed to operate the equipment within 20 km of the centre of Ny Ålesund, Norway.

The products are in compliance with the following regulatory requirements:

- In EU: the device conforms to the Essential Requirements according to Annex I of Council Directive 93/42/EEC for medical devices (MDD) and essential requirements and other relevant provisions of Directive 1999/5/EC (R&TTE). The declaration of conformity may be consulted at www.resound.com
- In US: FCC CFR 47 Part 15, subpart C, section 15.249.
- Other identified applicable international regulatory requirements in countries outside the EU and US. Please refer to local country requirements for these areas.
- Products are categorized as class 2 receivers according to EN 300 440

Introduction

Congratulations on the purchase of your new hearing instruments. ReSound's innovative sound technology and design, combined with the customized programming selected by your hearing care professional, will make hearing a more enjoyable experience. Hearing instruments will enable you to hear sounds that you may not have heard in years because of your hearing loss. Practice and a positive attitude are important in learning to use hearing instruments. Your ReSound instruments have been adjusted according to your individual hearing loss and needs. Some people adjust quickly to wearing hearing instruments in their ears and hearing new sounds; other people may need more time.

Please read this manual carefully in order to wholly benefit from the use of your hearing instruments. With proper care, maintenance, and usage, your hearing instruments will aid you in better communication for many years. Ask your hearing care professional if you have any questions.

ReSound is a registered trade mark of GN ReSound A/S

Hearing instrument model: _____

Battery size: _____ Tube type: _____ Dome size: _____

Left serial number: _____ Right serial number: _____

Contents

Statement	2	Inserting/removing hearing instruments . . .	16	Direct audio input (optional).	30	Battery warning Information	41
Intended use	4	Operation of the hearing instrument	20	Connecting/Disconnecting audio boots .	30	Troubleshooting guide	42
List of countries	4	Volume control (optional).	20	Care and maintenance	32	Technical Data	50
Introduction	6	Programme button (optional).	21	Daily maintenance	33	Warranty and repairs	51
Description of the hearing instruments . . .	10	Flight mode	23	Cleaning earmoulds	33	Temperature test, transport and storage information.	52
Getting started	12	Telephone use	24	Cleaning thin tubes and domes	34		
On/Off function	12	Listen to radio or TV	25	How to apply domes	35		
SmartStart	12	Cellular phones	25	ReSound Standard domes	35		
Inserting/Replacing the battery	13	PhoneNow	26	ReSound Tulip domes	36		
Low battery indicator	14	Telecoil (optional)	29	General precautions.	37		
Sports lock	15	Tele-loop systems	29	General warnings.	38		

Hearing instrument type designation is: M70-80 and this document contains information regarding the following models of these types:

Available in following variants:

AL987-DVIW

AL977-DVIW Open

AL977-DVIW

AL787-DVIW

AL777-DVIW Open

AL777-DVIW

AL587-DVIW

AL577-DVIW Open

AL577-DVIW

1. Programme button
2. Battery compartment & On/Off switch
3. Sound outlet
4. Front microphone inlet
5. Back microphone inlet
6. Volume control (optional)
7. Direct audio input
8. Left/Right indicator (Left=Blue/Right=Red)
9. Battery lock (optional)
10. Model
11. Manufacturer
12. Serial number
13. Sports lock

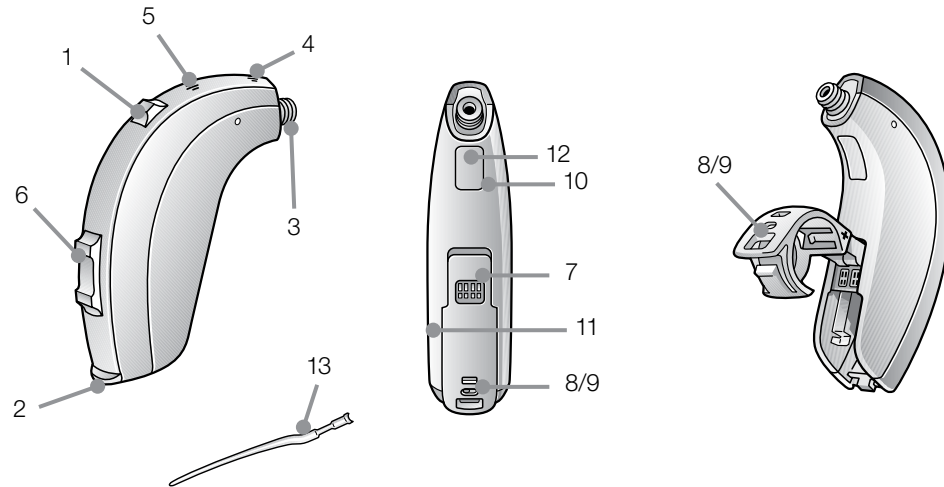

Getting started

On/Off function

1. When the battery door is closed, the hearing instrument turns on, and the default program will be activated.
2. To turn off the hearing instrument, open the battery door. Many individuals can use their fingernail to pull it open.

 Tip: Whenever the hearing instruments are not in use, remember to turn them off to avoid unnecessary battery consumption.

SmartStart

Hearing instruments can be turned on once you have placed them on your ears. If you prefer to turn them on just prior to placing them on your ear, your hearing care professional can activate a function called SmartStart. This function will delay the time in which the hearing instruments

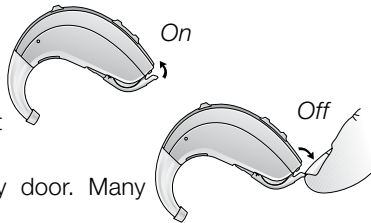

turn on by several seconds after the battery compartment is closed. With SmartStart, a beep will be heard for each second of the delay period.

Inserting/Replacing the battery

3. Open the battery door completely by using your fingernail.
4. Remove the used battery if present. Insert the new battery with the positive side in the correct position.
5. Always use new Zinc-Air batteries that have a minimum remaining shelf life of 1 year.
6. Gently close the battery door.

 Tip: Remove the batteries to prevent battery leakage or corrosion when the hearing instruments are not in use for an extended period of time.

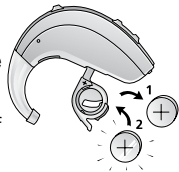

Low battery indicator

Your hearing care professional can activate a low battery indicator in your hearing instruments. The hearing instrument will reduce amplification and play a melody if battery power gets too low. This signal will recur every five minutes until the hearing instrument automatically switches off. The timing of the low battery indicator can vary slightly, depending on the type of battery used. It is recommended that you keep spare batteries on hand.

Low battery indicator (instruments paired with accessories only)

Active usage of the ReSound Unite accessories (Remote Control, Phone Clip and Unite TV) requires more battery power from the hearing instruments than when they are working without accessories. When the battery in the hearing instrument has depleted to a level at which use of the ReSound Unite TV and Phone Clip cannot be supported, the hearing instrument will play two sets of descending tones. After this, your hearing instrument and ReSound Unite Remote Con-

trol will continue to work as usual, but you will not be able to use your ReSound Unite TV and Phone Clip. At some point the battery level will also be too low to support the remote control as well and you will once again hear the descending tones. The hearing instruments will continue to work as usual. Once a new battery is inserted, full operation of the accessories will resume.

Sports lock

The Sports lock will be applied or adjusted by your hearing care professional.

Inserting/Removing hearing instruments

Insertion (custom earmoulds)

1. Hold the earmould between your thumb and index finger and position its sound outlet in your ear canal.
2. Slide the earmould all the way into your ear with a gentle, twisting movement.
3. Turn the top part of the earmould gently backwards and forwards so that it tucks behind the fold of skin above your ear canal.
4. Move the earmould up and down and gently press to ensure it is positioned correctly in the ear. Opening and closing your mouth can ease insertion.
5. Make sure the hearing instrument is seated behind the ear.

By experimenting, an easier method may be discovered. With proper insertion, hearing instruments should fit snugly but comfortably. If the hearing instruments cause irritation of the ears, contact your hearing care professional.



Note: Never attempt to modify the shape of the hearing instrument, earmoulds, or tubing yourself.



Tip: It may be helpful to pull your ear up and outward with your opposite hand during insertion.

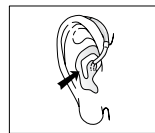
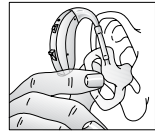

Insertion (domes/custom earmoulds with thin tubes)

1. Hold the thin tube where it bends, and gently push the dome into the ear canal. Push the dome far enough into the ear canal so that the thin tube lies flush with the head.
2. It is important that the tube and the dome fit correctly into your ear.
3. When the dome is placed correctly, you should not be able to see the thin tube sticking out when facing a mirror.



Note: You should never attempt to bend or modify the shape of the thin tube.

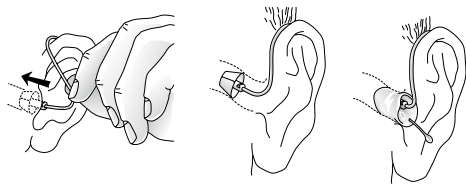

Removal (custom earmolds)

1. Hold a portion of your earmould towards the back of the ear.
2. Pull the earmould outward and simultaneously rotate the earmould forward.
3. Consult your hearing care professional if you have difficulties removing the hearing instrument.

Removal (domes/custom earmoulds with thin tubes)

1. Hold the thin tube with your thumb and forefinger and pull the tube outward.
2. For thin tube custom earmoulds, grasp the removal string and pull the earmould outward.
3. Consult your hearing care professional if you have difficulties removing the hearing instrument.

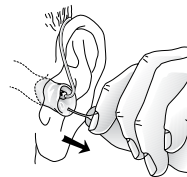

Operation of the hearing instrument

Volume control (optional)

The volume control will allow the volume of hearing instruments to be increased or decreased.

1. To increase the volume, push the volume control up.
2. To decrease the volume, push the volume control down.

When volume is increased or decreased, a beep signal will be heard for each incremental change. When the upper or lower limits of the volume range are reached, a beep signal with a longer duration will be heard.

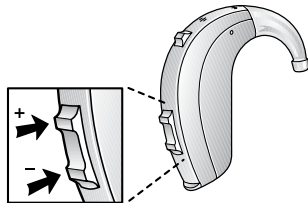

Programme button

Depending on your experience level with hearing instruments, individual hearing needs, and the type of listening environments you experience, your hearing care professional may activate additional programmes. If additional programmes have been activated, the following list explains how they work.

1. You can switch between programmes by pushing the push button once.
2. You will then hear one or more beeps. The number of beeps indicates which programme you have selected (one beep = programme one, two beeps = programme two, etc.).
3. When the hearing instruments are turned off and then back on, the hearing instrument always returns to the default setting (programme one).

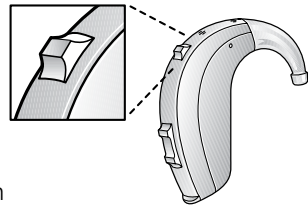

Programme	Description of when to use
1	
2	
3	
4	

Flight mode*



When boarding a flight wireless functionality must be deactivated, as it is not allowed to radiate radio signals during flights.

It is possible to disable wireless operation by opening and closing the battery compartment of the hearing instrument while at the same time pressing the push button.

When disabled manually, wireless operation may be re-enabled by opening and closing the battery compartment normally, (i.e. without at the same time pressing the push button).

**Instruments paired with ReSound Unite accessories only*

Telephone use

Finding the optimal position for holding a telephone may require practice for some individuals, and one or more of the following suggestions may be helpful.

1. Hold the telephone as you would normally.
2. Hold the telephone towards the top of the ear (closer to where the microphones are).
3. If whistling occurs, it may take a few seconds of holding the telephone in the same position before the hearing instrument eliminates the feedback.
4. Any whistling may also be decreased by holding the telephone slightly away from the ear.
5. Depending on your individual needs, your hearing care professional may activate a programme specifically for telephone use.

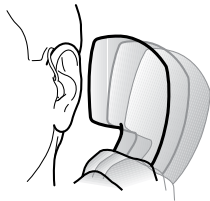

Listen to radio or TV

When listening to the TV or the radio, start out by listening to news commentators since they usually speak clearly, then try other programmes.

If you find it difficult to listen to TV or radio, your hearing care professional will be able to give you advice on available accessories to enhance your listening capabilities for TV and radio.

Cellular phones

Your hearing instrument is designed to comply with the most stringent Standards of International Electromagnetic Compatibility. However, not all cell phones are hearing instrument compatible. The varying degree of disturbance can be due to the nature of your particular cellular phone or of your wireless telephone service provider.

If you find it difficult to obtain a good result while using your cellular phone, your hearing care professional will be able to give you advice on available accessories to enhance listening capabilities.

PhoneNow

The PhoneNow function, allows your hearing instrument to automatically switch to your telephone programme when a telephone receiver is raised to the ear. When the telephone receiver is removed from the ear, the hearing instrument automatically returns to the previous listening programme.

Placement of PhoneNow magnets

In order to place PhoneNow magnets properly:

1. Clean the telephone receiver thoroughly.
2. Hold the telephone vertically, in a position similar to when making a telephone call.
3. Place the magnets just below the telephone receiver. If necessary, move the magnet to another position to improve ease of use and comfort while speaking.

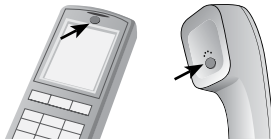

4. Only use a recommended cleaning agent to clean the telephone prior to placing the magnet on the phone.

PhoneNow usage

Telephones can be used in a normal manner. A short melody will indicate that the PhoneNow feature has automatically switched the hearing instrument to your telephone programme. Initially, you may need to move the telephone receiver slightly to find the best position for reliable PhoneNow activation and good hearing on the telephone.

PhoneNow precautions



1. Keep magnets out of reach of pets, children and people with mental disabilities. If a magnet is swallowed, please seek advice from a medical practitioner.

2. The magnet used to strengthen the magnetic field of a telephone receiver may affect functionality of some medical devices or electronic systems. Always keep the magnet or a telephone equipped with the magnet at least 30 cm (12") away from pacemakers, credit cards and other magnetically sensitive devices.
3. High distortion during dialing or phoning may mean that the magnet is not in the optimal position relative to the telephone receiver. To avoid the issue, please move the magnet to another place on the telephone receiver.
4. Only use magnets supplied by GN ReSound.

Telecoil (optional)

If equipped, a telecoil can be activated by your hearing care professional and accessed through one of the additional programmes. A telecoil picks up a telephone's magnetic signal and converts it to sound. An optional telephone programme may help to improve speech understanding on the telephone. When using a telecoil programme, the receiver of the telephone may need to be held closer to the hearing instrument. The handset of the telephone may need to be moved to slightly different positions in order to find the best reception.

Tele-loop systems

Many places, such as theatres, houses of worship, and schools are equipped with tele-loop systems. When using a telecoil programme with tele-loop systems, sound is picked up directly and may improve speech understanding. If there is no sound from the hearing instruments in a tele-loop system and with a telecoil programme activated, the tele-loop system may not be turned on or is not operating correctly. If a facility is not equipped with a tele-loop system, sitting as close as possible to the front may be helpful.

Direct audio input (optional)

Use of direct audio input (DAI), which enables a direct connection of the hearing instruments to items such as television, radio, and remote microphones, may increase speech understanding for some individuals. The sound source is connected to the hearing instruments by a cable or a wireless FM system to the audio boot. This accessory connects to the bottom of the hearing instruments, and once properly clicked into place, the hearing instruments switch to DAI automatically.

Connecting/Disconnecting audio boots

Connecting audio boots

1. Align the tip of the audio boot with the groove just above the battery compartment and below the model number.

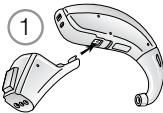

2. Once in place, move the boot in the direction of the battery compartment.
3. Gently click the audio boot onto the hearing instrument.

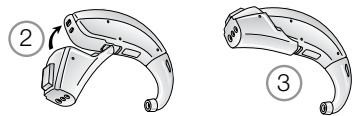

Disconnecting audio boots

4. Press and hold the button on the front side of the audio boot.
5. Gently remove the audio boot from the hearing instrument.

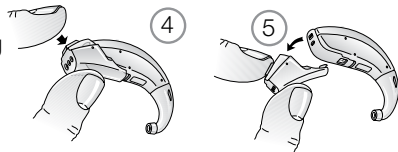

Care and maintenance



Proper handling

Your hearing instrument is protected by a layer of protective, hydrophobic nanocoat material. However, please follow these instructions to further prolong the durability of your hearing instruments.

1. Never immerse hearing instruments in water or other liquids, as liquids may cause permanent damage to the hearing instruments.
2. Avoid rough handling of hearing instruments or dropping them on hard surfaces or floors.
3. Do not leave hearing instruments in or near direct heat or sunlight, as excessive heat can cause damage or deform the casing.
4. Hair spray, make-up, etc. may damage hearing instruments. Remove the instruments prior to the application of cosmetics.

Daily maintenance



It is important to keep your hearing instrument clean and dry. On a daily basis, clean the hearing instruments using a soft cloth or tissue. In order to avoid damage due to humidity or excessive perspiration, the use of a drying kit is recommended.

Cleaning earmoulds



1. Remove the earmould and attached tubing from the hearing instruments prior to cleaning.
2. Clean the earmould using a mild soap, and rinse with lukewarm water.
3. After cleaning, dry earmoulds thoroughly and remove any residual water and debris from the tubing utilising an air bulb and wire loop.



i Note: Earmould tubing may become stiff, brittle, or discoloured over time. Contact your hearing care professional regarding tube changes.

Cleaning thin tubes and domes **i**

1. Remove thin tubes from hearing instruments before cleaning by unscrewing them counter clockwise.
2. Wipe down thin tubes and domes with a damp cloth.
3. In order to clear the thin tube of moisture and debris, push the black cleaning rod through the thin tube, beginning at the end opposite the dome.

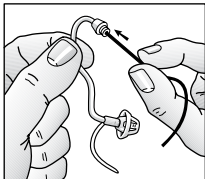

Note: Thin tube and dome systems should be changed every three months or sooner, should the components become stiff or brittle.

How to apply domes

It is recommended that your hearing care professional change domes, as incorrect dome replacement could result in the dome falling out in the ear.

ReSound Standard domes

1. Push the new dome over the flanges on the thin tube.
2. Make sure that the new dome is properly and securely mounted.

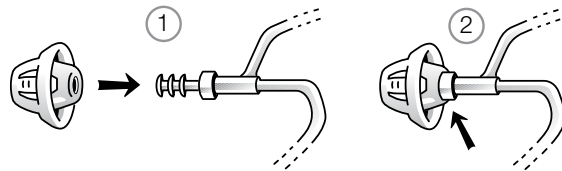

ReSound Tulip domes

Tulip domes are mounted in a similar manner to standard domes, but a few extra steps are required. Tulip domes consist of two “petals”. It is important to note that the largest petal is the outermost petal. To ensure this:

1. Push the largest petal away from the thin tube using a finger. This bends the petal forward.
2. Then push the largest petal back, and it will be placed on top of the smaller petal.

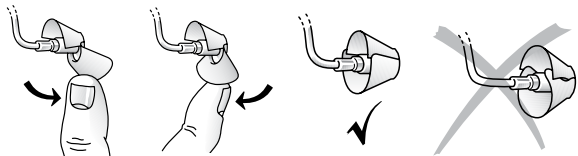

General precautions



1. Do not leave hearing instruments in the sun, near an open fire, or in a hot, parked car.
2. Do not wear hearing instruments while showering, swimming, in heavy rain, or in a moist atmosphere such as a steam bath or sauna.
3. Should the hearing instrument become moist, remove the battery and place the hearing instrument in a closed container with a drying agent. Your hearing care professional can provide options for drying containers or kits.
4. Remove the hearing instruments when applying items such as cosmetics, perfume, after-shave, hair spray, and suntan lotion.
5. When wireless function is activated, the device uses low-powered digitally coded transmissions in order to communicate with other wireless devices. Although unlikely, nearby electronic devices may be affected. In that case, move the hearing instrument away from the affected electronic device.

6. When using wireless functionality and the devices are affected by electromagnetic interference, move away from the source.

General warnings



1. Consult a hearing care professional if you think there may be a foreign object in your ear canal, if you experience skin irritation, or if excessive ear wax accumulates with the use of the hearing instrument.
2. Different types of radiation, from e.g. NMR, MRI, or CT scanners, may damage hearing instruments. It is recommended not to wear hearing instruments during these or other similar procedures. Other types of radiation, such as burglar alarms, room surveillance systems, radio equipment, mobile telephones, contain less energy and will not damage hearing instruments. However, they have the potential to momentarily affect the sound quality or temporarily create strange sounds from hearing instruments.

3. Do not wear hearing instruments in mines, oil fields, or other explosive areas unless those areas are certified for hearing instrument use.
4. Do not allow others to use your hearing instruments. This may cause damage to the hearing instruments or to the hearing of the other individual.
5. Due to choking hazards, hearing instrument usage by children or individuals who are mentally challenged should be supervised at all times.
6. Hearing instruments should be used only as prescribed by your hearing care professional. Incorrect use may result in hearing loss.
7. Warning to hearing care professionals: Special care should be exercised in selecting and fitting hearing instruments with maximum sound pressure level that exceeds 132dB SPL with an IEC 60711:1981 occluded ear simulator. There may be a risk of impairment of the remaining hearing.
8. Be careful when boarding flights to deactivate the wireless functionality.

9. Keep magnets out of reach of pets, children and people with mental disabilities. If a magnet is swallowed, please seek advice from a medical practitioner.
10. Turn off your wireless functionality by using the flight mode in areas where radio frequency emission is prohibited.
11. Only connect ReSound hearing instruments to ReSound accessories intended and qualified to be used with ReSound hearing instruments.
12. For use of wireless functionality only use ReSound Unite accessories. For further guidance please refer to the user guide of the relevant ReSound Unite accessory.

Battery warning information

Batteries, although very small, contain dangerous substances, and should be disposed of carefully. This is for the safety of you and the environment. Please note:

1. DO NOT attempt to recharge standard zinc air batteries. They may leak or explode.
2. DO NOT attempt to dispose of batteries by burning them.
3. DO NOT place batteries in your mouth. Consult a physician immediately if a battery has been swallowed, as they can be harmful to your health.
4. Keep batteries away from pets, children and individuals who are mentally challenged.

TROUBLESHOOTING GUIDE

SYMPTOM	CAUSE	POSSIBLE REMEDY
No sound	<ul style="list-style-type: none">• Not turned on• Dead battery• Battery door will not close• Blocked earmould or tube• Blocked wax filter	<ul style="list-style-type: none">• Turn on by closing the battery door• Replace battery• Insert battery properly• Clean earmould or tube• Replace wax filter or consult your hearing care professional

TROUBLESHOOTING GUIDE

SYMPTOM	CAUSE	POSSIBLE REMEDY
Not loud enough	<ul style="list-style-type: none">• Incorrect earmould placement• Blocked earmould or dome• Blocked sound outlet filter• Change in hearing sensitivity• Excessive ear wax• Volume set too low	<ul style="list-style-type: none">• Reinsert earmould• Clean earmould, replace dome, replace filter• Change filter or consult your hearing care professional• Consult your hearing care professional• Consult your physician• Increase the volume control if available or consult your hearing care professional

TROUBLESHOOTING GUIDE

SYMPTOM	CAUSE	POSSIBLE REMEDY
Excessive whistling / feedback	<ul style="list-style-type: none">• Incorrect earmould placement• Incorrect dome placement• Excessive ear wax• Feedback control may need adjustment• Earmould tubing worn or damaged• Thin tube connection loose• Hearing instrument settings not optimal	<ul style="list-style-type: none">• Re-insert earmould carefully• Re-insert dome• Consult your hearing care professional• Consult your hearing care professional• Consult your hearing care professional• Change thin tube or consult your hearing care professional• Consult your hearing care professional

TROUBLESHOOTING GUIDE

SYMPTOM	CAUSE	POSSIBLE REMEDY
Sound distorted / not clear	<ul style="list-style-type: none">• Weak battery• Improper earmould or dome fit• Hearing instrument damaged• Hearing instrument settings not optimal	<ul style="list-style-type: none">• Replace battery• Consult your hearing care professional• Consult your hearing care professional• Consult your hearing care professional

If there are any other problems not mentioned in this guide, please contact your hearing care professional.

Technical Data

Hearing Instrument Model	Maximum output (2ccCoupler / IEC 60118-7)
Models AL977/87-DVIW , AL777/87-DVIW, AL577/87-DVIW are available in following variants: Standard tube	
AL977-DVIW, AL777-DVIW, AL577-DVIW Open	123 dB SPL (typical)
AL977-DVIW, AL777-DVIW, AL577-DVIW	127 dB SPL (typical)
AL987-DVIW, AL787-DVIW, AL587-DVIW	130 dB SPL (typical)

Warranty and repairs

ReSound provides a warranty on hearing instruments in the event of defects in workmanship or materials, as described in applicable warranty documentation.

In its service policy, ReSound pledges to secure functionality at least equivalent to the original hearing instrument.

As a signatory to the United Nations Global Compact initiative, ReSound is committed to doing this in line with environment-friendly best practices. Hearing instruments therefore, at ReSound's discretion, may be replaced by new products or products manufactured from new or serviceable used parts, or repaired using new or refurbished replacement parts.

The warranty period of hearing instruments is designated on your warranty card, which is provided by your hearing care professional.

For hearing instruments that require service, please contact your hearing care professional for assistance.

ReSound hearing instruments that malfunction must be repaired by a qualified technician. Do not attempt to open the case of hearing instruments, as this will invalidate the warranty.

Temperature test, transport and storage information

GN ReSound Hearing Instruments are subjected to various tests in temperature and damp heating cycling between -25 C and +70C according to internal and industry standards.

During transport or storage, the temperature should not exceed the limit values of -20C to 60C and relative humidity of 90% RH, non condensing (for limited time). The air pressure between 500 and 1100 hPa is appropriate.

Be aware of information marked with the warning symbol



WARNING points out a situation that could lead to serious injuries,
CAUTION indicates a situation that could lead to minor and moderate injuries.



Advice and tips on how to handle your hearing instrument better.



Equipment includes RF transmitter.



Product is a Type B applied part.

Worldwide Headquarters

ReSound A/S
Lautrupbjerg 7
DK-2750 Ballerup, Denmark
Tel.: +45 45 75 11 11
Fax: +45 45 75 11 19
www.resound.com

United Kingdom

GN ReSound Ltd.
Kirtlington Business Centre
Portway
Kirtlington
Oxon OX5 3JA
Tel.: +44 1869 352 800
Fax: +44 1869 343 466
www.gnresound.co.uk

Australia

GN ReSound Pty. Ltd.
Unit R1 Regents Park Estate
391 Park Road
Regents Park NSW 2143
Tel.: (free) 1800 658 955
Fax: +61 2 9743 7472
www.gnresound.com.au

New Zealand

GN ReSound (NZ) Ltd.
12 Parkway Drive
Mairangi Bay
Auckland
Tel.: (free) 0800 900 126
Fax: (free) 0800 007 695
www.gnresound.co.nz

CE
0297



Any issues relating to the EU Medical Device Directive 93/42/EEC, or Council Directive 1999/5/EEC on Radio Equipment and Telecommunications terminal equipment should be directed to ReSound A/S

ReSound

rediscover hearing