

Jabra JX 10

WITH BLUETOOTH HUB

User manual

Dual-use headset for in the office and on the go

Jabra

English

Table of contents

Thank you	5
1. What's in the box	5
About your Jabra JX10 Headset	6
What your headset can do	6
Specifications	7
About your Jabra Bluetooth Hub	7
What your Jabra JX10 with Bluetooth Hub can do	7
2. Using the buttons: tap, press, press and hold, double tap	7
3. Headset setup, charging and use	8
Setting up your headset to wear it how you like it	8
Charging your headset	9
Charging from your desk stand	9
Using the AC adaptor to charge directly from a power socket	9
Turning your headset on and off	10
Adjusting the volume	10
4. For use with desk phone	10
Jabra Bluetooth Hub setup	10
Connecting your Jabra Bluetooth Hub with desk phone and power supply	10
How to pair your Jabra Bluetooth Hub and headset	11
Adjusting settings with a test call from your desk phone	11
Use	12
Making and ending a call from your desk phone	12
Answering and ending a call to your desk phone	12
Switching from headset to handset	12
Switching from handset to headset	12
Staying within range	13

5. For use with desk phone with headset port	13
Jabra Bluetooth Hub setup	13
Connecting your Jabra Bluetooth Hub with desk phone and power supply	13
How to pair your Jabra Bluetooth Hub and headset	14
Adjusting settings with a test call from your desk phone.....	14
Use.....	15
Making and ending a call from your desk phone	15
Answering and ending a call to your desk phone.....	15
Switching from headset to handset	15
Switching from handset to headset	15
Staying within range.....	16
6. For use with desk phone with GN1000 (remote handset lifter)	16
Jabra Bluetooth Hub setup	16
Connecting your Jabra Bluetooth Hub with desk phone and power supply	16
How to pair your Jabra Bluetooth Hub and headset	17
Adjusting settings with a test call from your desk phone.....	17
Use.....	18
Making and ending a call to a desk phone	18
Answering and ending a call to a desk phone	18
Switching from headset to handset	18
Switching from handset to headset	18
Staying within range.....	19
7. For use with a desk phone with electronic hookswitch (EHS)	19
Jabra Bluetooth Hub setup.....	19
Connecting your Jabra Bluetooth Hub with desk phone and power supply	19
How to pair your Jabra Bluetooth Hub and headset	20
Adjusting settings with a test call from your desk phone.....	20

Use	21
Making and ending a call to a desk phone	21
Answering and ending a call to a desk phone	21
Switching from headset to handset	21
Switching from handset to headset	21
Staying within range	21
8. For mobile phones	22
Setup	22
Pairing your headset with your mobile phone	22
Use	23
Making and ending a mobile phone call	23
Answering and ending an incoming mobile phone call	23
Switching from headset to mobile phone	23
Switching from mobile phone to headset	23
Rejecting an incoming call	23
Making a call with Voice Dial	24
Redialing the last number	24
Using call waiting and placing a call on hold	24
Staying within range	24
9. What the lights mean	25
10. Troubleshooting	25
11. Maintenance, safety and disposal	26
Taking care of your headset	26
Taking care of your Jabra Bluetooth Hub	27
Children and product packaging	27
Batteries and product disposal	27
12. Glossary	27
13. Bluetooth®	28
14. Waste of Electrical and Electronic Equipment (WEEE)	28
Customer Contact Details	29

Thank you

Thank you for purchasing the Jabra JX10 with Bluetooth Hub. We hope you enjoy it!
This instruction manual will help you make the most of your dual-use headset.

NOTE: Remember, driving comes first, not the call!

Using a mobile phone while driving can distract you and increase the likelihood of an accident. If driving conditions demand it (such as bad weather, high traffic density, presence of children in the car, difficult road conditions), pull off the road and park before making or answering calls. Also, try to keep conversations short and do not make notes or read documents.

Always drive safely and follow local laws.

1 What's in the box

Fig. 1

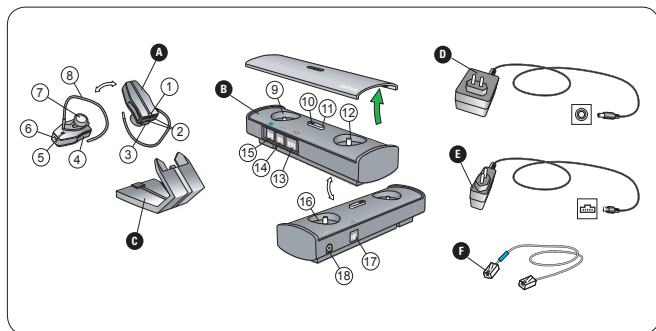

A. Jabra JX 10 headset

1. Light indicator (LED)
2. Volume controls
3. Charging socket
4. Answer/End button (also On/Off)
5. Pairing button
6. Microphone
7. Speaker
8. Earhook

* for use with optional handset lifter

** not for use with Jabra JX10 Headset

B. Jabra Bluetooth Hub

9. Dial Tone Finder
10. Light indicator (LED)
11. Pairing button
12. Microphone volume control
13. AUX socket*
14. Handset socket
15. Desk phone socket
16. Reset button
17. Desk stand socket**
18. Power supply socket

C. Desk stand**D. Bluetooth Hub power supply****E. Headset power supply****F. Desk phone-Bluetooth Hub connection cord****About your Jabra JX10 Headset****What your headset can do**

Your Jabra JX10 lets you do all this:

- Answer calls
- End calls
- Reject calls*
- Voice Dial*
- Redial last number*
- Call waiting*
- Call hold*

* Phone dependent

Specifications

- Up to 6 hours talk time, up to 200 hours standby time
- Rechargeable battery with charging option from desk stand charger, AC power supply. The headset can also be charged via a USB/PC cable (not included) or car charger (not included).
- headset Less than 10 grams
- Operating range up to 33 feet/10 meters
- The Jabra JX10 Headset is designed to work with Bluetooth® mobile phones. It can also work with other Bluetooth® devices that are compliant with Bluetooth® version 1.1 or 1.2 and support a headset and/or hands-free profile.

About your Jabra Bluetooth Hub

What your Jabra JX10 with Bluetooth Hub can do

Your Bluetooth Hub is a 'connectivity hub' that primes your headset for dual use by enabling your desk phone for wireless Bluetooth® communication. Once the Bluetooth Hub is connected, your Jabra JX10** Headset can be used with both your desk phone and your mobile phone (when paired).

The Bluetooth Hub also allows you to connect a GN1000 (remote handset lifter) that automatically lifts and puts down your desk phone's handset, so you don't have to. With this handset lifter, you only tap your headset to answer or end calls through the desk phone.

Stylishly designed, the Bluetooth Hub helps organize your cords, helping keep your desk tidy.

NOTE: *If there is no power to the Bluetooth Hub, the desk phone handset will still work, but the headset will not work with the desk phone. Once your power is restored, you will find all settings (including pairing) intact.*

** Requires Bluetooth Hub compatible Jabra JX10

2

Using the buttons: tap, press, press and hold, double tap

The Jabra JX10 Headset is easy to operate. When using the headset, most functions are activated by the Answer/End button ④. The headset and Bluetooth Hub buttons perform different functions, depending on how you use them. Instructions for using buttons are written in this manual as:

Action	Touch Answer/End for...	Audible indications
Tap	press briefly	1 beep
Press	approximately 1 second	2 beeps
Press and hold	approximately 5 seconds	2 beeps + a series of fading beeps
Double tap	press briefly and repeat	1 beep + 2 short beeps

3 Headset setup, charging and use

! **IMPORTANT:** Before you begin setup, be sure all parts have been above 32°F/0°C for at least 30 minutes.

Setting up your headset to wear it how you like it

For optimal performance, the Jabra JX10 and your mobile phone should be worn on the same side of your body so they can 'see' each other. In general, you will get better performance when there are no obstructions between your headset and your mobile phone or Bluetooth Hub.

The Jabra JX10 is ready to wear on your right ear. If you prefer to wear it on the left (this would be optimal if you prefer to carry your mobile phone in a holder on your left hip), gently remove the earhook ⑧ and flip to fit left ear. **(See Fig. 2.)**

Fig. 2

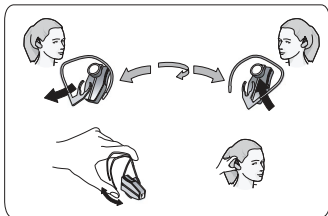

Finally, bend the earhook ⑧ so it fits comfortably on your ear. You can also wear your Jabra JX10 Headset without the earhook.

Charging your headset

Make sure that your Jabra JX10 Headset is fully charged before you start using it. The first full charge takes approximately 2 hours.

You have two options for charging the headset from a mains power supply.

Charging from your desk stand (Fig. 3)

Fig. 3

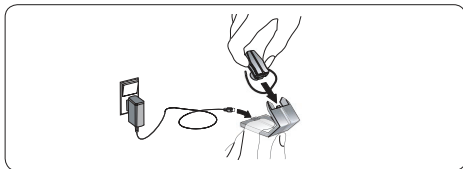

- Connect your AC power adaptor to the desk stand **Ⓒ** and to the power supply.
- Place your headset in the cradle.

Using the AC adaptor to charge directly from a power socket (Fig. 4)

Fig. 4

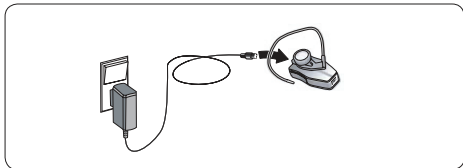

- Plug the headset into the power source using the headset power supply **Ⓔ**.

ⓘ IMPORTANT: Make sure your headset is inactive before charging. If you are on an active call, transfer the call to your handset before you charge your headset.

NOTE: You can also charge you headset via a USB/PC cable or car charger.

When the LED **Ⓛ** is solid red, your headset is charging. When the LED **Ⓛ** is green, it is fully charged.

If the headset is turned on when you put it into the charger, it will remain on while charging and when disconnected from the charger.

If your headset is turned off when you charge it, it will remain off while charging and when disconnected from the charger.

Turning your headset on and off

- **Press** the headset Answer/End button ④ to turn your headset on. The LED① will emit 3 fast blue flashes. If you are wearing the headset, you will hear a series of rising beeps.
- **Press and hold** the headset Answer/End button to turn your headset off. The LED① will emit 3 fast blue flashes. If you are wearing the headset, you will hear 2 beeps followed by a series of fading beeps.

! **IMPORTANT:** *If you are on an active call, transfer the call to your handset before you turn your headset off.*

Adjusting the volume

The Jabra JX10 automatic volume control elevates sound level and quality to match your environment. If necessary, use the volume button ② on your headset up (+) or down (-) to adjust ②.

4 For use with desk phone

This setup will work for most desk phones (not cordless phones).

If your desk phone has a headset port or electronic hookswitch, or you are using a GN1000 (remote handset lifter), you can follow this setup. However, if you wish to access all the features of the Jabra JX10 with Bluetooth Hub, please turn to the relevant chapter for setup and use instructions.

Jabra Bluetooth Hub setup

Connecting your Jabra Bluetooth Hub with desk phone and power supply

- Disconnect the handset from your desk phone (by unplugging the handset from the socket on the desk phone).
- Connect the handset to your Bluetooth Hub's handset socket ⑭.
- Connect the desk phone socket port to the desk phone socket ⑮ on the Bluetooth Hub using the supplied connection cord (desk phone-to-Bluetooth Hub ①).
- Connect the power supply ① to your Bluetooth Hub's power supply socket ⑱.
- Connect the power supply ① to the wall power socket.

The green LED⑩ indicates that the Bluetooth Hub power is on.

In the unlikely event that the Bluetooth Hub is not OK, its LED^⑩ will flash red.

- First, try disconnecting and reconnecting the Bluetooth Hub from the power source.
- If the LED is still flashing red, you must reset your Bluetooth Hub.
 - **Press and hold** the Bluetooth Hub reset button ^⑩.
 - The reset light^⑩ will turn solid red for 3 seconds, and then turn green.

! **IMPORTANT:** *Following reset, you must pair your Bluetooth Hub and headset.*

How to pair your Jabra Bluetooth Hub and headset

! **IMPORTANT:** *Your Bluetooth Hub and headset have been pre-paired at the factory, so this step is only necessary if pairing has been lost, e.g. by resetting.*

- Set your headset into pairing mode by **pressing** its pairing button ^⑤. The LED^① will show a steady blue light and the two devices will 'search' for each other.
- Set your Bluetooth Hub in pairing mode by **pressing and holding** its pairing button ^⑪. The LED^⑩ will show a steady blue light.

NOTE: *Both devices will continue to search for a pair for 5 minutes.*

- When your headset and Bluetooth Hub have paired successfully, the Bluetooth Hub LED^⑩ will flash blue 10 times and then turn green and the headset LED^① will flash blue slowly.

NOTE: *If you accidentally put either the Bluetooth Hub or headset into pairing mode, **tap** the pairing button ^⑤/^⑪ to exit pairing mode.*

One Bluetooth Hub can be paired with multiple headsets, just as one headset can be paired with multiple Bluetooth Hubs. Your headset will 'prioritize' the Bluetooth Hub it has been paired with most recently.

Adjusting settings with a test call from your desk phone

- Place the headset on your ear and **tap** the headset Answer/End button.
- Lift your desk phone handset and listen for a dial tone in your headset.
- If necessary, switch the Bluetooth Hub's Dial Tone Finder ^⑨ from A through G until you hear a clear dial tone. The Dial Tone Finder ^⑨ is preset to setting A, since that setting is most commonly used.
- Dial a friend so you can test the volume of your microphone (how your voice sounds to others).

- Adjust the headset microphone volume ⑫ in the Bluetooth Hub until your friend confirms that your voice can be heard at an appropriate level.
- To end the call, replace the desk phone handset and **tap** the headset Answer/End button.

Use

Making and ending a call from your desk phone

- Place the headset on your ear and **tap** the headset Answer/End button.
- Lift the desk phone handset and listen for the dial tone.
- Dial the desired number.
- To end the call, replace the desk phone handset AND **tap** the headset Answer/End button.

Answering and ending a call to your desk phone

- Place the headset on your ear and **tap** the headset Answer/End button.
- Lift the desk phone handset to connect the call.
- To end the call, replace desk phone handset AND **tap** the headset Answer/End button.

Switching from headset to handset

You can switch from your headset to your desk phone handset during an active call. You might want to do this if, for example, your headset battery is running low.

- Pick up the desk phone handset.
- **Tap** the headset Answer/End button, or place it into the desk stand  for charging.

The call will be transferred to your desk phone handset.

Switching from handset to headset

You can switch from your desk phone handset to your headset during an active call. You might want to do this if, for example, the call was answered on the desk phone handset and you would prefer to use your headset.

- Keep the desk phone handset off the hook.
- **Tap** the headset Answer/End button.

The call will be transferred to the headset.

Staying within range

The sound in your headset will deteriorate if you move beyond range.* Move back into range to restore sound quality.

If you move too far from the Bluetooth Hub, the call will be routed to your desk phone handset. Return into range within 60 seconds and the call will be re-routed back to the headset. If you stay out of range for more than 60 seconds, the call will remain in the handset until the handset is hung up or the call is transferred back to the headset by returning to range and tapping the headset Answer/End button.

Remember!

In general, you will get better performance when there are no obstructions between your headset and your Bluetooth Hub.

* up to 33 feet/10 meters in line of sight

5 For use with desk phone with headset port

Some desk phones are equipped with a headset port, allowing a corded headset to be plugged in directly. When using the headset port, the handset remains in its cradle, making headset use easier. Please refer to your desk phone User Manual for more information.

Jabra Bluetooth Hub setup

Connecting your Jabra Bluetooth Hub with desk phone and power supply

- Connect the desk phone headset port to the Bluetooth Hub desk telephone socket ⑮ using the supplied connection cord (desk phone-to-Bluetooth Hub ⑯).
- Connect the power supply ⑰ to your Bluetooth Hub's power supply socket ⑱.
- Connect the power supply ⑰ to the wall power socket.
- You can use the 'wire guide' at the bottom of the Bluetooth Hub to neatly guide the cable from the desk phone to the wall phone plug.

The green LED⑩ indicates that the Bluetooth Hub power is on.

In the unlikely event that the Bluetooth Hub is not OK, its LED^⑩ will flash red.

- First, try disconnecting and reconnecting the Bluetooth Hub from the power source.
- If the LED^⑩ is still flashing red, you must reset your Bluetooth Hub.
 - **Press and hold** the Bluetooth Hub reset button ^⑩.
 - The reset light^⑩ will turn solid red for 3 seconds, and then turn green.

! IMPORTANT: *Following reset, you must pair your Bluetooth Hub and headset.*

How to pair your Jabra Bluetooth Hub and headset

! IMPORTANT: *Your Bluetooth Hub and headset have been pre-paired at the factory, so this step is only necessary in the unlikely event that pairing has been lost, e.g. by resetting.*

- Set your headset into pairing mode by pressing its pairing button ^⑤. The LED^① will show a steady blue light and the two devices will 'search' for each other.
- Set your Bluetooth Hub in pairing mode by pressing and holding its pairing button ^⑪. The LED^⑩ will show a steady blue light.

NOTE: *Both devices will continue to search for a pair for 5 minutes.*

- When your headset and Bluetooth Hub have paired successfully, the Bluetooth Hub LED^⑩ will flash blue 10 times and then turn green and the headset LED^① will flash blue slowly.

NOTE: *If you accidentally put either the Bluetooth Hub or headset into pairing mode, tap the pairing button ^⑤/^⑪ to exit pairing mode.*

One Bluetooth Hub can be paired with multiple headsets, just as one headset can be paired with multiple Bluetooth Hubs. Your headset will 'prioritize' the Bluetooth Hub it has been paired with most recently.

Adjusting settings with a test call from your desk phone

- Place the headset on your ear and **tap** the headset Answer/End button.
- Press the appropriate button on your desk phone to establish a dial tone.
- If necessary, switch the Bluetooth Hub's Dial Tone Finder ^⑨ from A through G until you hear a clear dial tone. The Dial Tone Finder ^⑨ is preset to setting A, since that setting is most commonly used.
- Dial a friend so you can test the volume of your microphone (how your voice sounds to others).
- Adjust the headset microphone volume ^⑫ in the Bluetooth Hub until your friend confirms that your voice can be heard at an appropriate level.

- To end the call, press the appropriate button on your desk phone AND **tap** the headset Answer/End button.

Use

Making and ending a call from your desk phone

- Place the headset on your ear and **tap** the headset Answer/End button.
- Press the appropriate button on your desk phone to establish a dial tone.
- Dial the desired number.
- To end the call, press the appropriate button on your desk phone AND **tap** the headset Answer/End button.

Answering and ending a call to your desk phone

- Place your headset on your ear and **tap** the headset Answer/End button.
- Press the appropriate button on your desk phone to answer the call, and begin talking.
- To end the call, press the appropriate desk phone button AND **tap** the headset Answer/End button.

Switching from headset to handset

You can switch from your headset to your desk phone handset during an active call. You might want to do this if, for example, your headset battery is running low.

- Pick up the desk phone handset.
- If necessary, press the appropriate button on your desk phone (see *User Manual*).
- **Tap** the headset Answer/End button, or place it into the desk stand  for charging.

The call will be transferred to your desk phone handset.

Switching from handset to headset

You can switch from your desk phone handset to your headset during an active call. You might want to do this if, for example, the call was answered on the desk phone handset and you would prefer to use your headset.

- Keep the desk phone handset off the hook.
- **Tap** the headset Answer/End button.
- If necessary, press the appropriate button on your desk phone (see *desk phone User Manual*).

The call will be transferred to the headset.

NOTE: On some desk phones, you might hear an echo. This is because the headset and handset audio links are both open. If this happens, replace the desk phone handset.

Staying within range

The sound in your headset will deteriorate if you move beyond range.* Move back into range to restore sound quality.

If you move too far from the Bluetooth Hub, the call will be routed to your desk phone handset. Return into range within 60 seconds and the call will be re-routed back to the headset. If you stay out of range for more than 60 seconds, the call may remain active (this is phone dependent, please check your desk phone User Manual for more information).

Remember!

In general, you will get better performance when there are no obstructions between your headset and your Bluetooth Hub.

* up to 33 feet/10 meters in line of sight

6

For use with desk phone with GN1000 (remote handset lifter)

The GN1000 lifts or lowers your handset automatically, allowing you to answer and end calls when you're away from your desk. Jabra Bluetooth Hub setup

Jabra Bluetooth Hub setup

Connecting your Jabra Bluetooth Hub with desk phone and power supply

- Disconnect the handset from your desk phone (by unplugging the handset from the socket on the desk phone).
- Connect the handset to your Bluetooth Hub's handset socket (14).
- Connect the desk phone handset socket to the Bluetooth Hub desk phone socket (15) using the supplied connection cord (desk phone-to-Bluetooth Hub (1)).
- Connect the GN1000 to the AUX socket (13) on the Bluetooth Hub (see **GN1000 User Manual**).
- Connect the power supply (1) to your Bluetooth Hub's power supply socket (18).
- Connect the power supply (1) to the wall power socket.

- You can use the 'wire guide' at the bottom of the Bluetooth Hub to neatly guide the cable from the desk phone to the wall phone plug.

The green LED¹⁰ indicates that the Bluetooth Hub power is on.

Please refer to the GN1000 User Manual for directions on how to set up your GN1000.

In the unlikely event that the Bluetooth Hub is not OK, its LED¹⁰ will flash red.

- First, try disconnecting and reconnecting the Bluetooth Hub from the power source.
- If the LED¹⁰ is still flashing red, you must reset your Bluetooth Hub.
 - o **Press and hold** the Bluetooth Hub reset button ¹⁶.
 - o The reset light will turn solid red for 3 seconds, and then turn green.

! **IMPORTANT:** *Following reset, you must pair your Bluetooth Hub and headset.*

How to pair your Jabra Bluetooth Hub and headset

! **IMPORTANT:** *Your Bluetooth Hub and headset have been pre-paired at the factory, so this step is only necessary if pairing has been lost, e.g. by resetting.*

- Set your headset into pairing mode by **pressing** its pairing button ⁵. The LED¹ will show a steady blue light and the two devices will 'search' for each other.
- Set your Bluetooth Hub in pairing mode by **pressing and holding** its pairing button ¹¹. The LED¹⁰ will show a steady blue light.

NOTE: *Both devices will continue to search for a pair for 5 minutes.*

- When your headset and Bluetooth Hub have paired successfully, the Bluetooth Hub LED¹⁰ will flash blue 10 times and the headset LED¹ will flash blue slowly.

NOTE: *If you accidentally put either the Bluetooth Hub or headset into pairing mode, **tap** the pairing button ⁵/¹¹ to exit pairing mode.*

One Bluetooth Hub can be paired with multiple headsets, just as one headset can be paired with multiple Bluetooth Hubs. Your headset will 'prioritize' the Bluetooth Hub it has been paired with most recently.

Adjusting settings with a test call from your desk phone

- Place the headset on your ear and **tap** the headset Answer/End button. The handset will be lifted automatically, establishing a dial tone.
- If necessary, switch the Bluetooth Hub's Dial Tone Finder ⁹ from A through G until you hear a clear dial tone. The Dial Tone Finder ⁹ is preset to setting A, since that setting is most commonly used.

- Dial a friend so you can test the volume of your microphone (how your voice sounds to others).
- Adjust the headset microphone volume ⑫ in the Bluetooth Hub until your friend confirms that your voice can be heard at an appropriate level.
- To end the call, **tap** the headset Answer/End button. The handset will be lowered automatically.

Use

Making and ending a call to a desk phone

- Place the headset on your ear and **tap** the headset Answer/End button.
- The handset will lift automatically and the call will connect.
- Wait for the dial tone and dial the desired number.
- To end the call, **tap** the headset Answer/End button. The handset will be lowered automatically.

Answering and ending a call to a desk phone

Both the desk phone and the headset will give an audible indication that a call is incoming.

- Place the headset on your ear and **tap** the headset Answer/End button.
- The handset will lift automatically and the call will connect.
- To end the call, **tap** the headset Answer/End button. The handset will be lowered automatically.

Switching from headset to handset

You can switch from your headset to your desk phone handset during an active call. You might want to do this if, for example, your headset battery is running low.

- Pick up the desk phone handset (this step must be done first).
- **Tap** the headset Answer/End button, or place it into the desk stand ● for charging.

The call will be transferred to your desk phone handset.

Switching from handset to headset

You can switch from your desk phone handset to your headset during an active call. You might want to do this if, for example, the call was answered on the desk phone handset and you would prefer to use your headset.

- Keep the desk phone handset off the hook.
- **Tap** the headset Answer/End button. (The GN1000 will lift.)

The call will be transferred to the headset.

- To end the call, **tap** the Answer/End button. (The GN1000 will be lowered.) Remember to replace the desk phone handset after you have ended the call.

Staying within range

The sound in your headset will deteriorate if you move beyond range.* Move back into range to restore sound quality.

If you move too far from the Bluetooth Hub, the call will be routed to your desk phone handset. Return into range within 60 seconds and the call will be re-routed back to the headset. If you stay out of range for more than 60 seconds, the GN1000 will lower the handset and the call will be ended automatically.

Remember!

In general, you will get better performance when there are no obstructions between your headset and your Bluetooth Hub.

* up to 33 feet/10 meters in line of sight

7

For use with a desk phone with electronic hookswitch (EHS)

! **IMPORTANT:** *In order to use your Jabra JX10 Headset with Bluetooth Hub with a desk phone with EHS, you need to have an EHS-compliant Bluetooth Hub.*

Jabra Bluetooth Hub setup

Connecting your Jabra Bluetooth Hub with desk phone and power supply

- Connect your desk phone handset socket to the desk phone socket ⑮ on the Bluetooth Hub using the supplied Y connection cord. To do this:
 - o connect the single end of the Y cord into the desk phone headset port
 - o connect the double end of the Y cord to the Bluetooth Hub
 - the small plug connects to the Bluetooth Hub's desk phone socket ⑮
 - the large plug connects to the Bluetooth Hub's AUX socket ⑬

- Connect the power supply ⑩ to your Bluetooth Hub's power supply socket ⑱.
- Connect the power supply ⑩ to the wall power socket.
- You can use the 'wire guide' at the bottom of the Bluetooth Hub to neatly guide the cable from the desk phone to the wall phone plug.

The green LED⑩ indicates that the Bluetooth Hub power is on.

In the unlikely event that the Bluetooth Hub is not OK, its LED⑩ will flash red.

- First, try disconnecting and reconnecting the Bluetooth Hub from the power source.
- If the LED is still flashing red, you must reset your Bluetooth Hub.
 - **Press and hold** the Bluetooth Hub reset button ⑯.
 - The reset light⑩ will turn solid red for 3 seconds, and then turn green.

! **IMPORTANT:** *Following reset, you must pair your Bluetooth Hub and headset.*

How to pair your Jabra Bluetooth Hub and headset

! **IMPORTANT:** *Your Bluetooth Hub and headset have been pre-paired at the factory, so this step is only necessary if pairing has been lost, e.g. by resetting.*

- Set your headset into pairing mode by **pressing** its pairing button ⑤. The LED① will show a steady blue light and the two devices will 'search' for each other.
- Set your Bluetooth Hub in pairing mode by **pressing and holding** its pairing button ⑪. The LED⑩ will show a steady blue light.

NOTE: *Both devices will continue to search for a pair for 5 minutes.*

- When your headset and Bluetooth Hub have paired successfully, the Bluetooth Hub LED⑩ will flash blue 10 times and the headset LED① will flash blue slowly.

NOTE: *If you accidentally put either the Bluetooth Hub or headset into pairing mode, **tap** the pairing button ⑤/⑪ to exit pairing mode.*

One Bluetooth Hub can be paired with multiple headsets, just as one headset can be paired with multiple Bluetooth Hubs. Your headset will 'prioritize' the Bluetooth Hub it has been paired with most recently.

Adjusting settings with a test call from your desk phone

- Place the headset on your ear and **tap** the headset Answer/End button.
- The desk phone will activate automatically.
- Wait for the dial tone.

- Dial a friend so you can test the volume of your microphone (how your voice sounds to others).
- Adjust the headset microphone volume  in the Bluetooth Hub until your friend confirms that your voice can be heard at an appropriate level.
- To end the call, **tap** the headset Answer/End button.

Use

Making and ending a call to a desk phone

- Place the headset on your ear and **tap** the headset Answer/End button.
- The desk phone will activate automatically.
- Wait for the dial tone and dial the desired number.
- To end the call, **tap** the headset Answer/End button.

Answering and ending a call to a desk phone

Both the desk phone and the headset will give an audible indication that a call is incoming.

- Place the headset on your ear and **tap** the headset Answer/End button. The call will connect automatically.
- To end the call, **tap** the headset Answer/End button.

Switching from headset to handset

This function is phone specific. Please see your desk phone User Manual for more information on how to use this function.

Switching from handset to headset

This function is phone specific. Please see your desk phone User Manual for more information on how to use this function.

Staying within range

The sound in your headset will deteriorate if you move beyond range.* Move back into range to restore sound quality. If you move too far from the Bluetooth Hub, the call might be ended or re-routed to the desk phone handset, depending on your desk phone. Please see your desk phone User Manual for more information on this function.

Remember!

In general, you will get better performance when there are no obstructions between your headset and your Bluetooth Hub.

* up to 33 feet/10 meters in line of sight

8 For mobile phones

Setup

Pairing your headset with your mobile phone

NOTE: Before use, please charge your headset (see p. 8).

Before you use your Jabra JX10 with a mobile phone, you need to pair it with your mobile phone.

- Make sure the headset is on.
- **Press** the pairing button (5).
- Set your Bluetooth® phone to 'discover' the Jabra JX10:
 - o Follow your phone's instruction guide. This usually involves going to a 'setup', 'connect' or 'Bluetooth' menu on your phone and selecting the option to 'discover' or 'add' a Bluetooth® device.
 - o Your phone will find the Jabra JX10 and will ask if you want to pair with it.
- Accept pairing by pressing Yes/OK (or similar) on the phone and confirm with the passkey or PIN '0000' (4 zeros).
- Your phone will confirm when pairing is complete. If pairing is unsuccessful, repeat the steps above.

NOTE: If you accidentally put the headset into pairing mode, **tap** the pairing button (5) to exit pairing mode.

! IMPORTANT: The same headset can be paired with multiple mobile phones. However, if you have multiple mobile phones paired, switched on and within range of the headset, the headset will not be able to connect to the Bluetooth Hub. It is only possible to be connected to one mobile phone and the Bluetooth Hub **at a time**. To be able to connect with the Bluetooth Hub, only have one paired mobile phone turned on and within range of the headset.

Use

Making and ending a mobile phone call

- When you make a call from your mobile phone, the call will transfer to your headset automatically (this is subject to phone settings, see your mobile phone User Manual to find out how to activate this feature).

If your phone does not allow this feature, see your mobile phone User Manual on how to answer a call with a headset.

- To end a call, **tap** the headset Answer/End button, OR press End/No (or similar) on your mobile phone.

Answering and ending an incoming mobile phone call

- To answer, **tap** the headset Answer/End button on your headset.
- To end a call, **tap** the headset Answer/End button, OR press End/No (or similar) on your mobile phone.

! **IMPORTANT:** *If you answer a call on your mobile phone handset, certain mobile phone models will not automatically transfer the call to your headset.*

Switching from headset to mobile phone*

You can switch from your headset to your mobile phone during an active call. You might want to do this if, for example, your headset battery is running low.

- Use the menu on your mobile phone to switch from headset to mobile phone during an active call (see your mobile phone User Manual).

Switching from mobile phone to headset*

It is possible to switch from your mobile phone to your headset during an active call.

- Use the menu on your mobile phone to switch from mobile phone to headset during an active call (see your mobile phone User Manual).

Rejecting an incoming call*

- **Press** the headset Answer/End button when the phone rings to reject an incoming call.

Depending on your phone settings, the person who called will either be forwarded to your voice mail or hear a busy signal.

* Mobile phone dependent. Check your mobile phone User Manual for further information.

Making a call with Voice Dial*

- **Press** the headset Answer/End button to enter Voice Dial mode. (Consult your mobile phone User Manual for more information about how to use this feature.)

For best results, record the voice dialing tag through your headset.

Redialing the last number*

- **Double tap** the headset Answer/End button.

Using call waiting and placing a call on hold*

- This lets you put a call on hold during a conversation and answer a waiting call.
- **Press** the Answer/End button once to put the active call on hold and answer the waiting call.
- **Press** the Answer/End button to switch between the two calls.
- **Tap** the headset Answer/End button to end the active conversation.

Staying within range

The sound in your headset will deteriorate if you move beyond range.** Move back into range to restore sound quality. If you move too far from your mobile phone, the call might be ended or re-routed to your mobile phone, depending on what mobile phone model you are using. Please see your mobile phone User Manual for more information on this function.

Remember!

For optimal performance, wear the Jabra JX10 and your mobile phone on the same side of your body or within line of sight. In general, you will get better performance when there are no obstructions between your headset and your mobile phone.

* Mobile phone dependent. Check your mobile phone User Manual for further information.

** up to 33 feet/10 meters in line of sight

Only one color will be visible at any one time.

When your headset LED① does this...	It means...
Green steady	Charge complete
Blue slow flash	Headset on (sleep mode)
Blue fast flash	Headset on (active mode)
Blue steady	Headset in pairing mode
Red flash	Low battery
Red steady	Charge in progress

When your Bluetooth Hub LED⑩ does this...	It means...
Green steady	Bluetooth Hub on
Blue steady	Pairing in progress
Blue flash ten times	Pairing successful
Red flash	Bluetooth Hub needs to be reset
Red steady	Reset in progress

10 Troubleshooting

If your product is not working properly, please check the following:

- Are all the cables connected correctly?
- Is the AC adaptor plugged in?
- Is the mains power supply on?
- Is your mobile phone on and sufficiently powered?
- Is the headset paired with the mobile phone?
- Has your headset been charged?

- Is your headset turned on?
- Is your headset disconnected from its charger (desk stand **Ⓒ** or charger **Ⓔ**)?
- Has the Dial Tone Finder **⑨** been adjusted correctly?
- Has the microphone volume **⑫** been adjusted correctly?
- Is the headset within range of the Bluetooth Hub/mobile phone?
- Can your headset and Bluetooth Hub 'see' each other, or is something blocking their connection?
- Are there multiple mobile phones paired, switched on and within range of the headset and Bluetooth Hub while you are trying to connect to the Bluetooth Hub?
- Are more than eight devices paired with the Bluetooth Hub?

NOTE: If your Bluetooth Hub LED **⑩** is flashing red, try disconnecting and reconnecting the power supply. In the unlikely event that this does not help, try resetting it and re-pairing your Bluetooth Hub and headset.

If your Bluetooth Hub does not work and the LED **⑩** shows a steady green light, try resetting and re-pairing it with your headset.

Need more help?

For your country's support details, see the **European and Australasia Safety & Declaration** or **North American Declaration & Warranty** that came with your Jabra JX10 Headset with Bluetooth Hub.

11 Maintenance, safety and disposal

Taking care of your headset

- Always store the Jabra JX10 with the power off and safely protected.
- Avoid storage at extreme temperatures (above 113°F/ 45°C – including direct sunlight – or below 14°F/-10°C). This can shorten battery life and may affect operation. High temperatures may also degrade performance.
- Do not expose the Jabra JX10 to rain or other liquids.
- The earhook **⑧** can be wiped with a dry or slightly damp cloth.

Taking care of your Jabra Bluetooth Hub

- The cords and Bluetooth Hub can be dry dusted as required.
- Avoid getting moisture or liquids into any button sockets, receptors or other openings.
- Avoid exposing the product to rain.
- Do not insert objects – apart from the appropriate cables – into any of the sockets or ports.

Children and product packaging

The packaging, including plastic bags and wrapping parts, are not toys for children. The bags themselves or the small parts they contain may cause choking if ingested.

Batteries and product disposal

- Do not expose the headset batteries to heat.
- Dispose of the product and/or batteries according to local standards and regulations.

12 Glossary

Bluetooth® is a radio technology that connects devices, such as mobile phones and headsets, without wires or cords over a short distance. For more information go to www.bluetooth.com

Bluetooth Hub is the ‘connectivity unit’ made by Jabra (GN Netcom)’ that primes your headset for dual use by enabling your desk phone for wireless Bluetooth® communication. The Bluetooth Hub is compatible with several kinds of corded desk phones.

Bluetooth® profiles are the different ways that Bluetooth® devices communicate with other devices. Bluetooth® phones support either the headset profile, the hands-free profile or both. In order to support a certain profile, a phone manufacturer must implement certain mandatory features within the phone’s software.

Digital Sound Processor (DSP) is a microprocessor that helps with noise reduction and improves audio quality.

Electronic hookswitch (EHS) is a switch contact inside the desk phone that allows the line to be ‘opened’ and ‘closed’ electronically, rather than by picking up or putting down the handset. In order to use your Jabra JX10 Headset with Bluetooth Hub with a desk phone with EHS, you must have a special Bluetooth Hub version that supports EHS and a dedicated cable.

GN1000 (remote handset lifter) can be connected to a desk phone. It physically lifts the handset, so you don't have to pick up or put down the handset manually.

Pairing creates a unique and encrypted link between two Bluetooth® devices and lets them communicate with each other. Bluetooth® devices will not work if the devices have not been paired.

Passkey or PIN is a code that you enter on your mobile phone to pair it with your Jabra JX10. Most often, that code is '0000' (4 zeros). This makes your phone and the Jabra JX10 recognize each other and work together automatically.

Standby mode is when the Jabra JX10 is waiting passively for a call. When you 'end' a call on your mobile phone, the headset goes into standby mode.

Voice dialing tag is a name or phrase you record onto your mobile phone. This enables you to dial a specific person by repeating the voice dialing tag.

13

Bluetooth®

The Bluetooth® word mark and logos are owned by Bluetooth SIG, Inc. and any use of such marks by GN Netcom is under license. Other trademarks and trade names are those of their respective owners.

14

Waste of Electrical and Electronic Equipment (WEEE)

Please dispose of this product and its parts according to local standards and regulations. www.jabra.com/weee.

Customer Contact Details

The Jabra brand is wholly owned by GN Netcom. Customer service is provided by GN Netcom. Please see details below.

Australia	61 3 8823 9111	Japan	81 3 5297 7975
Austria	43 1 403 4134	P. R. China	86 10 6583 2311
Canada	1 905 212 11 02	Singapore	65 65 42 45 50
Denmark	45 43 43 15 52	Spain	34 91 639 80 64
France	33 1 30 58 30 31	Sweden	46 8 693 09 00
Germany	49 803 126 510	United Kingdom	44 1784 220 140
Hong Kong	852 21 04 68 28	USA	1 603 598 1100
Italy	39 02 5832 8253-61-74		

© 2006 GN Netcom A/S. All rights reserved. Jabra is a registered trademark, wholly owned by GN Netcom Inc., and MiniGels is a trademark of GN Netcom Inc. in the USA, and these trademarks may be registered in other countries. US and foreign patents pending. Design and specifications subject to change without notice. The *Bluetooth*® word mark and logos are owned by the Bluetooth SIG, Inc. and any use of such marks by the companies in the GN Netcom Group is under license.



www.jabra.com



RELEASE YOUR JABRA

Jabra