

NEED MORE HELP?

Why wait? Go to our support page and find all the answers you're looking for 24-hours a day. www.jabra.com/play

TOLL FREE Customer Contact Details:

NA Support

Email: techsupp@jabra.com

Twitter: twitter.com/jabra_US

<http://www.jabra.com/mobilesupport>

(For the latest support info
and online user manuals)

1 (800) 327-2230 (U.S.)

1 (800) 489-4199 (Canada)

Design Registration Pending International

For more information, please visit
www.jabra.com

JABRA PLAY

Jabra[®]
YOU'RE ON

GET STARTED UNDER

5 MINUTES

jabra.com/play

81-03669 C

CONTENTS

ENGLISH.....	1
FRANÇAIS.....	5
ESPAÑOL	9
PORTUGUÊS	13

A BRAND BY

GN Netcom

FCC ID: BCE-OTE11

IC : 2386C-OTE11

© 2012 GN Netcom A/S (North America: GN Netcom US, Inc.). All rights reserved. Jabra® is a registered trademark of GN Netcom A/S. All other trademarks included herein are the property of their respective owners. The Bluetooth® word mark and logos are owned by the Bluetooth SIG, Inc. and any use of such marks by GN Netcom A/S is under license. (Design and specifications subject to change without notice).

Made in China
MODEL: OTE11



www.jabra.com

1 PAIR WITH YOUR MOBILE PHONE

ENGLISH

FIRST TIME PAIRING

1. Turn the Jabra Play on (press and hold the **Answer/end** button for 4 secs).
2. Activate Bluetooth on your phone and select Jabra Play. If asked for a PIN code enter 0000 (4 zeros).



PAIR WITH A SECOND MOBILE PHONE

1. Turn the Jabra Play off (press and hold the **Answer/end** button for 4 secs).
2. Press and hold the the **Answer/end** button (6 secs) until the LED indicator flashes blue.
3. Activate Bluetooth on your phone and select Jabra Play. If asked for a PIN code enter 0000 (4 zeros).

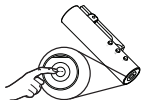

2 WEARING INSTRUCTIONS

The Jabra Play has two different wearing styles.

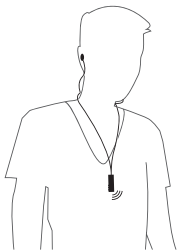

Around the neck

Create a loop using the headphone cables. The size of the loop can be adjusted by moving the cable clip up or down.

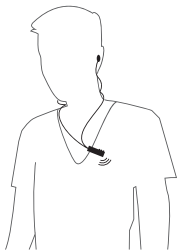

Clip-on



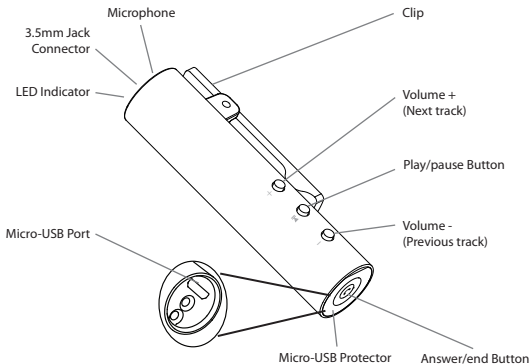

Clip-on to shirt for a secure fit.

3 USING YOUR JABRA PLAY



Did you know?

You can download the User Manual at jabra.com/play to learn about additional features such as Advanced MultiUse.

	On/off	Press and hold (4 secs) the Answer/end
	Make call *	Call will automatically transfer. If not tap the Answer/end button
	Answer call	Tap the Answer/end button
	End call	Tap the Answer/end button
	Reject call *	Press and hold (1 sec) the Answer/end button
	Redial last number *	Double-tap the Answer/end button
	Play/pause music *	Music played on your mobile phone will automatically transfer to the Jabra Play. To pause music tap the Play/pause button, to resume music tap the Play/pause button again
	Speaker volume up/down *	Tap the Volume + or Volume - button
	Skip music tracks	Press and hold (2 secs) the Volume + or Volume - button
	Mute microphone	Press both Volume + and Volume - buttons simultaneously

* Phone dependent

Charging the Jabra Play

Remove the micro-USB protector and connect the Jabra Play to a power supply using the charging adapter. It takes approx. 2 hours to fully charge.

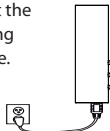

2 hrs

1 APPARIER AVEC VOTRE TÉLÉPHONE MOBILE

FRANÇAIS

PREMIER APPARIEMENT

1. Activez le Jabra Play (appuyez et maintenez appuyé la touche **Réponse/fin** pendant 4 secondes).
2. Activez Bluetooth sur votre téléphone et sélectionnez Jabra Play. Si demandé, entrez le code NIP 0000 (4 zéros).



APPARIER UN DEUXIÈME TÉLÉPHONE MOBILE

1. Désactivez le Jabra Play (appuyez et maintenez appuyé la touche **Réponse/fin** pendant 4 secondes).
2. Appuyez et maintenez appuyé la touche **Réponse/fin** (6 secondes) jusqu'à ce que le voyant DEL clignote bleu.
3. Activez Bluetooth sur votre téléphone et sélectionnez Jabra Play. Si demandé, le votre code NIP 0000 (4 zéros).

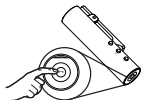

2 COMMENT LE PORTER

Le Jabra Play se porte de deux façons différentes.

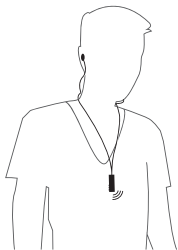

Autour du cou

Créez une boucle en utilisant les fils des écouteurs. La taille de la boucle peut être ajustée en déplaçant la pince du fil.

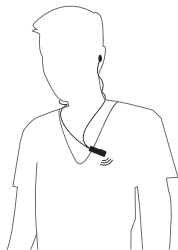

Avec pince



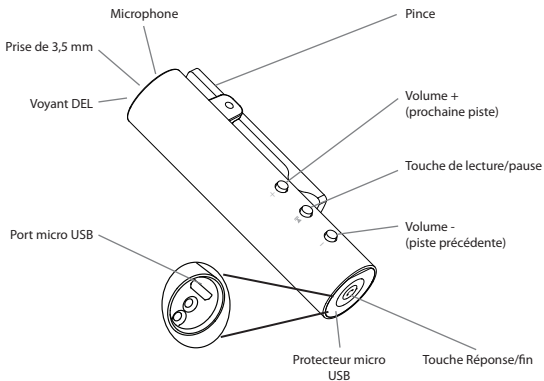

Accrochez la pince à la chemise pour une mise en place sûre.

3 UTILISATION DE VOTRE JABRA PLAY



Saviez-vous?

Vous pouvez télécharger le Manuel de l'utilisateur depuis jabra.com/play pour en apprendre davantage au sujet des fonctionnalités supplémentaires telles que « Advanced MultiUse ».

	Marche/arrêt	Appuyez et maintenez appuyé (4 secondes) la touche Réponse/fin
	Faire un appel *	L'appel sera automatiquement transféré. Sinon, appuyez brièvement sur la touche Réponse/fin
	Répondre à un appel	Appuyez brièvement sur la touche Réponse/fin
	Terminer un appel	Appuyez brièvement sur la touche Réponse/fin
	Refuser un appel *	Appuyez et maintenez appuyé (2 secondes) la touche Réponse/fin
	Recomposez le dernier numéro*	Tapez deux fois sur la touche Réponse/fin
	Lecture/pause de la musique *	La musique en lecture sur votre téléphone mobile sera transférée automatiquement au Jabra Play. Pour mettre la musique en pause, tapez la touche Lecture/pause et pour reprendre la musique, tapez la touche Lecture/pause à nouveau
	Volume du haut-parleur haut/bas*	Tapez la touche Volume + ou Volume -
	Sauter les pistes de musique	Appuyez et maintenez appuyé (2 secondes) la touche Volume + ou Volume -
	Mettre le microphone en mode de discrétion	Appuyez sur la touche Volume + et Volume - en même temps

Charger le Jabra Play

Retirez le protecteur micro USB et connectez le Jabra Play à une alimentation électrique en utilisant le bloc d'alimentation. La charge complète prend environ 2 heures.

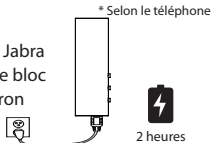

Enregistrement de conception en attente au niveau international

1 PARA SINCRONIZARLO CON SU TELÉFONO

PARA SINCRONIZARLO POR PRIMERA VEZ

1. Encienda el Jabra Play (presione **Responder/ Finalizar** durante 4 segundos).
2. Active el Bluetooth en su teléfono y seleccione Jabra Play. Si se le pide un código PIN escriba 0000 (4 ceros).



PARA SINCRONIZARLO CON UN SEGUNDO TELÉFONO

1. Apague el Jabra Play (presione **Responder/ Finalizar** durante 4 segundos).
2. Presione el botón **Responder/ Finalizar** y manténgalo presionado (6 segundos) hasta que el indicador LED parpadee en azul.
3. Active el Bluetooth en su teléfono y seleccione Jabra Play. Si se le pide un código PIN escriba 0000 (4 ceros).



2 INSTRUCCIONES DE USO

El Jabra Play se puede usar en dos estilos diferentes.

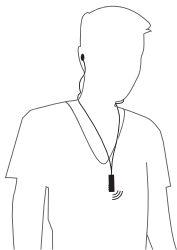

Alrededor del cuello

Cree un bucle utilizando los cables de los auriculares. El tamaño del bucle se puede ajustar moviendo el broche del cable hacia arriba o hacia abajo.

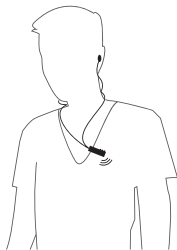

Abrochado



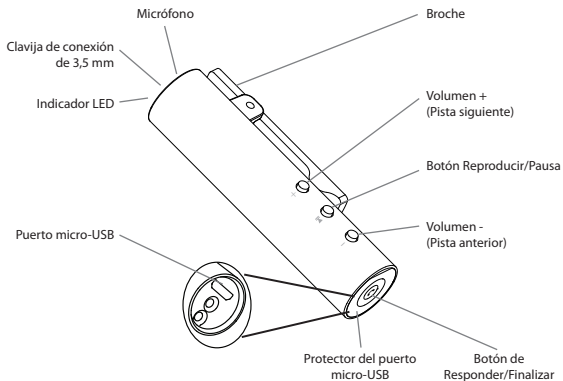

Para un ajuste seguro, abróchelo en su camisa.

3 USO DE SU JABRA PLAY



¿Sabía que...?

Puede descargar el Manual de Usuario en jabra.com/play para conocer las características adicionales, tales como Advanced MultiUse.

	Encendido/Apagado	Presione el botón Responder/Finalizar y manténgalo presionado (4 segundos)
	Realizar llamadas *	La llamada se transferirá automáticamente. Si no lo hace, pulse el botón de Responder/Finalizar
	Responder una llamada	Pulse el botón de Responder/Finalizar
	Finalizar una llamada	Pulse el botón de Responder/Finalizar
	Rechazar una llamada *	Presione el botón Responder/Finalizar y manténgalo presionado (1 segundo)
 x2	Nueva marcación del último número*	Pulse dos veces el botón de Responder/Finalizar
	Botón Reproducir/Pausa *	La música que se reproduce en el teléfono será transferida automáticamente al Jabra Play. Para hacer una pausa en la reproducción de música pulse el botón Reproducir/Pausa , para reanudar la reproducción pulse nuevamente Reproducir/Pausa
 	Volumen del altavoz + / - *	Pulse el botón de volumen + o volumen -
	Saltar pistas de música	Presione el botón Volumen + o Volumen - y manténgalo presionado (2 segundos)
	Silenciar el micrófono	Presione los botones Volumen + y Volumen - simultáneamente

* Depende del teléfono

Cargar su Jabra Play

Retire el protector del puerto micro-USB y conecte el Jabra Play a una fuente de alimentación mediante el adaptador para carga. Lleva aproximadamente 2 horas cargarlo por completo.

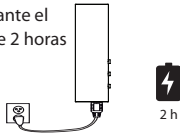

1 PAREAMENTO COM SEU TELEFONE CELULAR

PORTUGUÊS

PAREANDO PELA PRIMEIRA VEZ

1. Ligue o Jabra Play (pressione e segure o botão **Atender/encerrar** por 4 segundos).
2. Ative o Bluetooth do seu telefone e selecione Jabra Play. Se for solicitado um código PIN use 0000 (4 zeros).



PAREAMENTO COM UM SEGUNDO CELULAR

1. Desligue o Jabra Play (pressione e segure o botão **Atender/encerrar** por 4 segundos).
2. Pressione e segure o botão **Atender/encerrar** (6 segundos) até que a luz LED pisque azul.
3. Ative o Bluetooth do seu telefone e selecione Jabra Play. Se for solicitado um código PIN use 0000 (4 zeros).

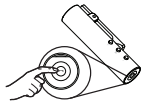

2 INSTRUÇÕES DE USO

O Jabra Play possui dois estilos diferentes de uso.

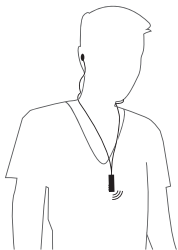

No pescoço

Crie uma alça com os fios do fone de ouvido. O tamanho da alça pode ser ajustado movendo o clipe do fio para cima ou para baixo.

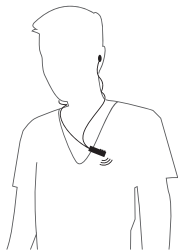

Clipe



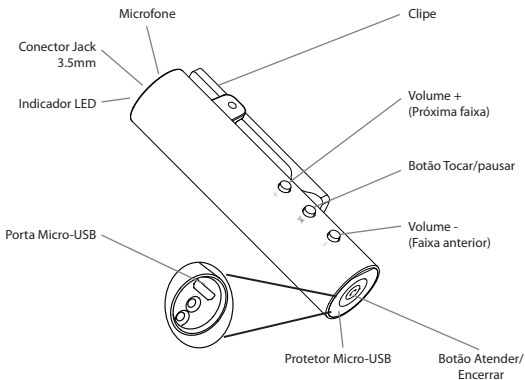

Prenda o clipe na camisa para ajustá-lo com segurança.

3 USANDO O SEU JABRA PLAY



Você sabia?

Você pode baixar o Manual do Usuário em jabra.com/play para aprender sobre recursos adicionais tais como Multiuso Avançado.

	Liga/desliga	Pressione e mantenha pressionado (4 segundos) o botão Atender/encerrar
	Fazer uma chamada *	A chamada será automaticamente transferida. Se não, toque no botão Atender/encerrar
	Atender uma chamada	Toque no botão Atender/encerrar
	Encerrar uma chamada	Toque no botão Atender/encerrar
	Recusar uma chamada *	Pressione e segure (1 segundo) o botão Atender/encerrar
	Rediscar o último número*	Toque duplo no botão Atender/encerrar
	Tocar/pausar música *	As músicas tocadas no seu telefone celular serão automaticamente transferidas para o Jabra Play. Para pausar a música toque o botão Tocar/pausar , para recomendar a música toque novamente no botão Tocar/pausar
	Aumentar/diminuir volume do alto-falante *	Toque no botão Volume + ou Volume -
	Pular faixas de música	Pressione e segure (2 segundos) o botão Volume + ou Volume -
	Microfone mudo	Pressione simultaneamente os botões Volume + e Volume -

* Dependente de um telefone

Carregando o Jabra Play

Remova o protetor micro-USB e conecte o Jabra Play a uma fonte de alimentação usando o carregador. Uma carga completa demora aproximadamente 2 horas.

