



	<u>Version</u> 1.3	<u>Date</u> November 18, 2016	<u>Page</u> 1 / 61
<u>Title</u> USER MANUAL	<u>Prepared by</u>	<u>Reviewed by</u>	<u>Approved by</u>

# **GST-IC-ELITE-1943**

## **USER MANUAL**

**November 18, 2016**

**GS Instech Co., Ltd.**





	<u>Version</u> 1.3	<u>Date</u> November 18, 2016	<u>Page</u> 2/ 61
<u>Title</u> USER MANUAL	<u>Prepared by</u>	<u>Reviewed by</u>	<u>Approved by</u>

## [CHANGE RECORD]

DATE	NAMES	DESCRIPTIONS	VERSION	REMARK
September 5, 2016	H.J.CHOI	Original Draft	1.0	
September 23th, 2016	H.J.CHOI	Add a Modem redundant Configuration	1.1	
November 11, 2016	H.J.CHOI	Change a Model Number	1.2	
		Edit contents		
November 18, 2016	H.J.CHOI	Edit according to FCC/ UL Regulation	1.3	





	<u>Version</u> 1.3	<u>Date</u> November 18, 2016	<u>Page</u> 3/ 61
<u>Title</u> USER MANUAL	<u>Prepared by</u>	<u>Reviewed by</u>	<u>Approved by</u>

## [TABLE OF CONTENTS]

### CHAPTER's INDEX

1.	GENERAL .....	8
1.1.	Purpose .....	8
1.2.	Copyright .....	8
1.3.	FCC Warning Statements .....	9
2.	INTRODUCTION .....	11
2.1.	System Overview .....	11
2.2.	Main Features .....	12
3.	SYSTEM DESIGN .....	13
3.1.	Perspective View .....	13
3.2.	Exterior View .....	14
3.3.	Interior View .....	15
3.4.	External Interface .....	16
4.	SYSTEM SPECIFICATION .....	17
4.1.	RF Performance .....	17
4.2.	ICS General Performance .....	19
4.3.	Frequency Information .....	19
4.3.1.	CDMA Band CLASS 1 .....	19
4.3.2.	LTE Band 25 .....	19





	<u>Version</u> 1.3	<u>Date</u> November 18, 2016	<u>Page</u> 4/ 61
<u>Title</u> USER MANUAL	<u>Prepared by</u>	<u>Reviewed by</u>	<u>Approved by</u>

4.4. Configuration & Mechanical Specification..... 20

5. SYSTEM BLOCK CONFIGURATION..... 21

5.1. Block Diagram..... 21

5.2. Signal & Data Flow ..... 22

6. FUNCTION DESCRIPTION..... 23

6.1. General ..... 23

6.2. Channel (Band) Selection ..... 23

6.3. ALC/ AGC & Gain Balance Function ..... 24

6.4. Smart AGS (Auto Gain Setting) Function..... 24

6.5. ASD (Auto Shut Down) Function ..... 25

6.6. ICS Function ..... 26

6.7. Download..... 27

6.8. NMS Operation ..... 27

6.9. System Gain Auto Saving ..... 27

7. STATUS/ CONTROL & ALARM MONITORING ..... 28

7.1. Status Monitoring and Control Parameters ..... 28

7.2. Alarm Monitoring..... 30

8. WEB-UI OVERVIEW ..... 32

8.1. Configuration the Laptop to Connect to the Repeater ..... 32

8.2. Login-In Screen ..... 33





	<u>Version</u> 1.3	<u>Date</u> November 18, 2016	<u>Page</u> 5/ 61
<u>Title</u> USER MANUAL	<u>Prepared by</u>	<u>Reviewed by</u>	<u>Approved by</u>

8.3.	Main Screen .....	34
8.4.	RF Status.....	35
8.5.	RF Configuration .....	36
8.6.	Alarm Configuration .....	37
8.7.	Fake Alarm Configuration.....	38
8.8.	Communication Configuration.....	39
8.9.	User Management .....	40
8.10.	Alarm Log.....	41
8.11.	Log.....	42
8.12.	Troubleshooting.....	43
8.13.	Software Update .....	44
8.14.	System Reset.....	45
8.15.	Factory Default Setting.....	46
8.16.	Configuration Transfer .....	47
9.	<b>SYSTEM INSTALLATION.....</b>	<b>48</b>
9.1.	<b>Warnings and Hazards .....</b>	<b>49</b>
9.1.1.	Electric Shock.....	49
9.1.2.	Exposure to RF.....	49
9.2.	Position Antenna.....	49
9.3.	Cabling.....	50
9.4.	Service Man Installation Guide .....	50
9.4.1.	Pole Mount Installation.....	51
9.4.2.	Wall Mount Installation.....	55





	<u>Version</u> 1.3	<u>Date</u> November 18, 2016	<u>Page</u> 6/ 61
<u>Title</u> USER MANUAL	<u>Prepared by</u>	<u>Reviewed by</u>	<u>Approved by</u>

9.4.3. Recommended Distance for installing system mounting ..... 58

**9.5. Cable Connection ..... 59**

9.5.1. AC Power cable connection ..... 59

9.5.2. FAN Power Cable Connection ..... 60

9.5.3. RET Cable Connection ..... 60

9.5.4. Local Maintenance Connection ..... 60

9.5.5. Grounding cable Connection ..... 61

**FIGURE's INDEX**

FIGURE 1. FCC/ UL CERTIFICATION STATEMENT ..... 9

FIGURE 2. GST-IC-ELITE 1943 APPLICATION CONFIGURATIONS ..... 11

FIGURE 3. GST-IC-ELITE-1943 PERSPECTIVE VIEW ..... 13

FIGURE 4. GST-IC-ELITE-1943 EXTERIOR VIEW ..... 14

FIGURE 5. GST-IC-ELITE-1943 INTERIOR VIEW ..... 15

FIGURE 6. GST-IC-ELITE-1943 EXTERNAL INTERFACE ..... 16

FIGURE 7. GST-IC-ELITE-1943 BLOCK DIAGRAM CONFIGURATION ..... 21

FIGURE 8. GST-IC-ELITE-1943 SIGNAL AND DATA FLOW ..... 22

FIGURE 9. GST-IC-ELITE-1943 THE WAY TO SELECT THE OPERATING CHANNEL (BAND) ..... 23

**FIGURE 17. A BAND SHUTDOWN CONDITION: START TO ASD ALGORITHM ONLY CDMA BAND ..... 25**

FIGURE 18. TOTAL BAND SHUTDOWN CONDITION: START TO ASD ALGORITHM FINAL AMP ..... 25

FIGURE 19. GST-IC-ELITE-1943 ICS FUNCTION OPERATION ..... 26

FIGURE 20. GST-IC-ELITE-1943 ILC FUNCTION INTERWORKING ..... 26

FIGURE 21. THE WAY TO FIX THE BRACKET ON THE POLE (NORMAL TYPE) ..... 51

FIGURE 22. INSTALLING THE STEEL BAND ..... 52

FIGURE 23. THE WAY TO USING A STEEL BAND ..... 52

FIGURE 24. THE WAY TO HANG THE SYSTEM FOR POLE MOUNTING ..... 53

FIGURE 25. THE WAY TO FIX FIRMLY THE SYSTEM FOR POLE MOUNTING ..... 54

FIGURE 26. DETACH THE UNUSED BRACKET AND BOLT ..... 55

FIGURE 27. FIXING THE BRACKET FOR INSTALLING A WALL MOUNT ..... 56

FIGURE 28. THE WAY TO HANG THE SYSTEM FOR WALL MOUNTING ..... 57

FIGURE 29. THE WAY TO FIX FIRMLY THE SYSTEM FOR WALL MOUNTING ..... 57

FIGURE 30. RECOMMENDED DISTANCE FOR INSTALLING SYSTEM MOUNTING ..... 58





	<u>Version</u> 1.3	<u>Date</u> November 18, 2016	<u>Page</u> 7/ 61
<u>Title</u> USER MANUAL	<u>Prepared by</u>	<u>Reviewed by</u>	<u>Approved by</u>

## TABLE's INDEX

TABLE 1. GST-IC-ELITE-1943 UNIT CONFIGURATION .....	15
TABLE 2. GST-IC-ELITE-1943 EXTERNAL INTERFACE DESCRIPTION .....	16
TABLE 3. GST-IC-ELITE-1943 RF PERFORMANCE DESCRIPTION .....	18
TABLE 4. GST-IC-ELITE-1943 ICS GENERAL PERFORMANCE .....	19
TABLE 5. GST-IC-ELITE-1943 OPERATION BAND FOR CDMA BAND CLASS 1 .....	19
TABLE 6. GST-IC-ELITE-1943 OPERATION BAND FOR LTE BAND 25 .....	19
TABLE 7. GST-IC-ELITE-1943 MECHANICAL & ENVIRONMENT CONDITIONS.....	20
TABLE 8. GST-IC-ELITE-1943 SIGNAL AND DATA FLOW .....	22
TABLE 9. GST-IC-ELITE-1943 STATUS MONITORING AND CONTROL PARAMETERS.....	29
TABLE 10. MONITORING ALARM PARAMETERS.....	31
TABLE 11. GST-IC-ELITE-1943 INSTALLATION ACCESSORIES .....	48





	<u>Version</u> 1.3	<u>Date</u> November 18, 2016	<u>Page</u> 8/ 61
<u>Title</u> USER MANUAL	<u>Prepared by</u>	<u>Reviewed by</u>	<u>Approved by</u>

# 1. General

## 1.1. Purpose

This document introduces features, specifications, structures and operation guideline for the GST-IC-ELITE-1943 CDMA & LTE Repeater

## 1.2. Copyright

All text and image in this document are subject to the copyright of GS Instech Co., Ltd.

This document may not be reproduced, distributed, or modified without the written permission of GS Instech Co., Ltd.





	<u>Version</u> 1.3	<u>Date</u> November 18, 2016	<u>Page</u> 9/ 61
<u>Title</u> USER MANUAL	<u>Prepared by</u>	<u>Reviewed by</u>	<u>Approved by</u>

### 1.3. FCC Warning Statements

FCC Warning Statement for system is follows. Must attach the label under manufacturing.



Figure 1. FCC/ UL Certification Statement



	<u>Version</u> 1.3	<u>Date</u> November 18, 2016	<u>Page</u> 10/ 61
<u>Title</u> USER MANUAL	<u>Prepared by</u>	<u>Reviewed by</u>	<u>Approved by</u>

## FCC Part 15.105 statement (Class A)

This equipment has been tested and found to comply with the limits for a Class A digital device, pursuant to part 15 of the FCC Rules. These limits are designed to provide reasonable protection against harmful interference when the equipment is operated in a commercial environment. This equipment generates, uses, and can radiate radio frequency energy and, if not installed and used in accordance with the instruction manual, may cause harmful interference to radio communications. Operation of this equipment in a residential area is likely to cause harmful interference in which case the user will be required to correct the interference at his own expense.

## FCC Part 15.21 statement

Any changes or modifications not expressly approved by the party responsible for compliance could void the user's authority to operate this equipment.

- Home/ personal use are prohibited
- Use of unauthorized antennas, cables, and/or coupling devices not conforming with ERP/EIRP and/or indoor-only restrictions is prohibited



	<u>Version</u> 1.3	<u>Date</u> November 18, 2016	<u>Page</u> 11 / 61
<u>Title</u> USER MANUAL	<u>Prepared by</u>	<u>Reviewed by</u>	<u>Approved by</u>

## 2. Introduction

### 2.1. System Overview

GST-IC-ELITE-1943 is designed to improve coverage and capacity of CDMA Band Class 1 and LTE Band25 services in all shadowed and blanked areas of Sprint network.

GST-IC-ELITE-1943 receives and improves weak signals as cancelling the multi-path interference even if there is a lack of isolation between Donor and Service antenna.

This solution does not request any costs for Backhaul installation, so will save OPEX and CAPEX.

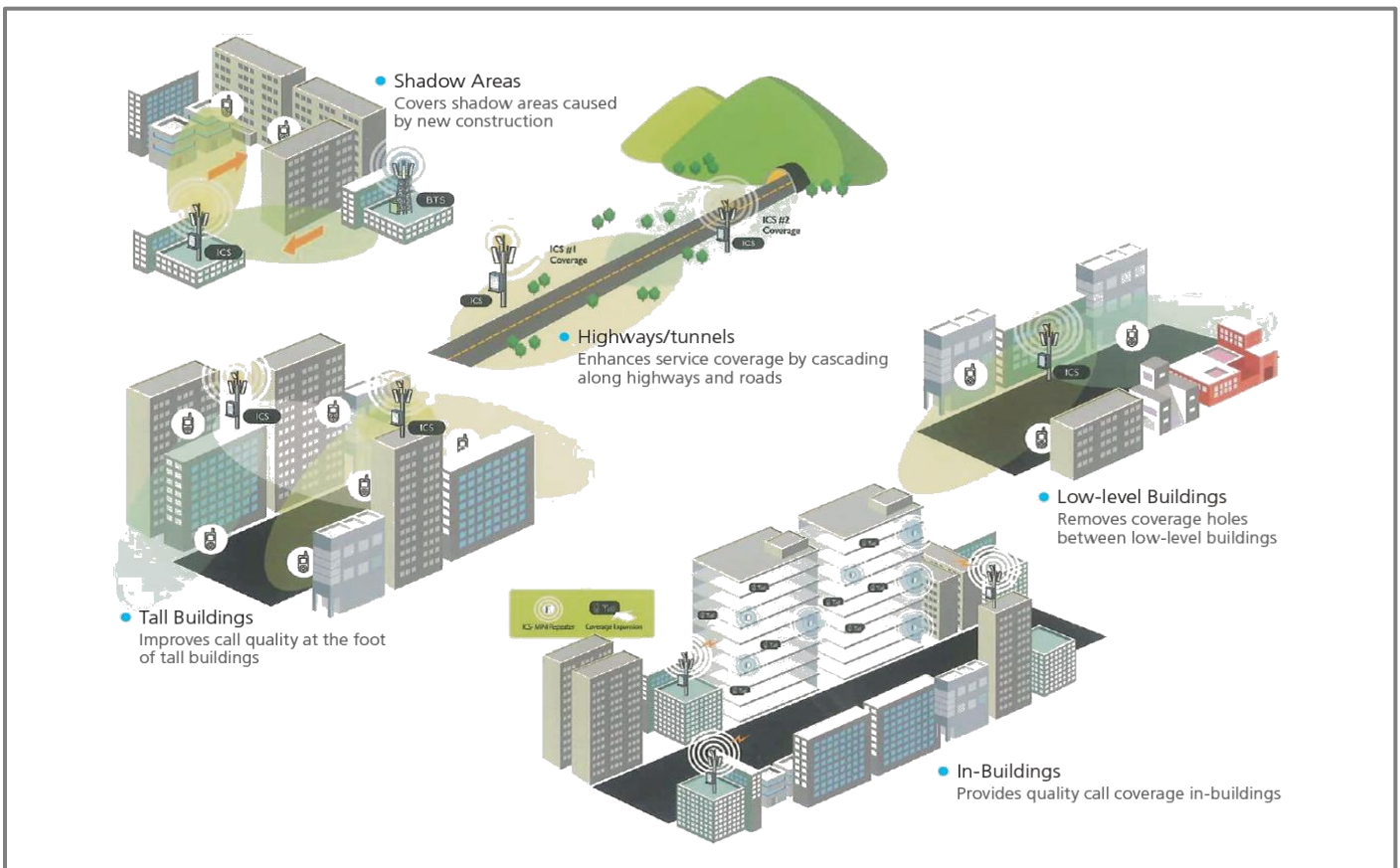

Figure 2. GST-IC-ELITE 1943 Application Configurations



	<u>Version</u> 1.3	<u>Date</u> November 18, 2016	<u>Page</u> 12/ 61
<u>Title</u> USER MANUAL	<u>Prepared by</u>	<u>Reviewed by</u>	<u>Approved by</u>

## 2.2. Main Features

- Maintain the Quality of Demodulation performance on the Overlay-Cell Region using Delay-Reduction Technology ( Less than 4us for CDMA & LTE)
  - Provide the SNMP Solution
  - Ensure the Uplink-Sensitivity and Suppress Rising-UL noise floor under high out-power at Downlink using PIMD-Reduction Technology ( Less than 153dBc)
  - Excellent RF Specifications
    - High Gain: more than 105dB
    - Low Noise figure under all system gain condition: Less than 4dB
    - Grate Performance of Interference Cancellation:  $G=I+15dB$
    - High Rejection: More than -50dBc at Band Edge  $\pm$  450 KHz
  - Adaptable functions for Operation
    - RS (Pilot) Aware, Smart ALC & ASD, Attenuator for each Band
    - Total Bandwidth of 25MHz Configurable in 1.25MHz Step for CDMA up to 15MHz and 5MHz Step for LTE up to 10MHz
  - Complies with NEMA 4 (equal to IP66) for Outdoor application
  - Apply for Cascade 6 chain installation
  - FCC Part 24, Part 15B class A
  - UL 60950-1, 60950-22 certificated



	<u>Version</u> 1.3	<u>Date</u> November 18, 2016	<u>Page</u> 13/ 61
<u>Title</u> USER MANUAL	<u>Prepared by</u>	<u>Reviewed by</u>	<u>Approved by</u>

### 3. System Design

#### 3.1. Perspective View

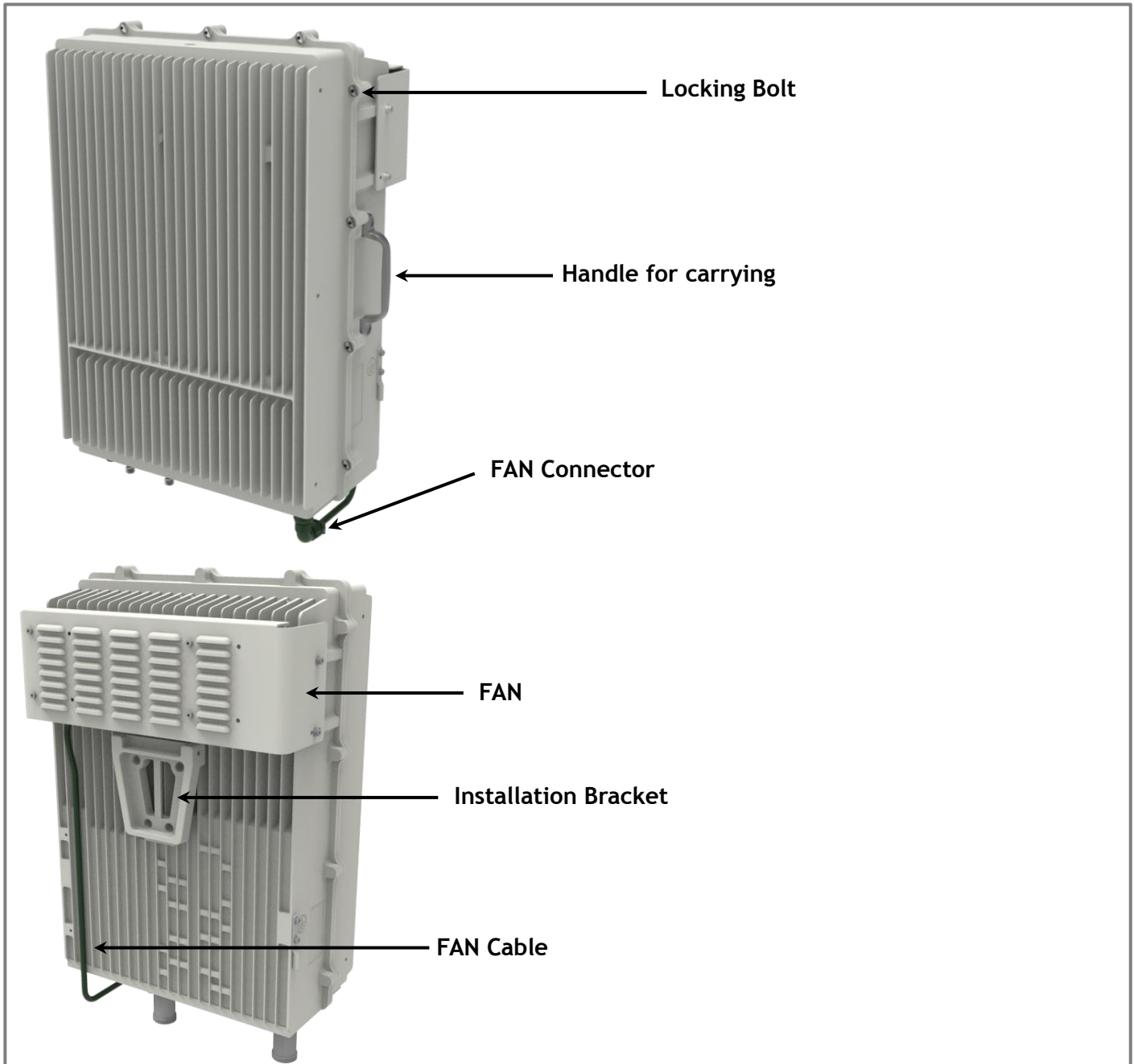

Figure 3. GST-IC-ELITE-1943 Perspective View

	<u>Version</u> 1.3	<u>Date</u> November 18, 2016	<u>Page</u> 14/ 61
<u>Title</u> USER MANUAL	<u>Prepared by</u>	<u>Reviewed by</u>	<u>Approved by</u>

### 3.2. Exterior View

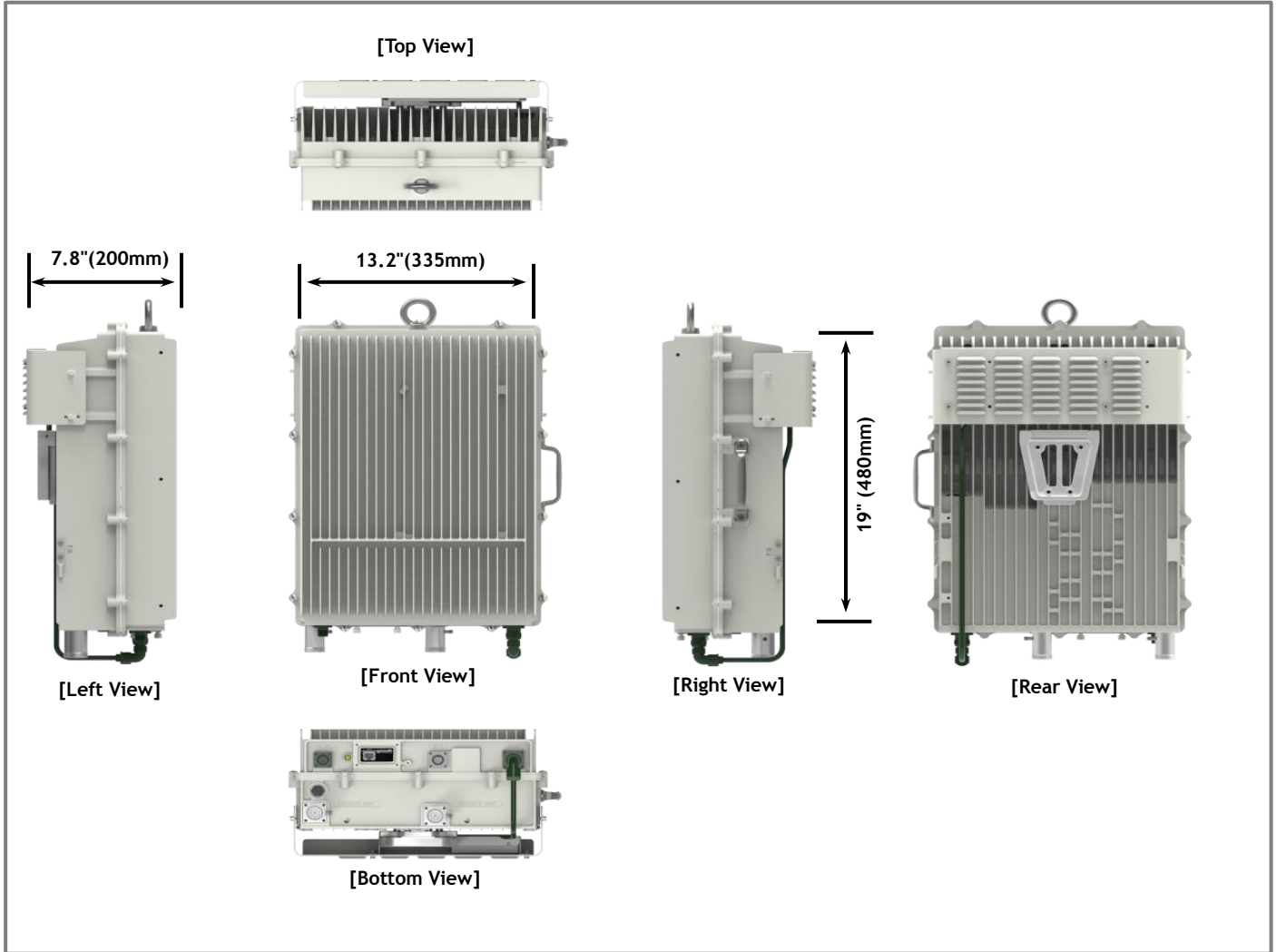

Figure 4. GST-IC-ELITE-1943 Exterior View

<u>Version</u> 1.3	<u>Date</u> November 18, 2016	<u>Page</u> 15/ 61
<u>Prepared by</u>	<u>Reviewed by</u>	<u>Approved by</u>

<u>Title</u> USER MANUAL
-----------------------------

### 3.3. Interior View

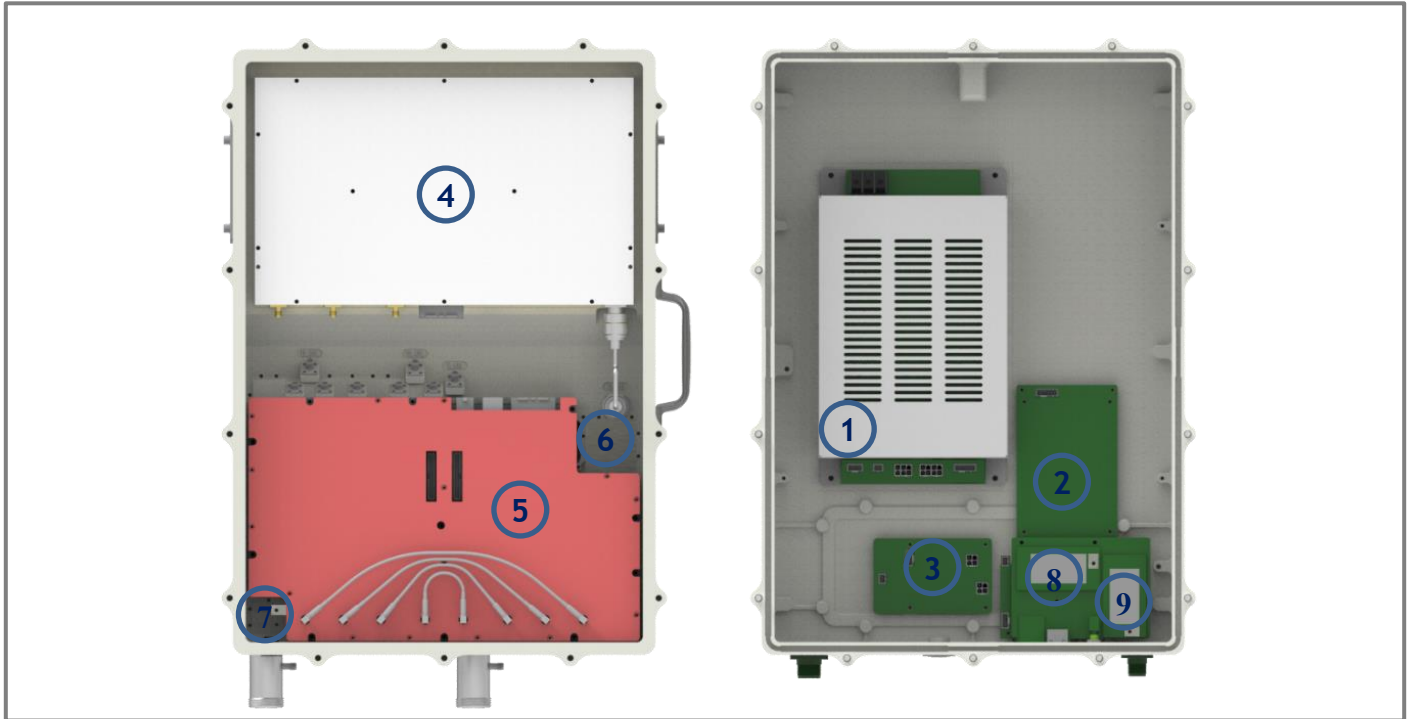

Figure 5. GST-IC-ELITE-1943 Interior View

No	Name	Remark
1	Power Supply Unit	Input: 110Vac~240Vac/ Output (DC):+32V, 24V, 5.6V
2	SNMP Board	For EMS using Wireless Modem
3	Surge Protect Board	RET Surge Protection
4	High Power Amplifier	For generating High RF Power
5	ICM (Interference Cancellation Module)	Contains RF Up & Down Convertor, Digital Signal Processing and Controller Unit
6	Duplexer	Separate Downlink and Uplink Frequency Band
7	Modem Coupling Port	Connect the Wireless Modem Output
8	LTE Modem	For Status Monitoring and Control from Server
9	CDMA Modem	For Status Monitoring and Control from Server

Table 1. GST-IC-ELITE-1943 Unit Configuration

<u>Version</u> 1.3	<u>Date</u> November 18, 2016	<u>Page</u> 16/ 61
<u>Title</u> USER MANUAL	<u>Prepared by</u>	<u>Reviewed by</u>
		<u>Approved by</u>

### 3.4. External Interface

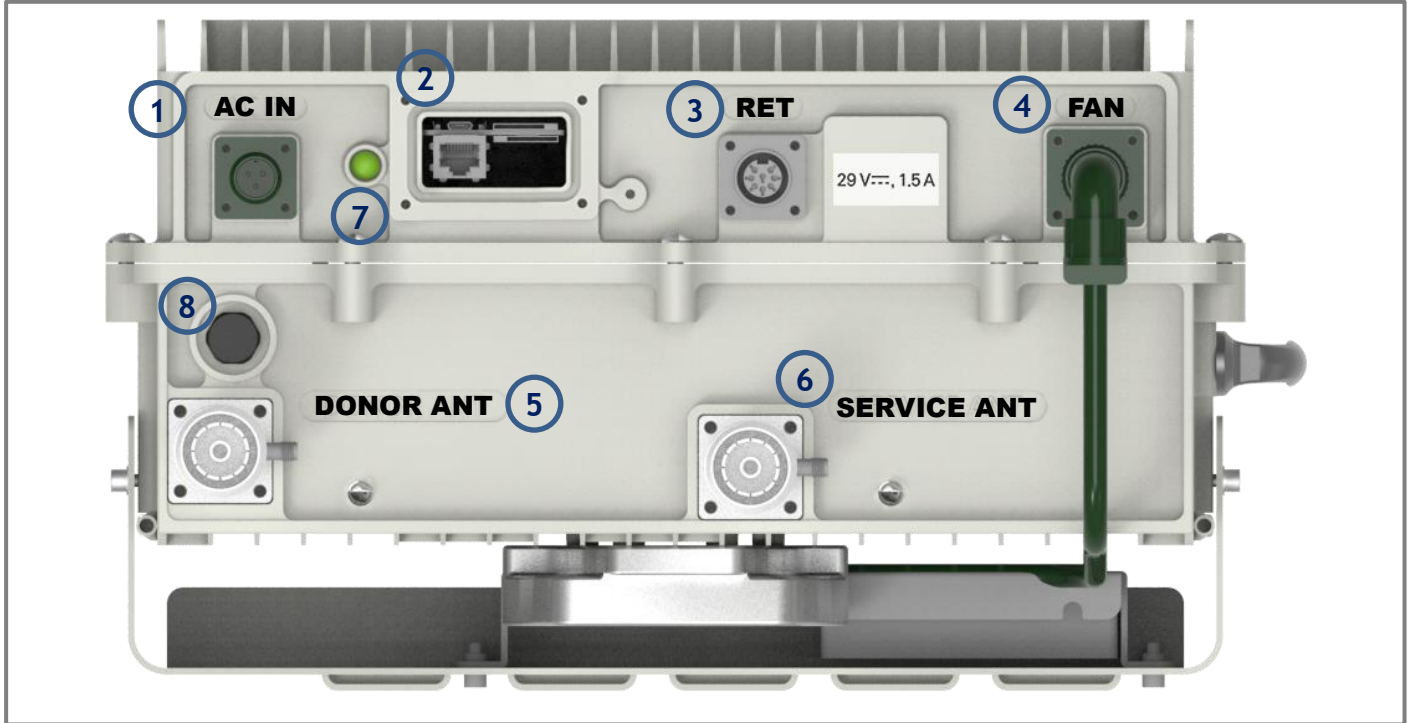

Figure 6. GST-IC-ELITE-1943 External Interface

No	NAMES	DESCRIPTION	SPECIFICATION
1	AC IN	AC Power Input Port	MS-3102A-10SL-3P
2	RJ-45 & SIM CARD SLOT	Local Maintenance & Modem Activation	Local: RJ-45 SLOT: AUSIM-115AADA0-R02
3	RET	Remote Antenna Control Port (AISG 2.0)	SU20SPR-8S/ 29V_1.5A max
4	FAN	FAN Power & Alarm Connection	MS3102A14S-2P
5	Donor ANT	Donor Antenna Connection	7/16 DIN Female with 30dB Coupler
6	Service ANT	Service Antenna Connection	7/16 DIN Female with 30dB Coupler
7	LED	System Total Alarm Indication	General Performance
8	Vent-Core	Maintain Humidity & Temp Inside	IP66

Table 2. GST-IC-ELITE-1943 External Interface Description



<u>Version</u>	<u>Date</u>	<u>Page</u>
1.3	November 18, 2016	17/ 61
<u>Title</u>	<u>Prepared by</u>	<u>Reviewed by</u>
USER MANUAL		
		<u>Approved by</u>

## 4. System Specification

### 4.1. RF Performance

Parameter		Down Link	Up Link	Remark	
Frequency Range		1930MHz ~ 1995MHz	1850MHz ~ 1915MHz		
Input Range		-62dBm ~ -32dBm/ Total	-75dBm ~ -45dBm/ Total		
Output Power		+43dBm (20W) max. CDMA 10W+LTE 10W / Total	+30dBm (1W) max.		
Channel Capacity		【CDMA】 15MHz max/ 1.25MHz Step 【LTE】 10MHz max (9.01MHz for OBW)/ 5MHz Step			
Gain	Range	65dB ~ 105dB (Max 40dB)		ALC: 30dB Manual: 10dB	
	Adjust Step	0.5dB			
	Accuracy	±0.5dB			
Ripple		±1.5dB p-p			
Roll off		> 50dBc @ Channel OBW ±450KHz > 50dBc @ Channel OBW ±1MHz > 75dBc @ Channel OBW ±3.5MHz			
Waveform Quality		No Feedback & Max/ Min Input	≥ 0.99 (Rho)	For CDMA	
		G=l+15dB & Fading 10Hz G=l	≥ 0.95 (Rho)		
EVM	No Feedback & Max/ Min Input		QPSK	7.1%	For LTE
			16QAM	5.1%	
			64QAM	3.2%	
	G=l+15dB & Fading 10Hz G=l		QPSK	8%	
			16QAM		
			64QAM		



<u>Version</u>	<u>Date</u>	<u>Page</u>
1.3	November 18, 2016	18/ 61
<u>Title</u>	<u>Prepared by</u>	<u>Reviewed by</u>
USER MANUAL		
		<u>Approved by</u>

Parameter	Down Link	Up Link	Remark
Frequency Error	< 0.05ppm		
Downlink Transmitter Intermodulation	> 153dBc Suppress Uplink Intermodulation Product		
Uplink Transmitter Intermodulation	> 153dBc Suppress Downlink Intermodulation Product		
System Delay	< 4us		CDMA & LTE
Noise Figure	Less than 4dB @ Min & Max Gain		
TX/RX Isolation	> 110dBc		
Cancellation Depth	G=I+15dB		
VSWR	< 1.5 : 1		
OB Unwanted Emission	<-5.5dBm @50KHz ≤ Δf < 5.05MHz (RBW: 100KHz)		For LTE
	<-12.5dBm @5.05MHz ≤ Δf < 10.05MHz (RBW: 100KHz)		
	<-13dBm @10.5MHz ≤ Δf < 15MHz (RBW: 1MHz)		
ACLR	> 45dBc @±5MHz, > 45dBc @±10MHz		For LTE
Spurious Emission For CDMA	885 kHz	-45 dBc with a 30KHz RBW	
	1.98 MHz	$P_{out} \geq 33dBm$ ; -55dBc with a 30KHz RBW	
		$28dBm \leq P_{out} < 33dBm$ ; -22dBm with a 30KHz RBW	
	2.25 MHz	-13dBm with a 30KHz RBW	ITU category A
	4.0 MHz	-13dBm / 1 kHz: 9 kHz < f < 150 kHz	
		-13dBm / 10 kHz: 150 kHz < f < 30 MHz	
		-13dBm/100 kHz: 30 MHz < f < 1 GHz	
		-13dBm / 1 MHz: 1 GHz < f < 12.75 GHz	
3rd Intermodulation Emission	< -13dBm @ Modulated Input 2 tones -65dBm each		CDMA & LTE

**Table 3. GST-IC-ELITE-1943 RF Performance Description**



<u>Version</u> 1.3	<u>Date</u> November 18, 2016	<u>Page</u> 19/ 61
<u>Prepared by</u>	<u>Reviewed by</u>	<u>Approved by</u>

<u>Title</u> USER MANUAL
-----------------------------

## 4.2. ICS General Performance

No.	Parameter	Condition	Specification
1	Gain Re-Tracking Time after reset	Target Gain $\pm 1$ dB	< 10 Sec
2	Isolation Sensing Range	-10dB < Gain < 10dB -20dB < Gain < 20dB	Accuracy $\pm 1$ Accuracy $\pm 3$
3	G = I + 15dB	Static	General Operating
4	G = I	10Hz	Fast Fading

Table 4. GST-IC-ELITE-1943 ICS General Performance

## 4.3. Frequency Information

### 4.3.1. CDMA Band CLASS 1

Block	Transmit frequency band (MHz)				Bandwidth UL / DL
	Uplink		Downlink		
A	1850	1865	1930	1945	15
D	1865	1870	1945	1950	5
B	1870	1885	1950	1965	15
E	1885	1890	1965	1970	5
F	1890	1895	1970	1975	5
C	1895	1910	1975	1990	15

Table 5. GST-IC-ELITE-1943 Operation Band for CDMA Band Class 1

### 4.3.2. LTE Band 25

BW	ERAFCN (Count 1 step)		Center Frequency (100KHz step)	
	Start	Stop	Start(MHz)	Stop(MHz)
5MHz	8065	8665	1932.5	1992.5
10MHz	8090	8640	1935	1990

Table 6. GST-IC-ELITE-1943 Operation Band for LTE Band 25



<u>Version</u>	<u>Date</u>	<u>Page</u>
1.3	November 18, 2016	20/ 61
<u>Title</u>	<u>Prepared by</u>	<u>Reviewed by</u>
USER MANUAL		
		<u>Approved by</u>

#### 4.4. Configuration & Mechanical Specification

Parameter	Specification	Remark
Donor/ Service Antenna Filter	One Output port-duplex type for LTE & CDMA	Donor Duplexer include Modem ANT port
Power Supply	AC Input Voltage: 110-240V (50/60Hz)	3.7A max
	DC Output Voltage: 32V/ 24V/ 5.6V	
Operation Temperature	-40°C~+55°C (100%RH)	
Storage Temperature	-40°C~+85°C (5-95%RH)	
Connectors	Antenna: 7/16 DIN Female	On Bottom side
	Ethernet: RJ-45	
	AC: MS-3102A10SL-3P	
	FAN: MS-3102A14S-2P	
	RET: SU20SPR	
Size	19" x 13.2" x 7.8"(480mm x 335mm x 200mm)	Without Bracket
Weigh	Less than 25kg (55.1lb)	Without Bracket
Power Consumption	Less than 350W	
MTBF	100,000 hours or higher	
Internal Modem	LTE Modem primary	Back up with CDMA Modem
RET	Provide a physical Connection & 29V/1.5Amax	AISG 2.0 Standard
Dust Resistance	Telcordia GR63-CORE	
Vibration Resistance	1G, 10-150Hz, 0.1 Octaves/min	
Grounding	nonferrous metal and anchoring point on bottom side	For RF and power cabling
Environmental Spec.	NEMA4	IP 66
Sustained winds.	150mph	
Altitude	AMSL 10,000ft	
Mount Application	Metal or Wooden Poles	8"-20" outside diameter
Pollution degree	PD2	
Overvoltage Category	OVC II	

Table 7. GST-IC-ELITE-1943 Mechanical & Environment conditions



	<u>Version</u> 1.3	<u>Date</u> November 18, 2016	<u>Page</u> 21/ 61
<u>Title</u> USER MANUAL	<u>Prepared by</u>	<u>Reviewed by</u>	<u>Approved by</u>

## 5. System Block Configuration

### 5.1. Block Diagram

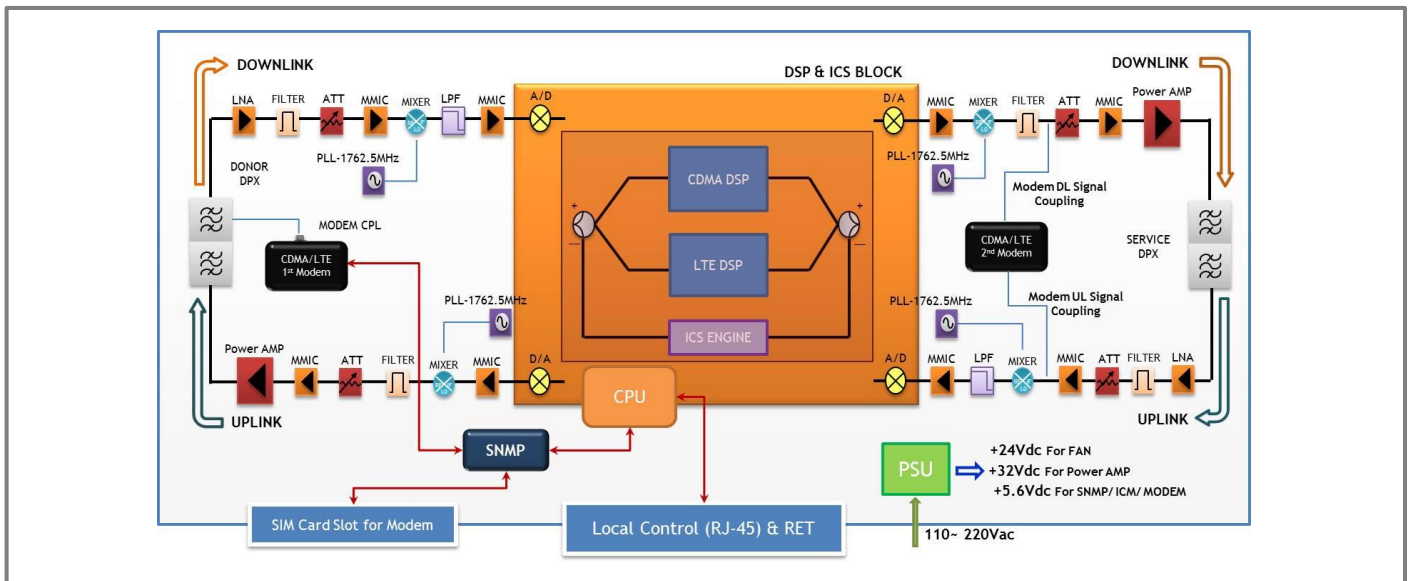

Figure 7. GST-IC-ELITE-1943 Block Diagram Configuration

The repeater improves service in the Sprint Network of CDMA Class 1 & LTE Band 25.

User may select frequency band according to the site peculiarities.

After receiving a weak signal from Donor antenna, the repeater improves and sends securely isolated signal out to service antenna under lack of isolation between Donor and Service Antenna using the ICS (Interference-Cancellation-System) engine.

The Repeater is consists of a ICM (Down and up converters with Digital Signal Processing (DSP) module), Cavity filters and power amplifier. In Downlink Path, a weak RF signal is received from Donor Antenna. being converted from RF to IF signal, It is transferred to the DSP&ICS block, where after digitalizing by DA converter, signal is filtered by DSP. After filtering digital signal is converted into analog RF signal via modulator and then transmitted to amplifier. Desirable signal is amplified and outputted through Service Antenna. Uplink path works vice versa.

<u>Version</u> 1.3	<u>Date</u> November 18, 2016	<u>Page</u> 22/ 61
<u>Title</u> USER MANUAL	<u>Prepared by</u>	<u>Reviewed by</u>
		<u>Approved by</u>

## 5.2. Signal & Data Flow

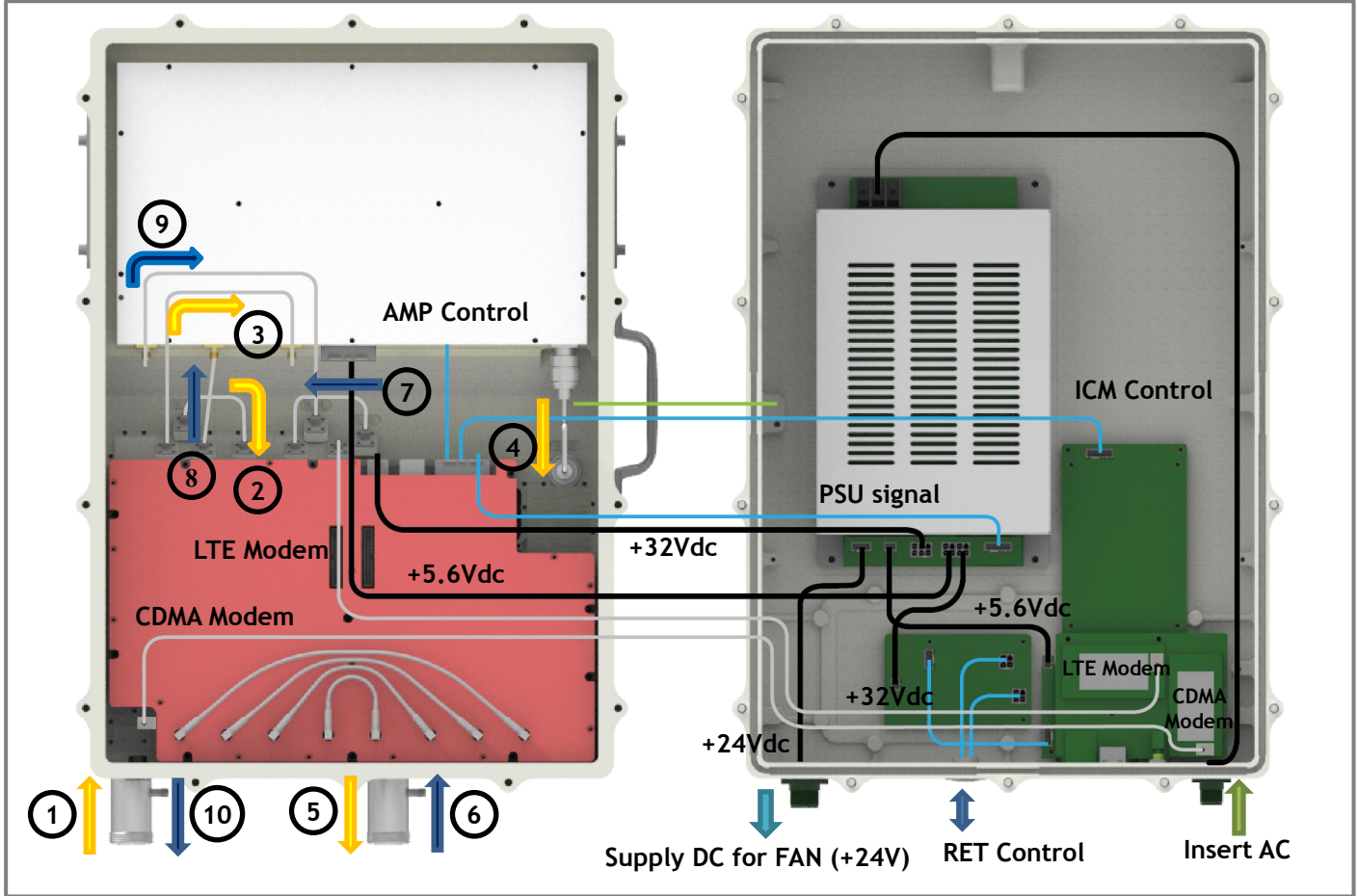

Figure 8. GST-IC-ELITE-1943 Signal and Data Flow

No	Signal Flow	No	Signal Flow
1-DL	From Donor Antenna	6-UL	From Service Antenna
2-DL	Donor Duplexer → ICM-DNC IN	7-UL	Service Duplexer → ICM-DNC IN
3-DL	ICM-UPC OUT → AMP-IN	8-UL	ICM-UPC OUT → AMP-IN
4-DL	AMP-OUT → Service Duplexer	9-UL	AMP-OUT → Donor Duplexer
5-DL	To Service Antenna	10-UL	To Donor Antenna

Table 8. GST-IC-ELITE-1943 Signal and Data Flow

	<u>Version</u> 1.3	<u>Date</u> November 18, 2016	<u>Page</u> 23/ 61
<u>Title</u> USER MANUAL	<u>Prepared by</u>	<u>Reviewed by</u>	<u>Approved by</u>

## 6. Function Description

### 6.1. General

- Ability to perform a function about management & operation (Band independently)
  - Gain & Level Adjustment
  - Smart AGS, ASD, ALC, Gain Balance, Channel Selection
- ILC operation based on ICS function
- Ability to initialize the entire system (include with local & remote control)

### 6.2. Channel (Band) Selection

- Repeater support the capacity of CDMA Band Class 1 and LTE Band 25
- Ability to set the 2 Non-Contiguous channel
- Support the CDMA 15MHz max per 1.25 step and LTE 10MHz max per 5MHz step
- User can set the desired channel using the Web-UI

Click the "v" on the blank of the desired CDMA channel  
1.25MHz step per "v"

Write the ERAFCN and Choose BW of the desired LTE channel

CDMA Band Selection													
A1	+	A2	+	A3	+	D	+	B1	+	B2	+	B3	+
<input checked="" type="checkbox"/>	<input checked="" type="checkbox"/>	<input checked="" type="checkbox"/>	<input type="checkbox"/>	<input type="checkbox"/>	<input type="checkbox"/>	<input type="checkbox"/>	<input type="checkbox"/>	<input type="checkbox"/>	<input type="checkbox"/>	<input type="checkbox"/>	<input type="checkbox"/>	<input type="checkbox"/>	<input type="checkbox"/>
E	+	F	+	C1	+	C2	+	C3	+	G			
<input type="checkbox"/>	<input type="checkbox"/>	<input type="checkbox"/>	<input type="checkbox"/>	<input type="checkbox"/>	<input type="checkbox"/>	<input type="checkbox"/>	<input type="checkbox"/>	<input type="checkbox"/>	<input type="checkbox"/>	<input type="checkbox"/>	<input type="checkbox"/>	<input type="checkbox"/>	<input type="checkbox"/>

LTE1 Band Selection			
EARFCN_BW	5M	EARFCN	8665.0

LTE1 Band Selection													
A1	+	A2	+	A3	+	D	+	B1	+	B2	+	B3	+
<input type="checkbox"/>	<input type="checkbox"/>	<input type="checkbox"/>	<input type="checkbox"/>	<input type="checkbox"/>	<input type="checkbox"/>	<input type="checkbox"/>	<input type="checkbox"/>	<input type="checkbox"/>	<input type="checkbox"/>	<input type="checkbox"/>	<input type="checkbox"/>	<input type="checkbox"/>	<input type="checkbox"/>
E	+	F	+	C1	+	C2	+	C3	+	G			
<input type="checkbox"/>	<input type="checkbox"/>	<input type="checkbox"/>	<input type="checkbox"/>	<input type="checkbox"/>	<input type="checkbox"/>	<input type="checkbox"/>	<input type="checkbox"/>	<input type="checkbox"/>	<input type="checkbox"/>	<input checked="" type="checkbox"/>	<input checked="" type="checkbox"/>	<input checked="" type="checkbox"/>	<input type="checkbox"/>

Display the LTE Channel that set by users in order to prevent the channel duplication with CDMA

Figure 9. GST-Ic-ELITE-1943 The way to select the operating Channel (Band)

	<u>Version</u> 1.3	<u>Date</u> November 18, 2016	<u>Page</u> 24/ 61
<u>Title</u> USER MANUAL	<u>Prepared by</u>	<u>Reviewed by</u>	<u>Approved by</u>

### 6.3. ALC/ AGC & Gain Balance Function

ALC means a function which controls gain automatically in order to protect H/W in case of excessive out power more than user-defined threshold value upon Input RSSI change, and to keep signal quality. AGC means UL Gain Balancing function based on DL Gain.

### 6.4. Smart AGS (Auto Gain Setting) Function

- Transmit the stable CDMA Pilot Power and LTE RS Power to use Smart ALC and CDMA/ LTE Dual Modem
- Operate the BTS Coverage reliably
- Set the repeater gain correctly based on Path loss between BTS and Repeater, minimize the increment of BTS Noise Floor
- If AGS function is close, system operate only Smart ALC function (able to control thru Web-UI)



<u>Version</u>	<u>Date</u>	<u>Page</u>
1.3	November 18, 2016	25/ 61
<u>Prepared by</u>	<u>Reviewed by</u>	<u>Approved by</u>
<u>Title</u>		
USER MANUAL		

### 6.5. ASD (Auto Shut Down) Function

- Cut off the Output power automatically to prevent a damage if system output power too high
- Able to function On/Off thru Web-UI
- Operate band independently
- In Case of Only One-Band Algorithm
  - Based on Band Output power
  - Cut Off the Band Output power thru Digital Filter closing

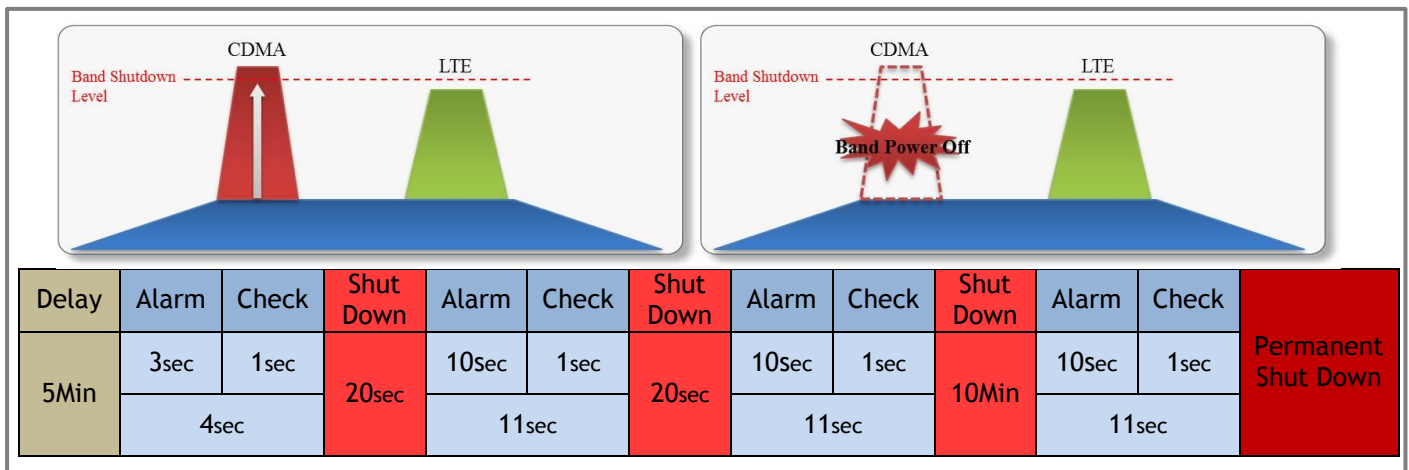

Figure 10. A band Shutdown Condition: Start to ASD Algorithm only CDMA Band

- In Case of Total-Band Algorithm
  - Based on Total Output Power
  - Cut off the Total Output Power thru Final AMP Off

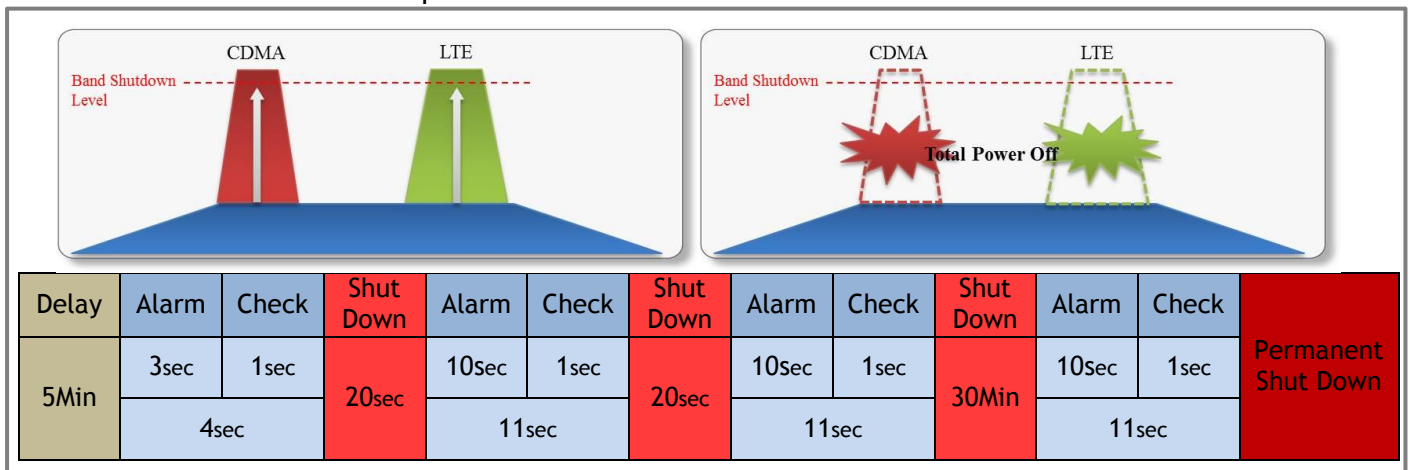

Figure 11. Total band Shutdown Condition: Start to ASD Algorithm Final AMP

	<u>Version</u> 1.3	<u>Date</u> November 18, 2016	<u>Page</u> 26/ 61
<u>Title</u> USER MANUAL	<u>Prepared by</u>	<u>Reviewed by</u>	<u>Approved by</u>

## 6.6. ICS Function

- Provide an Ability to operate stable under lack of isolation between Donor antenna and Service antenna
  - In case of operating under Repeater Gain=105dB, Antenna Isolation=90dB

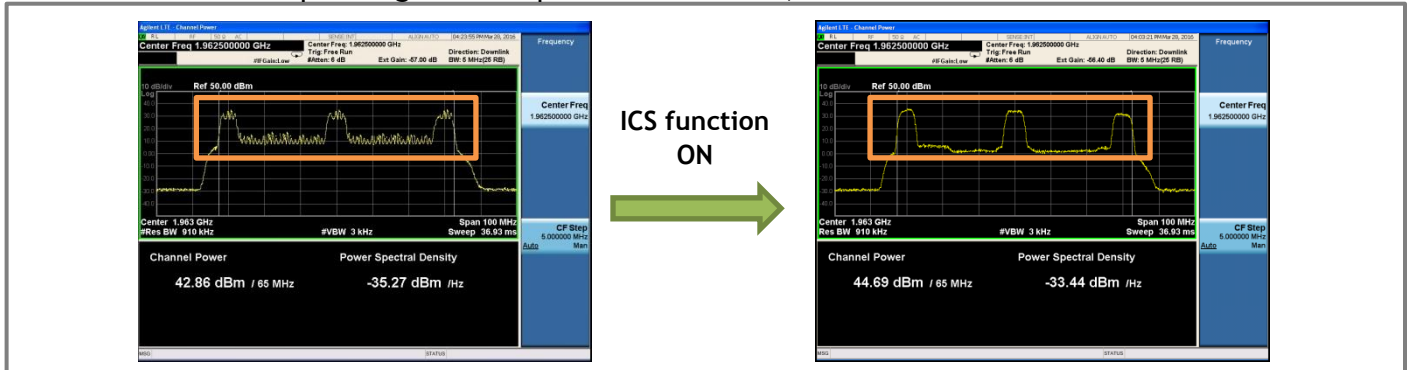

Figure 12. GST-IC-ELITE-1943 ICS Function Operation

- ILC Function Interworking
  - In case of "90dB<Isolation", Repeater reduce the gain compare to Isolation
  - Repeater total Gain=Repeater Max Gain (105dB)-ILC-Extra Attenuation (ALC, Manual etc.)

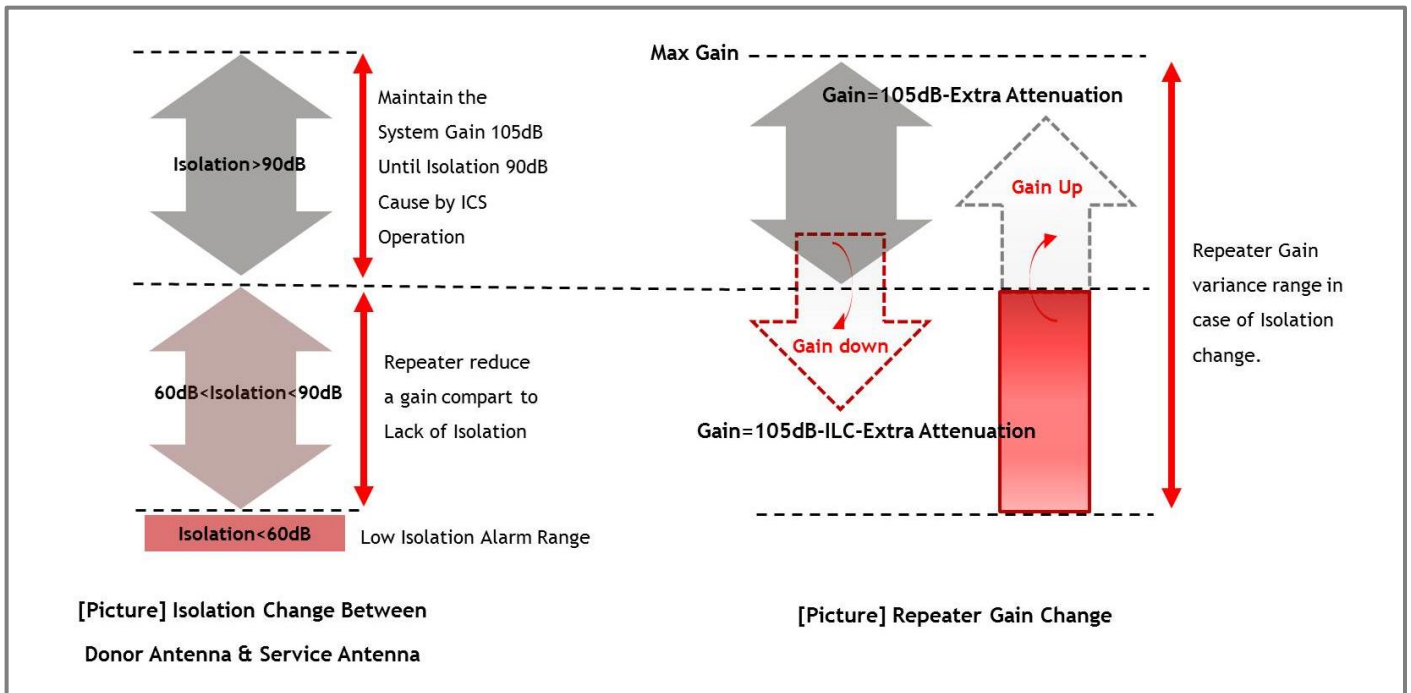

Figure 13. GST-IC-ELITE-1943 ILC Function Interworking



	<u>Version</u> 1.3	<u>Date</u> November 18, 2016	<u>Page</u> 27/ 61
<u>Title</u> USER MANUAL	<u>Prepared by</u>	<u>Reviewed by</u>	<u>Approved by</u>

## 6.7. Download

- To changed and updated features of system operation and monitoring program
  - Upgrade software or install a patch with minimal loss of service  
(Less than 2mins except for FPGA Program)
  - To handle a full software load and to receive/ error-check at the same time
  - If the load is rendered unsatisfactory after the upload, it will automatically revert to the old software load

## 6.8. NMS Operation

- Fault diagnostics and maintenance features can be available both through the Sprint proprietary Network
- Management System (NMS) and locally at the Outdoor Repeater via Local Craft Terminal (LCT)
- All functions that can be performed at the local craft port (physical device) are available thru the remote interface
- All configuration screens at the local craft port physical device location appear identically at the remote location

## 6.9. System Gain Auto Saving

- Save the System Gain according to period for preparing the Power-Off or Reset
- In case of the Repeater is turned off or Reset, Support to re-optimize the system using saved gain as soon as possible

<u>Version</u>	<u>Date</u>	<u>Page</u>
1.3	November 18, 2016	28/ 61
<u>Prepared by</u>	<u>Reviewed by</u>	<u>Approved by</u>
<u>Title</u>		
USER MANUAL		

## 7. Status/ Control & Alarm Monitoring

### 7.1. Status Monitoring and Control Parameters

- In case of control parameter, present status but also setting value display on Web-UI.

	Parameter	Status	Control	Description
Downlink	RSSI	○		A separate display according to CDMA&LTE
	Output	○		A separate display according to CDMA&LTE
	System Gain	○		A separate display according to CDMA&LTE
	ALC		○	Set the ALC function On/Off
	ALC Low Limit		○	Set the ALC Low Limit Value
	Path On/Off		○	Decide to cut off CDMA & LTE
	Attenuation		○	In order to adjust system gain, set the attenuation value
	Isolation (Unit: dB)	○		Display the isolation value between Donor antenna and Service antenna
	Band Selection		○	Select the band that user want to operate
	Final AMP		○	Set the High Power final AMP On/Off
	ASD		○	Set the Auto Shutdown function On/Off
Uplink	RSSI	○		A separate display according to CDMA&LTE
	Output	○		A separate display according to CDMA&LTE
	System Gain	○		A separate display according to CDMA&LTE
	ALC		○	Set the ALC function On/Off
	ALC Low Limit		○	Set the ALC Low Limit Value
	Path On/Off		○	Decide to cut off CDMA&LTE
	Attenuation		○	In order to adjust system gain, set the attenuation value
Uplink	Isolation (Unit: dB)	○		Display the isolation value between Donor antenna and Service antenna
	Gain Balance		○	Select the band that user want to operate & Set the Offset Value
	Final AMP		○	Set the High Power final AMP On/Off

<u>Version</u> 1.3	<u>Date</u> November 18, 2016	<u>Page</u> 29/ 61
<u>Title</u> USER MANUAL	<u>Prepared by</u>	<u>Reviewed by</u>
		<u>Approved by</u>

Parameter	Status	Control	Description
ASD		○	Set the Auto Shutdown function On/Off
Common	ICM Version	○	Display a ICM Software Version
	DL/UL FPGA Version	○	Display a DL/UL FPGA Software Version
	Final AMP Version	○	Display a Final AMP Software Version
	Site ID		○ Write the location Info. that install a repeater
	System Serial Number		○ Write a System Serial Number
	ICM Serial Number	○	Display a ICM Serial Number
	Final AMP Serial Number	○	Display a Final AMP Serial Number
	SNMP Serial Number		○ Write SNMP Serial Number
	System Temperature	○	○ Display a present temperature inside a repeater Set the temperature high limit value
	Alarm Delay		○ Set the delay time that transmit from repeater to Server
	Smart AGS		○ Set the Smart AGS function On/ Off
	ICS function		○ Set the ICS function On/Off
	FAN Operation		○ Operating On/Off and Select Auto/ Manual
	RET Power		○ On/ Off +24Vdc for Operating RET
Signal Information	○	Display RSRP, RSRQ, SINR, Ec/Io, Ec, LTE PCI, CDMA PN	

**Table 9. GST-IC-ELITE-1943 Status Monitoring and Control Parameters**

<u>Version</u>	<u>Date</u>	<u>Page</u>
1.3	November 18, 2016	30/ 61
<u>Title</u>	<u>Prepared by</u>	<u>Reviewed by</u>
USER MANUAL		<u>Approved by</u>

## 7.2. Alarm Monitoring

- All of alarms in Repeater are able to check thru Local maintenance Port & Remote Site
- Provide to Alarm Mask function in order to ignoring unnecessary alarm

	Parameter	Alarm conditions	Recovery
Downlink	DL Over RSSI	Input power exceed a setting value (Band independently)	< Hysteresis 2dB
	DL PLL Fail	Detect the Alarm from PLL	Alarm Clearing
	DL Low RSSI	Band RSSI < Input Low limit value	Opposite Condition
	DL Over Output	Output power exceed a setting value (Band independently)	< Hysteresis 1dB
	DL Low Output	RSSI + Gain value - DL ATT - Output $\geq$ Low Output Gap	< Low Output Gap-1
	DL Low Isolation	Isolation < 60dB	Opposite Condition
	DL VSWR	Return loss < 5dB	Return loss > 7dB
	Total Shutdown	Refer to the Shutdown	
	CDMA Band Shutdown	After finishing fully Shutdown , report the alarm to server And then display Outside LED to RED	
	LTE Band Shutdown	DL & UL Shutdown work independently & simultaneously	
Uplink	UL Over RSSI	Input power Exceed a setting value (Band independently)	< Hysteresis 2dB
	UL PLL Fail	Detect the Alarm from PLL	Alarm Clearing
	UL Over Output	Output power exceed a setting value (Band independently)	< Hysteresis 1dB
	UL Low Output	RSSI + Gain value - UL ATT - Output $\geq$ Low Output Gap	< Low Output Gap-1
	UL Low Isolation	Isolation < 60dB	Opposite Condition
	UL VSWR	Return loss < 5dB	Return loss > 7dB
	Total Shutdown	Refer to the Shutdown	
	CDMA Band Shutdown	After finishing fully Shutdown , report the alarm to server And then display Outside LED to RED	
	LTE Band Shutdown	DL & UL Shutdown work independently & simultaneously	

<u>Version</u>	<u>Date</u>	<u>Page</u>
1.3	November 18, 2016	31/ 61
<u>Title</u>	<u>Prepared by</u>	<u>Reviewed by</u>
USER MANUAL		

Parameter	Alarm conditions	Recovery
Under Current_DC	Output voltage below 90%	DC Recovery
ICM RESET	Hold the Alarm during 60s after system Reset	Normal operation after 60s
ICM HW Fail	ICM FPGA Fail (Judging from MCU, Except for RESET) DL/ UL Output Shutdown	Alarm & Power Recovery
AMP Link Fail	Communication Fail between ICM& Final AMP	Communication
AMP H/W Fail	Alarm from the Final AMP when AMP H/W fail	Fail Condition Clearing
Link Fail	Communication Fail between ICM& SNMP	Communication
Over Temperature	System: REAL Temp>Setting Value Refer to Final Amp Temperature : Alarm: 85℃~90℃ / Shutdown: > 90℃	System: Opposite Final Amp: < 80℃
FAN Alarm	Alarm from FAN	Opposite Condition
RET Link Fail	Communication Fail between SNMP & RET	Communication
Donor Antenna RET	Receive the alarm Info. From Donor Antenna	Clearing Alarm
Service Antenna RET	Receive the alarm Info. From Service Antenna	Clearing Alarm
Total Alarm Display	Only System Outside	

**Table 10. Monitoring Alarm Parameters**

	<u>Version</u> 1.3	<u>Date</u> November 18, 2016	<u>Page</u> 32/ 61
<u>Title</u> USER MANUAL	<u>Prepared by</u>	<u>Reviewed by</u>	<u>Approved by</u>

## 8. Web-UI Overview

- Provide all functions that can be performed at the local craft port will be available thru the remote interface
- Support the GUI pages that will be addressable via the LTE/ CDMA wireless modem
- Support Remote access that will enable troubleshooting down to a specific location

### 8.1. Configuration the Laptop to Connect to the Repeater

- Connect an Ethernet crossover cable from the LAN port of the repeater's bottom side to your laptop

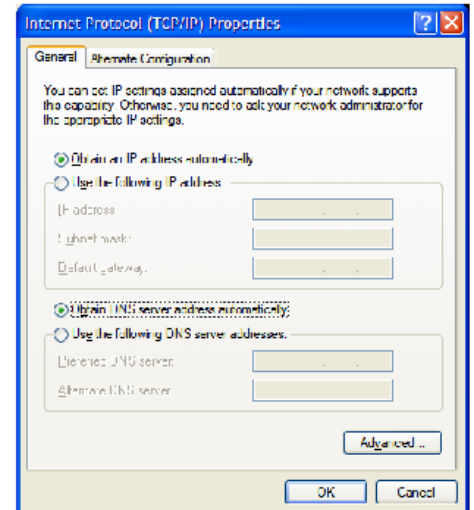
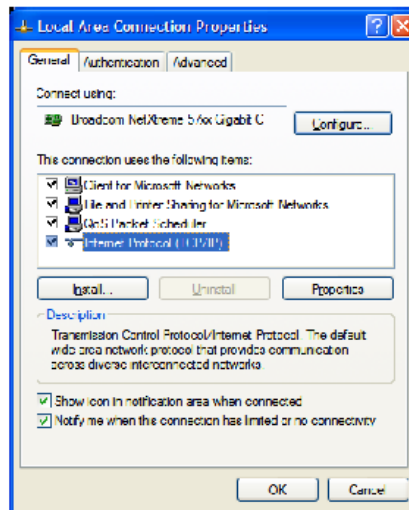
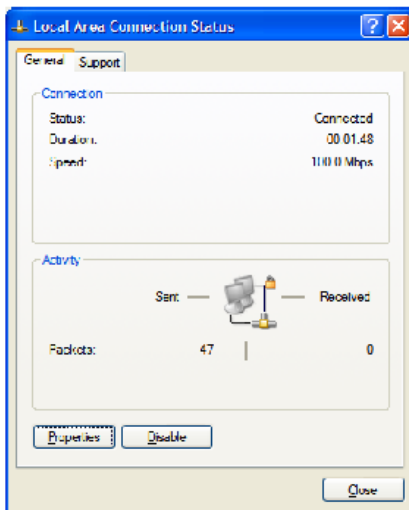

1. Go to Local Connection
2. Click on "Properties"

3. Highlight "Internet Protocol"
4. Click on "Properties"

5. Choose "Obtain DNS Server address automatically"
6. Click OK



	<u>Version</u> 1.3	<u>Date</u> November 18, 2016	<u>Page</u> 33/ 61
<u>Title</u> USER MANUAL	<u>Prepared by</u>	<u>Reviewed by</u>	<u>Approved by</u>

## 8.2. Login-In Screen

- Web-UI Screen for Log-In
- After Logging, User can be able to operate Web-UI
- Register & Delete a User name/ Password: Refer to 9.8 User Management
- Display Total Alarm & Shutdown Status
- Enter the IP Address "192.168.1.1" into your browser address bar and you will be redirected to the Login page

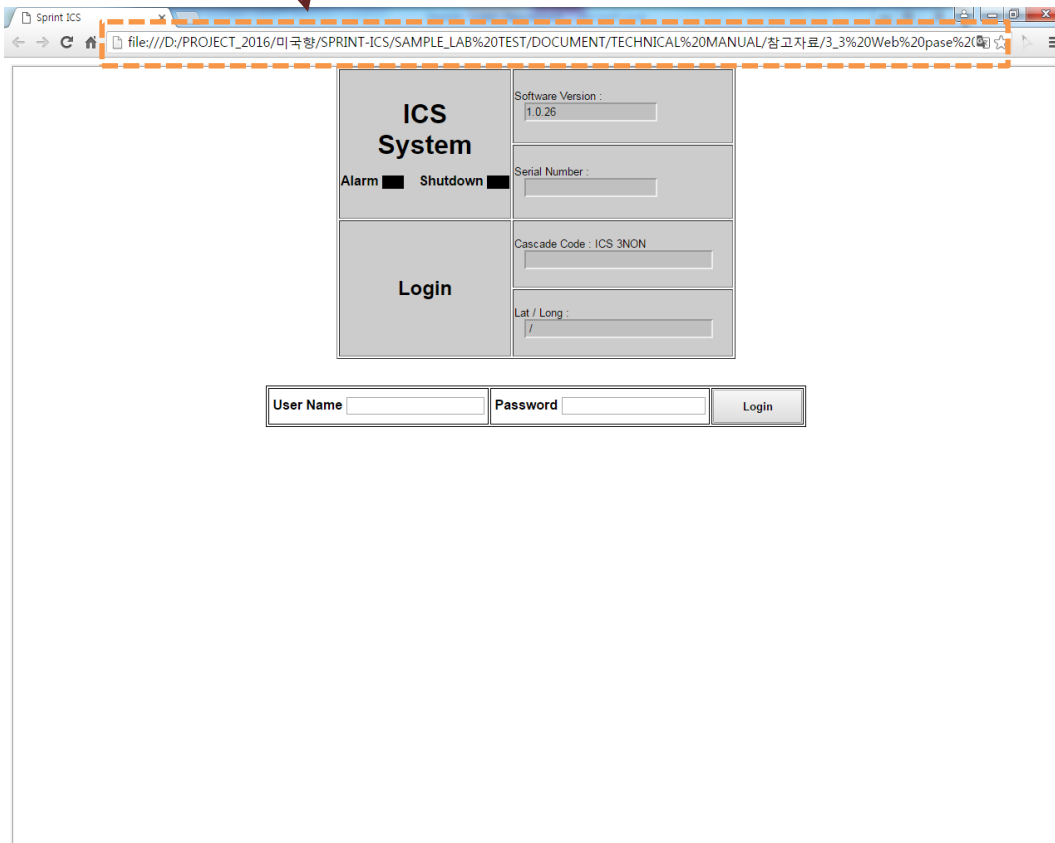

	<u>Version</u> 1.3	<u>Date</u> November 18, 2016	<u>Page</u> 34/ 61
<u>Title</u> USER MANUAL	<u>Prepared by</u>	<u>Reviewed by</u>	<u>Approved by</u>

### 8.3. Main Screen

- Web-UI Screen for Main Menu
- Able to select function RF Configuration & Status monitoring

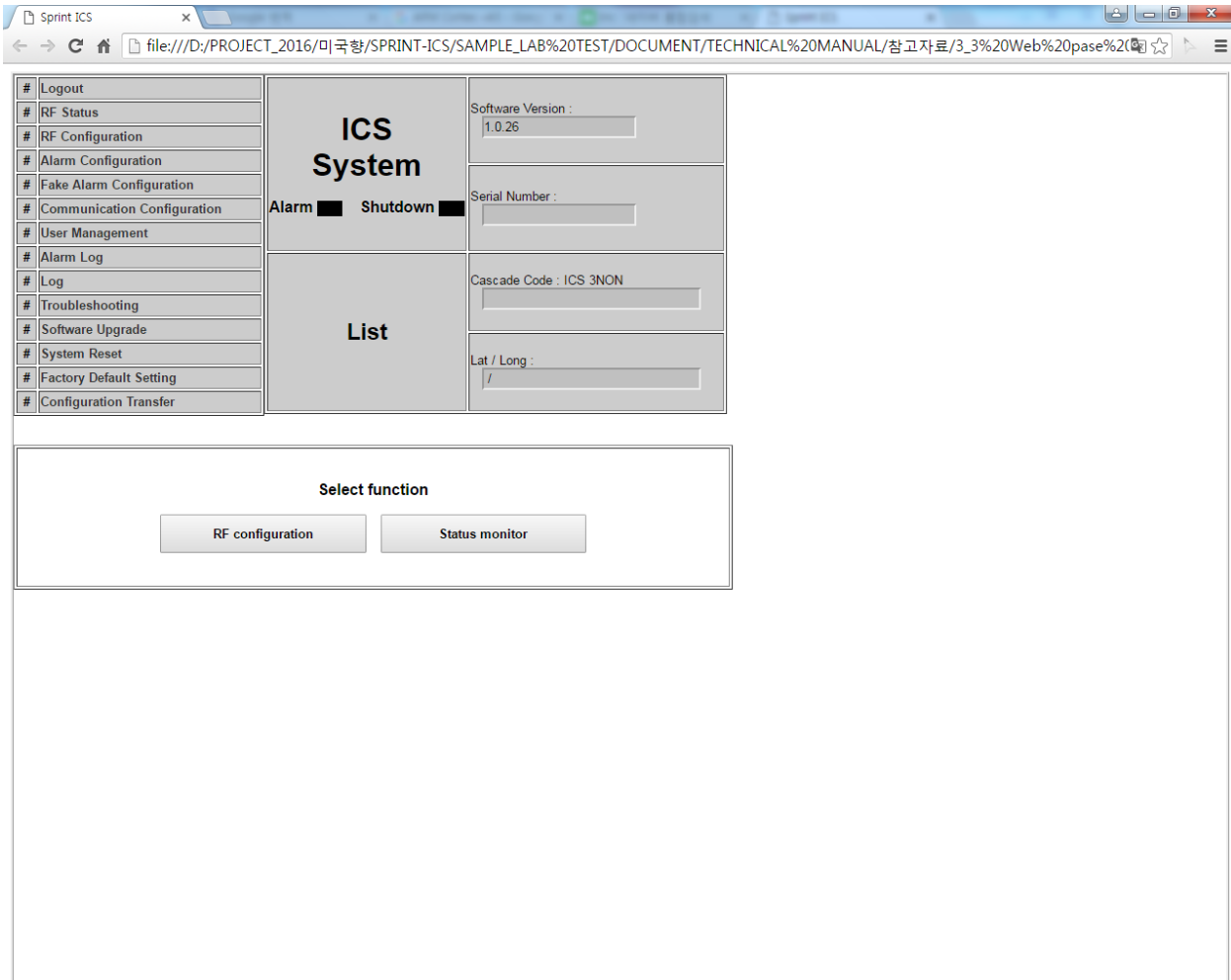

	<u>Version</u> 1.3	<u>Date</u> November 18, 2016	<u>Page</u> 35 / 61
<u>Title</u> USER MANUAL	<u>Prepared by</u>	<u>Reviewed by</u>	<u>Approved by</u>

## 8.4. RF Status

- Web-UI Screen for display Repeater's RF Status

**ICS System**  
Alarm ■ Shutdown ■

**RF Status**

Software Version: 0.6.03(0.6.3)  
Serial Number:   
Cascade Code: ICS 20W  
Donor SiteID:

**Status - ICS 20W** Configuration

Cascade Code:   
[ICS] S'N: RF Configuration

	Downlink			Uplink		
	CDMA	LTE 1	Total	CDMA	LTE 1	Total
RSSI[dBm]	-65.1	-65.1	-47.5	-134.9	-75.0	-67.7
OutputPower[dBm]	40.0	39.9	42.6	-29.9	30.0	29.8
Gain[dB]	105.0	105.0		105.0	105.0	
ALC[dB]	40.0	40.0		30.0	30.0	
ALC Lower Limit[dB]	0.0	0.0		0.0	0.0	
Path OnOff	ON	ON	ON	OFF	ON	ON
AGS Gain[dB]	105.0	105.0		105.0	105.0	
Gain Balance Value[dB]	0.0	0.0		ON	ON	
ALC onoff		ON			ON	
Attenuation[dB]		0.0			0	
Isolation[dB]		145.0			145.0	

**Common**

ICS Version	0.0.62	Amp Version	1.0
DL FPGA version	0.1.35	UL FPGA version	0.0.94
ICM Serial number		Amp Serial number	
TEMP[C]	40.0	TEMP High Limit[C]	85
Alarm Delay onoff	OFF	Smart AGS OnOff	OFF
FAN onoff	OFF		

**Alarm**

Name	CDMA	LTE 1	Name	CDMA	LTE 1
DL Over Output	<span style="color: green;">■</span>	<span style="color: green;">■</span>	UL Over Output	<span style="color: green;">■</span>	<span style="color: green;">■</span>
DL Over RSSI	<span style="color: green;">■</span>	<span style="color: green;">■</span>	UL Over RSSI	<span style="color: green;">■</span>	<span style="color: green;">■</span>
DL Low Output	<span style="color: green;">■</span>	<span style="color: green;">■</span>	DL Low RSSI	<span style="color: green;">■</span>	<span style="color: green;">■</span>
CDMA Shutdown	<span style="color: green;">■</span>	LTE Shutdown <span style="color: green;">■</span>	Amp Shutdown	<span style="color: green;">■</span>	<span style="color: green;">■</span>
DL LowIsolation	<span style="color: green;">■</span>	DL VSWR <span style="color: green;">■</span>	UL LowIsolation	<span style="color: green;">■</span>	UL VSWR <span style="color: green;">■</span>
Temp	RESET <span style="color: green;">■</span>	ICM HW <span style="color: green;">■</span>	AMP HW	<span style="color: green;">■</span>	<span style="color: green;">■</span>
LINK FAIL	PLL ALARM <span style="color: green;">■</span>	Heartbeat <span style="color: green;">■</span>	UNDER CURRENT	<span style="color: green;">■</span>	<span style="color: green;">■</span>
RET LINK	Donor RET <span style="color: green;">■</span>	Service RET <span style="color: green;">■</span>	FAN	<span style="color: green;">■</span>	<span style="color: green;">■</span>

**CDMA Band Selection**

A1	+	A2	+	A3	+	D	+	B1	+	B2	+	B3	+
<input checked="" type="checkbox"/>	<input checked="" type="checkbox"/>	<input type="checkbox"/>	<input type="checkbox"/>	<input type="checkbox"/>	<input type="checkbox"/>	<input type="checkbox"/>	<input type="checkbox"/>	<input type="checkbox"/>	<input type="checkbox"/>	<input type="checkbox"/>	<input type="checkbox"/>	<input type="checkbox"/>	<input type="checkbox"/>
E	+	F	+	C1	+	C2	+	C3	+	G			
<input type="checkbox"/>	<input type="checkbox"/>	<input type="checkbox"/>	<input type="checkbox"/>	<input type="checkbox"/>	<input type="checkbox"/>	<input type="checkbox"/>	<input type="checkbox"/>	<input type="checkbox"/>	<input type="checkbox"/>	<input type="checkbox"/>	<input type="checkbox"/>	<input type="checkbox"/>	<input type="checkbox"/>

**LTE1 Band Selection**

EARFCN_BW	5M	EARFCN	8665.0										
A1	+	A2	+	A3	+	D	+	B1	+	B2	+	B3	+
<input type="checkbox"/>	<input type="checkbox"/>	<input type="checkbox"/>	<input type="checkbox"/>	<input type="checkbox"/>	<input type="checkbox"/>	<input type="checkbox"/>	<input type="checkbox"/>	<input type="checkbox"/>	<input type="checkbox"/>	<input type="checkbox"/>	<input type="checkbox"/>	<input type="checkbox"/>	<input type="checkbox"/>
E	+	F	+	C1	+	C2	+	C3	+	G			
<input type="checkbox"/>	<input type="checkbox"/>	<input type="checkbox"/>	<input type="checkbox"/>	<input type="checkbox"/>	<input type="checkbox"/>	<input type="checkbox"/>	<input type="checkbox"/>	<input type="checkbox"/>	<input type="checkbox"/>	<input checked="" type="checkbox"/>	<input checked="" type="checkbox"/>	<input checked="" type="checkbox"/>	<input type="checkbox"/>

**Modem**

CDMA Channel	0.0	LTE EARFCN	0.0
CDMA PN	0.0	LTE PCI	0.0
CDMA RSSI[dBm]	0.0	LTE RSRQ[dBm]	0.0
CDMA ECIO[dB]	0.0	LTE RSRP[dBm]	0.0
CDMA EC [dB]	0.0	LTE SINR[dB]	0.0

**RET**

	Donor	1st Service	2nd Service
Model			
Band			
InstallDate			
InstallID			
Status			
DownTilt	40.0	40.0	40.0

	<u>Version</u> 1.3	<u>Date</u> November 18, 2016	<u>Page</u> 36/ 61
<u>Title</u> USER MANUAL	<u>Prepared by</u>	<u>Reviewed by</u>	<u>Approved by</u>

## 8.5. RF Configuration

- Web-UI Screen in order to change the RF values
- User may change the various RF values of the repeater on this page
- Changes will not take effect until you click "Apply" button
- This menu is where the installer will choose references for specific implementation

The screenshot displays the 'RF Configuration' web interface for the ICS System. The interface is organized into several sections:

- Navigation Menu:** Includes options like Logout, RF Status, RF Configuration (selected), Alarm Configuration, Fake Alarm Configuration, Communication Configuration, User Management, Alarm Log, Log, Troubleshooting, Software Upgrade, System Reset, Factory Default Setting, Configuration Transfer, and Modem Activation.
- System Information:** Shows 'ICS System' with 'Alarm' and 'Shutdown' status indicators. It also displays 'Software Version: 0.6.03[0.6.3]', 'Serial Number', 'Cascade Code: ICS 20W', and 'Donor SiteID'.
- RF Configuration Section:** Contains a table for configuring Downlink and Uplink parameters.
 

Downlink				Uplink			
CDMA	LTE 1	LTE 2	Total	CDMA	LTE 1	LTE 2	Total
ALC Value[dB]				ALC Value[dB]			
40.0	40.0	40.0		30.0	30.0	30.0	
ALC Lower Limit[dB]				ALC Lower Limit[dB]			
0.0	0.0	0.0		0.0	0.0	0.0	
Path On/Off				Path On/Off			
ON	ON	OFF	OFF	OFF	ON	OFF	OFF
Gain Balance Value[dB]				Gain Balance On/off			
0.0	0.0	0.0		ON	ON	ON	
ALC on/off				ALC on/off			
Attenuation[dB]				Attenuation[dB]			
				0.0			
- Common Section:** Includes fields for Cascade Code, Donor SiteID, ICM Serial number, Alarm Delay on/off (OFF), TEMP High Limit[C] (85), and Smart AGS On/Off (OFF).
- CDMA Band Selection:** A grid of checkboxes for selecting CDMA bands (A1-A3, D, B1-B3, E, F, C1-C3, G).
- LTE Band Selection:** Fields for LTE1 EARFCN\_BW (10M) and LTE1 EARFCN (8665.0), and LTE2 EARFCN\_BW (OFF) and LTE2 EARFCN (0.0).
- RET Section:** A table for Donor, 1st Service, and 2nd Service configurations.
 

	Donor	1st Service	2nd Service
InstalID			
Status			

	<u>Version</u> 1.3	<u>Date</u> November 18, 2016	<u>Page</u> 37/ 61
<u>Title</u> USER MANUAL	<u>Prepared by</u>	<u>Reviewed by</u>	<u>Approved by</u>

## 8.6. Alarm Configuration

- Web-UI Screen for Alarm Configurations
- Define a TRAP alarm thru SNMP Mapping
- Decide to activate an each alarm
- When "Report Alarm" is OFF, all alarms are disabled. When "Report Alarm" is ON, alarms can be Enable/ disabled individually

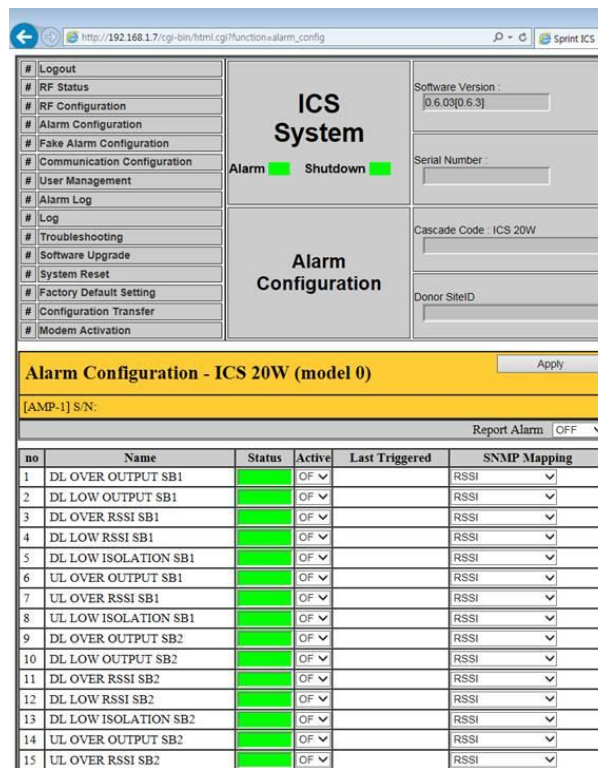

The screenshot displays the 'Alarm Configuration' page for an ICS 20W (model 0) device. The page includes a navigation menu on the left, system status indicators for 'Alarm' and 'Shutdown', and a table of configured alarms. The 'Report Alarm' status is currently set to 'OFF'.

no	Name	Status	Active	Last Triggered	SNMP Mapping
1	DL OVER OUTPUT SB1	ON	OF		RSSI
2	DL LOW OUTPUT SB1	ON	OF		RSSI
3	DL OVER RSSI SB1	ON	OF		RSSI
4	DL LOW RSSI SB1	ON	OF		RSSI
5	DL LOW ISOLATION SB1	ON	OF		RSSI
6	UL OVER OUTPUT SB1	ON	OF		RSSI
7	UL OVER RSSI SB1	ON	OF		RSSI
8	UL LOW ISOLATION SB1	ON	OF		RSSI
9	DL OVER OUTPUT SB2	ON	OF		RSSI
10	DL LOW OUTPUT SB2	ON	OF		RSSI
11	DL OVER RSSI SB2	ON	OF		RSSI
12	DL LOW RSSI SB2	ON	OF		RSSI
13	DL LOW ISOLATION SB2	ON	OF		RSSI
14	UL OVER OUTPUT SB2	ON	OF		RSSI
15	UL OVER RSSI SB2	ON	OF		RSSI

	<u>Version</u> 1.3	<u>Date</u> November 18, 2016	<u>Page</u> 38/ 61
<u>Title</u> USER MANUAL	<u>Prepared by</u>	<u>Reviewed by</u>	<u>Approved by</u>

## 8.7. Fake Alarm Configuration

- Web-UI Screen for Fake Alarm Configurations
- In order to test about transmitting alarm to Sprint Server, Fake alarm occur in SNMP Board



The screenshot shows the 'Fake alarm configuration - ICS 20W (model 0)' web interface. It features a navigation menu on the left with options like Logout, RF Status, Alarm Configuration, and Fake Alarm Configuration. The main content area is divided into 'ICS System' (with Alarm and Shutdown status indicators) and 'Fake alarm configuration'. Below this, there is a configuration section for '[AMP-1] S/N:' and a 'Fake alarm mode' dropdown set to 'OFF'. A table lists 15 alarm configurations with columns for 'no', 'name', 'status', and 'active'.

no	name	status	active
1	DL OVER OUTPUT SB1		OFF
2	DL LOW OUTPUT SB1		OFF
3	DL OVER RSSI SB1		OFF
4	DL LOW RSSI SB1		OFF
5	DL LOW ISOLATION SB1		OFF
6	UL OVER OUTPUT SB1		OFF
7	UL OVER RSSI SB1		OFF
8	UL LOW ISOLATION SB1		OFF
9	DL OVER OUTPUT SB2		OFF
10	DL LOW OUTPUT SB2		OFF
11	DL OVER RSSI SB2		OFF
12	DL LOW RSSI SB2		OFF
13	DL LOW ISOLATION SB2		OFF
14	UL OVER OUTPUT SB2		OFF
15	UL OVER RSSI SB2		OFF

	<u>Version</u> 1.3	<u>Date</u> November 18, 2016	<u>Page</u> 39/ 61
<u>Title</u> USER MANUAL	<u>Prepared by</u>	<u>Reviewed by</u>	<u>Approved by</u>

## 8.8. Communication Configuration

- Web-UI Screen for Communication Configurations
- Set the information in order to connect to Sprint Server
- On this page you can change the various values related to IP network. Because the Web-UI is based on the IP network, incorrect configuration may make it impossible to connect to the Web-UI.
- In that case, Contact GSI Technical Support for further instructions

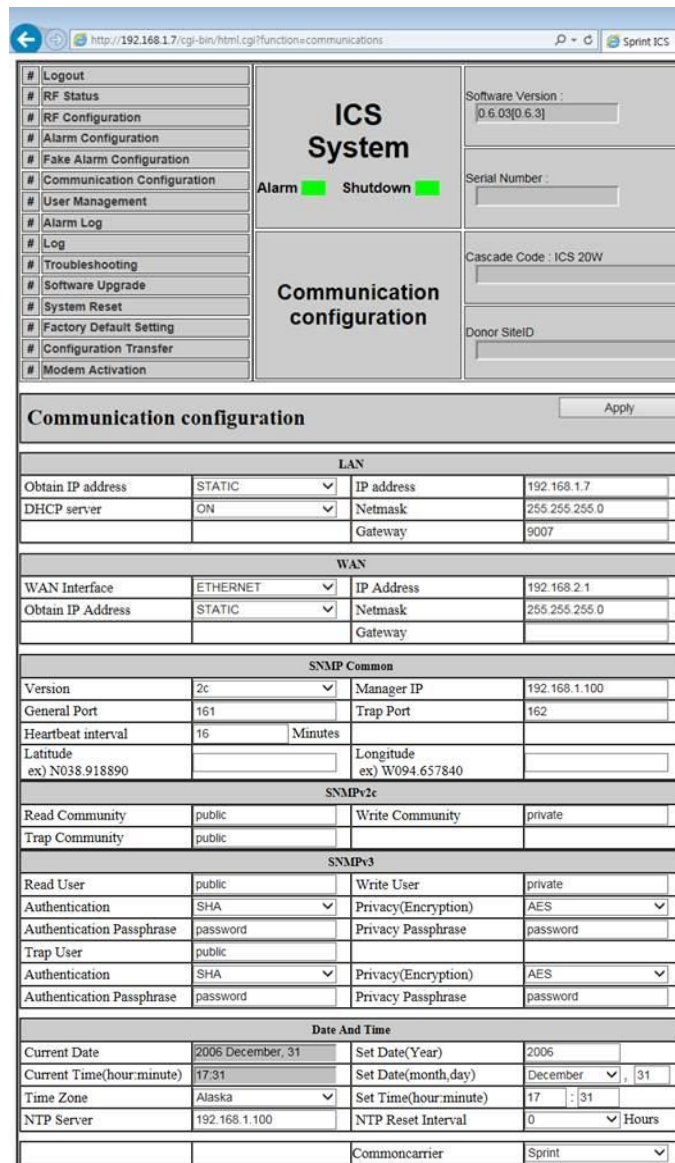

<a href="#">Logout</a> <a href="#">RF Status</a> <a href="#">RF Configuration</a> <a href="#">Alarm Configuration</a> <a href="#">Fake Alarm Configuration</a> <a href="#">Communication Configuration</a> <a href="#">User Management</a> <a href="#">Alarm Log</a> <a href="#">Log</a> <a href="#">Troubleshooting</a> <a href="#">Software Upgrade</a> <a href="#">System Reset</a> <a href="#">Factory Default Setting</a> <a href="#">Configuration Transfer</a> <a href="#">Modem Activation</a>		<b>ICS System</b> Alarm <span style="color: green;">■</span> Shutdown <span style="color: green;">■</span>		Software Version : <input type="text" value="0.6.03[0.6.3]"/>
				Serial Number : <input type="text"/>
				Cascade Code : ICS 20W <input type="text"/>
				Donor SiteID <input type="text"/>

Communication configuration				Apply
<b>LAN</b>				
Obtain IP address	STATIC	IP address	192.168.1.7	
DHCP server	ON	Netmask	255.255.255.0	
		Gateway	9007	
<b>WAN</b>				
WAN Interface	ETHERNET	IP Address	192.168.2.1	
Obtain IP Address	STATIC	Netmask	255.255.255.0	
		Gateway		
<b>SNMP Common</b>				
Version	2c	Manager IP	192.168.1.100	
General Port	161	Trap Port	162	
Heartbeat interval	16	Minutes		
Latitude		Longitude		
ex) N038.918890		ex) W094.657840		
<b>SNMPv2c</b>				
Read Community	public	Write Community	private	
Trap Community	public			
<b>SNMPv3</b>				
Read User	public	Write User	private	
Authentication	SHA	Privacy(Encryption)	AES	
Authentication Passphrase	password	Privacy Passphrase	password	
Trap User	public			
Authentication	SHA	Privacy(Encryption)	AES	
Authentication Passphrase	password	Privacy Passphrase	password	
<b>Date And Time</b>				
Current Date	2006 December, 31	Set Date(Year)	2006	
Current Time(hour:minute)	17:31	Set Date(month,day)	December	31
Time Zone	Alaska	Set Time(hour:minute)	17	: 31
NTP Server	192.168.1.100	NTP Reset Interval	0	Hours
		Commoncarrier	Sprint	

	<u>Version</u> 1.3	<u>Date</u> November 18, 2016	<u>Page</u> 40/ 61
<u>Title</u> USER MANUAL	<u>Prepared by</u>	<u>Reviewed by</u>	<u>Approved by</u>

## 8.9. User Management

- Web-UI Screen for Management about user information
- On this page you can create and delete users, change passwords, and assign authorities to individual users
- Read Authority will only allow the user to view information on the menu pages, but cannot make any changes
- Read/ Write Authority means the user can view and change various values
- Super User is very similar to and Administrator account

### CAUTION

DO NOT DELETE 'admin'.



	<u>Version</u> 1.3	<u>Date</u> November 18, 2016	<u>Page</u> 41/ 61
<u>Title</u> USER MANUAL	<u>Prepared by</u>	<u>Reviewed by</u>	<u>Approved by</u>

## 8.10. Alarm Log

- Web-UI Screen for finding Alarm log
- You can see the history of reported and reset Alarms. When an alarm is reported, the name and time of the alarm is displayed along with its current status
- **Red** means the alarm is reported, **Green** means the alarm has returned to normal status
- An alarm will only be reported if the alarm condition lasts longer that the set value in the "Delay Alarm Reporting Minutes" field, found on the RF configuration page

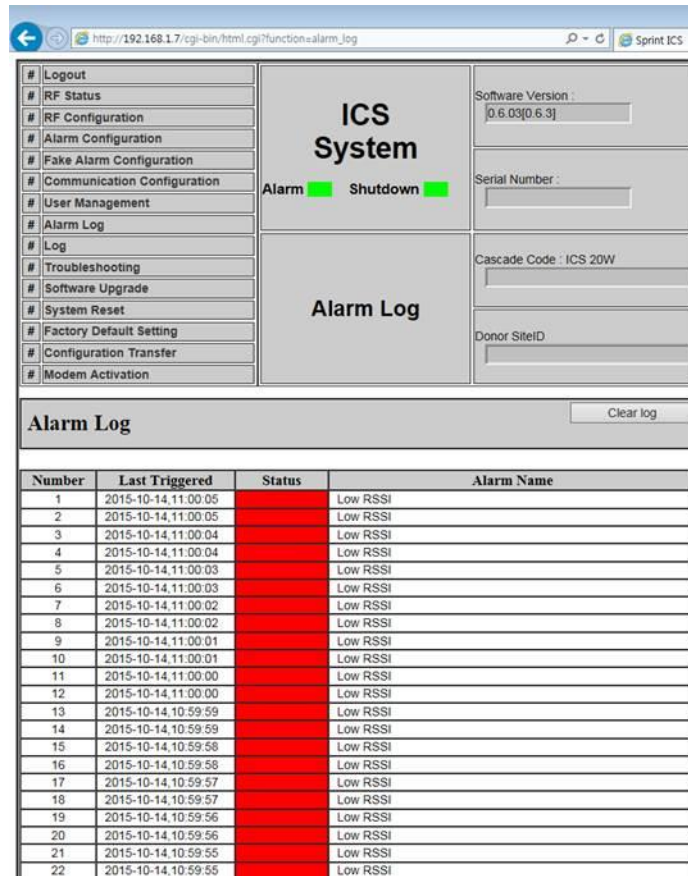

The screenshot shows the 'Alarm Log' section of the ICS System web interface. The interface includes a navigation menu on the left with options like Logout, RF Status, RF Configuration, Alarm Configuration, Fake Alarm Configuration, Communication Configuration, User Management, Alarm Log, Log, Troubleshooting, Software Upgrade, System Reset, Factory Default Setting, Configuration Transfer, and Modem Activation. The main content area displays 'ICS System' with 'Alarm' and 'Shutdown' indicators. Below this, there is an 'Alarm Log' section with a 'Clear log' button and a table of alarm events.

Number	Last Triggered	Status	Alarm Name
1	2015-10-14,11:00:05	Red	Low RSSI
2	2015-10-14,11:00:05	Red	Low RSSI
3	2015-10-14,11:00:04	Red	Low RSSI
4	2015-10-14,11:00:04	Red	Low RSSI
5	2015-10-14,11:00:03	Red	Low RSSI
6	2015-10-14,11:00:03	Red	Low RSSI
7	2015-10-14,11:00:02	Red	Low RSSI
8	2015-10-14,11:00:02	Red	Low RSSI
9	2015-10-14,11:00:01	Red	Low RSSI
10	2015-10-14,11:00:01	Red	Low RSSI
11	2015-10-14,11:00:00	Red	Low RSSI
12	2015-10-14,11:00:00	Red	Low RSSI
13	2015-10-14,10:59:59	Red	Low RSSI
14	2015-10-14,10:59:59	Red	Low RSSI
15	2015-10-14,10:59:58	Red	Low RSSI
16	2015-10-14,10:59:58	Red	Low RSSI
17	2015-10-14,10:59:57	Red	Low RSSI
18	2015-10-14,10:59:57	Red	Low RSSI
19	2015-10-14,10:59:56	Red	Low RSSI
20	2015-10-14,10:59:56	Red	Low RSSI
21	2015-10-14,10:59:55	Red	Low RSSI
22	2015-10-14,10:59:55	Red	Low RSSI

	<u>Version</u> 1.3	<u>Date</u> November 18, 2016	<u>Page</u> 42/ 61
<u>Title</u> USER MANUAL	<u>Prepared by</u>	<u>Reviewed by</u>	<u>Approved by</u>

## 8.11. Log

- Web-UI Screen for reading a List of operation history
- Logs will maintain a history of up to 30 cycles

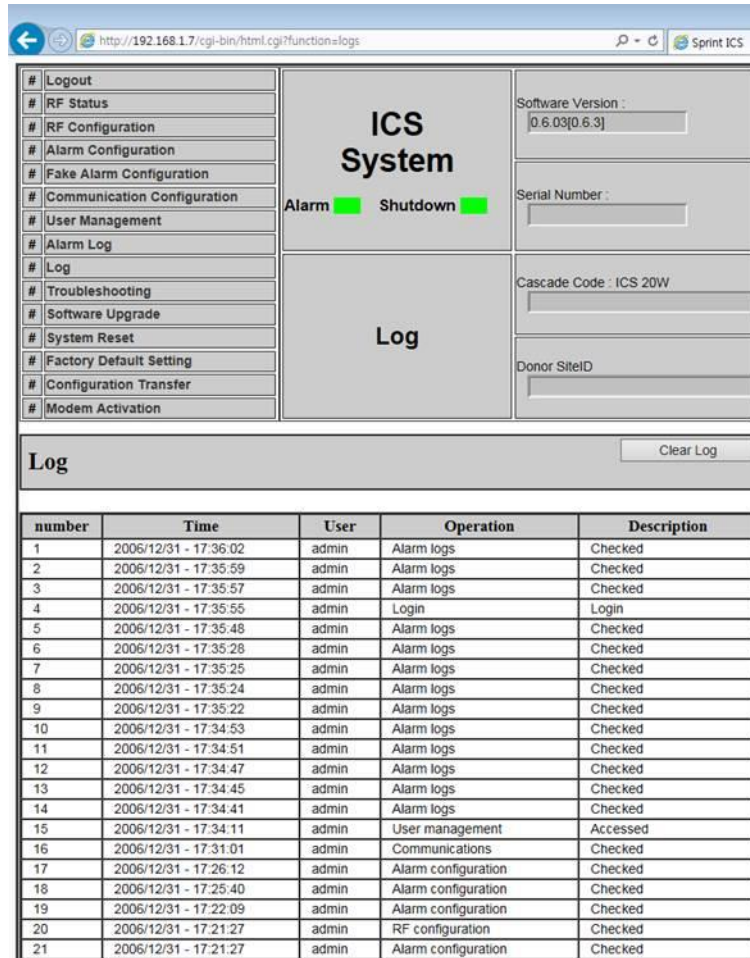

number	Time	User	Operation	Description
1	2006/12/31 - 17:36:02	admin	Alarm logs	Checked
2	2006/12/31 - 17:35:59	admin	Alarm logs	Checked
3	2006/12/31 - 17:35:57	admin	Alarm logs	Checked
4	2006/12/31 - 17:35:55	admin	Login	Login
5	2006/12/31 - 17:35:48	admin	Alarm logs	Checked
6	2006/12/31 - 17:35:28	admin	Alarm logs	Checked
7	2006/12/31 - 17:35:25	admin	Alarm logs	Checked
8	2006/12/31 - 17:35:24	admin	Alarm logs	Checked
9	2006/12/31 - 17:35:22	admin	Alarm logs	Checked
10	2006/12/31 - 17:34:53	admin	Alarm logs	Checked
11	2006/12/31 - 17:34:51	admin	Alarm logs	Checked
12	2006/12/31 - 17:34:47	admin	Alarm logs	Checked
13	2006/12/31 - 17:34:45	admin	Alarm logs	Checked
14	2006/12/31 - 17:34:41	admin	Alarm logs	Checked
15	2006/12/31 - 17:34:11	admin	User management	Accessed
16	2006/12/31 - 17:31:01	admin	Communications	Checked
17	2006/12/31 - 17:26:12	admin	Alarm configuration	Checked
18	2006/12/31 - 17:25:40	admin	Alarm configuration	Checked
19	2006/12/31 - 17:22:09	admin	Alarm configuration	Checked
20	2006/12/31 - 17:21:27	admin	RF configuration	Checked
21	2006/12/31 - 17:21:27	admin	Alarm configuration	Checked

	<u>Version</u> 1.3	<u>Date</u> November 18, 2016	<u>Page</u> 43/ 61
<u>Title</u> USER MANUAL	<u>Prepared by</u>	<u>Reviewed by</u>	<u>Approved by</u>

## 8.12. Troubleshooting

- Web-UI Screen for informing a contact information in case of occurring Field Troubleshooting

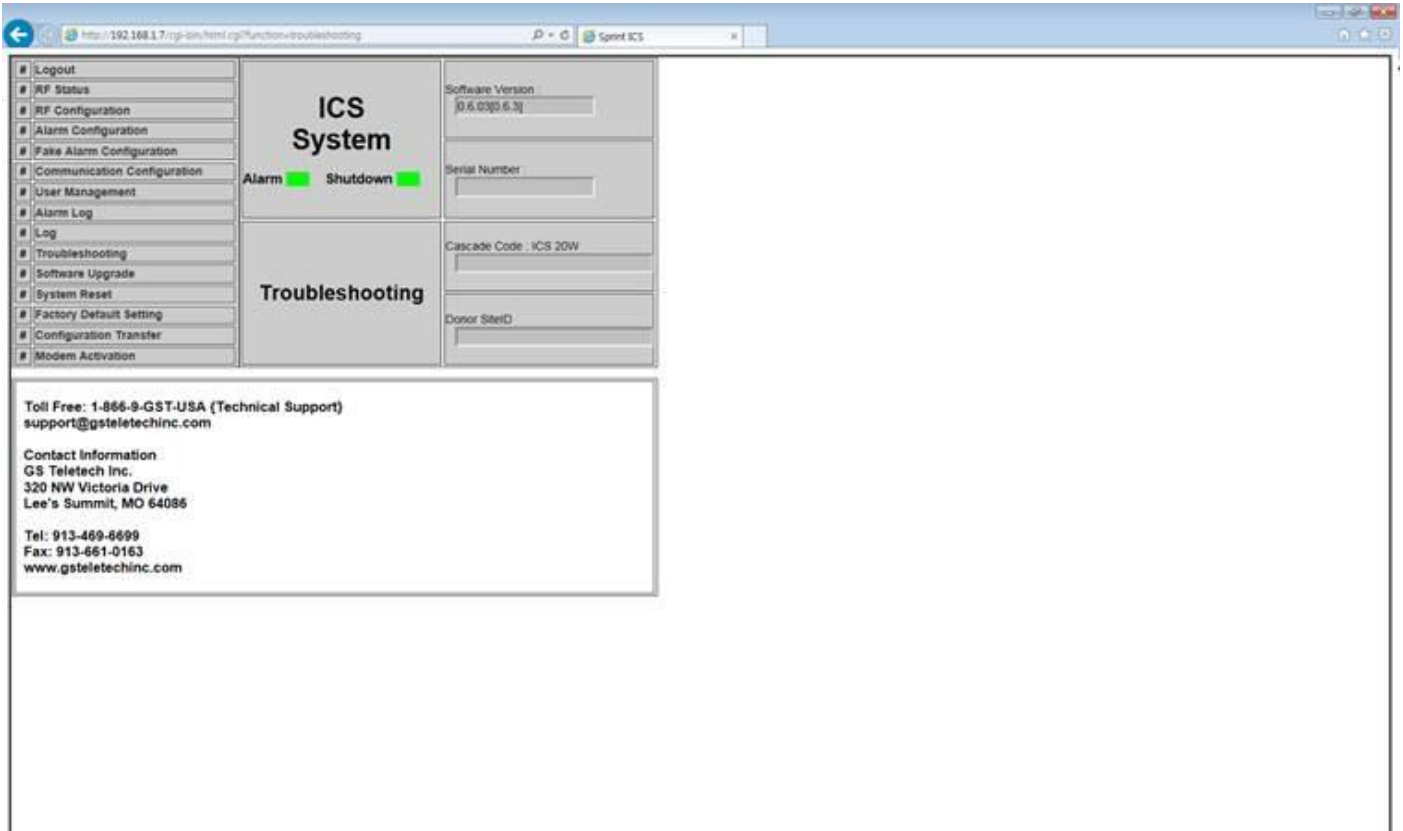

	<u>Version</u> 1.3	<u>Date</u> November 18, 2016	<u>Page</u> 44/ 61
<u>Title</u> USER MANUAL	<u>Prepared by</u>	<u>Reviewed by</u>	<u>Approved by</u>

### 8.13. Software Update

- Web-UI Screen for downloading a software
- Procedure
  1. Go to "Remote Software Upgrade" link
  2. Click Browse button to select the upgrade file from the laptop
  3. Choose the file to upgrade. Provided by manufacturer. After you choose the file, You should click "upload" to send the file from your laptop to the Repeater
  4. Once the file name and file size are displayed, click "Upgrade" to start the upgrade installation
  5. Provided file will have the following format: smc\_vxxxx\_xxxxxxxx.tar.gz

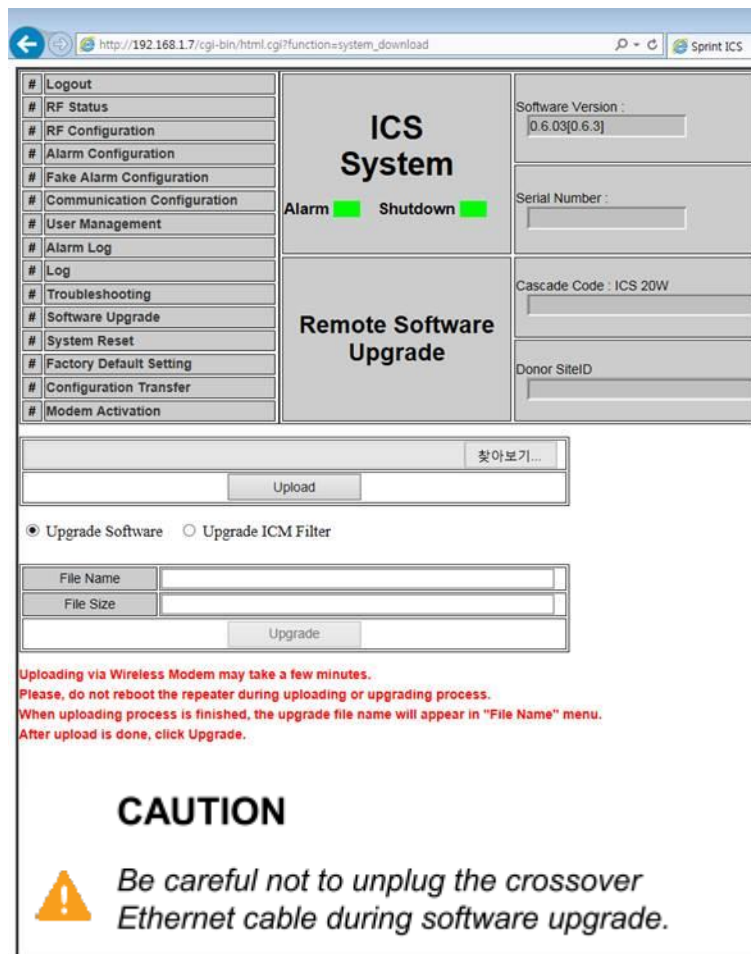

	<u>Version</u> 1.3	<u>Date</u> November 18, 2016	<u>Page</u> 45/ 61
<u>Title</u> USER MANUAL	<u>Prepared by</u>	<u>Reviewed by</u>	<u>Approved by</u>

## 8.14. System Reset

- Web-UI Screen for resetting the system
- Click on the desired reset action
- Click "Yes" to reset the repeater via a soft-boot. This will not change any of the current settings

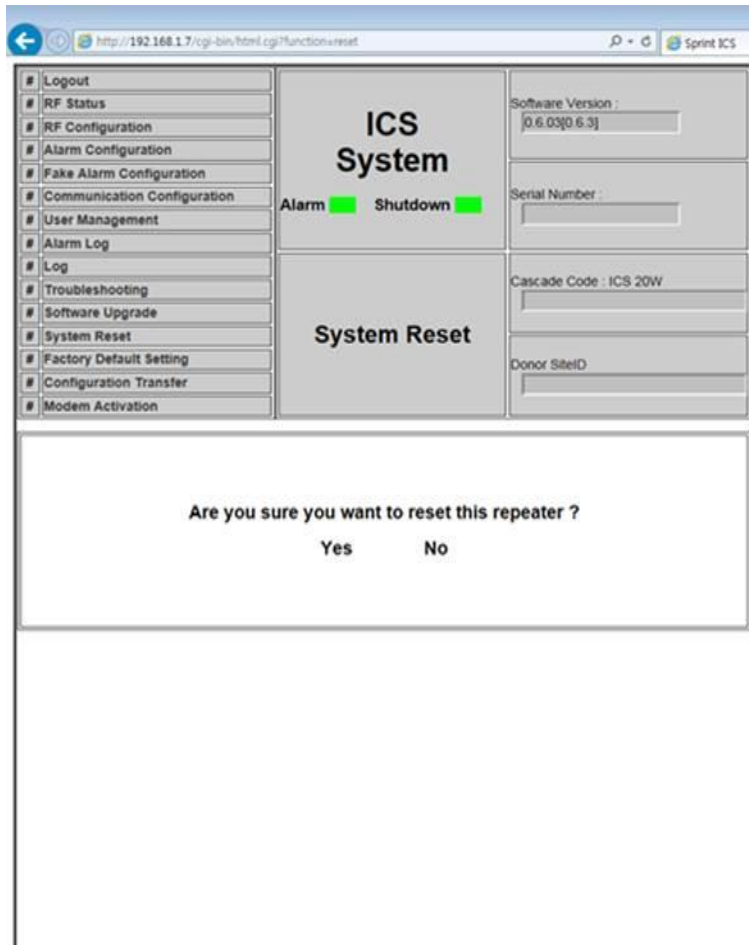

	<u>Version</u> 1.3	<u>Date</u> November 18, 2016	<u>Page</u> 46/ 61
<u>Title</u> USER MANUAL	<u>Prepared by</u>	<u>Reviewed by</u>	<u>Approved by</u>

## 8.15. Factory Default Setting

- Web-UI Screen for Default Setting before operating

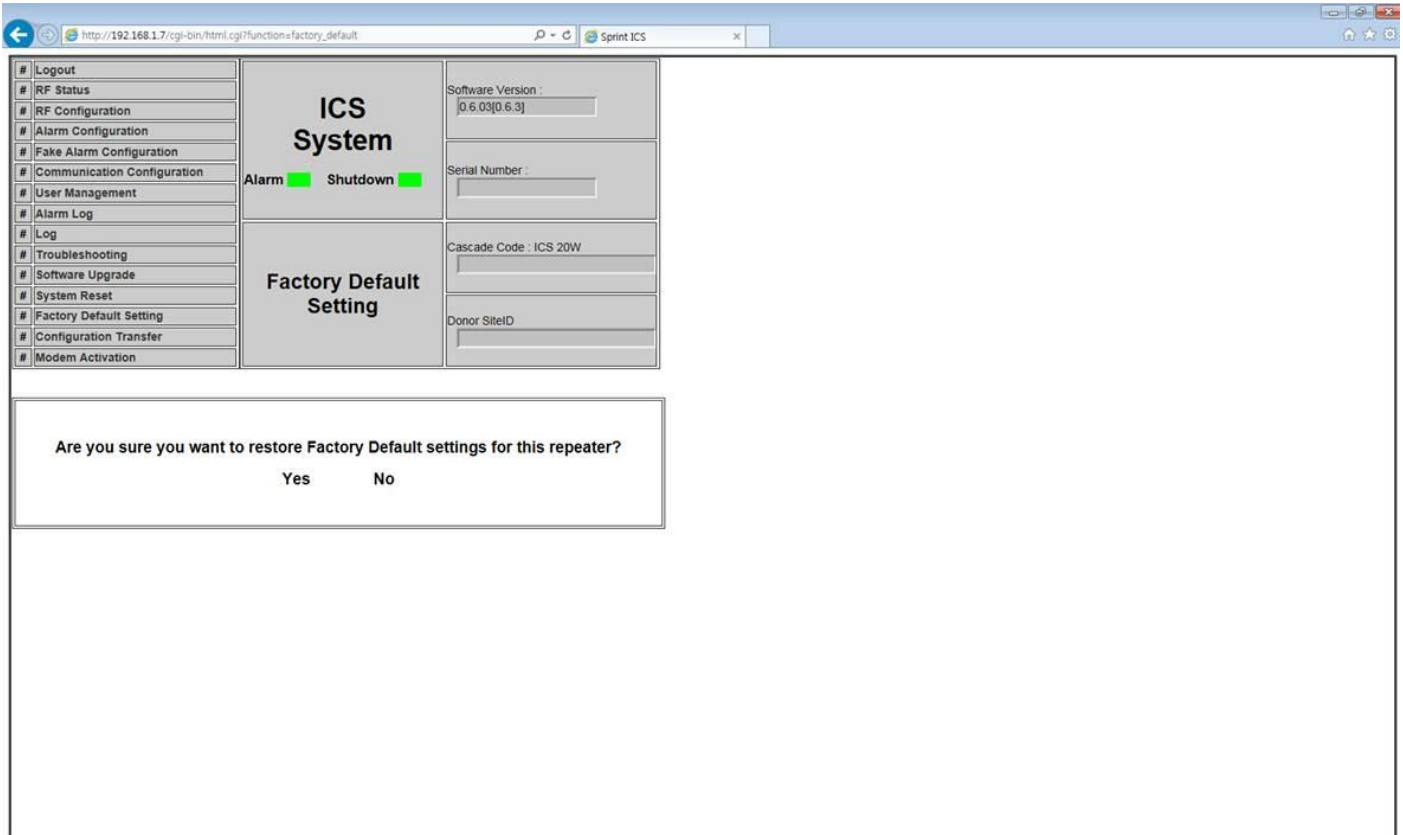

	<u>Version</u> 1.3	<u>Date</u> November 18, 2016	<u>Page</u> 47/ 61
<u>Title</u> USER MANUAL	<u>Prepared by</u>	<u>Reviewed by</u>	<u>Approved by</u>

## 8.16. Configuration Transfer

- Web-UI Screen for mutual information transfer between Repeater and Local Craft

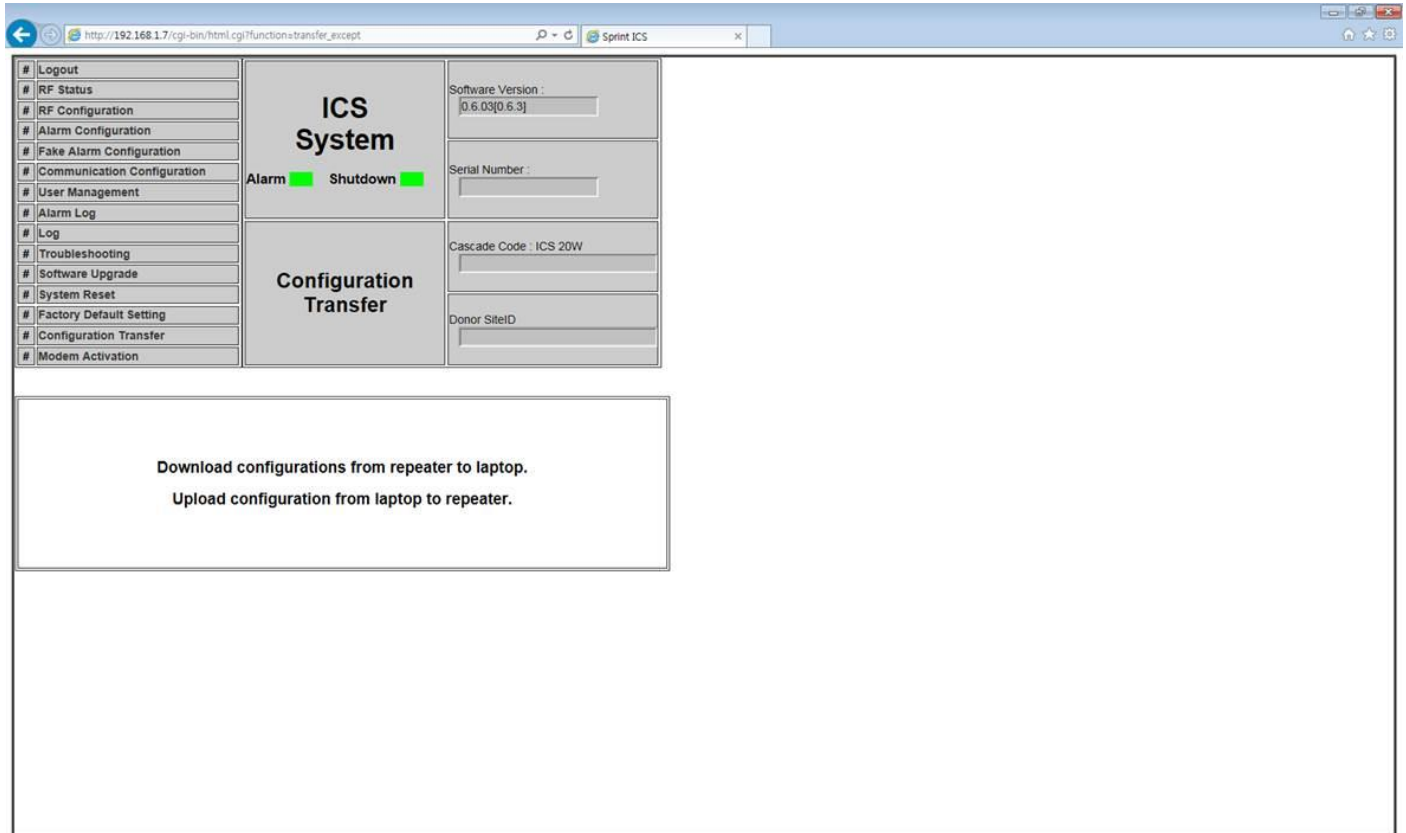

<u>Version</u>	<u>Date</u>	<u>Page</u>
1.3	November 18, 2016	48/ 61
<u>Title</u>	<u>Prepared by</u>	<u>Reviewed by</u>
USER MANUAL		

## 9. System Installation

- This chapter describes how to install the repeater and Cabling method
- The needed accessories and tools are list up as below

#	Contents		Picture	Q'ty
1	Mounting Bracket			1EA
2	Steel band			1EA
3	AC Power Cable SJT 3/16 AWG, 6ft			1EA
4	Frame Ground Cable with Tubular Cable Lug, 6ft			1EA
5	Installation purchase set	EYE BOLT(M12)		1EA
		M5x12mm WRENCH BOLT, SEMS		2EA
		PH(+) M4x8mm ,SEMS		4EA
6	Mounting Screw set	LAG SCREW 3/8"x3"		2EA
		HEX HEAD 3/8"x2", SCM440		2EA
		Φ10.5mm/Φ21mm PLAIN WASHER		2EA
		Φ10.2mm/Φ18.4mm SPRING WASHER		2EA
7	Tubing Tube Sleeve Black	Φ30mm/L:150mm Adhesive Polyolefin 3:1 Heat Shrink		1EA

Table 11. GST-Ic-ELITE-1943 Installation Accessories



	<u>Version</u> 1.3	<u>Date</u> November 18, 2016	<u>Page</u> 49/ 61
<u>Title</u> USER MANUAL	<u>Prepared by</u>	<u>Reviewed by</u>	<u>Approved by</u>

## 9.1. Warnings and Hazards

### 9.1.1. Electric Shock



- Opening the Repeater could result in electrical shock and may cause severe injury
- Operating the Repeater with antennas in very close proximity facing each other could lead to severe damage to the repeater

### 9.1.2. Exposure to RF



Working with the repeater while in operation, may expose the technician to RF electromagnetic fields that exceed FCC Rules for human exposure.

Visit the FCC Website at <http://www.fcc.gov/oet/rfsafety> to learn more about

The effects of exposure to RF electromagnetic fields

## 9.2. Position Antenna

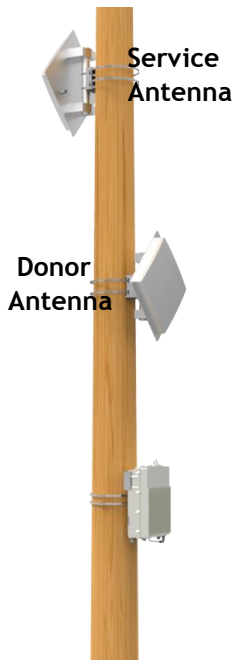

- After installing antennas, Installer should ensure line of Site
- Actual separation distance is determined upon gain of antenna used So, maintain a minimum safe distance that achieved isolation 60dB at least while operating near the donor and service antenna
- Antennas needs to be mounted outdoors on a permanent structure
- Antenna's general specification is below

PART	Donor	Service
Frequency	1850-1995	1850-1995
Gain	20dBi	20dBi
VSWR	< 1.5	< 1.5
Polarization	Vertical	Vertical
FRB	> 40	> 25
Size (Inch)	27.6 x 27.6 x 5.4	78.7 x 11.8 x 6.2

	<u>Version</u> 1.3	<u>Date</u> November 18, 2016	<u>Page</u> 50/ 61
<u>Title</u> USER MANUAL	<u>Prepared by</u>	<u>Reviewed by</u>	<u>Approved by</u>

### 9.3. Cabling

The cabling diagram of the GST-IC-ELITE1943 is as follows

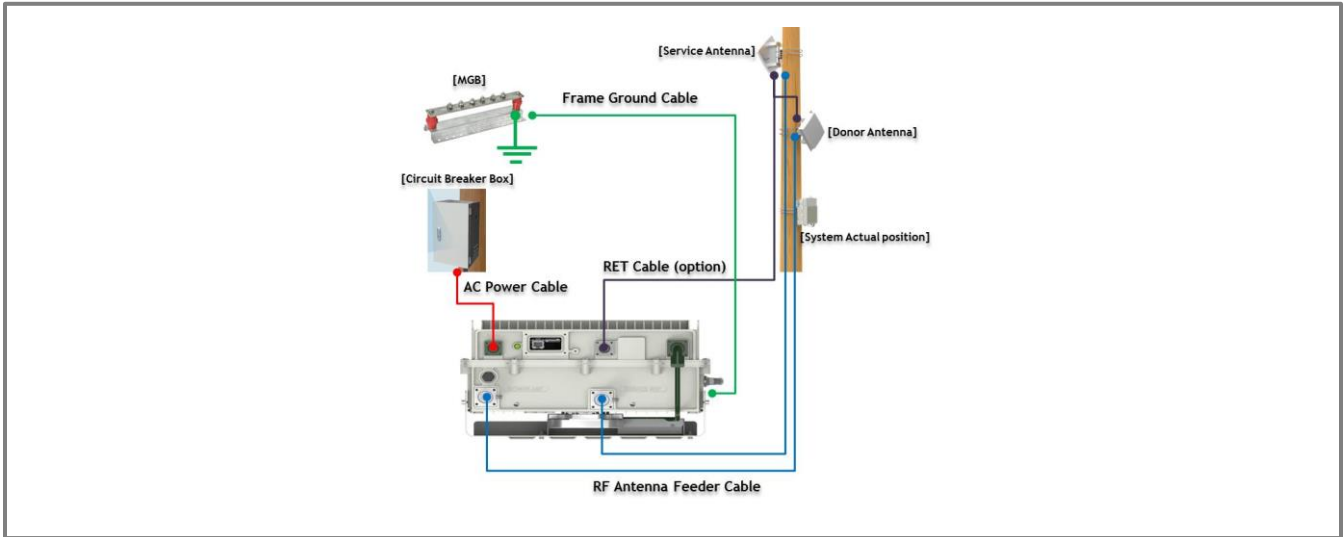

From	To	Cable
GST-IC-ELITE1943	MGB	Frame Ground Cable: AWG 6/ 10ft
	Circuit Breaker Box	AC Power Cable: AWG 16/ 6ft
	RF Antennas	RF Antenna Feeder Cable: 1/2 inch Feeder Line
		RET control Cable (option)

 **No use for the unauthorized device**  
 When installing the system, must check the devices that use is authorized.  
 This conditions apply antenna, cable and coupling device if necessary.

 **Circuit Breaker Installation in the Box for Overcurrent Protection**  
 Must install the circuit breaker between the system and main AC source for separating.  
 Make sure to install the Circuit breaker on the place to operate easily  
 Circuit Breaker is able to operate up to 20A

 **Terminal, Conduit and Cable Size**  
 To install the conduit is according to NAE regulation, and Terminal size is according to NEC regulation

	<u>Version</u> 1.3	<u>Date</u> November 18, 2016	<u>Page</u> 51/ 61
<u>Title</u> USER MANUAL	<u>Prepared by</u>	<u>Reviewed by</u>	<u>Approved by</u>

## 9.4. Service Man Installation Guide

### 9.4.1. Pole Mount Installation

The procedure for fixing the pole type system is as follows

- 1) To mount the system on the pole, first fix the bracket on the wanted position.

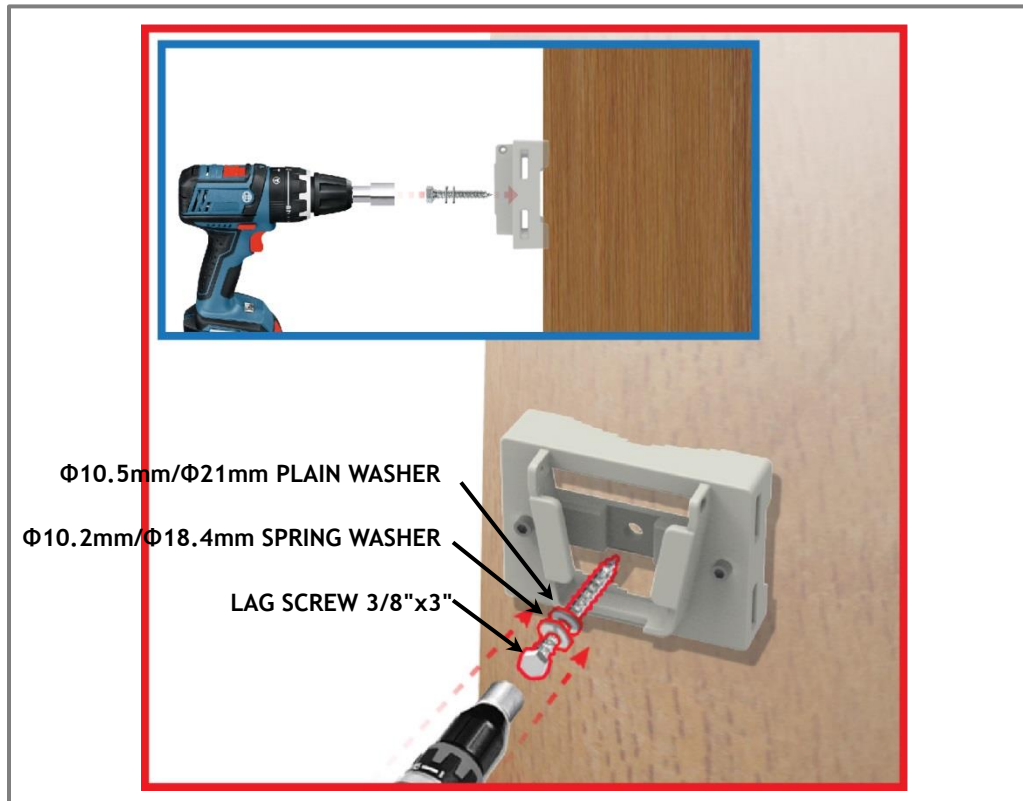

Figure 14. The way to fix the bracket on the pole (Normal type)



#### Protection gloves and goggles

Make sure that worker wears protection gloves and goggles to prevent damages from debris while drilling holes in a Pole or Wall



#### Cautions while drilling on the pole

Drilling thru-hole on a center of the pole

	<u>Version</u> 1.3	<u>Date</u> November 18, 2016	<u>Page</u> 52/ 61
<u>Title</u> USER MANUAL	<u>Prepared by</u>	<u>Reviewed by</u>	<u>Approved by</u>

2) To fix the bracket on the pole, strip the bracket using a steel band



Figure 15. Installing the Steel Band



Fasten the Steel-Band tightly

Buckle the Steel-Band

Figure 16. The way to using a Steel Band



**Cautions System leveling**  
Before fixing the bracket, Check the horizontal and vertical level using a spirit level

	<u>Version</u> 1.3	<u>Date</u> November 18, 2016	<u>Page</u> 53/ 61
<u>Title</u> USER MANUAL	<u>Prepared by</u>	<u>Reviewed by</u>	<u>Approved by</u>

3) Hang the system to the hooking position at the top of the mounting bracket

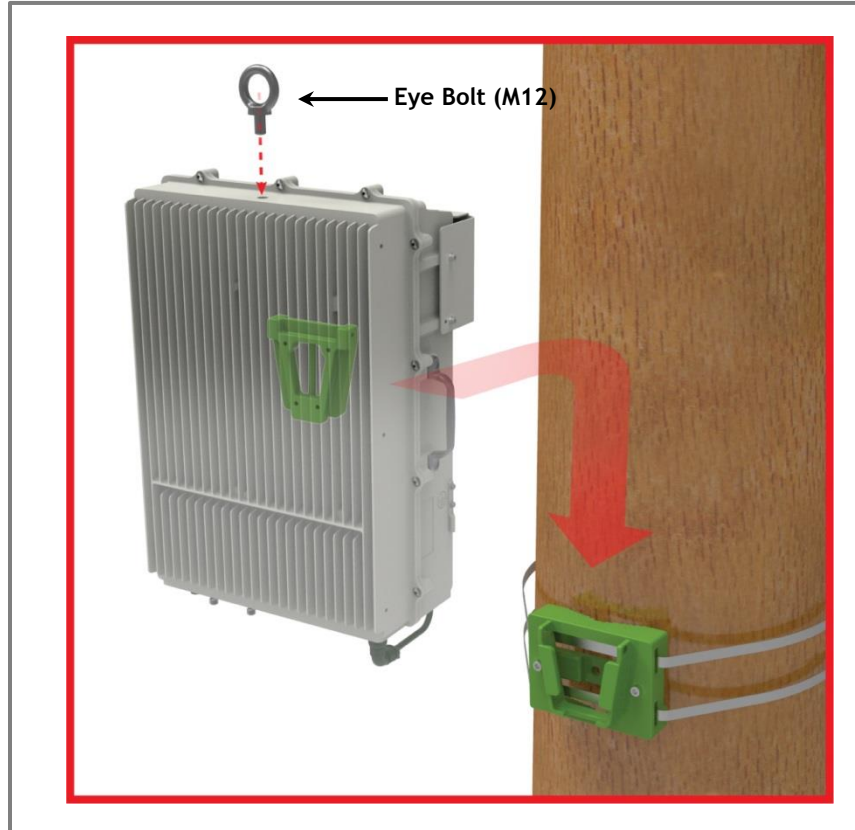

Figure 17. The way to hang the system for Pole Mounting



**Cautions while lifting the system**

Regarding equipment weight and size, decide to the way to lift the system

	<u>Version</u> 1.3	<u>Date</u> November 18, 2016	<u>Page</u> 54/ 61
<u>Title</u> USER MANUAL	<u>Prepared by</u>	<u>Reviewed by</u>	<u>Approved by</u>

4) Align the system with the fixing holes of the mounting bracket and fix them firmly

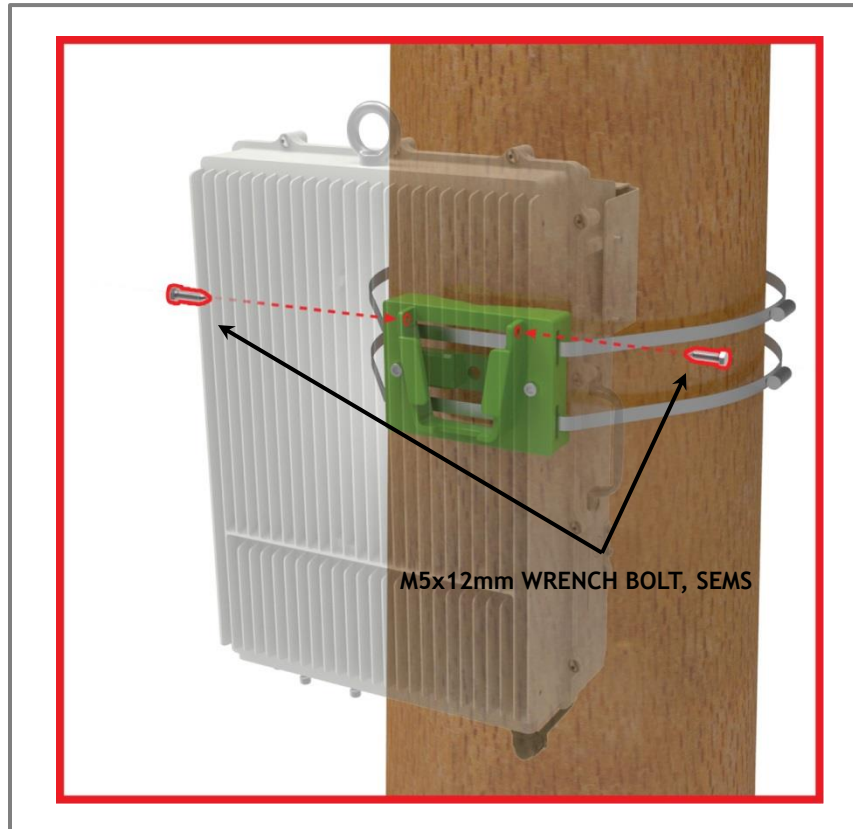

Figure 18. The way to fix firmly the System for Pole Mounting



#### Cautions System leveling

Before fixing the system, Check the horizontal and vertical level using a spirit level

### 9.4.2. Wall Mount Installation

The procedure for fixing the wall type system is as follows:

- 1) Before fixing the bracket on the wall, detach a piece of bracket

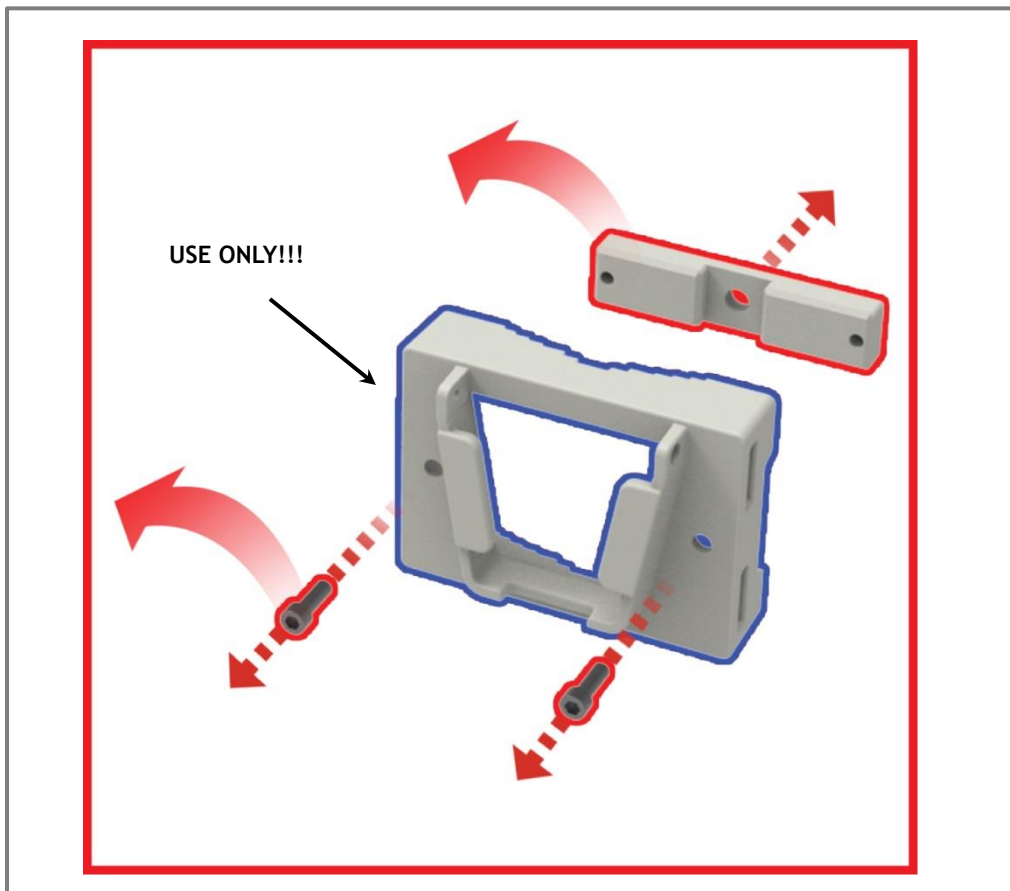

Figure 19. Detach the unused bracket and Bolt

	<u>Version</u> 1.3	<u>Date</u> November 18, 2016	<u>Page</u> 56/ 61
<u>Title</u> USER MANUAL	<u>Prepared by</u>	<u>Reviewed by</u>	<u>Approved by</u>

2) To mount the system on the wall, first fix the bracket on the wanted position

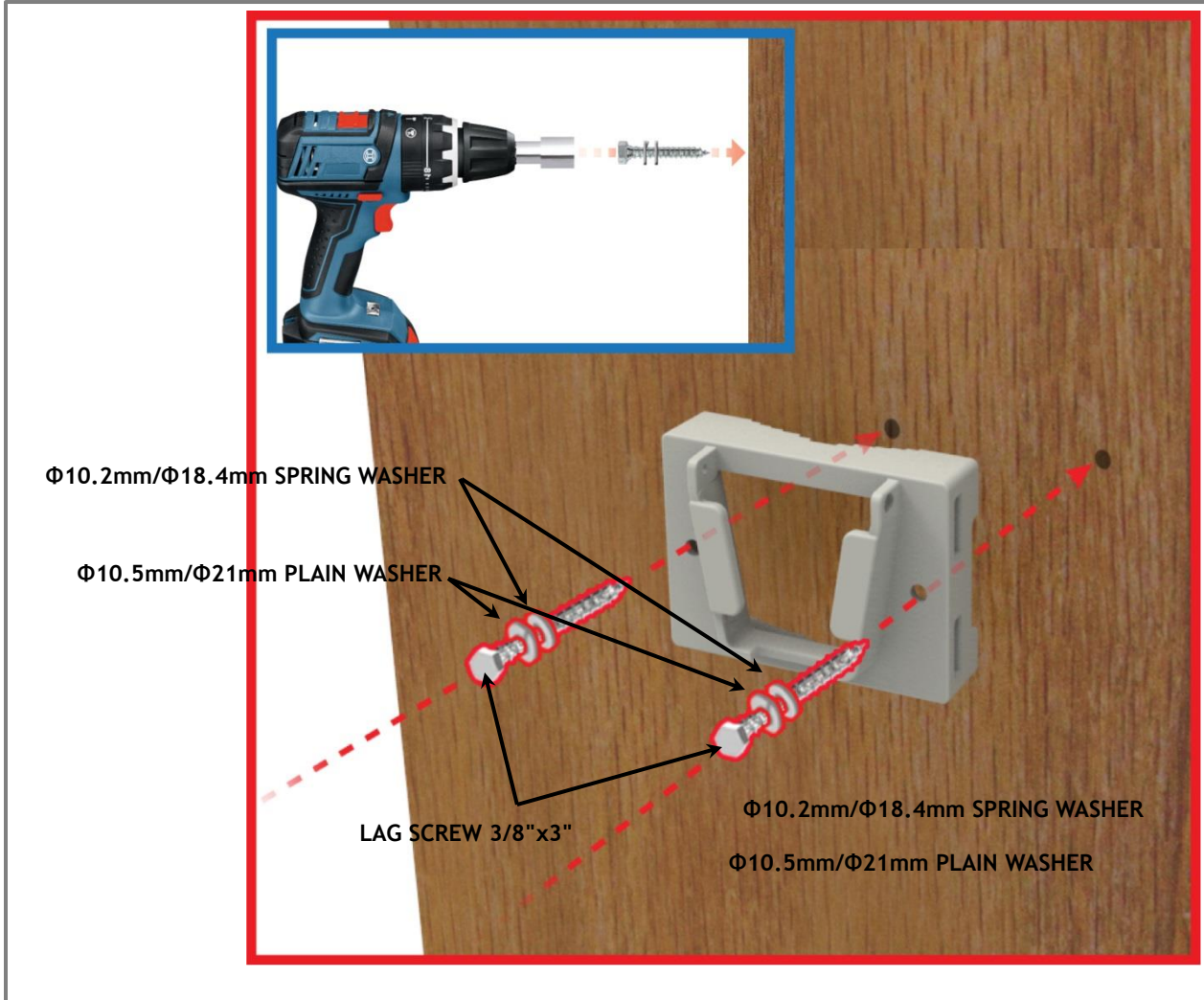

Figure 20. Fixing the Bracket for installing a Wall Mount

 <b>CAUTION</b>	<p><b>Wall Thickness</b></p> <p>Wall thickness to fix the system is 1.5 inch over at least.</p>
--------------------	---



	<u>Version</u> 1.3	<u>Date</u> November 18, 2016	<u>Page</u> 57/ 61
<u>Title</u> USER MANUAL	<u>Prepared by</u>	<u>Reviewed by</u>	<u>Approved by</u>

- 3) Hang the system to the hooking position at the top of the mounting bracket

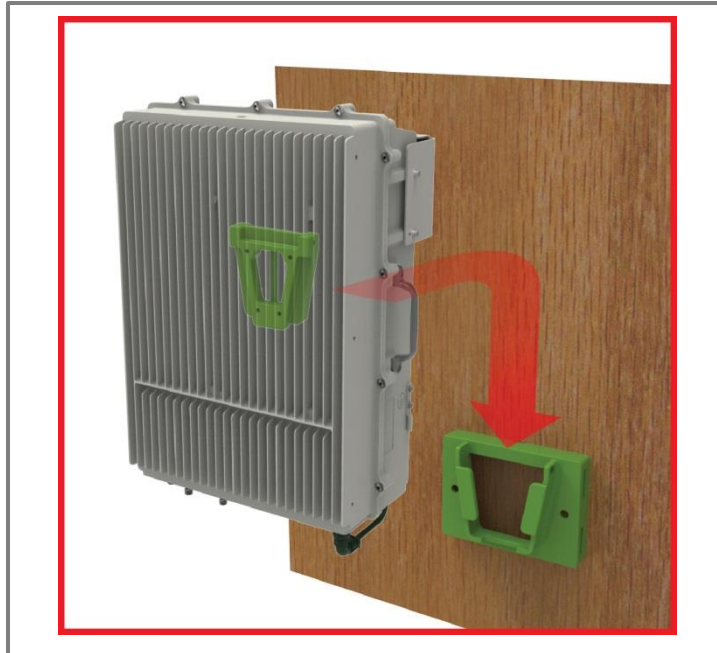

Figure 21. The way to hang the system for Wall Mounting

- 4) Align the system with the fixing holes of the mounting bracket and fix them firmly

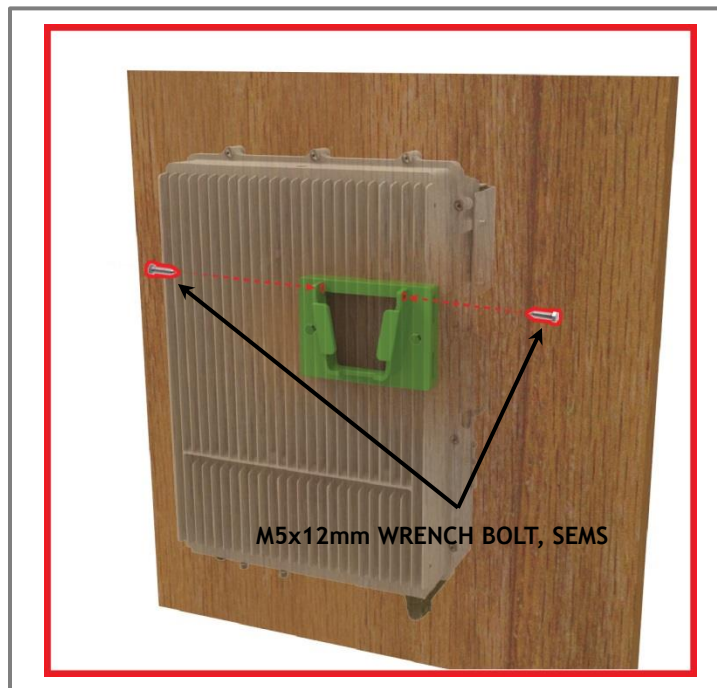

Figure 22. The way to fix firmly the System for Wall Mounting

	<u>Version</u> 1.3	<u>Date</u> November 18, 2016	<u>Page</u> 58/ 61
<u>Title</u> USER MANUAL	<u>Prepared by</u>	<u>Reviewed by</u>	<u>Approved by</u>

### 9.4.3. Recommended Distance for installing system mounting

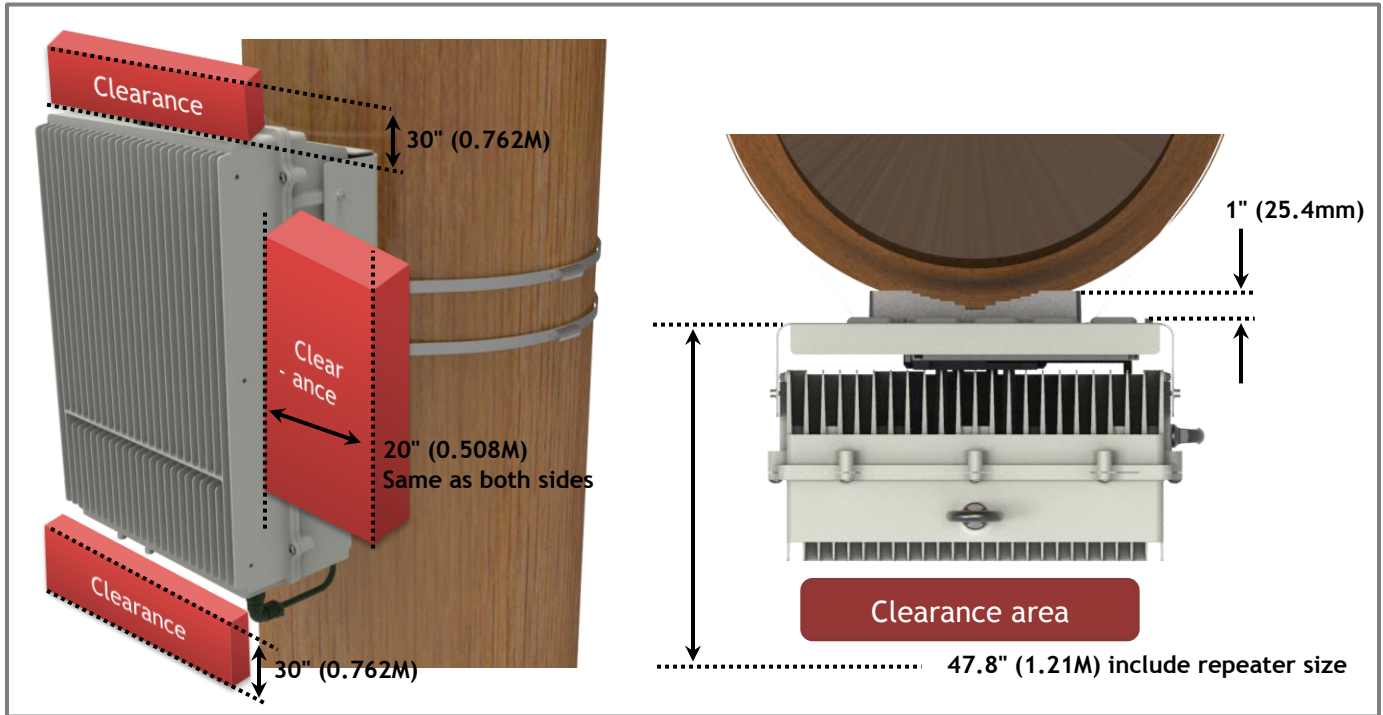



Figure 23. Recommended Distance for installing system mounting

	<u>Version</u> 1.3	<u>Date</u> November 18, 2016	<u>Page</u> 59/ 61
<u>Title</u> USER MANUAL	<u>Prepared by</u>	<u>Reviewed by</u>	<u>Approved by</u>

## 9.5. Cable Connection

### 9.5.1. AC Power cable connection

- Repeater supports a free AC Input voltage from 110V to 240V
- Provided Power cable is single type, so it can be used flexibly
- The pin description of AC Port is below. User should connect exact polarity of AC

Port Outlook (System Side)	Port numbering for MS	NAME	Description
 MS-3102A-10SL-3P	A	AC_H	AC Hot
	B	AC_N	AC Neutral
	C	F.G	Frame Ground

- The specification & Connection of AC Power Cable

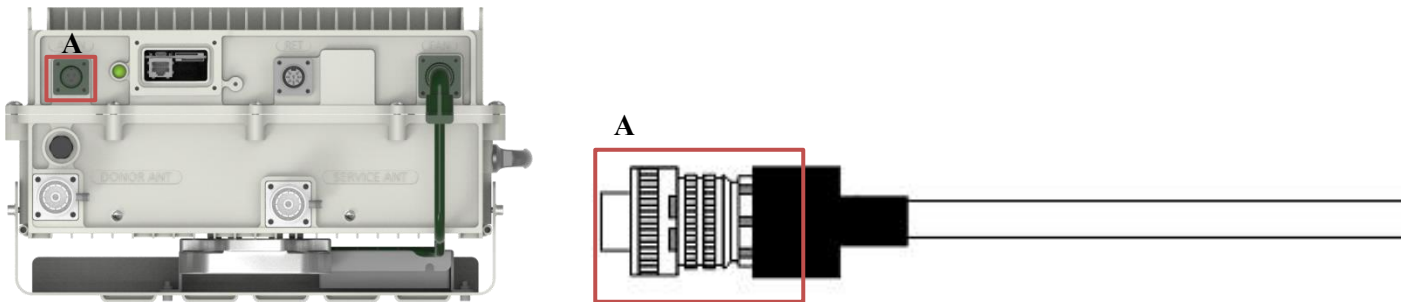

- A: MS3106A-10SL-3S
- Connect Port A for inserting AC Power

	<u>Version</u> 1.3	<u>Date</u> November 18, 2016	<u>Page</u> 60/ 61
<u>Title</u> USER MANUAL	<u>Prepared by</u>	<u>Reviewed by</u>	<u>Approved by</u>

### 9.5.2. FAN Power Cable Connection

Port Outlook (System Side)	Port numbering for MS	NAME	Description
 MS3102A14S-2P	A	Red	+24 VDC
	B	Black	Frame Ground
	C	Yellow	FAN Alarm #1
	D	Brown	Reserved

### 9.5.3. RET Cable Connection

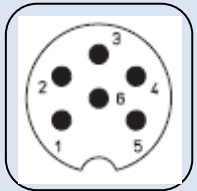
Port Outlook (System Side)	Port numbering for MS	NAME	Description
 SU20SPR-8S	3	RS485B	Communication
	4	DGND	Frame Ground
	5	RS485A	Communication
	6	+29 V	1.5A max
	7	DC Return	Retune DC Power
	1, 2, 8	NC	-

### 9.5.4. Local Maintenance Connection

- Repeater Support a RJ-45 connector

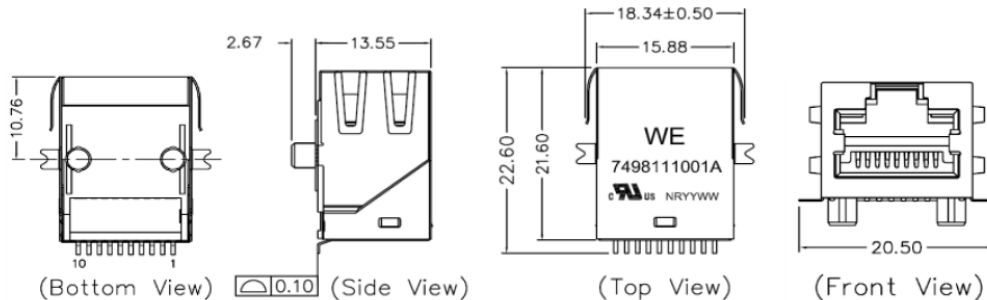

	<u>Version</u> 1.3	<u>Date</u> November 18, 2016	<u>Page</u> 61 / 61
<u>Title</u> USER MANUAL	<u>Prepared by</u>	<u>Reviewed by</u>	<u>Approved by</u>

### 9.5.5. Grounding cable Connection

- Frame(Earth) Wire size is AWG #6. The way to install the grounding cable is below

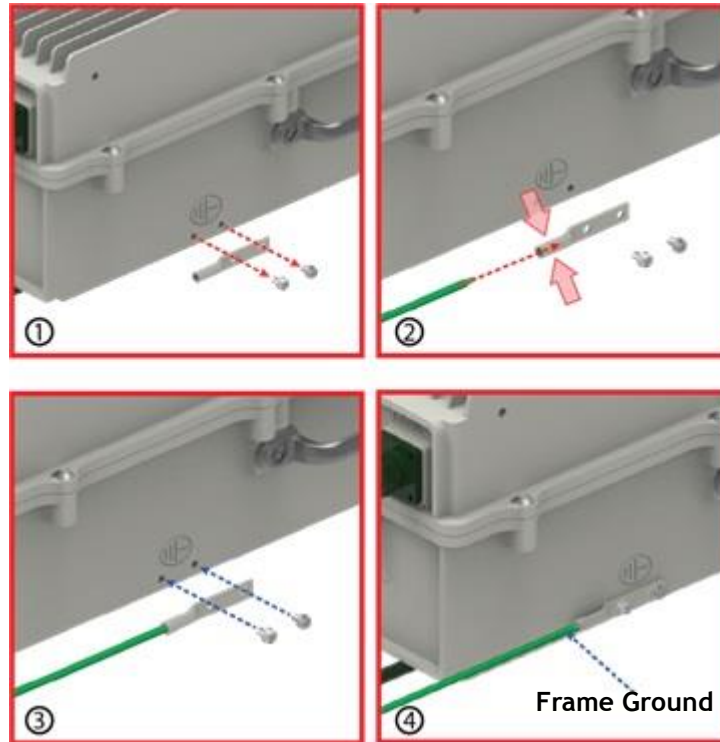

- The specification of ground terminal lug is like below (Refer to JOCT 0202-RL05)

#### TUBULAR CABLE LUGS, TWO-HOLE, STANDARD BARREL AND LONG BARREL TYPE-CT

- Material : Electrolytic Copper (TPC)
- Surface : Tin Plated
- With Inspection Hole
- Color Coded to Show Proper Die Number and Color 10mm~630mm
- To IEC 60228 Class 2 and Class 5
- UL Listed 486A-486B up to 35KV

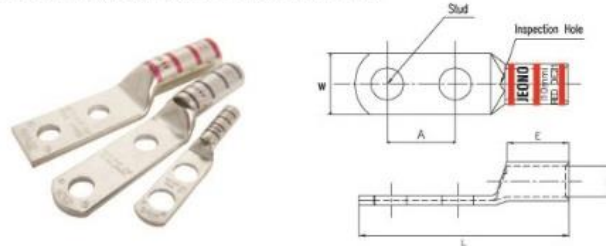

Part No Explanation : JOCO 0201-X X 04 → Stud Size(mm, UNC)

Tongue Form R : Round Type S : Square Type      Barrel Form \*S : Standard Barrel Type \*L : Long Barrel Type



Part Number	Wire Range				Stud Size	Dimension (mm)						Color Code & Die No	Q'ty / bag	
	CODE		FLEX			W	d	A	E		L			
	AWG	mm <sup>2</sup>	AWG	mm <sup>2</sup>					*S	*L	*S			*L
JOCT 0202-XX05	6	16	6	16	M5	12	16	15	30	52	67	Blue 24 JOCD-6	300	
JOCT 0202-XX06					M6					67	82			
JOCT 0202-XX08					M8	82	97							
JOCT 0202-XX10					M10	97	112							
JOCT 0202-XX12					M12	112	127							