



TECHNICAL SERVICE MANUAL



PLATINUM TECHNICAL SERVICE MANUAL (Rev 00 Aug.06): CONTENTS

- 1. Introduction (rev.00)**
 - 1.1 Documentation required
 - 1.2 Tools and equipment required
 - 1.3 Safety warnings
 - 1.4 Platinum range
- 2. Technical data (rev.00)**
 - 2.1 Product technical data
 - 2.2 Internal / external machine components
- 3. Summarised instructions (rev.00)**
 - 3.1 Client and programming menu (rev.00)
 - 3.2 Maintenance and cleaning (rev.00)
- 4. Diagrams (rev.00)**
 - 4.1 Wiring diagram (rev.00)
 - 4.2 Water circuit diagram (rev.00)
- 5. Troubleshooting (rev.00)**
 - 5.1 Test functions (rev.00)
 - 5.2 Diagnostics function (rev.00)
 - 5.3 Error messages for Service personnel (rev.00)
 - 5.4 Problems, Causes, Remedies (rev.00)
- 6. Operating logic (rev.00)**
 - 6.1 Resetting coffee grounds drawer (rev.00)
 - 6.2 Water reserve (rev.00)
 - 6.3 Motorized tank (rev.00)
 - 6.4 Prima water (rev.00)
 - 6.5 SBS valve (rev.00)
 - 6.6 Solenoid pilot (rev.00)
- 7. Component assembly / disassembly (rev.00)**
 - 7.1 Top cover (rev.00)
 - 7.2 Right and left-side cover (rev.00)
 - 7.3 Electronics (rev.00)
 - 7.4 Gearmotor (rev.00)
 - 7.5 Pump (rev.00)
 - 7.6 Heater and solenoid pilot unit (rev.00)
 - 7.7 Oetiker clamp assembly and disassembly (rev.00)
 - 7.8 Coffee grinder (rev.00)
 - 7.9 Grinder adjustment/assembly and disassembly (rev.00)
 - 7.10 Grinder adjustment during servicing (rev.00)
 - 7.11 Motorized drip tray (rev.00)
- 8. Service schedule (rev.00)**
 - 8.1 Routine maintenance Check list (rev.00)
- 9. Exploded drawing (rev.00)**

SECTION 1
INTRODUCTION

REV.00

1.1 Documentation required

The following technical documentation is required for repairs:

Instruction booklet for specific model.

Technical documentation for specific model (diagrams, exploded drawings).

1.2 Tools and equipment required

As well as the standard equipment, the tools listed below are required.

1 special screwdriver with Torx T10 tip.

1 digital thermometer with full 200°C scale.

This must be suitable for measuring in liquids and on surfaces.

1 set of pliers for Oetiker clamps.

1 pincer.

1 CC -A - Vdc tester.

1.3 Safety warnings

Before starting operations on the machine, consult the relative instruction booklet. Observe all current standards related to the repair of domestic appliances.

Always disconnect the power plug from the mains before carrying out repairs. Simply turning off the main switch is not sufficient to prevent electrical discharge.

This domestic appliance is rated with insulation class I.

On completion of repairs, the insulation and dielectric rigidity tests must be performed.

1.4 Platinum range

VISION



- Touch Screen
- S B S
- Cup warmer
- Motorized tank
- Milk adapter
- Rapid Steam
- Pre-ground option

SWING UP



- 24x2 display
- Ring selector
- S B S
- Cup warmer
- Motorized tank
- Milk adapter
- Rapid Steam
- Pre-ground option

SWING



- 10x2 display
- Ring selector
- S B S
- Milk adapter
- Rapid Steam
- Pre-ground option

VOGUE



- Height adjustment ringnut
- S B S
- Milk adapter
- Rapid Steam

EVENT



- **S B S**
- Rapid Steam

SECTION 2
TECHNICAL DATA

REV.00

2.1 Product technical data

Power supply and output:	230 V~, 50/60 Hz, 1300 W.
Temperature control:	1 (NTC) variable resistor sensor – transmits the value to the electronic board.
Safety system:	2 x 175°C manual reset thermostats.
Coffee heat exchanger output: Stainless steel	1300 W – to dispense coffee, hot water and steam.
Motorized tank only on Platinum Vision e Swing Up	24V stepper motor.
Water level and drip tray sensor:	Capacitive sensor
Gearmotor:	33VC with 2 directions of rotation.
Cup warmer plate: Solo Platinum Vision e Swing Up	Activated via MENU display. PTC Type.
Pump:	Ulka reciprocating piston type with thermal cutout at 100°C, 48 W, 230V, 50 Hz, Type EX5 approx. 13-15 bars.
Pressure relief valve:	Opening at approx. 18-20 bars.
Water filter:	In tank.
Coffee grinder:	DC motor with ceramic plate grinders.
Solenoid pilot:	15 VA.
Coffee dose control:	Hall sensor – Pulse control. Dose adjustment can be set from approx. 7 to 10.5 g.
Amps:	During heating phase- approx. 5.6 A.
Dimensions: l x h x d in mm:	310/390/440
Weight:	10 kg (average).
Water tank capacity:	1.7 l.
Coffee container capacity:	250g coffee granules.
Coffee grounds drawer capacity:	14
Heatex changer capacity:	Approx. 10 cc.
Water circuit filling time:	Approx. 15 sec on first filling cycle.
Heating time:	Approx. 45 sec.
Dispensed drink temperature:	Approx. 73°C - 83°C
Grinding time:	Approx. 8-10 sec.

Internal components

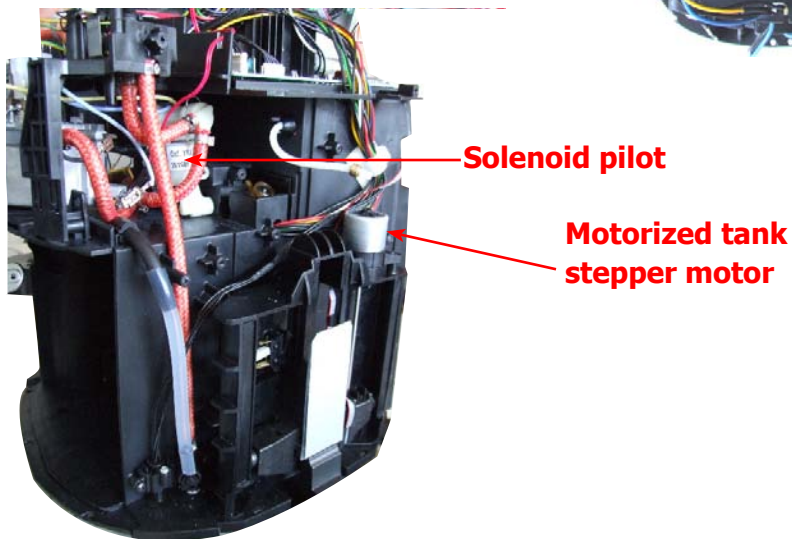
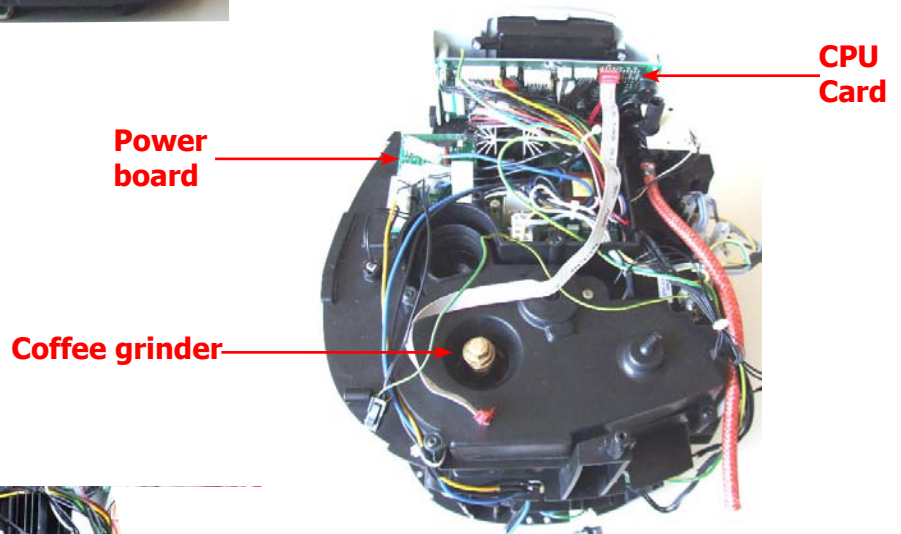
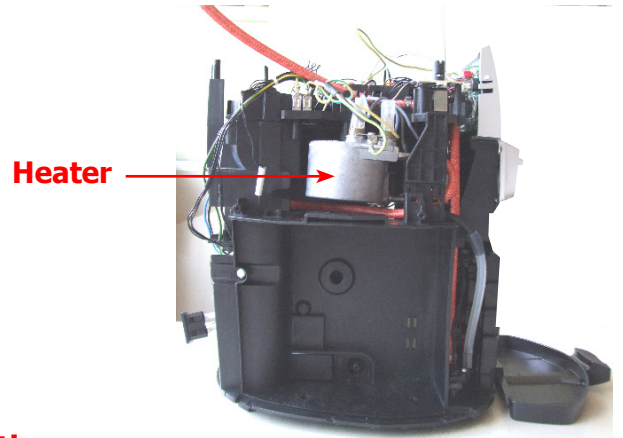
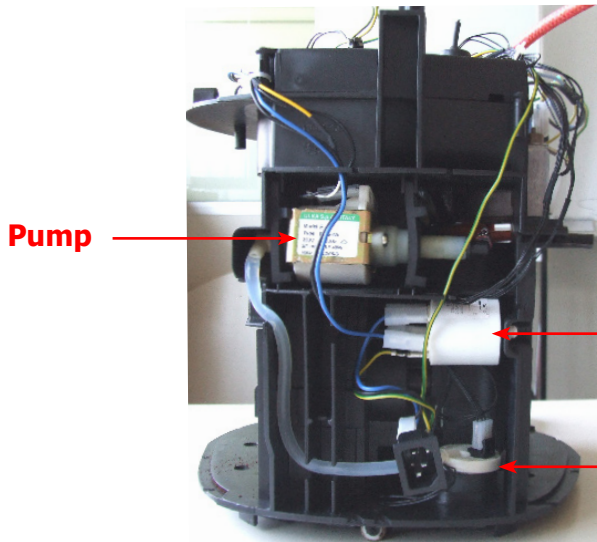

SECTION 3
BRIEF
INSTRUCTIONS

REV.00

3.1 Client and programming menu

Platinum Vision

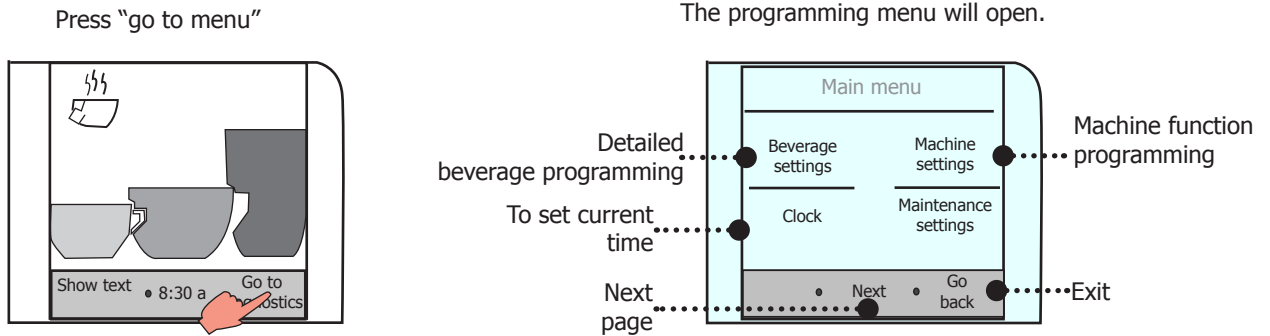

- After setting each of the following menus, press:
- "Go back" to be returned to the previous screen and save any new settings.
 - "Previous settings" to reset previous values.
 - "Go back to menu" to be returned to the main menu and save new settings.

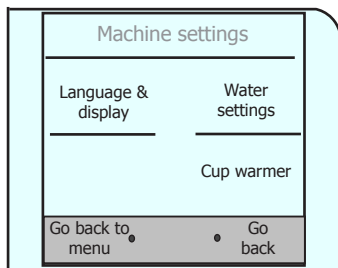

Machine settings menu.

- Language & display = to set menu language and display contrast.
- Water settings = to set some water functions.
- Cup warmer = to set cut warmer functions.

Beverage settings menu

To set general parameters for the dispense of beverages containing coffee, press the "beverage settings" key in the main menu.

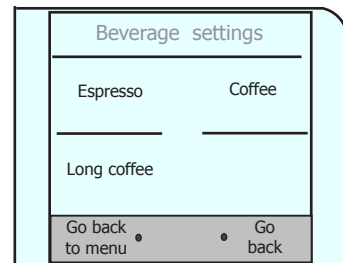

The following can be set for each beverage selected:

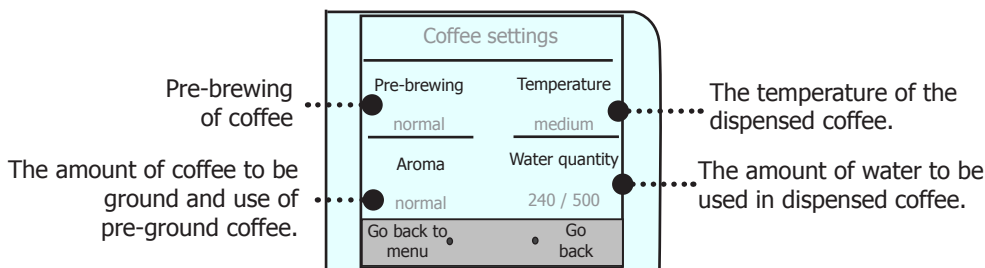

Clock menu

To set the current time and timer (for standby), press the "clock settings" key on the main menu.

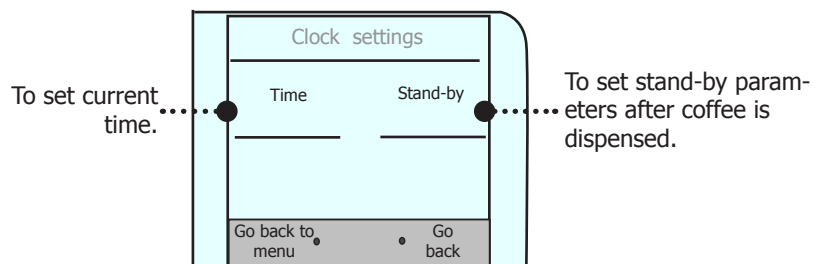

Platinum Swing Up

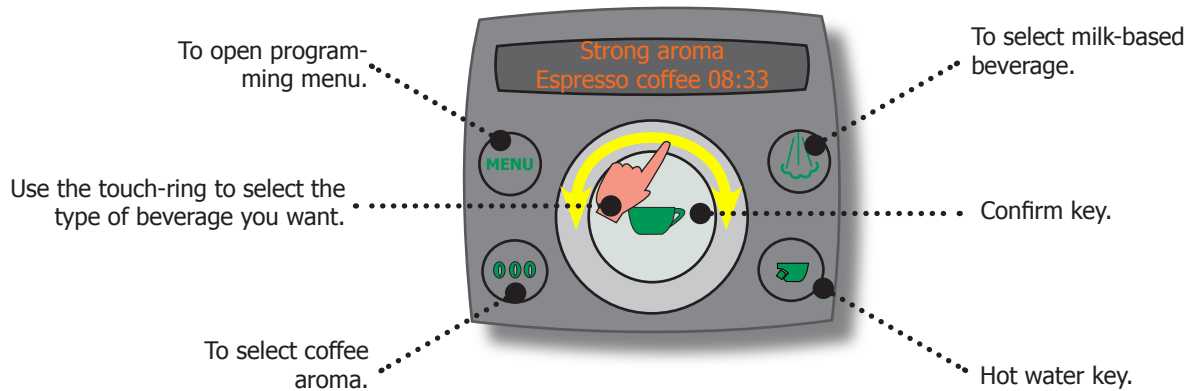

Beverage settings

To set beverage preparation parameters: press the MENU key and use the touch-ring to select "beverage settings".

At this point, you can:

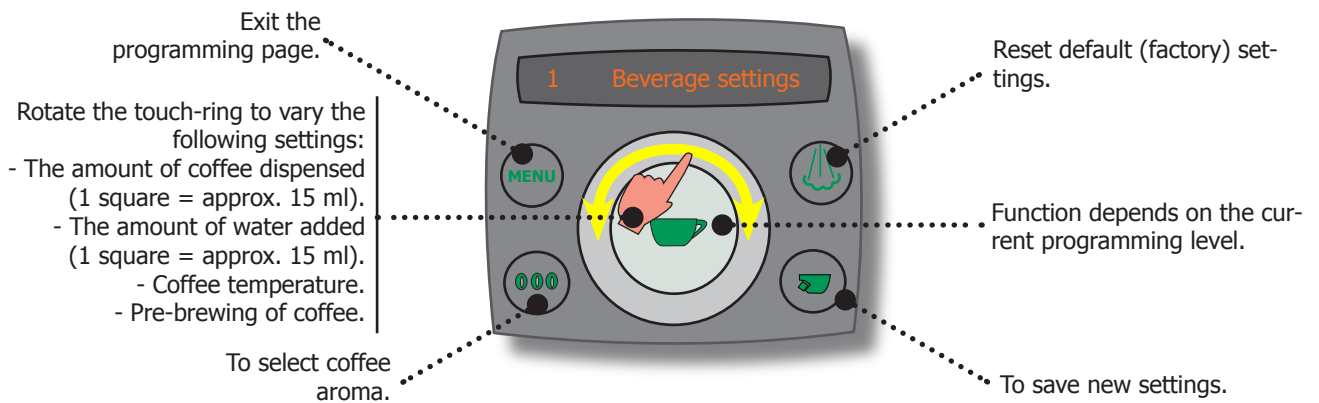

Machine settings

To set general machine settings, press the MENU key, select "machine settings" then use the touch-ring to select:

2.1 Language
Italian

To set menu language.

2.2 Cup warmer
Disabled

To set cup warmer function.

2.3 Beeps
Enabled

To enable beep warnings.

2.4 Filter alarm.
Enabled

To set machine function with "Aqua Prima" filter.

2.5 Rinse
Enabled

To set circuit rinsing.

2.6 Water hardness
1

To set water hardness.

2.7 Clock

To set internal clock.

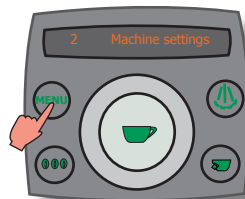

To exit at any time from "Machine settings" without saving any changes made, press the MENU key.

3.2 Maintenance and cleaning

STEPS		
A	Empty coffee grounds drawer.	As instructed.
B	Empty drip tray.	As necessary.
C	Clean water tank.	Once a week.
D	Clean the coffee granule container.	As necessary.
E	Clean casing.	As necessary
F	Clean and grease the brew group.	Monthly or every 500 coffees.
H	Descaling.	As instructed.
J	Clean drip tray.	Weekly.
K	Clean coffee circuit.	Weekly.

Descaling.		
Hardness	Water hardness	Descaling frequency *
1	Soft water (up to 7 ^o dH)	Approx. every 3 months/120 litres
2	Medium water (7 ^o -14 ^o dH)	Approx. every 2 months / 90 litres
3	Hard water (15 ^o -21 ^o dH)	Approx. every 6 weeks / 60 litres
4	Very hard water (over 21 ^o dH)	Approx. every 4 weeks / 30 litres

* Without Prima water filter

SECTION 4

DIAGRAMS

REV.00

4.1 Wiring diagram

Platinum Vision

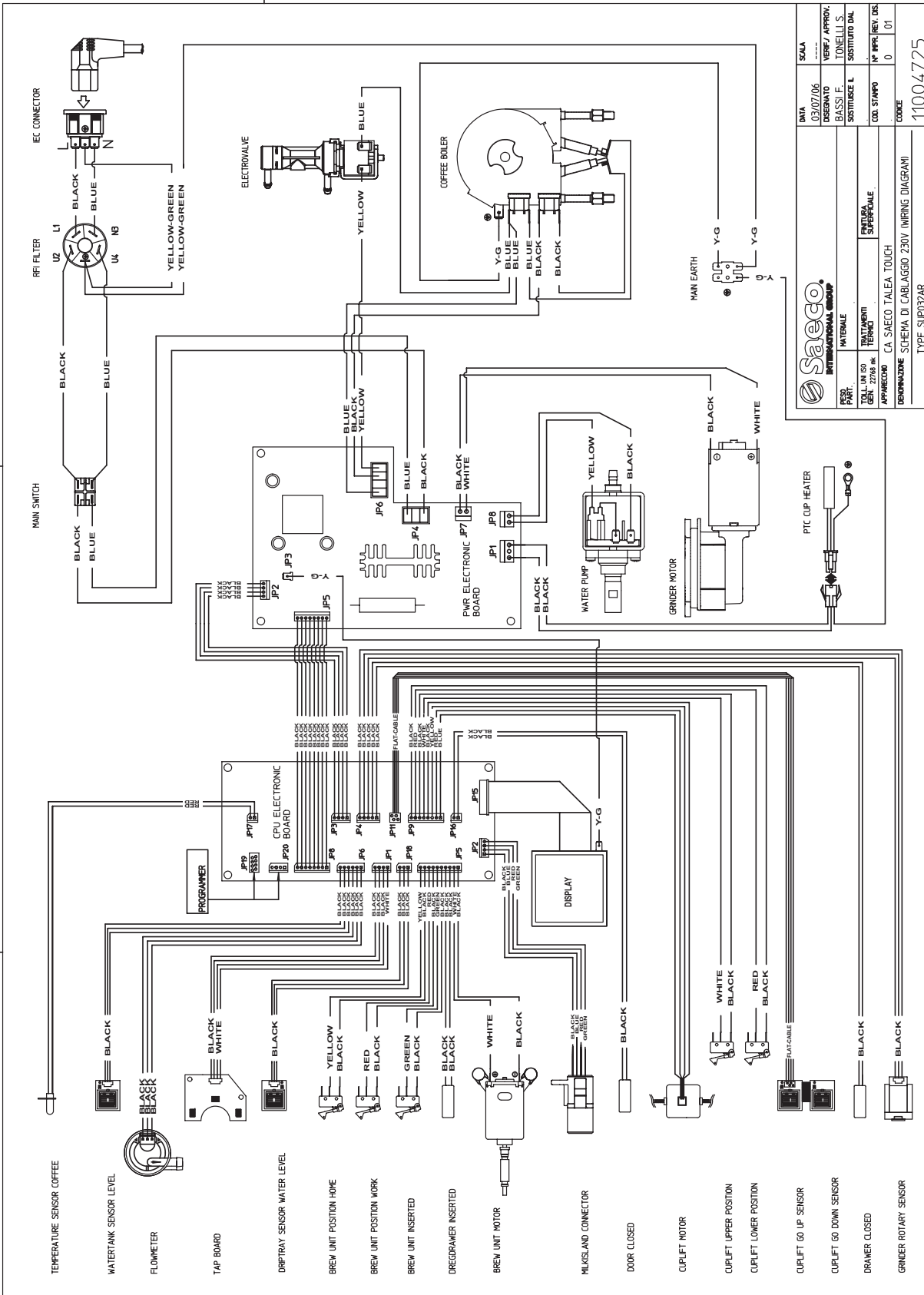

DATA	03/07/06	SCALE	
DESIGNER	BASSI P.	VERIF. / APPROV.	TONELLI S.
REVISIONI	28/08/06 L.	REVISIONI	0
APPROVATO	CA SAECCO TALEA TOUCH	REVISIONI	0
MODELLO	GEN. 2768 4K	REVISIONI	0
APPLICAZIONE	CA SAECCO TALEA TOUCH	REVISIONI	0
DESCRIZIONE	SCHEMA DI CABLAGGIO 230V (WIRING DIAGRAM)	REVISIONI	0
TIPO	TYPE SUPRO32AR	REVISIONI	0
NUMERO	11004725	REVISIONI	0

LA PROPRIETA' DI QUESTO DESENIO E' RISERVATA A TERMI DI LEGGE. VEIATO QUINDI RIPRODURLO E RENDERSLO NOTO A TERZI.

Platinum Swing UP

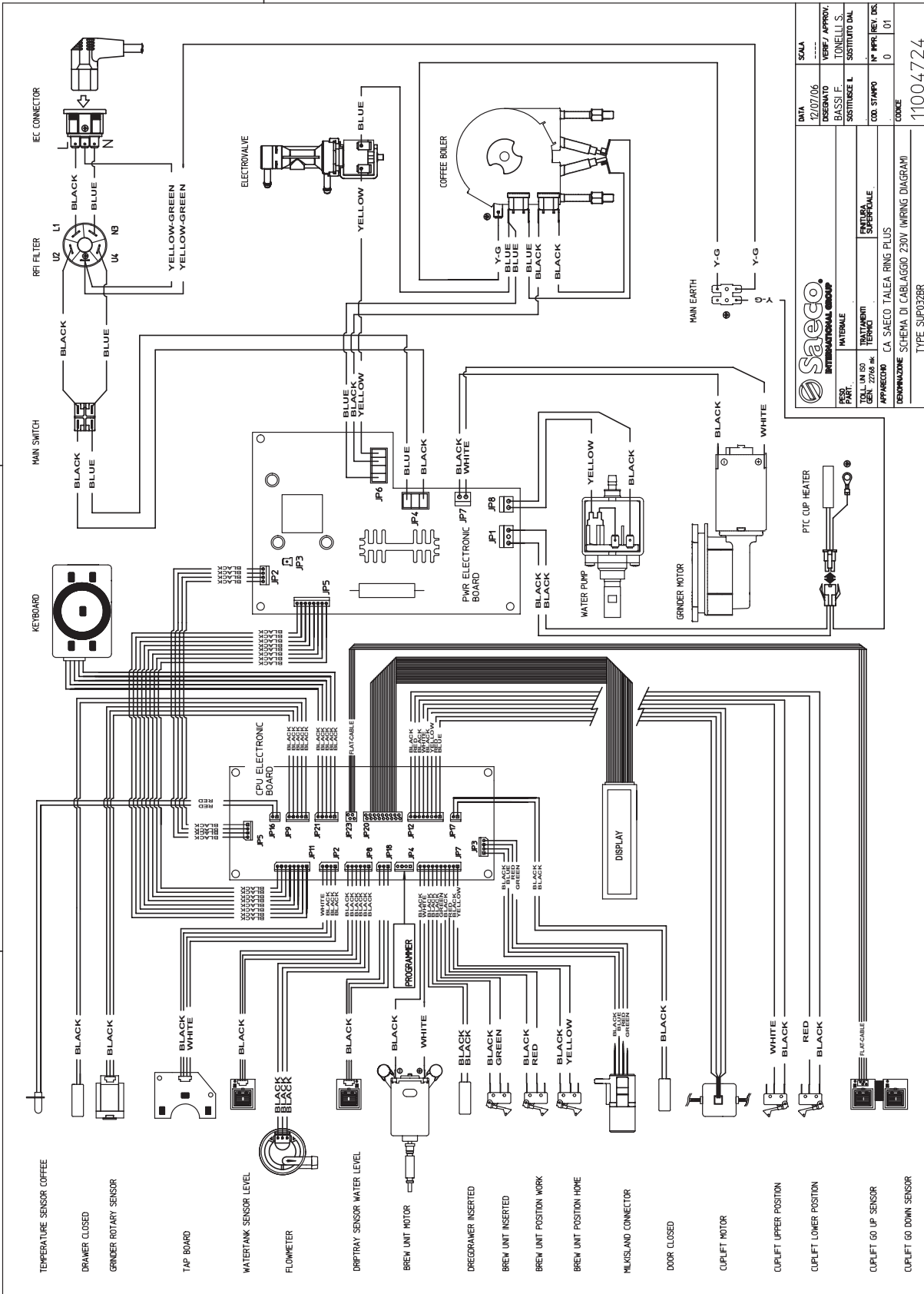

Saeco INTERNATIONAL GROUP		DATA	SCALA
MODELLO	12/07/06	VERB./ APPROV.	
PRODOTTORE	SAECO	DESIGNER	TONELLI S.
APPARTECCHIO	CA SAEKO TALEA RING PLUS	SOSTITUIRE L.	
VERSIONE	14	REVISIONE	01
NUMERO	11004724	DATA	01

LA PROPRIETA' DI QUESTO DESENIO E' RISERVATA A TERMI DI LEGGE. METATO QUINDI RIPRODURLO E RENDERSI NOTO A TERZO.

Platinum Swing

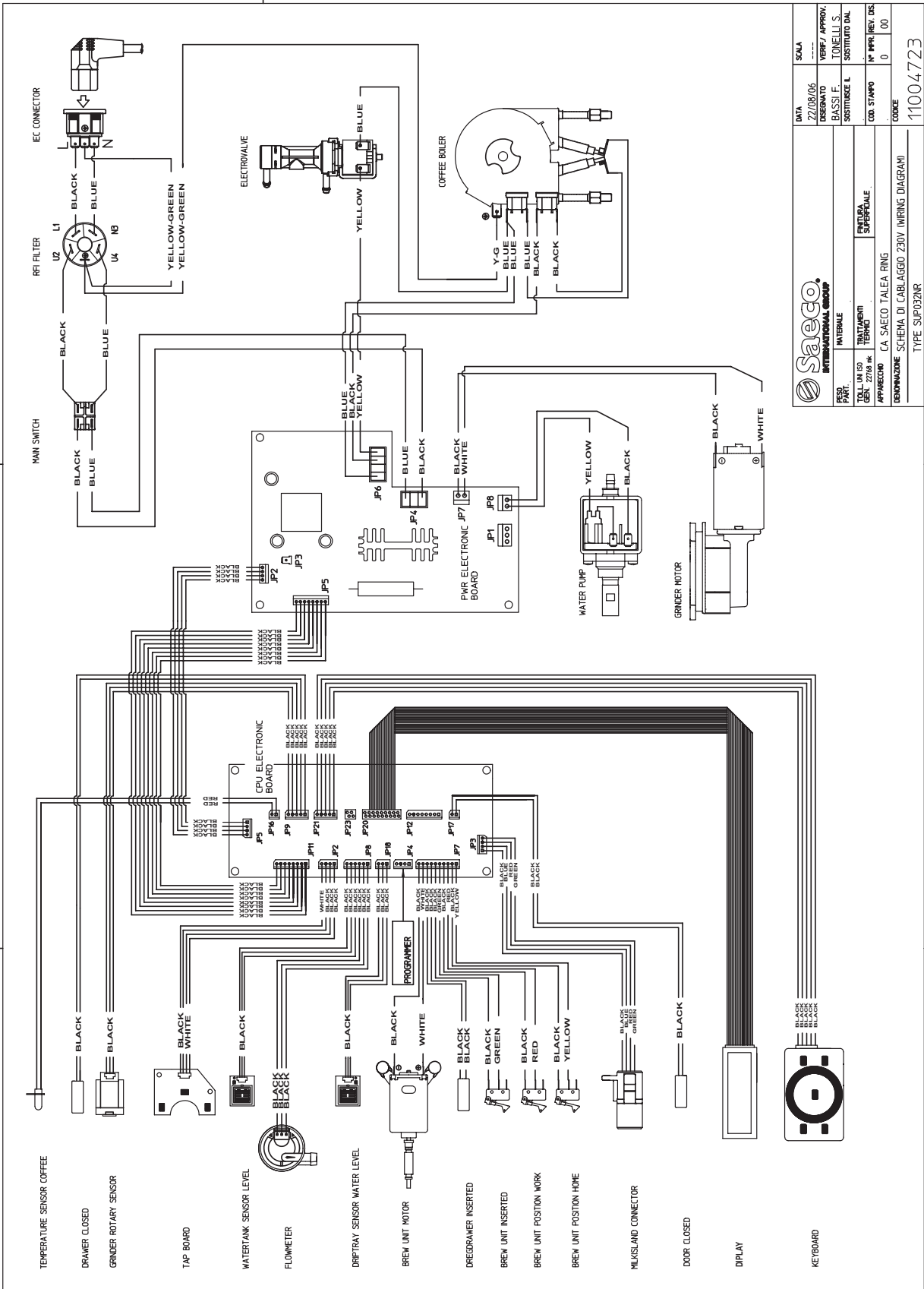

Saeco INTERNATIONAL GROUP		DATA	SCALA
DESIGNATO	VERIF. APPROV.	22/08/06	
BASSI F.	TONELLI S.		
SOSTITUISCE L.			
TOLL. IN ISO		TRATTAMENTI	FRUTTATA
GEN. 27768 int.	TERRI	CA SAEKO TALEA RING	SUPERFICIALE
APPARECCHIO		CA SAEKO TALEA RING	
DENOMINAZIONE		SCHEMA DI CABLAGGIO 230V (WIRING DIAGRAM)	
TYPE		SUP032NR	
CODICE		11004723	

LA PROPRIETÀ DI QUESTO DISEGNO È RISERVATA A TERMI DI LEGGE. METATO QUINDI RIPRODURLO E RENDERSI NOTO A TERZI

4.2 Platinum water circuit

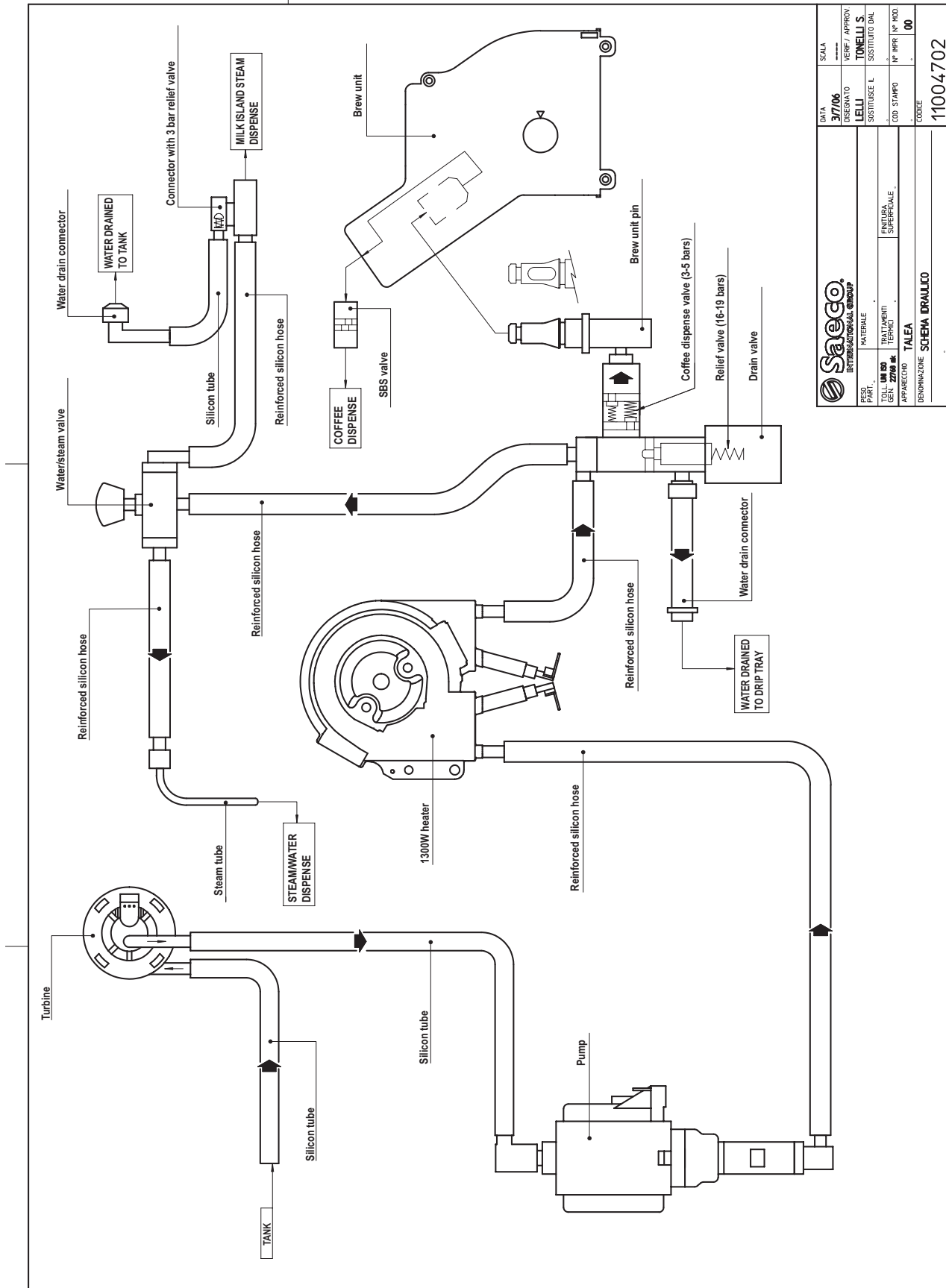

5.1 Test functions

Platinum Vision

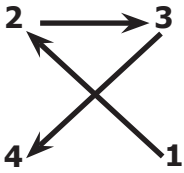

In the first three seconds after the appliance is switched on, you can enter test mode by pressing the keys in the sequence shown on the left.

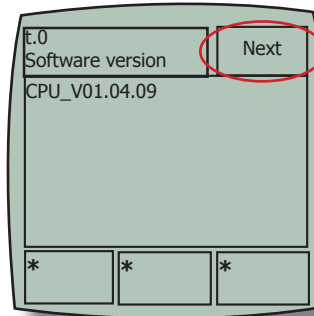

On entering test mode, the screen shown in the screenshot opens. Press the next key to move on to subsequent levels.

Level T1 – brew group

At this level, brew group gearmotor and associated microswitches function is tested.

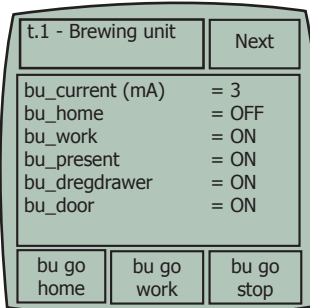

- **bu_current (mA)** - indicates current absorbed by gearmotor.
- **bu_home** - indicates state of brew group home position microswitch.
- **bu_work** - indicates state of brew group work position microswitch.
- **bu_present** - indicates state of brew group presence microswitch.
- **bu_dregdraver** - indicates state of coffee grounds drawer presence microswitch.
- **bu_door** - indicates state of side door closed microswitch.
- By pressing "bu go home" once, the gearmotor moves the brew group to the home position.
- By pressing "bu go work" once, the gearmotor moves the brew group to the work position.
- By pressing "bu stop" once, the gearmotor stops the brew group.

Level T2 – heating unit

At this level, you can check heater function and the associated ntc sensor.

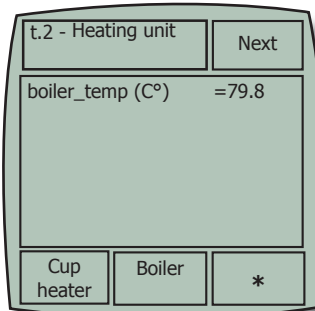

- **boiler_temp (C°)** - indicates the temperature of the water heater.
- Pressing "cup heater" once will turn the cup warmer on.
- Pressing "boiler" once will turn the heater on.

Level T3 – hydraulic circuit

At this level, you can test pump, solenoid valve, drip tray/water tank level, milk island and water/steam valve status sensor function.

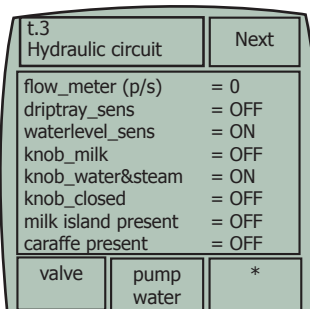

- **flow_meters (p/s)** - indicates revolutions per second of the hall sensor in the turbine.
- **driptray_sens** - indicates the state of the capacitive sensor reading the water level in the drip tray.
- **waterlevel_sens** - indicates the state of the capacitive sensor reading the water level in the water tank.
- **knob_milk** - indicates the state of the water/steam/milk-island knob in the milk position.
- **knob_water&steam** - indicates the state of the water/steam/milk-island knob in the water/steam position.
- **knob_closed** - indicates the state of the water/steam/milk-island knob in the closed position.

- **Milk island present** indicates the state of the milk island present microswitch.
- **Caraffe present** indicates the state of the milk carafe present microswitch.
- Pressing “valve” once will excite the solenoid valve.
- Pressing “water pump” once will start the pump.
- Pressing “valve” once will activate the solenoid valve.

Level T4 – Grinder unit

At this level, you can test coffee grinder function.

t.4 - Grinder unit	Next
pulses_counter = 0	
delay_time (msec) = 0	
bean_door = ON	
bean_alarm = OFF	
grinder *	bean test

- **pulse_counter** - indicates the number of grinding pulses the grinder performs.
- **delay_time (msec)** - indicates revolutions per second of the hall sensor in the coffee grinder.
- **bean_door** - indicates the state of the coffee bean container lid magnetic sensor.
- **bean_alarm** - indicates the no coffee beans left alarm during last grinding.
- Holding and pressing “grinder” starts the coffee grinder for at least 200 grinding pulses.
- Pressing “bean test” once starts the coffee grinder to check the no coffee bean alarm.

Level T5 – Cup lift

At this level, you can check cup-lift function.

t.5 - Cup lift	Next
upper_switch = OFF	
lower_switch = OFF	
key_up = OFF	
key_down = OFF	
cup_lift up	cup_lift down *

- **upper_switch** - indicates the state of the moving tray up position microswitch in the up position of the moving tray.
- **lower_switch** - indicates the state of the moving tray lower position microswitch in the lower position of the moving tray.
- **key_up** - indicates the state of the capacitive sensor that raises the moving tray.
- **key_down** - indicates the state of the capacitive sensor that lowers the moving tray.
- Holding and pressing “cup_lift” moves the cup lift up to the uppermost position.
- Holding and pressing “cup_down” moves the cup lift up to the lowermost position.

Level T6 – Grinder dose

At this level, you can test and modify the amount of coffee that is ground.

t.6 - Grinder dose	Next	
Mild dose = 63		
Medium dose = 70		
Strong dose = 77		
Mild	Medium	Strong
Value up	Value down	Value test

- **Mild dose** - indicates the number of grinding pulses to set for a mild coffee.
- **Medium dose** - indicates the number of grinding pulses to set for a medium-strength coffee.
- **Strong dose** - indicates the number of grinding pulses to set for a strong coffee.
- Pressing “value up” increases the number of grinding pulses for a medium-strength coffee in steps of 5.
- Pressing “value down” reduces the number of grinding pulses for a medium-strength coffee in steps of 5.
- “Mild” and “strong” values are equal to 10% less and 10% more respectively than the average value set.
- Pressing “value test” starts grinding at the selected strength (mild, medium or strong).

Level T7 – Coffee grounds drawer

At this level, you can modify the current value of the number of coffee grounds (maximum of 13).

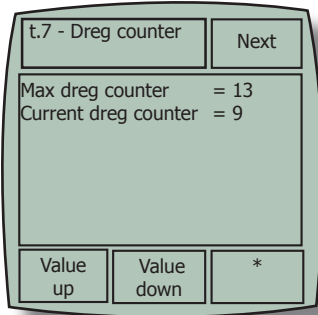

- **max dreg counter** - indicates the maximum number of coffee grounds that the drip tray can contain.
- **current dreg counter** - indicates the current number of coffee grounds

Level T8 – Steam out

At this level, you can drain the water circuit..

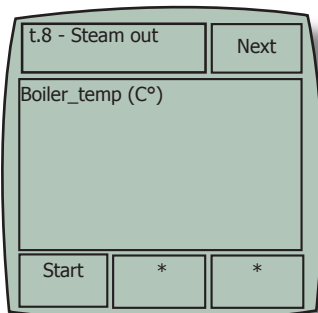

- **boiler_temp (C°)** - indicates the temperature of the water heater. Pressing start will run the procedure. If the knob state is not in the water/steam/milk-island position, the message shows below will appear on the display.

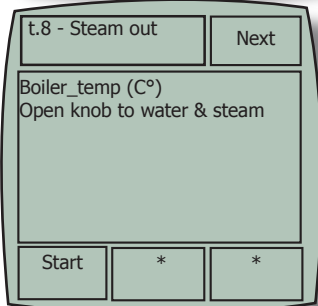

- **open knob to water & steam** - indicates that the knob is not in the water/steam position. Moving the knob to the water/steam state will start the procedure to drain the water circuit.

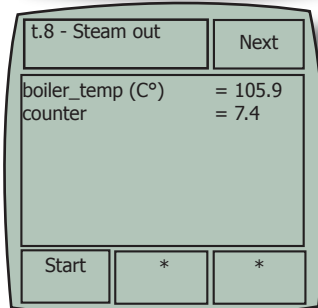

- **boiler_temp (C°)** - indicates the temperature of the water heater.
- **counter** - indicates the time remaining until the end of the cycle. When the water heater reaches 100°C, it switches off and the **counter starts**.

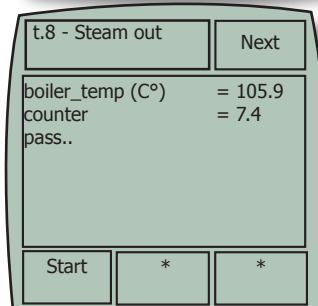

- **pass** - indicates that the procedure has been completed. Press **next** to move on.

Platinum Swing e Swing Up

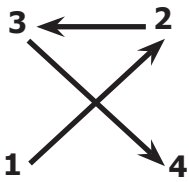

When in test mode

Switch the appliance on (double-pole switch on right side) and wait for the CA to finish initializing; then press and hold the illustrated menu key for 2 seconds until the string "Exit" appears on the screen. Press the capacitive keypad keys in the order shown on the left within the next two seconds.

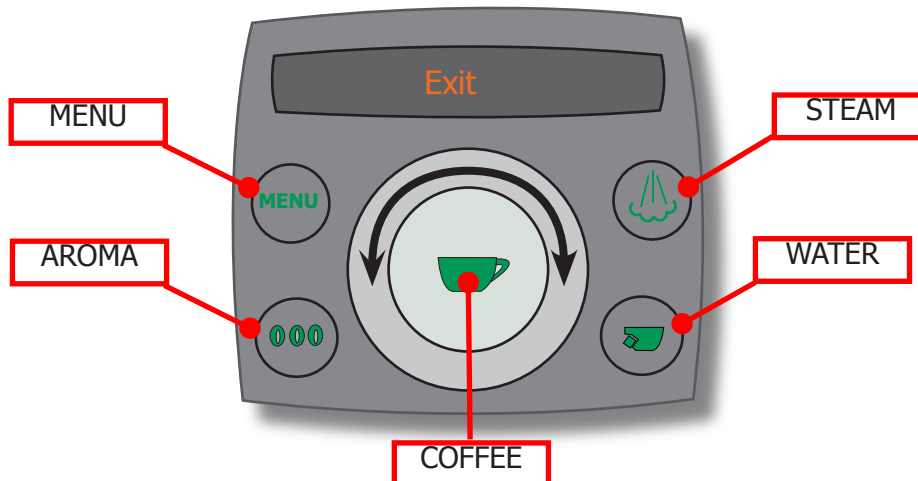

The following string appears when you enter test mode:

```
*Test* M0      12345 oo:mm:ss
SWvx.xx.xx    FFHz
```

```
*Test* M0      oo:mm:ss
DLv:1.01.10.FT  50HZ
```

Where:

- *Test* indicates that the C.A. is in test mode.
- M0 indicates the test level.
- 12345 indicate the keys pressed in the sequence shown in figure 1.
- oo:mm:ss indicates the hours and minutes of the CPU clock.
- SWvx.xx.xx indicates the SW version installed in the CPU card microcontroller.
- FFHz indicates actual supply voltage frequency.

To move from one test level to another, use the touch-ring around the coffee key, turning it clockwise to move to the next level and anticlockwise to go back a level.

Level M1

The state of the microswitch is shown at this level; the following string is shown on the second line:

```
Inputs 123456789ABCDEFG
```

Where:

- 1 Brew group presence microswitch excited.
- 2 Brew group work position microswitch excited.
- 3 Brew group home position microswitch excited.
- 4 Turbine sensor excited.
- 5 Tank water level capacitive sensor excited.
- 6 Side door closed microswitch excited.
- 7 Coffee grounds drawer presence microswitch excited.
- 8 Coffee bean container sensor excited.
- 9 Coffee grinder direction of rotation sensor excited.
- A Drip tray level capacitive sensor excited.
- B Water/steam knob in milk-island position.
- C Water/steam knob in water/steam position.
- D Milk-island presence microswitch excited.
- E Milk carafe presence microswitch excited.
- F Cup-lift-down microswitch excited (only on Ring Plus).
- F Cup-lift-up microswitch excited (only on Ring Plus).
- H Water/steam knob in closed position.

Numbers 6 and 7 are not displayed if the coffee grounds drawer is removed.

Level M2

Gearmotor function is tested at this level. To move the gearmotor, the coffee grounds drawer and side door microswitches must be excited. The status of the microswitches listed below is shown at the right of the top line on the display:

- 1 Brew group presence microswitch excited.
- 2 Brew group work position microswitch excited.
- 3 Brew group home position microswitch excited.
- 6 Side door closed microswitch excited.
- 7 Coffee grounds drawer presence microswitch excited.

Gearmotor status after the aroma key and capacitive keypad menu have been pressed is shown on the second line on the display:

- Aroma key - the gearmotor brings the group to the home position.
- Menu key - the gearmotor brings the group to the work position.

Power absorbed (mA) by the gearmotor during movement is shown on the right of the second line on the display.

Level M3

Coffee grinder, pump, cup warmer (Ring Plus only) and solenoid valve function are tested at this level. The above are primed by pressing the following keys:

- Steam key: coffee grinder.
- Water key: pump.
- Aroma key: varies grinding aroma.
- Menu key: solenoid valve.
- Coffee key: coffee grinder pulses.

COFFEE GRINDER TEST:

Coffee bean container sensor must be excited.

When the appropriate key is pressed, the following string appears on the second line of the display:

- Grinder ON 8 GG %%

Where:

- 8 indicates that the coffee bean container sensor has been excited.
- GG indicates the number of rotations performed by the coffee grinder.
- %% indicates the ratio between coffee grinder revolutions at 100% and 50% supply.

To set medium aroma pulses, press the coffee key then use the touch-ring to choose aroma pulses. After this, press the coffee key to save the number of impulses selected. Press the steam key to restore default settings.

By pressing the aroma key, you can vary grinding aroma. The value of the selected aroma is shown on the bottom left of the display, classified as follows:

- 1 - mild aroma.
- 2 - medium aroma.
- 3 - strong aroma.

PUMP TEST:

By pressing the appropriate key, the following string appears on the display:

- Flowmeter (Imp/s) GG

Where:

- GG indicates the number of revolutions performed by the turbine.

SOLENOID VALVE TEST:

By pressing the menu key, the following string appears on the second line of the display:

- Ev Brew On

Level M4

At this level you can check water heater, relative ntc sensor and cup warmer function.

- When you press the steam key, the ambient temperature (tt.t) is shown on the second line of the display in degrees centigrade.
- When you press the water key, the state of the ntc sensor (open or short), on the water heater (open or short), or the water heater temperature in degrees centigrade are shown on the second line of the display.
- Pressing the aroma key switches on the water heater (pressing the water key shows the rising temperature) and the string Heater ON appears on the second line of the display.
- When you press the menu key, the cup warmer is switched on and the string Cup Heater **(Ring Plus only) appears on the second line of the display.**

Steamout

Open the knob in the water/steam position to prepare for steamout (draining water heater). Press the coffee key to start, the water heater will be brought to 120°, at which time the machine emits a sequence of beeps.

WARNING: At the end of this procedure, the machine will automatically switch to English.

Level M5 (Cup lift position) on Ring Plus only.

At this level, you can check cup-lift function.

- Press the aroma key to move the cup-lift down to its lowermost position.
- Press the menu key to raise the cup-lift to its uppermost position.

Level M6 (LCD contrast)

You can change display contrast at this level.

- Press the coffee key to edit display contrast (the percentage value starts blinking).
- You can use the touch-ring to change this value: turn clockwise to increase it, and anticlockwise to decrease it.
- Press the coffee key again to save the value selected.

Level M7 (LCD backlight)

You can change display brightness at this level.

- Press the coffee key to change display brightness (the percentage value starts blinking).
- You can use the touch-ring to change this value: turn clockwise to increase it, and anticlockwise to decrease it.
- Press the coffee key again to save the value selected.

Level M8 (Self-test)

The machine automatically tests its main functions in the self-test. **The brew group must be present and the doors closed.**

On completion of this procedure (which lasts approx. 10 seconds), the outcome will appear on the display.

Pass!! and 2 consecutive beeps if it was successful.

If an error was encountered, 10 beeps will be emitted and a message appears on the display.

Level M9

- Exit.

Press the coffee key to exit test mode and fully restart the appliance.

Platinum Vogue

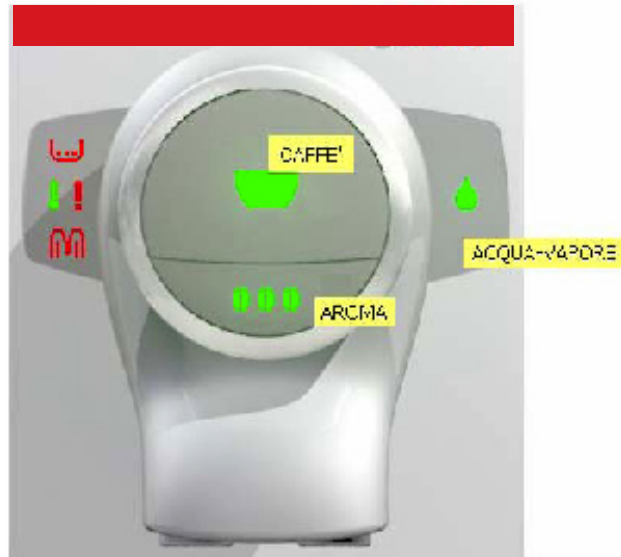

Coffee key

Press once to select a coffee.

Press twice to select a double coffee.

Stops coffee from being dispensed when pressed during dispensing.

Water/steam key

To select either water or steam.

Press and hold for 6 seconds to "reset" descaling alarm.

When off, indicates that the machine is ready to release steam.

When on, indicates that the machine is ready to dispense water.











Aroma key

To select either a mild coffee, a medium coffee or a strong coffee.

Middle button







To select length of coffee required.











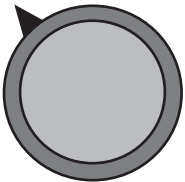

Messages/Alarms











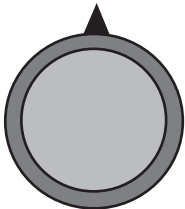



	Temperature ready LED	Fixed on.	Indicates "Coffee ready" or "Steam ready".
	Temperature ready LED	Slow blinking.	The correct temperature has not been reached.
	Water/steam LED	Off	The appliance is in steam mode.
	Water/steam LED	Fixed on.	The appliance is in water mode.
	Aroma LED	Fixed on.	To set aroma.
	General alarms LED	Fixed on.	Fill water tank. Empty drip tray. Out of coffee (*)
	General alarms LED	Slow blinking.	Door open. Brew group missing. Drip tray missing. Coffee container cover missing. Milk island or carafe missing.
	General alarms LED	Fast blinking.	Prime circuit.
	Coffee grounds drawer LED	Fixed on.	Indicates that grounds drawer needs emptying.
	Descaling LED (60 litres)	Slow blinking.	Indicates that descaling (manual) is required.
	Coffee grounds drawer and descaling LEDs	Blinking alternately.	Max. brew group torque exceeded. Brew group timeout or microswitch error. Coffee grinder blocked. OUT OF SERVICE
	Temperature ready LED Descaling LED General alarms LED Coffee grounds drawer LED	Light up one after the other anticlockwise.	Indicates that the appliance is running a "rinse cycle".













(*) Removing and replacing the coffee bean container will reset the "out of coffee" alarm.

Test mode

To open **Test Mode**, press  and turn the appliance on at the same time (Power On). Entering Test Mode is indicated by the rapid flashing of LEDs     (lighting up repeatedly **ANTICLOCKWISE** one after the other), continuing until  is released.

POSITION POTENTIOMETER	ACTION	CHECK
	Press 	Solenoid pilot
	Press 	Coffee grinder
	Press 	Set aroma. (default: 90-100-110 pulses).
	Valve open.	 lights up and stays on.
	Brew group missing microswitch	 blinks slowly.
	Drawer missing microswitch	 blinks slowly.
	Door open microswitch.	 blinks slowly.
	Coffee container cover microswitch	 blinks slowly.
	Carafe present microswitch (with valve closed).	 lights up and stays on.
	Turbine sensor (during pump function)	 blinks (turb. freq.)
	Water tank sensor	 lights up and stays on.
	Coffee grounds drawer	 lights up and stays on.

POSITION POTENTIOMETER	ACTION	CHECK
	Press 	Coffee heater.
	Press 	Unit down.
	Press 	Set aroma. (default: 90-100-110 pulses).
	Unit down microswitch. + Steam key pressed.	 blinks quickly.
	Valve open.	 lights up and stays on.
	Brew group missing microswitch	 blinks slowly.
	Drawer missing microswitch	 blinks slowly.
	Door open microswitch.	 blinks slowly.
	Coffee container cover microswitch	 blinks slowly.
	Carafe present microswitch (with valve closed).	 lights up and stays on.
	Turbine sensor (during pump function)	 blinks (turb. freq.)
	Water tank sensor	 lights up and stays on.
	Coffee grounds drawer	 lights up and stays on.







POSITION POTENTIOMETER	ACTION	CHECK
	Press 	Pump
	Press 	Unit up.
	Press 	Set aroma. (default: 90-100-110 pulses).
	Unit microswitch up. + Steam key pressed.	 blinks quickly.
	Valve open.	 lights up and stays on.
	Brew group missing microswitch	 blinks slowly.
	Drawer missing microswitch	 blinks slowly.
	Door open microswitch.	 blinks slowly.
	Coffee container cover microswitch	 blinks slowly.
	Carafe present microswitch (with valve closed).	 lights up and stays on.
	Turbine sensor (during pump function)	 blinks (turb. freq.)
	Water tank sensor	 lights up and stays on.
	Coffee grounds drawer	 lights up and stays on.











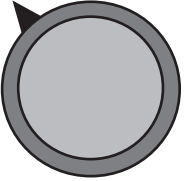

Special functions mode







The "Special Functions" mode allows you to:



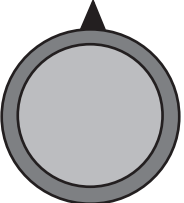



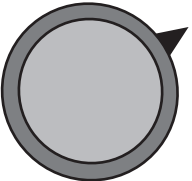

1) Activate the steamout procedure.

2) Identify which microswitch is responsible for the  "General Alarms" LED lighting up.

To enter **Special Functions Mode**, press  and switch on the appliance (Power On) at the same time. Entering Special Functions Mode is indicated by the rapid flashing of LEDs     (lighting up repeatedly **CLOCKWISE** one after the other), continuing until  is released.

POSITION POTENTIOMETER	ACTION	CHECK
	Open valve and press 	Steamout procedure. While the procedure is underway (for a total of 30 seconds), the following LEDs light up alternately one after the other in a clockwise direction    
	Press 	  light up and each time the key is pressed, the number of pulses for AVERAGE AROMA is reduced by 5 pulses to a minimum of 60 pulses.
	Brew group missing microswitch	 lights up and stays on.
	Drawer missing microswitch	 lights up and stays on.
	Door open microswitch.	 lights up and stays on.
	Coffee container cover microswitch	 lights up and stays on.

POSITION POTENTIOMETER	ACTION	CHECK
	Press 	No action!
	Press 	No action!
	Brew group missing microswitch	 lights up and stays on.
	Drawer missing microswitch	 lights up and stays on.
	Door open microswitch.	 lights up and stays on.
	Coffee container cover microswitch	 lights up and stays on.

POSITION POTENTIOMETER	ACTION	CHECK
	Press 	No action!
	Press 	  light up and each time the key is pressed, the number of pulses for AVERAGE AROMA is increased by 5 pulses up to a maximum of 150 pulses.
	Brew group missing microswitch	 lights up and stays on.
	Drawer missing microswitch	 lights up and stays on.
	Door open microswitch.	 lights up and stays on.
	Coffee container cover microswitch	 lights up and stays on.

DIP SWITCH

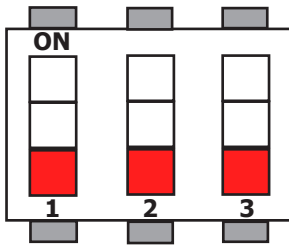

**CONFIGURATION
PLATINUM EVENT**

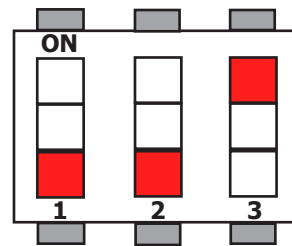

**CONFIGURATION
PLATINUM VOGUE**

DEFAULT DATA

AROMA PULSES		
MILD STRENGTH	MEDIUM STRENGTH	STRONG STRENGTH
54	60	66
59	65	71
63	70	77
68	75	82
72	80	88
77	85	93
81	90	99
86	95	104
90	100	110
95	105	115
99	110	121
104	115	126
108	120	132
113	125	137
117	130	143
122	135	148
126	140	154
131	145	159
135	150	165

5.2 Diagnostics function

Platinum Swin up

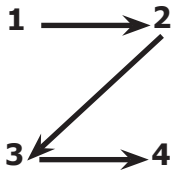

When in diagnostics mode

Switch the appliance on (double-pole switch on right side) and wait for the CA to finish initializing; then press and hold the menu key for 2 seconds until the string "Exit" appears on the screen. Press the capacitive keypad keys in the order shown on the left within the next two seconds.

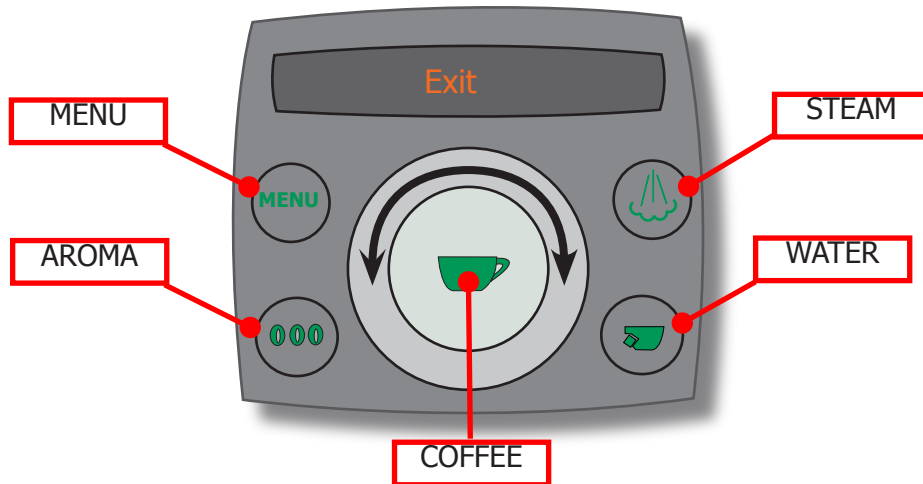

To move from one test level to another, use the touch-ring around the coffee key, turning it clockwise to move to the next level and anticlockwise to go back a level. Press the coffee key to open the sub-menus. Press the coffee again to confirm any changes. Press the menu key to exit sub-menus.

Level M1 : Product Counters

The following counters are shown at this level:

- 1.1 Total Products
- 1.2 Total number of espressos.
- 1.3 Total ml of espresso
- 1.4 Total number of coffees.
- 1.5 Total ml of coffee.
- 1.6 Total number of long coffees.
- 1.7 Total ml of long coffee.
- 1.8 Total number of waters.
- 1.9 Total ml of water.

Level M2 : Total Counters

The following counters are shown at this level:

- | | | |
|-----|--------------------|---|
| 2.1 | Water S.L.Descale | water since last descaling. |
| 2.2 | Water S. 1 Descale | water since last descaling. |
| 2.3 | Water S. 2 Descale | water since second last descaling. |
| 2.4 | Water S. 3 Descale | water since third last descaling. |
| 2.5 | Water Since Prod. | water used since production. |
| 2.6 | Descaling N° | total number of times appliance descaled. |
| 2.7 | B.U. Cleanings N° | times group cleaned. |
| 2.8 | Water Filters N° | filters used. |
| 2.9 | E2prom writes N° | |

Level M3 : Error Log

3.1 Errors List

The following are shown at this level:

-) The last 20 errors involving the CA
-) The date the error occurred.

The error map is shown below:

Code	Brief description	Description
COFFEE GRINDER ERRORS		
01	Coffee grinder blocked.	The coffee grinder won't turn: there may be something obstructing the grinders or beverage signal has not been read correctly by the Hall probe in the coffee grinder.
BREW GROUP ERRORS		
03	TORQUE_FAULT_FWD	Maximum force exceeded in forward movement to dispense position (second attempt).
	TIMEOUT_FWD	Maximum time exceeded to reach dispense position.
	TIMEOUT_FWD_DOWN	Maximum time exceeded to clear home position microswitch.
	HOME_WHILE_WORKING	Home position microswitch activated while moving to work position.
04	TORQUE_FAULT_RWD	Maximum force exceeded returning to home position.
	TIMEOUT_RWD	Maximum time exceeded returning to rest position.
	WORK_WHILE_HOMING	Work position microswitch activated while moving to home position.
16	HOME_AND_WORK_PRESSED	Both the work and home microswitches are activated at the same time.
WATER CIRCUIT ERRORS		
05	Water circuit blocked.	This can happen for a variety of reasons ...(trips when water not flowing in turbine).
TEMPERATURE CONTROL ERRORS		
10	SENSOR1_SHORT	Coffee heater sensor shorted.
11	SENSOR1_OPEN	Coffee heater sensor in open circuit.
14	TEMPERATURE_BO_TOO_HIGH	Coffee heater temperature too high.
15	TEMPERATURE_BO_OUT_CONTROL	Coffee heater temperature out of control (not responding to stimuli: e.g. heater on but temperature not rising).
GENERAL ERRORS		
19	No zero crossing.	No zero crossing on card, could be caused by power card.

3.2 Clear all?

pressing YES will delete all errors at level 3.1.

Level M4 : Products Settings

The parameters for each different beverage are shown at this level; these parameters can be modified by opening each item using the coffee key and selecting with the touch-ring.

4.1 Espresso Settings:

- 4.1.1 Product Qty. (imp.) Number of water pulses.
- 4.1.2 Aroma Displays coffee grinder pulses in 60-150 pulse range.
0: pre-ground (0 pulses); 1: mild (- 10% medium); 2: medium; 3: strong (+10% medium).
- 4.1.3 Prebrewing Prebrewing 1: enabled; 0: disabled; 2: long.
- 4.1.4 Temperature Shows temperature in °C. Low (-3°C average), average, high (+3°C average).

4.2 Coffee Settings:

- 4.2.1 Product Qty. (imp.) Number of water pulses.
- 4.2.2 Aroma 0: pre-ground; 1: mild; 2: medium; 3: strong.
- 4.2.3 Prebrewing 1: enabled; 0: disabled; 2: long.
- 4.2.4 Temperature in °C

4.3 Long Coffee Settings:

- 4.3.1 Product Qty. (imp.) Number of water pulses.
- 4.3.2 Aroma 0: pre-ground; 1: mild; 2: medium; 3: strong.
- 4.3.3 Prebrewing 1: enabled; 0: disabled; 2: long.
- 4.3.4 Temperature in °C

Level M5 : System Settings

System parameter values are shown at this level:

- 5.1 SW Version
- 5.2 Boot Version
- 5.3 Aroma Setup (imp.) Number of pulses set for medium aroma.
- 5.4 Temp. Standby From 50° to 80°C.
- 5.5 Cup. temp.
- 5.6 Standby temp. Standby time can be varied in 15 minute intervals.
- 5.7 Flowrate (L/h) Water flowrate.
- 5.8 Language
- 5.9 Water Hardness
- 5.10 Lcd Backlight Display brightness.
- 5.11 Lcd contrast Display contrast.
- 5.12 Grounds Limit Stop coffee grounds.
- 5.13 Grounds Left Coffee grounds counter.
- 5.14 Grounds Warning Empty coffee grounds.
- 5.15 W.Filter C. Date Date Aqua Prima filter was installed.
- 5.16 Service Date (to be added after servicing).
- 5.17 Production Date

5.3 Error messages for service personnel

Code	Applicable models:	Brief description	Description
01	All models	Coffee grinder 1 blocked.	The coffee grinder is blocked (grinders blocked or sensor not reading properly).
03	All models	Brew group blocked in work position.	Microswitch not released in up position after 3", torque error trying to move down, descent time out exceeded.
04	All models	Brew group blocked in home position.	Microswitch not released in down position after 3", torque error trying to move up, ascent time out exceeded.
05	All models	Water circuit blocked.	No water in turbine.
10-11	All models	Various sensor errors.	Water heater sensors shorted or in open circuit.
14-15	All models	Various temperature errors.	Heater temperatures out of control.
16	All models	Both microswitches activated on brew group.	The work and home microswitches have both been activated.
17	All models	Memory error.	Impossible to read or write to e2prom.
18	All models	Clock error.	Memory defect or impossible to set.
19	All models	No zero crossing.	No zero crossing on card, could be caused by power card.
20	All models	Cup lift error.	The two stroke end position microswitches are activated at the same time.

On models in the new Platinum ranges, errors recorded can be viewed on the display (during diagnosis) or on a PC (with programmer). The following are saved:

- A) The last 20 errors to be recorded.
- B) Total number of errors (not all models).
 - Since production (total).
 - Since last service (partial).
 - Current.

5.4 Problems, causes, remedies

HELP MESSAGES DISPLAYED	HOW TO RESET MESSAGE
Turn the appliance off and on to solve the problem.	Switch off and after 30 sec. turn on the appliance to restore normal operating conditions.
Call the Service Center.	Problem requiring assistance of Service Center.
Insert drip tray.	Insert drip tray.
Close coffee granule container cover.	Close the coffee granule container to enable delivery of any beverage.
Insert ground coffee.	This message guides the user when this type of coffee has been selected during personalised beverage programming.
Insert brew group.	Insert brew group in seat.
Insert coffee grounds drawer.	Insert coffee grounds drawer.
Empty coffee grounds drawer.	Remove coffee grounds drawer and empty. N.B: The coffee grounds drawer must only be emptied when the appliance is switched on. The drawer must be removed for at least 5 seconds. If the drawer is emptied when the appliance is switched off the message is not reset.
Close side door	Close service door.
Fill water tank.	Fill tank.
Empty drip tray below brew group.	Empty drip tray.
Insert milk container.	Insert container in milk compartment.
Prime circuit.	Start filling water circuit automatically. The appliance will automatically try to fill the circuit 5 times; if it fails, contact the Service Centre.
The descaling cycle did not run correctly.	Repeat the operation as described in the relative chapter in the instruction booklet.
Replace Aqua Prima filter.	This message is only displayed if the filter control is enabled (see instruction booklet). Replace the filter if: 1) 60 litres of water have been dispensed. 2) 90 days have elapsed since installation. 3) 20 days have elapsed since the coffee maker was last used.
The cleaning cycle did not run correctly.	Repeat the operation as described in the relative chapter in the instruction booklet.
Insert cappuccinatore.	Insert cappuccinatore in milk compartment.
Rinse milk container.	Clean container after use.
Descale appliance.	Run descaling cycle
Standby.	Press " start".

SECTION 6
OPERATING
LOGIC

REV.00

6.1 Reset coffee grounds drawer.

The "empty coffee grounds drawer" message is signalled by a "coffee" beverages counter controlled by the appliance electronics.

The counter is cleared "empty coffee grounds drawer" reset message:

1. After 13 coffees, if the grounds drawer is removed for more than 5 seconds.
2. Each time the grounds drawer is removed for more than 5 seconds when an "empty coffee grounds drawer" alarm has been generated (it is assumed that the grounds drawer has been emptied).

N.B:

If the 12th coffee is actually a "double coffee", the "empty coffee grounds drawer" alarm will be generated at the 14th coffee. As a result, the counter for the "empty coffee grounds drawer" in this case would be reset at the 14th coffee.

6.2 Water reserve

Platinum models have a fixed reserve (turbine pulses) to ensure the selected beverage can be fully (partially or totally) dispensed each time the capacitive sensor registers the presence of water in the water tank. Otherwise, the appliance displays the "fill water tank" message and will not dispense the beverage.

The beverage will be dispensed in full or in part depending on whether the remaining reserve is enough to cover the programmed length of the selected beverage.

On selection, a message requests that the water tank is filled.

Example:

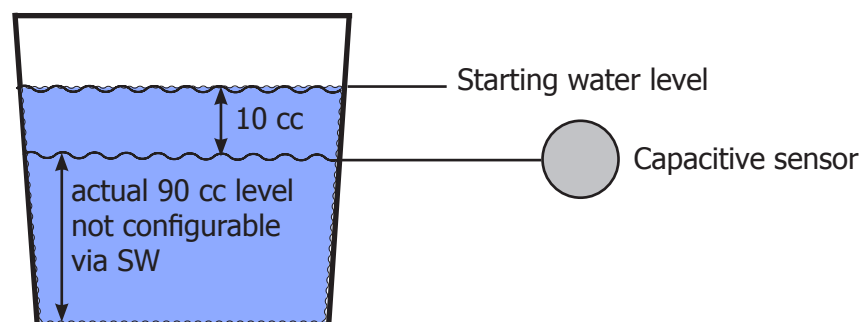

e.g: sensor registers presence of water (+10cc).

Hypothesis 1) A 60cc beverage is selected, 50cc is taken from the reserve, the beverage is dispensed in full, and the "fill water tank" message appears.

Hypothesis 2) A 110cc beverage is selected, 90cc is taken from the reserve, the product is dispensed in part (100cc), and the "fill water tank" message appears.

Hypothesis 3) A double 110cc coffee is selected; the first is dispensed in part (100cc), the fill tank message appears, then the second one is dispensed in full (110cc).

Hypothesis 4) Double 40cc coffees are selected; the appliance dispenses both in full.

6.3 Motorized tray

The movement of the motorized tray is mechanical by means of a stepper motor (1) in 24V DC, controlled by two capacitive pushbuttons (2) located at the front of the tray. The two microswitches (3) are for the limit switch, and operation can be checked in test mode (see section 5.1).

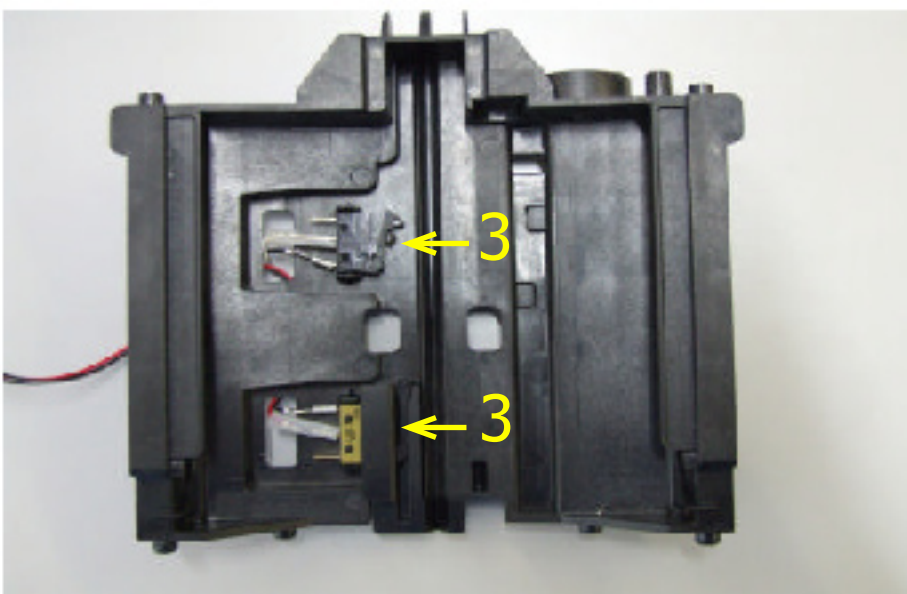
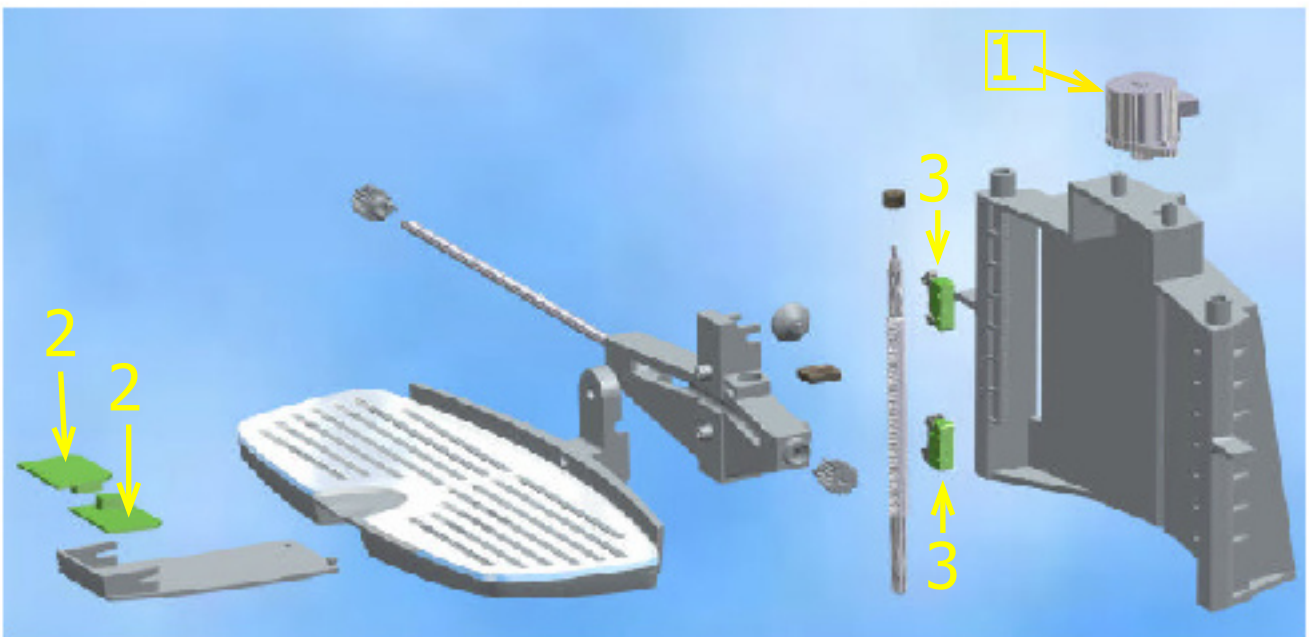

6.4 Aqua Prima

Operating logic with "AQUA PRIMA" filter.

When use of the "aqua prima" filter is selected on the user menu or via the control panel, the system water count logic is as follows:

If the "aqua prima" function is **enabled** the electronics perform a pulse count of the turbine, recording **one pulse every 2 revolutions**.

If the "aqua prima" function is **disabled**, the electronics perform a pulse count of the turbine, recording **one pulse every revolution**.

The graph in the figure below illustrates this function:

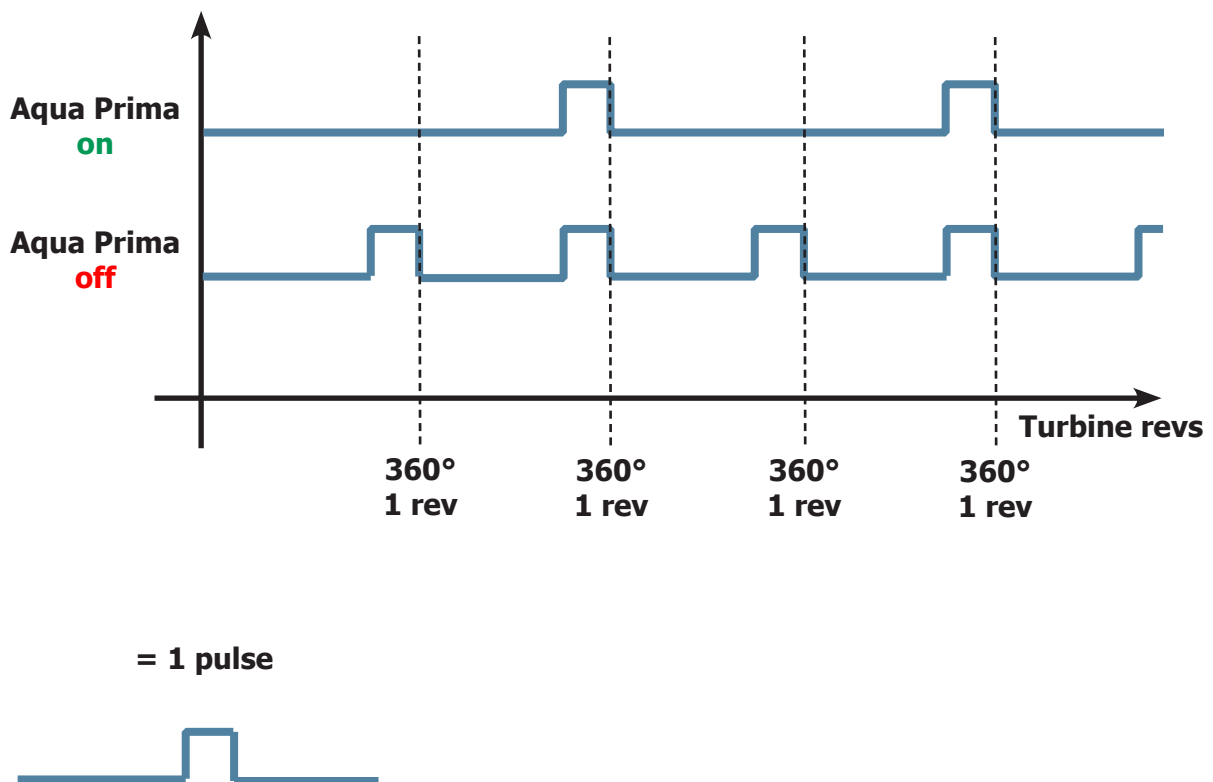

6.5 SBS Valve

Beverage dispensing

The SBS brewing system valve (see Fig. 2) controllable via the knob, enables variation (increasing or decreasing according to the position of the knob) of the water flow rate for brewing. This adjusts the coffee brewing time (extraction time) and consequently the intensity of taste, keeping the cream quality constant.

Function

With the SBS valve in the open position, coffee is accumulated in the membrane valve due to a low back-pressure of the SBS valve. Consequently the membrane valve needle remains in the maximum open position, due to resistance of the spring. Coffee exits quickly (see fig. 3).

With the SBS valve in the closed position, coffee is accumulated on the membrane of the valve with a consequent increase in pressure in the valve. The spring yields to the back-pressure and the needle then reduces the coffee passage (see Fig. 4).

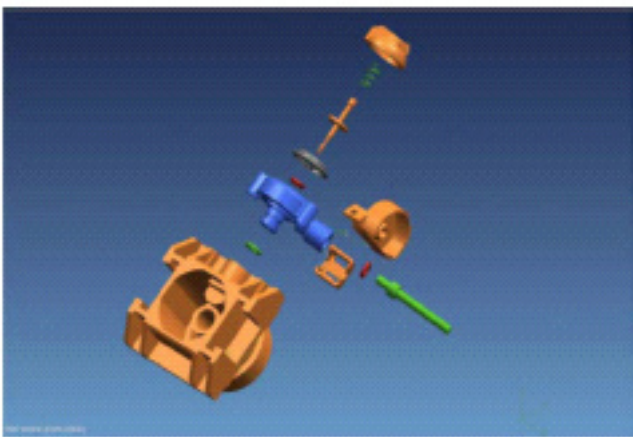

Fig.1

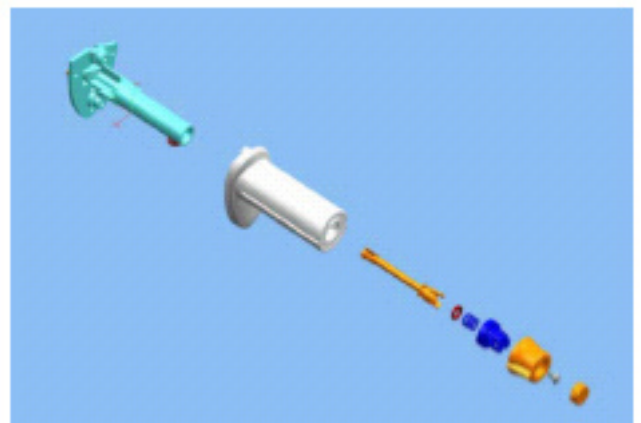

Fig.2

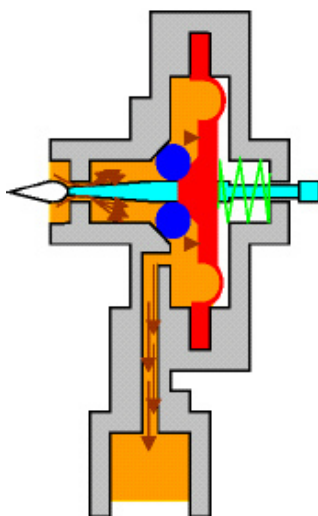

Fig.3

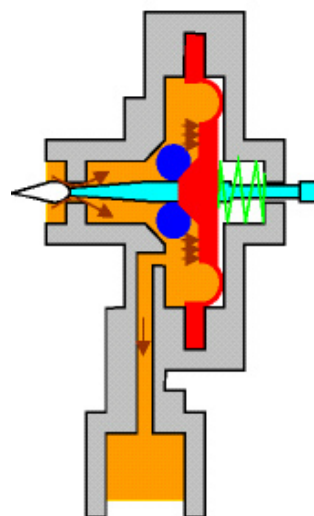
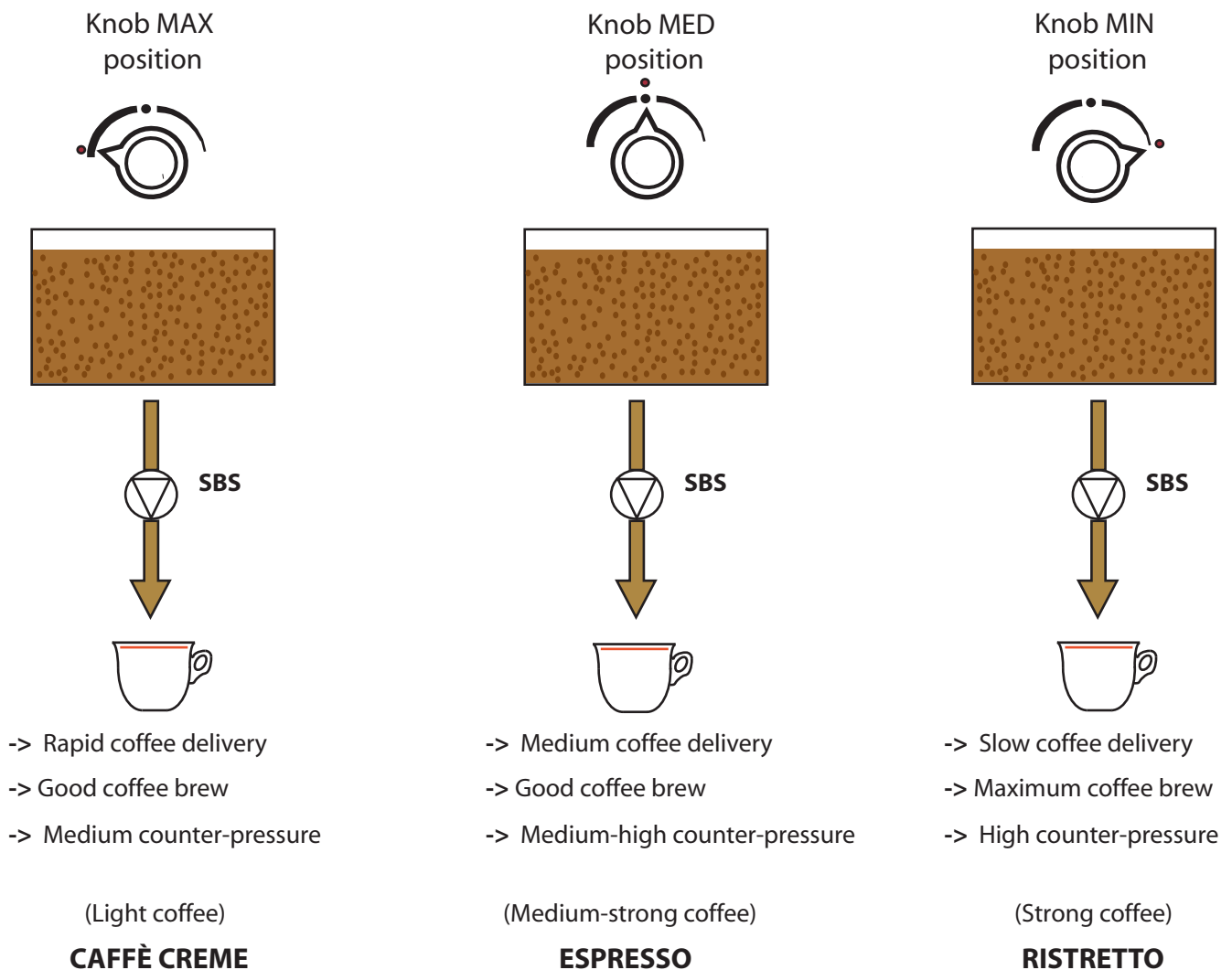

Fig.4

SBS valve operation check

To ensure correct operation of the valve SBS a long coffee should be made, and during preparation of the latter, check the difference in dispensing speed between the maximum and minimum positions.

The difference in dispensing speed is approx. 2.5 times greater (and therefore VERY obvious!!).



6.6 Solenoid pilot

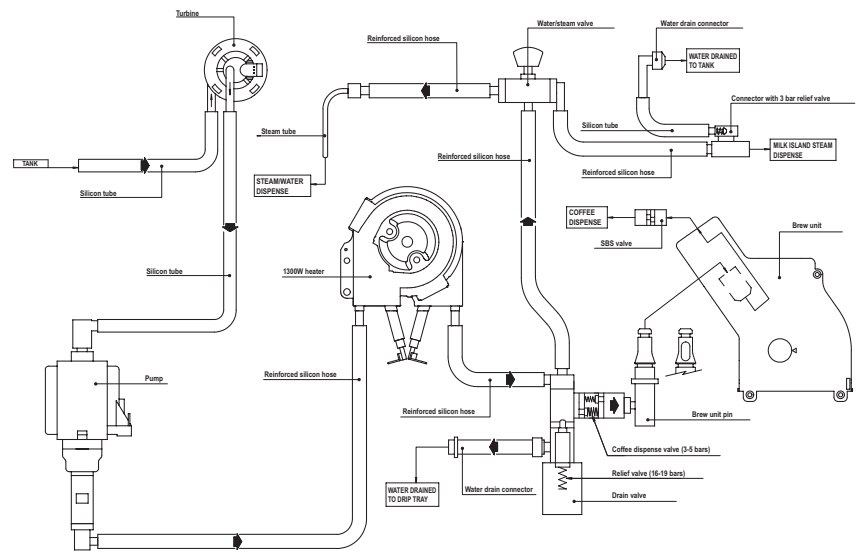
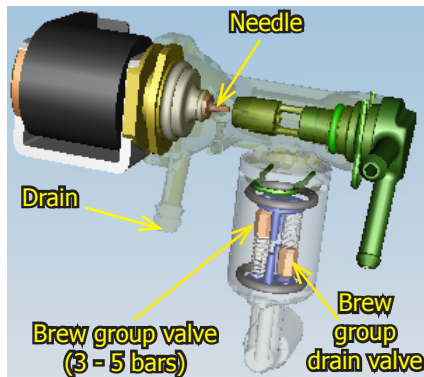

Solenoid pilot function:

1. **Brew group drain:** before the group is lowered, the solenoid pilot opens briefly creating a depression that in turn opens the valve in the opposite direction from dispensing, allowing any water left in the group to be drained and keeping the pad dry.
 2. **Coffee ready after steam:** when a coffee or water are selected, the solenoid pilot opens the drain valve to lower pressure in the heater.
 3. **Prime heater:** after a period in standby or when the appliance has not been used for an extended period (1st coffee), the pump loads briefly during grinding to get rid of any water between the heater pin and heater, and to pre-heat the elements.
 4. **Fill circuit:** the solenoid pilot discharges and recharges automatically. The discharge occurs via the drain pipe and not via the valve.
 5. **Relief valve:** the solenoid pilot also serves as a relief valve (not present on pump), opening in the event of pressure in excess of 16-19 bars.
 6. **Lower pressure:** pressure is lowered by the circuit being discharged for 10 seconds after water or steam have been dispensed (see variables A and B).
- A) Configuration with dual-sensor valve card (water/steam position sensor + Milk Island position sensor):**
 After water has been dispensed -> the solenoid pilot opens to the discharge side as soon as the sensor is disengaged.
 Immediately after steam has been dispensed -> the solenoid pilot opens to the discharge side as soon as the sensor is disengaged.
 Water dispensed after steam has been dispensed -> the solenoid pilot opens to the discharge side as soon as the sensor is disengaged.
 - After each beverage has been dispensed -> the solenoid pilot opens to the discharge side.
 - Each time the appliance is switched on and the temperature is reached -> the solenoid pilot opens to the discharge side.
 - When the temperature is reached -> the solenoid pilot opens to the discharge side.
- B) Configuration with three-sensor valve card (water/steam sensor + closed position sensor + milk island position sensor):**
 In addition to the functions described in configuration A, the following also occur:
 Each time the closed position central sensor is disengaged -> always open the solenoid pilot towards the discharge side.

6.7 Milk Island

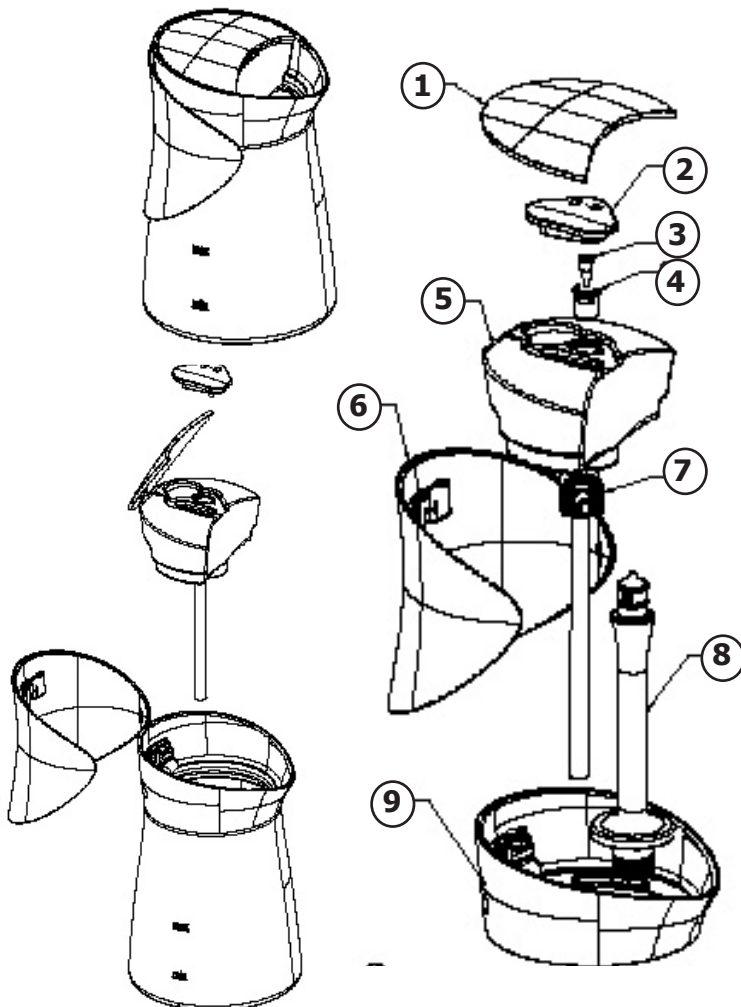
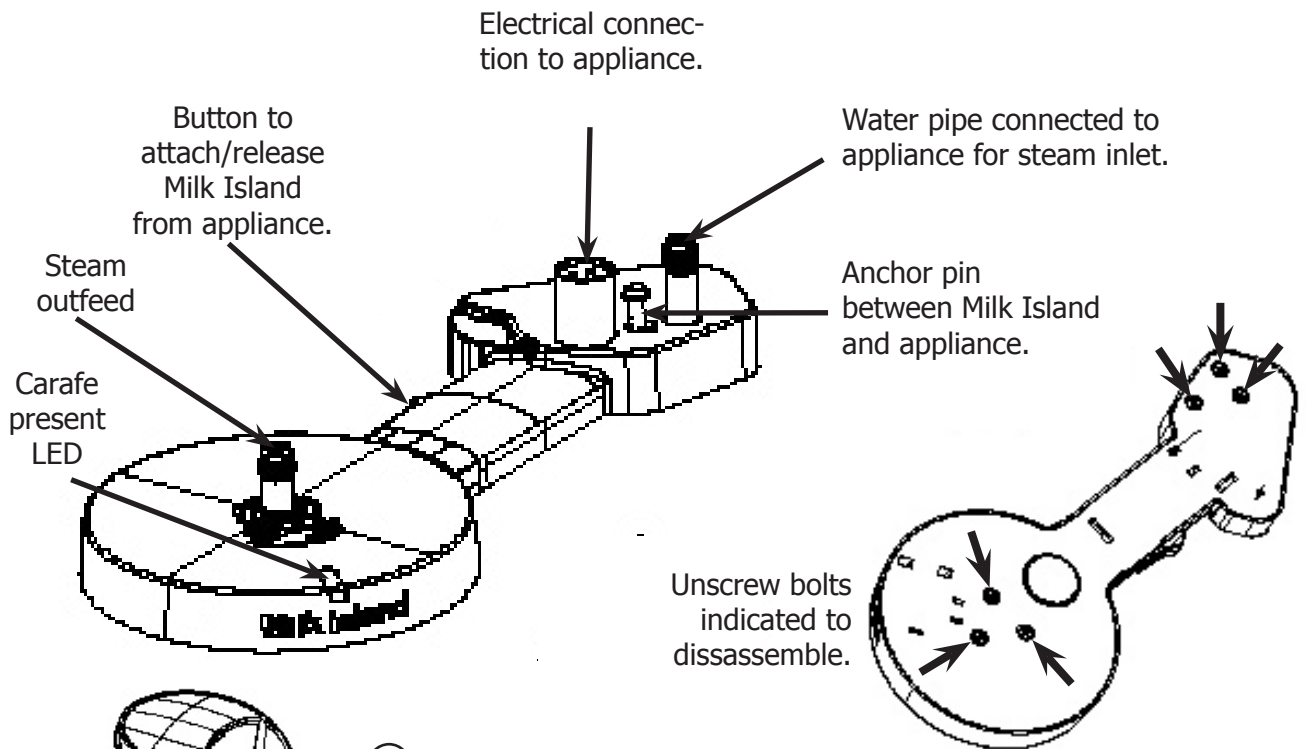

- ① Cappuccinatore cover.
- ② Cappuccinatore valve cover.
- ③ Vernay valve.
- ④ Cappuccinatore valve cover insert.
- ⑤ Cappuccinatore body.
- ⑥ Carafe handle.
- ⑦ Carafe milk suction pipe.
- ⑧ Carafe steamout pipe.
- ⑨ Top part carafe.

***SECTION 7
COMPONENT
ASSEMBLY
AND DISASSEMBLY***

REV.00



Remove the coffee top container, unscrew the three screws pointed out and lift the upper cover.

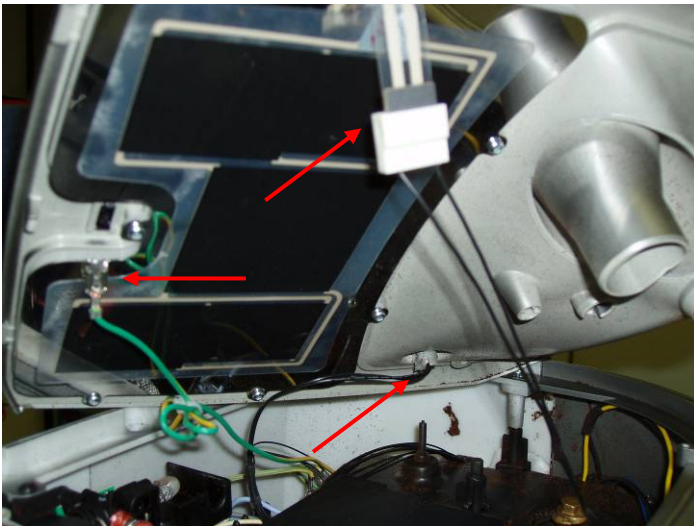

Disconnct the cups warmer (where included), the ground wire cable and the coffee top container sensor.



In order to dismantle the distributor completely, extract the regulation stick and, following the screws sequence, dismantle the different parts.

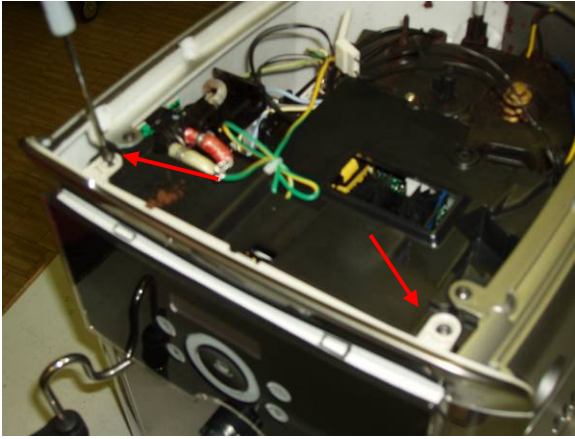

Unscrew the four screws which block the frontal panel, so that it can move.

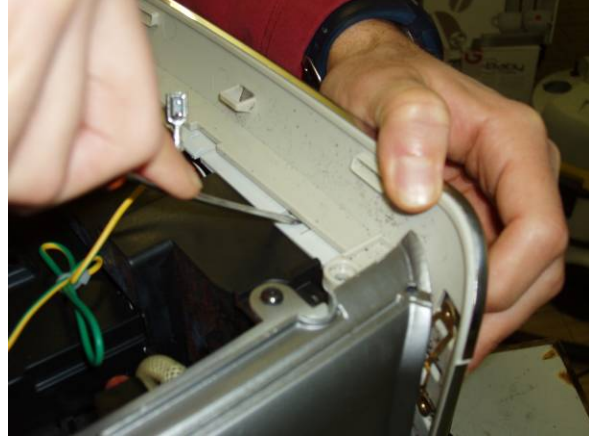

Unhook the anterior riser, by unblocking firstly the two lower hooks and then the upper ones (see photo), paying attention to not break the riser's hooks. After having removed the riser, it is possible to remove the frontal panel.

7.2 Right and left side casing

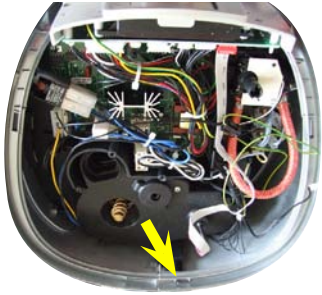

Loosen the screw as shown.



To remove the right side, loosen the screws as indicated.



To remove the left side, loosen the screws as indicated.

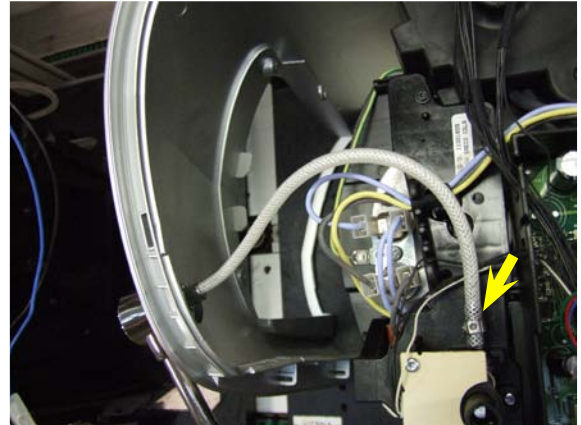

To take the left-side off, release the small clamp and pull out the wire mesh pipe connecting the steam pipe to the valve, removing the metal band as shown.



1



2

Split the two sides of the casing (see Fig..1).
Press from the bottom (see Fig.2).
Release and take it off from the side and at the bottom
(see Fig. 3), pulling towards you at the same time (see Fig. 4).



3



4

7.3 Electronics

CPU card

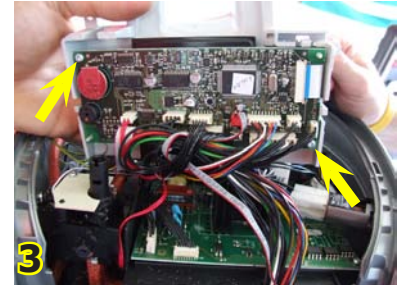
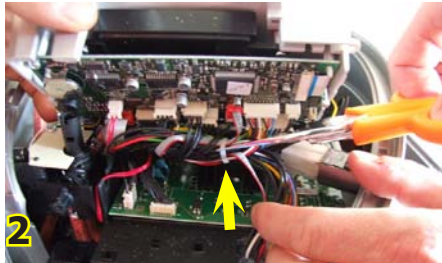
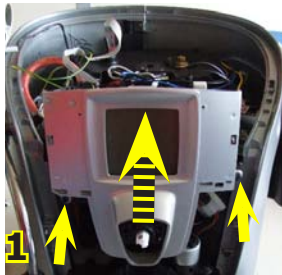
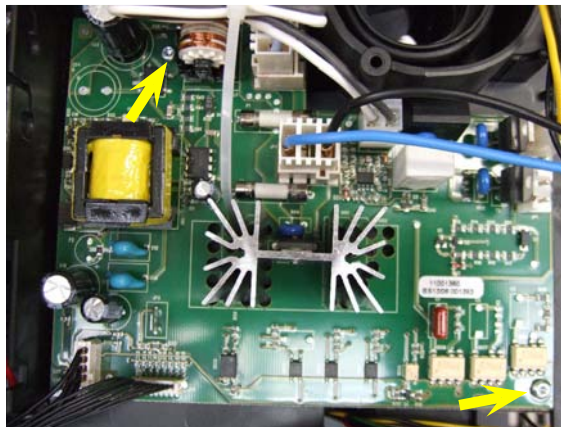

Fig.1 Loosen the screws as indicated and turn the front piece upwards to get to the card.

Fig.2 Take off the small clamp.

Fig.3 Disconnect all connectors and loosen the screws as indicated.

Power board



Remove the small clamps, disconnect all connectors and loosen the screws indicated.

7.4 Gearmotor

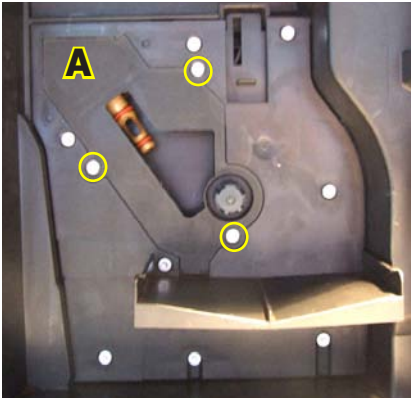

Remove the safety guard (A) by loosening the screws as indicated.

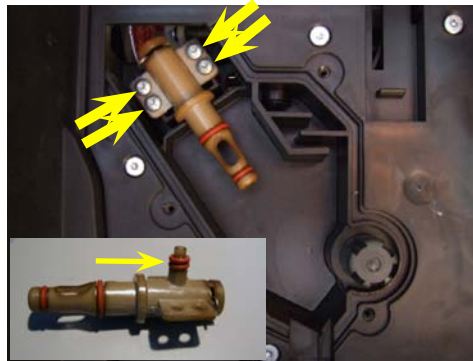

Loosen the four screws indicated and remove the heater valve asm. When refitting it, be careful with the two oil-rings shown in the smaller picture.

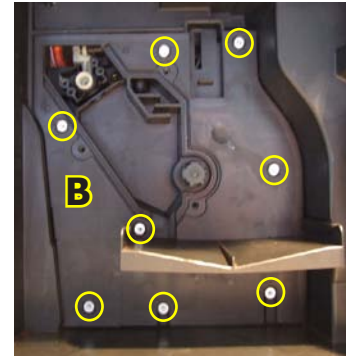

Disassemble the protection plate (B) by loosening the screws as indicated.

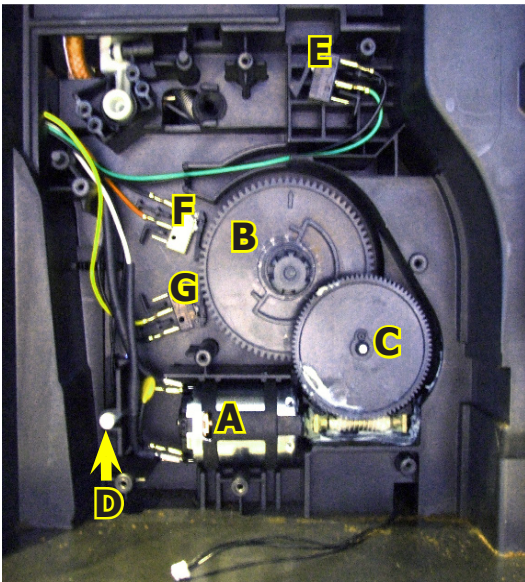

The following are located inside the compartment protected by the guard:

- Electric motor (A) with gears (B) and (C) for transmission and timing of the brew group.
- The drip tray present reed switch sensor (D).
- Brew group present microswitch (E).
- Microswitch (F) brew group at Home position.
- Microswitch (G) brew group at dispensing position.

Withdraw the gear (C) that meshes with the motor transmission shaft.

Withdraw the large gear (B).

Pull out the motor (A) complete with transmission shaft (H).

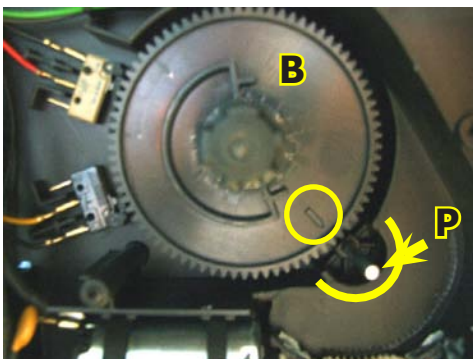

Insert the gear (B), taking care that the arrow stamped on the element is within the opening that contains pin (P).

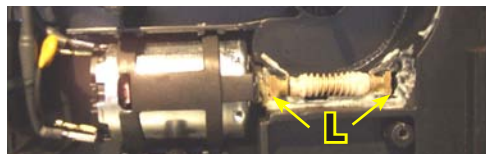

Install the motor and transmission shaft, inserting the guides (L) in the relative seat.

7.5 Pump



Take the pump out from the rubber support guides.



Withdraw the fastener connectors as indicated.



Pull out the adapter.

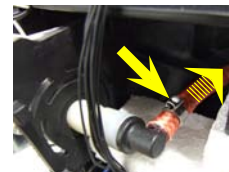

Take off the oetiker clamp as indicated and pull out the reinforced flexible hose.

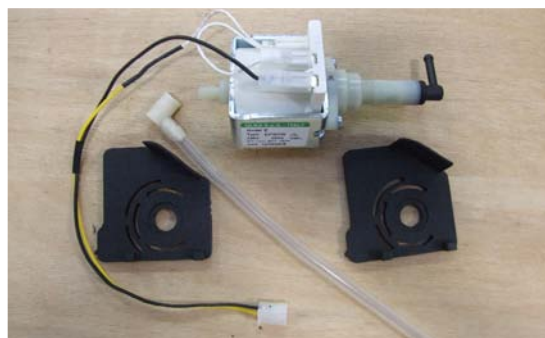

7.6 Heater and solenoid pilot unit



Loosen the screws as indicated.

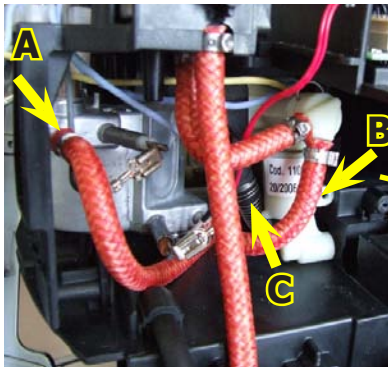
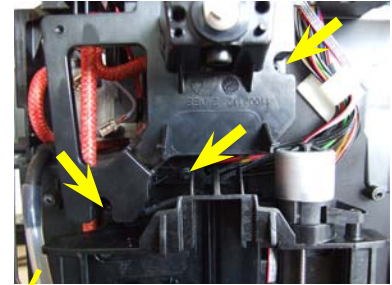

Take off the oetiker clamp A, pull out the reinforced flexible hose, loosen screw B and withdraw the drain pipe C from the solenoid pilot.

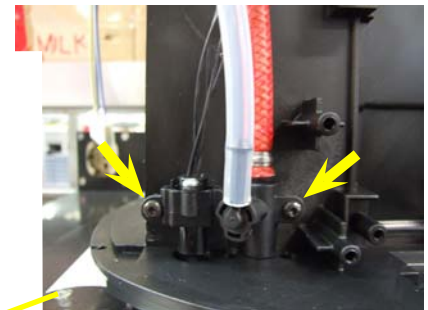
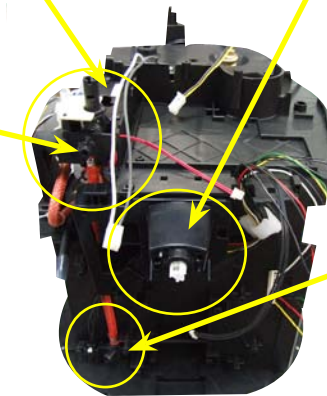

Loosen the screws on the relief valve assembly.

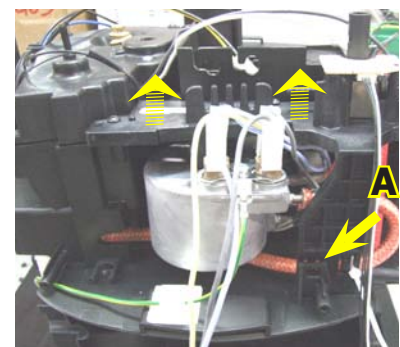
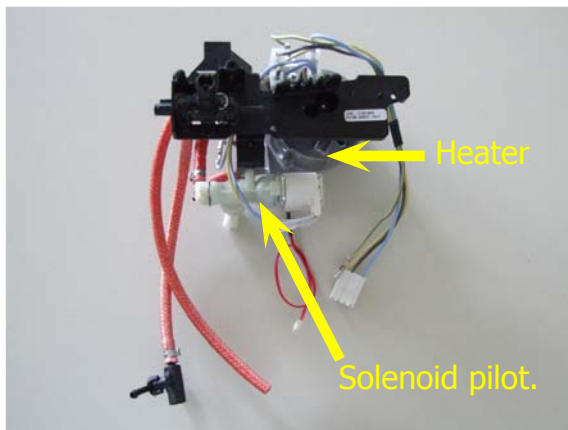

Unhook the teeth anchoring to the body and lift the heater and solenoid pilot.

7.7 OETIKER clamp assembly and disassembly

Heater clamps

1 HEATER

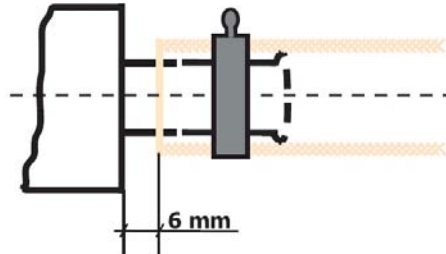

Figure (1) shows the assembly position of the clamp on the heater connector.

Solenoid pilot

2 SOLENOID PILOT

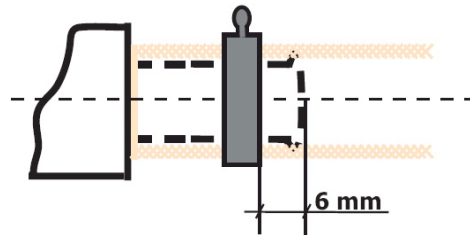

Figure (2) shows the assembly position of the clamp on the plastic solenoid pilot connectors.



A

Use suitable pliers to tighten the clamp. Ensure correct tightening (A) and positioning as shown in illustrations (1) / (2).



B

To remove the clamp, use a pincer as shown in (B)

7.8 Coffee grinder

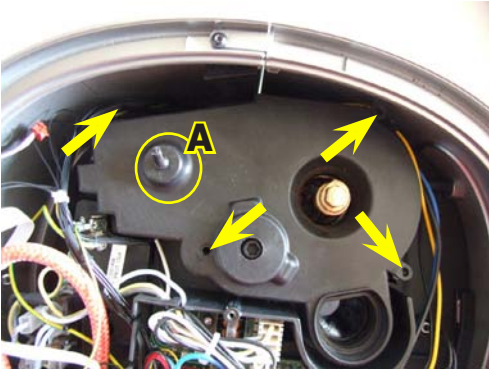

Loosen the screws on the cover and lift it off, being careful to withdraw damper A.

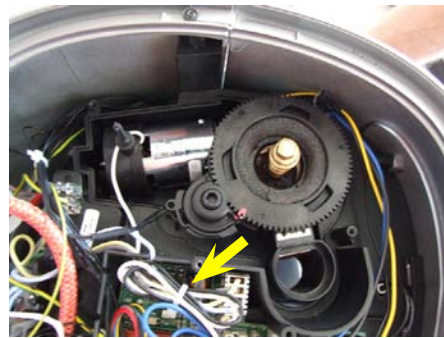

Unclamp and remove the connector inserted in the card.

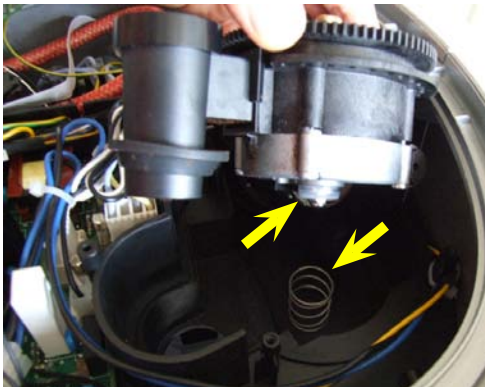

When refitting the motor assembly, be careful to reinsert the spring.

7.9 Coffee grinder setting, assembly and disassembly

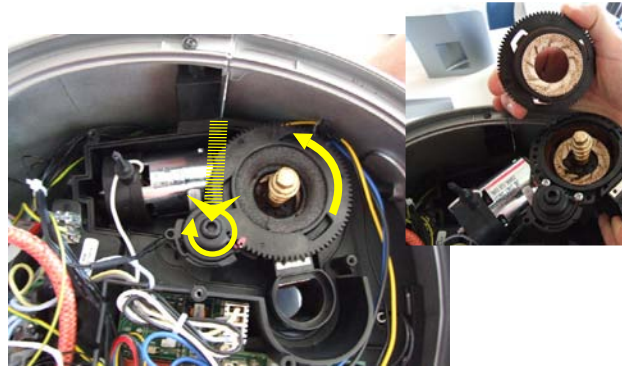

To remove the upper grinder support, use a wrench, turning it clockwise to release the grinder support from the bayonet coupling.

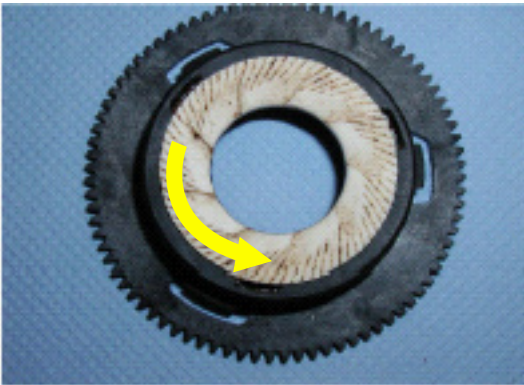

To remove the upper burr, rotate anti-clockwise until it detaches from the bayonet coupling.



On the lower burr, keep the increment pin as indicated locked in position and proceed as shown in the figure above.

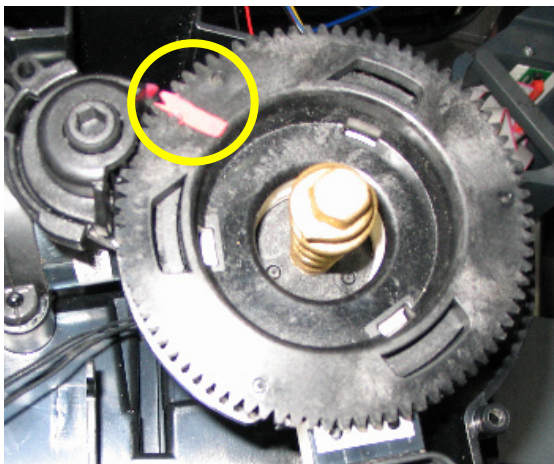

When refitting the upper grinder support, take care to reposition the mark as shown in the picture.

7.10 Grinder adjustment during servicing

To adjust the coffee grinder (in addition to user-permitted adjustments of "C" with the grinding adjustment tool "A"), remove the coffee granule container and turn adjustment insert "B" to widen or tighten grinding. This insert can be repositioned to move interval "C".

Be very careful not to separate the grinders from their supports.

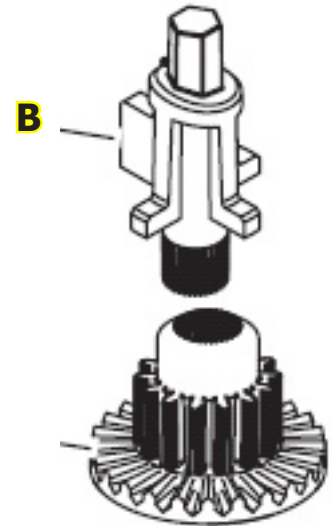
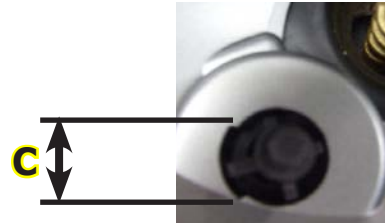

To vary the grinding setting, tighten or loosen with wrench "A" supplied.

(+) = Coarse grinding

(-) = Fine grinding.



WARNING:

- Grinding must be adjusted with the motor in movement.
- Adjust the grinding level by one step at a time.
- After setting grinding, run two grinding cycles and check the resulting granules and dose.
- Repeat if further adjustment is required.

7.11 Motorized drip tray

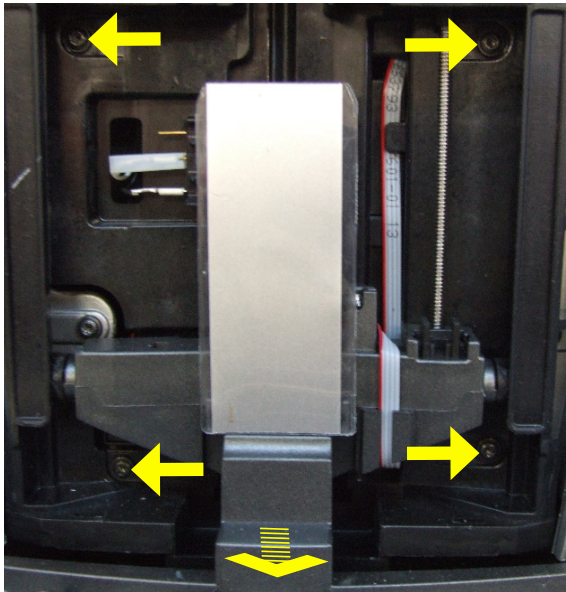

Loosen the screws as indicated.
Pull the motorized tray towards you.

Disassembling the motorized tank stepper motor

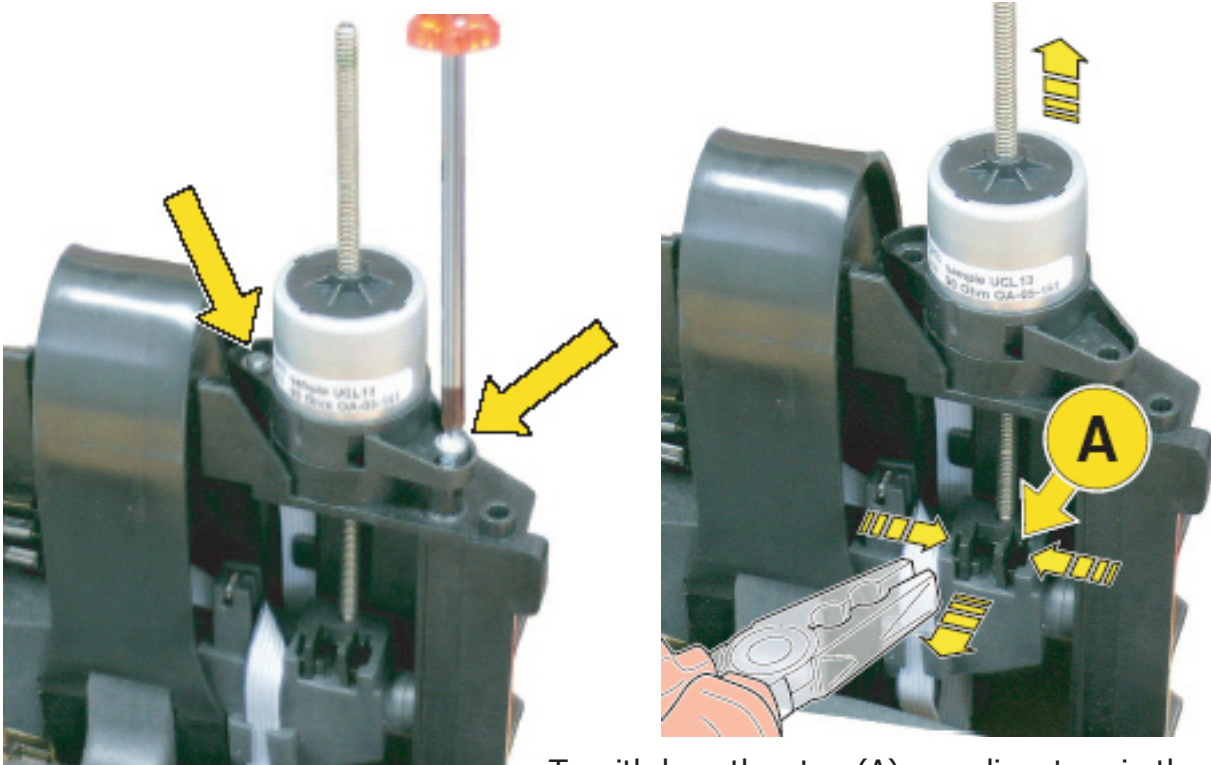

Loosen the two screws to release
the electric motor with worm gear

To withdraw the stop (A) use pliers to grip the tabs
securing the lifting system to the base and pull out-
wards. Withdraw the electric motor with worm gear
from above.

SECTION 8
SERVICE
SCHEDULE

REV.00

8.1 Routine maintenance check list

S= Replacement

R= Service

P= Cleaning

D= Descaling

C= Inspection

***= Number of beverages dispensed**

Parts	Task			Reason	Item
	Service	5,000*	10,000*		
Casing, tanks, containers, power cable.	C	C	C	Dirty, damaged.	See documentation (exp. drawing).
Water coffee andè milk lines.					
GACO DIM 14 seals	S	S	S	Wear	
Water filter	S	S	S	Dirty, hygiene.	
Silicon tube	C	D	D	Dirty, scale, leaks.	See documentation (exp. drawing).
Turbine	C	D	D	Dirty, scale, leaks.	See documentation (exp. drawing).
Heater	C	D	D	Dirty, scale, leaks.	See documentation (exp. drawing).
Multi-valve	C	D	D	Dirty, scale, leaks.	See documentation (exp. drawing).
Heater pin o-ring	S	S	S	Dirty, scale, leaks.	
Brew group	P	P	P	Dirty, hygiene.	See documentation (exp. drawing).
Cappuccinatore	P	P	P	Dirty, hygiene.	See documentation (exp. drawing).
Coffee grinder					
Grinders	P	P	P	Dirty, hygiene.	See documentation (exp. drawing).
Check grinding and dose.	C	C	C	Grain size and dose	
Brew group					
Cleaning	C	R	R	Dirty, hygiene.	
Lubrication	C	R	R	Dirty, hygiene.	
O-ring	C	S	S	Wear	See documentation (exp. drawing).
Full service	C	C	C	Wear	
Othertasks					
Descale	C	D	D	Then check condition of parts.	
Temperature check	C	C	C	Client information	
Explanation of fault	C	C	C	Client information	
Safety check	C	C	C	Always	
Packing	C	C	S	Check, always.	Use new packaging if necessary.