

SPECIFICATION CONTROL DRAWING

Revisions			
Rev.	Date	Description	ECO No.
1	05/07/13	Experimental Release (Pilot Run)	----

Dimensions and drawings for reference only. Drawings are not to scale.

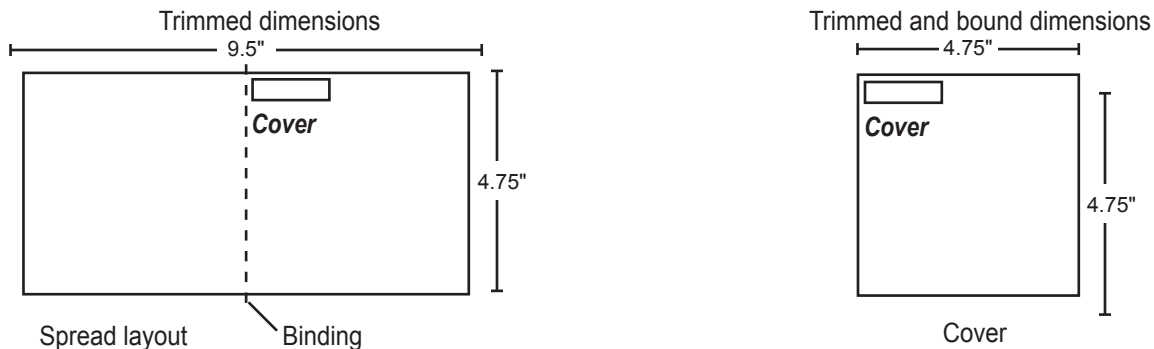

Specifications

- | | |
|----------------|--|
| 1. Description | Product documentation, Astro 320 with DC 50 Quick Start Manual |
| 2. Size | Trimmed: Width = 9.5" Height = 4.75". Finished, Folded: Width = 4.75", Height = 4.75". |
| 3. Tolerance | ±0.0787" (±2 mm) |
| 4. Pagination | 12 pages |
| 5. Material | 120-lb coated. Approved Equivalents Allowed. |
| 6. Finish | Matte. |
| 7. Color | 4-color process. |
| 8. Bindery | Saddle-stitched. Approved Equivalents Allowed. |
| 9. Folds | N/A |
| 10. Languages | English |
| 11. Notes | This part shall comply with Garmin Banned & Restricted Substances (GPN 001-00211-00). |

Electronic Archive Contents

File Name	File Contents
Astro320_DC50_QSM_EN_Spec.indd	InDesign CS4, Document specification sheet
Astro320_DC50_QSM_EN.pdf	Portable Document Format, manual for online posting and CD-ROM

CONFIDENTIAL This drawing and the specifications contained herein are the property of Garmin Ltd. or its subsidiaries and may not be reproduced or used in whole or in part as the basis for manufacture or sale of products without written permission.				Garmin Ltd. or its subsidiaries C/O Garmin International, Inc. 1200 E. 151st Street Olathe, Kansas 66062 U.S.A.	
	Initials	Date	TITLE Astro 320 with DC 50 Quick Start Manual		
Drawn By:	JAH	05/07/13	SIZE A	PART NO: 190-01628-01	REV: 1
			SCALE N/A	Sheet 1	Of 13

Astro[®] 320 with DC[™] 50

Quick Start Manual



Introduction

WARNING

See the *Important Safety and Product Information* guide in the product box for product warnings and other important information.

Setting Up the Astro System

Before you can use all the features of the DC 50 device, you should update your Astro to the latest software version. See the *Astro 320 with DC 50 Owner's Manual*.

You must set up the Astro handheld device and the DC 50 dog collar device before you can use the devices.

- 1 Install batteries in the handheld device (page 4).
- 2 Charge the dog collar device (page 5).
- 3 Turn on the devices (page 5).
- 4 If necessary, add the dog collar device to the handheld device (page 6).
- 5 Acquire satellite signals (page 6).

Device Overviews

Astro

NOTICE

Avoid using a high-powered radio (greater than 5 watts) in close proximity to the Astro. It may cause irreversible damage to the Astro.



①	GPS antenna
②	VHF antenna

③	⏻ Power key
④	Display
⑤	Keypad
⑥	USB port (under weather cap)
⑦	microSD™ card slot (under battery door)
⑧	Mounting spine
⑨	Battery cover D-ring

Keypad



BACK	Select to cancel data entry or return to the previous menu or page.
MAP	Select to view the map.
MENU	Select to open the menu for the active page. Select twice to open the main menu.
ENTER	Select to select options and acknowledge messages.
	Select to view or scroll through options and to move the map pointer.
IN	Select to zoom in on the map.
OUT	Select to zoom out on the map.

Locking the Keypad

- 1 Select ⏻.
- 2 Select **OUT**.

DOG	Select to view the dog tracking page.
MARK	Select to mark your current location.

DC 50



①	VHF antenna
②	Collar
③	GPS antenna
④	Power key

Getting More Information

You can find more information about this product on the Garmin® website.

- Go to www.garmin.com/astro.
- Go to www.garmin.com/outdoor.
- Go to <http://buy.garmin.com>, or contact your Garmin dealer for more information about optional accessories and replacement parts.

Getting the Owner's Manual

You can get the latest owner's manual from the web.

- 1 Go to www.garmin.com/support.
- 2 Select **Manuals**.
- 3 Follow the on-screen instructions to select your product.

Registering Your Device

Help us better support you by completing our online registration today.

- Go to <http://my.garmin.com>.
- Keep the original sales receipt, or a photocopy, in a safe place.

Installing Batteries

The handheld device operates on two AA batteries (not included). Use NiMH or lithium batteries for best results.

- 1 Turn the D-ring counter-clockwise, and pull up to remove the cover.
- 2 Insert two AA batteries, observing polarity.





- 3 Replace the battery cover, and turn the D-ring clockwise.
- 4 Hold .
- 5 Select **Setup > System > Battery Type**.
- 6 Select **Alkaline, Lithium, or Rechargeable NiMH**.

Charging the Dog Collar Device

NOTICE

To prevent corrosion, thoroughly dry the contacts on the collar and the surrounding area before connecting the charging clip.

You should fully charge the battery before you use the device for the first time. Charging a fully depleted battery takes about five hours. The device will not charge when outside the temperature range of 32° to 113°F (0° to 45°C).

- 1 Snap the charging clip  onto the device .



- 2 Plug the power cable into a power source.

The status LED is solid red when the collar is charging.

- 3 After the status LED turns solid green, remove the charging clip from the collar.

Turning On the Devices

- On the handheld device, hold the power key until the LCD display turns on.
- On the dog collar device, hold the power key until the status LED flashes and the collar beeps.

Acquiring Satellite Signals

Both the collar and handheld device must acquire satellite signals before you put the collar on your dog. Acquiring satellites can take a few minutes.

- 1 Go outdoors to an open area.
- 2 Turn on both devices (page 5).
- 3 Select the power key on the handheld device.

 shows the GPS signal strength.

When the collar has acquired satellite signals, the status LED flashes a double-blink or triple-blink in green.

Adding a Dog

The handheld device can track up to 10 dogs with dog collar devices. If you purchase additional dog collar devices, you can link them to the handheld device. To link, the handheld device must be close enough to the dog collar device to touch it, or you must know the dog collar device ID number.



- 1 Select **DOG**.
- 2 Select **Add Dog**.
- 3 Follow the on-screen instructions.

By default, the new dog is named “Dog” and an ID number is randomly assigned.

An error message could appear if there is a conflict with the ID number of another dog.

Status Information

Satellite signal and battery status information is provided on the main menu and when you select .

	Indicates the satellite signal strength.
	Indicates the remaining battery power.
	Blinks when the device detects a signal (for example, a dog collar device) on the channel it is receiving.

Adjusting the Backlight Brightness

NOTE: The backlight brightness may be limited when the remaining capacity in the batteries is low.

Extensive use of screen backlighting can significantly reduce battery life.

- 1 Select .
- 2 Use the rocker to adjust the brightness levels.

TIP: You can also select  to cycle through the brightness levels.

- 3 Select **ENTER** to select a brightness level and close the menu.

Fitting the Collar on Your Dog

Before you put the collar on the dog, pair the handheld device and collar (page 6), and acquire satellite signals (page 6).

- 1 Position the collar with the VHF whip antenna pointing up, the GPS antenna facing up, and the LEDs facing forward.
- 2 Place the collar around the middle of the dog's neck.
- 3 Tighten the strap so it is snug around the dog's neck.

NOTE: The collar should fit tightly and should not be able to rotate or slide on the dog's neck. The dog must be able to swallow food and water normally. You should observe your dog's behavior to verify that the collar is not too tight.

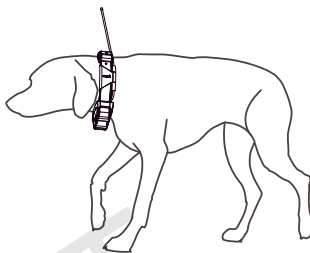

- 4 If the strap is too long, cut off the excess, leaving at least 3 inches (7.62 cm) to spare.

Marking Your Vehicle Location

You can mark the location of your vehicle so you can navigate back to your vehicle after a hunt.

- 1 From the main menu, select **Start New Hunt**.
- 2 Follow the on-screen instructions.

Communication with the Collar

The handheld device and dog collar device use radio signals to communicate. Objects in the path of radio signals degrade the quality of the signals. Keeping an unobstructed line of sight

between your handheld device and your dog's dog collar device produces the best communication signal. Obstructed radio waves result in a poor signal. To achieve the best line-of-sight conditions, you should move to the highest elevation point in your area (for example, on the top of a hill).

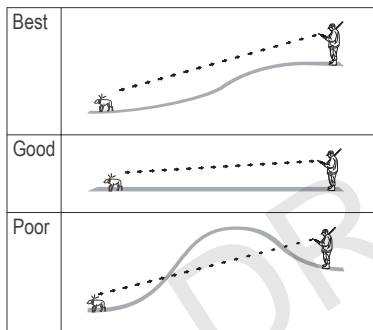

Calibrating the Compass

NOTE: You must calibrate the electronic compass outdoors. Do not stand near objects that influence magnetic fields, such as cars, buildings, or overhead power lines.

The device has a 3-axis electronic compass. You should calibrate the compass after moving long distances, experiencing temperature changes, or changing the batteries.

- 1 Select **DOG > MENU**.
- 2 Select **Calibrate Compass > Start**.
- 3 Follow the on-screen instructions.

Garmin BaseCamp™ BaseStation

To get the most from your Garmin device, you can download BaseCamp software. Go to www.garmin.com/basecamp. You can view and organize your maps, waypoints, routes, and tracks and send them to your device. You can also use the BaseStation feature to view the location of your dogs on your computer in real time.

Tips

- Turn on the dog collar device and allow it to acquire satellites before you put the dog collar device on your dog. This allows the dog collar device to acquire satellite signals much faster.
- Bring extra AA batteries for your handheld device.

- Use a fully charged dog collar device. A fully charged dog collar device operates for approximately 21 hours when using five-second interval reporting.
- Use line-of-sight radio communication (page 7).
- From the dog tracking page, select **MENU > Small Numbers** to reduce the text size.
This allows you to view more dogs at one time on the dog tracking page.

Optional Accessories

Optional accessories, such as mounts, maps, fitness accessories, and replacement parts, are available at <http://buy.garmin.com> or from your Garmin dealer.

Troubleshooting

My handheld device is not responding

If your handheld device stops responding, you can reset the device.

NOTE: This does not erase any of your data or settings.

- 1** Remove the batteries.

- 2** Reinstall the batteries (page 4).

My dog collar devices have conflicting IDs

Each dog you track has its own ID number. If two dogs within range of the handheld device have the same ID, the handheld device warns you of a conflicting ID signal. Follow the on-screen instructions to resolve the conflict.

When possible, you should allow the handheld device to automatically assign IDs. If necessary, you can manually assign a new ID number to a dog.

Contacting Garmin Product Support

- Go to www.garmin.com/support and click **Contact Support** for in-country support information.
- In the USA, call (913) 397.8200 or (800) 800.1020.
- In the UK, call 0808 2380000.
- In Europe, call +44 (0) 870.8501241.

DRAFT

DRAFT

www.garmin.com/support



913-397-8200
1-800-800-1020



0808 238 0000
+44 870 850 1242



1-866-429-9296



+43 (0) 820 220 230



+32 2 672 52 54



+45 4810 5050



+358 9 6937 9758



+ 331 55 69 33 99



+49 (0)180 6 427646



+ 39 02 36 699699



0800 - 023 3937
035 - 539 3727



+ 47 815 69 555



00800 4412 454
+44 2380 662 915



+ 35 1214 447 460



+ 34 93 275 44 97



+ 46 7744 52020

Garmin International, Inc.
1200 East 151st Street
Olathe, Kansas 66062, USA

Garmin (Europe) Ltd.
Liberty House, Hounsdown Business Park
Southampton, Hampshire, SO40 9LR UK

Garmin Corporation
No. 68, Zhongshu 2nd Road, Xizhi Dist.
New Taipei City, 221, Taiwan (R.O.C.)

Garmin®, the Garmin logo, and Astro® are trademarks of Garmin Ltd. or its subsidiaries, registered in the USA and other countries. ANT+™, BaseCamp™, and DC™ are trademarks of Garmin Ltd. or its subsidiaries. These trademarks may not be used without the express permission of Garmin.

microSD™ and the microSD logo are trademarks of SD-3C, LLC.

Other trademarks and trade names are those of their respective owners.



Part Information

GPN:	190-01628-01
Description:	Astro 320 with DC50 Quick Start Manual
Part Type:	Manuals / Printed Literature
Lifecycle Phase:	Experimental
Rev:	1 IR#047242

Item Attribution

Document Review Required:	
Item Notes:	
Preferred Rating:	
ESD Sensitive:	
Moisture Sensitive:	
Limited Shelf Life:	
Magnetic Sensitive:	

Federal Communication Commission Interference Statement

This equipment has been tested and found to comply with the limits for a Class B digital device, pursuant to Part 15 of the FCC Rules. These limits are designed to provide reasonable protection against harmful interference in a residential installation.

This equipment generates, uses and can radiate radio frequency energy and, if not installed and used in accordance with the instructions, may cause harmful interference to radio communications. However, there is no guarantee that interference will not occur in a particular installation. If this equipment does cause harmful interference to radio or television reception, which can be determined by turning the equipment off and on, the user is encouraged to try to correct the interference by one of the following measures:

- . Reorient or relocate the receiving antenna.
- . Increase the separation between the equipment and receiver.
- . Connect the equipment into an outlet on a circuit different from that to which the receiver is connected.
- . Consult the dealer or an experienced radio/TV technician for help.

FCC Caution: To assure continued compliance, any changes or modifications not expressly approved by the party responsible for compliance could void the user's authority to operate this equipment. (Example - use only shielded interface cables when connecting to computer or peripheral devices).

This device complies with Part 15 of the FCC Rules. Operation is subject to the following two conditions:

(1) This device may not cause harmful interference, and (2) This device must accept any interference received, including interference that may cause undesired operation.