

GARMIN®

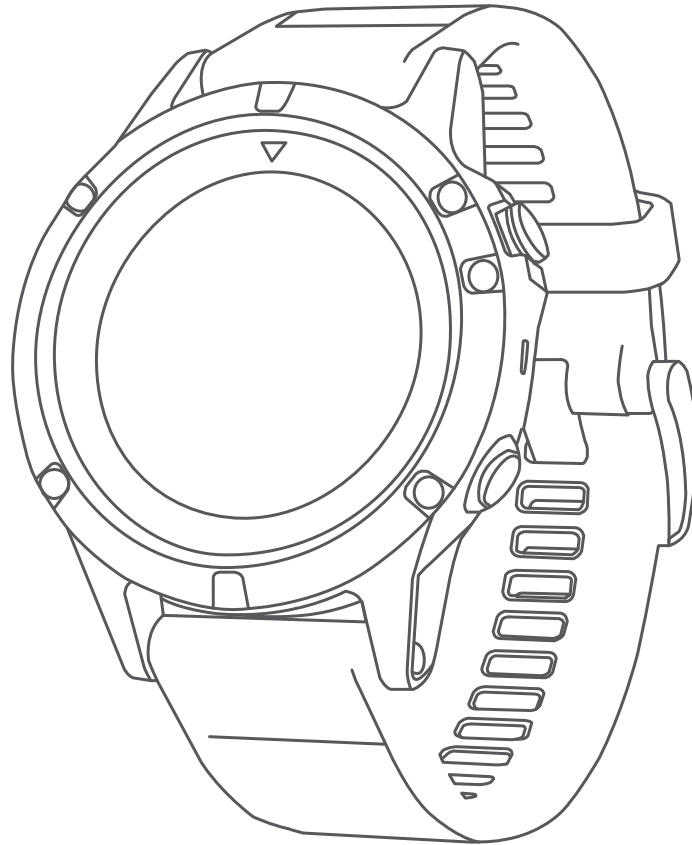

FENIX® 5/5S

Owner's Manual

AA311900

AA311910

© 2016 Garmin Ltd. or its subsidiaries

All rights reserved. Under the copyright laws, this manual may not be copied, in whole or in part, without the written consent of Garmin. Garmin reserves the right to change or improve its products and to make changes in the content of this manual without obligation to notify any person or organization of such changes or improvements. Go to www.garmin.com for current updates and supplemental information concerning the use of this product.

Garmin®, the Garmin logo, ANT+®, Auto Lap®, Auto Pause®, Edge®, fēnix®, TracBack®, VIRB®, and Virtual Partner® are trademarks of Garmin Ltd. or its subsidiaries, registered in the USA and other countries. Connect IQ™, Garmin Connect™, Garmin Express™, Garmin Move IQ™, HRM-Run™, HRM-Swim™, HRM-Tri™, QuickFit™, tempe™, TruSwing™, Varia™, Varia Vision™, and Vector™ are trademarks of Garmin Ltd. or its subsidiaries. These trademarks may not be used without the express permission of Garmin.

American Heart Association® is a registered trademark of American Heart Association, Inc. Android™ is a trademark of Google Inc. Apple® and Mac® are trademarks of Apple Inc., registered in the U.S. and other countries. The Bluetooth® word mark and logos are owned by the Bluetooth SIG, Inc. and any use of such marks by Garmin is under license. The Cooper Institute®, as well as any related trademarks, are the property of The Cooper Institute. Di2™ is a trademark of Shimano, Inc. Shimano® is a registered trademark of Shimano, Inc. Advanced heartbeat analytics by Firstbeat. Training Stress Score™ (TSS), Intensity Factor™ (IF), and Normalized Power™ (NP) are trademarks of Peaksware, LLC. Wi-Fi® is a registered mark of Wi-Fi Alliance Corporation. Windows® is a registered trademark of Microsoft Corporation in the United States and other countries. Other trademarks and trade names are those of their respective owners.

This product may contain a library (Kiss FFT) licensed by Mark Borgerding under the 3-Clause BSD License (<http://opensource.org/licenses/BSD-3-Clause>).

This product is ANT+® certified. Visit www.thisisant.com/directory for a list of compatible products and apps.

Table of Contents

Introduction	1	Recovery Time.....	8
Device Overview.....	1	Viewing Your Recovery Time.....	9
Viewing the Controls Menu.....	1	Training Load.....	9
Viewing Widgets.....	1	Viewing Your Predicted Race Times.....	9
Charging the Device.....	1	Heart Rate Variability and Stress Level.....	9
Pairing Your Smartphone with Your Device.....	1	Viewing Your Heart Rate Variability and Stress Level.....	9
Product Updates.....	1	Performance Condition.....	9
Setting Up Garmin Express.....	2	Viewing Your Performance Condition.....	9
Activities	2	Getting Your FTP Estimate.....	9
Starting an Activity.....	2	Conducting an FTP Test.....	9
Tips for Recording Activities.....	2	Lactate Threshold.....	10
Stopping an Activity.....	2	Performing a Guided Test to Determine Your Lactate	
Creating a Custom Activity.....	2	Threshold.....	10
Indoor Activities.....	2	Recovery Heart Rate.....	10
Outdoor Activities.....	2	About Training Effect.....	10
Viewing Your Ski Runs.....	2	Training	10
Using the Metronome.....	2	Setting Up Your User Profile.....	10
Jumpmaster.....	3	Fitness Goals.....	10
Multisport.....	3	About Heart Rate Zones.....	11
Creating a Multisport Activity.....	3	Setting Your Heart Rate Zones.....	11
Tips for Triathlon Training or Using Multisport Activities.....	3	Letting the Device Set Your Heart Rate Zones.....	11
Swimming.....	3	Heart Rate Zone Calculations.....	11
Swim Terminology.....	3	About Lifetime Athletes.....	11
Stroke Types.....	3	Setting Your Power Zones.....	11
Tips for Swimming Activities.....	3	Activity Tracking.....	11
Resting During Pool Swimming.....	3	Auto Goal.....	11
Training with the Drill Log.....	3	Using the Move Alert.....	12
Golfing.....	4	Sleep Tracking.....	12
Playing Golf.....	4	Using Automated Sleep Tracking.....	12
Hole Information.....	4	Using Do Not Disturb Mode.....	12
Moving the Flag.....	4	Intensity Minutes.....	12
Measuring a Shot.....	4	Earning Intensity Minutes.....	12
Viewing Layup and Dogleg Distances.....	4	Garmin Move IQ™ Events.....	12
Keeping Score.....	4	Activity Tracking Settings.....	12
Updating a Score.....	4	Turning Off Activity Tracking.....	12
TruSwing™.....	4	Workouts.....	12
Using the Golf Odometer.....	4	Following a Workout From the Web.....	12
Tracking Statistics.....	4	Starting a Workout.....	12
Heart Rate Features	4	About the Training Calendar.....	13
Wrist-based Heart Rate.....	4	Using Garmin Connect Training Plans.....	13
Wearing the Device and Heart Rate.....	4	Interval Workouts.....	13
Tips for Erratic Heart Rate Data.....	5	Creating an Interval Workout.....	13
Viewing the Heart Rate Widget.....	5	Starting an Interval Workout.....	13
Broadcasting Heart Rate Data to Garmin Devices.....	5	Stopping an Interval Workout.....	13
Turning Off the Wrist Heart Rate Monitor.....	5	Segments.....	13
Putting On the Heart Rate Monitor.....	5	Using Virtual Partner®.....	13
Pool Swimming.....	5	Setting a Training Target.....	13
Heart Rate While Swimming.....	5	Cancelling a Training Target.....	13
Data Storage.....	6	Racing a Previous Activity.....	14
Tips for Erratic Heart Rate Data.....	6	Personal Records.....	14
Caring for the Heart Rate Monitor.....	6	Viewing Your Personal Records.....	14
Running Dynamics.....	6	Restoring a Personal Record.....	14
Training with Running Dynamics.....	6	Clearing a Personal Record.....	14
Color Gauges and Running Dynamics Data.....	6	Clearing All Personal Records.....	14
Ground Contact Time Balance Data.....	7	Clock	14
Tips for Missing Running Dynamics Data.....	7	Setting an Alarm.....	14
Performance Measurements.....	7	Starting the Countdown Timer.....	14
Turning On Performance Notifications.....	7	Using the Stopwatch.....	14
Automatically Detecting Performance Measurements.....	8	Setting Sunrise and Sunset Alerts.....	14
Training Status.....	8	Syncing the Time with GPS.....	14
About VO2 Max. Estimates.....	8	Navigation	15
Getting Your VO2 Max. Estimate for Running.....	8	Saving Your Location.....	15
Getting Your VO2 Max. Estimate for Cycling.....	8	Editing Your Saved Locations.....	15
		Deleting All Saved Locations.....	15
		Projecting a Waypoint.....	15

Navigating to a Destination	15	Barometer Settings	22
Creating and Following a Course on Your Device	15	Map Settings	22
Marking and Starting Navigation to a Man Overboard		Navigation Settings	22
Location	15	Customizing Map Features	22
Navigating with Sight 'N Go	15	Heading Settings	22
Navigating to Your Starting Point	15	Course Pointer	22
Stopping Navigation	15	Setting Up a Heading Bug	23
Map	15	Setting Navigation Alerts	23
Panning and Zooming the Map	15	System Settings	23
Compass	16	Time Settings	23
Altimeter and Barometer	16	Backlight Settings	23
History	16	Customizing the Controls Menu	23
Using History	16	Customizing the Hot Keys	23
Multisport History	16	Changing the Units of Measure	23
Viewing Your Time in Each Heart Rate Zone	16	Viewing Device Information	23
Viewing Data Totals	16	Viewing Regulatory and Compliance Information	23
Using the Odometer	16	ANT+ Sensors	24
Deleting History	16	Pairing ANT+ Sensors	24
Connected Features	16	Using an Optional Bike Speed or Cadence Sensor	24
Enabling Bluetooth Notifications	16	Training with Power Meters	24
Viewing Notifications	17	Using Electronic Shifters	24
Managing Notifications	17	Situational Awareness	24
Turning Off Bluetooth Technology	17	Foot Pod	24
Turning On and Off Bluetooth Connection Alerts	17	Improving Foot Pod Calibration	24
Locating a Lost Mobile Device	17	Calibrating Your Foot Pod Manually	24
Garmin Connect	17	Setting Foot Pod Speed and Distance	24
Updating the Software Using Garmin Connect Mobile	17	tempe	25
Updating the Software Using Garmin Express	17	Device Information	25
Using Garmin Connect on Your Computer	17	fenix 5/5S Specifications	25
Manually Syncing Data with Garmin Connect Mobile	17	Battery Information	25
Wi-Fi® Connected Features	18	HRM-Tri Specifications	25
Setting Up Wi-Fi Connectivity	18	Data Management	25
Connect IQ Features	18	Disconnecting the USB Cable	25
Downloading Connect IQ Features	18	Deleting Files	25
Downloading Connect IQ Features Using Your Computer	18	Device Maintenance	25
Customizing Your Device	18	Device Care	25
Widgets	18	Cleaning the Device	25
Customizing the Widget Loop	18	Cleaning the Leather Bands	25
VIRB Remote	18	Changing the QuickFit™ Bands	26
Controlling a VIRB Action Camera	19	Metal Watch Band Adjustment	26
Controlling a VIRB Action Camera During an Activity	19	Replacing the Heart Rate Monitor Battery	26
Activities and App Settings	19	Troubleshooting	26
Customizing the Data Screens	19	My device is in the wrong language	26
Adding a Map to an Activity	20	Is my smartphone compatible with my device?	26
Alerts	20	My phone will not connect to the device	26
Setting an Alert	20	Resetting Your Device	26
Auto Lap	20	Restoring All Default Settings	26
Marking Laps by Distance	20	Acquiring Satellite Signals	26
Enabling Auto Pause®	20	Improving GPS Satellite Reception	26
Enabling Auto Climb	21	The temperature reading is not accurate	27
3D Speed and Distance	21	Maximizing the Battery Life	27
Turning On and Off the Lap Key	21	Activity Tracking	27
Using Auto Scroll	21	My daily step count does not appear	27
UltraTrac	21	My step count does not seem accurate	27
Power Save Timeout Settings	21	The step counts on my device and my Garmin Connect	
Removing an Activity or App	21	account don't match	27
Changing the Order of an Activity in the Apps List	21	The floors climbed amount does not seem accurate	27
Watch Face Settings	21	My intensity minutes are flashing	27
Customizing the Watch Face	21	Getting More Information	27
Sensors Settings	22	Appendix	27
Compass Settings	22	Data Fields	27
Calibrating the Compass Manually	22	VO2 Max. Standard Ratings	31
Setting the North Reference	22	FTP Ratings	31
Altimeter Settings	22	Wheel Size and Circumference	31
Calibrating the Barometric Altimeter	22		

BSD 3-Clause License.....	32
Symbol Definitions	32
Index.....	33

Introduction

⚠ WARNING

See the *Important Safety and Product Information* guide in the product box for product warnings and other important information.

Always consult your physician before you begin or modify any exercise program.

Device Overview

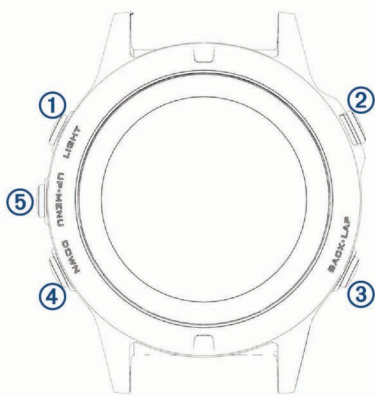

① LIGHT	Select to turn the backlight on and off. Hold to view the controls menu. Hold to turn the device on.
② ▲	Select to view the activity list and start or stop an activity. Select to choose an option in a menu.
③ BACK LAP	Select to return to the previous screen. Select to record a lap, rest, or transition during an activity.
④ DOWN	Select to scroll through the widget loop and menus. Hold to view the watch face from any screen.
⑤ UP MENU	Select to scroll through the widget loop and menus. Hold to view the menu.

Viewing the Controls Menu

The controls menu contains shortcut menu options, such as turning on do not disturb mode, locking the keys, and turning the device off.

NOTE: You can add, reorder, and remove the shortcut menu options in the controls menu (*Customizing the Controls Menu*, page 23).

1 From any screen, hold **LIGHT**.



2 Select **UP** or **DOWN** to scroll through the options.

Viewing Widgets

Your device comes preloaded with several widgets, and more are available when you pair your device with a smartphone.

- Select **UP** or **DOWN**.
The device scrolls through the widget loop.
- Select ▲ to view additional options and functions for a widget.

- From any screen, hold **DOWN** to return to the watch face.
- If you are recording an activity, select **BACK** to return to the activity data pages.

Charging the Device

⚠ WARNING

This device contains a lithium-ion battery. See the *Important Safety and Product Information* guide in the product box for product warnings and other important information.

NOTICE

To prevent corrosion, thoroughly clean and dry the contacts and the surrounding area before charging or connecting to a computer. Refer to the cleaning instructions in the appendix.

1 Plug the small end of the USB cable into the charging port on your device.



- 2 Plug the large end of the USB cable into a USB port on your computer.
- 3 Charge the device completely.

Pairing Your Smartphone with Your Device

To use the connected features of the fēnix device, it must be paired directly through the Garmin Connect™ Mobile app, instead of from the Bluetooth® settings on your smartphone.

- 1 From the app store on your smartphone, install and open the Garmin Connect Mobile app.
- 2 Bring your smartphone within 10 m (33 ft.) of your device.
- 3 Hold **LIGHT** to turn on the device.

The first time you turn on the device, it is in pairing mode.

TIP: You can hold **LIGHT** and select ⌘ to manually enter pairing mode.

- 4 Select an option to add your device to your Garmin Connect account:
 - If this is the first time you are pairing a device with the Garmin Connect Mobile app, follow the on-screen instructions.
 - If you already paired another device with the Garmin Connect Mobile app, from the settings menu, select **Garmin Devices > Add Device**, and follow the on-screen instructions.

Product Updates

On your computer, install Garmin Express™ (www.garmin.com/express). On your smartphone, install the Garmin Connect Mobile app.

This provides easy access to these services for Garmin® devices:

- Software updates
- Data uploads to Garmin Connect
- Product registration

Setting Up Garmin Express

- 1 Connect the device to your computer using a USB cable.
- 2 Go to www.garmin.com/express.
- 3 Follow the on-screen instructions.

Activities



Your device can be used for indoor, outdoor, athletic, and fitness activities. When you start an activity, the device displays and records sensor data. You can save activities and share them with the Garmin Connect community.

You can also add Connect IQ™ activity apps to your device using your Garmin Connect account ([Connect IQ Features](#), page 18).

For more information about activity tracking and fitness metric accuracy, go to garmin.com/ataccuracy.

Starting an Activity

When you start an activity, GPS turns on automatically (if required). When you stop the activity, the device returns to watch mode.

- 1 From the watch face, select .
- 2 Select an activity.
- 3 If necessary, follow the on-screen instructions to enter additional information.
- 4 If necessary, wait while the device connects to your ANT+® sensors.
- 5 If the activity requires GPS, go outside, and wait while the device locates satellites.
- 6 Select  to start the timer.

NOTE: The device does not record your activity data until you start the timer.

Tips for Recording Activities

- Charge the device before starting an activity ([Charging the Device](#), page 1).
- Select **LAP** to record laps.
- Select **UP** or **DOWN** to view additional data pages.

Stopping an Activity

- 1 Select .
- 2 Select an option:
 - To resume your activity, select **Resume**.
 - To save the activity and return to watch mode, select **Save**.
 - To suspend your activity and resume it at a later time, select **Resume Later**.
 - To mark a lap, select **Lap**.
 - To navigate back to the starting point of your activity along the path you traveled, select **Back to Start > TracBack**.

NOTE: This feature is available only for activities that use GPS.

- To navigate back to the starting point of your activity, select **Back to Start > Straight Line**.

NOTE: This feature is available only for activities that use GPS.

- To discard the activity and return to watch mode, select **Discard**.

NOTE: After stopping the activity, the device saves it automatically after 25 minutes.

Creating a Custom Activity

- 1 From the watch face, select  > **Add**.

- 2 Select an option:

- Select **Copy Activity** to create your custom activity starting from one of your saved activities.
- Select **Other** to create a new custom activity.

- 3 If necessary, select an activity type.

- 4 Select a name or enter a custom name.

Duplicate activity names include a number, for example: Bike(2).

- 5 Select an option:

- Select an option to customize specific activity settings. For example, you can select an accent color or customize the data screens.
- Select **Done** to save and use the custom activity.

- 6 Select **Yes** to add the activity to your list of favorites.

Indoor Activities

The fēnix device can be used for training indoors, such as running on an indoor track or using a stationary bike. GPS is turned off for indoor activities.

When running or walking with GPS turned off, speed, distance, and cadence are calculated using the accelerometer in the device. The accelerometer is self-calibrating. The accuracy of the speed, distance, and cadence data improves after a few outdoor runs or walks using GPS.

TIP: Holding the handrails of the treadmill reduces accuracy. You can use an optional foot pod to record pace, distance, and cadence.

When cycling with GPS turned off, speed and distance are not available unless you have an optional sensor that sends speed and distance data to the device (such as a speed or cadence sensor).

Outdoor Activities

The fēnix device comes preloaded with apps for outdoor activities, such as running, hiking, and open water swimming. GPS is turned on for outdoor activities. You can add apps using default profiles, such as walking and tactical. You can also add custom sport apps to your device ([Creating a Custom Activity](#), page 2).

Viewing Your Ski Runs

Your device records the details of each skiing or snowboarding run using the auto run feature. This feature is turned on by default for downhill skiing and snowboarding. It automatically records new ski runs based on your movement. The timer pauses when you stop moving downhill and when you are on a chairlift. The timer remains paused during the chairlift ride. You can start moving downhill to restart the timer. You can view run details from the paused screen or while the timer is running.

- 1 Start a skiing or snowboarding activity.
- 2 Hold **MENU**.
- 3 Select **View Runs**.
- 4 Select **UP** and **DOWN** to view details of your last run, your current run, and your total runs.

The run screens include time, distance traveled, maximum speed, average speed, and total descent.

Using the Metronome

The metronome feature plays tones at a steady rhythm to help you improve your performance by training at a faster, slower, or more consistent cadence.

NOTE: This feature is not available for all activities.

- 1 Hold **MENU**.
- 2 Select **Settings > Activities & Apps**.
- 3 Select an activity.

- 4 Select the activity settings.
- 5 Select **Metronome > Status > On**.
- 6 Select an option:
 - Select **Beats / Minute** to enter a value based on the cadence you want to maintain.
 - Select **Alert Frequency** to customize the frequency of the beats.
 - Select **Sounds** to customize the metronome tone and vibration.
- 7 If necessary, select **Preview** to listen to the metronome feature before you run.
- 8 Hold **DOWN** to return to the clock.
- 9 Go for a run (*Starting an Activity, page 2*).
The metronome starts automatically.
- 10 During your run, select **UP** or **DOWN** to view the metronome screen.
- 11 If necessary, hold **MENU** to change the metronome settings.

Jumpmaster

⚠ WARNING

The jumpmaster feature is for use by experienced skydivers only. The jumpmaster feature should not be used as a primary skydiving altimeter. Failure to input the appropriate jump related information can lead to serious personal injury or death.

The jumpmaster feature follows military guidelines for calculating the high altitude release point (HARP). The device detects automatically when you have jumped to begin navigating toward the desired impact point (DIP) using the barometer and electronic compass.

Multisport

Triathletes, duathletes, and other multisport competitors can take advantage of the multisport activities, such as Triathlon or Swimrun. During a multisport activity, you can transition between activities and continue to view your total time and distance. For example, you can switch from biking to running and view your total time and distance for biking and running throughout the multisport activity.

You can customize a multisport activity, or you can use the default triathlon activity set up for a standard triathlon.

Creating a Multisport Activity

- 1 From the watch face, select **(▲) > Add > Multisport**.
- 2 Select a multisport activity type, or enter a custom name.
Duplicate activity names include a number, for example: Triathlon(2).
- 3 Select two or more activity profiles.
- 4 Select an option:
 - Select an option to customize specific activity settings. For example, you can select whether to include transitions.
 - Select **Done** to save and use the multisport activity.
- 5 Select **Yes** to add the activity to your list of favorites.

Tips for Triathlon Training or Using Multisport Activities

- Select **(▲)** to start your first activity.
- Select **LAP** to transition to the next activity.
If transitions are turned on, the transition time is recorded separately from the activity times.
- If necessary, select **LAP** to start the next activity.
- Select **UP** or **DOWN** to view additional data pages.

Swimming

NOTICE

The device is intended for surface swimming. Scuba diving with the device may damage the product and will void the warranty.

NOTE: The device cannot record heart rate data while swimming.

NOTE: The device is compatible with the HRM-Tri™ accessory and the HRM-Swim™ accessory (*Heart Rate While Swimming, page 5*).

Swim Terminology

Length: One trip down the pool.

Interval: One or more consecutive lengths. A new interval starts after a rest.

Stroke: A stroke is counted every time your arm wearing the device completes a full cycle.

Swolf: Your swolf score is the sum of the time for one pool length and the number of strokes for that length. For example, 30 seconds plus 15 strokes equals a swolf score of 45. For open water swimming, swolf is calculated over 25 meters. Swolf is a measurement of swimming efficiency and, like golf, a lower score is better.

Stroke Types

Stroke type identification is available only for pool swimming. Your stroke type is identified at the end of a length. Stroke types appear when you are viewing interval history. You can also select stroke type as a custom data field (*Customizing the Data Screens, page 19*).

Free	Freestyle
Back	Backstroke
Breast	Breaststroke
Fly	Butterfly
Mixed	More than one stroke type in an interval
Drill	Used with drill logging (<i>Training with the Drill Log, page 3</i>)

Tips for Swimming Activities

- Before starting a pool swimming activity, follow the on-screen instructions to select your pool size or enter a custom size.
- Select **LAP** to record a rest during pool swimming.
The device automatically records swim intervals and lengths for pool swimming.
- Select **LAP** to record an interval during open water swimming.

Resting During Pool Swimming

The default rest screen displays two rest timers. It also displays time and distance for the last completed interval.

NOTE: Swim data is not recorded during a rest.

- 1 During your swim activity, select **LAP** to start a rest.
The display reverses to white text on a black background, and the rest screen appears.
- 2 During a rest, select **UP** or **DOWN** to view other data screens (optional).
- 3 Select **LAP**, and continue swimming.
- 4 Repeat for additional rest intervals.

Training with the Drill Log

The drill log feature is available only for pool swimming. You can use the drill log feature to manually record kick sets, one-arm swimming, or any type of swimming that is not one of the four major strokes.

- 1 During your pool swim activity, select **UP** or **DOWN** to view the drill log screen.
- 2 Select **LAP** to start the drill timer.

- After you complete a drill interval, select **LAP**.
The drill timer stops, but the activity timer continues to record the entire swim session.
- Select a distance for the completed drill.
Distance increments are based on the pool size selected for the activity profile.
- Select an option:
 - To start another drill interval, select **LAP**.
 - To start a swim interval, select **UP** or **DOWN** to return to the swim training screens.

Golfing

Playing Golf

Before you play a course for the first time, you must download it from the Garmin Connect Mobile app ([Garmin Connect, page 17](#)). Courses downloaded from the Garmin Connect Mobile app are updated automatically.

Before you play golf, you should charge the device ([Charging the Device, page 1](#)).

- From the watch face, select **▲** > **Golf**.
- Go outside, and wait while the device locates satellites.
- Select a course from the list of available courses.
- Select **Yes** to keep score.
- Select **UP** or **DOWN** to scroll through the holes.
The device automatically transitions when you move to the next hole.
- After you complete your activity, select **▲** > **End Round** > **Yes**.

Hole Information

Because pin locations change, the device calculates the distance to the front, middle, and back of the green, but not the actual pin location.

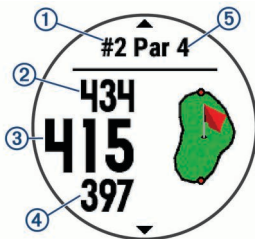

①	Current hole number
②	Distance to the back of the green
③	Distance to the middle of the green
④	Distance to the front of the green
⑤	Par for the hole
▲	Next hole
▼	Previous hole

Moving the Flag

You can take a closer look at the green and move the pin location.

- From the hole information screen, select **▲** > **Move Flag**.
- Select **UP** or **DOWN** to move the pin position.
- Select **▲**.
The distances on the hole information screen are updated to show the new pin location. The pin location is saved for only the current round.

Measuring a Shot

- Take a shot, and watch where your ball lands.

- Select **▲** > **Measure Shot**.
- Walk or drive to your ball.
The distance automatically resets when you move to the next hole.
- If necessary, select **Reset** to reset the distance at any time.

Viewing Layup and Dogleg Distances

You can view a list of layup and dogleg distances for par 4 and 5 holes.

Select **▲** > **Layups**.

Each layup and the distance until you reach each layup appear on the screen.

NOTE: Distances are removed from the list as you pass them.

Keeping Score

- From the hole information screen, select **▲** > **Scorecard**.
The scorecard appears when you are on the green.
- Select **UP** or **DOWN** to scroll through the holes.
- Select **▲** to select a hole.
- Select **UP** or **DOWN** to set the score.
Your total score is updated.

Updating a Score

- From the hole information screen, select **▲** > **Scorecard**.
- Select **UP** or **DOWN** to scroll through the holes.
- Select **▲** to select a hole.
- Select **UP** or **DOWN** to change the score for that hole.
Your total score is updated.

TruSwing™

The TruSwing feature allows you to view swing metrics recorded from your TruSwing device. Go to www.garmin.com/golf to purchase a TruSwing device.

Using the Golf Odometer

You can use the odometer to record the time, distance, and steps traveled. The odometer automatically starts and stops when you start or end a round.

- Select **▲** > **Odometer**.
- If necessary, select **Reset** to reset the odometer to zero.

Tracking Statistics

The Stat Tracking feature enables detailed statistics tracking while playing golf.

- From the hole information screen, hold **MENU**.
- Select **Options** > **Stat Tracking** to enable tracking statistics.

Heart Rate Features

The fēnix 5/5S device has a wrist-based heart rate monitor and is also compatible with ANT+ and Bluetooth chest heart rate monitors (sold separately). You can view wrist-based heart rate data on the heart rate widget. If both wrist-based heart rate and chest heart rate data are available, your device uses the chest heart rate data.

Wrist-based Heart Rate

Wearing the Device and Heart Rate

- Wear the fēnix 5/5S device above your wrist bone.

NOTE: The device should be snug but comfortable, and it should not move while running or exercising.

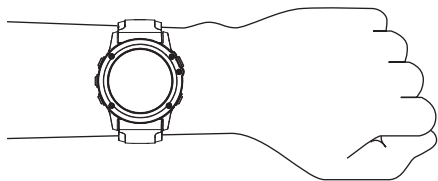

NOTE: The heart rate sensor is located on the back of the device.

- See [Tips for Erratic Heart Rate Data](#), page 5 for more information about wrist-based heart rate.
- For more information about the accuracy of wrist-based heart rate, go to garmin.com/ataccuracy.

Tips for Erratic Heart Rate Data

If the heart rate data is erratic or does not appear, you can try these tips.

- Clean and dry your arm before putting on the device.
- Avoid wearing sunscreen, lotion, and insect repellent under the device.
- Avoid scratching the heart rate sensor on the back of the device.
- Wear the device above your wrist bone. The device should be snug but comfortable.
- Wait until the ♥ icon is solid before starting your activity.
- Warm up for 5 to 10 minutes and get a heart rate reading before starting your activity.

NOTE: In cold environments, warm up indoors.

- Rinse the device with fresh water after each workout.
- While exercising, use a silicone band.

Viewing the Heart Rate Widget

The widget displays your current heart rate in beats per minute (bpm), your resting heart rate for today, and a graph of your heart rate for the last 4 hours.

- 1 From the watch face, select **DOWN**.
- 2 Select ▲ to view your average resting heart rate values for the last 7 days.

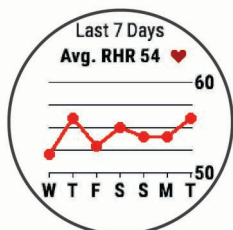

Broadcasting Heart Rate Data to Garmin Devices

You can broadcast your heart rate data from your fēnix 5/5S device and view it on paired Garmin devices. For example, you can broadcast your heart rate data to an Edge® device while cycling, or to a VIRB® action camera during an activity.

NOTE: Broadcasting heart rate data decreases battery life.

- 1 From the heart rate widget, hold **MENU**.
- 2 Select **Options**.
- 3 Select an option:
 - Select **Broadcast Heart Rate** to start broadcasting heart rate data now.
 - Select **Broadcast During Activity** to broadcast heart rate during timed activities ([Starting an Activity](#), page 2).

The fēnix 5/5S device starts broadcasting your heart rate data, and ♥ appears.

NOTE: You can view only the heart rate widget while broadcasting heart rate data.

- 4 Pair your fēnix 5/5S device with your Garmin ANT+ compatible device.

NOTE: The pairing instructions differ for each Garmin compatible device. See your owner's manual.

TIP: To stop broadcasting your heart rate data, select any key, and select Yes.

Turning Off the Wrist Heart Rate Monitor

The default value for the Wrist Heart Rate setting is Auto. The device automatically uses the wrist-based heart rate monitor unless you pair an ANT+ heart rate monitor to the device.

- 1 From the heart rate widget, hold **MENU**.
- 2 Select **Options > Status > Off**.

Putting On the Heart Rate Monitor

You should wear the heart rate monitor directly on your skin, just below your sternum. It should be snug enough to stay in place during your activity.

- 1 If necessary, attach the strap extender to the heart rate monitor.
- 2 Wet the electrodes ① on the back of the heart rate monitor to create a strong connection between your chest and the transmitter.



- 3 Wear the heart rate monitor with the Garmin logo facing right-side up.

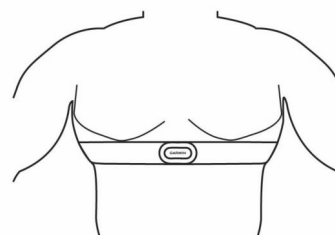

The loop ② and hook ③ connection should be on your right side.

- 4 Wrap the heart rate monitor around your chest, and connect the strap hook to the loop.

NOTE: Make sure the care tag does not fold over.

After you put on the heart rate monitor, it is active and sending data.

Pool Swimming

NOTICE

Hand wash the heart rate monitor after exposure to chlorine or other pool chemicals. Prolonged exposure to these substances can damage the heart rate monitor.

The HRM-Tri accessory is designed primarily for open water swimming, but it can be used occasionally for pool swimming. The heart rate monitor should be worn under a swim suit or triathlon top during pool swimming. Otherwise, it may slide down your chest when pushing off the pool wall.

Heart Rate While Swimming

NOTE: Wrist-based heart rate is not available while swimming.

The HRM-Tri accessory and the HRM-Swim accessory record and store your heart rate data while swimming. Heart rate data

is not visible on compatible fēnix devices while the heart rate monitor is underwater.

You must start a timed activity on your paired fēnix device to view stored heart rate data later. During rest intervals when out of the water, the heart rate monitor sends your heart rate data to your fēnix device.

Your fēnix device automatically downloads stored heart rate data when you save your timed swim activity. Your heart rate monitor must be out of the water, active, and within range of the device (3 m) while data is downloaded. You can review your heart rate data in the device history and on your Garmin Connect account.

Data Storage

The heart rate monitor can store up to 20 hours of data in a single activity. When the heart rate monitor memory is full, your oldest data is overwritten.

You can start a timed activity on your paired fēnix device, and the heart rate monitor records your heart rate data even if you move away from your device. For example, you can record heart rate data during fitness activities or team sports where watches cannot be worn. Your heart rate monitor automatically sends your stored heart rate data to your fēnix device when you save your activity. Your heart rate monitor must be active and within range (3 m) of the device while data is uploaded.

Tips for Erratic Heart Rate Data

If the heart rate data is erratic or does not appear, you can try these tips.

- Reapply water to the electrodes and contact patches (if applicable).
- Tighten the strap on your chest.
- Warm up for 5 to 10 minutes.
- Follow the care instructions ([Caring for the Heart Rate Monitor, page 6](#)).
- Wear a cotton shirt or thoroughly wet both sides of the strap. Synthetic fabrics that rub or flap against the heart rate monitor can create static electricity that interferes with heart rate signals.
- Move away from sources that can interfere with your heart rate monitor.

Sources of interference may include strong electromagnetic fields, some 2.4 GHz wireless sensors, high-voltage power lines, electric motors, ovens, microwave ovens, 2.4 GHz cordless phones, and wireless LAN access points.

Caring for the Heart Rate Monitor

NOTICE

A buildup of sweat and salt on the strap can decrease the ability of the heart rate monitor to report accurate data.

- Rinse the heart rate monitor after every use.
- Hand wash the heart rate monitor after every seven uses or one pool swim, using a tiny amount of mild detergent, such as dishwashing liquid.
NOTE: Using too much detergent may damage the heart rate monitor.
- Do not put the heart rate monitor in a washing machine or dryer.

Color Gauges and Running Dynamics Data

The running dynamics screens display a color gauge for the primary metric. You can display cadence, vertical oscillation, ground contact time, ground contact time balance, or vertical ratio as the primary metric. The color gauge shows you how your running dynamics data compare to those of other runners. The color zones are based on percentiles.

Garmin has researched many runners of all different levels. The data values in the red or orange zones are typical for less experienced or slower runners. The data values in the green, blue, or purple zones are typical for more experienced or faster runners. More experienced runners tend to exhibit shorter ground contact times, lower vertical oscillation, lower vertical ratio, and

- When drying the heart rate monitor, hang it up or lay it flat.

Running Dynamics

You can use your compatible fēnix device paired with the HRM-Tri accessory or other running dynamics accessory to provide real-time feedback about your running form. If your fēnix device was packaged with the HRM-Tri accessory, the devices are already paired.

The running dynamics accessory has an accelerometer that measures torso movement in order to calculate six running metrics.

Cadence: Cadence is the number of steps per minute. It displays the total steps (right and left combined).

Vertical oscillation: Vertical oscillation is your bounce while running. It displays the vertical motion of your torso, measured in centimeters.

Ground contact time: Ground contact time is the amount of time in each step that you spend on the ground while running. It is measured in milliseconds.

NOTE: Ground contact time and balance are not available while walking.

Ground contact time balance: Ground contact time balance displays the left/right balance of your ground contact time while running. It displays a percentage. For example, 53.2 with an arrow pointing left or right.

Stride length: Stride length is the length of your stride from one footfall to the next. It is measured in meters.

Vertical ratio: Vertical ratio is the ratio of vertical oscillation to stride length. It displays a percentage. A lower number typically indicates better running form.

Training with Running Dynamics

Before you can view running dynamics, you must put on a running dynamics accessory, such as the HRM-Tri accessory, and pair it with your device ([Pairing ANT+ Sensors, page 24](#)). If your fēnix 5/5S was packaged with the accessory, the devices are already paired, and the fēnix 5/5S is set to display running dynamics data screens.

- 1 Select an option:
 - If your running dynamics accessory and fēnix 5/5S device are already paired, skip to step 7.
 - If your running dynamics accessory and fēnix 5/5S device are not already paired, complete all the steps in this procedure.
- 2 Hold **MENU**.
- 3 Select **Settings > Activities & Apps**.
- 4 Select an activity.
- 5 Select the activity settings.
- 6 Select **Data Screens > Add New**.
- 7 Select a running dynamics data screen.
NOTE: The running dynamics screens are not available for all activities.
- 8 Go for a run ([Starting an Activity, page 2](#)).
- 9 Select **UP** or **DOWN** to open a running dynamics screen to view your metrics.

higher cadence than less experienced runners. However, taller runners typically have slightly slower cadences, longer strides, and slightly higher vertical oscillation. Vertical ratio is your vertical oscillation divided by stride length. It is not correlated with height.

NOTE: The color gauge for ground contact time balance is different ([Ground Contact Time Balance Data, page 7](#)).

Go to www.garmin.com for more information on running dynamics. For additional theories and interpretations of running dynamics data, you can search reputable running publications and websites.

Color Zone	Percentile in Zone	Cadence Range	Vertical Oscillation Range	Vertical Ratio	Ground Contact Time Range
Purple	>95	>183 spm	<6.4 cm	<6.1%	<218 ms
Blue	70–95	174–183 spm	6.4–8.1 cm	6.1–7.4%	218–248 ms
Green	30–69	164–173 spm	8.2–9.7 cm	7.5–8.6%	249–277 ms
Orange	5–29	153–163 spm	9.8–11.5 cm	8.7–10.1%	278–308 ms
Red	<5	<153 spm	>11.5 cm	>10.1%	>308 ms

Ground Contact Time Balance Data

Ground contact time balance measures your running symmetry and appears as a percentage of your total ground contact time. For example, 51.3% with an arrow pointing left indicates the runner is spending more time on the ground when on the left foot. If your data screen displays both numbers, for example 48–52, 48% is the left foot and 52% is the right foot.

Color Zone	Red	Orange	Green	Orange	Red
Symmetry	Poor	Fair	Good	Fair	Poor
Percent of Other Runners	5%	25%	40%	25%	5%
Ground Contact Time Balance	>52.2% L	50.8–52.2% L	50.7% L–50.7% R	50.8–52.2% R	>52.2% R

While developing and testing running dynamics, the Garmin team found correlations between injuries and greater imbalances with certain runners. For many runners, ground contact time balance tends to deviate further from 50–50 when running up or down hills. Most running coaches agree that a symmetrical running form is good. Elite runners tend to have quick and balanced strides.

You can watch the color gauge or data field during your run or view the summary on your Garmin Connect account after your run. As with the other running dynamics data, ground contact time balance is a quantitative measurement to help you learn about your running form.

Tips for Missing Running Dynamics Data

If running dynamics data does not appear, you can try these tips.

- Make sure you have a running dynamics accessory, such as the HRM-Tri accessory.
Accessories with running dynamics have  on the front of the module.
- Pair the running dynamics accessory with your fēnix device again, according to the instructions.
- If the running dynamics data display shows only zeros, make sure the accessory is worn right-side up.
NOTE: Ground contact time and balance appears only while running. It is not calculated while walking.

Performance Measurements

These performance measurements require a few activities using wrist-based heart rate or a compatible chest heart rate monitor. The measurements are estimates that can help you track and understand your training activities and race performances. These estimates are provided and supported by Firstbeat.



NOTE: The estimates may seem inaccurate at first. The device requires you to complete a few activities to learn about your performance.

Training status: Training status shows you how your training affects your fitness and performance. Your training status is based on changes to your training load and VO2 max. over an extended time period.

VO2 max.: VO2 max. is the maximum volume of oxygen (in milliliters) you can consume per minute per kilogram of body weight at your maximum performance.

Recovery time: The recovery time displays how much time remains before you are fully recovered and ready for the next hard workout.

Training load: Training load is the sum of your excess post-exercise oxygen consumption (EPOC) over the last 7 days. EPOC is an estimate of how much energy it takes for your body to recover after exercise.

Predicted race times: Your device uses the VO2 max. estimate and published data sources to provide a target race time based on your current state of fitness. This projection also presumes you have completed the proper training for the race.

HRV stress test: The HRV (heart rate variability) stress test requires a Garmin chest heart rate monitor. The device records your heart rate variability while standing still for 3 minutes. It provides your overall stress level. The scale is 1 to 100, and a lower score indicates a lower stress level.

Performance condition: Your performance condition is a real-time assessment after 6 to 20 minutes of activity. It can be added as a data field so you can view your performance condition during the rest of your activity. It compares your real-time condition to your average fitness level.

Functional threshold power (FTP): The device uses your user profile information from the initial setup to estimate your FTP. For a more accurate rating, you can conduct a guided test.

Lactate threshold: Lactate threshold requires a chest heart rate monitor. Lactate threshold is the point where your muscles start to rapidly fatigue. Your device measures your lactate threshold level using heart rate data and pace.

Turning On Performance Notifications

Performance notifications are alerts that appear upon completion of your activity. You can turn on notifications for performance measurements, such as your performance condition and recovery time. Some performance notifications

appear when you achieve a new performance measurement, such as a new VO2 max. estimate.

- 1 Hold **MENU**.
- 2 Select **Settings > Physiological Metrics > Performance Notifications**.
- 3 Select an option.

Automatically Detecting Performance Measurements

You can enable the device to automatically detect your maximum heart rate, lactate threshold, and functional threshold power (FTP) during an activity.

- 1 Hold **MENU**.
- 2 Select **Settings > Physiological Metrics > Auto Detection**.
- 3 Select an option.

Training Status

Training status shows you how your training affects your fitness level and performance. Your training status is based on changes to your training load and VO2 max. over an extended time period. You can use your training status to help plan future training and continue improving your fitness level.

- No status:** The device needs one or two weeks of training history, including activities with VO2 max. results from running or cycling, to determine your training status.
- Detraining:** Detraining occurs when you are training much less than usual for a week or more, and it is affecting your fitness level. You can try increasing your training load to see improvement.
- Recovery:** Your lighter training load is allowing your body to recover, which is essential during extended periods of hard training. You can return to a higher training load when you feel ready.
- Maintaining:** Your current training load is enough to maintain your fitness level. To see improvement, try adding more variety to your workouts or increasing your training volume.
- Productive:** Your current training load is moving your fitness level and performance in the right direction. It is important to plan recovery periods into your training to maintain your fitness level.
- Peaking:** Peaking means that you are in ideal race condition. Your recently reduced training load is allowing your body to recover and fully compensate for earlier training. You should plan ahead, since this peak state can only be maintained for a short time.
- Overreaching:** Your training load is very high and counterproductive. Your body needs a rest. You should give yourself time to recover by adding lighter training to your schedule.
- Unproductive:** Your training load is at a good level, but your fitness is decreasing. Your body may be struggling to recover, so you should pay attention to your overall health including stress, nutrition, and rest.

About VO2 Max. Estimates

VO2 max. is the maximum volume of oxygen (in milliliters) you can consume per minute per kilogram of body weight at your maximum performance. In simple terms, VO2 max. is an indication of athletic performance and should increase as your level of fitness improves. The fēnix 5/5S device requires wrist-based heart rate or a compatible chest heart rate monitor to display your VO2 max. estimate. The device has separate VO2 max. estimates for running and cycling. You can pair your device with a compatible power meter to display your cycling VO2 max. estimate.

Your VO2 max. estimate appears as a number and position on the color gauge.



Purple	Superior
Blue	Excellent
Green	Good
Orange	Fair
Red	Poor

VO2 max. data and analysis is provided with permission from The Cooper Institute®. For more information, see the appendix (*VO2 Max. Standard Ratings, page 31*), and go to www.CooperInstitute.org.

Getting Your VO2 Max. Estimate for Running

This feature requires wrist-based heart rate or a compatible chest heart rate monitor. If you are using a chest heart rate monitor, you must put it on and pair it with your device (*Pairing ANT+ Sensors, page 24*). If your fēnix 5/5S device was packaged with a heart rate monitor, the devices are already paired.

For the most accurate estimate, complete the user profile setup (*Setting Up Your User Profile, page 10*), and set your maximum heart rate (*Setting Your Heart Rate Zones, page 11*). The estimate may seem inaccurate at first. The device requires a few runs to learn about your running performance.

- 1 Run for at least 10 minutes outdoors.
- 2 After your run, select **Save**.
- 3 Select **UP** or **DOWN** to view the performance widget.
- 4 Select **▲** to scroll through the performance measurements.

Getting Your VO2 Max. Estimate for Cycling

This feature requires a power meter and wrist-based heart rate or a compatible chest heart rate monitor. The power meter must be paired with your fēnix 5/5S device (*Pairing ANT+ Sensors, page 24*). If you are using a chest heart rate monitor, you must put it on and pair it with your device. If your fēnix 5/5S device was packaged with a heart rate monitor, the devices are already paired.

For the most accurate estimate, complete the user profile setup (*Setting Up Your User Profile, page 10*) and set your maximum heart rate (*Setting Your Heart Rate Zones, page 11*). The estimate may seem inaccurate at first. The device requires a few rides to learn about your cycling performance.

- 1 Ride at a steady, high intensity for at least 20 minutes.
- 2 After your ride, select **Save**.
- 3 Select **UP** or **DOWN** to view the performance widget.
- 4 Select **▲** to scroll through the performance measurements.

Recovery Time

You can use your Garmin device with wrist-based heart rate or a compatible chest heart rate monitor to display how much time remains before you are fully recovered and ready for the next hard workout.

Recovery time: The recovery time appears immediately following an activity. The time counts down until it is optimal for you to attempt another hard workout.

Viewing Your Recovery Time

For the most accurate estimate, complete the user profile setup ([Setting Up Your User Profile, page 10](#)), and set your maximum heart rate ([Setting Your Heart Rate Zones, page 11](#)).

1 Go for a run.

After 6 to 20 minutes, your performance condition appears ([Viewing Your Performance Condition, page 9](#)).

2 After your run, select **Save**.

The recovery time appears. The maximum time is 4 days.

NOTE: From the watch face, you can select UP or DOWN to view the performance widget, and select  to scroll through the performance measurements to view your recovery time.

Training Load

Training load is a measurement of your training volume over the last seven days. It is the sum of your EPOC measurements for the last seven days. The gauge indicates whether your current load is low, high, or within the optimal range to maintain or improve your fitness level. The optimal range is determined based on your individual fitness level and training history. The range adjusts as your training time and intensity increase or decrease.

Viewing Your Predicted Race Times

For the most accurate estimate, complete the user profile setup ([Setting Up Your User Profile, page 10](#)), and set your maximum heart rate ([Setting Your Heart Rate Zones, page 11](#)).

Your device uses the VO2 max. estimate ([About VO2 Max. Estimates, page 8](#)) and published data sources to provide a target race time based on your current state of fitness. This projection also presumes you have completed the proper training for the race.

NOTE: The projections may seem inaccurate at first. The device requires a few runs to learn about your running performance.

1 Select **UP** or **DOWN** to view the performance widget.

2 Select to scroll through the performance measurements.

Your projected race times appear for 5K, 10K, half marathon, and marathon distances.

Heart Rate Variability and Stress Level

Stress level is the result of a three-minute test performed while standing still, where the fēnix device analyzes heart rate variability to determine your overall stress. Training, sleep, nutrition, and general life stress all impact how a runner performs. The stress level range is from 1 to 100, where 1 is a very low stress state and 100 is a very high stress state. Knowing your stress level can help you decide if your body is ready for a tough training run or yoga.

Viewing Your Heart Rate Variability and Stress Level

This feature requires a Garmin chest heart rate monitor. Before you can view your heart rate variability (HRV) stress level, you must put on a heart rate monitor and pair it with your device ([Pairing ANT+ Sensors, page 24](#)). If your fēnix 5/5S device was packaged with a heart rate monitor, the devices are already paired.

TIP: Garmin recommends that you measure your stress level at approximately the same time and under the same conditions every day.

1 If necessary, select > **Add** > **HRV Stress** to add the stress app to the apps list.

2 Select **Yes** to add the app to your list of favorites.

3 From the watch face, select > **HRV Stress** > .

4 Stand still, and rest for 3 minutes.

Performance Condition

As you complete your activity, such as running or cycling, the performance condition feature analyzes your pace, heart rate, and heart rate variability to make a real-time assessment of your ability to perform compared to your average fitness level.

Performance condition values range from -20 to +20. After the first 6 to 20 minutes of your activity, the device displays your performance condition score. For example, a score of +5 means that you are rested, fresh, and capable of a good run or ride. You can add performance condition as a data field to one of your training screens to monitor your ability throughout the activity. Performance condition can also be an indicator of fatigue level, especially at the end of a long training run or ride.

NOTE: The device requires a few runs or rides with a heart rate monitor to get an accurate VO2 max. estimate and learn about your running or riding ability ([About VO2 Max. Estimates, page 8](#)).

Viewing Your Performance Condition

This feature requires wrist-based heart rate or a compatible chest heart rate monitor. If you are using a chest heart rate monitor, you must put it on and pair it with your device ([Pairing ANT+ Sensors, page 24](#)). If your fēnix 5/5S device was packaged with a heart rate monitor, the devices are already paired.

Your device analyzes your performance condition based on heart rate and power data.

1 Add **Perform. Cond.** to a data screen ([Customizing the Data Screens, page 19](#)).

2 Go for a run or ride.

After 6 to 20 minutes, your performance condition appears.

3 Scroll to the data screen to view your performance condition throughout the run or ride.

Getting Your FTP Estimate





Before you can get your functional threshold power (FTP) estimate, you must pair a chest heart rate monitor and power meter with your device ([Pairing ANT+ Sensors, page 24](#)), and you must get your VO2 max. estimate for cycling ([Getting Your VO2 Max. Estimate for Cycling, page 8](#)).

The device uses your user profile information from the initial setup and your VO2 max. estimate to estimate your FTP.

1 Select **UP** or **DOWN** to view the performance widget.

2 Select to scroll through the performance measurements.

Your FTP estimate appears as a value measured in watts per kilogram, your power output in watts, and a position on the color gauge.

	Purple	Superior
	Blue	Excellent
	Green	Good
	Orange	Fair
	Red	Untrained

For more information, see the appendix ([FTP Ratings, page 31](#)).

NOTE: When a performance notification alerts you to a new FTP, you can select Accept to save the new FTP, or Decline to keep your current FTP ([Turning On Performance Notifications, page 7](#)).

Conducting an FTP Test

Before you can conduct a test to determine your functional threshold power (FTP), you must pair a chest heart rate monitor and a power meter with your device ([Pairing ANT+ Sensors, page 24](#)), and you must get your VO2 max. estimate for cycling ([Getting Your VO2 Max. Estimate for Cycling, page 8](#)).

1 From the watch face, select .

- 2 Select a cycling activity.
- 3 Hold **MENU**.
- 4 Select **Training > FTP Guided Test**.
- 5 Follow the on-screen instructions.
After you begin your ride, the device displays each step duration, the target, and current power data. A message appears when the test is complete.
- 6 After you complete the guided test, complete the cool down.
Your FTP appears as a value measured in watts per kilogram, your power output in watts, and a position on the color gauge.
- 7 Select an option:
 - Select **Accept** to save the new FTP.
 - Select **Decline** to keep your current FTP.

Lactate Threshold

Lactate threshold is the exercise intensity at which lactate (lactic acid) starts to accumulate in the bloodstream. In running, it is the estimated level of effort or pace. When a runner exceeds the threshold, fatigue starts to increase at an accelerating rate. For experienced runners, the threshold occurs at approximately 90% of their maximum heart rate and between 10k and half-marathon race pace. For average runners, the lactate threshold often occurs well below 90% of maximum heart rate. Knowing your lactate threshold can help you determine how hard to train or when to push yourself during a race.

If you already know your lactate threshold heart rate value, you can enter it in your user profile settings ([Setting Your Heart Rate Zones](#), page 11).

Performing a Guided Test to Determine Your Lactate Threshold

This feature requires a Garmin chest heart rate monitor. Before you can perform the guided test, you must put on a heart rate monitor and pair it with your device ([Pairing ANT+ Sensors](#), page 24). You must also have a VO2 max. estimate from a previous run ([About VO2 Max. Estimates](#), page 8).

TIP: The device requires a few runs with a chest heart rate monitor to get an accurate maximum heart rate value and VO2 max. estimate.

- 1 From the watch face, select .
- 2 Select an outdoor running activity.
GPS is required to complete the test.
- 3 Hold **MENU**.
- 4 Select **Training > Lactate Threshold Guided Test**.
- 5 Follow the on-screen instructions.

Recovery Heart Rate

If you are training with wrist-based heart rate or a compatible chest heart rate monitor, you can check your recovery heart rate value after each activity. Recovery heart rate is the difference between your exercising heart rate and your heart rate two minutes after the exercise has stopped. For example, after a typical training run, you stop the timer. Your heart rate is 140 bpm. After two minutes of no activity or cool down, your heart rate is 90 bpm. Your recovery heart rate is 50 bpm (140 minus 90). Some studies have linked recovery heart rate to cardiac health. Higher numbers generally indicate healthier hearts.

TIP: For best results, you should stop moving for two minutes while the device calculates your recovery heart rate value. You can save or discard the activity after this value appears.

About Training Effect







Training Effect measures the impact of an activity on your aerobic and anaerobic fitness. Training Effect accumulates during the activity. As the activity progresses, the Training Effect

value increases, telling you how the activity has improved your fitness. Training Effect is determined by your user profile information, heart rate, duration, and intensity of your activity.

Aerobic Training Effect uses your heart rate to measure how the accumulated intensity of an exercise affects your aerobic fitness and indicates if the workout had a maintaining or improving effect on your fitness level. Your EPOC accumulated during exercise is mapped to a range of values that account for your fitness level and training habits. Steady workouts at moderate effort or workouts involving longer intervals (>180 sec) have a positive impact on your aerobic metabolism and result in an improved aerobic Training Effect.

Anaerobic Training Effect uses heart rate and speed (or power) to determine how a workout affects your ability to perform at very high intensity. You receive a value based on the anaerobic contribution to EPOC and the type of activity. Repeated high-intensity intervals of 10 to 120 seconds have a highly beneficial impact on your anaerobic capability and result in an improved anaerobic Training Effect.

It is important to know that your Training Effect numbers (from 0.0 to 5.0) may seem abnormally high during your first few activities. It takes several activities for the device to learn your aerobic and anaerobic fitness.

Color Zone	Training Effect	Aerobic Benefit	Anaerobic Benefit
	From 0.0 to 0.9	No benefit.	No benefit.
	From 1.0 to 1.9	Minor benefit.	Minor benefit.
	From 2.0 to 2.9	Maintains your aerobic fitness.	Maintains your anaerobic fitness.
	From 3.0 to 3.9	Improves your aerobic fitness.	Improves your anaerobic fitness.
	From 4.0 to 4.9	Highly improves your aerobic fitness.	Highly improves your anaerobic fitness.
	5.0	Overreaching and potentially harmful without enough recovery time.	Overreaching and potentially harmful without enough recovery time.

Training effect technology is provided and supported by Firstbeat Technologies Ltd. For more information, go to www.firstbeattechnologies.com.

Training

Setting Up Your User Profile

You can update your gender, birth year, height, weight, heart rate zone, and power zone settings. The device uses this information to calculate accurate training data.

- 1 Hold **MENU**.
- 2 Select **Settings > User Profile**.
- 3 Select an option.

Fitness Goals

Knowing your heart rate zones can help you measure and improve your fitness by understanding and applying these principles.

- Your heart rate is a good measure of exercise intensity.
- Training in certain heart rate zones can help you improve cardiovascular capacity and strength.
- Knowing your heart rate zones can prevent you from overtraining and can decrease your risk of injury.

If you know your maximum heart rate, you can use the table ([Heart Rate Zone Calculations, page 11](#)) to determine the best heart rate zone for your fitness objectives.

If you do not know your maximum heart rate, use one of the calculators available on the Internet. Some gyms and health centers can provide a test that measures maximum heart rate. The default maximum heart rate is 220 minus your age.

About Heart Rate Zones

Many athletes use heart rate zones to measure and increase their cardiovascular strength and improve their level of fitness. A heart rate zone is a set range of heartbeats per minute. The five commonly accepted heart rate zones are numbered from 1 to 5 according to increasing intensity. Generally, heart rate zones are calculated based on percentages of your maximum heart rate.

Setting Your Heart Rate Zones

The device uses your user profile information from the initial setup to determine your default heart rate zones. You can set separate heart rate zones for sport profiles, such as running, cycling, and swimming. For the most accurate calorie data during your activity, set your maximum heart rate. You can also set each heart rate zone and enter your resting heart rate manually. You can manually adjust your zones on the device or using your Garmin Connect account.

- 1 Hold **MENU**.
- 2 Select **Settings > User Profile > Heart Rate**.
- 3 Select **Max. HR**, and enter your maximum heart rate.
You can use the Auto Detection feature to automatically record your maximum heart rate during an activity ([Automatically Detecting Performance Measurements, page 8](#)).
- 4 Select **LTHR > Enter Manually**, and enter your lactate threshold heart rate.
You can perform a guided test to estimate your lactate threshold ([Lactate Threshold, page 10](#)).
- 5 Select **Resting HR**, and enter your resting heart rate.
You can use the average resting heart rate based on your user profile information, or you can set a custom resting heart rate.
- 6 Select **Zones > Based On**.
- 7 Select an option:
 - Select **BPM** to view and edit the zones in beats per minute.
 - Select **%Max. HR** to view and edit the zones as a percentage of your maximum heart rate.
 - Select **%HRR** to view and edit the zones as a percentage of your heart rate reserve (maximum heart rate minus resting heart rate).
 - Select **%LTHR** to view and edit the zones as a percentage of your lactate threshold heart rate.
- 8 Select a zone, and enter a value for each zone.
- 9 Select **Add Sport Heart Rate**, and select a sport profile to add separate heart rate zones (optional).
- 10 Repeat steps 3 through 8 to add sport heart rate zones (optional).

Letting the Device Set Your Heart Rate Zones

The default settings allow the device to detect your maximum heart rate and set your heart rate zones as a percentage of your maximum heart rate.

- Verify that your user profile settings are accurate ([Setting Up Your User Profile, page 10](#)).
- Run often with the wrist or chest heart rate monitor.
- Try a few heart rate training plans, available from your Garmin Connect account.

- View your heart rate trends and time in zones using your Garmin Connect account.

Heart Rate Zone Calculations

Zone	% of Maximum Heart Rate	Perceived Exertion	Benefits
1	50–60%	Relaxed, easy pace, rhythmic breathing	Beginning-level aerobic training, reduces stress
2	60–70%	Comfortable pace, slightly deeper breathing, conversation possible	Basic cardiovascular training, good recovery pace
3	70–80%	Moderate pace, more difficult to hold conversation	Improved aerobic capacity, optimal cardiovascular training
4	80–90%	Fast pace and a bit uncomfortable, breathing forceful	Improved anaerobic capacity and threshold, improved speed
5	90–100%	Sprinting pace, unsustainable for long period of time, labored breathing	Anaerobic and muscular endurance, increased power

About Lifetime Athletes

A lifetime athlete is an individual who has trained intensely for many years (with the exception of minor injuries) and has a resting heart rate of 60 beats per minute (bpm) or less.

Setting Your Power Zones

The values for the zones are default values and may not match your personal abilities. If you know your functional threshold power (FTP) value, you can enter it and allow the software to calculate your power zones automatically. You can manually adjust your zones on the device or using your Garmin Connect account.

- 1 Hold **MENU**.
- 2 Select **Settings > User Profile > Power Zones > Based On**.
- 3 Select an option:
 - Select **Watts** to view and edit the zones in watts.
 - Select **% FTP** to view and edit the zones as a percentage of your functional threshold power.
- 4 Select **FTP**, and enter your FTP value.
- 5 Select a zone, and enter a value for each zone.
- 6 If necessary, select **Minimum**, and enter a minimum power value.

Activity Tracking

The activity tracking feature records your daily step count, distance traveled, intensity minutes, floors climbed, calories burned, and sleep statistics for each recorded day. Your calories burned includes your base metabolism plus activity calories.

The number of steps taken during the day appears on the steps widget. The step count is updated periodically.

Auto Goal

Your device creates a daily step goal automatically, based on your previous activity levels. As you move during the day, the device shows your progress toward your daily goal .



If you choose not to use the auto goal feature, you can set a personalized step goal on your Garmin Connect account.

Using the Move Alert

Sitting for prolonged periods of time can trigger undesirable metabolic state changes. The move alert reminds you to keep moving. After one hour of inactivity, Move! and the red bar appear. Additional segments appear after every 15 minutes of inactivity. The device also beeps or vibrates if audible tones are turned on ([System Settings, page 23](#)).

Go for a short walk (at least a couple of minutes) to reset the move alert.

Sleep Tracking

While you are sleeping, the device monitors your movement. Sleep statistics include total hours of sleep, sleep levels, and sleep movement. You can set your normal sleep hours in the user settings on your Garmin Connect account. You can view your sleep statistics on your Garmin Connect account.

Using Automated Sleep Tracking

- 1 Wear your device while sleeping.
- 2 Upload your sleep tracking data to the Garmin Connect site ([Manually Syncing Data with Garmin Connect Mobile, page 17](#)).

You can view your sleep statistics on your Garmin Connect account.

Using Do Not Disturb Mode

You can use do not disturb mode to turn off the backlight and vibration alerts. For example, you can use this mode while sleeping or watching a movie.

NOTE: You can set your normal sleep hours in the user settings on your Garmin Connect account. You can enable the Sleep Time option in the system settings to automatically enter do not disturb mode during your normal sleep hours ([System Settings, page 23](#)).

- 1 Hold **LIGHT**.
- 2 Select .

Intensity Minutes

To improve your health, organizations such as the U.S. Centers for Disease Control and Prevention, the American Heart Association®, and the World Health Organization, recommend at least 150 minutes per week of moderate intensity activity, such as brisk walking, or 75 minutes per week of vigorous intensity activity, such as running.

The device monitors your activity intensity and tracks your time spent participating in moderate to vigorous intensity activities (heart rate data is required to quantify vigorous intensity). You can work toward achieving your weekly intensity minutes goal by participating in at least 10 consecutive minutes of moderate to vigorous intensity activities. The device adds the amount of moderate activity minutes with the amount of vigorous activity minutes. Your total vigorous intensity minutes are doubled when added.

Earning Intensity Minutes

Your fēnix 5/5S device calculates intensity minutes by comparing your heart rate data during an activity to your average resting heart rate. If heart rate is turned off, the device

calculates moderate intensity minutes by analyzing your steps per minute.

- Start a timed activity for the most accurate calculation of intensity minutes.
- Exercise for at least 10 consecutive minutes at a moderate or vigorous intensity level.

Garmin Move IQ™ Events

The Move IQ feature automatically detects activity patterns, such as walking, running, biking, swimming, and elliptical training, for at least 10 minutes. You can view the event type and duration on your Garmin Connect timeline, but they do not appear in your activities list, snapshots, or newsfeed. For more detail and accuracy, you can record a timed activity on your device.

Activity Tracking Settings

Hold **MENU**, and select **Settings > Activity Tracking**.

Status: Turns off the activity tracking feature.

Move Alert: Displays a message and the move bar on the digital watch face and steps screen. The device also beeps or vibrates if audible tones are turned on ([System Settings, page 23](#)).

Goal Alerts: Allows you to turn on and off goal alerts. Goal alerts appear for your daily steps goal, daily floors climbed goal, and weekly intensity minutes goal.

Move IQ: Allows you to turn on and off Move IQ events.

Turning Off Activity Tracking

When you turn off activity tracking, your steps, floors climbed, intensity minutes, sleep tracking, and Move IQ events are not recorded.

- 1 Hold **MENU**.
- 2 Select **Settings > Activity Tracking > Status > Off**.

Workouts

You can create custom workouts that include goals for each workout step and for varied distances, times, and calories. You can create workouts using Garmin Connect or select a training plan that has built-in workouts from Garmin Connect, and transfer them to your device.

You can schedule workouts using Garmin Connect. You can plan workouts in advance and store them on your device.



Following a Workout From the Web

Before you can download a workout from Garmin Connect, you must have a Garmin Connect account ([Garmin Connect, page 17](#)).

- 1 Connect the device to your computer.
- 2 Go to www.garminconnect.com.
- 3 Create and save a new workout.
- 4 Select **Send to Device**, and follow the on-screen instructions.
- 5 Disconnect the device.

Starting a Workout

Before you can start a workout, you must download a workout from your Garmin Connect account.

- 1 From the watch face, select .
- 2 Select an activity.
- 3 Hold **MENU**.
- 4 Select **Training > My Workouts**.
- 5 Select a workout.
- 6 Select **Do Workout**.
- 7 Select  to start the timer.

After you begin a workout, the device displays each step of the workout, step notes (optional), the target (optional), and the current workout data.

About the Training Calendar

The training calendar on your device is an extension of the training calendar or schedule you set up in Garmin Connect. After you have added a few workouts to the Garmin Connect calendar, you can send them to your device. All scheduled workouts sent to the device appear in the training calendar list by date. When you select a day in the training calendar, you can view or do the workout. The scheduled workout stays on your device whether you complete it or skip it. When you send scheduled workouts from Garmin Connect, they overwrite the existing training calendar.

Using Garmin Connect Training Plans

Before you can download and use a training plan from Garmin Connect, you must have a Garmin Connect account ([Garmin Connect, page 17](#)).



You can browse Garmin Connect to find a training plan, schedule workouts and courses, and download the plan to your device.

- 1 Connect the device to your computer.
- 2 Go to www.garminconnect.com.
- 3 Select and schedule a training plan.
- 4 Review the training plan in your calendar.
- 5 Select , and follow the on-screen instructions.



Interval Workouts

You can create interval workouts based on distance or time. The device saves your custom interval workout until you create another interval workout. You can use open intervals for track workouts and when you are running a known distance.

Creating an Interval Workout

- 1 From the watch face, select .
- 2 Select an activity.
- 3 Hold **MENU**.
- 4 Select **Training > Intervals > Edit > Interval > Type**.
- 5 Select **Distance**, **Time**, or **Open**.
TIP: You can create an open-ended interval by selecting the Open option.
- 6 Select **Duration**, enter a distance or time interval value for the workout, and select .
- 7 Select **BACK**.
- 8 Select **Rest > Type**.
- 9 Select **Distance**, **Time**, or **Open**.
- 10 If necessary, enter a distance or time value for the rest interval, and select .
- 11 Select **BACK**.
- 12 Select one or more options:
 - To set the number of repetitions, select **Repeat**.
 - To add an open-ended warm up to your workout, select **Warm Up > On**.
 - To add an open-ended cool down to your workout, select **Cool Down > On**.

Starting an Interval Workout

- 1 From the watch face, select .
- 2 Select an activity.
- 3 Hold **MENU**.
- 4 Select **Training > Intervals > Do Workout**.
- 5 Select  to start the timer.

- 6 When your interval workout has a warm up, select **LAP** to begin the first interval.
- 7 Follow the on-screen instructions.

After you complete all of the intervals, a message appears.

Stopping an Interval Workout

- At any time, select **LAP** to end an interval.
- At any time, select  to stop the timer.
- If you added a cool down to your interval workout, select **LAP** to end the interval workout.

Segments

You can send running or cycling segments from your Garmin Connect account to your device. After a segment is saved to your device, you can race a segment, trying to match or exceed your personal record or other participants who have raced the segment.

NOTE: When you download a course from your Garmin Connect account, all segments in the course are downloaded automatically.

Using Virtual Partner®

Your Virtual Partner is a training tool designed to help you meet your goals. You can set a pace for the Virtual Partner and race against it.

NOTE: This feature is not available for all activities.

- 1 Hold **MENU**.
- 2 Select **Settings > Activities & Apps**.
- 3 Select an activity.
- 4 Select the activity settings.
- 5 Select **Data Screens > Add New > Virtual Partner**.
- 6 Enter a pace or speed value.
- 7 Start your activity ([Starting an Activity, page 2](#)).
- 8 Select **UP** or **DOWN** to scroll to the Virtual Partner screen and see who is leading.

Setting a Training Target

The training target feature works with the Virtual Partner feature so you can train toward a set distance, distance and time, distance and pace, or distance and speed goal. During your training activity, the device gives you real-time feedback about how close you are to achieving your training target.

- 1 From the watch face, select .
- 2 Select an activity.
- 3 Hold **MENU**.
- 4 Select **Training > Set a Target**.
- 5 Select an option:
 - Select **Distance Only** to select a preset distance or enter a custom distance.
 - Select **Distance and Time** to select a distance and time target.
 - Select **Distance and Pace** or **Distance and Speed** to select a distance and pace or speed target.

The training target screen appears and displays your estimated finish time. The estimated finish time is based on your current performance and the time remaining.

- 6 Select  to start the timer.

Cancelling a Training Target

- 1 During an activity, hold **MENU**.
- 2 Select **Cancel Target > Yes**.

Racing a Previous Activity

You can race a previously recorded or downloaded activity. This feature works with the Virtual Partner feature so you can see how far ahead or behind you are during the activity.

NOTE: This feature is not available for all activities.

- 1 From the watch face, select **▲**.
- 2 Select an activity.
- 3 Hold **MENU**.
- 4 Select **Training > Race an Activity**.
- 5 Select an option:
 - Select **From History** to select a previously recorded activity from your device.
 - Select **Downloaded** to select an activity you downloaded from your Garmin Connect account.
- 6 Select the activity.
The Virtual Partner screen appears indicating your estimated finish time.
- 7 Select **▲** to start the timer.
- 8 After you complete your activity, select **▲ > Save**.

Personal Records

When you complete an activity, the device displays any new personal records you achieved during that activity. Personal records include your fastest time over several typical race distances and longest run or ride.

NOTE: For cycling, personal records also include most ascent and best power (power meter required).

Viewing Your Personal Records

- 1 Hold **MENU**.
- 2 Select **History > Records**.
- 3 Select a sport.
- 4 Select a record.
- 5 Select **View Record**.

Restoring a Personal Record

You can set each personal record back to the one previously recorded.

- 1 Hold **MENU**.
- 2 Select **History > Records**.
- 3 Select a sport.
- 4 Select a record to restore.
- 5 Select **Previous > Yes**.

NOTE: This does not delete any saved activities.

Clearing a Personal Record

- 1 Hold **MENU**.
- 2 Select **History > Records**.
- 3 Select a sport.
- 4 Select a record to delete.
- 5 Select **Clear Record > Yes**.

NOTE: This does not delete any saved activities.

Clearing All Personal Records

- 1 Hold **MENU**.
- 2 Select **History > Records**.
NOTE: This does not delete any saved activities.
- 3 Select a sport.
- 4 Select **Clear All Records > Yes**.
The records are deleted for that sport only.

Clock

Setting an Alarm

You can set up to ten separate alarms. You can set each alarm to sound once or to repeat regularly.

- 1 From the watch face, hold **MENU**.
- 2 Select **Clock > Alarm Clock > Add Alarm**.
- 3 Select **Time**, and enter the alarm time.
- 4 Select **Repeat**, and select when the alarm should repeat (optional).
- 5 Select **Sounds**, and select a type of notification (optional).
- 6 Select **Backlight > On** to turn on the backlight with the alarm.

Starting the Countdown Timer

- 1 From the watch face, hold **MENU**.
- 2 Select **Clock > Timer**.
- 3 Enter the time.
- 4 If necessary, select **Restart > On** to automatically restart the timer after it expires.
- 5 If necessary, select **Sounds**, and select a type of notification.
- 6 Select **Start Timer**.

Using the Stopwatch

- 1 From the watch face, hold **MENU**.
- 2 Select **Clock > Stopwatch**.
- 3 Select **▲** to start the timer.
- 4 Select **DOWN** to restart the lap timer^①.

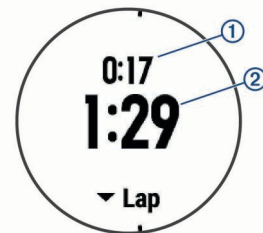

The total stopwatch time ^② continues running.

- 5 Select **▲** to stop both timers.
- 6 Select **DOWN** to reset both timers.

Setting Sunrise and Sunset Alerts

You can set the sunrise and sunset alerts to sound a specific number of minutes or hours before the actual sunrise or sunset occurs.

- 1 From the watch face, hold **MENU**.
- 2 Select **Clock > Alerts**.
- 3 Select an option:
 - Select **Til Sunset > Status > On**.
 - Select **Til Sunrise > Status > On**.
- 4 Select **Time**, and enter the time.

Syncing the Time with GPS

Each time you turn on the device and acquire satellites, the device automatically detects your time zones and the current time of day. You can also manually sync the time with GPS when you change time zones, and to update for daylight saving time.

- 1 From the watch face, hold **MENU**.
- 2 Select **Clock > Sync With GPS**.

- 3 Wait while the device locates satellites (*Acquiring Satellite Signals*, page 26).

Navigation

Saving Your Location

You can save your current location to navigate back to it later.

- 1 Hold **LIGHT**.
- 2 Select .
- 3 Follow the on-screen instructions.

Editing Your Saved Locations

You can delete a saved location or edit its name, elevation, and position information.

- 1 From the watch face, select  > **Navigate** > **Saved Locations**.
- 2 Select a saved location.
- 3 Select an option to edit the location.





Deleting All Saved Locations

You can delete all of your saved locations at once.

From the watch face, select  > **Navigate** > **Saved Locations** > **Delete All**.

Projecting a Waypoint



You can create a new location by projecting the distance and bearing from your current location to a new location.

- 1 If necessary, select  > **Add** > **Project Wpt.** to add the project waypoint app to the apps list.
- 2 Select **Yes** to add the app to your list of favorites.
- 3 From the watch face, select  > **Project Wpt.**
- 4 Select **UP** or **DOWN** to set the heading.
- 5 Select .
- 6 Select **DOWN** to select a unit of measure.
- 7 Select **UP** to enter the distance.
- 8 Select  to save.



The projected waypoint is saved with a default name.

Navigating to a Destination

You can use your device to navigate to a destination or follow a course.

- 1 From the watch face, select  > **Navigate**.
- 2 Select a category.
- 3 Respond to the on-screen prompts to choose a destination.
- 4 Select **Go To**.
Navigation information appears.
- 5 Select  to begin navigation.

Creating and Following a Course on Your Device

- 1 From the watch face, select  > **Navigate** > **Courses** > **Create New**.
- 2 Enter a name for the course, and select .
- 3 Select **Add Location**.
- 4 Select an option.
- 5 If necessary, repeat steps 3 and 4.
- 6 Select **Done** > **Do Course**.
Navigation information appears.
- 7 Select  to begin navigation.

Marking and Starting Navigation to a Man Overboard Location



You can save a man overboard (MOB) location, and automatically start navigation back to it.

TIP: You can customize the hold function of the keys to access the MOB function (*Customizing the Hot Keys*, page 23).

From the watch face, select  > **Navigate** > **Last MOB**.
Navigation information appears.

Navigating with Sight 'N Go

You can point the device at an object in the distance, such as a water tower, lock in the direction, and then navigate to the object.

- 1 From the watch face, select  > **Navigate** > **Sight 'N Go**.
- 2 Point the top of the watch at an object, and select .
- 3 Select  to begin navigation.

Navigating to Your Starting Point

You can navigate back to the starting point of your activity in a straight line or along the path you traveled. This feature is available only for activities that use GPS.

- 1 During an activity, select  > **Back to Start**.
- 2 Select an option:
 - To navigate back to the starting point of your activity along the path you traveled, select **TracBack**.
 - To navigate back to the starting point of your activity in a straight line, select **Straight Line**.

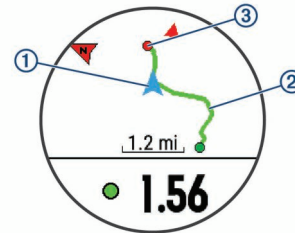

Your current location ①, the track to follow ②, and your destination ③ appear on the map.

Stopping Navigation

- 1 During an activity, hold **MENU**.
- 2 Select **Stop Navigation**.

Map

 represents your location on the map. Location names and symbols appear on the map. When you are navigating to a destination, your route is marked with a line on the map.

- Map navigation (*Panning and Zooming the Map*, page 15)
- Map settings (*Map Settings*, page 22)

Panning and Zooming the Map

- 1 While navigating, select **UP** or **DOWN** to view the map.
- 2 Hold **MENU**.
- 3 Select **Pan/Zoom**.
- 4 Select an option:
 - To toggle between panning up and down, panning left and right, or zooming, select .
 - To pan or zoom the map, select **UP** and **DOWN**.
 - To quit, select **BACK**.

Compass

The device has a 3-axis compass with automatic calibration. The compass features and appearance change depending on your activity, whether GPS is enabled, and whether you are navigating to a destination. You can change the compass settings manually (*Compass Settings*, page 22). To open the compass settings quickly, you can select  from the compass widget.

Altimeter and Barometer

The device contains an internal altimeter and barometer. The device collects elevation and pressure data continuously, even in low-power mode. The altimeter displays your approximate elevation based on pressure changes. The barometer displays environmental pressure data based on the fixed elevation where the altimeter was most recently calibrated (*Altimeter Settings*, page 22). To open the altimeter or barometer settings quickly, select  from the altimeter or barometer widgets.

History

History includes time, distance, calories, average pace or speed, lap data, and optional ANT+ sensor information.

NOTE: When the device memory is full, your oldest data is overwritten.

Using History

History contains previous activities you have saved on your device.

- 1 Hold **MENU**.
- 2 Select **History > Activities**.
- 3 Select an activity.
- 4 Select an option:
 - To view additional information about the activity, select **Details**.
 - To select a lap and view additional information about each lap, select **Laps**.
 - To select an interval and view additional information about each interval, select **Intervals**.
 - To view the activity on a map, select **Map**.
 - To view the impact of the activity on your aerobic and anaerobic fitness, select **Training Effect** (*About Training Effect*, page 10).
 - To view your time in each heart rate zone, select **Time in Zone** (*Viewing Your Time in Each Heart Rate Zone*, page 16).
 - To view an elevation plot of the activity, select **Elevation Plot**.
 - To delete the selected activity, select **Delete**.

Multisport History

Your device stores the overall multisport summary of the activity, including overall distance, time, calories, and optional accessory data. Your device also separates the activity data for each sport segment and transition so you can compare similar training activities and track how quickly you move through the transitions. Transition history includes distance, time, average speed, and calories.

Viewing Your Time in Each Heart Rate Zone

Before you can view heart rate zone data, you must complete an activity with heart rate and save the activity.

Viewing your time in each heart rate zone can help you adjust your training intensity.

- 1 Hold **MENU**.
- 2 Select **History > Activities**.

- 3 Select an activity.
- 4 Select **Time in Zone**.

Viewing Data Totals

You can view the accumulated distance and time data saved to your device.

- 1 Hold **MENU**.
- 2 Select **History > Totals**.
- 3 If necessary, select an activity.
- 4 Select an option to view weekly or monthly totals.

Using the Odometer

The odometer automatically records the total distance traveled, elevation gained, and time in activities.

- 1 Hold **MENU**.
- 2 Select **History > Totals > Odometer**.
- 3 Select **UP** or **DOWN** to view odometer totals.

Deleting History

- 1 Hold **MENU**.
 - 2 Select **History > Options**.
 - 3 Select an option:
 - Select **Delete All Activities** to delete all activities from the history.
 - Select **Reset Totals** to reset all distance and time totals.
 - 4 Confirm your selection.
- NOTE:** This does not delete any saved activities.

Connected Features

Connected features are available for your fēnix device when you connect the device to a compatible smartphone using Bluetooth wireless technology. Some features require you to install the Garmin Connect Mobile app on the connected smartphone. Go to www.garmin.com/apps for more information. Some features are also available when you connect your device to a wireless network.

Phone notifications: Displays phone notifications and messages on your fēnix device.

LiveTrack: Allows friends and family to follow your races and training activities in real time. You can invite followers using email or social media, allowing them to view your live data on a Garmin Connect tracking page.

Activity uploads to Garmin Connect: Automatically sends your activity to your Garmin Connect account as soon as you finish recording the activity.

Connect IQ: Allows you to extend your device features with new watch faces, widgets, apps, and data fields.

Bluetooth sensors: Allows you to connect Bluetooth compatible sensors, such as a heart rate monitor.

Find my phone: Locates your lost smartphone that is paired with your fēnix device and currently within range.

Find my watch: Locates your lost fēnix device that is paired with your smartphone and currently within range.

Enabling Bluetooth Notifications

Before you can enable notifications, you must pair the fēnix device with a compatible mobile device (*Pairing Your Smartphone with Your Device*, page 1).

- 1 Hold **MENU**.
- 2 Select **Settings > Phone > Smart Notifications > Status > On**.

- 3 Select **During Activity**.
- 4 Select a notification preference.
- 5 Select a sound preference.
- 6 Select **Watch Mode**.
- 7 Select a notification preference.
- 8 Select a sound preference.
- 9 Select **Timeout**.
- 10 Select the amount of time the alert for a new notification appears on the screen.

Viewing Notifications

- 1 From the watch face, select **UP** to view the notifications widget.
- 2 Select , and select a notification.
- 3 Select **DOWN** for more options.
- 4 Select **BACK** to return to the previous screen.

Managing Notifications

You can use your compatible smartphone to manage notifications that appear on your fēnix 5/5S device.

Select an option:

- If you are using an Apple® device, use the notification center settings on your smartphone to select the items to show on the device.
- If you are using an Android™ device, use the app settings in the Garmin Connect Mobile app to select the items to show on the device.

Turning Off Bluetooth Technology

- 1 Hold **LIGHT** to view the controls menu.
- 2 Select  to turn off Bluetooth wireless technology on your fēnix device.

Refer to the owner's manual for your mobile device to turn off Bluetooth wireless technology on your mobile device.

Turning On and Off Bluetooth Connection Alerts

You can set the fēnix 5/5S device to alert you when your paired smartphone connects and disconnects using Bluetooth wireless technology.

NOTE: Bluetooth connection alerts are turned off by default.

- 1 Hold **MENU**.
- 2 Select **Settings > Phone > Alerts**.

Locating a Lost Mobile Device

You can use this feature to help locate a lost mobile device that is paired using Bluetooth wireless technology and currently within range.

- 1 Hold **LIGHT** to view the controls menu.
- 2 Select .

The fēnix device begins searching for your paired mobile device. An audible alert sounds on your mobile device, and the Bluetooth signal strength displays on the fēnix device screen. The Bluetooth signal strength increases as you move closer to your mobile device.

- 3 Select **BACK** to stop searching.

Garmin Connect

You can connect with your friends on your Garmin Connect account. Garmin Connect gives you the tools to track, analyze, share, and encourage each other. Record the events of your active lifestyle including runs, walks, rides, swims, hikes, golf games, and more. Garmin Connect is also your online statistics tracker where you can analyze and share all your rounds of golf. To sign up for a free account, go to www.garminconnect.com/start.

Store your activities: After you complete and save a timed activity with your device, you can upload that activity to your Garmin Connect account and keep it as long as you want.

Analyze your data: You can view more detailed information about your fitness and outdoor activities, including time, distance, heart rate, calories burned, cadence, an overhead map view, and pace and speed charts. You can view more detailed information about your golf games, including scorecards, statistics, and course information. You can also view customizable reports.

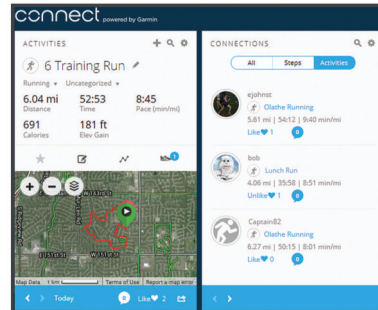

Track your progress: You can track your daily steps, join a friendly competition with your connections, and meet your goals.

Share your activities: You can connect with friends to follow each other's activities or post links to your activities on your favorite social networking sites.

Manage your settings: You can customize your device and user settings on your Garmin Connect account.

Access the Connect IQ store: You can download apps, watch faces, data fields, and widgets.

Updating the Software Using Garmin Connect Mobile

Before you can update your device software using the Garmin Connect Mobile app, you must have a Garmin Connect account, and you must pair the device with a compatible smartphone (*Pairing Your Smartphone with Your Device, page 1*).

- 1 Synchronize your device with the Garmin Connect Mobile app (*Manually Syncing Data with Garmin Connect Mobile, page 17*).

When new software is available, the Garmin Connect Mobile app automatically sends the update to your device.

- 2 Follow the on-screen instructions.

Updating the Software Using Garmin Express

Before you can update your device software, you must have a Garmin Connect account, and you must download and install the Garmin Express application.

- 1 Connect the device to your computer using the USB cable.

When new software is available, Garmin Express sends it to your device.
- 2 Disconnect the device from your computer.

Your device alerts you to update the software.
- 3 Select an option.

Using Garmin Connect on Your Computer

If you have not paired your fēnix device with your smartphone, you can upload all of your activity data to your Garmin Connect account using your computer.

- 1 Connect the device to your computer using the USB cable.
- 2 Go to www.garminconnect.com/start.
- 3 Follow the on-screen instructions.

Manually Syncing Data with Garmin Connect Mobile

- 1 Hold **LIGHT** to view the controls menu.
- 2 Select .

Wi-Fi® Connected Features

Some fēnix 5/5S models have Wi-Fi connected features. The Garmin Connect Mobile app is not required for you to use Wi-Fi connectivity.

Activity uploads to your Garmin Connect account:

Automatically sends your activity to your Garmin Connect account as soon as you finish recording the activity.

Workouts and training plans: Allows you to browse for and select workouts and training plans on the Garmin Connect site. The next time your device has a Wi-Fi connection, the files are wirelessly sent to your device.

Software updates: Your device downloads the latest software update when a Wi-Fi connection is available. The next time you turn on or unlock the device, you can follow the on-screen instructions to install the software update.

Setting Up Wi-Fi Connectivity

- 1 Go to www.garminconnect.com/start, and download the Garmin Express application.
- 2 Follow the on-screen instructions to set up Wi-Fi connectivity with Garmin Express.

Connect IQ Features

You can add Connect IQ features to your watch from Garmin and other providers using the Garmin Connect Mobile app. You can customize your device with watch faces, data fields, widgets, and apps.

Watch Faces: Allow you to customize the appearance of the clock.

Data Fields: Allow you to download new data fields that present sensor, activity, and history data in new ways. You can add Connect IQ data fields to built-in features and pages.

Widgets: Provide information at a glance, including sensor data and notifications.

Apps: Add interactive features to your watch, such as new outdoor and fitness activity types.

Downloading Connect IQ Features

Before you can download Connect IQ features from the Garmin Connect Mobile app, you must pair your fēnix 5/5S device with your smartphone.

- 1 From the settings in the Garmin Connect Mobile app, select **Connect IQ Store**.
- 2 If necessary, select your device.
- 3 Select a Connect IQ feature.
- 4 Follow the on-screen instructions.

Downloading Connect IQ Features Using Your Computer

- 1 Connect the device to your computer using a USB cable.
- 2 Go to garminconnect.com and sign in.
- 3 From your device's widget, select **Connect IQ Store**.
- 4 Select a Connect IQ feature, and download it.
- 5 Follow the on-screen instructions.

Customizing Your Device

Widgets

Your device comes preloaded with widgets that provide at-a-glance information. Some widgets require a Bluetooth connection to a compatible smartphone.

Some widgets are not visible by default. You can add them to the widget loop manually.

Notifications: Alerts you to incoming calls, texts, social network updates, and more, based on your smartphone notification settings.

Calendar: Displays upcoming meetings from your smartphone calendar.

Music controls: Provides music player controls for your smartphone.

Weather: Displays the current temperature and weather forecast.

My day: Displays a dynamic summary of your activity today. The metrics include your last recorded activity, intensity minutes, floors climbed, steps, calories burned, and more.

Steps: Tracks your daily step count, step goal, and distance traveled.

Intensity minutes: Tracks your time spent participating in moderate to vigorous activities, your weekly intensity minutes goal, and progress toward your goal.

Heart rate: Displays your current heart rate in beats per minute (bpm), lowest resting heart rate (RHR) for today, and a graph of your heart rate.

Performance: Displays your current training status, training load, VO2 max. estimates, recovery time, FTP estimate, lactate threshold, and predicted race times.

Last sport: Displays a brief summary of your last recorded sport and your total distance for the week.

ABC: Displays combined altimeter, barometer, and compass information.

Sensor information: Displays information from an internal sensor or a connected ANT+ sensor.

VIRB controls: Provides camera controls when you have a VIRB device paired with your fēnix device.

Last activity: Displays a brief summary of your last recorded activity, such as your last run, last ride, or last swim.

Calories: Displays your calorie information for the current day.

Golf: Displays golf information for your last round.

Floors climbed: Tracks your floors climbed and progress toward your goal.

Dog tracking: Displays your dog's location information when you have a compatible dog tracking device paired with your fēnix device.

Customizing the Widget Loop

You can change the order of widgets in the widget loop, remove widgets, and add new widgets.

- 1 Hold **MENU**.
- 2 Select **Settings > Widgets**.
- 3 Select a widget.
- 4 Select an option:
 - Select **Reorder** to change the location of the widget in the widget loop.
 - Select **Remove** to remove the widget from the widget loop.
- 5 Select **Add Widgets**.
- 6 Select a widget.

The widget is added to the widget loop.

VIRB Remote

The VIRB remote function allows you to control your VIRB action camera using your device. Go to www.garmin.com/VIRB to purchase a VIRB action camera.

Controlling a VIRB Action Camera

Before you can use the VIRB remote function, you must enable the remote setting on your VIRB camera. See the *VIRB Series Owner's Manual* for more information. You must also set the VIRB widget to be shown in the widget loop (*Customizing the Widget Loop*, page 18).

- 1 Turn on your VIRB camera.
- 2 On your fēnix device, select **UP** or **DOWN** from the watch face to view the VIRB widget.
- 3 Wait while the device connects to your VIRB camera.
- 4 Select **▲**.
- 5 Select an option:
 - To record video, select **Start Recording**.
The video counter appears on the fēnix screen.
 - To take a photo while recording video, select **DOWN**.
 - To stop recording video, select **▲**.
 - To take a photo, select **Take Photo**.
 - To change video and photo settings, select **Settings**.

Controlling a VIRB Action Camera During an Activity

Before you can use the VIRB remote function, you must enable the remote setting on your VIRB camera. See the *VIRB Series Owner's Manual* for more information. You must also set the VIRB widget to be shown in the widget loop (*Customizing the Widget Loop*, page 18).

- 1 Turn on your VIRB camera.
- 2 On your fēnix device, select **UP** or **DOWN** from the watch face to view the VIRB widget.
- 3 Wait while the device connects to your VIRB camera.
When the camera is connected, a VIRB data screen is automatically added to the activity apps.
- 4 During an activity, select **UP** or **DOWN** to view the VIRB data screen.
- 5 Hold **MENU**.
- 6 Select **VIRB Remote**.
- 7 Select an option:
 - To control the camera using the activity timer, select **Settings > Timer Start/Stop**.
NOTE: Video recording automatically starts and stops when you start and stop an activity.
 - To control the camera using the menu options, select **Settings > Manual**.
 - To manually record video, select **Start Recording**.
The video counter appears on the fēnix screen.
 - To take a photo while recording video, select **DOWN**.
 - To manually stop recording video, select **▲**.
 - To take a photo, select **Take Photo**.

Activities and App Settings

These settings allow you to customize each preloaded activity app based on your needs. For example, you can customize data pages and enable alerts and training features. Not all settings are available for all activity types.

Hold **MENU**, select **Settings > Activities & Apps**, select an activity, and select the activity settings.

Data Screens: Enables you to customize data screens and add new data screens for the activity (*Customizing the Data Screens*, page 19).

Transitions: Enables transitions for multisport activities.

Lock Keys: Locks the keys during multisport activities to prevent accidental key presses.

Repeat: Enables the repeat option for multisport activities. For example, you can use this option for activities that include multiple transitions, such as a swimrun.

Alerts: Sets the training or navigation alerts for the activity.

Metronome: Plays tones at a steady rhythm to help you improve your performance by training at a faster, slower, or more consistent cadence (*Using the Metronome*, page 2).

Auto Lap: Sets the options for the Auto Lap® feature (*Auto Lap*, page 20).

Auto Pause: Sets the device to stop recording data when you stop moving or when you drop below a specified speed (*Enabling Auto Pause®*, page 20).

Auto Climb: Enables the device to detect elevation changes automatically using the built-in altimeter.

Auto Run: Enables the device to detect ski runs automatically using the built-in accelerometer.

3D Speed: Calculates your speed using your elevation change and your horizontal movement over ground (*3D Speed and Distance*, page 21).

3D Distance: Calculates your distance traveled using your elevation change and your horizontal movement over ground.

Lap Key: Enables you to record a lap or a rest during the activity.

Auto Scroll: Enables you to move through all of the activity data screens automatically while the timer is running (*Using Auto Scroll*, page 21).

Segment Alerts: Enables prompts that alert you to approaching segments.

GPS: Sets the mode for the GPS antenna. Using GPS + GLONASS provides increased performance in challenging environments and faster position acquisition. Using the GPS + GLONASS option can reduce battery life more than using the GPS option only. Using the UltraTrac option records track points and sensor data less frequently (*UltraTrac*, page 21).

Pool Size: Sets the pool length for pool swimming.

Stroke Detect.: Enables stroke detection for pool swimming.

Power Save Timeout: Sets the power-save timeout setting for the activity (*Power Save Timeout Settings*, page 21).

Background Color: Sets the background color of each activity to black or white.

Accent Color: Sets the accent color of each activity to help identify which activity is active.

Rename: Sets the activity name.

Restore Defaults: Allows you to reset the activity settings.

Customizing the Data Screens

You can show, hide, and change the layout and content of data screens for each activity.

- 1 Hold **MENU**.
- 2 Select **Settings > Activities & Apps**.
- 3 Select the activity to customize.
- 4 Select the activity settings.
- 5 Select **Data Screens**.
- 6 Select a data screen to customize.
- 7 Select an option:
 - Select **Layout** to adjust the number of data fields on the data screen.
 - Select a field to change the data that appears in the field.
 - Select **Reorder** to change the location of the data screen in the loop.
 - Select **Remove** to remove the data screen from the loop.
- 8 If necessary, select **Add New** to add a data screen to the loop.

You can add a custom data screen, or select one of the predefined data screens.

Adding a Map to an Activity

You can add the map to the data screens loop for an activity.

- 1 Hold **MENU**.
- 2 Select **Settings > Activities & Apps**.
- 3 Select the activity to customize.
- 4 Select the activity settings.
- 5 Select **Data Screens > Add New > Map**.

Alerts

You can set alerts for each activity, which can help you to train toward specific goals, to increase your awareness of your environment, and to navigate to your destination. Some alerts are available only for specific activities. There are three types of alerts: event alerts, range alerts, and recurring alerts.

Event alert: An event alert notifies you once. The event is a specific value. For example, you can set the device to alert you when you reach a specified elevation.

Range alert: A range alert notifies you each time the device is above or below a specified range of values. For example, you can set the device to alert you when your heart rate is below 60 beats per minute (bpm) and over 210 bpm.

Recurring alert: A recurring alert notifies you each time the device records a specified value or interval. For example, you can set the device to alert you every 30 minutes.

Alert Name	Alert Type	Description
Cadence	Range	You can set minimum and maximum cadence values.
Calories	Event, recurring	You can set the number of calories.
Custom	Recurring	You can select an existing message or create a custom message and select an alert type.
Distance	Recurring	You can set a distance interval.
Elevation	Range	You can set minimum and maximum elevation values.
Heart Rate	Range	You can set minimum and maximum heart rate values or select zone changes. See About Heart Rate Zones, page 11 and Heart Rate Zone Calculations, page 11 .
Pace	Range	You can set minimum and maximum pace values.
Power	Range	You can set the high or low power level.
Proximity	Event	You can set a radius from a saved location.
Run/Walk	Recurring	You can set timed walking breaks at regular intervals.
Speed	Range	You can set minimum and maximum speed values.
Stroke Rate	Range	You can set high or low strokes per minute.
Time	Event, recurring	You can set a time interval.

Setting an Alert

- 1 Hold **MENU**.
- 2 Select **Settings > Activities & Apps**.
- 3 Select an activity.
NOTE: This feature is not available for all activities.
- 4 Select the activity settings.
- 5 Select **Alerts**.
- 6 Select an option:
 - Select **Add New** to add a new alert for the activity.

- Select the alert name to edit an existing alert.
- 7 If necessary, select the type of alert.
 - 8 Select a zone, enter the minimum and maximum values, or enter a custom value for the alert.
 - 9 If necessary, turn on the alert.

For event and recurring alerts, a message appears each time you reach the alert value. For range alerts, a message appears each time you exceed or drop below the specified range (minimum and maximum values).

Auto Lap

Marking Laps by Distance

You can use Auto Lap to mark a lap at a specific distance automatically. This feature is helpful for comparing your performance over different parts of an activity (for example, every 1 mile or 5 kilometers).

- 1 Hold **MENU**.
- 2 Select **Settings > Activities & Apps**.
- 3 Select an activity.
NOTE: This feature is not available for all activities.
- 4 Select the activity settings.
- 5 Select **Auto Lap**.
- 6 Select an option:
 - Select **Auto Lap** to turn Auto Lap on or off.
 - Select **Auto Distance** to adjust the distance between laps.

Each time you complete a lap, a message appears that displays the time for that lap. The device also beeps or vibrates if audible tones are turned on ([System Settings, page 23](#)).

If necessary, you can customize the data pages to display additional lap data ([Customizing the Data Screens, page 19](#)).

Customizing the Lap Alert Message

You can customize one or two data fields that appear in the lap alert message.

- 1 Hold **MENU**.
- 2 Select **Settings > Activities & Apps**.
- 3 Select an activity.
NOTE: This feature is not available for all activities.
- 4 Select the activity settings.
- 5 Select **Auto Lap > Lap Alert**.
- 6 Select a data field to change it.
- 7 Select **Preview** (optional).

Enabling Auto Pause®

You can use the Auto Pause feature to pause the timer automatically when you stop moving. This feature is helpful if your activity includes stop lights or other places where you must stop.

NOTE: History is not recorded while the timer is stopped or paused.

- 1 Hold **MENU**.
- 2 Select **Settings > Activities & Apps**.
- 3 Select an activity.
NOTE: This feature is not available for all activities.
- 4 Select the activity settings.
- 5 Select **Auto Pause**.
- 6 Select an option:
 - To pause the timer automatically when you stop moving, select **When Stopped**.
 - To pause the timer automatically when your pace or speed drops below a specified level, select **Custom**.

Enabling Auto Climb

You can use the auto climb feature to detect elevation changes automatically. You can use it during activities such as climbing, hiking, running, or biking.

- 1 Hold **MENU**.
- 2 Select **Settings > Activities & Apps**.
- 3 Select an activity.
NOTE: This feature is not available for all activities.
- 4 Select the activity settings.
- 5 Select **Auto Climb > Status > On**.
- 6 Select an option:
 - Select **Run Screen** to identify which data screen appears while running.
 - Select **Climb Screen** to identify which data screen appears while climbing.
 - Select **Invert Colors** to reverse the display colors when changing modes.
 - Select **Vertical Speed** to set the rate of ascent over time.
 - Select **Mode Switch** to set how quickly the device changes modes.

3D Speed and Distance

You can set 3D speed and distance to calculate your speed or distance using both your elevation change and your horizontal movement over ground. You can use it during activities such as skiing, climbing, navigating, hiking, running, or biking.

Turning On and Off the Lap Key

You can turn on the Lap Key setting to record a lap or a rest during an activity using LAP. You can turn off the Lap Key setting to avoid recording laps due to accidental key presses during an activity.

- 1 Hold **MENU**.
- 2 Select **Settings > Activities & Apps**.
- 3 Select an activity.
- 4 Select the activity settings.
- 5 Select **Lap Key**.
The lap key status changes to On or Off based on the current setting.

Using Auto Scroll

You can use the auto scroll feature to cycle through all of the activity data screens automatically while the timer is running.

- 1 Hold **MENU**.
- 2 Select **Settings > Activities & Apps**.
- 3 Select an activity.
NOTE: This feature is not available for all activities.
- 4 Select the activity settings.
- 5 Select **Auto Scroll**.
- 6 Select a display speed.

UltraTrac

The UltraTrac feature is a GPS setting that records track points and sensor data less frequently. Enabling the UltraTrac feature increases battery life but decreases the quality of recorded activities. You should use the UltraTrac feature for activities that demand longer battery life and for which frequent sensor data updates are less important.

Power Save Timeout Settings

The timeout settings affect how long your device stays in training mode, for example, when you are waiting for a race to start. Hold **MENU**, select **Settings > Activities & Apps**, select an activity, and select the activity settings. Select **Power Save Timeout** to adjust the timeout settings for the activity.

Normal: Sets the device to enter low-power watch mode after 5 minutes of inactivity.

Extended: Sets the device to enter low-power watch mode after 25 minutes of inactivity. The extended mode can result in shorter battery life between charges.

Removing an Activity or App

- 1 Hold **MENU**.
- 2 Select **Settings > Activities & Apps**.
- 3 Select an activity.
- 4 Select an option:
 - To remove an activity from your list of favorites, select **Remove from Favorites**.
 - To delete the activity from the apps list, select **Remove**.

Changing the Order of an Activity in the Apps List

- 1 Hold **MENU**.
- 2 Select **Settings > Activities & Apps**.
- 3 Select an activity.
- 4 Select **Reorder**.
- 5 Select **UP** or **DOWN** to adjust the position of the activity in the apps list.

Watch Face Settings

You can customize the appearance of the watch face by selecting the layout, colors, and additional data. You can also download custom watch faces from the Connect IQ store.

Customizing the Watch Face

Before you can activate a Connect IQ watch face, you must install a watch face from the Connect IQ store ([Connect IQ Features](#), page 18).

You can customize the watch face information and appearance, or activate an installed Connect IQ watch face.

- 1 From the watch face, hold **MENU**.
- 2 Select **Watch Face**.
- 3 Select **UP** or **DOWN** to preview the watch face options.
- 4 Select **Add New** to scroll through additional pre-loaded watch faces.
- 5 Select **▲ > Apply** to activate a pre-loaded watch face or an installed Connect IQ watch face.
- 6 If using a pre-loaded watch face, select **▲ > Customize**.
- 7 Select an option:
 - To change the style of the numbers for the analog watch face, select **Dial**.
 - To change the style of the hands for the analog watch face, select **Hands**.
 - To change the style of the numbers for the digital watch face, select **Layout**.
 - To change the style of the seconds for the digital watch face, select **Seconds**.
 - To change the data that appears on the watch face, select **Additional Data**.
 - To add or change an accent color for the watch face, select **Accent Color**.
 - To change the background color, select **Bkgd. Color**.
 - To save the changes, select **Done**.

Sensors Settings

Compass Settings

Hold **MENU**, and select **Settings > Sensors & Accessories > Compass**.

Calibrate: Allows you to manually calibrate the compass sensor (*Calibrating the Compass Manually, page 22*).

Display: Sets the directional heading on the compass to letters, degrees, or milli-radians.

North Ref.: Sets the north reference of the compass (*Setting the North Reference, page 22*).

Mode: Sets the compass to use electronic-sensor data only (On), a combination of GPS and electronic-sensor data when moving (Auto), or GPS data only (Off).

Calibrating the Compass Manually

NOTICE

Calibrate the electronic compass outdoors. To improve heading accuracy, do not stand near objects that influence magnetic fields, such as vehicles, buildings, and overhead power lines.

Your device was already calibrated at the factory, and the device uses automatic calibration by default. If you experience irregular compass behavior, for example, after moving long distances or after extreme temperature changes, you can manually calibrate the compass.

- 1 Hold **MENU**.
- 2 Select **Settings > Sensors & Accessories > Compass > Calibrate > Start**.
- 3 Follow the on-screen instructions.
TIP: Move your wrist in a small figure eight motion until a message appears.

Setting the North Reference

You can set the directional reference used in calculating heading information.

- 1 Hold **MENU**.
- 2 Select **Settings > Sensors & Accessories > Compass > North Ref.**
- 3 Select an option:
 - To set geographic north as the heading reference, select **True**.
 - To set the magnetic declination for your location automatically, select **Magnetic**.
 - To set grid north (000°) as the heading reference, select **Grid**.
 - To set the magnetic variation value manually, select **User**, enter the magnetic variance, and select **Done**.

Altimeter Settings

Hold **MENU**, and select **Settings > Sensors & Accessories > Altimeter**.

Auto Cal.: Allows the altimeter to self-calibrate each time you turn on GPS tracking.

Calibrate: Allows you to manually calibrate the altimeter sensor.

Calibrating the Barometric Altimeter

Your device was already calibrated at the factory, and the device uses automatic calibration at your GPS starting point by default. You can manually calibrate the barometric altimeter if you know the correct elevation.

- 1 Hold **MENU**.
- 2 Select **Settings > Sensors & Accessories > Altimeter**.
- 3 Select an option:
 - To calibrate automatically from your GPS starting point, select **Auto Cal. > On**.
 - To enter the current elevation, select **Calibrate**.

Barometer Settings

Hold **MENU**, and select **Settings > Sensors & Accessories > Barometer**.

Plot: Sets the time scale for the chart in the barometer widget.

Storm Alert: Sets the rate of barometric pressure change that triggers a storm alert.

Watch Mode: Sets the sensor used in watch mode. The Auto option uses both the altimeter and barometer according to your movement. You can use the Altimeter option when your activity involves changes in altitude, or the Barometer option when your activity does not involve changes in altitude.

Map Settings

You can customize how the map appears in the map app and data screens.

Hold **MENU**, and select **Settings > Map**.

Orientation: Sets the orientation of the map. The North Up option shows north at the top of the screen. The Track Up option shows your current direction of travel at the top of the screen.

User Locations: Shows or hides saved locations on the map.

Auto Zoom: Automatically selects the zoom level for optimal use of your map. When disabled, you must zoom in or out manually.

Navigation Settings

You can customize the map features and appearance when navigating to a destination.

Customizing Map Features

- 1 Hold **MENU**.
- 2 Select **Settings > Navigation > Data Screens**.
- 3 Select an option:
 - Select **Map** to turn on or off the map.
 - Select **Guide** to turn on or off the guide screen that displays the compass bearing or course to follow while navigating.
 - Select **Elevation Plot** to turn on or off the elevation plot.
 - Select a screen to add, remove, or customize.

Heading Settings

You can set the behavior of the pointer that appears when navigating.

Hold **MENU**, and select **Settings > Navigation > Type**.

Bearing: Points in the direction of your destination.

Course: Shows your relationship to the course line leading to the destination (*Course Pointer, page 22*).

Course Pointer

The course pointer is most useful when you are navigating to your destination in a straight line, such as when you are navigating on water. It can help you navigate back to the course line when you go off-course to avoid obstacles or hazards.

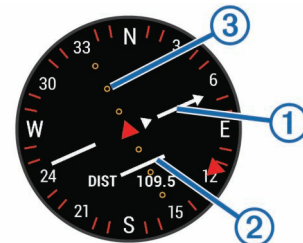

The course pointer ① indicates your relationship to the course line leading to the destination. The course deviation indicator

(CDI) ② provides the indication of drift (right or left) from the course. The dots ③ tell you how far off course you are.

Setting Up a Heading Bug

You can set up a heading indicator to display on your data pages while navigating. The indicator points to your target heading.

- 1 Hold **MENU**.
- 2 Select **Settings > Navigation > Heading Bug**.

Setting Navigation Alerts

You can set alerts to help you navigate to your destination.

- 1 Hold **MENU**.
- 2 Select **Settings > Navigation > Alerts**.
- 3 Select an option:
 - To set an alert for a specified distance from your final destination, select **Final Distance**.
 - To set an alert for the estimated time remaining until you reach your final destination, select **Final ETE**.
- 4 Select **Status** to turn on the alert.
- 5 Enter a distance or time value, and select ✓.

System Settings

Hold **MENU**, and select **Settings > System**.

Language: Sets the language displayed on the device.

Time: Adjusts the time settings ([Time Settings, page 23](#)).

Backlight: Adjusts the backlight settings ([Backlight Settings, page 23](#)).

Sounds: Sets the device sounds, such as key tones, alerts, and vibrations.

Do Not Disturb: Turns on or off do not disturb mode. Use the Sleep Time option to turn on do not disturb mode automatically during your normal sleep hours. You can set your normal sleep hours on your Garmin Connect account.

Controls Menu: Allows you to add, reorder, and remove the shortcut menu options in the controls menu ([Customizing the Controls Menu, page 23](#)).

Hot Keys: Allows you to assign shortcuts to device keys ([Customizing the Hot Keys, page 23](#)).

Auto Lock: Allows you to lock the keys automatically to prevent accidental key presses. Use the During Activity option to lock the keys during a timed activity. Use the Watch Mode option to lock the keys when you are not recording a timed activity.

Units: Sets the units of measure used on the device ([Changing the Units of Measure, page 23](#)).

Format: Sets general format preferences, such as the pace and speed shown during activities, the start of the week, and geographical position format and datum options.

Data Recording: Sets how the device records activity data. The Smart recording option (default) allows for longer activity recordings. The Every Second recording option provides more detailed activity recordings, but may not record entire activities that last for longer periods of time.

USB Mode: Sets the device to use mass storage mode or Garmin mode when connected to a computer.

Restore Defaults: Allows you to reset user data and settings ([Restoring All Default Settings, page 26](#)).

Software Update: Allows you to install software updates downloaded using Garmin Express.

Time Settings

Hold **MENU**, and select **Settings > System > Time**.

Time Format: Sets the device to show time in a 12-hour or 24-hour format.

Set Time: Sets the time zone for the device. The Auto option sets the time zone automatically based on your GPS position.

Time: Allows you to adjust the time if it is set to the Manual option.

Alerts: Allows you to set sunrise and sunset alerts to sound a specific number of minutes or hours before the actual sunrise or sunset occurs.

Sync With GPS: Allows you to manually sync the time with GPS when you change time zones, and to update for daylight saving time.

Backlight Settings

Hold **MENU**, and select **Settings > System > Backlight**.

Mode: Sets the backlight to turn on manually or automatically.

The Auto option allows you to separately set the backlight for keys, alerts, and gestures.

NOTE: When you set Gesture to On, you trigger the backlight by raising and turning your arm to look at your wrist.

Timeout: Sets the length of time before the backlight turns off.

Brightness: Sets the brightness level of the backlight.

Customizing the Controls Menu

You can add, remove, and change the order of the shortcut menu options in the controls menu ([Viewing the Controls Menu, page 1](#)).

- 1 Hold **MENU**.
- 2 Select **Settings > System > Controls Menu**.
- 3 Select a shortcut to customize.
- 4 Select an option:
 - Select **Reorder** to change the location of the shortcut in the controls menu.
 - Select **Remove** to remove the shortcut from the controls menu.
- 5 If necessary, select **Add New** to add an additional shortcut to the controls menu.

Customizing the Hot Keys

You can customize the hold function of individual keys and combinations of keys.

- 1 Hold **MENU**.
- 2 Select **Settings > System > Hot Keys**.
- 3 Select a key or combination of keys to customize.
- 4 Select a function.

Changing the Units of Measure

You can customize units of measure for distance, pace and speed, elevation, weight, height, and temperature.

- 1 Hold **MENU**.
- 2 Select **Settings > System > Units**.
- 3 Select a measurement type.
- 4 Select a unit of measure.

Viewing Device Information

You can view device information, such as the unit ID, software version, regulatory information, and license agreement.

- 1 Hold **MENU**.
- 2 Select **Settings > About**.

Viewing Regulatory and Compliance Information

- 1 From the settings, select **About**.
- 2 Select **DOWN** until regulatory information appears.

ANT+ Sensors

The device is compatible with these optional, wireless ANT+ accessories.

- Heart rate monitor, such as HRM-Run™ (*Putting On the Heart Rate Monitor, page 5*)
- Bike speed and cadence sensor (*Using an Optional Bike Speed or Cadence Sensor, page 24*)
- Foot pod (*Foot Pod, page 24*)
- Power sensor, such as Vector™
- tempe™ wireless temperature sensor (*tempe, page 25*)

For information about compatibility and purchasing additional sensors, go to <http://buy.garmin.com>.

Pairing ANT+ Sensors

The first time you connect a sensor to your device using ANT+ wireless technology, you must pair the device and sensor. After they are paired, the device connects to the sensor automatically when you start an activity and the sensor is active and within range.

NOTE: If a heart rate monitor was bundled with your device, the included heart rate monitor is already paired with your device.

- 1 If you are pairing a heart rate monitor, put on the heart rate monitor (*Putting On the Heart Rate Monitor, page 5*).

The heart rate monitor does not send or receive data until you put it on.

- 2 Bring the device within 3 m (10 ft.) of the sensor.

NOTE: Stay 10 m (33 ft.) away from other ANT+ sensors while pairing.

- 3 Hold **MENU**.

- 4 Select **Settings > Sensors & Accessories > Add New**.

- 5 Select an option:

- Select **Search All**.
- Select your sensor type.

After the sensor is paired with your device, the sensor status changes from Searching to Connected. Sensor data appears in the data page loop or a custom data field.

Using an Optional Bike Speed or Cadence Sensor

You can use a compatible bike speed or cadence sensor to send data to your device.

- Pair the sensor with your device (*Pairing ANT+ Sensors, page 24*).
- Update your fitness user profile information (*Setting Up Your User Profile, page 10*).
- Set your wheel size (*Wheel Size and Circumference, page 31*).
- Go for a ride (*Starting an Activity, page 2*).

Training with Power Meters

- Go to www.garmin.com/intosports for a list of ANT+ sensors that are compatible with your device (such as Vector).
- For more information, see the owner's manual for your power meter.
- Adjust your power zones to match your goals and abilities (*Setting Your Power Zones, page 11*).
- Use range alerts to be notified when you reach a specified power zone (*Setting an Alert, page 20*).
- Customize the power data fields (*Customizing the Data Screens, page 19*).

Using Electronic Shifters

Before you can use compatible electronic shifters, such as Shimano® Di2™ shifters, you must pair them with your device (*Pairing ANT+ Sensors, page 24*). You can customize the optional data fields (*Customizing the Data Screens, page 19*). The fēnix 5/5S device displays current adjustment values when the sensor is in adjustment mode.

Situational Awareness

Your fēnix device can be used with the Varia Vision™ device, Varia™ smart bike lights, and rearview radar to improve situational awareness. See the owner's manual for your Varia device for more information.

NOTE: You may need to update the fēnix software before pairing Varia devices (*Updating the Software Using Garmin Connect Mobile, page 17*).

Foot Pod

Your device is compatible with the foot pod. You can use the foot pod to record pace and distance instead of using GPS when you are training indoors or when your GPS signal is weak. The foot pod is on standby and ready to send data (like the heart rate monitor).

After 30 minutes of inactivity, the foot pod powers off to conserve the battery. When the battery is low, a message appears on your device. Approximately five hours of battery life remain.

Improving Foot Pod Calibration

Before you can calibrate your device, you must acquire GPS signals and pair your device with the foot pod (*Pairing ANT+ Sensors, page 24*).

The foot pod is self-calibrating, but you can improve the accuracy of the speed and distance data with a few outdoor runs using GPS.

- 1 Stand outside for 5 minutes with a clear view of the sky.
- 2 Start a running activity.
- 3 Run on a track without stopping for 10 minutes.
- 4 Stop your activity, and save it.

Based on the recorded data, the foot pod calibration value changes, if necessary. You should not need to calibrate the foot pod again unless your running style changes.

Calibrating Your Foot Pod Manually

Before you can calibrate your device, you must pair your device with the foot pod sensor (*Pairing ANT+ Sensors, page 24*).

Manual calibration is recommended if you know your calibration factor. If you have calibrated a foot pod with another Garmin product, you may know your calibration factor.

- 1 Hold **MENU**.
- 2 Select **Settings > Sensors & Accessories**.
- 3 Select your foot pod.
- 4 Select **Cal. Factor > Set Value**.
- 5 Adjust the calibration factor:
 - Increase the calibration factor if your distance is too low.
 - Decrease the calibration factor if your distance is too high.

Setting Foot Pod Speed and Distance

Before you can customize the foot pod speed and distance, you must pair your device with the foot pod sensor (*Pairing ANT+ Sensors, page 24*).

You can set your device to calculate pace and distance from your foot pod data instead of GPS data.

- 1 Hold **MENU**.
- 2 Select **Settings > Sensors & Accessories**.

- 3 Select your foot pod.
- 4 Select **Speed**.
- 5 Select an option:
 - Select **Indoor** when you are training with GPS turned off, usually indoors.
 - Select **Always** to use your foot pod data regardless of the GPS setting.

tempe

The tempe is an ANT+ wireless temperature sensor. You can attach the sensor to a secure strap or loop where it is exposed to ambient air, and therefore, provides a consistent source of accurate temperature data. You must pair the tempe with your device to display temperature data from the tempe.

Device Information

fēnix 5/5S Specifications

Battery type	Rechargeable, built-in lithium-ion battery
fēnix 5 battery life	Up to 2 weeks
fēnix 5S battery life	Up to 9 days
Water rating	10 ATM*
Operating temperature range	From -20° to 50°C (from -4° to 122°F)
Charging temperature range	From 0° to 45°C (from 32° to 113°F)
Radio frequency	2.4 GHz
Radio protocols	ANT+ wireless technology Bluetooth Smart device Wi-Fi technology (applicable models)

*The device withstands pressure equivalent to a depth of 100 m. For more information, go to www.garmin.com/waterrating.

Battery Information

The actual battery life depends on the features enabled on your device, such as activity tracking, wrist-based heart rate, smartphone notifications, GPS, internal sensors, and connected ANT+ sensors.

fēnix 5 Battery Life	fēnix 5S Battery Life	Mode
Up to 2 weeks	Up to 9 days	Smartwatch mode with activity tracking and 24/7 wrist-based heart rate monitoring
Up to 24 hours	Up to 14 hours	GPS mode with wrist-based heart rate
Up to 75 hours	Up to 40 hours	UltraTrac GPS mode with gyro-based dead reckoning

HRM-Tri Specifications

Battery type	User-replaceable CR2032, 3 V
Battery life	Up to 10 mo. for triathlon training (approximately 1 hr./day)
Operating temperature range	From -10° to 50°C (from 14° to 122°F)
Radio frequency/protocol	2.4 GHz ANT+ wireless communications protocol
Water rating	5 ATM*

*The device withstands pressure equivalent to a depth of 50 m. For more information, go to www.garmin.com/waterrating.

Data Management

NOTE: The device is not compatible with Windows® 95, 98, Me, Windows NT®, and Mac® OS 10.3 and earlier.

Disconnecting the USB Cable

If your device is connected to your computer as a removable drive or volume, you must safely disconnect your device from your computer to avoid data loss. If your device is connected to your Windows computer as a portable device, it is not necessary to safely disconnect the device.

- 1 Complete an action:
 - For Windows computers, select the **Safely Remove Hardware** icon in the system tray, and select your device.
 - For Apple computers, select the device, and select **File > Eject**.
- 2 Disconnect the cable from your computer.

Deleting Files

NOTICE

If you do not know the purpose of a file, do not delete it. Your device memory contains important system files that should not be deleted.

- 1 Open the **Garmin** drive or volume.
- 2 If necessary, open a folder or volume.
- 3 Select a file.
- 4 Press the **Delete** key on your keyboard.

NOTE: If you are using an Apple computer, you must empty the Trash folder to completely remove the files.

Device Maintenance

Device Care

NOTICE

Do not use a sharp object to clean the device.

Avoid chemical cleaners, solvents, and insect repellents that can damage plastic components and finishes.

Thoroughly rinse the device with fresh water after exposure to chlorine, salt water, sunscreen, cosmetics, alcohol, or other harsh chemicals. Prolonged exposure to these substances can damage the case.

Avoid pressing the keys under water.

Keep the leather band dry. Avoid swimming or showering with the leather band. Exposure to water can damage the leather band.

Avoid extreme shock and harsh treatment, because it can degrade the life of the product.

Do not store the device where prolonged exposure to extreme temperatures can occur, because it can cause permanent damage.

Cleaning the Device

NOTICE

Even small amounts of sweat or moisture can cause corrosion of the electrical contacts when connected to a charger. Corrosion can prevent charging and data transfer.

- 1 Wipe the device using a cloth dampened with a mild detergent solution.
- 2 Wipe it dry.

After cleaning, allow the device to dry completely.

TIP: For more information, go to www.garmin.com/fitandcare.

Cleaning the Leather Bands

- 1 Wipe the leather bands with a dry cloth.
- 2 Use a leather conditioner to clean the leather bands.

Changing the QuickFit™ Bands

- 1 Slide the latch on the QuickFit band, and remove the band from the watch.



- 2 Align the new band with the watch.
- 3 Press the band into place.
NOTE: Make sure the band is secure. The latch should close over the watch pin.
- 4 Repeat steps 1 through 3 to change the other band.

Metal Watch Band Adjustment

If your watch includes a metal watch band, you should take your watch to a jeweler or other professional to adjust the length of the metal band.

Replacing the Heart Rate Monitor Battery

- 1 Remove the sleeve ① from the heart rate monitor module.
- 2 Use a small Phillips (00) screwdriver to remove the four screws on the front of the module.
- 3 Remove the cover and battery.

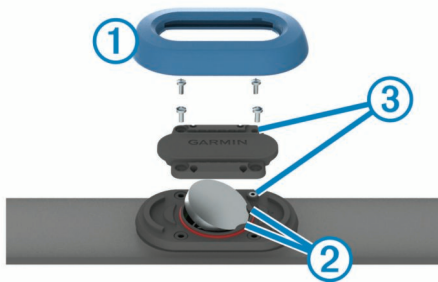

- 4 Wait 30 seconds.
- 5 Insert the new battery under the two plastic tabs ② with the positive side facing up.
NOTE: Do not damage or lose the O-ring gasket. The O-ring gasket should remain around the outside of the raised plastic ring.
- 6 Replace the front cover and the four screws. Observe the orientation of the front cover. The raised screw ③ should fit in the matching raised screw hole on the front cover.
NOTE: Do not overtighten.
- 7 Replace the sleeve.

After you replace the heart rate monitor battery, you may need to pair it with the device again.

Troubleshooting

My device is in the wrong language

You can change the device language selection if you have accidentally selected the wrong language on the device.

- 1 Hold **MENU**.
- 2 Scroll down to the last item in the list, and select ▲.
- 3 Scroll down to the second to last item in the list, and select ▲.
- 4 Select ▲.
- 5 Select your language.

Is my smartphone compatible with my device?

The fēnix 5/5S device is compatible with smartphones using Bluetooth Smart wireless technology.

Go to www.garmin.com/ble for compatibility information.

My phone will not connect to the device

- Enable Bluetooth wireless technology on your smartphone.
- Bring your phone within 10 m (33 ft.) of the device.
- On your smartphone, open the Garmin Connect Mobile app, and enter pairing mode.
- On your device, hold **LIGHT**, and select  to turn on Bluetooth technology and enter pairing mode.

Resetting Your Device

- 1 Hold **LIGHT** for at least 25 seconds.
- 2 Hold **LIGHT** for one second to turn on the device.

Restoring All Default Settings

NOTE: This deletes all user-entered information and activity history.

You can restore all of the device settings to the factory default values.

- 1 Hold **MENU**.
- 2 Select **Settings > System > Restore Defaults > Yes**.

Acquiring Satellite Signals

The device may need a clear view of the sky to acquire satellite signals. The time and date are set automatically based on the GPS position.

- 1 Go outdoors to an open area.
The front of the device should be oriented toward the sky.
- 2 Wait while the device locates satellites.
It may take 30–60 seconds to locate satellite signals.

Improving GPS Satellite Reception

- Frequently sync the device to your Garmin Connect account:
 - Connect your device to a computer using the USB cable and the Garmin Express application.
 - Sync your device to the Garmin Connect Mobile app using your Bluetooth enabled smartphone.
 - Connect your device to your Garmin Connect account using a Wi-Fi wireless network.

While connected to your Garmin Connect account, the device downloads several days of satellite data, allowing it to quickly locate satellite signals.

- Take your device outside to an open area away from tall buildings and trees.
- Remain stationary for a few minutes.

The temperature reading is not accurate

Your body temperature affects the temperature reading for the internal temperature sensor. To get the most accurate temperature reading, you should remove the watch from your wrist and wait 20 to 30 minutes.

You can also use an optional external temperature sensor to view accurate ambient temperature readings while wearing the watch.

Maximizing the Battery Life

You can do several things to extend the life of the battery.

- Reduce the backlight timeout (*Backlight Settings, page 23*).
- Reduce the backlight brightness.
- Use UltraTrac GPS mode for your activity (*UltraTrac, page 21*).
- Turn off Bluetooth wireless technology when you are not using connected features (*Connected Features, page 16*).
- When pausing your activity for a longer period of time, use the resume later option (*Stopping an Activity, page 2*).
- Turn off activity tracking (*Turning Off Activity Tracking, page 12*).
- Use a Connect IQ watch face that is not updated every second.

For example, use a watch face without a second hand (*Customizing the Watch Face, page 21*).

- Limit the smartphone notifications the device displays (*Managing Notifications, page 17*).
- Stop broadcasting heart rate data to paired Garmin devices (*Broadcasting Heart Rate Data to Garmin Devices, page 5*).
- Turn off wrist-based heart rate monitoring (*Turning Off the Wrist Heart Rate Monitor, page 5*).

NOTE: Wrist-based heart rate monitoring is used to calculate vigorous intensity minutes and calories burned.

Activity Tracking

For more information about activity tracking accuracy, go to garmin.com/ataccuracy.

My daily step count does not appear

The daily step count is reset every night at midnight.

If dashes appear instead of your step count, allow the device to acquire satellite signals and set the time automatically.

My step count does not seem accurate

If your step count does not seem accurate, you can try these tips.

- Wear the device on your non-dominant wrist.
- Carry the device in your pocket when pushing a stroller or lawn mower.
- Carry the device in your pocket when actively using your hands or arms only.

NOTE: The device may interpret some repetitive motions, such as washing dishes, folding laundry, or clapping your hands, as steps.

The step counts on my device and my Garmin Connect account don't match

The step count on your Garmin Connect account updates when you synchronize your device.

1 Select an option:

- Synchronize your step count with the Garmin Connect application (*Using Garmin Connect on Your Computer, page 17*).

- Synchronize your step count with the Garmin Connect Mobile app (*Manually Syncing Data with Garmin Connect Mobile, page 17*).

2 Wait while the device synchronizes your data.

Synchronizing can take several minutes.

NOTE: Refreshing the Garmin Connect Mobile app or the Garmin Connect application does not synchronize your data or update your step count.

The floors climbed amount does not seem accurate

Your device uses an internal barometer to measure elevation changes as you climb floors. A floor climbed is equal to 3 m (10 ft.).

- Avoid holding handrails or skipping steps while climbing stairs.

My intensity minutes are flashing

When you exercise at an intensity level that qualifies toward your intensity minutes goal, the intensity minutes flash.

Exercise for at least 10 consecutive minutes at a moderate or vigorous intensity level.

Getting More Information

You can find more information about this product on the Garmin website.

- Go to support.garmin.com.
- Go to www.garmin.com/outdoor.
- Go to <http://buy.garmin.com>, or contact your Garmin dealer for information about optional accessories and replacement parts.

Appendix

Data Fields

%FTP: The current power output as a percentage of functional threshold power.

%HRR: The percentage of heart rate reserve (maximum heart rate minus resting heart rate).

10s Avg. Power: The 10-second moving average of power output.

10s Avg Balance: The 10-second moving average of the left/right power balance.

24-Hour Max.: The maximum temperature recorded in the last 24 hours from a compatible temperature sensor.

24-Hour Min.: The minimum temperature recorded in the last 24 hours from a compatible temperature sensor.

30s Avg. Power: The 30-second moving average of power output.

30s Avg Balance: The 30-second moving average of the left/right power balance.

3s Avg. Balance: The three-second moving average of the left/right power balance.

3s Avg. Power: The 3-second moving average of power output.

500m Pace: The current swimming pace per 500 meters.

Aerobic TE: The impact of the current activity on your aerobic fitness level.

Ambient Press.: The uncalibrated ambient pressure.

Anaerobic TE: The impact of the current activity on your anaerobic fitness level.

Average HR: The average heart rate for the current activity.

Average Pace: The average pace for the current activity.

Average Power: The average power output for the current activity.

- Average Swolf:** The average swolf score for the current activity. Your swolf score is the sum of the time for one length plus the number of strokes for that length (*Swim Terminology*, page 3). In open water swimming, 25 meters is used to calculate your swolf score.
- Avg. %HRR:** The average percentage of heart rate reserve (maximum heart rate minus resting heart rate) for the current activity.
- Avg. 500m Pace:** The average swimming pace per 500 meters for the current activity.
- Avg. Ascent:** The average vertical distance of ascent since the last reset.
- Avg. Balance:** The average left/right power balance for the current activity.
- Avg. Cadence:** Cycling. The average cadence for the current activity.
- Avg. Cadence:** Running. The average cadence for the current activity.
- Avg. Descent:** The average vertical distance of descent since the last reset.
- Avg. GCT Bal.:** The average ground contact time balance for the current session.
- Avg. L. PP:** The average power phase angle for the left leg for the current activity.
- Avg. L. PPP:** The average power phase peak angle for the left leg for the current activity.
- Avg. Lap Time:** The average lap time for the current activity.
- Avg. Moving Speed:** The average speed when moving for the current activity.
- Avg. Overall Speed:** The average speed for the current activity, including both moving and stopped speeds.
- Avg. PCO:** The average platform center offset for the current activity.
- Avg. R. PP:** The average power phase angle for the right leg for the current activity.
- Avg. R. PPP:** The average power phase peak angle for the right leg for the current activity.
- Avg. Speed:** The average speed for the current activity.
- Avg. Stride Len.:** The average stride length for the current session.
- Avg. Strk/Len:** The average number of strokes per pool length during the current activity.
- Avg. Strk Rate:** Swimming. The average number of strokes per minute (spm) during the current activity.
- Avg. Strk Rate:** Paddle sports. The average number of strokes per minute (spm) during the current activity.
- Avg. Vert. Osc.:** The average amount of vertical oscillation for the current activity.
- Avg. Vert. Ratio:** The average ratio of vertical oscillation to stride length for the current session.
- Avg Dist Per Stk:** Swimming. The average distance traveled per stroke during the current activity.
- Avg Dist Per Stk:** Paddle sports. The average distance traveled per stroke during the current activity.
- Avg GCT:** The average amount of ground contact time for the current activity.
- Avg HR %Max.:** The average percentage of maximum heart rate for the current activity.
- Balance:** The current left/right power balance.
- Baro. Pressure:** The calibrated current pressure.
- Battery Level:** The remaining battery power.
- Bearing:** The direction from your current location to a destination. You must be navigating for this data to appear.
- Cadence:** Cycling. The number of revolutions of the crank arm. Your device must be connected to a cadence accessory for this data to appear.
- Cadence:** Running. The steps per minute (right and left).
- Calories:** The amount of total calories burned.
- Compass Hdg.:** The direction you are moving based on the compass.
- Course:** The direction from your starting location to a destination. Course can be viewed as a planned or set route. You must be navigating for this data to appear.
- Dest. Location:** The position of your final destination.
- Dest. Wpt:** The last point on the route to the destination. You must be navigating for this data to appear.
- Di2 Battery:** The remaining battery power of a Di2 sensor.
- Dist. Per Stroke:** Swimming. The distance traveled per stroke.
- Dist. Per Stroke:** Paddle sports. The distance traveled per stroke.
- Dist. Remaining:** The remaining distance to the final destination. You must be navigating for this data to appear.
- Distance:** The distance traveled for the current track or activity.
- Distance To Next:** The remaining distance to the next waypoint on the route. You must be navigating for this data to appear.
- Elapsed Time:** The total time recorded. For example, if you start the timer and run for 10 minutes, then stop the timer for 5 minutes, then start the timer and run for 20 minutes, your elapsed time is 35 minutes.
- Elevation:** The altitude of your current location above or below sea level.
- ETA:** The estimated time of day when you will reach the final destination (adjusted to the local time of the destination). You must be navigating for this data to appear.
- ETA at Next:** The estimated time of day when you will reach the next waypoint on the route (adjusted to the local time of the waypoint). You must be navigating for this data to appear.
- ETE:** The estimated time remaining until you reach the final destination. You must be navigating for this data to appear.
- Front:** The front bike gear from a gear position sensor.
- GCT:** The amount of time in each step that you spend on the ground while running, measured in milliseconds. Ground contact time is not calculated while walking.
- GCT Balance:** The left/right balance of ground contact time while running.
- Gear Combo:** The current gear combination from a gear position sensor.
- Gear Ratio:** The number of teeth on the front and rear bike gears, as detected by a gear position sensor.
- Gears:** The front and rear bike gears from a gear position sensor.
- Glide Ratio:** The ratio of horizontal distance traveled to the change in vertical distance.
- Glide Ratio Dest.:** The glide ratio required to descend from your current position to the destination elevation. You must be navigating for this data to appear.
- GPS:** The strength of the GPS satellite signal.
- GPS Elevation:** The altitude of your current location using GPS.
- GPS Heading:** The direction you are moving based on GPS.
- Grade:** The calculation of rise (elevation) over run (distance). For example, if for every 3 m (10 ft.) you climb you travel 60 m (200 ft.), the grade is 5%.
- Heading:** The direction you are moving.

Heart Rate: Your heart rate in beats per minute (bpm). Your device must be connected to a compatible heart rate monitor.

HR %Max.: The percentage of maximum heart rate.

HR Zone: The current range of your heart rate (1 to 5). The default zones are based on your user profile and maximum heart rate (220 minus your age).

Int. Avg. %HRR: The average percentage of heart rate reserve (maximum heart rate minus resting heart rate) for the current swim interval.

Int. Avg. %Max.: The average percentage of maximum heart rate for the current swim interval.

Int. Avg. HR: The average heart rate for the current swim interval.

Int. Distance: The distance traveled for the current interval.

Int. Max. %HRR: The maximum percentage of heart rate reserve (maximum heart rate minus resting heart rate) for the current swim interval.

Int. Max. %Max.: The maximum percentage of maximum heart rate for the current swim interval.

Int. Max. HR: The maximum heart rate for the current swim interval.

Int. Pace: The average pace for the current interval.

Int. Swolf: The average swolf score for the current interval.

Intensity Factor: The Intensity Factor™ for the current activity.

Interval Lengths: The number of pool lengths completed during the current interval.

Interval Time: The stopwatch time for the current interval.

Int Strk/Len: The average number of strokes per pool length during the current interval.

Int Strk Rate: The average number of strokes per minute (spm) during the current interval.

Int Strk Type: The current stroke type for the interval.

L. Lap Stk. Rate: Swimming. The average number of strokes per minute (spm) during the last completed lap.

L. Lap Stk. Rate: Paddle sports. The average number of strokes per minute (spm) during the last completed lap.

L. Lap Strokes: Swimming. The total number of strokes for the last completed lap.

L. Lap Strokes: Paddle sports. The total number of strokes for the last completed lap.

L. Lap Swolf: The swolf score for the last completed lap.

L. Len. Stk. Rate: The average number strokes per minute (spm) during the last completed pool length.

L. Len. Stk. Type: The stroke type used during the last completed pool length.

L. Len. Strokes: The total number of strokes for the last completed pool length.

Lap %HRR: The average percentage of heart rate reserve (maximum heart rate minus resting heart rate) for the current lap.

Lap 500m Pace: The average swimming pace per 500 meters for the current lap.

Lap Ascent: The vertical distance of ascent for the current lap.

Lap Balance: The average left/right power balance for the current lap.

Lap Cadence: Cycling. The average cadence for the current lap.

Lap Cadence: Running. The average cadence for the current lap.

Lap Descent: The vertical distance of descent for the current lap.

Lap Distance: The distance traveled for the current lap.

Lap Dist Per Stk: Swimming. The average distance traveled per stroke during the current lap.

Lap Dist Per Stk: Paddle sports. The average distance traveled per stroke during the current lap.

Lap GCT: The average amount of ground contact time for the current lap.

Lap GCT Bal.: The average ground contact time balance for the current lap.

Lap HR: The average heart rate for the current lap.

Lap HR %Max.: The average percentage of maximum heart rate for the current lap.

Lap L. PP: The average power phase angle for the left leg for the current lap.

Lap L. PPP: The average power phase peak angle for the left leg for the current lap.

Lap NP: The average Normalized Power for the current lap.

Lap Pace: The average pace for the current lap.

Lap PCO: The average platform center offset for the current lap.

Lap Power: The average power output for the current lap.

Lap R. PP: The average power phase angle for the right leg for the current lap.

Lap R. PPP: The average power phase peak angle for the right leg for the current lap.

Laps: The number of laps completed for the current activity.

Lap Speed: The average speed for the current lap.

Lap Stride Len.: The average stride length for the current lap.

Lap Strk Rate: Swimming. The average number of strokes per minute (spm) during the current lap.

Lap Strk Rate: Paddle sports. The average number of strokes per minute (spm) during the current lap.

Lap Strokes: Swimming. The total number of strokes for the current lap.

Lap Strokes: Paddle sports. The total number of strokes for the current lap.

Lap Swolf: The swolf score for the current lap.

Lap Time: The stopwatch time for the current lap.

Lap Vert. Osc.: The average amount of vertical oscillation for the current lap.

Lap Vert. Ratio: The average ratio of vertical oscillation to stride length for the current lap.

Last Lap Ascent: The vertical distance of ascent for the last completed lap.

Last Lap Cad.: Cycling. The average cadence for the last completed lap.

Last Lap Cad.: Running. The average cadence for the last completed lap.

Last Lap Descent: The vertical distance of descent for the last completed lap.

Last Lap Dist.: The distance traveled for the last completed lap.

Last Lap NP: The average Normalized Power for the last completed lap.

Last Lap Pace: The average pace for the last completed lap.

Last Lap Power: The average power output for the last completed lap.

Last Lap Speed: The average speed for the last completed lap.

Last Lap Time: The stopwatch time for the last completed lap.

Last Len. Pace: The average pace for your last completed pool length.

Last Len. Swolf: The swolf score for the last completed pool length.

Lat/Lon: The current position in latitude and longitude regardless of the selected position format setting.

Left PP: The current power phase angle for the left leg. Power phase is the pedal stroke region where positive power is produced.

Left PPP: The current power phase peak angle for the left leg. Power phase peak is the angle range over which the rider produces the peak portion of the driving force.

Lengths: The number of pool lengths completed during the current activity.

LL 500m Pace: The average swimming pace per 500 meters for the last lap.

L Lap Dist P Stk: Swimming. The average distance traveled per stroke during the last completed lap.

L Lap Dist P Stk: Paddle sports. The average distance traveled per stroke during the last completed lap.

Location: The current position using the selected position format setting.

Max. Ascent: The maximum rate of ascent in feet per minute or meters per minute since the last reset.

Max. Descent: The maximum rate of descent in meters per minute or feet per minute since the last reset.

Max. Elevation: The highest elevation reached since the last reset.

Max. Lap Power: The top power output for the current lap.

Maximum Speed: The top speed for the current activity.

Max Power: The top power output for the current activity.

Min. Elevation: The lowest elevation reached since the last reset.

Moving Time: The total time moving for the current activity.

Multisport Time: The total time for all sports in a multisport activity, including transitions.

Muscle O2 Sat. %: The estimated muscle oxygen saturation percentage for the current activity.

Nautical Dist: The distance traveled in nautical meters or nautical feet.

Nautical Speed: The current speed in knots.

Next Waypoint: The next point on the route. You must be navigating for this data to appear.

NP: The Normalized Power™ for the current activity.

Off Course: The distance to the left or right by which you have strayed from the original path of travel. You must be navigating for this data to appear.

Pace: The current pace.

PCO: The platform center offset. Platform center offset is the location on the pedal platform where force is applied.

Pedal Smooth.: The measurement of how evenly a rider is applying force to the pedals throughout each pedal stroke.

Perform. Cond.: The performance condition score is a real-time assessment of your ability to perform.

Power: The current power output in watts.

Power to Weight: The current power measured in watts per kilogram.

Power Zone: The current range of power output (1 to 7) based on your FTP or custom settings.

Rear: The rear bike gear from a gear position sensor.

Repeat On: The timer for the last interval plus the current rest (pool swimming).

Rest Timer: The timer for the current rest (pool swimming).

Right PP: The current power phase angle for the right leg. Power phase is the pedal stroke region where positive power is produced.

Right PPP: The current power phase peak angle for the right leg. Power phase peak is the angle range over which the rider produces the peak portion of the driving force.

Speed: The current rate of travel.

Stopped Time: The total time stopped for the current activity.

Stride Length: The length of your stride from one footfall to the next, measured in meters.

Stroke Rate: Swimming. The number of strokes per minute (spm).

Stroke Rate: Paddle sports. The number of strokes per minute (spm).

Strokes: Swimming. The total number of strokes for the current activity.

Strokes: Paddle sports. The total number of strokes for the current activity.

Sunrise: The time of sunrise based on your GPS position.

Sunset: The time of sunset based on your GPS position.

Temperature: The temperature of the air. Your body temperature affects the temperature sensor. You can pair a temperature sensor with your device to provide a consistent source of accurate temperature data.

Time in Zone: The time elapsed in each heart rate or power zone.

Time of Day: The time of day based on your current location and time settings (format, time zone, daylight saving time).

Timer: The current time of the countdown timer.

Time Seat.: The time spent seated while pedaling for the current activity.

Time Seat. Lap: The time spent seated while pedaling for the current lap.

Time Stand.: The time spent standing while pedaling for the current activity.

Time Stand. Lap: The time spent standing while pedaling for the current lap.

Time to Next: The estimated time remaining before you reach the next waypoint in the route. You must be navigating for this data to appear.

Torque Eff.: The measurement of how efficiently a rider is pedaling.

Total Ascent: The total elevation distance ascended since the last reset.

Total Descent: The total elevation distance descended since the last reset.

Total Hemoglobin: The estimated muscle oxygen total for the current activity.

Training Effect: The current impact (1.0 to 5.0) on your aerobic fitness.

TSS: The Training Stress Score™ for the current activity.

V Dist to Dest: The elevation distance between your current position and the final destination. You must be navigating for this data to appear.

Vert. Spd.: The rate of ascent or descent over time.

Vertical Osc.: The amount of bounce while you are running. The vertical motion of your torso, measured in centimeters for each step.

Vertical Ratio: The ratio of vertical oscillation to stride length.

Vert Spd to Tgt: The rate of ascent or descent to a predetermined altitude. You must be navigating for this data to appear.

VMG: The speed at which you are closing on a destination along a route. You must be navigating for this data to appear.

Work: The accumulated work performed (power output) in kilojoules.

VO2 Max. Standard Ratings

These tables include standardized classifications for VO2 max. estimates by age and gender.

Males	Percentile	20–29	30–39	40–49	50–59	60–69	70–79
Superior	95	55.4	54	52.5	48.9	45.7	42.1
Excellent	80	51.1	48.3	46.4	43.4	39.5	36.7
Good	60	45.4	44	42.4	39.2	35.5	32.3
Fair	40	41.7	40.5	38.5	35.6	32.3	29.4
Poor	0–40	<41.7	<40.5	<38.5	<35.6	<32.3	<29.4

Females	Percentile	20–29	30–39	40–49	50–59	60–69	70–79
Superior	95	49.6	47.4	45.3	41.1	37.8	36.7
Excellent	80	43.9	42.4	39.7	36.7	33	30.9
Good	60	39.5	37.8	36.3	33	30	28.1
Fair	40	36.1	34.4	33	30.1	27.5	25.9
Poor	0–40	<36.1	<34.4	<33	<30.1	<27.5	<25.9

Data reprinted with permission from The Cooper Institute. For more information, go to www.CooperInstitute.org.

FTP Ratings

These tables include classifications for functional threshold power (FTP) estimates by gender.

Males	Watts per Kilogram (W/kg)
Superior	5.05 and greater
Excellent	From 3.93 to 5.04
Good	From 2.79 to 3.92
Fair	From 2.23 to 2.78
Untrained	Less than 2.23

Females	Watts per Kilogram (W/kg)
Superior	4.30 and greater
Excellent	From 3.33 to 4.29
Good	From 2.36 to 3.32
Fair	From 1.90 to 2.35
Untrained	Less than 1.90

FTP ratings are based on research by Hunter Allen and Andrew Coggan, PhD, *Training and Racing with a Power Meter* (Boulder, CO: VeloPress, 2010).

Wheel Size and Circumference

The wheel size is marked on both sides of the tire. This is not a comprehensive list. You can also use one of the calculators available on the Internet.

Wheel Size	L (mm)
12 × 1.75	935
14 × 1.5	1020
14 × 1.75	1055
16 × 1.5	1185
16 × 1.75	1195
18 × 1.5	1340
18 × 1.75	1350
20 × 1.75	1515
20 × 1-3/8	1615
22 × 1-3/8	1770
22 × 1-1/2	1785
24 × 1	1753
24 × 3/4 Tubular	1785
24 × 1-1/8	1795

Wheel Size	L (mm)
24 × 1-1/4	1905
24 × 1.75	1890
24 × 2.00	1925
24 × 2.125	1965
26 × 7/8	1920
26 × 1(59)	1913
26 × 1(65)	1952
26 × 1.25	1953
26 × 1-1/8	1970
26 × 1-3/8	2068
26 × 1-1/2	2100
26 × 1.40	2005
26 × 1.50	2010
26 × 1.75	2023
26 × 1.95	2050
26 × 2.00	2055
26 × 2.10	2068
26 × 2.125	2070
26 × 2.35	2083
26 × 3.00	2170
27 × 1	2145
27 × 1-1/8	2155
27 × 1-1/4	2161
27 × 1-3/8	2169
650 × 35A	2090
650 × 38A	2125
650 × 38B	2105
700 × 18C	2070
700 × 19C	2080
700 × 20C	2086
700 × 23C	2096
700 × 25C	2105
700 × 28C	2136
700 × 30C	2170
700 × 32C	2155
700C Tubular	2130
700 × 35C	2168

Wheel Size	L (mm)
700 × 38C	2180
700 × 40C	2200

BSD 3-Clause License

Copyright © 2003-2010, Mark Borgerding

All rights reserved.





Redistribution and use in source and binary forms, with or without modification, are permitted provided that the following conditions are met:

- Redistributions of source code must retain the above copyright notice, this list of conditions and the following disclaimer.
- Redistributions in binary form must reproduce the above copyright notice, this list of conditions and the following disclaimer in the documentation and/or other materials provided with the distribution.
- Neither the author nor the names of any contributors may be used to endorse or promote products derived from this software without specific prior written permission.

THIS SOFTWARE IS PROVIDED BY THE COPYRIGHT HOLDERS AND CONTRIBUTORS "AS IS" AND ANY EXPRESS OR IMPLIED WARRANTIES, INCLUDING, BUT NOT LIMITED TO, THE IMPLIED WARRANTIES OF MERCHANTABILITY AND FITNESS FOR A PARTICULAR PURPOSE ARE DISCLAIMED. IN NO EVENT SHALL THE COPYRIGHT OWNER OR CONTRIBUTORS BE LIABLE FOR ANY DIRECT, INDIRECT, INCIDENTAL, SPECIAL, EXEMPLARY, OR CONSEQUENTIAL DAMAGES (INCLUDING, BUT NOT LIMITED TO, PROCUREMENT OF SUBSTITUTE GOODS OR SERVICES; LOSS OF USE, DATA, OR PROFITS; OR BUSINESS INTERRUPTION) HOWEVER CAUSED AND ON ANY THEORY OF LIABILITY, WHETHER IN CONTRACT, STRICT LIABILITY, OR TORT (INCLUDING NEGLIGENCE OR OTHERWISE) ARISING IN ANY WAY OUT OF THE USE OF THIS SOFTWARE, EVEN IF ADVISED OF THE POSSIBILITY OF SUCH DAMAGE.

Symbol Definitions

These symbols may appear on the device or accessory labels.

	Alternating current. The device is suitable for alternating current.
	Direct current. The device is suitable for direct current only.
	Fuse. Indicates a fuse specification or location.
	WEEE disposal and recycling symbol. The WEEE symbol is attached to the product in compliance with the EU directive 2012/19/EU on Waste Electrical and Electronic Equipment (WEEE). It is intended to deter the improper disposal of this product and to promote reuse and recycling.

Index

A

accessories **24, 27**
activities **2, 19, 21**
 custom **2, 3**
 saving **2**
 starting **2**
activity tracking **11, 12**
alarms **14, 20**
alerts **14, 20, 23**
altimeter **16, 22**
 calibrating **22**
ANT+ sensors **24**
applications **16, 18**
 smartphone **1**
auto climb **21**
Auto Lap **20**
Auto Pause **20**
auto scroll **21**

B

backlight **1, 23**
bands **26**
barometer **16, 22**
battery **25**
 charging **1**
 life **25**
 maximizing **17, 21, 27**
 replacing **26**
bike sensors **24**
Bluetooth technology **16, 17, 26**

C

cadence **2, 6**
 alerts **20**
 sensors **24**
calendar **13**
calibrating
 altimeter **22**
 compass **22**
calorie, alerts **20**
charging **1**
cleaning the device **6, 25**
clock **14**
compass **16, 22**
 calibrating **22**
 settings **22**
Connect IQ **18**
connecting **17**
controls menu **1, 23**
coordinates **15**
countdown timer **14**
courses **22**
 creating **15**
 playing **4**
 selecting **4**
customizing the device **19, 23**

D

data
 pages **19**
 storing **6, 17**
 transferring **17**
 uploading **17**
data fields **18**
deleting
 all user data **25**
 history **16**
 personal records **14**
distance **21**
 alerts **20, 23**
dogleg **4**
drills **3**

F

fitness **10**
foot pod **24**

G

Garmin Connect **1, 12, 13, 16–18**
 storing data **17**
Garmin Express **2, 18**
 updating software **1**
GLONASS **23**
goals **13, 14**
GPS **21, 23**
 signal **26**
green view, pin location **4**
ground contact time **6, 7**

H

heading setting **23**
heart rate **4, 5**
 alerts **20**
 monitor **5–10, 24, 26**
 pairing sensors **5**
 zones **8, 10, 11, 16**
history **16**
 deleting **16**
 sending to computer **17**

I

indoor training **2**
intensity minutes **12, 27**
intervals **3**
 workouts **13**

J

jumpmaster **3**

K

keys **1, 23**
 customizing **21**

L

lactate threshold **8, 10**
language **23**
layup **4**
lengths **3**
lifetime athlete **11**
locations **15**
 deleting **15**
 editing **15**
 saving **15**

M

main menu, customizing **18**
man overboard (MOB) **15**
map **22**
maps **20, 22**
 browsing **15**
 navigating **15**
measurements **4**
measuring a shot **4**
menu **1**
metronome **2**
MOB **15**
multisport **2, 3, 16**

N

navigation **20, 22, 23**
 Sight 'N Go **15**
 stopping **15**
north reference **22**
notifications **16, 17**

O

odometer **4, 16**

P

pairing
 ANT+ sensors **5, 24**
 smartphone **1, 26**
performance condition **7, 9**
personal records **14**
 deleting **14**
power (force) **8**
 alerts **20**
 meters **8, 9, 24, 31**
 zones **11**

profiles **2**
 user **10**
projected finish time **9**

R

racing **14**
recovery **7–9**
replacing the battery **26**
resetting the device **26**
routes **15**
running dynamics **6, 7**

S

satellite signals **26**
scorecard **4**
screen **23**
segments **13**
settings **12, 18, 19, 21–23, 26**
shortcuts **1, 23**
Sight 'N Go **15**
skiing
 alpine **2**
 snowboarding **2**
sleep mode **12**
smartphone **18, 26**
 applications **16, 18**
 pairing **1, 26**
snowboarding **2**
software
 license **23**
 updating **1, 17**
 version **23**
specifications **25**
speed **21**
speed and cadence sensors **24**
statistics **4**
stopwatch **14**
storing data **17**
stress level **9**
stress score **9**
stride length **6**
strokes **3**
sunrise and sunset times **14**
swimming **3, 5**
swing analysis **4**
swolf score **3**
system settings **23**

T

target **13**
tempe **25, 27**
temperature **25, 27**
time
 alerts **20**
 settings **23**
 zones and formats **23**
time zones **14**
timer **16**
 countdown **14**
tones **2, 14**
TracBack **2, 15**
tracks **15**
training **13, 14, 16**
 plans **12, 13**
Training Effect **7, 10**
training load **9**
training status **8**
triathlon training **3**
troubleshooting **5–7, 26, 27**

U

UltraTrac **21**
unit ID **23**
units of measure **23**
updates, software **17**
uploading data **17**
USB **17**
 disconnecting **25**
user data, deleting **25**
user profile **10**

V

vertical oscillation **6**
vertical ratio **6**
VIRB remote **18, 19**
Virtual Partner **13, 14**
VO2 max. **7–9, 31**

W

watch faces **18, 21**
watch mode **21**
water resistance **25**
waypoints, projecting **15**
wheel sizes **31**
Wi-Fi, connecting **18**
widgets **1, 5, 18**
workouts **12**
 loading **12**

Z

zones
 heart rate **11**
 power **11**
 time **14**

support.garmin.com



1800 235 822



+43 (0) 820 220230



+ 32 2 672 52 54



0800 770 4960



1-866-429-9296



+385 1 5508 272
+385 1 5508 271



+420 221 985466
+420 221 985465



+ 45 4810 5050



+ 358 9 6937 9758



+ 331 55 69 33 99



+ 39 02 36 699699



(+52) 001-855-792-7671



0800 427 652



0800 0233937



+47 815 69 555



00800 4412 454
+44 2380 662 915



+35 1214 447 460



+386 4 27 92 500



0861 GARMIN (427 646)
+27 (0)11 251 9800



+34 93 275 44 97



+ 46 7744 52020



+886 2 2642-9199 ext 2



0808 238 0000
+44 870 850 1242



+49 (0) 89 858364880
zum Ortstarif - Mobilfunk kann
abweichen



913-397-8200
1-800-800-1020

