

GARMIN[®]

GPSMAP[®] 8000 Series



Owner's Manual

Table of Contents

Introduction	1	Waypoints.....	9
GPSMAP 8000 Series Front View.....	1	Marking Your Present Location as a Waypoint.....	9
Using the Touchscreen.....	1	Creating a Waypoint at a Different Location.....	9
Locking the Touchscreen.....	1	Marking an SOS Location.....	9
Accessing Owner's Manuals on the Chartplotter.....	1	Viewing a List of all Waypoints.....	9
Downloading the Manuals.....	1	Editing a Saved Waypoint.....	9
Getting More Information.....	1	Moving a Saved Waypoint.....	9
Inserting a Memory Card.....	1	Browsing for and Navigating to a Saved Waypoint.....	9
Software Update.....	1	Deleting a Waypoint or an MOB.....	9
Loading the New Software on a Memory Card.....	1	Deleting All Waypoints.....	9
Updating the Device Software.....	1	Setting and Following a Direct Course Using Go To.....	9
GPS Satellite Signals.....	2	Routes.....	9
Selecting the GPS Source.....	2	Creating and Navigating a Route From Your Present Location.....	9
Customizing the Chartplotter	2	Creating and Saving a Route.....	10
Home Screen.....	2	Viewing a List of Routes.....	10
Adding an Item to Favorites.....	2	Editing a Saved Route.....	10
Customizing the Layout of a SmartMode or Combination Page.....	2	Browsing for and Navigating a Saved Route.....	10
Adding a SmartMode Layout.....	2	Browsing for and Navigating Parallel to a Saved Route.....	10
Adding a Custom Combination Screen.....	2	Deleting a Saved Route.....	10
Resetting the Station Layouts.....	3	Deleting All Saved Routes.....	10
Setting the Vessel Type.....	3	Auto Guidance.....	10
Adjusting the Backlight.....	3	Setting and Following an Auto Guidance Path.....	10
Adjusting the Color Mode.....	3	Creating and Saving an Auto Guidance Path.....	11
Charts and 3D Chart Views	3	Adjusting a Saved Auto Guidance Path.....	11
Navigation Chart and Offshore Fishing Chart.....	3	Canceling an Auto Guidance Calculation in Progress.....	11
Zooming In and Out Using the Touchscreen.....	3	Setting a Timed Arrival.....	11
Selecting a Map.....	3	Auto Guidance Line Configurations.....	11
Measuring a Distance on the Chart.....	3	Tracks.....	12
Chart Symbols.....	3	Showing Tracks.....	12
Showing a Different Chart.....	3	Setting the Color of the Active Track.....	12
Creating a Waypoint on the Chart.....	4	Saving the Active Track.....	12
Viewing Location and Object Information on a Chart.....	4	Viewing a List of Saved Tracks.....	12
Viewing Details about NavAids.....	4	Editing a Saved Track.....	12
Navigating to a Point on the Chart.....	4	Saving a Track as a Route.....	12
Premium Charts.....	4	Browsing for and Navigating a Recorded Track.....	12
Viewing Tide Station Information.....	4	Deleting a Saved Track.....	12
Showing Satellite Imagery on the Navigation Chart.....	5	Deleting All Saved Tracks.....	12
Viewing Aerial Photos of Landmarks.....	5	Retracing the Active Track.....	12
Automatic Identification System.....	5	Clearing the Active Track.....	12
AIS Targeting Symbols.....	5	Managing the Track Log Memory During Recording.....	12
Heading and Projected Course of Activated AIS Targets.....	5	Configuring the Recording Interval of the Track Log.....	12
Showing AIS and MARPA Vessels on a Chart or on a 3D Chart View.....	6	Stopping Navigation.....	12
Activating a Target for an AIS Vessel.....	6	Synchronizing User Data Across the Garmin Marine Network.....	12
Viewing a List of AIS and MARPA Threats.....	6	Deleting All Saved Waypoints, Routes, and Tracks.....	13
Setting the Safe-Zone Collision Alarm.....	6	Sailing Features	13
AIS Distress Signals.....	6	Setting the Vessel Type.....	13
Turning Off AIS Reception.....	6	Sail Racing.....	13
Chart and 3D Chart View Settings.....	7	Starting Line Guidance.....	13
Navigation and Fishing Chart Setup.....	7	Setting the Starting Line.....	13
Waypoints and Tracks Settings on the Charts and Chart Views.....	7	Using the Starting Line Guidance.....	13
Chart Appearance Settings.....	7	Starting the Race Timer.....	13
Other Vessels Settings on the Charts and Chart Views.....	7	Stopping the Race Timer.....	13
Laylines Settings.....	8	Setting the Distance between the Bow and the GPS Antenna.....	13
Fish Eye 3D Settings.....	8	Laylines Settings.....	13
Navigation with a Chartplotter	8	Setting the Keel Offset.....	13
Basic Navigation Questions.....	8	Sailboat Autopilot Operation.....	14
Destinations.....	8	Wind Hold.....	14
Searching for a Destination by Name.....	8	Tack and Gybe.....	14
Selecting a Destination Using the Navigation Chart.....	8	Sonar	14
Searching for a Marine Services Destination.....	8	Sonar Views.....	14
		Traditional Sonar View.....	14
		DownVü Sonar View.....	15
		SideVü Sonar View.....	15

Split-Zoom Sonar View	15	Stopping the Transmission of Radar Signals	23
Split-Frequency Sonar View	15	Optimizing the Radar Display	23
Panoptix™ Sonar Views	15	Radar Gain and Clutter	23
Changing the Sonar View	16	Echo Trails	24
Creating a Waypoint on the Sonar Screen	16	Radar Display Settings	24
Measuring Distance on the Sonar Screen	16	Radar Appearance Settings	24
Pausing the Sonar Display	16	Front-of-Boat Offset	25
Viewing Sonar History	16	Selecting a Different Radar Source	25
Sonar Sharing	16	Autopilot	25
Selecting a Sonar Source	17	Opening the Autopilot Screen	25
Renaming a Sonar Source	17	Autopilot Screen	25
Adjusting the Level of Detail	17	Adjusting the Step Steering Increment	25
Adjusting the Color Intensity	17	Setting the Power Saver	25
Adjusting the Range of the Depth or Width Scale	17	Enabling Shadow Drive™	25
Setting the Zoom Level on the Sonar Screen	17	Engaging the Autopilot	25
Setting the Scroll Speed	17	Adjusting the Heading with the Helm	25
Sonar Frequencies	18	Adjusting the Heading with the Chartplotter in Step Steering Mode	25
Selecting Frequencies	18	Steering Patterns	26
Creating a Frequency Preset	18	Following the U-Turn Pattern	26
Customizing the Panoptix Sonar Views	18	Setting Up and Following the Circles Pattern	26
Adjusting the Appearance of the LiveVü Sonar Views	18	Setting Up and Following the Zigzag Pattern	26
Setting the LiveVü Transducer Transmit Angle	18	Following the Williamson Turn Pattern	26
Adjusting the RealVü Viewing Angle and Zoom Level	18	Following an Orbit Pattern	26
Adjusting the Appearance of the RealVü Sonar Views	18	Setting Up and Following the Cloverleaf Pattern	26
Adjusting the RealVü Sweep Speed	18	Setting Up and Following a Search Pattern	26
Turning On the A-Scope	18	Cancelling a Steering Pattern	26
Selecting the Transducer Type	18	Digital Selective Calling	26
Sonar Setup	19	Networked Chartplotter and VHF Radio Functionality	26
Sonar Settings	19	Turning On DSC	26
RealVü Sonar Settings	19	DSC List	26
LiveVü Sonar Settings	19	Viewing the DSC List	26
Sonar Noise Rejection Settings	19	Adding a DSC Contact	27
Sonar Appearance Settings	19	Incoming Distress Calls	27
Sonar Alarm Settings	19	Navigating to a Vessel in Distress	27
Advanced Sonar Settings	20	Man-Overboard Distress Calls Initiated from a VHF Radio	27
Transducer Installation Settings	20	Man-Overboard and SOS Distress Calls Initiated from the Chartplotter	27
Sonar Recordings	20	Position Tracking	27
Recording the Sonar Display	20	Viewing a Position Report	27
Stopping the Sonar Recording	20	Navigating to a Tracked Vessel	27
Deleting a Sonar Recording	20	Creating a Waypoint at the Position of a Tracked Vessel	27
Playing Sonar Recordings	20	Editing Information in a Position Report	27
Radar	20	Deleting a Position-Report Call	27
Radar Display Modes	21	Viewing Vessel Trails on the Chart	27
Changing the Radar Mode	21	Individual Routine Calls	27
Transmitting Radar Signals	21	Selecting a DSC Channel	27
Adjusting the Radar Range	21	Making an Individual Routine Call	28
Tips for Selecting a Radar Range	21	Making an Individual Routine Call to an AIS Target	28
Zooming In and Out of the Radar Screen	21	Gauges and Graphs	28
Marking a Waypoint on the Radar Screen	21	Viewing the Gauges	28
Sentry Mode	21	Changing the Data Shown in a Gauge	28
Enabling Timed Transmit	21	Customizing Engine Gauge and Fuel Gauge Limits	28
Setting the Standby and Transmit Times	21	Viewing Engine and Fuel Gauges	28
Enabling a Guard Zone	21	Selecting the Number of Engines Shown in Gauges	28
Defining a Circular Guard Zone	21	Customizing the Engines Shown in Gauges	28
Defining a Partial Guard Zone	21	Enabling Status Alarms for Engine Gauges	28
Radar Targeting and MARPA	22	Enabling Some Engine Gauge Status Alarms	28
MARPA Targeting Symbols	22	Setting the Fuel Alarm	28
Assigning a MARPA Tag to an Object	22	Setting the Fuel Capacity of the Vessel	28
Viewing a List of AIS and MARPA Threats	22	Synchronizing the Fuel Data with the Actual Vessel Fuel	28
Showing AIS Vessels on the Radar Screen	22	Viewing the Wind Gauges	28
VRM and EBL	22	Configuring the Sailing Wind Gauge	29
Radar Overlay	23	Configuring the Speed Source	29
Radar Overlay and Chart Data Alignment	23		
Showing the Radar Overlay	23		
Setting a Custom Park Position	23		
Enabling and Adjusting a Radar No Transmit Zone	23		

Configuring the Heading Source of the Wind Gauge	29	Visibility Information	33
Customizing the Close-Hauled Wind Gauge	29	Viewing Forecast Visibility Information for Another Time	
Viewing Trip Gauges	29	Period	34
Resetting Trip Gauges	29	Viewing Buoy Reports	34
Viewing Graphs	29	Viewing Local Weather Information near a Buoy	34
Setting the Graph Range and Time Scales	29	Creating a Waypoint on a Weather Chart	34
Tide, Current, and Celestial Information	29	Weather Overlay	34
Tide Station Information	29	Turning On the Weather Overlay on a Chart	34
Current Station Information	29	Weather Overlay Settings on the Navigation Chart	34
Celestial Information	29	Weather Overlay Settings on the Fishing Chart	34
Viewing Tide Station, Current Station, or Celestial Information		Viewing Weather Subscription Information	34
for a Different Date	29	Viewing Video	34
Viewing Information for a Different Tide or Current Station	30	Selecting a Video Source	34
Viewing Almanac Information from the Navigation Chart	30	Alternating Among Multiple Video Sources	34
Warning Manager	30	Networked Video Devices	34
Viewing Messages	30	Using Video Presets on Networked Video Cameras	34
Sorting and Filtering Messages	30	Camera Settings	35
Saving Messages to a Memory Card	30	Video Settings	35
Clearing all of the Messages	30	Associating the Camera to a Video Source	35
Media Player	30	Video Camera Movement Control	35
Opening the Media Player	30	Creating a Combination with Video Functions	35
Icons	30	Configuring the Video Appearance	35
Selecting the Media Source	30	Configuring the PC Display	36
Playing Music	30	Exiting PC Display Mode	36
Browsing for Music	30	Device Configuration	36
Setting a Song to Repeat	30	Turning On the Chartplotter Automatically	36
Setting All Songs to Repeat	30	System Settings	36
Setting Songs to Shuffle	30	Station Settings	36
Listening to the Radio	30	Viewing System Software Information	36
Opening the MTP Source	30	Viewing the Event Log	36
Adjusting the Volume	31	Preferences Settings	36
Enabling and Disabling Zones	31	Units Settings	36
Muting the Media Volume	31	Navigation Settings	36
Scanning VHF Channels	31	Communications Settings	37
Adjusting the VHF Squelch	31	NMEA 0183 Settings	37
SiriusXM® Satellite Radio	31	NMEA 2000 Settings	38
Locating a SiriusXM Radio ID	31	Garmin Marine Network	38
Activating a SiriusXM Subscription	31	Setting Alarms	38
Customizing the Channel Guide	31	Navigation Alarms	38
Saving a SiriusXM Channel to the Presets List	31	System Alarms	38
Unlocking SiriusXM Parental Controls	31	Setting the Fuel Alarm	38
Setting the Device Name	31	Setting Weather Alarms	38
SiriusXM Weather	32	My Vessel Settings	38
SiriusXM Equipment and Subscription Requirements	32	Setting the Keel Offset	38
Weather Data Broadcasts	32	Setting the Water Temperature Offset	38
Changing the Weather Chart	32	Calibrating a Water Speed Device	39
Viewing Precipitation Information	32	Setting the Vessel Type	39
Precipitation Views	32	Other Vessels Settings	39
Storm Cell and Lightning Information	32	Restoring the Original Chartplotter Factory Settings	39
Hurricane Information	32	Communication with Wireless Devices	39
Weather Warnings and Weather Bulletins	32	Setting Up the Wi-Fi® Wireless Network	39
Forecast Information	32	Connecting a Wireless Device to the Chartplotter	39
Viewing Forecast Information for Another Time Period	32	Changing the Wireless Channel	39
Weather Fronts and Pressure Centers	32	Changing the Wi-Fi Host	39
Viewing a Marine Forecast or an Offshore Forecast	33	Wireless Remote Control	39
City Forecasts	33	Pairing the Wireless Remote Control With the	
Viewing Sea Conditions	33	Chartplotter	39
Surface Winds	33	Turning On and Off the Remote Backlight	39
Wave Height, Wave Period, and Wave Direction	33	Disconnecting the Remote from All Chartplotters	40
Viewing Forecast Sea Conditions Information for Another		Using the Garmin Helm Application with the Chartplotter	40
Time Period	33	Chartplotter Data Management	40
Viewing Fishing Information	33	Copying Waypoints, Routes, and Tracks from HomePort to a	
Surface Pressure and Water Temperature Data	33	Chartplotter	40
Forecasting Fish Locations	33	Selecting a File Type for Third-Party Waypoints and Routes	40
Changing the Sea Surface Temperature Color Range	33	Copying Data from a Memory Card	40

Copying Waypoints, Routes, and Tracks to a Memory Card	40
Copying Built-In Maps to a Memory Card	40
Backing Up Data to a Computer	40
Restoring Backup Data to a Chartplotter	40
Saving System Information to a Memory Card	40
Appendix	40
Registering Your Device	40
Digital Switching	40
Rotating the GRID Joystick	40
Cleaning the Screen	41
Screenshots	41
Capturing Screenshots	41
Copying Screenshots to a Computer	41
Troubleshooting	41
My device will not acquire GPS signals	41
My device will not turn on or keeps turning off	41
My device is not creating waypoints in the correct location	41
NMEA 0183 Information	41
NMEA 2000 PGN Information	42
Software License Agreement	42
Index	43

Introduction

⚠ WARNING

See the *Important Safety and Product Information* guide in the product box for product warnings and other important information.

The Garmin® website at www.garmin.com presents up-to-date information about your product. The support pages will provide answers to frequently asked support questions, and you can download software and chart updates. There is also contact information to Garmin support should you have any questions.

GPSMAP 8000 Series Front View

The location of items varies based upon the model. This image and table are representations of the GPSMAP 8000 series devices.



①	Power key
②	Automatic backlight sensor
③	Touchscreen

Using the Touchscreen

- Tap the screen to select an item.
- Drag or swipe your finger across the screen to pan or scroll.
- Pinch two fingers together to zoom out.
- Spread two fingers apart to zoom in.

Locking the Touchscreen

You can lock the touchscreen to prevent inadvertent screen touches.

- 1 Select .
- 2 Select **Lock Touchscreen**.

Accessing Owner's Manuals on the Chartplotter

- 1 Select **Info > Owner's Manual**.
- 2 Select a manual.
- 3 Select **Open**.

Downloading the Manuals

You can get the latest owner's manual and translations of manuals from the web.

- 1 Go to www.garmin.com/manuals/GPSMAP8000.

TIP: To quickly open this web page, scan this code:



- 2 Download the manual.

Getting More Information

If you have any questions about your device, you can contact Garmin Product Support.

The website, www.garmin.com/support, offers many different troubleshooting tips to help resolve most issues and answer most questions.

- Frequently-asked questions (FAQs)
- Software updates
- Owner's and installation manuals
- Service alerts
- Video
- Contact numbers and addresses

Inserting a Memory Card

You can use optional memory cards in the chartplotter. Map cards allow you to view high-resolution satellite imagery and aerial reference photos of ports, harbors, marinas, and other points of interest. You can use blank memory cards to transfer data such as waypoints, routes, and tracks to another compatible chartplotter or a computer.

- 1 Open the door ① on the memory card reader.



- 2 Insert the memory card ② with the label facing away from the door.
- 3 Press the card in until it clicks.
- 4 Close the card reader door.

Software Update

You may need to update the device software when you install the device or add an accessory to the device.

Loading the New Software on a Memory Card

- 1 Insert a memory card into the card slot on the computer.
- 2 Go to www.garmin.com/support/software/marine.html.
- 3 Select **Download** next to **Garmin Marine Network with SD card**.
- 4 Read and agree to the terms.
- 5 Select **Download**.
- 6 Select **Run**.
- 7 Select the drive associated with the memory card, and select **Next > Finish**.

Updating the Device Software

Before you can update the software, you must obtain a software-update memory card or load the latest software onto a memory card.



- 1 Turn on the chartplotter.
- 2 After the home screen appears, insert the memory card into the card slot.
NOTE: In order for the software update instructions to appear, the device must be fully booted before the card is inserted.
- 3 Follow the on-screen instructions.
- 4 Wait several minutes while the software update process completes.

The device returns to normal operation after the software update process is complete.

- 5 Remove the memory card.

NOTE: If the memory card is removed before the device restarts fully, the software update is not complete.

GPS Satellite Signals

When you turn on the chartplotter, the GPS receiver must collect satellite data and establish the current location. When the chartplotter acquires satellite signals,  appears at the top of the Home screen. When the chartplotter loses satellite signals,  disappears and a flashing question mark appears over  on the chart.

For more information about GPS, go to www.garmin.com/aboutGPS.

Selecting the GPS Source

You can select your preferred source for GPS data, if you have more than one GPS source.

- 1 Select **Settings > System > GPS > Source**.
- 2 Select the source for GPS data.

Customizing the Chartplotter

Home Screen

The chartplotter home screen provides access to all of the features in the chartplotter. The features are dependant on the accessories you have connected to the chartplotter. You may not have all of the options and features discussed in this manual.

The categories along the right of the screen provide quick access to the main features of your chartplotter. For example, the Sonar category displays the views and pages related to the sonar feature. You can save items you commonly access to the Favorites category.

All of the options along the bottom of the home screen are visible on all other screens, except for the Settings button. The Settings button is accessible only from the home screen.

When viewing another screen, you can return to the home screen by selecting Home.

When multiple displays are installed on the Garmin Marine Network, you can group them together into a station. A station enables the displays to work together, instead of as several separate displays. When you select Home on one display, each display in the station returns to the home screen. You can customize the layout of the pages on each display, making each page different on each display. When you change the layout of a page in one display, the changes appear on only that display. When you change the name and symbol of the layout, those changes appear on all displays in the station, to maintain a consistent appearance.

The SmartMode™ items are geared toward an activity, such as cruising or docking. When a SmartMode button is selected from the home screen, each display in the station can show unique information. For example, when Cruising is selected from the home screen, one display can show the navigation chart and another display can show the radar screen.

Adding an Item to Favorites

- 1 From the home screen, select a category from the right.
- 2 Hold a button.

The item is added to the Favorites home screen category.

Customizing the Layout of a SmartMode or Combination Page

You can customize the layout and data shown in the combination pages and SmartMode layouts. When you change the layout of a page in a display you are interacting with, the change appears only on that display, except for the SmartMode name and symbol. When you change the SmartMode name or

symbol for the layout, the new name or symbol appears on all displays in the station.

- 1 Open a page to customize.
- 2 Select **Menu**.
- 3 Select **Edit Layout** or **Edit Combo**.
- 4 Select an option:
 - To change the name, select **Name** or **Name & Symbol > Name**, enter a new name, and select **Done**.
 - To change the SmartMode symbol, select **Name & Symbol > Symbol**, and select a new symbol.
 - To change the number of functions shown, select **Functions**, and select a number.
 - To change the function of the portion of the screen, select the area to change, and select a function from the list on the right.
 - To change the vertical or horizontal split orientation of a multi-function display, select **Split**, and select an option.
 - To change how data appears on the page, select **Overlays**, and select an option.
 - To change the type of data shown, select **Overlays**, select a data field, and select the new data type.

Adding a SmartMode Layout

You can add SmartMode layouts to suit your needs. Each customization made to one SmartMode layout for the home screen in a station appears on all displays in the station.

- 1 From the home screen, select **SmartMode™ > Menu > Add Layout**.
- 2 Select an option:
 - To change the name, select **Name & Symbol > Name**, enter a new name, and select **Done**.
 - To change the symbol, select **Name & Symbol > Symbol**, and select a new symbol.
 - To change the number of functions shown, select **Functions**, and select a number.
 - To change the function of the portion of the screen, select the area to change, and select a function from the list on the right.
 - To change the vertical or horizontal split orientation of a multi-function display, select **Split**, and select an option.
 - To change how data appears on the page, select **Overlays**, and select an option.
 - To change the type of data shown, select **Overlays**, select a data field, and select the new data type.

Adding a Custom Combination Screen

You can create a custom combination screen to suit your needs.

- 1 Select **Combos > Menu > Add Combo**.
- 2 Select an option:
 - To change the name, select **Name**, enter a new name, and select **Done**.
 - To change the number of functions shown, select **Functions**, and select a number.
 - To change the function of the portion of the screen, select the area to change, and select a function from the list on the right.
 - To change the vertical or horizontal split orientation of a multi-function display, select **Split**, and select an option.
 - To change how data appears on the page, select **Overlays**, and select an option.
 - To change the type of data shown, select **Overlays**, select a data field, and select the new data type.

Resetting the Station Layouts

You can restore the factory default layouts for all stations.

Select **Settings > System > Station Information > Reset Stations**.

Setting the Vessel Type

You can select your boat type to configure the chartplotter settings and to use features customized for your boat type.

- 1 Select **Settings > My Vessel > Vessel Type**.
- 2 Select **Powerboat** or **Sailboat**.

Adjusting the Backlight

- 1 Select **Settings > System > Beeper and Display > Backlight**.

TIP: Press  from any screen to open the backlight settings.

- 2 Select an option:
 - Adjust the backlight level.
 - Select **Auto**.

Adjusting the Color Mode

- 1 Select **Settings > System > Beeper and Display > Color Mode**.

TIP: Press  from any screen to access the color settings.

- 2 Select an option.

Charts and 3D Chart Views

The charts and 3D chart views that are available depend on the map data and accessories used.

You can access the charts and 3D chart views by selecting **Charts**.

Navigation Chart: Shows navigation data available on your pre-loaded maps and from supplemental maps, if available. The data includes buoys, lights, cables, depth soundings, marinas, and tide stations in an overhead view.

Perspective 3D: Provides a view from above and behind the boat (according to your course) and provides a visual navigation aid. This view is helpful when navigating tricky shoals, reefs, bridges, or channels, and is beneficial when trying to identify entry and exit routes in unfamiliar harbors or anchorages.

Mariner's Eye 3D: Shows a detailed, three-dimensional view from above and behind the boat (according to your course) and provides a visual navigation aid. This view is helpful when navigating tricky shoals, reefs, bridges, or channels, and when trying to identify entry and exit routes in unfamiliar harbors or anchorages.

NOTE: Mariner's Eye 3D and Fish Eye 3D chart views are available with premium charts, in some areas.

Fish Eye 3D: Provides an underwater view that visually represents the sea floor according to the chart information. When a sonar transducer is connected, suspended targets (such as fish) are indicated by red, green, and yellow spheres. Red indicates the largest targets and green indicates the smallest.

Fishing Chart: Provides a detailed view of the bottom contours and depth soundings on the chart. This chart removes navigational data from the chart, provides detailed bathymetric data, and enhances bottom contours for depth recognition. This chart is best for offshore deep-sea fishing.

NOTE: The offshore Fishing chart is available with premium charts, in some areas.

Radar Overlay: Superimposes radar information on the Navigation chart or the Fishing chart, when the chartplotter is

connected to a radar. This feature is not available with all models.

Navigation Chart and Offshore Fishing Chart

NOTE: The offshore Fishing chart is available with premium charts, in some areas.

The Navigation and Fishing charts allow you to plan your course, view map information, and follow a route. The Fishing chart is for offshore fishing.

To open the Navigation chart, select **Charts > Nav Chart**.

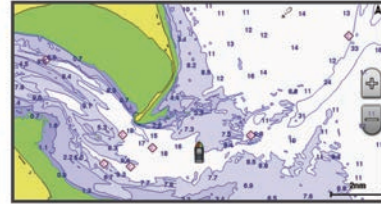

To open the Fishing chart, select **Charts > Fishing Chart**.

Zooming In and Out Using the Touchscreen

You can quickly zoom in and out of many screens, such as the charts and sonar views.

- Pinch two fingers together to zoom out.
- Spread two fingers apart to zoom in.

Selecting a Map

If your product has both BlueChart® g2 and LakeVü™ HD built-in maps, you can select which map to use. Not all models have both types of built-in maps.

- 1 From the Navigation chart, select **Menu > Built-In Map**.
- 2 Select an option:
 - When you are on an inland lake, select **LakeVü™ HD**.
 - When you are offshore, select **BlueChart® g2**.

Measuring a Distance on the Chart







- 1 From a chart or the Radar overlay, select a location.
- 2 Select **Measure Distance**.

A push pin appears on the screen at your present location. The distance and angle from the pin is listed in the upper-left corner.

TIP: To reset the pin and measure from the current location of the cursor, select **Set Reference**.

Chart Symbols

This table contains some of the common symbols you might see on the detailed charts.

Icon	Description
	Buoy
	Information
	Marine services
	Tide station
	Current station
	Overhead photo available
	Perspective photo available

Other features common to most charts include depth contour lines, intertidal zones, spot soundings (as depicted on the original paper chart), navigational aids and symbols, obstructions, and cable areas.

Showing a Different Chart

- 1 From a combination screen or SmartMode layout with a chart, select **Menu > Chart Menu > Change Chart**.

- 2 Select a chart or 3D chart view.

Creating a Waypoint on the Chart

- 1 From a chart or a 3D chart view, select a location or object.
A list of options appears along the right side of the chart. The options that appear vary based on the location or object you selected.
- 2 Select **Create Waypoint**.

Viewing Location and Object Information on a Chart

You can view information about a location or an object on the Navigation chart or the Fishing chart.

NOTE: The offshore Fishing chart is available with premium charts, in some areas.

- 1 From the Navigation chart or Fishing chart, select a location or object.
A list of options appears along the right side of the chart. The options that appear vary based on the location or object you selected.
- 2 Select an option:
 - To navigate to the selected location, select **Navigate To**.
 - To mark a waypoint at the cursor location, select **Create Waypoint**.
 - To view the distance and bearing of the object from your current location, select **Measure Distance**.
The distance and bearing appear on the screen. Select **Select** to measure from a location other than your current location.
 - To view tide, current, celestial, chart notes, or local services information near the cursor, select **Information**.

Viewing Details about Nav aids

From the Navigation chart, Fishing chart, Perspective 3D chart view, or Mariner's Eye 3D chart view, you can view details about various types of navigation aids, including beacons, lights, and obstructions.

NOTE: The offshore Fishing chart is available with premium charts, in some areas.

NOTE: Mariner's Eye 3D and Fish Eye 3D chart views are available with premium charts, in some areas.

- 1 From a chart or 3D chart view, select a nav aid.
- 2 Select the name of the nav aid.

Navigating to a Point on the Chart

CAUTION

The Auto Guidance feature is based on electronic chart information. That data does not ensure obstacle and bottom clearance. Carefully compare the course to all visual sightings, and avoid any land, shallow water, or other obstacles that may be in your path.

When using Go To, a direct course and a corrected course may pass over land or shallow water. Use visual sightings, and steer to avoid land, shallow water, and other dangerous objects.

NOTE: The offshore Fishing chart is available with premium charts, in some areas.

NOTE: Auto Guidance is available with premium charts, in some areas.

- 1 From the Navigation chart or Fishing chart, select a location.
- 2 If necessary, select **Select**.
- 3 Select **Navigate To**.
- 4 Select an option:
 - To navigate directly to the location, select **Go To**.
 - To create a route to the location, including turns, select **Route To**.

- To use Auto Guidance, select **Auto Guidance**.

- 5 Review the course indicated by the magenta line.

NOTE: When using Auto Guidance, a gray segment within any part of the magenta line indicates that Auto Guidance cannot calculate part of the Auto Guidance line. This is due to the settings for minimum safe water depth and minimum safe obstacle height.

- 6 Follow the magenta line, steering to avoid land, shallow water, and other obstacles.

Premium Charts

CAUTION

The Auto Guidance feature is based on electronic chart information. That data does not ensure obstacle and bottom clearance. Carefully compare the course to all visual sightings, and avoid any land, shallow water, or other obstacles that may be in your path.

NOTE: Not all models support all charts.

Optional premium charts, such as BlueChart g2 Vision®, allow you to get the most out of your chartplotter. In addition to detailed marine charting, premium charts may contain these features, which are available in some areas.

Mariner's Eye 3D: Provides a view from above and behind the boat for a three-dimensional navigation aid.

Fish Eye 3D: Provides an underwater, three-dimensional view that visually represents the sea floor according to the information on the chart.

Fishing Charts: Shows the chart with enhanced bottom contours and without navigational data. This chart works well for offshore deep-sea fishing.

High Resolution Satellite Imagery: Provides high-resolution satellite images for a realistic view of the land and water on the Navigation chart ([Showing Satellite Imagery on the Navigation Chart](#)).

Aerial Photos: Shows marinas and other navigationally significant aerial photos to help you visualize your surroundings ([Viewing Aerial Photos of Landmarks](#)).

Detailed Roads and POI data: Shows detailed road and point of interest (POI) data, which includes highly detailed coastal roads and POIs such as restaurants, lodging, and local attractions.

Auto Guidance: Uses specified safe depth, safe height, and chart data to determine the best course to your destination. Auto Guidance is available when you navigate to a destination using Guide To.

Viewing Tide Station Information

◆ on the chart indicates a tide station. You can view a detailed graph for a tide station to help predict the tide level at different times or on different days.

NOTE: This feature is available with premium charts, in some areas.

- 1 From the Navigation chart or Fishing chart, select a tide station.
Tide direction and tide level information appear near ◆.
- 2 Select the station name.

Animated Tide and Current Indicators

NOTE: This feature is available with premium charts, in some areas.

You can view indicators for animated tide station and current direction on the Navigation chart or the Fishing chart. You must also enable animated icons in the chart settings ([Showing Tides and Current Indicators](#)).

An indicator for a tide station appears on the chart as a vertical bar graph with an arrow. A red arrow pointing downward indicates a falling tide, and a blue arrow pointing upward indicates a rising tide. When you move the cursor over the tide station indicator, the height of the tide at the station appears above the station indicator.

Current direction indicators appear as arrows on the chart. The direction of each arrow indicates the direction of the current at a specific location on the chart. The color of the current arrow indicates the range of speed for the current at that location. When you move the cursor over the current direction indicator, the specific current speed at the location appears above the direction indicator.

Color	Current Speed Range
Yellow	0 to 1 knot
Orange	1 to 2 knots
Red	2 or more knots

Showing Tides and Current Indicators

NOTE: This feature is available with premium charts, in some areas.

You can show static or animated tide and current station indicators on the Navigation chart or Fishing chart.

- From the Navigation or Fishing chart, select **Menu > Chart Setup > Tides & Currents**.
- Select an option:
 - To show current station indicators and tide station indicators on the chart, select **On**.
 - To show animated tide station indicators and animated current direction indicators on the chart, select **Animated**.

Showing Satellite Imagery on the Navigation Chart

NOTE: This feature is available with premium charts, in some areas.

You can overlay high-resolution satellite images on the land or on both land and sea portions of the Navigation chart.

NOTE: When enabled, high-resolution satellite images are present only at lower zoom levels. If you cannot see high-resolution images in your optional chart region, you can select **+** to zoom in. You also can set the detail level higher by changing the map zoom detail.



- From the Navigation chart, select **Menu > Chart Setup > Satellite Photos**.
- Select an option:
 - Select **Land Only** to show standard chart information on the water, with photos overlaying the land.
 - Select **Photo Map** to show photos on both the water and the land at a specified opacity. Use the slider bar to adjust the photo opacity. The higher you set the percentage, the more the satellite photos cover both land and water.

Viewing Aerial Photos of Landmarks

Before you can view aerial photos on the Navigation chart, you must turn on the Satellite Photos setting in the chart setup.

NOTE: This feature is available with premium charts, in some areas.

You can use aerial photographs of landmarks, marinas, and harbors to help orient yourself to your surroundings or to acquaint yourself with a marina or a harbor prior to arrival.

- From the Navigation chart, select a camera icon:
 - To view an overhead photo, select .
 - To view a perspective photo, select . The photo was taken from the location of the camera, pointed in the direction of the cone.
- Select **Aerial Photo**.







Automatic Identification System

The Automatic Identification System (AIS) enables you to identify and track other vessels, and alerts you to area traffic. When connected to an external AIS device, the chartplotter can show some AIS information about other vessels that are within range, that are equipped with a transponder, and that are actively transmitting AIS information.

The information reported for each vessel includes the Maritime Mobile Service Identity (MMSI), location, GPS speed, GPS heading, time that has elapsed since the last position of the vessel was reported, nearest approach, and time to the nearest approach.

Some chartplotter models also support Blue Force Tracking. Vessels being tracked with Blue Force Tracking are indicated on the chartplotter with a blue-green color.

AIS Targeting Symbols

Symbol	Description
	AIS vessel. The vessel is reporting AIS information. The direction in which the triangle is pointing indicates the direction in which the AIS vessel is moving.
	Target is selected.
	Target is activated. The target appears larger on the chart. A green line attached to the target indicates the heading of the target. The MMSI, speed, and direction of the vessel appear beneath the target, if the details setting has been set to Show. If the AIS transmission from the vessel is lost, a message banner appears.
	Target is lost. A green X indicates that the AIS transmission from the vessel is lost, and the chartplotter displays a message banner asking whether the vessel should continue to be tracked. If you discontinue vessel tracking, the lost target symbol disappears from the chart or the 3D chart view.
	Dangerous target in range. The target flashes while an alarm sounds and a message banner appears. After the alarm has been acknowledged, a solid red triangle with a red line attached to it indicates the location and the heading of the target. If the safe-zone collision alarm has been set to Off, the target flashes, but the audible alarm does not sound and the alarm banner does not appear. If the AIS transmission from the vessel is lost, a message banner appears.
	Dangerous target is lost. A red X indicates that the AIS transmission from the vessel is lost, and the chartplotter displays a message banner asking whether the vessel should continue to be tracked. If you discontinue vessel tracking, the lost dangerous target symbol disappears from the chart or the 3D chart view.
	The location of this symbol indicates the closest point of approach to a dangerous target, and the numbers near the symbol indicate the time to the closest point of approach to that target.

NOTE: Vessels being tracked with the Blue Force Tracking feature are indicated with a blue-green color regardless of their status.

Heading and Projected Course of Activated AIS Targets

When heading and course over ground information are provided by an activated AIS target, the heading of the target appears on a chart as a solid line attached to the AIS target symbol. A heading line does not appear on a 3D chart view.

The projected course of an activated AIS target appears as a dashed line on a chart or a 3D chart view. The length of the projected course line is based on the value of the projected heading setting. If an activated AIS target is not transmitting speed information, or if the vessel is not moving, a projected course line does not appear. Changes in the speed, course over ground, or rate of turn information transmitted by the vessel can impact the calculation of the projected course line.

When course over ground, heading, and rate of turn information are provided by an activated AIS target, the projected course of

the target is calculated based on the course over ground and the rate of turn information. The direction in which the target is turning, which is also based on the rate of turn information, is indicated by the direction of the barb at the end of the heading line. The length of the barb does not change.



When course over ground and heading information are provided by an activated AIS target, but rate of turn information is not provided, the projected course of the target is calculated based on the course over ground information.

Showing AIS and MARPA Vessels on a Chart or on a 3D Chart View

Before you can show AIS vessels on a chart, you must have an external AIS device and active transponder signals from other vessels. Mini Automatic Radar Plotting Aid (MARPA) functionality works with radar.

You can configure how other vessels appear on a chart or on a 3D chart view. The display range and MARPA settings configured for one chart or one 3D chart view are applied only to that chart or to that 3D chart view. The details, projected heading, and trails settings configured for one chart or one 3D chart view are applied to all charts and to all 3D chart views.

- 1 From a chart or a 3D chart view, select **Menu > Other Vessels > Display Setup**.
- 2 Select an option:
 - To indicate the distance from your location in which AIS vessels appear, select **Display Range**, and select a distance.
 - To show MARPA-tagged vessels, select **MARPA > Show**.
 - To show details about AIS-activated and MARPA-tagged vessels, select **Details > Show**.
 - To set the projected heading time for AIS-activated and MARPA-tagged vessels, select **Proj. Heading**, and enter the time.
 - To show the tracks of AIS vessels, select the length of the track that appears using a trail, select **Trails**, and select the length.

Activating a Target for an AIS Vessel

- 1 From a chart or a 3D chart view, select an AIS vessel.
- 2 Select **AIS Vessel > Activate Target**.

Viewing Information about a Targeted AIS Vessel

You can view the AIS signal status, MMSI, GPS speed, GPS heading, and other information that is reported about a targeted AIS vessel.

- 1 From a chart or a 3D chart view, select an AIS vessel.
- 2 Select **AIS Vessel**.

Deactivating a Target for an AIS Vessel

- 1 From a chart or a 3D chart view, select an AIS vessel.
- 2 Select **AIS Vessel > Deactivate**.

Viewing a List of AIS and MARPA Threats

- 1 From a chart or a 3D chart view, select **Menu > Other Vessels > List > Show**.
- 2 Select the type of threats to include in the list.

Setting the Safe-Zone Collision Alarm

Before you can set a collision alarm, you must have a compatible chartplotter connected to an AIS device or radar.

The safe-zone collision alarm is used only with AIS and MARPA. MARPA functionality works with radar. The safe zone is used for collision avoidance and can be customized.

- 1 Select **Settings > Alarms > AIS > Collision Alarm > On**.

A message banner appears and an alarm sounds when a MARPA-tagged object or an AIS-activated vessel enters the safe-zone area around your boat. The object is also labeled as dangerous on the screen. When the alarm is off, the message banner and audible alarm are disabled, but the object is still labeled as dangerous on the screen.

- 2 Select **Range**.
- 3 Select a distance for the safe-zone radius around your vessel.
- 4 Select **Time To**.
- 5 Select a time at which the alarm will sound if a target is determined to intersect the safe zone.

For example, to be notified of a pending intersection 10 minutes before it will likely occur, set Time To to 10, and the alarm will sound 10 minutes before the vessel intersects the safe zone.

AIS Distress Signals

Self-contained AIS distress signal devices transmit emergency position reports when activated. The chartplotter can receive signals from Search and Rescue Transmitters (SART), Emergency Position Indicating Radio Beacons (EPIRB), and other man overboard signals. Distress signal transmissions are different than standard AIS transmissions, so they appear differently on the chartplotter. Instead of tracking a distress signal transmission for collision avoidance, you track a distress signal transmission to locate and assist a vessel or person.

Navigating to a Distress Signal Transmission

When you receive a distress signal transmission, a distress signal alarm appears.

Select **Review > Go To** to begin navigation to the transmission.

AIS Distress Signal Device Targeting Symbols

Symbol	Description
	AIS distress signal device transmission. Select to see more information about the transmission and begin navigation.
	Transmission lost.
	Transmission test. Appears when a vessel initiates a test of their distress signal device, and does not represent a true emergency.
	Transmission test lost.

Enabling AIS Transmission Test Alerts

To avoid a large number of test alerts and symbols in crowded areas such as marinas, you can select to receive or ignore AIS test messages. To test an AIS emergency device, you must enable the chartplotter to receive test alerts.

- 1 Select **Settings > Alarms > AIS**.
- 2 Select an option:
 - To receive or ignore Emergency Position Indicating Radio Beacon (EPRIB) test signals, select **AIS-EPIRB Test**.
 - To receive or ignore Man Overboard (MOB) test signals, select **AIS-MOB Test**.
 - To receive or ignore Search and Rescue Transponder (SART) test signals, select **AIS-SART Test**.

Turning Off AIS Reception

AIS signal reception is turned on by default.

Select **Settings > Other Vessels > AIS > Off**.

All AIS functionality on all charts and 3D chart views is disabled. This includes AIS vessel targeting and tracking, collision alarms that result from AIS vessel targeting and tracking, and the display of information about AIS vessels.

Chart and 3D Chart View Settings

NOTE: Not all settings apply to all charts and 3D chart views. Some options require premium maps or connected accessories, such as radar.

These settings apply to the charts and 3D chart views, except the radar overlay and Fish Eye 3D ([Fish Eye 3D Settings](#)).

From a chart or a 3D chart view, select Menu.

Waypoints and Tracks: See [Waypoints and Tracks Settings on the Charts and Chart Views](#).

Other Vessels: See [Other Vessels Settings on the Charts and Chart Views](#).

Surface Radar: Shows surface radar details on the Perspective 3D or Mariner's Eye 3D chart views.

Weather Radar: Shows weather radar imaging on the Perspective 3D or Mariner's Eye 3D chart views.

Nav aids: Shows navigational aids on the Fishing chart.

Laylines: Adjusts the laylines, when in sailing mode ([Laylines Settings](#)).

Chart Setup: See [Navigation and Fishing Chart Setup](#).

Chart Appearance: See [Chart Appearance Settings](#). This might appear in the Chart Setup menu.

Navigation and Fishing Chart Setup

NOTE: Not all settings apply to all charts and 3D chart views. Some settings require external accessories or applicable premium charts.

From the Navigation chart or Fishing chart, select **Menu > Chart Setup**.

Satellite Photos: Shows high-resolution satellite images on the land or on both land and sea portions of the Navigation chart, when certain premium maps are used [Showing Satellite Imagery on the Navigation Chart](#).

Water Overlay: Enables relief shading, which shows the gradient of the bottom with shading, or sonar imagery, which helps identify the density of the bottom. This feature is available only with some premium maps.

Tides & Currents: Shows current station indicators and tide station indicators on the chart [Showing Tides and Current Indicators](#) and enables the tides and current slider, which sets the time for which tides and currents are reported on the map.

Roses: Shows a compass rose around your boat, indicating compass direction oriented to the heading of the boat. A true wind direction or apparent wind direction indicator appears if the chartplotter is connected to a compatible marine wind sensor. When in sailing mode, true and apparent wind are shown on the wind rose.

Lake Level: Sets the present water level of the lake. This feature is available only with some premium maps.

Inset Map: Shows a small map centered on your present location.

Weather: Sets which weather items are shown on the chart, when the chartplotter is connected to a compatible weather receiver with an active subscription. Requires a compatible, connected antenna and an active subscription.

Chart Appearance: See [Chart Appearance Settings](#).

Waypoints and Tracks Settings on the Charts and Chart Views

From a chart or a 3D chart view, select **Menu > Waypoints and Tracks**.

Tracks: Shows tracks on the chart or 3D chart view.

Waypoints: Shows the list of waypoints ([Viewing a List of all Waypoints](#)).

Create Waypoint: Creates a new waypoint.

Waypoint Display: Sets how to display waypoints on the chart.

Active Tracks: Shows the active track options menu.

Saved Tracks: Shows the list of saved tracks ([Viewing a List of Saved Tracks](#)).

Tracks Display: Sets which tracks to display on the chart based on track color.

Chart Appearance Settings

You can adjust the appearance of the different charts and 3D chart views. Each setting is specific to the chart or chart view being used.

NOTE: Not all settings apply to all charts and 3D chart views and chartplotter models. Some options require premium maps or connected accessories.

From a chart or 3D chart view, select **Menu > Chart Setup > Chart Appearance**.

Orientation: Sets the perspective of the map.

Detail: Adjusts the amount of detail shown on the map, at different zoom levels.

Heading Line: Shows and adjusts the heading line, which is a line drawn on the map from the bow of the boat in the direction of travel, and sets the data source for the heading line.

World Map: Uses either a basic world map or a shaded relief map on the chart. These differences are visible only when zoomed out too far to see the detailed charts.

Spot Depths: Turns on spot soundings and sets a dangerous depth. Spot depths that are equal to or more shallow than the dangerous depth are indicated by red text.

Safety Shading: Sets the shades from the shoreline to the specified depth.

Depth Range Shading: Specifies an upper and lower depth to shade between.

Symbols: Shows and configures the appearance of various symbols on the chart, such as the vessel icon, navaid symbols, land POIs, and light sectors.

Inset Map: Shows a map zoomed in on the vessel's location in the corner of the main map.

Style: Sets how the chart appears over 3D terrain.

Hazard Colors: Shows shallow water and land with a color scale. Blue indicates deep water, yellow is shallow water, and red is very shallow water.

Safe Depth: Sets the appearance of a safe depth for the Mariner's Eye 3D chart view.

NOTE: This setting affects only the appearance of hazard colors for the Mariner's Eye 3D chart view. It does not affect the safe water depth Auto Guidance setting or the sonar shallow water alarm setting.

Range Rings: Shows and configures the appearance of range rings, which help you to visualize distances in some chart views.

Lane Width: Specifies the width of the navigation lane, which is the magenta line in some chart views that indicates the course to your destination.

Other Vessels Settings on the Charts and Chart Views

NOTE: These options require connected accessories, such as an AIS receiver or VHF radio.

From a chart or a 3D chart view, select **Menu > Other Vessels**.

List: Shows a list of AIS and MARPA vessels.

DSC: Shows the DSC list and sets the DSC trails on the chart.

Collision Alarm: Sets the safe-zone collision alarm ([Setting the Safe-Zone Collision Alarm](#)).

Display Setup: See [Showing AIS and MARPA Vessels on a Chart or on a 3D Chart View](#).

Laylines Settings

When in sailing mode ([Setting the Vessel Type](#)), you can display laylines on the navigation chart. Laylines can be very helpful when racing.

From the navigation chart, select **Menu > Sailing > Laylines**.

Display: Sets how the laylines and vessel are shown on the chart, and sets the length of the laylines.

Sailing Ang.: Allows you to select how the device calculates laylines. The Actual option calculates the laylines using the measured wind angle from the wind sensor. The Manual option calculates the laylines using manually entered windward and leeward angles.

Tide Correction: Corrects the laylines based on the tide.

Fish Eye 3D Settings

NOTE: This feature is available with premium charts, in some areas.

From the Fish Eye 3D chart view, select Menu.

View: Sets the perspective of the 3D chart view.

Tracks: Shows tracks.

Sonar Cone: Shows a cone that indicates the area covered by the transducer.

Fish Symbols: Shows suspended targets.

Navigation with a Chartplotter

CAUTION

If your vessel has an autopilot system, a dedicated autopilot control display must be installed at each steering helm in order to disable the autopilot system.

The Auto Guidance feature is based on electronic chart information. That data does not ensure obstacle and bottom clearance. Carefully compare the course to all visual sightings, and avoid any land, shallow water, or other obstacles that may be in your path.

When using Go To, a direct course and a corrected course may pass over land or shallow water. Use visual sightings, and steer to avoid land, shallow water, and other dangerous objects.

NOTE: Auto Guidance is available with premium charts, in some areas.

NOTE: Mariner's Eye 3D and Fish Eye 3D chart views are available with premium charts, in some areas.

NOTE: The offshore Fishing chart is available with premium charts, in some areas.

To navigate, you must choose a destination, set a course or create a route, and follow the course or route. You can follow the course or the route on the Navigation chart, Fishing chart, Perspective 3D chart view, or Mariner's Eye 3D chart view.

You can set and follow a course to a destination using one of three methods: Go To, Route To, or Auto Guidance.

Go To: Takes you directly to the destination. This is the standard option for navigating to a destination. The chartplotter creates a straight-line course or navigation line to the destination. The path may run over land and other obstacles.

Route To: Creates a route from your location to a destination, allowing you to add turns along the way. This option provides a straight-line course to the destination, but allows you to add turns into the route to avoid land and other obstacles.

Auto Guidance: Creates a path to a destination using Auto Guidance. This option is available only when using a compatible premium chart in a compatible chartplotter. It

provides a turn-by-turn navigation line to the destination, avoiding land and other obstacles. The navigation line is based on the chart data and the safe depth, safe height, and shoreline distance user-defined chartplotter settings. Using these settings and chart data, the chartplotter creates a navigation line that avoids all areas that cannot be navigated between the present location and the destination.

When you are using a compatible Garmin autopilot connected to the chartplotter using NMEA 2000®, the autopilot follows the Auto Guidance route.

Basic Navigation Questions

Question	Answer
How do I make the chartplotter point me in the direction in which I want to go (bearing)?	Navigate using Go To. See Setting and Following a Direct Course Using Go To .
How do I make the device guide me along a straight line (minimizing cross track) to a location using the shortest distance from the present location?	Build a single-leg route and navigate it using Route To. See Creating and Navigating a Route From Your Present Location .
How do I make the device guide me to a location while avoiding charted obstacles?	Build a multi-leg route and navigate it using Route To. See Creating and Navigating a Route From Your Present Location .
How do I make the device steer my automatic pilot?	Navigate using Route To. See Creating and Navigating a Route From Your Present Location .
Can the device create a path for me?	If you have premium maps that support Auto Guidance and are in an area covered by Auto Guidance, navigate using Auto Guidance. See Setting and Following an Auto Guidance Path .
How do I change the Auto Guidance settings for my boat?	See Auto Guidance Line Configurations .

Destinations

You can select destinations using various charts and 3D chart views or using the lists.

Searching for a Destination by Name

You can search for saved waypoints, saved routes, saved tracks, and marine services destinations by name.

- 1 Select **Info > Services > Search by Name**.
- 2 Enter at least a portion of the name of your destination.
- 3 If necessary, select **Done**.
The 50 nearest destinations that contain your search criteria appear.
- 4 Select the destination.

Selecting a Destination Using the Navigation Chart

From the Navigation chart, select a destination.

Searching for a Marine Services Destination

NOTE: This feature is available with premium charts, in some areas.

The chartplotter contains information for thousands of destinations offering marine services.

- 1 Select **Info > Services**.
- 2 Select **Offshore Services** or **Inland Services**.
- 3 If necessary, select the marine service category.
The chartplotter shows a list of the nearest locations and the distance and bearing to each.
- 4 Select a destination.
You can select Next Page or Previous Page to view additional information or to show the location on a chart.

Waypoints

Waypoints are locations you record and store in the device.

Marking Your Present Location as a Waypoint

From any screen, select **Mark**.

Creating a Waypoint at a Different Location

- 1 Select **Info > User Data > Waypoints > Create Waypoint**.
- 2 Select an option:
 - To create the waypoint by entering position coordinates, select **Enter Coordinates**, and enter the coordinates.
 - To create the waypoint using a chart, select **Use Chart**, select the location, and select **Select**.

Marking an SOS Location

You can mark an SOS location. When a Garmin VHF radio is connected using NMEA 2000, you can select different SOS types, such as Man Overboard and Piracy.

- 1 From the Home screen, select **SOS**.
- 2 Select the SOS type.
- 3 If necessary, select **OK** to navigate to the man overboard location.

If you selected OK, the chartplotter sets a direct course back to the location. If you selected another type of SOS, the call details are sent to the VHF radio. You must send the call using the radio.

Viewing a List of all Waypoints

Select **Info > User Data > Waypoints**.

Editing a Saved Waypoint

- 1 Select **Info > User Data > Waypoints**.
- 2 Select a waypoint.
- 3 Select **Review > Edit**.
- 4 Select an option:
 - To add a name, select **Name**, and enter a name.
 - To change the symbol, select **Symbol**.
 - To change the depth, select **Depth**.
 - To change the water temperature, select **Water Temp..**
 - To change the comment, select **Comment**.

Moving a Saved Waypoint

- 1 Select **Info > User Data > Waypoints**.
- 2 Select a waypoint.
- 3 Select **Review > Move**.
- 4 Indicate a new location for the waypoint:
 - To move the waypoint while using the chart, select **Use Chart**, select a new location on the chart, and select **Move Waypoint**.
 - To move the waypoint using coordinates, select **Enter Coordinates**, and enter the new coordinates.

Browsing for and Navigating to a Saved Waypoint

CAUTION

The Auto Guidance feature is based on electronic chart information. That data does not ensure obstacle and bottom clearance. Carefully compare the course to all visual sightings, and avoid any land, shallow water, or other obstacles that may be in your path.

When using Go To, a direct course and a corrected course may pass over land or shallow water. Use visual sightings, and steer to avoid land, shallow water, and other dangerous objects.

NOTE: Auto Guidance is available with premium charts, in some areas.

Before you can navigate to a waypoint, you must create a waypoint.

- 1 Select **Info > User Data > Waypoints**.
- 2 Select a waypoint.
- 3 Select **Navigate To**.
- 4 Select an option:
 - To navigate directly to the location, select **Go To**.
 - To create a route to the location, including turns, select **Route To**.
 - To use Auto Guidance, select **Auto Guidance**.
- 5 Review the course indicated by the magenta line.

NOTE: When using Auto Guidance, a gray segment within any part of the magenta line indicates that Auto Guidance cannot calculate part of the Auto Guidance line. This is due to the settings for minimum safe water depth and minimum safe obstacle height.
- 6 Follow the magenta line, steering to avoid land, shallow water, and other obstacles.

Deleting a Waypoint or an MOB

- 1 Select **Info > User Data > Waypoints**.
- 2 Select a waypoint or an MOB.
- 3 Select **Review > Delete**.

Deleting All Waypoints

Select **Info > User Data > Clear User Data > Waypoints > All**.

Setting and Following a Direct Course Using Go To

CAUTION

When using Go To, a direct course and a corrected course may pass over land or shallow water. Use visual sightings, and steer to avoid land, shallow water, and other dangerous objects.

You can set and follow a direct course from your current location to a selected destination.

- 1 Select a destination ([Destinations](#)).
- 2 Select **Navigate To > Go To**.

A magenta line appears. In the center of the magenta line is a thinner purple line that represents the corrected course from your current location to the destination. The corrected course is dynamic, and it moves with your boat when you are off course.
- 3 Follow the magenta line, steering to avoid land, shallow water, and other obstacles.
- 4 If you are off course, follow the purple line (corrected course) to go to your destination, or steer back to the magenta line (direct course).

Routes

Creating and Navigating a Route From Your Present Location

You can create and immediately navigate a route on the Navigation chart or the Fishing chart. This procedure does not save the route or the waypoint data.

NOTE: The offshore Fishing chart is available with premium charts, in some areas.

- 1 From the Navigation chart or Fishing chart, select a destination.
- 2 Select **Navigate To > Route To**.
- 3 Select the location of the last turn before the destination.
- 4 Select **Add Turn**.

5 If necessary, repeat step 3 and 4 to add additional turns, working backward from the destination to the present location of your vessel.

The last turn you add should be the first turn you make, starting from your present location. It should be the turn closest to your vessel.

6 If necessary, select **Menu**.

7 Select **Navigate Route**.

8 Review the course indicated by the magenta line.

9 Follow the magenta line, steering to avoid land, shallow water, and other obstacles.

Creating and Saving a Route

This procedure saves the route and all the waypoints in it. The starting point can be your present location or another location.

1 Select **Info > User Data > Routes & Auto Guidance Paths > New > Use Chart**.

2 Select the starting location of the route.

3 Select **Add Turn**.

4 Select the location of the next turn on the chart.

5 Select **Add Turn**.

The chartplotter marks the location of the turn with a waypoint.

6 If necessary, repeat steps 4 and 5 to add more turns.

7 Select the final destination.

Viewing a List of Routes

Select **Info > User Data > Routes & Auto Guidance Paths**.

Editing a Saved Route

You can change the name of a route or change the turns the route contains.

1 Select **Info > User Data > Routes & Auto Guidance Paths**.

2 Select a route.

3 Select **Review > Edit Route**.

4 Select an option:

- To change the name, select **Name**, and enter the name.
- To select a waypoint from the turn list, select **Edit Turns > Use Turn List**, and select a waypoint from the list.
- To select a turn using the chart, select **Edit Turns > Use Chart**, and select a location on the chart.

Browsing for and Navigating a Saved Route

Before you can browse a list of routes and navigate to one of them, you must create and save at least one route.

1 Select **Info > User Data > Routes & Auto Guidance Paths**.

2 Select a route.

3 Select **Navigate To**.

4 Select an option:

- To navigate the route from the starting point used when the route was created, select **Forward**.
- To navigate the route from the destination point used when the route was created, select **Backward**.

A magenta line appears. In the center of the magenta line is a thinner purple line that represents the corrected course from your present location to the destination. The corrected course is dynamic, and it moves with your boat when you are off course.

5 Review the course indicated by the magenta line.

6 Follow the magenta line along each leg in the route, steering to avoid land, shallow water, and other obstacles.

7 If you are off course, follow the purple line (corrected course) to go to your destination, or steer back to the magenta line (direct course).

Browsing for and Navigating Parallel to a Saved Route

Before you can browse a list of routes and navigate to one of them, you must create and save at least one route.

1 Select **Info > User Data > Routes & Auto Guidance Paths**.

2 Select a route.

3 Select **Navigate To**.

4 Select **Offset** to navigate parallel to the route, offset from it by a specific distance.

5 Indicate how to navigate the route:

- To navigate the route from the starting point used when the route was created, to the left of the original route, select **Forward - Port**.
- To navigate the route from the starting point used when the route was created, to the right of the original route, select **Forward - Starboard**.
- To navigate the route from the destination point used when the route was created, to the left of the original route, select **Backward - Port**.
- To navigate the route from the destination point used when the route was created, to the right of the original route, select **Backward - Starboard**.

6 If necessary, select **Done**.

A magenta line appears. In the center of the magenta line is a thinner purple line that represents the corrected course from your present location to the destination. The corrected course is dynamic, and it moves with your boat when you are off course.

7 Review the course indicated by the magenta line.

8 Follow the magenta line along each leg in the route, steering to avoid land, shallow water, and other obstacles.

9 If you are off course, follow the purple line (corrected course) to go to your destination, or steer back to the magenta line (direct course).

Deleting a Saved Route

1 Select **Info > User Data > Routes & Auto Guidance Paths**.

2 Select a route.

3 Select **Review > Delete**.

Deleting All Saved Routes

Select **Info > User Data > Clear User Data > Routes & Auto Guidance Paths**.

Auto Guidance

⚠ CAUTION

The Auto Guidance feature is based on electronic chart information. That data does not ensure obstacle and bottom clearance. Carefully compare the course to all visual sightings, and avoid any land, shallow water, or other obstacles that may be in your path.

NOTE: Auto Guidance is available with premium charts, in some areas.

You can use Auto Guidance to plot the best path to your destination. Auto Guidance uses your chartplotter to scan chart data, such as water depth and known obstacles, to calculate a suggested path. You can adjust the path during navigation.

Setting and Following an Auto Guidance Path

1 Select a destination ([Destinations](#)).

2 Select **Navigate To > Auto Guidance**.

- 3 Review the path, indicated by the magenta line.
- 4 Select **Start Navigation**.
- 5 Follow the magenta line, steering to avoid land, shallow water, and other obstacles.

NOTE: When using Auto Guidance, a gray segment within any part of the magenta line indicates that Auto Guidance cannot calculate part of the Auto Guidance line. This is due to the settings for minimum safe water depth and minimum safe obstacle height.

Creating and Saving an Auto Guidance Path

- 1 Select **Info > User Data > Routes & Auto Guidance Paths > New > Auto Guidance**.
- 2 Select a starting point, and select **Next**.
- 3 Select a destination, and select **Next**.
- 4 Select an option:
 - To view a hazard and adjust the hazard path, select **Hazard Review**.
 - To adjust the path, select **Adjust Path**, and follow the on-screen instructions.
 - To delete the path, select **Cancel Auto Guidance**.
 - To save the path, select **Done**.

Adjusting a Saved Auto Guidance Path

- 1 Select **Info > User Data > Routes & Auto Guidance Paths**.
- 2 Select a path, and select **Review > Edit > Adjust Path**.
TIP: When navigating an Auto Guidance path, select the path on the navigation chart, and select **Adjust Path**.
- 3 Select a location on the path.
- 4 Drag the point to a new location.
- 5 If necessary, select a point, and select **Remove**.
- 6 Select **Done**.

Canceling an Auto Guidance Calculation in Progress

From the Navigation chart, select **Menu > Cancel**.

TIP: You can select **Back** to quickly cancel the calculation.

Setting a Timed Arrival

You can use the Timed Arrival feature on a route or an Auto Guidance path to get feedback regarding when you should arrive at a selected point. This allows you to time your arrival at a location, such as a bridge opening or a race starting line.

- 1 From the Navigation chart, select **Menu**.
- 2 If necessary, select **Navigation Options**.
- 3 Select **Timed Arrival**.

TIP: You can quickly open the Timed Arrival menu by selecting a point on the Auto Guidance path.

Auto Guidance Line Configurations

CAUTION

The Safe Depth and Safe Height settings influence how the chartplotter calculates an Auto Guidance line. If an area has an unknown water depth or an unknown obstacle height, the Auto Guidance line is not calculated in that area. If an area at the beginning or the end of an Auto Guidance line is shallower than the safe water depth or lower than the safe obstacle height, the Auto Guidance line is not calculated in that area. On the chart, the course through those areas appears as a gray line. When your boat enters one of those areas, a warning message appears.

NOTE: Auto Guidance is available with premium charts, in some areas.

You can set the parameters the chartplotter uses when calculating an Auto Guidance line.

Safe Depth: Sets the minimum depth (chart depth datum) the chartplotter uses when calculating an Auto Guidance line.

NOTE: The minimum safe depth for the premium charts is 3 feet. If you enter a Safe Depth value of less than 3 feet, the charts only use depths of 3 feet for Auto Guidance route calculations.

Safe Height: Sets the minimum height (chart height datum) of a bridge that your boat can safely travel under.

Shoreline Distance: Sets how close to the shore you want the Auto Guidance line to be placed. The Auto Guidance line may move if you change this setting while navigating. The available values for this setting are relative, not absolute. To ensure that the Auto Guidance line is placed the appropriate distance from shore, you can assess the placement of the Auto Guidance line using one or more familiar destinations that require navigation through a narrow waterway ([Adjusting the Distance from Shore](#)).

Adjusting the Distance from Shore

The Shoreline Distance setting indicates how close to the shore you want the Auto Guidance line to be placed. The Auto Guidance line may move if you change this setting while navigating. The available values for the Shoreline Distance setting are relative, not absolute. To ensure the Auto Guidance line is placed the appropriate distance from shore, you can assess the placement of the Auto Guidance line using one or more familiar destinations that require navigation through a narrow waterway.

- 1 Dock your vessel or drop the anchor.
- 2 Select **Settings > Preferences > Navigation > Auto Guidance > Shoreline Distance > Normal**.
- 3 Select a destination that you have navigated to previously.
- 4 Select **Navigate To > Auto Guidance**.
- 5 Review the placement of the Auto Guidance line, and determine whether the line safely avoids known obstacles and the turns enable efficient travel.
- 6 Select an option:
 - If the placement of the Auto Guidance line is satisfactory, select **Menu > Navigation Options > Stop Navigation**, and proceed to step 10.
 - If the Auto Guidance line is too close to known obstacles, select **Settings > Preferences > Navigation > Auto Guidance > Shoreline Distance > Far**.
 - If the turns in the Auto Guidance line are too wide, select **Settings > Preferences > Navigation > Auto Guidance > Shoreline Distance > Near**.
- 7 If you selected **Near** or **Far** in step 6, review the placement of the Auto Guidance line, and determine whether the line safely avoids known obstacles and the turns enable efficient travel.

Auto Guidance maintains a wide clearance from obstacles in open water, even if you set the Shoreline Distance setting to **Near** or **Nearest**. As a result, the chartplotter may not reposition the Auto Guidance line, unless the destination selected requires navigation through a narrow waterway.

- 8 Select an option:
 - If the placement of the Auto Guidance line is satisfactory, select **Menu > Navigation Options > Stop Navigation**, and proceed to step 10.
 - If the Auto Guidance line is too close to known obstacles, select **Settings > Preferences > Navigation > Auto Guidance > Shoreline Distance > Farthest**.
 - If the turns in the Auto Guidance line are too wide, select **Settings > Preferences > Navigation > Auto Guidance > Shoreline Distance > Nearest**.
- 9 If you selected **Nearest** or **Farthest** in step 8, review the placement of the **Auto Guidance** line, and determine

whether the line safely avoids known obstacles and the turns enable efficient travel.

Auto Guidance maintains a wide clearance from obstacles in open water, even if you set the Shoreline Distance setting to Near or Nearest. As a result, the chartplotter may not reposition the Auto Guidance line, unless the destination selected requires navigation through a narrow waterway.

- 10 Repeat steps 3 through 9 at least once more, using a different destination each time, until you are familiar with the functionality of the Shoreline Distance setting.

Tracks

A track is a recording of the path of your boat. The track currently being recorded is called the active track, and it can be saved. You can show tracks in each chart or 3D chart view.

Showing Tracks

From any chart or a 3D chart view, select **Menu > Waypoints and Tracks > Tracks > On**.

A trailing line on the chart indicates your track.

Setting the Color of the Active Track

- 1 Select **Info > User Data > Tracks > Active Track Options > Track Color**.
- 2 Select a track color.

Saving the Active Track

The track currently being recorded is called the active track.

- 1 Select **Info > User Data > Tracks > Save Active Track**.
- 2 Select an option:
 - Select the time the active track began.
 - Select **Entire Log**.
- 3 Select **Save**.

Viewing a List of Saved Tracks

Select **Info > User Data > Tracks > Saved Tracks**.

Editing a Saved Track

- 1 Select **Info > User Data > Tracks > Saved Tracks**.
- 2 Select a track.
- 3 Select **Edit Track**.
- 4 Select an option:
 - Select **Name**, and enter the new name.
 - Select **Track Color**, and select a color.

Saving a Track as a Route

- 1 Select **Info > User Data > Tracks > Saved Tracks**.
- 2 Select a track.
- 3 Select **Select > Edit Track > Save Route**.

Browsing for and Navigating a Recorded Track

Before you can browse a list of tracks and navigate to them, you must record and save at least one track ([Tracks](#)).

- 1 Select **Info > User Data > Tracks > Saved Tracks**.
- 2 Select a track.
- 3 Select **Follow Track**.
- 4 Select an option:
 - To navigate the track from the starting point used when the track was created, select **Forward**.
 - To navigate the track from the destination point used when the track was created, select **Backward**.
- 5 Review the course indicated by the colored line.
- 6 Follow the line along each leg in the route, steering to avoid land, shallow water, and other obstacles.

Deleting a Saved Track

- 1 Select **Info > User Data > Tracks > Saved Tracks**.
- 2 Select a track.
- 3 Select **Select > Delete**.

Deleting All Saved Tracks

Select **Info > User Data > Clear User Data > Saved Tracks**.

Retracing the Active Track

The track currently being recorded is called the active track.

- 1 Select **Info > User Data > Tracks > Follow Active Track**.
- 2 Select an option:
 - Select the time the active track began.
 - Select **Entire Log**.
- 3 Review the course indicated by the colored line.
- 4 Follow the colored line, steering to avoid land, shallow water, and other obstacles.

Clearing the Active Track

Select **Info > User Data > Tracks > Clear Active Track**.

The track memory is cleared, and the active track continues to be recorded.

Managing the Track Log Memory During Recording

- 1 Select **Info > User Data > Tracks > Active Track Options**.
- 2 Select **Record Mode**.
- 3 Select an option:
 - To record a track log until the track memory is full, select **Fill**.
 - To continuously record a track log, replacing the oldest track data with new data, select **Wrap**.

Configuring the Recording Interval of the Track Log

You can indicate the frequency at which the track plot is recorded. Recording more frequent plots is more accurate but fills the track log faster. The resolution interval is recommended for the most efficient use of memory.

- 1 Select **Info > User Data > Tracks > Active Track Options > Interval > Interval**.
- 2 Select an option:
 - To record the track based on a distance between points, select **Distance > Change**, and enter the distance.
 - To record the track based on a time interval, select **Time > Change**, and enter the time interval.
 - To record the track plot based on a variance from your course, select **Resolution > Change**, and enter the maximum error allowed from the true course before recording a track point.

Stopping Navigation

While navigating, from the Navigation or Fishing chart, select an option:

- Select **Menu > Stop Navigation**.
- When navigating with Auto Guidance, select **Menu > Navigation Options > Stop Navigation**.

Synchronizing User Data Across the Garmin Marine Network

NOTICE

Before you synchronize the user data across the network, you should backup your user data to prevent possible data loss. See [Backing Up Data to a Computer](#).

You can share waypoints, tracks, and routes with all compatible devices connected to the Garmin Marine Network (Ethernet) automatically.

NOTE: This feature is not available on all models.

Select **Settings > Preferences > User Data Sharing > On**.

If a change is made to a waypoint, track, or route on one chartplotter, that data is synchronized automatically across all chartplotters on the Ethernet network.

Deleting All Saved Waypoints, Routes, and Tracks

Select **Info > User Data > Clear User Data > All > OK**.

Sailing Features

Setting the Vessel Type

You can select your boat type to configure the chartplotter settings and to use features customized for your boat type.

- 1 Select **Settings > My Vessel > Vessel Type**.
- 2 Select **Powerboat** or **Sailboat**.

Sail Racing

You can use the device to increase the likelihood that your boat will cross the start line of a race exactly when the race begins. When you synchronize the race timer with the official race countdown timer, you are alerted at one-minute intervals as the race start approaches. When you combine the race timer with the virtual start line, the device measures your speed, bearing, and remaining time on the countdown timer. The device uses this data to indicate whether your boat will cross the start line before, after, or at the correct time to start the race.

Starting Line Guidance

Sailing start line guidance is a visual representation of the information you need to cross the start line at the optimal time and speed.

After you set the starboard and port start line pins, and the target speed and time, and after you start the race timer, a predictor line appears. The predictor line extends from your current location toward the start line and the laylines that extend from each pin.

The end point and color of the predictor line indicate where the boat will be when the timer expires, based on your current boat speed.

When the end point is before the start line, the line is white. This indicates the boat must increase speed to reach the start line on time.

When the end point is past the start line, the line is red. This indicates the boat must reduce speed to avoid a penalty for reaching the start line before the timer expires.

When the end point is on the start line, the line is white. This indicates the boat is moving at an optimal speed to reach the start line when the timer expires.

By default, the start line guidance window and the race timer window appear in the Sail Racing combination screen.

Setting the Starting Line

The start line guidance window is added to the Sail Racing combination screen by default.

- 1 From the Sail Racing combination screen, select **Menu > Start Line Guidance > Start Line**.
- 2 Select an option:
 - To mark the port and starboard starting line marks as you sail past them, select **Ping Marks**.

- To mark the port and starboard starting line marks by entering their coordinates, select **Enter Coordinates**.
- To switch the position of the port and starboard marks after you have set them, select **Swap Port & Starbd. Marks**.

Using the Starting Line Guidance

You can use the starting line guidance feature to help get you cross the start line, at the optimal speed during a sailing race.

- 1 Mark the starting line ([Setting the Starting Line](#)).
- 2 From the Sail Racing combination screen, select **Menu > Start Line Guidance > Target Speed**, and select your target speed when crossing the starting line.
- 3 Select **Target Time**, and select the target time to cross the starting line.
- 4 Select **Back**.
- 5 Start the racing timer ([Starting the Race Timer](#)).

Starting the Race Timer

The race timer is added to the Sail Racing combination screen by default.

- 1 From the Sail Racing combination screen, select **Start**.
NOTE: You can also access this from the Sailing SmartMode screen and the navigation chart.
- 2 When necessary, select **Sync** to synchronize with the official race timer.

Stopping the Race Timer

From the Sail Racing combination screen, select **Stop**.

Setting the Distance between the Bow and the GPS Antenna

You can enter the distance between the bow of your boat and the location of your GPS antenna. This helps ensure the bow of your boat crosses the starting line at the precise start time.

- 1 From a navigation chart, select **Sailing > Start Line > GPS Bow Offset**.
- 2 Enter the distance.
- 3 Select **Done**.

Laylines Settings

When in sailing mode ([Setting the Vessel Type](#)), you can display laylines on the navigation chart. Laylines can be very helpful when racing.

From the navigation chart, select **Menu > Sailing > Laylines**.

Display: Sets how the laylines and vessel are shown on the chart, and sets the length of the laylines.

Sailing Ang.: Allows you to select how the device calculates laylines. The Actual option calculates the laylines using the measured wind angle from the wind sensor. The Manual option calculates the laylines using manually entered windward and leeward angles.

Tide Correction: Corrects the laylines based on the tide.

Setting the Keel Offset

You can enter a keel offset to compensate the surface reading for the depth of a keel, making it possible to measure depth from the bottom of the keel instead of from the transducer location. Enter a positive number to offset for a keel. You can enter a negative number to compensate for a large vessel that may draw several feet of water.

- 1 Complete an action, based on the location of the transducer:
 - If the transducer is installed at the water line ①, measure the distance from the transducer location to the keel of the boat. Enter this value in steps 3 and 4 as a positive number.

- If the transducer is installed at the bottom of the keel ②, measure the distance from the transducer to the water line. Enter this value in steps 3 and 4 as a negative number.

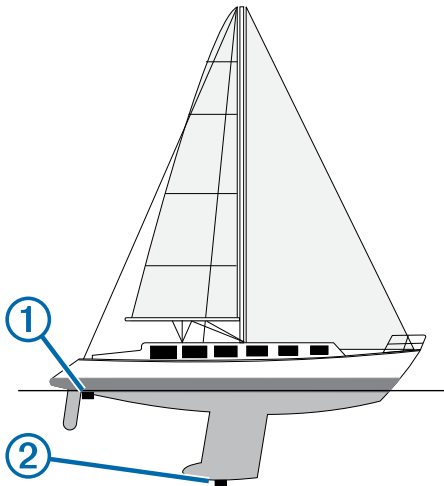

- 2 Select **Settings > My Vessel > Keel Offset**.
- 3 Select **+** or **-** based on the location of the transducer.
- 4 Enter the distance measured in step 1.

Sailboat Autopilot Operation

⚠ CAUTION

When engaged, the autopilot controls only the rudder. You and your crew remain responsible for the sails while the autopilot is engaged.

In addition to heading hold, you can use the autopilot to maintain a wind hold. You can also use the autopilot to control the rudder while tacking and gybing.

Wind Hold

You can set the autopilot to maintain a specific bearing relative to the current wind angle. Your device must be connected to a NMEA 2000 or NMEA® 0183 compatible wind sensor to perform a wind hold or a wind-based tack or gybe.

Setting the Wind Hold Type

Before you can enable the wind hold type, you must connect a NMEA 2000 or NMEA 0183 wind sensor to the autopilot.

For advanced autopilot configuration, see the installation instructions included with your autopilot.

- 1 From the autopilot screen, select **Menu > Autopilot Setup > Wind Hold Type**.
- 2 Select **Apparent** or **True**.

Engaging Wind Hold

Before you can enable the wind hold type, you must connect a NMEA 2000 or NMEA 0183 wind sensor to the autopilot.

When the autopilot is in standby mode, select **Wind Hold**.

Engaging Wind Hold from Heading Hold

Before you can enable the wind hold type, you must connect a NMEA 2000 or NMEA 0183 wind sensor to the autopilot.

With heading hold engaged, select **Menu > Wind Hold**.

Adjusting the Wind Hold Angle with the Autopilot

You can adjust the wind hold angle on the autopilot when wind hold is engaged.

- To adjust the wind hold angle in increments of 1°, select ◀ or ▶.
- To adjust the wind hold angle in increments of 10°, hold ◀ or ▶.

Tack and Gybe

You can set the autopilot to perform a tack or gybe while heading hold or wind hold is engaged.

Tacking and Gybing from Heading Hold

- 1 Engage heading hold ([Engaging the Autopilot](#)).
- 2 Select **Menu > Tack/Gybe**.
- 3 Select a direction.

The autopilot steers your boat through a tack or gybe.

Tacking and Gybing from Wind Hold

Before you can engage wind hold, you must have a wind sensor installed.

- 1 Engage wind hold ([Engaging Wind Hold](#)).
- 2 Select **Menu > Tack/Gybe**.
- 3 Select **Tack** or **Gybe**.

The autopilot steers your boat through a tack or gybe, and information about the progress of the tack or gybe appears on the screen.

Setting a Tack and Gybe Delay

The tack and gybe delay allows you to delay steering a tack and gybe after you initiate the maneuver.

- 1 From the autopilot screen, select **Menu > Autopilot Setup > Sailing Setup > Tack Delay**.
- 2 Select the length of the delay.
- 3 If necessary, select **Done**.

Enabling the Gybe Inhibitor

NOTE: The gybe inhibitor does not prevent you from manually performing a gybe using the helm or step steering.

The gybe inhibitor prevents the autopilot from performing a gybe.

- 1 From the autopilot screen, select **Menu > Autopilot Setup > Sailing Setup > Gybe Inhibitor**.
- 2 Select **Enabled**.

Sonar

When properly connected to an optional Garmin sounder module and a transducer, your compatible chartplotter can be used as a fishfinder. Different sonar views can help you view the fish in the area.

The adjustments you can make to each sonar view vary depending on the view you are in and the chartplotter model, sounder module, and transducer you have connected.

Sonar Views

The sonar views available vary depending on the type of transducer and optional sounder module connected to the chartplotter. For example, you can view the Split Frequency view only if you have a dual-frequency transducer connected.

There are four basic styles of sonar views available: a full-screen view, a split-screen view that combines two or more views, a split-zoom view, and a split-frequency view that displays two different frequencies. You can customize the settings for each view in the screen. For example, if you are viewing the split-frequency view, you can adjust the gain for each of the frequencies separately.

If you do not see an arrangement of sonar views to suit your needs, you can create a custom screen ([Adding a Custom Combination Screen](#)).

Traditional Sonar View

There are several full-screen views available, depending on the equipment connected.

The full-screen Traditional sonar view show a large image of the sonar readings from a transducer. The range scale along the right side of the screen shows the depth of detected objects as the screen scrolls from the right to the left.

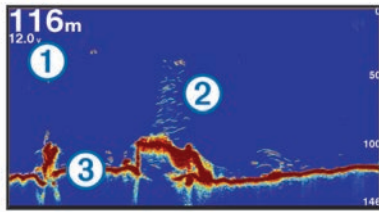

①	Depth information
②	Suspended targets or fish
③	Bottom of the body of water

DownVü Sonar View

NOTE: Not all models support DownVü sonar technology and transducers.

NOTE: To receive DownVü scanning sonar, you need a compatible chartplotter or fishfinder and a compatible transducer.

DownVü high-frequency sonar provides a clearer picture below the boat, providing a more detailed representation of structures the boat is passing over.

Traditional transducers emit a conical beam. The DownVü scanning sonar technology emits a narrow beam, similar to the shape of the beam in a copying machine. This beam provides a clearer, picture-like image of what is beneath the boat.

SideVü Sonar View

NOTE: Not all models support SideVü sonar and scanning transducers.

NOTE: To receive SideVü scanning sonar, you need a compatible chartplotter, a compatible sounder module, and a compatible transducer.

SideVü scanning sonar technology shows you a picture of what lies to the sides of the boat. You can use this as a search tool to find structures and fish.

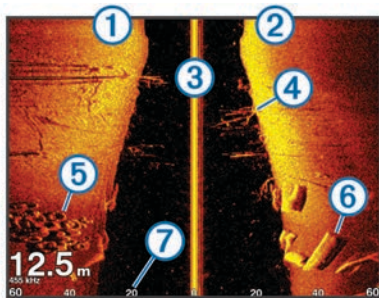

①	Left side of the boat
②	Right side of the boat
③	The transducer on your vessel
④	Trees
⑤	Old tires
⑥	Logs
⑦	Distance from the side of the boat

SideVü/DownVü Scanning Technology

Instead of a more common conical beam, the SideVü/DownVü transducer uses a flat beam to scan the water and ground to the sides of your boat.

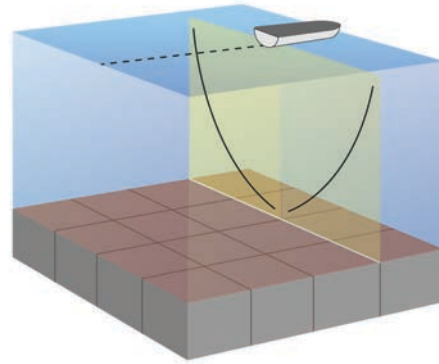

Split-Zoom Sonar View

The split-zoom sonar view shows a full-view graph of sonar readings, and a magnified portion of that graph, on the same screen.

Split-Frequency Sonar View

In the split-frequency sonar view, one side of the screen shows a full-view graph of high frequency sonar data, and the other side of the screen shows a full-view graph of lower frequency sonar data.

NOTE: The split-frequency sonar view requires the use of a dual-frequency transducer.

Panoptix™ Sonar Views

NOTE: Not all models support Panoptix transducers.

To receive Panoptix sonar, you need a compatible chartplotter and a compatible transducer.

ThePanoptix sonar views allow you to see all around the boat in real time. You can also see your bait being cast into the water and bait schools in front of or below your boat.

The LiveVü sonar views provide you a view of the live movement either in front of or below your boat. The screen updates very quickly, producing sonar views that look more like live video.

The RealVü 3D sonar views provide three-dimensional views of either what is in front of or below your boat. The screen updates with each sweep of the transducer.

To see all five Panoptix sonar views, you need one transducer to show the down views and a second transducer to show the forward views.

To access the Panoptix sonar views, select Sonar, and select a view.

LiveVü Down Sonar View

This sonar view shows a two-dimensional view of what is below the boat and can be used to see a bait ball and fish.

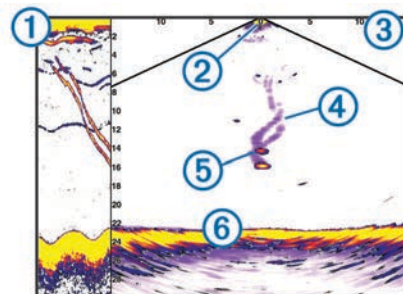

①	Panoptix down view history in a scrolling sonar view
②	Boat
③	Range
④	Trails

⑤	Drop shot jig
⑥	Bottom

LiveVü Forward Sonar View

This sonar view shows a two-dimensional view of what is in front of the boat and can be used to see a bait ball and fish.

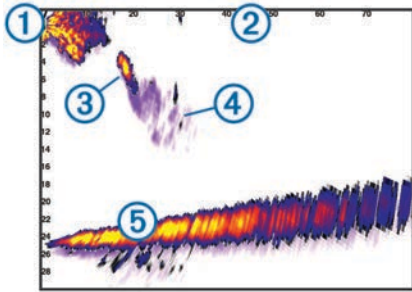

①	Boat
②	Range
③	Fish
④	Trails
⑤	Bottom

RealVü 3D Forward Sonar View

This sonar view shows a three-dimensional view of what is in front of the transducer. This view can be used when you are stationary and you need to see the bottom and the fish approaching the boat.

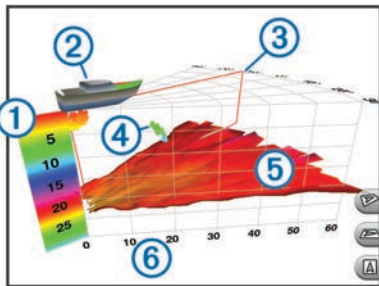

①	Color legend
②	Boat
③	Ping indicator
④	Fish
⑤	Bottom
⑥	Range

RealVü 3D Down Sonar View

This sonar view shows a three-dimensional view of what is below the transducer and can be used when you are stationary and want to see what is around your boat.

RealVü 3D Historical Sonar View

This sonar view provides a three-dimensional view of what is behind your boat as you are moving and shows the entire water column in 3D, from the bottom to the top of the water. This view is used for finding fish.

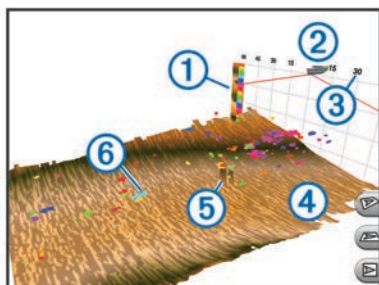

①	Color legend
②	Boat
③	Range
④	Bottom
⑤	Structure
⑥	Fish

Changing the Sonar View

- 1 From a combination screen or SmartMode layout with sonar, select the window to change.
- 2 Select **Menu > Change Sonar**.
- 3 Select a sonar view.

Creating a Waypoint on the Sonar Screen

- 1 From a sonar view, select a location.
- 2 Select **New Wpt**.
- 3 If necessary, edit the waypoint information.

Measuring Distance on the Sonar Screen

You can measure the distance between two points on the SideVü sonar view.

- 1 From the SideVü sonar view, select a location on the screen.
- 2 Select **Measure Distance**.
A push pin appears on the screen at the selected location.
- 3 Select another location.
The distance and angle from the pin is listed in the upper-left corner.

TIP: To reset the pin and measure from the current location of the pin, select Measure Distance.

Pausing the Sonar Display

From a sonar view, select **||**.

Viewing Sonar History

You can scroll the sonar display to view historical sonar data.

NOTE: Not all transducers save historical sonar data.

- 1 From a sonar view, select **||**.
- 2 Drag the screen.

Sonar Sharing

This feature may not be available on all chartplotter models. You can view the sonar data from all compatible sources on the Garmin Marine Network. You can view sonar data from a compatible external sonar module, such as a GCV™ sonar module. In addition, you can view the sonar data from other chartplotters that have a built-in sonar module.

Each chartplotter on the network can display sonar data from every compatible sonar module and transducer on the network, no matter where the chartplotters and transducers are mounted on your boat. For example, from a transducer with DownVü mounted at the back of the boat, you can view the sonar data using the GPSMAP 8212 mounted at the front of your boat.

Chartplotters can display only compatible types of sonar. For example, GPSMAP 547 models can display traditional and DownVü data, but not SideVü data.

When sharing sonar data, the values of some sonar settings, such as Range and Gain, are synchronized across the devices on the network. The values of other sonar settings, such as the Appearance settings, are not synchronized and should be configured on each individual device. In addition, the scroll rates of the various traditional and DownVü sonar views are synchronized to make the split views more cohesive.

NOTE: Using multiple transducers simultaneously can create cross talk, which can be removed by adjusting the Interference sonar setting.

Selecting a Sonar Source

This feature may not be available with all models.

When you are using more than one sonar data source for a particular sonar view, you can select the source to use for that sonar view. For example, if you have two sources for DownVü, you can select the source to use from the DownVü sonar view.

- 1 Open the sonar view for which you will change the source.
- 2 Select **Menu > Sonar Setup > Source**.
- 3 Select the source for this sonar view.

Renaming a Sonar Source

You can rename a sonar source to easily identify that source. For example, you use "Bow" as the name of the transducer on the bow of your boat.

The source is renamed for the present view only. For example, to rename the DownVü sonar source, you must open the DownVü sonar view.

- 1 From the sonar view, select **Menu > Sonar Setup > Source > Rename Sources**.
- 2 Enter the name.

Adjusting the Level of Detail

You can control the level of detail and noise shown on the sonar screen either by adjusting the gain for traditional transducers, or by adjusting the brightness for DownVü and SideVü/DownVü transducers.

If you want to see the highest intensity signal returns on the screen, you can lower the gain or brightness to remove lower intensity returns and noise. If you want to see all return information, you can increase the gain or brightness to see more information on the screen. This also increases noise, and can make it more difficult to recognize actual returns.

- 1 From a sonar view, select **Menu**.
- 2 Select **Gain** or **Brightness**.
- 3 Select an option:
 - To increase or decrease the gain or brightness manually, select **Up** or **Down**.
 - To allow the chartplotter to adjust the gain or brightness automatically, select an automatic option.

Adjusting the Color Intensity

You can adjust the intensity of colors and highlight areas of interest on the sonar screen by adjusting the color gain for traditional transducers or the contrast for DownVü and SideVü/DownVü transducers. This setting works best after you have adjusted the level of detail shown on the screen using the gain or brightness settings.

If you want to highlight smaller fish targets or create a higher intensity display of a target, you can increase the color gain or contrast setting. This causes a loss in the differentiation of the high intensity returns at the bottom. If you want to reduce the intensity of the return, you can reduce the color gain or contrast.

- 1 From a sonar view, select **Menu**.
- 2 Select an option:
 - While in the DownVü or SideVü sonar view, select **Contrast**.
 - While in a Panoptix LiveVü sonar view, select **Color Gain**.
 - While in another sonar view, select **Sonar Setup > Advanced > Color Gain**.
- 3 Select an option:

- To increase or decrease the color intensity manually, select **Up** or **Down**.
- To use the default setting, select **Default**.

Adjusting the Range of the Depth or Width Scale

You can adjust the range of the depth scale traditional and DownVü sonar views and the range of the width scale for the SideVü sonar view.

Allowing the device to adjust the range automatically keeps the bottom within the lower or outer third of the sonar screen, and can be useful for tracking a bottom that has minimal or moderate terrain changes.

Manually adjusting the range enables you to view a specified range, which can be useful for tracking a bottom that has large terrain changes, such as a drop-offs or cliffs. The bottom can appear on the screen as long as it appears within the range you have set.

- 1 From a sonar view, select **Menu > Range**.
- 2 Select an option:
 - To allow the chartplotter to adjust the range automatically, select **Auto**.
 - To increase or decrease the range manually, select **Up** or **Down**.

TIP: From the sonar screen, you can select **+** or **-** to manually adjust the range.

TIP: When viewing multiple sonar screens, you can select **Select** to choose the active screen.

Setting the Zoom Level on the Sonar Screen

- 1 From a sonar view, select **Menu > Zoom**.
- 2 Select an option:
 - To zoom in on the sonar data from the bottom depth, select **Bottom Lock**.
 - To set the depth range of the magnified area manually, select **Set Zoom**, select **View Up** or **View Down** to set the depth range of the magnified area, and select **Zoom In** or **Zoom Out** to increase or decrease the magnification of the magnified area.
 - To set the depth and zoom automatically, select **Set Zoom > Auto**.
 - To cancel the zoom, select **No Zoom**.

Setting the Scroll Speed

You can set the rate at which the sonar image moves across the screen. A higher scroll speed shows more detail, especially while moving or trolling. A lower scroll speed displays sonar information on the screen longer. Setting the scroll speed on one sonar view applies to all the sonar views.

- 1 From a sonar view, select **Menu > Sonar Setup > Scroll Speed**.
- 2 Select an option:
 - To adjust the scroll speed automatically using speed-over-ground or water speed data, select **Auto**.
The Auto setting selects a scroll rate to match the boat speed, so targets in the water are drawn with the correct aspect ratio and appear less distorted. When viewing DownVü or SideVü sonar views, it is recommend to use the Auto setting.
 - To use a very fast scroll speed, select **Ultrasroll®**.
The Ultrasroll option quickly scrolls new sonar data, but with a reduced image quality. For most situations, the Fast option provides a good balance between a quickly scrolling image and targets that are less distorted.

Sonar Frequencies

NOTE: The frequencies available depend on the chartplotter, sounder modules, and transducer being used.

Adjusting the frequency helps adapt the sonar for your particular goals and the present depth of the water.

Higher frequencies use narrow beam widths, and are better for high-speed operation and rough sea conditions. Bottom definition and thermocline definition can be better when using a higher frequency.

Lower frequencies use wider beam widths, which can let the fisherman see more targets, but could also generate more surface noise and reduce bottom signal continuity during rough sea conditions. Wider beam widths generate larger arches for fish target returns, making them ideal for locating fish. Wider beam widths also perform better in deep water, because the lower frequency has better deep water penetration.

Chirp frequencies allow you to sweep each pulse through a range of frequencies, resulting in better target separation in deep water. Chirp can be used to distinctly identify targets, like individual fish in a school, and for deep water applications. Chirp generally performs better than single frequency applications. Because some fish targets may show up better using a fixed frequency, you should consider your goals and water conditions when using Chirp.

Some sonar black boxes and transducers also provide the ability to customize preset frequencies for each transducer element, which enables you to change the frequency quickly using the presets as the water and your goals change.

Viewing two frequencies concurrently using the split-frequency view allows you to see deeper with the lower frequency return and, at the same time, see more detail from the higher frequency return.

Selecting Frequencies

NOTE: You cannot adjust the frequency for all sonar views and transducers.

You can indicate which frequencies appear on the sonar screen.

- 1 From a sonar view, select **Menu > Frequency**.
- 2 Select a frequency suited to your needs and water depth.
For more information on frequencies, see [Sonar Frequencies](#).

Creating a Frequency Preset

NOTE: Not available with all transducers.

You can create a preset to save a specific sonar frequency, which allows you to change frequencies quickly.

- 1 From a sonar view, select **Menu > Frequency**.
- 2 Select **Manage Frequencies > New Preset**.
- 3 Enter a frequency.

Customizing the Panoptix Sonar Views

NOTE: Not all models support Panoptix transducers.

Adjusting the Appearance of the LiveVü Sonar Views

- 1 From a LiveVü sonar view, select **Menu > Sonar Setup**.
- 2 Select an option:
 - To change the colors of the sonar view, select **Color Scheme**, and select an option.
 - To adjust the length of the trails that show target movement, select **Trails**, and select an option.
 - To show or hide the range grid lines, select **Grid Overlay**.
 - To hide or show the history on the side of the screen, select **Scroll History**.

Setting the LiveVü Transducer Transmit Angle



You can change the LiveVü transducer transmit angle to aim the transducer at a particular area of interest. For example, you might aim the transducer to follow a bait ball or focus on a tree as you pass it.

- 1 From a LiveVü sonar view, select **Menu > Transmit Angle**.
- 2 Select an option.

Adjusting the RealVü Viewing Angle and Zoom Level

You can change the viewing angle of the RealVü sonar views. You can also zoom in and out of the view.

From a RealVü sonar view, select an option:

- To adjust the viewing angle diagonally, select .
- To adjust the viewing angle horizontally, select .
- To adjust the viewing angle vertically, select .
- To adjust the viewing angle, swipe the screen in any direction.
- To zoom in, spread two fingers apart.
- To zoom out, pinch two fingers together.

Adjusting the Appearance of the RealVü Sonar Views

- 1 From a RealVü sonar view, select **Menu**.
- 2 Select an option:
 - To adjust the depth at which the color palette starts over, select **Palette Depth**, and select an option.
 - To select a different color palette for the sonar return points, select **Sonar Setup > Point Colors**, and select an option.
 - To select a different color palette for the bottom, select **Sonar Setup > Bottom Colors**, and select an option.
 - To select a different style for the bottom, select **Sonar Setup > Bottom Style**, and select an option.
 - To hide or show the color legend on the side of the screen, select **Sonar Setup > Color Key**.

Adjusting the RealVü Sweep Speed

You can update how quickly the transducer sweeps back and forth. A faster sweep rate creates a less detailed image, but the screen refreshes faster. A slower sweep rate creates a more detailed image, but the screen refreshes more slowly.

NOTE: This feature is not available for the RealVü 3D Historical sonar view.

- 1 From a RealVü sonar view, select **Menu > Sweep Speed**.
- 2 Select an option.

Turning On the A-Scope

NOTE: This feature is not available in all sonar views.

The a-scope is a vertical flasher along the right side of the full-screen sonar view. This feature expands the most recently received sonar data so that it is easier to see. It can also be helpful for detecting fish that are close to the bottom.

From a sonar view, select **Menu > Sonar Setup > Appearance > A-Scope > On**.

Selecting the Transducer Type

Before you can select the transducer type, you must know what kind of transducer you have.

If you are connecting a transducer that was not included with the chartplotter, you may need to set the transducer type to make the sonar function properly. If the device automatically detected your transducer, this option does not appear.

- 1 From a sonar view, select **Menu > Sonar Setup > Installation > Transducer Type**.

2 Select an option:

- If you have a 200/77 kHz, dual-beam transducer, select **Dual Beam (200/77 kHz)**.
- If you have a 200/50 kHz, dual-frequency transducer, select **Dual Frequency (200/50 kHz)**.
- If you have another type of transducer, select it from the list.

Sonar Setup

NOTE: Not all options and settings apply to all models, sounder modules, and transducers.

Sonar Settings

NOTE: These settings do not apply to Panoptix transducers. See [RealVü Sonar Settings](#) and [LiveVü Sonar Settings](#).

From a sonar view, select **Menu > Sonar Setup**.

Scroll Speed: Sets the rate at which the sonar scrolls from right to left ([Setting the Scroll Speed](#)).

In shallow water, you can select a slower scroll speed to extend the length of time the information is displayed on screen. In deeper water, you can select a faster scroll speed. Automatic scroll speed adjusts the scrolling speed to the speed the boat is traveling.

Noise Reject: Reduces the interference and the amount of clutter shown on the sonar screen ([Sonar Noise Rejection Settings](#)).

Appearance: Configures the appearance of the sonar screen ([Sonar Appearance Settings](#)).

Alarms: Sets sonar alarms ([Sonar Alarm Settings](#)).

Advanced: Configures various sonar display and data source settings ([Advanced Sonar Settings](#)).

Installation: Configures the transducer ([Transducer Installation Settings](#)).

RealVü Sonar Settings

From a RealVü sonar view, select **Menu > Sonar Setup**.

Point Colors: Sets a different color palette for the sonar return points.

Bottom Style: Sets the style for the bottom. When you are in deep water, you can set this setting to the Points and manually set the range shallower.

Bottom Colors: Sets the color scheme for the bottom.

Color Key: Shows a legend of the depths the colors represent.

Overlay Data: Sets the data shown on the sonar screen.

Installation: Configures the transducer ([Transducer Installation Settings](#)).

LiveVü Sonar Settings

From a LiveVü sonar view, select **Menu > Sonar Setup**.

Color Scheme: Sets the color palette.

Trails: Sets the how long the trails appear on the screen. The trails show the movement of the target.

Grid Overlay: Shows a grid of range lines.

Noise Reject: Reduces the interference and the amount of clutter shown on the sonar screen.

Scroll History: Shows the sonar history in a traditional sonar view.

Overlay Data: Sets the data shown on the sonar screen.

Installation: Configures the transducer ([Transducer Installation Settings](#)).

Sonar Noise Rejection Settings

From a sonar view, select **Menu > Sonar Setup > Noise Reject**.

Interference: Adjusts the sensitivity to reduce the effects of interference from nearby sources of noise.

The lowest interference setting that achieves the desired improvement should be used to remove interference from the screen. Correcting installation issues that cause noise is the best way to eliminate interference.

Color Limit: Hides part of the color palette to help eliminate fields of weak clutter.

By setting the color limit to the color of the undesired returns, you can eliminate the display of undesired returns on the screen.

Smoothing: Removes noise that is not part of a normal sonar return, and adjusts the appearance of returns, such as the bottom.

When smoothing is set to high, more of the low-level noise remains than when using the interference control, but the noise is more subdued because of averaging. Smoothing can remove speckle from the bottom. Smoothing and interference work well together to eliminate low-level noise. You can adjust the interference and smoothing settings incrementally to remove undesirable noise from the display.

Surface Noise: Hides surface noise to help reduce clutter.

Wider beam widths (lower frequencies) can show more targets, but can generate more surface noise.

TVG: Adjusts the time varying gain, which can reduce noise.

This control is best used for situations when you want to control and suppress clutter or noise near the water surface. It also allows for the display of targets near the surface that are otherwise hidden or masked by surface noise.

Sonar Appearance Settings

From a sonar view, select **Menu > Sonar Setup > Appearance**.

Color: Sets the color scheme and color gain.

Overlay Data: Sets the data shown on the sonar screen.

A-Scope: Displays a vertical flasher along the right side of the screen that shows instantaneously the range to targets along a scale.

Depth Line: Shows a quick-reference depth line.

Edge: Highlights the strongest signal from the bottom to help define the hardness or softness of the signal.

Pic. Advance: Allows the sonar picture to advance faster by drawing more than one column of data on the screen for each column of sounder data received. This is especially helpful when you are using the sounder in deep water, because the sonar signal takes longer to travel to the water bottom and back to the transducer.

The 1/1 setting draws one column of information on the screen per sounder return. The 2/1 setting draws two columns of information on the screen per sounder return, and so on for the 4/1 and 8/1 settings.

Sonar Alarm Settings

NOTE: Some settings require external accessories.

Select **Settings > Alarms > Sonar**.

Shallow Water: Sets an alarm to sound when the depth is less than the specified value.

Deep Water: Sets an alarm to sound when the depth is greater than the specified value.

Water Temp.: Sets an alarm to sound when the transducer reports a temperature that is 2°F (1.1°C) above or below the specified temperature.

Contour: Sets an alarm to sound when the transducer detects a suspended target within the specified depth from the surface of the water and from the bottom.

Fish Alarm: Sets an alarm to sound when the transducer detects a suspended target within the specified depth range and the specified color range.

Advanced Sonar Settings

From a sonar view, select **Menu > Sonar Setup > Advanced**.

Transmit: Stops the transducer from transmitting.

Shift: Allows you to set the depth range on which the sonar is focused. This allows you to zoom in a higher resolution in the focused depth.

When using shift, bottom tracking may not work effectively, because the sonar looks for data within the depth range of the focused area, which may not include the bottom. Using shift also can impact the scroll speed, because data outside the depth range of the focused area is not processed, which reduces the time required to receive and display the data. You can zoom in to the focused area, which enables you to evaluate target returns more closely at a higher resolution than just zooming alone.

Echo Stretch: Adjusts the size of the echoes on the screen to make it easier to see separate returns on the screen.

When targets are difficult to see, echo stretch makes the target returns more pronounced and easier to see on the screen. If the echo stretch value is too high, the targets blend together, and if the value is too low, the targets might be small and difficult to see.

You can use echo stretch and filter width together to obtain the preferable resolution and noise reduction. With echo stretch and filter width set to low, the display has the highest resolution, but is the most susceptible to noise. With echo stretch set to high and filter width set to low, the display has a lower resolution, but has wider targets. With echo stretch and filter width set to high, the display has the lowest resolution, but is the least susceptible to noise. It is not recommended to set echo stretch to low and filter width to high.

Bottom Track: Sets the frequency used for determining depth.

The bottom tracking control allows you to select the specific channel that is used to track the bottom. For example, you can set the bottom tracking for the low frequency for deep water operation.

Temp. Source: Sets the channel for the water temperature log when more than one water-temperature sensor or temperature-capable transducer is connected.

Transducer Installation Settings

From a sonar view, select **Menu > Sonar Setup > Installation**.

Transmit Rate: Sets the length of time between sonar pings. Increasing the transmit rate increases the scroll speed, but it may also increase self-interference.

Reducing the transmit rate increases the spacing between transmit pulses and can resolve self-interference.

Transmit Power: Reduces transducer ringing near the surface. A lower transmit power value reduces transducer ringing.

Filter Width: Defines the edges of the target. A shorter filter defines the edges of the targets, but may allow more noise. A longer filter creates softer target edges, and may also reduce noise.

Transducer Diagnostics: Shows details about the transducer.

Flip Left/Right: Changes the SideVü view orientation from left to right.

Install Depth: Sets the depth below the water line that the Panoptix transducer is mounted. Entering the actual depth the transducer is mounted will result in a more accurate visual presentation of what is in the water.

Flipped: Sets the orientation of the Panoptix sonar view when the down view transducer is installed with the cables pointing toward the port side of the boat.

Beam Width: Sets the width of the Panoptix transducer beam.

Narrow beam widths are better for high-speed operation and rough sea conditions. They also can improve bottom definition and thermocline definition.

Wider beam widths generate larger arches for fish target returns, making them ideal for locating fish. Wider beam widths perform better in deep water. They can generate more surface noise and reduce bottom signal continuity during rough sea conditions.

Use AHRS: Allows the internal attitude heading and reference system (AHRS) sensors to detect the installation angle of the Panoptix transducer. When this setting is turned off, it is assumed the forward view transducer is installed at a 45-degree angle and the down view transducer is installed at a 0-degree angle.

Sonar Recordings

Recording the Sonar Display

NOTE: Not all models support sonar recording.

- 1 Insert a memory card into the card slot.
- 2 From a sonar view, select **Menu > Sonar Setup > Sonar Recording > Record Sonar**.

15 minutes of sonar recording uses approximately 200 MB of space of the inserted memory card. You can record sonar until the card reaches capacity.

Stopping the Sonar Recording

Before you can stop recording sonar, you must begin recording it ([Recording the Sonar Display](#)).

From a sonar view, select **Menu > Sonar Setup > Sonar Recording > Stop Recording**.

Deleting a Sonar Recording

- 1 Insert a memory card into the card slot.
- 2 From a sonar view, select **Menu > Sonar Setup > Sonar Recordings > View Recordings**.
- 3 Select a recording.
- 4 Select **Delete**.

Playing Sonar Recordings

Before you can play back the sonar recordings, you must download and install the HomePort™ application and record sonar data onto a memory card.

- 1 Remove the memory card from the device.
- 2 Insert the memory card into a card reader attached to a computer.
- 3 Open the HomePort application.
- 4 Select a sonar recording from your device list.
- 5 Right-click the sonar recording in the lower pane.
- 6 Select **Playback**.

Radar

WARNING

The marine radar transmits microwave energy that has the potential to be harmful to humans and animals. Before beginning radar transmission, verify that the area around the radar is clear. The radar transmits a beam approximately 12° above and below a line extending horizontally from the center of the radar.

When the radar is transmitting, do not look directly at the antenna at close range; eyes are the most sensitive part of the body to electromagnetic energy.

NOTE: Not all models support radar.

When you connect your compatible chartplotter to an optional Garmin marine radar, such as a GMR™ 1226 xHD2 or a GMR 24 HD, you can view more information about your surroundings.

The GMR transmits a narrow beam of microwave energy as it rotates to a 360° pattern. When the transmitted energy contacts a target, some of that energy is reflected back to the radar.

Radar Display Modes

NOTE: Not all modes are available with all radar devices and all chartplotters.

Select Radar.

Cruising Mode: Shows a full-screen image of the gathered radar information.

Harbor Mode: Intended for use in inland waters, this mode works best with short-range signals (2 nm or less).

Offshore Mode: Intended for use in open waters, this mode works best with long-range signals.

Sentry Mode: Allows you to put the radar into timed-transmit mode, in which you can configure a radar transmit and standby cycle to conserve power. You can also enable a guard zone in this mode, which identifies a safe zone around your boat. If you switch from Sentry mode to another mode, the radar switches to full-time transmission and disables all guard zones.

Radar Overlay Mode: Shows a full-screen image of the gathered radar information on top of the Navigation chart. The Radar overlay displays data based on the most recently used radar mode.

Dual Range Mode: Provides a side-by-side view of both short-range and long-range radar data.

Changing the Radar Mode

- 1 From a combination screen or SmartMode layout with radar, select **Menu > Radar Menu > Change Radar**.
- 2 Select a radar mode.

Transmitting Radar Signals

NOTE: As a safety feature, the radar enters standby mode after it warms up. This gives you an opportunity to verify the area around the radar is clear before beginning radar transmission.

- 1 With the chartplotter off, connect your radar as described in the radar installation instructions.
- 2 Turn on the chartplotter.
The radar warms up and a countdown alerts you when the radar is ready.
- 3 Select **Radar**.
- 4 Select a radar mode.
A countdown message appears while the radar is starting up.
- 5 Select **Menu > Transmit Radar**.

Adjusting the Radar Range

The range of the radar signal indicates the length of the pulsed signal transmitted and received by the radar. As the range increases, the radar transmits longer pulses in order to reach distant targets. Closer targets, especially rain and waves, also reflect the longer pulses, which can add noise to the Radar screen. Viewing information about longer-range targets can also decrease the amount of space available on the Radar screen for viewing information about shorter-range targets.

- Select **+** to decrease the range.
- Select **-** to increase the range.

Tips for Selecting a Radar Range

- Determine what information you need to see on the Radar screen.

For example, do you need information about nearby weather conditions or targets and traffic, or are you more concerned about distant weather conditions?

- Assess the environmental conditions where the radar is being used.

Especially in inclement weather, longer-range radar signals can increase the clutter on the Radar screen and make it more difficult to view information about shorter-range targets. In rain, shorter-range radar signals can enable you to view information about nearby objects more effectively, if the rain clutter setting is configured optimally.

- Select the shortest effective range, given your reason for using radar and the present environmental conditions.

Zooming In and Out of the Radar Screen

- Pinch two fingers together to zoom out.
- Spread two fingers apart to zoom in.
- Drag the screen to pan, and then select **+** or **-** to zoom, if necessary.

Marking a Waypoint on the Radar Screen

- 1 From a Radar screen or the Radar overlay, select a location.
- 2 Select **Create Waypoint**.

Sentry Mode

Sentry mode allows you to put the radar into timed-transmit mode, in which you can configure a radar transmit and standby cycle to conserve power. You can also enable a guard zone in this mode, which identifies a safe zone around your boat and sounds an alarm when a radar object enters the zone. Sentry mode works with all Garmin GMR model radars.

Enabling Timed Transmit

Select **Radar > Sentry > Menu > Sentry Setup > Timed Transmit > On**.

Setting the Standby and Transmit Times

Before you can set the standby and transmit times, you must enable timed transmit ([Enabling Timed Transmit](#)).

To help conserve power, you can indicate the radar standby time and the transmit time to implement periodic radar signal transmissions at set intervals.

- 1 From the sentry screen, select **Menu > Sentry Setup**.
- 2 Select **Stdby Time**.
- 3 Enter the time interval between radar signal transmissions.
- 4 Select **Transmit Time**.
- 5 Enter the duration of each radar signal transmission.

Enabling a Guard Zone

Select **Radar > Sentry > Menu > Sentry Setup > Enable Guard Zone**.

Defining a Circular Guard Zone

Before you can define the boundaries of the guard zone, you must enable a guard zone ([Enabling a Guard Zone](#)).

You can define a circular guard zone that completely encompasses your boat.

- 1 Select **Radar > Sentry > Menu > Sentry Setup > Adjust Guard Zone > Adjust Guard Zone > Circle**.
- 2 Select the location of the outer guard zone circle.
- 3 Select the location of the inner guard zone circle to define the width of the guard zone.

Defining a Partial Guard Zone

You can define the boundaries of a guard zone that does not completely encompass your boat.

- 1 Select **Radar > Sentry > Menu > Sentry Setup > Adjust Guard Zone > Adjust Guard Zone > Corner 1.**
- 2 Touch and drag the location of the outer guard-zone corner ①.



- 3 Select **Corner 2.**
- 4 Touch the location of the inner guard-zone corner ② to define the width of the guard zone.

Radar Targeting and MARPA

Radar targeting enables you to identify and track objects.

Mini-automatic radar plotting aid (MARPA) is primarily used for collision avoidance. To use MARPA, you assign a MARPA tag to a target. The radar system automatically tracks the tagged object and provides you with information about the object, including the range, bearing, speed, GPS heading, nearest approach, and time to nearest approach. MARPA indicates the status of each tagged object (acquiring, lost, tracking, or dangerous), and the chartplotter can sound a collision alarm if the object enters your safe zone.

MARPA Targeting Symbols

	Acquiring a target. Concentric, dashed green rings radiate from the target while the radar is locking onto it.
	Target has been acquired. A solid green ring indicates the location of a target that the radar has locked onto. A dashed green line attached to the circle indicates the projected course over ground or the GPS heading of the target.
	Dangerous target is in range. A red ring flashes from the target while an alarm sounds and a message banner appears. After the alarm has been acknowledged, a solid red dot with a dashed red line attached to it indicates the location and the projected course over ground or the GPS heading of the target. If the safe-zone collision alarm has been set to Off, the target flashes, but the audible alarm does not sound and the alarm banner does not appear.
	Target has been lost. A solid green ring with an X through it indicates that the radar could not lock onto the target.
	Closest point of approach and time to closest point of approach to a dangerous target.

Assigning a MARPA Tag to an Object

Before you can use MARPA, you must have a heading sensor connected and an active GPS signal. The heading sensor must provide the NMEA 2000 parameter group number (PGN) 127250 or the NMEA 0183 HDM or HDG output sentence.

- 1 From the Harbor, Offshore, or Cruising Radar screen, select an object or location.
- 2 Select **Acquire Target > MARPA Target.**

Viewing Information about a MARPA-tagged Object

You can view the range, bearing, speed, and other information about a MARPA-tagged object.

- 1 From a radar screen, select a targeted object.
- 2 Select **MARPA Target.**

Removing a MARPA Tag from a Targeted Object

- 1 From the Radar screen, select a MARPA target.
- 2 Select **MARPA Target > Remove.**

Viewing a List of AIS and MARPA Threats

From any Radar screen or the Radar overlay, you can view and customize the appearance of a list of AIS and MARPA threats.

- 1 From a Radar screen, select **Menu > Other Vessels > List > Show.**
- 2 Select the type of threats to include in the list.

Showing AIS Vessels on the Radar Screen

AIS requires the use of an external AIS device and active transponder signals from other vessels.

You can configure how other vessels appear on the Radar screen. If any setting (except the AIS display range) is configured for one radar mode, the setting is applied to every other radar mode. The details and projected heading settings configured for one radar mode are applied to every other radar mode and to the Radar overlay.

- 1 From a Radar screen or the Radar overlay, select **Menu > Other Vessels > Display Setup.**
- 2 Select an option:
 - To indicate the distance from your location within which AIS vessels appear, select **Display Range**, and select a distance.
 - To show details about AIS-activated vessels, select **Details > Show.**
 - To set the projected heading time for AIS-activated vessels, select **Proj. Heading**, and enter the time.
 - To show the tracks of AIS vessels, select **Trails**, and select the length of the track that appears.

VRM and EBL

The variable range marker (VRM) and the electronic bearing line (EBL) measure the distance and bearing from your boat to a target object. On the Radar screen, the VRM appears as a circle that is centered on the present location of your boat, and the EBL appears as a line that begins at the present location of your boat and intersects the VRM. The point of intersection is the target of the VRM and the EBL.

Showing the VRM and the EBL

The VRM and the EBL configured for one mode are applied to other radar modes.

NOTE: The VRM and the EBL cannot be changed in sentry mode.

From a radar screen, select **Menu > Show VRM/EBL.**

Adjusting the VRM and the EBL

Before you can adjust the VRM and the EBL, you must show them on the Radar screen ([Showing the VRM and the EBL](#)).

You can adjust the diameter of the VRM and the angle of the EBL, which moves the intersection point of the VRM and the EBL. The VRM and the EBL configured for one mode are applied to all other radar modes.

- 1 From a Radar screen, select a new location for the intersection point of the VRM and the EBL.
- 2 Select **Drop VRM/EBL.**
- 3 Select **Stop Pointing.**

Measuring the Range and Bearing to a Target Object

Before you can adjust the VRM and the EBL, you must show them on the Radar screen ([Showing the VRM and the EBL](#)).

- 1 From a Radar screen, select the target location.
- 2 Select **Measure Distance.**

The range and the bearing to the target location appear in the upper-left corner of the screen.

Radar Overlay

When you connect your chartplotter to an optional Garmin marine radar, you can use the Radar overlay to overlay radar information on the Navigation chart or on the Fishing chart.

The Radar overlay superimposes radar information on the Navigation chart or the Fishing chart. Data appears on the Radar overlay based on the most recently used radar mode (such as Harbor, Offshore, or Sentry), and all settings configurations applied to the Radar overlay are also applied to the last-used radar mode. For example, if you use Harbor mode and then you switch to the Radar overlay, the Radar overlay would show Harbor mode radar data. If you changed the gain setting using the Radar overlay menu, the gain setting for Harbor mode would change automatically.

Radar Overlay and Chart Data Alignment

When using the Radar overlay, the chartplotter aligns radar data with chart data based on the boat heading, which is based by default on data from a magnetic heading sensor connected using a NMEA 0183 or NMEA 2000 network. If a heading sensor is not available, the boat heading is based on GPS tracking data.

GPS tracking data indicates the direction in which the boat is moving, not the direction in which the boat is pointing. If the boat is drifting backward or sideways due to a current or wind, the Radar overlay may not perfectly align with the chart data. This situation should be avoided by using boat-heading data from an electronic compass.

If the boat heading is based on data from a magnetic heading sensor or an automatic pilot, the heading data could be compromised due to incorrect setup, mechanical malfunction, magnetic interference, or other factors. If the heading data is compromised, the Radar overlay may not align perfectly with the chart data.

Showing the Radar Overlay

The radar overlay displays data based on the most recently used radar mode.

Select **Charts > Radar Overlay**.

The radar picture appears in orange and overlays the navigation chart.

Setting a Custom Park Position

If you have more than one radar on your boat, you must be viewing the radar screen for the radar you want to adjust.

By default, the antenna is stopped perpendicular to the pedestal when it is not spinning. You can adjust this position.

- 1 From the radar screen, select **Menu > Radar Setup > Antenna Configuration > Park Position**.
- 2 Use the slider bar to adjust the position of the antenna when stopped, and select **Back**.

Enabling and Adjusting a Radar No Transmit Zone

You can indicate an area within which the radar scanner does not transmit signals.

NOTE: This feature is not available on all radar and chartplotter models.

- 1 From a radar screen, select **Menu > Radar Setup > Enable No Transmit Zone**.

The no-transmit zone is indicated by a shaded area on the radar screen.

- 2 Select **Adjust No Transmit Zone > Move No Transmit Zone**.
- 3 Select **Angle 1**, and select the new location for the first angle.

- 4 Select **Angle 2**, and select the new location for the second angle.
- 5 Select **Done**.

Stopping the Transmission of Radar Signals

From a radar screen, select **Menu > Radar To Standby**.

TIP: Press \odot from any screen to quickly stop radar transmission.

Optimizing the Radar Display

You can adjust the radar display settings for reduced clutter and increased accuracy.

NOTE: You can optimize the radar display for each radar mode.

- 1 Select a radar range ([Adjusting the Radar Range](#)).
- 2 Restore the default value of the gain setting ([Adjusting Gain on the Radar Screen Automatically](#)).
- 3 Adjust the gain setting manually ([Adjusting Gain on the Radar Screen Manually](#)).

Radar Gain and Clutter

Adjusting Gain on the Radar Screen Automatically

The automatic gain setting for each radar mode is optimized for that mode, and may differ from the automatic gain setting used for another mode.

NOTE: Depending upon the radar in use, the gain setting configured for use in one radar mode may or may not be applied to other radar modes or to the Radar overlay.

NOTE: Not all options and settings are available on all radar and chartplotter models.

- 1 From a radar screen or the radar overlay, select **Menu > Gain**.
- 2 Select an applicable option for the connected radar:
 - To set the gain automatically once, based on average conditions, the range of the radar signal, and the selected radar mode, select **Auto**.
The chartplotter does not adjust the gain automatically in response to changing conditions.
 - To adjust the gain automatically for changing conditions, select **Auto Low** or **Auto High**.
 - To adjust the gain automatically to show birds over the surface of the water, select **Auto Bird**.

Adjusting Gain on the Radar Screen Manually

For optimal radar performance, you can manually adjust the gain.

NOTE: Depending upon the radar in use, the gain setting configured for use in one radar mode may or may not be applied to other radar modes or to the Radar overlay.

- 1 From a Radar screen or the Radar overlay, select **Menu > Gain**.
- 2 Select **Up** to raise the gain, until light speckles appear across the Radar screen.
Data on the Radar screen is refreshed every few seconds. As a result, the effects of manually adjusting the gain may not appear instantly. Adjust the gain slowly.
- 3 Select **Down** to lower the gain until the speckles disappear.
- 4 If boats, land, or other targets are within range, select **Down** to lower the gain until the targets begin to blink.
- 5 Select **Up** to raise the gain until the boats, land, or other targets appear steadily lit on the Radar screen.
- 6 Minimize the appearance of nearby large objects, if necessary.
- 7 Minimize the appearance of side-lobe echoes, if necessary.

Minimizing Nearby Large-Object Interference

Nearby targets of significant size, such as jetty walls, can cause a very bright image of the target to appear on the Radar screen. This image can obscure smaller targets located near it.

NOTE: Depending upon the radar in use, the gain setting configured for use in one radar mode may or may not be applied to other radar modes or to the Radar overlay.

- 1 From a Radar screen or the Radar overlay, select **Menu > Gain**.
- 2 Select **Down** to lower the gain until the smaller targets are clearly visible on the Radar screen.
Reducing the gain to eliminate nearby large-object interference may cause smaller or distant targets to blink or disappear from the Radar screen.

Minimizing Side-Lobe Interference on the Radar Screen

Side-lobe interference may appear to streak outward from a target in a semi-circular pattern. Side-lobe effects can be avoided by reducing the gain or reducing the radar range.

NOTE: Depending upon the radar in use, the gain setting configured for use in one radar mode may or may not be applied to other radar modes or to the Radar overlay.

- 1 From a Radar screen or the Radar overlay, select **Menu > Gain**.
- 2 Select **Down** to lower the gain until the semi-circular, streaked pattern disappears from the Radar screen.
Reducing the gain to eliminate side-lobe interference may cause smaller or distant targets to blink or disappear from the Radar screen.

Adjusting Sea Clutter on the Radar Screen Automatically

You can set the chartplotter to automatically adjust the appearance of clutter caused by choppy sea conditions.

NOTE: Depending upon the radar in use, the sea clutter setting configured for use in one radar mode may or may not be applied to other radar modes or to the radar overlay.

NOTE: Not all options and settings are available on all radar and chartplotter models.

- 1 From a radar screen or the radar overlay, select **Menu > Noise Rejection > Sea Clutter**.
- 2 Select **Presets** or **Auto**.
- 3 Select a setting that reflects the present sea conditions.

When using a compatible radar model, the chartplotter adjusts the sea clutter based on the sea conditions automatically.

Adjusting Sea Clutter on the Radar Screen Manually

You can adjust the appearance of clutter caused by choppy sea conditions. The sea clutter setting affects the appearance of nearby clutter and targets more than it affects the appearance of distant clutter and targets. A higher sea clutter setting reduces the appearance of clutter caused by nearby waves, but it can also reduce or eliminate the appearance of nearby targets.

NOTE: Depending upon the radar in use, the sea clutter setting configured for use in one radar mode may or may not be applied to other radar modes or to the radar overlay.

- 1 From a radar screen or the radar overlay, select **Menu > Noise Rejection > Sea Clutter**.
- 2 Select **Up** or **Down** to adjust the appearance of sea clutter until other targets are clearly visible on the radar screen.
Clutter caused by sea conditions may still be visible.

Adjusting Rain Clutter on the Radar Screen

You can adjust the appearance of clutter caused by rain. Reducing the radar range also can minimize rain clutter ([Zooming In and Out of the Radar Screen](#)).

The rain clutter setting affects the appearance of nearby rain clutter and targets more than it affects the appearance of distant rain clutter and targets. A higher rain clutter setting reduces the

appearance of clutter caused by nearby rain, but it can also reduce or eliminate the appearance of nearby targets.

NOTE: Depending upon the radar in use, the rain clutter settings configured for use in one radar mode may or may not be applied to other radar modes or to the Radar overlay.

- 1 From a Radar screen or the Radar overlay, select **Menu > Noise Rejection > Rain Clutter**.
- 2 Select **Up** or **Down** to decrease or increase the appearance of nearby rain clutter until other targets are clearly visible on the Radar screen.

Clutter caused by rain may still be visible.

Reducing Cross Talk Clutter on the Radar Screen

You can reduce the appearance of clutter caused by interference from another nearby radar source, when the Cross Talk Reject setting is on.

NOTE: Depending upon the radar in use, the crosstalk setting configured for use in one radar mode may or may not be applied to other radar modes or to the Radar overlay.

From a Radar screen or the Radar overlay, select **Menu > Noise Rejection > Crosstalk Rej.**

Echo Trails

The echo trails feature enables you to track the movement of vessels on the radar display. You can change the length of time the trail is displayed.

NOTE: Depending upon the radar in use, the settings configured for use in one radar mode may or may not be applied to other radar modes or to the radar overlay.

NOTE: Not all options and settings are available on all radar and chartplotter models.

Turning on Echo Trails

From a radar screen or the radar overlay, select **Menu > Radar Setup > Echo Trails > Display**.

Adjusting the Length of the Echo Trails

- 1 From a radar screen or the radar overlay, select **Menu > Radar Setup > Echo Trails > Time**.
- 2 Select the length of the trail.

Clearing the Echo Trails

You can remove the echo trails from the radar screen to reduce the clutter the screen.

From a radar screen or the radar overlay, select **Clear Trails**.

Radar Display Settings

From any Radar screen or the Radar overlay, select **Menu > Radar Setup**.

Orientation: Sets the perspective of the radar display. The orientation setting applies to every radar mode. This setting does not apply to the Radar overlay.

Appearance: Sets the color scheme, look-ahead speed, and navigation appearance.

Front of Boat: Compensates for the physical location of the radar scanner on a boat, if the radar scanner does not align with the bow-stern axis.

Radar Appearance Settings

From a Radar screen, select **Menu > Radar Setup > Appearance**.

NOTE: These settings do not apply to the Radar overlay.

Color Scheme: Sets the color scheme.

Look-Ahead Speed: Shifts your present location toward the bottom of the screen automatically as your speed increases. Enter your top speed for the best results.

Heading Line: Shows an extension from the bow of the boat in the direction of travel on the radar screen.

Rings: Shows the range rings that help you to visualize distances on the radar screen.

Nav Lines: Shows the navigation lines that indicate the course you have set using Route To, Guide To, or Go To.

Waypoints: Shows waypoints on the radar screen.

Front-of-Boat Offset

The front-of-boat offset compensates for the physical location of the radar scanner on a boat, if the radar scanner does not align with the bow-stern axis.

Measuring the Potential Front-of-Boat Offset

The front-of-boat offset compensates for the physical location of the radar scanner on a boat, if the radar scanner does not align with the bow-stern axis.

- 1 Using a magnetic compass, take an optical bearing of a stationary target located within viewable range.
- 2 Measure the target bearing on the radar.
- 3 If the bearing deviation is more than +/- 1°, set the front-of-boat offset.

Setting the Front-of-Boat Offset

Before you can set the front-of-boat offset, you must measure the potential front-of-boat offset.

The front-of-boat offset setting configured for use in one radar mode is applied to every other radar mode and to the Radar overlay.

- 1 From a Radar screen or the Radar overlay, select **Menu > Radar Setup > Front of Boat**.
- 2 Select **Up** or **Down** to adjust the offset.

Selecting a Different Radar Source

- 1 Select an option:
 - From a radar screen or the radar overlay, select **Menu > Radar Setup > Source**.
 - Select **Settings > Communications > Preferred Sources > Radar**.
- 2 Select the radar source.

Autopilot

⚠ WARNING

You can use the autopilot feature only at a station installed next to a helm, throttle, and helm control device.

You are responsible for the safe and prudent operation of your vessel. The autopilot is a tool that enhances your capability to operate your boat. It does not relieve you of the responsibility of safely operating your boat. Avoid navigational hazards and never leave the helm unattended.

Always be prepared to promptly regain manual control of your boat.

Learn to operate the autopilot on calm and hazard-free open water.

Use caution when operating the autopilot near hazards in the water, such as docks, pilings, and other boats.

The autopilot system continuously adjusts the steering of your boat to maintain a constant heading (heading hold). The system also allows manual steering and several modes of automatic-steering functions and patterns.

Opening the Autopilot Screen

Before you can open the autopilot screen, you must have a compatible autopilot installed and configured.

Select **A/V, Gauges, Controls > Autopilot**.

Autopilot Screen



①	Actual heading
②	Intended heading (heading the autopilot is steering toward)
③	Actual heading (when in standby mode) Intended heading (when engaged)
④	Rudder position indicator (This functionality is available only when a rudder sensor is connected.)

Adjusting the Step Steering Increment

- 1 From the Autopilot screen, select **Menu > Autopilot Setup > Steering Mode > Step Turn Size**.
- 2 Select an increment.

Setting the Power Saver

You can adjust the level of rudder activity.

- 1 From the autopilot screen, select **Menu > Autopilot Setup > Power Saver**.
- 2 Select a percentage.

Selecting a higher percentage reduces rudder activity at the expense of heading performance. The higher the percentage, the more the course deviates before the autopilot corrects it.

TIP: In choppy conditions at low speeds, increasing the Power Saver percentage reduces rudder activity.

Enabling Shadow Drive™

NOTE: The Shadow Drive feature is available only on hydraulic steering systems.

From the autopilot screen, select **Menu > Autopilot Setup > Shadow Drive > Enabled**.

Engaging the Autopilot

When you engage the autopilot, the autopilot takes control of the helm and steers the boat to maintain your heading.

From any screen, select **Engage**.

Your intended heading shows in the center of the Autopilot screen.

Adjusting the Heading with the Helm

NOTE: You must enable the Shadow Drive feature before you can adjust the heading using the helm ([Enabling Shadow Drive™](#)).

With the autopilot engaged, manually steer the boat.

The autopilot activates Shadow Drive mode.

When you release the helm and manually maintain a specific heading for a few seconds, the autopilot resumes a heading hold at the new heading.

Adjusting the Heading with the Chartplotter in Step Steering Mode

Before you can steer your boat using the keys at the bottom of the autopilot screen, you must engage the autopilot ([Engaging the Autopilot](#)).

- Select **<1°** or **1°>** to initiate a single 1° turn.

- Select <<10° or 10°>> to initiate a single 10° turn.
- Hold <1° or 1°> to initiate a rate-controlled turn.
The boat continues to turn until you let go of the key.
- Hold <<10° or 10°>> to initiate a sequence of 10° turns.

Steering Patterns

⚠ WARNING

You are responsible for the safe operation of your boat. Do not begin a pattern until you are certain that the water is clear of obstacles.

The autopilot can steer the boat in preset patterns for fishing, and it can also perform other specialty maneuvers such as U-turns and Williamson turns.

Following the U-Turn Pattern

You can use the u-turn pattern to turn the boat around 180° and maintain the new heading.

- 1 From the autopilot screen, select **Menu > Pattern Steering > U-Turn > Engage**.
- 2 Select **Engage Port** or **Engage Starboard**.

Setting Up and Following the Circles Pattern

You can use the circles pattern to steer the boat in a continuous circle, in a specified direction, and at a specified time interval.

- 1 From the autopilot screen, select **Menu > Pattern Steering > Circles**.
- 2 If necessary, select **Time**, and select a time for the autopilot to steer one complete circle.
- 3 Select **Engage Port** or **Engage Starboard**.

Setting Up and Following the Zigzag Pattern

You can use the zigzag pattern to steer the boat from port to starboard and back, over a specified time and angle, across your present heading.

- 1 From the autopilot screen, select **Menu > Pattern Steering > Zigzag**.
- 2 If necessary, select **Amplitude**, and select a degree.
- 3 If necessary, select **Period**, and select a length of time.
- 4 Select **Engage Zigzag**.

Following the Williamson Turn Pattern

You can use the Williamson turn pattern to steer the boat around with the intent of running alongside the location where the Williamson turn pattern was initiated. The Williamson turn pattern can be used in man overboard situations.

- 1 From the autopilot screen, select **Menu > Pattern Steering > Williamson Turn**.
- 2 Select **Engage Port** or **Engage Starboard**.

Following an Orbit Pattern

You can use the orbit pattern to steer the boat in a continuous circle around the active waypoint. The size of the circle is defined by your distance from the active waypoint when you begin the orbit pattern.

- 1 From the autopilot screen, select **Menu > Pattern Steering > Orbit**.
- 2 Select **Engage Port** or **Engage Starboard**.

Setting Up and Following the Cloverleaf Pattern

You can use the cloverleaf pattern to steer the boat to repeatedly pass over an active waypoint. When you begin the cloverleaf pattern, the autopilot drives the boat toward the active waypoint and begins the cloverleaf pattern.

You can adjust the distance between the waypoint and the location where the autopilot turns the boat for another pass over

the waypoint. The default setting turns the boat at a range of 1000 ft. (300 m) from the active waypoint.

- 1 From the autopilot screen, select **Menu > Pattern Steering > Cloverleaf**.
- 2 If necessary, select **Length**, and select a distance.
- 3 Select **Engage Port** or **Engage Starboard**.

Setting Up and Following a Search Pattern

You can use the search pattern to steer the boat in increasingly larger circles outward from the active waypoint, forming a spiral pattern. When you begin the search pattern, the autopilot drives the boat to the active waypoint and begins the pattern.

You can adjust the distance between each circle in the spiral. The default distance between circles is 50 ft. (20 m).

- 1 From the autopilot screen, select **Menu > Pattern Steering > Search**.
- 2 If necessary, select **Search Spacing**, and select a distance.
- 3 Select **Engage Port** or **Engage Starboard**.

Cancelling a Steering Pattern

- Physically steer the boat.
NOTE: Shadow Drive must be enabled to cancel a steering pattern by physically steering the boat.
- Select ◀ or ▶ to cancel a pattern using step steering mode.
- Select **Standby**.

Digital Selective Calling

Networked Chartplotter and VHF Radio Functionality

If you have a NMEA 0183 VHF radio or a NMEA 2000 VHF radio connected to your chartplotter, these features are enabled.

- The chartplotter can transfer your GPS position to your radio. If your radio is capable, GPS position information is transmitted with DSC calls.
- The chartplotter can receive digital selective calling (DSC) distress and position information from the radio.
- The chartplotter can track the positions of vessels sending position reports.

If you have a Garmin NMEA 2000 VHF radio connected to your chartplotter, these features are also enabled.

- The chartplotter allows you to quickly set up and send individual routine call details to your Garmin VHF radio.
- When you initiate a man-overboard distress call from your radio, the chartplotter shows the man-overboard screen and prompts you to navigate to the man-overboard point.
- When you initiate a man-overboard distress call from your chartplotter, the radio shows the Distress Call page to initiate a man-overboard distress call.

Turning On DSC

Select **Settings > Other Vessels > DSC**.

DSC List

The DSC list is a log of the most recent DSC calls and other DSC contacts you have entered. The DSC list can contain up to 100 entries. The DSC list shows the most recent call from a boat. If a second call is received from the same boat, it replaces the first call in the call list.

Viewing the DSC List

Before you can view the DSC list, the chartplotter must be connected to a VHF radio that supports DSC.

Select **Info > DSC List**.

Adding a DSC Contact

You can add a vessel to your DSC list. You can make calls to a DSC contact from the chartplotter.

- 1 Select **Info > DSC List > Add Contact**.
- 2 Enter the Maritime Mobile Service Identity (MMSI) of the vessel.
- 3 Enter the name of the vessel.

Incoming Distress Calls

If your compatible chartplotter and VHF radio are connected using NMEA 0183 or NMEA 2000, your chartplotter alerts you when your VHF radio receives a DSC distress call. If position information was sent with the distress call, that information is also available and recorded with the call.

■ designates a distress call in the DSC list and marks the position of the vessel on the Navigation chart at the time of the DSC distress call.

Navigating to a Vessel in Distress

■ designates a distress call in the DSC list and marks the position of a vessel on the Navigation chart at the time of the DSC distress call.

- 1 Select **Info > DSC List**.
- 2 Select a position-report call.
- 3 Select **Review > Navigate To**.
- 4 Select **Go To** or **Route To**.

Man-Overboard Distress Calls Initiated from a VHF Radio

When the chartplotter is connected to a compatible VHF radio with NMEA 2000, and you initiate a man-overboard DSC distress call from the radio, the chartplotter shows the man-overboard screen and prompts you to navigate to the man-overboard point. If you have a compatible autopilot system connected to the network, the chartplotter prompts you to start a Williamson's turn to the man-overboard point.

If you cancel the man-overboard distress call on the radio, the chartplotter screen prompting you to activate navigation to the man-overboard location disappears.

Man-Overboard and SOS Distress Calls Initiated from the Chartplotter

When your chartplotter is connected to a Garmin NMEA 2000 compatible radio and you mark an SOS or man-overboard location, the radio shows the Distress Call page so you can quickly initiate a distress call.

For information on placing distress calls from your radio, see the VHF radio owner's manual. For information about marking an MOB or SOS location, see [Marking an SOS Location](#).

Position Tracking

When you connect the chartplotter to a VHF radio using NMEA 0183, you can track vessels that send position reports.

This feature is also available with NMEA 2000, when the vessel sends the correct PGN data (PGN 129808; DSC Call Information).

Every position report call received is logged in the DSC list ([DSC List](#)).

Viewing a Position Report

- 1 Select **Info > DSC List**.
- 2 Select a position-report call.
- 3 Select **Review**.
- 4 Select an option:
 - To switch to a Navigation chart marking the location, select **Next Page**.

- To view the position report details, select **Previous Page**.

Navigating to a Tracked Vessel

- 1 Select **Info > DSC List**.
- 2 Select a position-report call.
- 3 Select **Review > Navigate To**.
- 4 Select **Go To** or **Route To**.

Creating a Waypoint at the Position of a Tracked Vessel

- 1 Select **Info > DSC List**.
- 2 Select a position-report call.
- 3 Select **Review > Create Waypoint**.

Editing Information in a Position Report

- 1 Select **Info > DSC List**.
- 2 Select a position-report call.
- 3 Select **Review > Edit**.
 - To enter the name of the vessel, select **Name**.
 - To select a new symbol, select **Symbol**, if available.
 - To enter a comment, select **Comment**.
 - To show a trail line for the vessel if your radio is tracking the position of the vessel, select **Trail**.
 - To select a color for the trail line, select **Trail Line**.

Deleting a Position-Report Call

- 1 Select **Info > DSC List**.
- 2 Select a position-report call.
- 3 Select **Review > Clear Report**.

Viewing Vessel Trails on the Chart

You can view trails for all tracked vessels on some chart views. By default, a black line indicates the path of the vessel, a black dot indicates each previously reported position of a tracked vessel, and a blue flag indicates the last reported position of the vessel.

- 1 From a chart or 3D chart view, select **Menu > Chart Setup > Other Vessels > DSC > DSC Trails**.
- 2 Select the number of hours to show tracked vessels on the chart.

For example, if you select 4 Hours, all trail points that are less than four hours old appear for all tracked vessels.

Individual Routine Calls

When you connect the chartplotter to a Garmin VHF radio, you can use the chartplotter interface to set up an individual routine call.

When setting up an individual routine call from your chartplotter, you can select the DSC channel on which you want to communicate. The radio transmits this request with your call.

Selecting a DSC Channel

NOTE: The selection of a DSC channel is limited to those channels that are available in all frequency bands. The default channel is 72. If you select a different channel, the chartplotter uses that channel for subsequent calls until you call using another channel.

- 1 Select **Info > DSC List**.
- 2 Select a vessel or a station to call.
- 3 Select **Review > Call with Radio > Channel**.
- 4 Select an available channel.

Making an Individual Routine Call

NOTE: When initiating a call from the chartplotter, if the radio does not have an MMSI number programmed, the radio will not receive call information.

- 1 Select **Info > DSC List**.
- 2 Select a vessel or a station to call.
- 3 Select **Review > Call with Radio**.
- 4 If necessary, select **Channel**, and select a new channel.
- 5 Select **Send**.
The chartplotter sends information about the call to the radio.
- 6 On your Garmin VHF radio, select **Call**.

Making an Individual Routine Call to an AIS Target

- 1 From a chart or 3D chart view, select an AIS target.
- 2 Select **AIS Vessel > Call with Radio**.
- 3 If necessary, select **Channel**, and select a new channel.
- 4 Select **Send**.
The chartplotter sends information about the call to the radio.
- 5 On your Garmin VHF radio, select **Call**.

Gauges and Graphs

The gauges and graphs provide various information about the engine and environment. To view the information, a compatible transducer or sensor must be connected to the network.

Viewing the Gauges

- 1 Select **A/V, Gauges, Controls**.
- 2 Select a gauge.
- 3 Select ◀ or ▶ to view a different gauge page.

Changing the Data Shown in a Gauge

- 1 From a gauges screen, hold a gauge.
- 2 Select a data type.
- 3 Select the data to display.

Customizing Engine Gauge and Fuel Gauge Limits

You can configure the upper and lower limits and the range of desired standard operation of a gauge. When a value exceeds the range of standard operation, the gauge becomes red.

NOTE: Not all options are available for all gauges.

- 1 From the engine gauges screen, select **Menu > Gauge Setup > Set Gauge Limits**.
- 2 Select a gauge.
- 3 Select **Mode > Custom**.
- 4 Select an option:
 - To set the minimum value of the standard operating range, select **Rated Min..**
 - To set the maximum value of the standard operating range, select **Rated Max..**
 - To set the lower limit of the gauge lower than the rated minimum, select **Scale Min..**
 - To set the upper limit of the gauge higher than the rated maximum, select **Scale Max..**
- 5 Select the limit value.
- 6 Repeat steps 4 and 5 to set additional gauge limits.

Viewing Engine and Fuel Gauges

Before you can view engine and fuel gauges, you must be connected to a NMEA 2000 network capable of sensing engine and fuel data. See the installation instructions for details.

Select **A/V, Gauges, Controls > Engines**.

Selecting the Number of Engines Shown in Gauges

You can show information for up to four engines.

- 1 From the engine gauges screen, select **Menu > Gauge Setup > Engine Selection > Num. Engines**.
- 2 Select an option:
 - Select the number of engines.
 - Select **Auto Configure** to automatically detect the number of engines.

Customizing the Engines Shown in Gauges

Before you can customize how the engines are shown in the gauges, you must manually select the number of engines (**Selecting the Number of Engines Shown in Gauges**).

- 1 From the engine gauges screen, select **Menu > Gauge Setup > Engine Selection > Edit Engines**.
- 2 Select **First Engine**.
- 3 Select the engine to display in the first gauge.
- 4 Repeat for the remaining engine bars.

Enabling Status Alarms for Engine Gauges

You can enable the chartplotter to display engine status alarms.

From the engine gauges screen, select **Menu > Gauge Setup > Status Alarms > On**.

When an engine alarm is triggered, a gauge status alarm message appears and the gauge may become red depending on the type of alarm.

Enabling Some Engine Gauge Status Alarms

- 1 From the engine gauges screen, select **Menu > Gauge Setup > Status Alarms > Custom**.
- 2 Select one or more engine gauge alarms to turn on or off.

Setting the Fuel Alarm

Before you can set a fuel level alarm, a compatible fuel flow sensor must be connected to the NMEA 2000 network.

You can set an alarm to sound when the total amount of remaining onboard fuel reaches the level you specify.

- 1 Select **Settings > Alarms > Fuel > Fuel Level Alarm > On**.
- 2 Enter the remaining amount of fuel that triggers the alarm.

Setting the Fuel Capacity of the Vessel

- 1 Select **Settings > My Vessel > Fuel Capacity**.
- 2 Enter the combined total capacity of the fuel tanks.

Synchronizing the Fuel Data with the Actual Vessel Fuel

You can synchronize the fuel levels in the chartplotter with the actual fuel in the vessel when you add fuel to your vessel.

- 1 Select **A/V, Gauges, Controls > Engines > Menu**.
- 2 Select an option:
 - After you have filled up all the fuel tanks on the vessel, select **Fill Up All Tanks**. The fuel level is reset to maximum capacity.
 - After you have added less than a full tank of fuel, select **Add Fuel to Boat**, and enter the amount added.
 - To specify the total fuel in the vessel tanks, select **Set Total Fuel Onboard**, and enter the total amount of fuel in the tanks.

Viewing the Wind Gauges

Before you can view wind information, you must have a wind sensor connected to the chartplotter.

Select **A/V, Gauges, Controls > Wind**.

Configuring the Sailing Wind Gauge

You can configure the sailing wind gauge to show true or apparent wind speed and angle.

- 1 From the wind gauge, select **Menu > Sailing Wind Gauge**.
- 2 Select an option:
 - To show true or apparent wind angle, select **Needle**, and select an option.
 - To show true or apparent wind speed, select **Wind Speed**, and select an option.

Configuring the Speed Source

You can specify whether the vessel speed data displayed on the gauge and used for wind calculations is based on water speed or GPS speed.

- 1 From the wind gauge, select **Menu > Compass Gauge > Speed Display**.
- 2 Select an option:
 - To calculate the vessel speed based on data from the water-speed sensor, select **Water Speed**.
 - To calculate the vessel speed based on GPS data, select **GPS Speed**.

Configuring the Heading Source of the Wind Gauge

You can specify the source of the heading displayed on the wind gauge. Magnetic heading is the heading data received from a heading sensor, and GPS heading is calculated by your chartplotter GPS (course over ground).

- 1 From the wind gauge, select **Menu > Compass Gauge > Heading Source**.
- 2 Select **GPS Hdg.** or **Magnetic**.
NOTE: When moving at low speeds or when stationary, the magnetic compass source is more accurate than the GPS source.

Customizing the Close-Hauled Wind Gauge

You can specify the range of the close-hauled wind gauge for both the upwind scale and the downwind scale.

- 1 From the wind gauge, select **Menu > Compass Gauge > Gauge Type > Close Hauled Gauge**.
- 2 Select an option:
 - To set the maximum and minimum values that appear when the upwind close-hauled wind gauge appears, select **Change Upwind Scale**, and set the angles.
 - To set the maximum and minimum values that appear when the downwind close-hauled wind gauge appears, select **Change Downwind Scale**, and set the angles.
 - To view true or apparent wind, select **Wind**, and select an option.

Viewing Trip Gauges

Trip gauges show information for odometer, speed, time, and fuel for your present trip.

Select **Info > Trip & Graphs > Trip**.

Resetting Trip Gauges

- 1 Select **Info > Trip & Graphs > Trip**.
- 2 Select an option:
 - To set all the readings for the present trip to zero, select **Reset Trip**.
 - To set the maximum speed reading to zero, select **Reset Maximum Speed**.
 - To set the odometer reading to zero, select **Reset Odometer**.
 - To set all the readings to zero, select **Reset All**.

Viewing Graphs

Before you can view graphs of various environmental changes, such as temperature, depth, and wind, you must have an appropriate transducer or sensor connected to the network.

Select **Info > Trip & Graphs > Graphs**.

Setting the Graph Range and Time Scales

You can indicate the amount of time and the range of depth that appear in the depth and water temperature graphs.

- 1 From a graph, select **Graph Setup**.
- 2 Select an option:
 - To set a time-elapsed scale, select **Duration**. The default setting is 10 minutes. Increasing the time-elapsed scale allows you to view variations over a longer period of time. Decreasing the time-elapsed scale allows you to view more detail over a shorter period of time.
 - To set the graph scale, select **Scale**. Increasing the scale allows you to view more variation in readings. Decreasing the scale allows you to view more detail in the variation.

Tide, Current, and Celestial Information

Tide Station Information

You can view information about a tide station for a specific date and time, including the tide height, and when the next high and low tides will occur. By default, the chartplotter shows tide information for the most recently viewed tide station and for the present date and time.

Select **Info > Tides & Currents > Tides**.

Current Station Information

NOTE: Current station information is available with certain detailed maps.

You can view information about a current station for a specific date and time, including the current speed and level of the current. By default, the chartplotter shows current information for the most recently viewed current station and for the present date and time.

Select **Info > Tides & Currents > Currents**.

Celestial Information

You can view information about sunrise, sunset, moonrise, moonset, moon phase, and the approximate sky view location of the sun and moon. The center of the screen represents the sky overhead, and the outermost rings represent the horizon. By default, the chartplotter shows celestial information for the present date and time.

Select **Info > Tides & Currents > Celestial**.

Viewing Tide Station, Current Station, or Celestial Information for a Different Date

- 1 Select **Info > Tides & Currents**.
- 2 Select **Tides, Currents, or Celestial**.
- 3 Select an option.
 - To view information for a different date, select **Change Date > Manual**, and enter a date.
 - To view information for today, select **Change Date > Current**.
 - If available, to view information for the day after the date shown, select **Next Day**.
 - If available, to view information for the day before the date shown, select **Previous Day**.

Viewing Information for a Different Tide or Current Station

- 1 Select **Info** > **Tides & Currents**.
- 2 Select **Tides** or **Currents**.
- 3 Select **Nearby Stations**.
- 4 Select a station.

Viewing Almanac Information from the Navigation Chart

- 1 From a chart or 3D chart view, select a location.
- 2 Select **Information**.
- 3 Select **Tides**, **Currents**, or **Celestial**.

Warning Manager

Viewing Messages

- 1 Select **Info** > **Warning Manager**.
- 2 Select a message.
- 3 Select **Review**.

Sorting and Filtering Messages

- 1 Select **Info** > **Warning Manager** > **Sort/Filter**.
- 2 Select an option to sort or filter the message list.

Saving Messages to a Memory Card

- 1 Insert a memory card into the card slot.
- 2 Select **Info** > **Warning Manager** > **Save to Card**.

Clearing all of the Messages

Select **Info** > **Warning Manager** > **Clear Warning Manager**.

Media Player

NOTE: The media player feature is not compatible with all chartplotter models.

If you have a FUSION-Link™ capable stereo connected to the NMEA 2000 network, you can control the stereo using the chartplotter. The chartplotter should automatically detect the media player when it is first connected.

You can play media from sources connected to the media player and sources connected to the NMEA 2000 network. Your chartplotter and iPod® can be connected using a FUSION-Link capable stereo.

Opening the Media Player

Before you can open the media player, you must connect a compatible device to the chartplotter.

Select **A/V**, **Gauges**, **Controls** > **Media**.

Icons

NOTE: Not all devices have these icons.

Icon	Description
★	Saves or deletes a channel as a preset
↻	Repeats all songs
↻ ¹	Repeats one song
⏮⏭⏭⏮	Searches for stations or skips songs
↻	Shuffles

Selecting the Media Source

When you have multiple media devices connected on a network, such as the NMEA 2000 network, you can select the media source you want to control from your chartplotter.

NOTE: You can play media only from sources that are connected to the device.

NOTE: Not all features are available on all media sources.

- 1 From the media screen, select **Source**.

NOTE: The source menu appears only for devices that support multiple media sources.

- 2 Select a source.

Playing Music

Browsing for Music

- 1 From the media screen, select **Browse** or **Menu** > **Browse**.
- 2 Select **Select** or select an option.

Enabling Alphabetical Search

You can enable the alphabetical search feature to find a song or album in a large list.

From the media screen, select **Menu** > **Installation** > **Alpha Search**.

Setting a Song to Repeat

- 1 While playing a song, select **Menu** > **Repeat**.
- 2 If necessary, select **Single**.

Setting All Songs to Repeat

From the media screen, select **Menu** > **Repeat** > **All**.

Setting Songs to Shuffle

- 1 From the media screen, select **Menu** > **Shuffle**.
- 2 If necessary, select an option.

Listening to the Radio

Saving a Channel as a Preset

You can save up to 15 AM stations and 15 FM stations as presets.

- 1 From the AM, FM, or VHF page, tune the device to a channel.
- 2 Select **Presets** > **Add Current Channel**.

Removing a Channel Preset

- 1 Tune the device to a channel.
- 2 Select **Menu** > **Presets** > **Remove Current Channel**.

Changing the Tuning Mode

You can change how you select a station for some media types, such as FM or AM radio.

NOTE: Not all tuning modes are available for all media sources.

- 1 From the media screen, select **Menu** > **Tuning Mode**.
- 2 Select an option.
- 3 If necessary, select **Select**.

Setting the Tuner Region

- 1 From the media screen, select **Menu** > **Installation** > **Tuner Region**.
- 2 Select an option.

Opening the MTP Source

Before you can open the MTP source, you must connect your MTP device to a compatible media device.

You can access music on your Media Transfer Protocol (MTP) device, such as an Android™ device. You can also charge your phone or media player while it is connected and playing music.

- 1 Connect your MTP source through USB, such as the stereo, the external USB plug, or an external dock.

- 2 From the media screen, select **Source > MTP**.

Adjusting the Volume

Enabling and Disabling Zones

If you have wired your vessel's speakers into zones, you can disable unused zones.

- 1 From the media screen, select **Menu > Audio Levels > Enable/Disable Zones**.
- 2 Select a zone.

Muting the Media Volume

- 1 From the media screen, select .
- 2 If necessary, select **Select**.

Scanning VHF Channels

Before you can scan VHF channels, you must set the source to VHF.

You can monitor VHF channels saved as presets for activity and automatically switch to an active channel.

From the VHF media screen, select **Scan**.

Adjusting the VHF Squelch

NOTE: Your media player must support VHF radio to use this feature.

- 1 From the VHF source page, select **Menu > Squelch**.
- 2 Use the slider bar to adjust the VHF squelch.

SiriusXM® Satellite Radio

When you have a FUSION-Link capable stereo and SiriusXM Connect Tuner installed and connected to the chartplotter, you may have access to SiriusXM satellite radio, depending on your subscription.

Locating a SiriusXM Radio ID

Before you can activate your SiriusXM subscription, you must have the radio ID of your SiriusXM Connect Tuner.

You can locate the SiriusXM Radio ID on the back of the SiriusXM Connect Tuner, on the back of its packaging, or by tuning your chartplotter to channel 0.

- 1 Select **Media > Source > SiriusXM**.
- 2 Tune to channel 0.

The SiriusXM radio ID does not include the letters I, O, S, or F.

Activating a SiriusXM Subscription

Before you can activate the SiriusXM subscription, you must have the Radio ID ([Locating a SiriusXM Radio ID](#)).

- 1 With the SiriusXM source selected, tune to channel 1.
You should be able to hear the preview channel. If not, check the SiriusXM Connect Tuner and antenna installation and connections, and try again.
- 2 Tune to channel 0 to locate the Radio ID.
- 3 Contact SiriusXM listener care by phone at (866) 635-2349 or go to www.siriusxm.com/activatenow to subscribe in the United States. Contact SiriusXM by phone at (877) 438-9677 or go to www.siriusxm.ca/activatexm to subscribe in Canada.
- 4 Provide the Radio ID.

The activation process usually takes 10 to 15 minutes, but can take up to an hour. For the SiriusXM Connect Tuner to receive the activation message, it must be turned on and receiving the SiriusXM signal.

- 5 If the service is not activated within the hour, go to <http://care.siriusxm.com/refresh> or contact SiriusXM by phone at 1-855-MYREFRESH (697-3373).

Customizing the Channel Guide

SiriusXM radio channels are grouped in categories. You can select the categories of channels that appear in the channel guide.

NOTE: This feature is available with a GXM™ 52 antenna.

- 1 Select **Media > Category**.
- 2 Select a category.

Saving a SiriusXM Channel to the Presets List

You can save your favorite channels to the presets list.

- 1 Select **Media**.
- 2 Select the channel you want to save as a preset.
- 3 Select **Menu > Presets > Add Current Channel**.

Unlocking SiriusXM Parental Controls

- 1 From the media screen, select **Browse > Parental > Unlock**.
- 2 Enter your passcode.

The default passcode is 0000.

Setting Parental Controls on SiriusXM Radio Channels



Before you can set parental controls, the parental controls must be unlocked.

The parental control feature allows you to limit access to any SiriusXM channels, including those with mature content. When enabled, the parental control feature requires you to enter a passcode to tune to the locked channels.

Select **Browse > Parental > Lock/Unlock**.

A list of channels appears. A checkmark indicates a locked channel.

NOTE: When you view the channels after setting parental controls, the display changes:

-  indicates a locked channel.
-  indicates an unlocked channel.

Changing a Parental Passcode on a SiriusXM Radio

Before you can change the passcode, the parental controls must be unlocked.

- 1 From the media screen, select **Browse > Parental > Change PIN**.
- 2 Enter your passcode and select **Done**.
- 3 Enter a new passcode.
- 4 Confirm the new passcode.

Restoring Default Parental Control Settings Values

This process deletes all the settings information you have entered. When you restore the parental control settings to their default values, the passcode value is reset to 0000.

- 1 From the media menu, select **Installation > Factory Defaults**.
- 2 Select **Yes**.

Clearing All Locked Channels on a SiriusXM Radio

Before you can clear all locked channels, the parental controls must be unlocked.

- 1 From the media screen, select **Browse > Parental > Clear All Locked**.
- 2 Enter your passcode.

Setting the Device Name

- 1 From the media screen, select **Menu > Installation > Set Device Name**.
- 2 Enter a device name.
- 3 Select **Select** or **Done**.

SiriusXM Weather

WARNING

The weather information provided through this product is subject to service interruptions and may contain errors, inaccuracies, or outdated information, and consequently should not be relied upon exclusively. Always use common sense while navigating, and check alternate weather information sources prior to making safety-related decisions. You acknowledge and agree that you shall be solely responsible for use of the weather information and all decisions taken with respect to navigating in weather. Garmin will not be responsible for any consequences of using SiriusXM weather information.

NOTE: SiriusXM data is not available in all regions.

A Garmin SiriusXM satellite weather receiver and antenna receives satellite weather data and shows it on various Garmin devices, including the Navigation chart on a compatible chartplotter. The weather data for each feature comes from reputable weather data centers such as the National Weather Service and the Hydrometeorological Prediction Center. For more information, go to www.siriusxm.com/sxmmarine.

SiriusXM Equipment and Subscription Requirements

To use satellite weather, you must have a compatible satellite weather receiver. To use SiriusXM satellite radio, you must have a compatible satellite radio receiver. Go to www.garmin.com for more information. You must also have a valid subscription to receive satellite weather and radio. For more information, refer to the instructions for your satellite weather and radio equipment.

Weather Data Broadcasts

Weather data is broadcast at different intervals for each weather feature. For example, radar is broadcast at five-minute intervals. When the Garmin receiver is turned on, or when a different weather feature is selected, the receiver must receive new data before it can be shown. You might experience a delay before weather data or a different feature appears on the chart.

NOTE: Any weather feature can change in appearance if the source that provides the information changes.

Changing the Weather Chart

- 1 From a combination screen or SmartMode layout with a weather chart, select **Menu > Weather Menu > Change Weather**.
- 2 Select a weather chart.

Viewing Precipitation Information

Precipitation ranging from very light rain and snow, up to strong thunderstorms, is indicated in varying shades and colors. Precipitation is shown either independently or with other weather information.

Select **Charts > Precipitation**.

The time stamp in the upper-left corner of the screen indicates the elapsed time since the weather data provider last updated the information.

Precipitation Views

From the precipitation weather chart, select **Menu**.

RADAR Loop: Shows precipitation information as an image of the latest update or as an animated loop of the latest updates. The time stamp indicates the elapsed time since the service provider generated the weather radar frame currently displayed on the screen.

Cloud Cover: Shows cloud cover data.

Waypoints: Shows waypoints.

Legend: Shows the weather legend.

Storm Cell and Lightning Information

Storm cell are represented by  on the weather precipitation chart. They indicate both the present position of a storm and the projected path of that storm in the immediate future.

Red cones appear with a storm cell icon, and the widest part of each cone points in the direction of the projected path of the storm cell. The red lines in each cone indicate where the storm will most likely be in the near future. Each line represents 15 minutes.

Lightning strikes are represented by . Lightning appears on the weather precipitation chart if strikes were detected within the last seven minutes. The ground-based lightning detection network detects cloud-to-ground lightning only.

NOTE: This feature is not available on all devices and in all subscriptions.

Hurricane Information

The weather Precipitation chart can show the present position of a hurricane , a tropical storm, or a tropical depression. A red line stemming from a hurricane icon indicates the projected path of the hurricane. Darkened dots on the red line indicate the projected locations through which the hurricane will pass, as received from the weather data provider.

Weather Warnings and Weather Bulletins

When a marine weather warning, weather watch, weather advisory, weather bulletin, or other weather statement is issued, shading indicates the area to which the information applies. The aqua lines on the chart indicate the boundaries of marine forecasts, coastal forecasts, and offshore forecasts. Weather bulletins may consist of either weather watches or weather advisories.

To view information about the warning or bulletin, select the shaded area.

Color	Marine Weather Group
Cyan	Flash Flood
Blue	Flood
Red	Marine
Yellow	Severe Storm
Red	Tornado

Forecast Information



The Forecast chart shows city forecasts, marine forecasts, warnings, hurricane warnings, METARS, county warnings, weather fronts and pressure centers, surface pressure, and weather buoys.

Viewing Forecast Information for Another Time Period

- 1 Select **Charts > Forecast**.
- 2 Select an option:
 - To view the weather forecast for the next 48 hours, in 12-hour increments, select **Next Forecast** multiple times.
 - To view the weather forecast for the previous 48 hours, in 12-hour increments, select **Previous Forecast** multiple times.

Weather Fronts and Pressure Centers

Weather fronts appear as lines that indicate the leading edge of an air mass.

Front Symbol	Description
	Cold front
	Warm front

Front Symbol	Description
	Stationary front
	Occluded front
	Trough

Pressure-center symbols often appear near weather fronts.

Pressure-Center Symbol	Description
L	Indicates a low-pressure center, which is a region of relatively lower pressure. Moving away from a low-pressure center results in increased pressure. Winds flow counterclockwise around low-pressure centers in the northern hemisphere.
H	Indicates a high-pressure center, which is a region of relatively higher pressure. Moving away from a high-pressure center results in decreased pressure. Winds flow clockwise around high-pressure centers in the northern hemisphere.

Viewing a Marine Forecast or an Offshore Forecast

- 1 Select **Charts > Forecast**.
- 2 Pan the chart to an offshore location.
The Marine Forecast or Offshore Forecast options appear when forecast information is available.
- 3 Select **Marine Forecast** or **Offshore Forecast**.

City Forecasts

City forecasts appear as weather symbols. The forecast is viewed in 12-hour increments.

Symbol	Weather	Symbol	Weather
	Partly cloudy		Fair (sunny, hot, clear)
	Cloudy		Rain (drizzle, sleet, showers)
	Windy		Foggy
	Thunderstorms		Snow (snow showers, flurries, blizzard, blowing snow, sleet, freezing rain, freezing drizzle)
	Smoke (dusty, hazy)		

Viewing Sea Conditions

The Sea Conditions feature shows information about surface conditions, including winds, wave height, wave period, and wave direction.

Select **Charts > Sea Conditions**.

Surface Winds

Surface wind vectors appear on the Sea Conditions chart using wind barbs that indicate the direction from which the wind is blowing. A wind barb is a circle with a tail. The line or flag attached to the tail of the wind barb indicates the wind speed. A short line represents 5 knots, a long line represents 10 knots, and triangle represents 50 knots.

Wind Barb	Wind Speed	Wind Barb	Wind Speed
	Calm		20 knots
	5 knots		50 knots
	10 knots		65 knots
	15 knots		

Wave Height, Wave Period, and Wave Direction

Wave heights for an area appear as variations in color. Different colors indicate different wave heights, as shown in the legend.

The wave period indicates the time (in seconds) between successive waves. Wave period lines indicate areas that have the same wave period.

Wave directions appear on the chart using red arrows. The direction of each arrow pointer indicates the direction in which a wave is moving.

Viewing Forecast Sea Conditions Information for Another Time Period

- 1 Select **Charts > Sea Conditions**.
- 2 Select an option:
 - To view forecasted sea conditions for the next 36 hours, in 12-hour increments, select **Next Forecast** multiple times.
 - To view the forecasted sea conditions for the previous 36 hours, in 12-hour increments, select **Previous Forecast** multiple times.

Viewing Fishing Information

The weather Fishing chart shows present water temperature, present surface pressure conditions, and fishing forecasts.

Select **Charts > Fishing**.

Surface Pressure and Water Temperature Data

Surface-pressure information appears as pressure isobars and pressure centers. Isobars connect points of equal pressure. Pressure readings can help to determine weather and wind conditions. High-pressure areas are generally associated with fair weather. Low-pressure areas are generally associated with clouds and the chance of precipitation. Isobars packed closely together show a strong pressure gradient. Strong pressure gradients are associated with areas of stronger winds.

Pressure units are shown in millibars (mb), inches of Mercury (inHg), or hectopascals (hPa).

Colored shading indicates the surface temperature of the water, as shown in the legend in the corner of the display.

Forecasting Fish Locations

You can show areas that contain optimal weather conditions for specific species of fish.

NOTE: This feature is not available on all devices and in all subscriptions.

- 1 From the weather Fishing chart, select **Menu > Fish Species**.
- 2 Select a species of fish.
- 3 Select **On**.
- 4 Repeat steps 2 and 3 to show areas with optimal weather conditions for additional species of fish.

Shaded areas indicate optimal fishing areas. If you have selected more than one species of fish, you can select a shaded area to view the fish species that are included in the shaded area.

Changing the Sea Surface Temperature Color Range

You can change the color range dynamically to view higher resolution sea surface temperature readings.

- 1 From the weather fishing chart, select **Menu > Sea Temperature**.
- 2 Select an option:
 - To allow the chartplotter to adjust the temperature range automatically, select **Auto Configure**.
The chartplotter automatically finds the lower and upper limits for the current screen, and updates the temperature-color scale.
 - To enter the lower and upper limits for the temperature range, select **Lower Limit** or **Upper Limit**, and enter the lower or upper limit.

Visibility Information

Visibility is the forecast maximum horizontal distance that can be seen at the surface, as shown in the legend on the left of the

screen. Variations in the visibility shading show the forecast change in surface visibility.

NOTE: This feature is not available on all devices and in all subscriptions.

Select **Charts > Visibility**.

Viewing Forecast Visibility Information for Another Time Period

- 1 Select **Charts > Visibility**.
- 2 Select an option:
 - To view the visibility forecast for the next 36 hours, in 12-hour increments, select **Next Forecast** multiple times.
 - To view the visibility forecast for the previous 36 hours, in 12-hour increments, select **Previous Forecast** multiple times.

Viewing Buoy Reports

Report readings are taken from buoys and coastal observation stations. These readings are used to determine air temperature, dew point, water temperature, tide, wave height and period, wind direction and speed, visibility, and barometric pressure.

- 1 From a weather chart, select .
- 2 Select **Buoy**.

Viewing Local Weather Information near a Buoy

You can select an area near a buoy to view forecast information.

- 1 From a weather chart, select a location on the chart.
- 2 Select **Local Weather**.
- 3 Select an option:
 - To view present weather conditions from a local weather service, select **Current Cond.**
 - To view a local weather forecast, select **Forecast**.
 - To view surface wind and barometric pressure information, select **Sea Surface**.
 - To view wind and wave information, select **Marine Bulletin**.

Creating a Waypoint on a Weather Chart

- 1 From a weather chart, select a location.
- 2 Select **Create Waypoint**.

Weather Overlay

The weather overlay superimposes weather and weather-related information on the Navigation chart, the Fishing chart, and the Perspective 3D chart view. The Navigation chart and the Fishing chart can show weather radar, height of cloud tops, lightning, weather buoys, county warnings, and hurricane warnings. The Perspective 3D chart view can show weather radar.

Weather overlay settings configured for use on one chart are not applied to another chart. The weather overlay settings for each chart must be configured separately.

NOTE: The offshore Fishing chart is available with premium charts, in some areas.

Turning On the Weather Overlay on a Chart

From the Navigation chart or Fishing chart, select **Menu > Chart Setup > Weather > Weather > On**.

Weather Overlay Settings on the Navigation Chart

From the Navigation chart, select **Menu > Chart Setup > Weather**.

Weather: Turns on and off the weather overlay.

Precipitation: Shows precipitation data.

Cloud Cover: Shows cloud cover data.

Visibility: Shows visibility data.

Buoys: Shows weather buoys.

Legend: Shows the weather legend.

Weather Overlay Settings on the Fishing Chart

From the Fishing chart, select **Menu > Chart Setup > Weather**.

Precipitation: Shows precipitation radar.

Sea Temperature: Shows sea temperature data.

Buoys: Shows weather buoys.

Legend: Shows the weather legend.

Viewing Weather Subscription Information

You can view information about the weather services you have subscribed to and how many minutes have passed since the data for each service was updated.

From a weather chart, select **Menu > Weather Subscription**.

Viewing Video

Before you can view video, you must connect to a compatible source.

Compatible devices include video devices connected to the ports on the chartplotter, as well as supported network (IP-based) video cameras, encoders, and thermal cameras.

Select **A/V, Gauges, Controls > Video**.

Selecting a Video Source

- 1 From the video screen, select **Menu > Source**.
- 2 Select the source of the video feed.

Alternating Among Multiple Video Sources

If you have two or more video sources, you can alternate between them using a specific time interval.

- 1 From the video screen, select **Menu > Source > Alternate**.
- 2 Select **Time**, and select the amount of time each video appears.
- 3 Select **Source**, and select the video sources to add to the alternating sequence.

Networked Video Devices

NOTICE

A Garmin Power over Ethernet (PoE) Isolation Coupler (P/N 010-10580-10) must be used when connecting a PoE device, such as a FLIR® camera, to a Garmin Marine Network. Connecting a PoE device directly to a Garmin Marine Network chartplotter damages the Garmin chartplotter and may damage the PoE device.

Before you can view and control video devices such as IP cameras, encoders, and thermal cameras using your chartplotter, you must have a compatible video device connected to your chartplotter, and you must have a marine network cable Power over Ethernet (PoE) isolation coupler. Go to www.garmin.com for a list of compatible devices or to purchase a PoE Isolation Coupler.

You can connect multiple supported video cameras and up to two video encoders to the Garmin Marine Network. You can select and view up to four video sources at once. Chartplotters with multiple composite built-in video inputs can display a single built-in video input only. When the cameras are connected, the network detects them automatically and displays them in the source list.

Using Video Presets on Networked Video Cameras

You can save, name, and activate video presents for each networked video source.

Saving Video Presets on a Networked Video Camera

- 1 From a video screen, touch the screen.
The video controls appear on the screen.
- 2 Hold a video preset button.
A green light indicates the setting is stored.

Naming Video Presets on a Networked Video Camera

- 1 From a video screen, select **Menu > Video Setup > Presets**.
- 2 Select a preset.
- 3 Select **Rename**.
- 4 Enter preset name.

Activating Video Presets on a Networked Video Camera

You can quickly return networked cameras to preset values.

- 1 From a video screen, touch the screen.
The video controls appear on the screen.
- 2 Select a video preset.
The camera restores the video settings saved for that preset.
TIP: You can also save and activate presets using the video menu.

Camera Settings

Some cameras provide additional options to control the camera view.

NOTE: Not all options are available on all camera models and chartplotter models. Refer to the camera manual for a list of available features. You may need to update the camera software to use this feature.

From the infrared video screen, select **Menu**.

IR/Visible: Displays an infrared or visible camera image.

Scan: Surveys the surrounding area.

Freeze: Pauses the camera image.

Change Colors: Selects the color scheme of the infrared image.

Change Scene: Selects the infrared image mode, such as day, night, MOB, or docking.

Video Setup: Opens more video options.

Video Settings

Some cameras provide additional setup options.

NOTE: Not all options are available on all camera models and chartplotter models. You may need to update the camera software to use this feature.

From the video screen, select **Menu > Video Setup**.

Set Input: Associates the camera with a video source.

Mirror: Reverses the image like a rearview mirror.

Standby: Places the camera in standby mode to conserve power and protect the lens when not in use.

Home Position: Sets the home position of the camera.

Scan Speed: Sets how quickly the camera moves during a scan.

Scan Width: Sets the width of the image captured by the camera during a scan.

Name: Allows you to enter a new name for this camera.

FLIR™ Menu: Provides access to the settings for the camera.

Associating the Camera to a Video Source

You may need to associate the camera with a video source.

- 1 From the video screen, select **Menu > Source**.
- 2 Select the camera.
- 3 Select **Video Setup > Set Input**.
- 4 Select the video input.

Video Camera Movement Control

NOTICE

Do not aim the camera at the sun or extremely bright objects. Damage to the lens may occur.

Always use the chartplotter controls or buttons to pan and tilt the camera. Do not manually move the camera unit. Manually moving the camera may damage the camera.

NOTE: This feature is available only when a compatible camera is connected. You may need to update the camera software to use this feature.

You can control the movements of the connected video cameras that support panning, tilting, and zooming.

Controlling Video Cameras Using On-Screen Controls

On-screen controls allow you to control pan-tilt-zoom (PTZ) cameras. Refer to the camera manual for a list of available features.

- 1 From a video screen, touch the screen.
The video controls appear on the screen.

- 2 Select an option:

- To zoom in and out, use the zoom button.
- To pan or tilt the camera, use the compass rose.

TIP: Hold in the compass rose to continue to move the camera in the desired direction.

Controlling a Video Camera Using Gestures

When a networked video camera supports gesture responses, you can control pan-tilt-zoom cameras using gestures directly on the chartplotter screen. Check your camera user manual for a list of available features.

TIP: Using gestures allows video control without displaying the video controls.

- 1 From a video screen, touch the screen.

- 2 Select an option:

- To zoom in and out with the camera, use pinch and zoom gestures.
- To pan or tilt the camera, swipe the screen in the desired direction.

Creating a Combination with Video Functions

You can include up to four video functions in a custom combination screen.

If your device has multiple built-in video connections, you can use one built-in source for one function within each combination.

NOTE: The video source displays all connected, supported video devices. You can select **Show All** to see a list of all possible video inputs or video encoder channels that are not connected to a video input source.

- 1 Select **Combos > Menu > Add Combo**.
- 2 Select **Functions**, and select a number.
- 3 Select an area to assign a function to, select **Video**, and select a video source.
- 4 Repeat step 3 for all video functions in the combination screen.
- 5 If necessary, customize the combination screen ([Adding a Custom Combination Screen](#)).

Configuring the Video Appearance

NOTE: Not all options are available on all camera models and chartplotter models.

- 1 From the video screen, select **Menu > Video Setup**.

2 Select an option:

- To show the video using a stretched aspect ratio, select **Aspect > Stretch**. The video cannot be stretched beyond the dimensions provided by the connected video device, and it may not fill the entire screen.
- To show the video using a standard aspect ratio, select **Aspect > Standard**.
- To adjust the brightness, select **Brightness**, and select **Up, Down, or Auto**.
- To adjust the color saturation, select **Saturation**, and select **Up, Down, or Auto**.
- To adjust the contrast, select **Contrast**, and select **Up, Down, or Auto**.
- To allow the chartplotter to automatically select the source format, select **Standard > Auto**.

Configuring the PC Display

Before you can configure the PC display mode, you must set the video source to analog or digital PC.

1 When in PC display mode, select anywhere on the screen.

2 Select an option:

- To adjust the screen brightness, select the brightness arrows.
- To adjust the screen contrast, select the contrast arrows.

Exiting PC Display Mode

1 When in PC display mode, select anywhere on the screen.

2 Select the display mode icon in the upper-left corner.

The video source changes to Video 1.

Device Configuration

Turning On the Chartplotter Automatically

You can set the chartplotter to turn on automatically when the power is applied. Otherwise, you must turn on the chartplotter by pressing \odot .

Select **Settings > System > Auto Power Up**.

NOTE: When Auto Power Up is On, and the chartplotter is turned off using \odot , and power is removed and reapplied within less than two minutes, you may need to press \odot to restart the chartplotter.

System Settings

Select **Settings > System**.

Simulator: Turns the simulator on or off and allows you to set the time, date, speed, and simulated location.

Beeper and Display: Adjusts the display and sound settings.

GPS: Provides information about the GPS satellites and settings.

System Information: Provides information about the devices on the network and the software version.

Station Information: Adjusts the setup of the station.

Auto Power Up: Turns the device on automatically when power is applied.

Station Settings

Select **Settings > System > Station Information**.

Change Station: Sets the entire station to a new set of defaults based on the location of this station. You can also select to use this display as a stand-alone, individual display, instead of grouping it with other displays to make a station.

GRID™ Pairing: Allows you to pair a GRID™ remote input device with this station.

Display Order: Sets the order of the displays, which is important when using a GRID remote input device.

Reset Stations: Restores the factory default layouts for all displays in the station.

Viewing System Software Information

You can view the software version, the basemap version, all supplemental map information (if applicable), the software version for an optional Garmin radar (if applicable), and the unit ID number. You may need this information to update the system software or to purchase additional map data information.

Select **Settings > System > System Information**.

Viewing the Event Log

The event log shows a list of system events.

Select **Settings > System > System Information > Event Log**.

Preferences Settings

Select **Settings > Preferences**.

Units: Sets units of measure.

Language: Sets the on-screen text language.

Navigation: Sets navigation preferences.

Keyboard Layout: Arranges the keys on the on-screen keyboard.

Screenshot Capture: Allows the device to save images of the screen.

User Data Sharing: Allows you to share waypoints and routes over the Garmin Marine Network. All chartplotters that share waypoints and routes must have this setting turned on.

Menu Bar Display: Shows or automatically hides the menu bar when it is not needed.

Units Settings

Select **Settings > Preferences > Units**.

System Units: Sets the unit format for the device.

Variance: Sets the magnetic declination, the angle between magnetic north and true north, for your present location.

North Reference: Sets the direction references used in calculating heading information. True sets geographic north as the north reference. Grid sets grid north as the north reference (000°). Magnetic sets the magnetic north as the north reference.

Position Format: Sets the position format in which a given location reading appears. Do not change this setting unless you are using a map or chart that specifies a different position format.

Map Datum: Sets the coordinate system on which the map is structured. Do not change this setting unless you are using a map or chart that specifies a different map datum.

Time: Sets the time format, time zone, and daylight saving time.

Navigation Settings

NOTE: Some settings and options require additional charts or hardware.

Select **Settings > Preferences > Navigation**.

Route Labels: Sets the type of labels shown with route turns on the map.

Turn Transition: Adjusts how the chartplotter transitions to the next turn or leg or the route. You can set the transition to be based on time or distance before the turn. You can increase the time or distance value to help improve the accuracy of the autopilot when navigating a route or an Auto Guidance line with many frequent turns or at higher speeds. For straighter routes or slower speeds, lowering this value can improve autopilot accuracy.

Auto Guidance: Sets the measurements for the Safe Depth, Safe Height, and Shoreline Distance, when you are using some premium maps.

Route Start: Selects a starting point for route navigation.

Auto Guidance Line Configurations

CAUTION

The Safe Depth and Safe Height settings influence how the chartplotter calculates an Auto Guidance line. If an area has an unknown water depth or an unknown obstacle height, the Auto Guidance line is not calculated in that area. If an area at the beginning or the end of an Auto Guidance line is shallower than the safe water depth or lower than the safe obstacle height, the Auto Guidance line is not calculated in that area. On the chart, the course through those areas appears as a gray line. When your boat enters one of those areas, a warning message appears.

NOTE: Auto Guidance is available with premium charts, in some areas.

You can set the parameters the chartplotter uses when calculating an Auto Guidance line.

Safe Depth: Sets the minimum depth (chart depth datum) the chartplotter uses when calculating an Auto Guidance line.

NOTE: The minimum safe depth for the premium charts is 3 feet. If you enter a Safe Depth value of less than 3 feet, the charts only use depths of 3 feet for Auto Guidance route calculations.

Safe Height: Sets the minimum height (chart height datum) of a bridge that your boat can safely travel under.

Shoreline Distance: Sets how close to the shore you want the Auto Guidance line to be placed. The Auto Guidance line may move if you change this setting while navigating. The available values for this setting are relative, not absolute. To ensure that the Auto Guidance line is placed the appropriate distance from shore, you can assess the placement of the Auto Guidance line using one or more familiar destinations that require navigation through a narrow waterway ([Adjusting the Distance from Shore](#)).

Adjusting the Distance from Shore

The Shoreline Distance setting indicates how close to the shore you want the Auto Guidance line to be placed. The Auto Guidance line may move if you change this setting while navigating. The available values for the Shoreline Distance setting are relative, not absolute. To ensure the Auto Guidance line is placed the appropriate distance from shore, you can assess the placement of the Auto Guidance line using one or more familiar destinations that require navigation through a narrow waterway.

- 1 Dock your vessel or drop the anchor.
- 2 Select **Settings > Preferences > Navigation > Auto Guidance > Shoreline Distance > Normal**.
- 3 Select a destination that you have navigated to previously.
- 4 Select **Navigate To > Auto Guidance**.
- 5 Review the placement of the Auto Guidance line, and determine whether the line safely avoids known obstacles and the turns enable efficient travel.
- 6 Select an option:
 - If the placement of the Auto Guidance line is satisfactory, select **Menu > Navigation Options > Stop Navigation**, and proceed to step 10.
 - If the Auto Guidance line is too close to known obstacles, select **Settings > Preferences > Navigation > Auto Guidance > Shoreline Distance > Far**.
 - If the turns in the Auto Guidance line are too wide, select **Settings > Preferences > Navigation > Auto Guidance > Shoreline Distance > Near**.

- 7 If you selected **Near** or **Far** in step 6, review the placement of the Auto Guidance line, and determine whether the line safely avoids known obstacles and the turns enable efficient travel.

Auto Guidance maintains a wide clearance from obstacles in open water, even if you set the Shoreline Distance setting to Near or Nearest. As a result, the chartplotter may not reposition the Auto Guidance line, unless the destination selected requires navigation through a narrow waterway.

- 8 Select an option:
 - If the placement of the Auto Guidance line is satisfactory, select **Menu > Navigation Options > Stop Navigation**, and proceed to step 10.
 - If the Auto Guidance line is too close to known obstacles, select **Settings > Preferences > Navigation > Auto Guidance > Shoreline Distance > Farthest**.
 - If the turns in the Auto Guidance line are too wide, select **Settings > Preferences > Navigation > Auto Guidance > Shoreline Distance > Nearest**.
- 9 If you selected **Nearest** or **Farthest** in step 8, review the placement of the **Auto Guidance** line, and determine whether the line safely avoids known obstacles and the turns enable efficient travel.

Auto Guidance maintains a wide clearance from obstacles in open water, even if you set the Shoreline Distance setting to Near or Nearest. As a result, the chartplotter may not reposition the Auto Guidance line, unless the destination selected requires navigation through a narrow waterway.
- 10 Repeat steps 3 through 9 at least once more, using a different destination each time, until you are familiar with the functionality of the Shoreline Distance setting.

Communications Settings

NMEA 0183 Settings

Select **Settings > Communications > NMEA 0183 Setup**.

Port Types: See [Setting the Communication Format for Each NMEA 0183 Port](#).

Output Sentences: See [Configuring NMEA 0183 Output Sentences](#).

Position Precision: Adjusts the number of digits to the right of the decimal point for transmission of NMEA output.

XTE Precision: Adjusts the number of digits to the right of the decimal point for NMEA crosstalk error output.

Waypoint IDs: Sets the device to transmit waypoint names or numbers via NMEA 0183 while navigating. Using numbers may resolve compatibility issues with older NMEA 0183 autopilots.

Defaults: Restores the NMEA 0183 settings to the original factory defaults.

Diagnostics: Displays NMEA 0183 diagnostic information.

Configuring NMEA 0183 Output Sentences

You can enable and disable NMEA 0183 output sentences.

- 1 Select **Settings > Communications > NMEA 0183 Setup > Output Sentences**.
- 2 Select an option.
- 3 Select one or more NMEA 0183 output sentences, and select **Back**.
- 4 Repeat steps 2 and 3 to enable or disable additional output sentences.

Setting the Communication Format for Each NMEA 0183 Port

You can configure the communication format for each internal NMEA 0183 port when connecting your chartplotter to external NMEA 0183 devices, a computer, or other Garmin devices.

- 1 Select **Settings > Communications > NMEA 0183 Setup > Port Types**.
- 2 Select an input or output port.
- 3 Select a format:
 - To support the input or output of standard NMEA 0183 data, DSC, and sonar NMEA input support for the DPT, MTW, and VHW sentences, select **NMEA Std.**
 - To support the input or output of standard NMEA 0183 data for most AIS receivers, select **NMEA High Speed**.
 - To support the input or output of Garmin proprietary data for interfacing with Garmin software, select **Garmin**.
- 4 Repeat steps 2–3 to configure additional input or output ports.

NMEA 2000 Settings

Select **Settings > Communications > NMEA 2000 Setup**.

Device List: Displays the devices connected to the network.

Label Devices: Changes the labels for available connected devices.

Garmin Marine Network

The Garmin Marine Network allows you to share data from Garmin peripheral devices with the chartplotters quickly and easily. You can connect a chartplotter to a Garmin Marine Network to receive data from and share data with other Garmin Marine Network-compatible devices and chartplotters.

Setting Alarms

Navigation Alarms

Select **Settings > Alarms > Navigation**.

Arrival: Sets an alarm to sound when you are within a specified distance or time from a turn or a destination.

Anchor Drag: Sets an alarm to sound when you exceed a specified drift distance while anchored.

Off Course: Sets an alarm to sound when you are off course by a specified distance.

System Alarms

Alarm Clock: Sets an alarm clock.

Unit Voltage: Sets an alarm to sound when the battery reaches a specified low voltage.

GPS Accuracy: Sets an alarm to sound when the GPS location accuracy falls outside the user-defined value.

Setting the Fuel Alarm

Before you can set a fuel level alarm, a compatible fuel flow sensor must be connected to the NMEA 2000 network.

You can set an alarm to sound when the total amount of remaining onboard fuel reaches the level you specify.

- 1 Select **Settings > Alarms > Fuel > Fuel Level Alarm > On**.
- 2 Enter the remaining amount of fuel that triggers the alarm.

Setting Weather Alarms

Before you can set weather alarms, you must have a compatible chartplotter connected to a weather device, such as a GXM device, and have a valid weather subscription.

- 1 Select **Settings > Alarms > Weather**.
- 2 Turn on alarms for specific weather events.

My Vessel Settings

NOTE: Some settings and options require additional charts or hardware.

Select **Settings > My Vessel**.

Keel Offset: Offsets the surface reading for the depth of a keel, making it possible to measure depth from the bottom of the

keel instead of from the transducer location ([Setting the Keel Offset](#)).

Temperature Offset: Compensates for the water temperature reading from a NMEA 0183 water-temperature sensor or a temperature-capable transducer ([Setting the Water Temperature Offset](#)).

Calibrate Water Speed: Calibrates the speed-sensing transducer or sensor ([Calibrating a Water Speed Device](#)).

Fuel Capacity: Sets the combined fuel capacity of all the fuel tanks on your vessel ([Setting the Fuel Capacity of the Vessel](#)).

Vessel Type: Enables some chartplotter features based on the boat type.

Setting the Keel Offset

You can enter a keel offset to compensate the surface reading for the depth of a keel, making it possible to measure depth from the bottom of the keel instead of from the transducer location.

Enter a positive number to offset for a keel. You can enter a negative number to compensate for a large vessel that may draw several feet of water.

- 1 Complete an action, based on the location of the transducer:
 - If the transducer is installed at the water line ①, measure the distance from the transducer location to the keel of the boat. Enter this value in steps 3 and 4 as a positive number.
 - If the transducer is installed at the bottom of the keel ②, measure the distance from the transducer to the water line. Enter this value in steps 3 and 4 as a negative number.

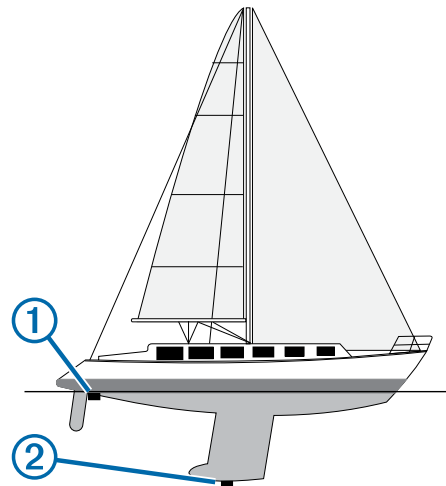

- 2 Select **Settings > My Vessel > Keel Offset**.
- 3 Select **+** or **-** based on the location of the transducer.
- 4 Enter the distance measured in step 1.

Setting the Water Temperature Offset

Before you can set the water temperature offset, you must have a NMEA 0183 water-temperature sensor or a temperature-capable transducer to measure water temperature.

The temperature offset compensates for the temperature reading from a temperature sensor.

- 1 Measure the water temperature using the temperature sensor or temperature-capable transducer that is connected to the chartplotter.
- 2 Measure the water temperature using a different temperature sensor or a thermometer that is known to be accurate.
- 3 Subtract the water temperature measured in step 1 from the water temperature measured in step 2.

This is the temperature offset. Enter this value in step 5 as a positive number if the sensor connected to the chartplotter measures the water temperature as being colder than it actually is. Enter this value in step 5 as a negative number if the sensor connected to the chartplotter measures the water temperature as being warmer than it actually is.

- 4 Select **Settings** > **My Vessel** > **Temperature Offset**.
- 5 Enter the temperature offset calculated in step 3.

Calibrating a Water Speed Device

If you have a speed-sensing transducer connected to the chartplotter, you can calibrate that speed-sensing device to improve the accuracy of water-speed data displayed by the chartplotter.

- 1 Select **Settings** > **My Vessel** > **Calibrate Water Speed**.
- 2 Follow the on-screen instructions.
If the boat is not moving fast enough or the speed sensor is not registering a speed, a message appears.
- 3 Select **OK**, and safely increase the boat speed.
- 4 If the message appears again, stop the boat, and ensure the speed-sensor wheel is not stuck.
- 5 If the wheel turns freely, check the cable connections.
- 6 If you continue to get the message, contact Garmin product support.

Setting the Vessel Type

You can select your boat type to configure the chartplotter settings and to use features customized for your boat type.

- 1 Select **Settings** > **My Vessel** > **Vessel Type**.
- 2 Select **Powerboat** or **Sailboat**.

Other Vessels Settings

When your compatible chartplotter is connected to an AIS device or VHF radio, you can set up how other vessels are displayed on the chartplotter.

Select **Settings** > **Other Vessels**.

AIS: Enables and disables AIS signal reception.

DSC: Enables and disables digital selective calling (DSC).

Collision Alarm: Sets the collision alarm ([Setting the Safe-Zone Collision Alarm](#)).

AIS-EPIRB Test: Enables test signals from Emergency Position Indicating Radio Beacons (EPIRB).

AIS-MOB Test: Enables test signals from man overboard (MOB) devices.

AIS-SART Test: Enables test transmissions from Search and Rescue Transponders (SART).

Restoring the Original Chartplotter Factory Settings

NOTE: This will delete all settings information you have entered.

Select **Settings** > **System** > **System Information** > **Factory Settings** > **Reset**.

Communication with Wireless Devices

The chartplotters can create a wireless network to which you can connect wireless devices.

Connecting wireless devices allows you to use Garmin apps, including BlueChart Mobile and Garmin Helm™. See www.garmin.com for more information.

Setting Up the Wi-Fi® Wireless Network

The chartplotters can create a Wi-Fi network to which you can connect wireless devices. The first time you access the wireless network settings, you are prompted to set up the network.

- 1 Select **Settings** > **Communications** > **Wi-Fi® Network** > **Wi-Fi®** > **On** > **OK**.
- 2 If necessary, enter a name for this wireless network.
- 3 Enter a password.

You will need this password to access the wireless network from a wireless device. The password is case-sensitive.

Connecting a Wireless Device to the Chartplotter

Before you can connect a wireless device to the chartplotter wireless network, you must configure the chartplotter wireless network ([Setting Up the Wi-Fi® Wireless Network](#)).

You can connect multiple wireless devices to the chartplotter to share data.

- 1 From the wireless device, turn on the Wi-Fi technology and search for wireless networks.
- 2 Select the name of your chartplotter wireless network ([Setting Up the Wi-Fi® Wireless Network](#)).
- 3 Enter the network password.

Changing the Wireless Channel

You can change the wireless channel if you have trouble finding or connecting to a device, or if you experience interference.

- 1 Select **Settings** > **Communications** > **Wi-Fi® Network** > **Advanced** > **Channel**.
- 2 Enter a new channel.

You do not need to change the wireless channel of devices connected to this network.

Changing the Wi-Fi Host

You can change which chartplotter is serving as the Wi-Fi host. This can be helpful if you are having trouble with Wi-Fi communications. Changing the Wi-Fi host allows you to select a chartplotter that is physically closer to your mobile device.

- 1 Select **Settings** > **Communications** > **Wi-Fi® Network** > **Advanced** > **Wi-Fi® Host**.
- 2 Follow the on-screen instructions.

Wireless Remote Control

Pairing the Wireless Remote Control With the Chartplotter

Before you can use the wireless remote control with a chartplotter, you must pair the remote with the chartplotter.

You can connect a single remote to multiple plotters, and then press the pairing key to switch between the chartplotters.

- 1 Select **Settings** > **Communications** > **Wireless Devices** > **Wireless Remote**.
- 2 Select **New Connection**.
- 3 Follow the on-screen instructions.

Turning On and Off the Remote Backlight

Turning off the remote backlight can significantly increase the battery life.

- 1 On the chartplotter, select **Settings** > **Communications** > **Wireless Devices** > **Wireless Remote** > **Backlight**.
- 2 Follow the on-screen instructions.

Disconnecting the Remote from All Chartplotters

- 1 On the chartplotter, select **Settings > Communications > Wireless Devices > Wireless Remote > Disconnect All**.
- 2 Follow the on-screen instructions.

Using the Garmin Helm Application with the Chartplotter

Before you can control the chartplotter with the Garmin Helm application, you must download and install the application, and connect the chartplotter to a Wi-Fi router.

- 1 Select **Settings > Communications > Wireless Devices > Helm App**.
- 2 Select an option.
- 3 Use the application to view or control the chartplotter.

Chartplotter Data Management

Copying Waypoints, Routes, and Tracks from HomePort to a Chartplotter

Before you can copy data to the chartplotter, you must have the latest version of the HomePort software program loaded on your computer and a memory card installed in the chartplotter.

Copy the data from HomePort to the prepared memory card.

For more information, see the HomePort help file.

Selecting a File Type for Third-Party Waypoints and Routes

You can import and export waypoints and routes from third-party devices.

- 1 Select **Info > User Data > Data Transfer > File Type**.
- 2 Select **GPX**.

To transfer data with Garmin devices again, select the ADM file type.

Copying Data from a Memory Card

- 1 Insert a memory card into a card slot.
- 2 Select **Info > User Data > Data Transfer**.
- 3 If necessary, select the memory card to copy data to.
- 4 Select an option:
 - To transfer data from the memory card to the chartplotter and combine it with existing user data, select **Merge from Card**.
 - To transfer data from the memory card to the chartplotter and overwrite existing user data, select **Replace from Card**.
- 5 Select the file name.

Copying Waypoints, Routes, and Tracks to a Memory Card

- 1 Insert a memory card into the card slot.
- 2 Select **Info > User Data > Data Transfer > Save to Card**.
- 3 If necessary, select the memory card to copy data to.
- 4 Select an option:
 - To create a new file, select **Add New File**, and enter a name.
 - To add the information to an existing file, select the file from the list.

Copying Built-In Maps to a Memory Card

You can copy maps from the chartplotter to a memory card for use with HomePort.

- 1 Insert a memory card into the card slot.
- 2 Select **Info > User Data > Data Transfer**.
- 3 Select **Copy Built-In Map**.

Backing Up Data to a Computer

- 1 Insert a memory card into the card slot.
- 2 Select **Info > User Data > Data Transfer > Save to Card**.
- 3 Select a file name from the list, or select **Add New File**.
- 4 Select **Save to Card**.
- 5 Remove the memory card, and insert it into a card reader attached to a computer.
- 6 Open the Garmin\UserData folder on the memory card.
- 7 Copy the backup file on the card and paste it to any location on the computer.

Restoring Backup Data to a Chartplotter

- 1 Insert a memory card into a card reader that is attached to the computer.
- 2 Copy a backup file from the computer to the memory card, into a folder named Garmin\UserData.
- 3 Insert a memory card into the card slot.
- 4 Select **Info > User Data > Data Transfer > Replace from Card**.

Saving System Information to a Memory Card

You can save system information to a memory card as a troubleshooting tool. A product support representative may ask you to use this information to retrieve data about the network.

- 1 Insert a memory card into the card slot.
- 2 Select **Settings > System > System Information > Garmin Devices > Save to Card**.
- 3 If necessary, select the memory card to save system information to.
- 4 Remove the memory card.

Appendix

Registering Your Device

Help us better support you by completing our online registration today.

- Go to <http://my.garmin.com>.
- Keep the original sales receipt, or a photocopy, in a safe place.

Digital Switching

Your chartplotter can be used to monitor or control circuits when a compatible system is connected.

For example, you can control the interior lights and navigation lights on the vessel. You can also monitor live well circuits.

To access the digital switching controls, select **Info > Circuit Control**.

For more information about purchasing and configuring a digital switching system, contact your Garmin dealer.

Rotating the GRID Joystick

For certain installation situations, you can rotate the orientation of the GRID joystick.

- 1 Select **Settings > Communications > Marine Network**.
- 2 Select the GRID device.

Cleaning the Screen

NOTICE

Cleaners containing ammonia will harm the anti-reflective coating.

The device is coated with a special anti-reflective coating which is very sensitive to skin oils, waxes, and abrasive cleaners.

- 1 Apply an eyeglass lens cleaner specified as safe for anti-reflective coatings to the cloth.
- 2 Gently wipe the screen with a soft, clean, lint-free cloth.

Screenshots

You can capture a screenshot of any screen shown on your chartplotter as a bitmap (.bmp) file. You can transfer the screenshot to your computer.

Capturing Screenshots

- 1 Insert a memory card into the card slot.
- 2 Select **Settings > Preferences > Screenshot Capture > On**.
- 3 Go to a screen you want to capture.
- 4 Hold **Home** for at least six seconds.

Copying Screenshots to a Computer

- 1 Remove the memory card from the chartplotter, and insert it into a card reader that is attached to a computer.
- 2 From Windows® Explorer, open the Garmin\scrn folder on the memory card.
- 3 Copy a .bmp file from the card and paste it to any location on the computer.

Troubleshooting

My device will not acquire GPS signals

If the device is not acquiring satellite signals, there could be few causes. If the device has moved a large distance since the last time it has acquired satellites or has been turned off for longer than a few weeks or months, the device may not be able to acquire the satellites correctly.

- Ensure the device is using the latest software. If not, update the device software ([Updating the Device Software](#)).
- If the device is using an internal GPS antenna, make sure the device has a clear view of the sky so that the internal antenna can receive the GPS signal. If it is mounted inside of a cabin, it should be close to a window so it can receive the GPS signal. If the device is mounted inside a cabin and cannot be placed in a location where the device can acquire satellites, use an external GPS antenna.
- If the device is using an external GPS antenna, make sure the antenna is connected to the chartplotter or the NMEA network.
- If the device has more than one GPS antenna source, select a different source ([Selecting the GPS Source](#)).

My device will not turn on or keeps turning off

Devices erratically turning off or not turning on could indicate an issue with the power supplied to the device. Check these items to attempt to troubleshoot the cause of the power issue.

- Make sure the power source is generating power.
You can check this several ways. For example, you can check whether other devices powered by the source are functioning.
- Check the fuse in the power cable.
The fuse should be located in a holder that is part of the red wire of the power cable. A 3 Amp fuse is used in this power cable. Check the fuse to make sure there is still a connection

inside of the fuse. You can test the fuse using a multimeter. If the fuse is good, the multimeter reads 0 ohms.

- Check to make sure the device is receiving is at least 10 volts, but 12 volts is recommended.
To check the voltage, measure the female sockets 8 (power) and 2 (ground) of the power cable for DC voltage. If the voltage is less than 10 volts, the device will not turn on.
- If the device is receiving enough power but does not turn on, contact Garmin product support at www.garmin.com/support.

My device is not creating waypoints in the correct location

You can manually enter a waypoint location to transfer and share data from one device to the next. If you have manually entered a waypoint using coordinates, and the location of the point does not appear where the point should be, the map datum and position format of the device may not match the map datum and position format originally used to mark the waypoint.

Position format is the way in which the GPS receiver's position appears on the screen. Commonly displayed as latitude/longitude in degrees and minutes, with options for degrees, minutes and second, degrees only, or one of several grid formats.

Map datum is a math model which depicts a part of the surface of the earth. Latitude and longitude lines on a paper map are referenced to a specific map datum.

- 1 Find out which map datum and position format was used when the original waypoint was created.

If the original waypoint was taken from a map, there should be a legend on the map that lists the map datum and position format used to create that map. Most often this is found near the map key.

- 2 On the chartplotter, select **Settings > Preferences > Units**.
- 3 Select the correct map datum and position format settings.
- 4 Create the waypoint again.

NMEA 0183 Information

Type	Sentence	Description
Transmit	GPAPB	APB: Heading or track controller (autopilot) sentence "B"
	GPBOD	BOD: Bearing (origin to destination)
	GPBWC	BWC: Bearing and distance to waypoint
	GPGGA	GGA: Global positioning system fix data
	GPGLL	GLL: Geographic position (latitude and longitude)
	GPGSA	GSA: GNSS DOP and active satellites
	GPGSV	GSV: GNSS satellites in view
	GPRMB	RMB: Recommended minimum navigation information
	GPRMC	RMC: Recommended minimum specific GNSS data
	GP RTE	RTE: Routes
	GPVTG	VTG: Course over ground and ground speed
	GPWPL	WPL: Waypoint location
	GPXTE	XTE: Cross track error
	PGRME	E: Estimated error
	PGRMM	M: Map datum
	PGRMZ	Z: Altitude
SDDBT	DBT: Depth below transducer	
SDDPT	DPT: Depth	
SDMTW	MTW: Water temperature	
SDVHW	VHW: Water speed and heading	
Receive	DPT	Depth
	DBT	Depth below transducer

Type	Sentence	Description
	MTW	Water temperature
	VHW	Water speed and heading
	WPL	Waypoint location
	DSC	Digital selective calling information
	DSE	Expanded digital selective calling
	HDG	Heading, deviation, and variation
	HDM	Heading, magnetic
	MWD	Wind direction and speed
	MDA	Meteorological composite
	MWV	Wind speed and angle
	VDM	AIS VHF data-link message

NMEA 2000 PGN Information

Type	PGN	Description
Transmit and receive	059392	ISO acknowledgment
	059904	ISO request
	060928	ISO address claim
	126208	NMEA: Command, request, and acknowledge group function
	126464	Transmit and receive PGN list group function
	126996	Product information
	129026	COG and SOG : Rapid update
	129029	GNSS position data
	129540	GNSS satellites in view
	130306	Wind data
	130312	Temperature
	Transmit	127250
127258		Magnetic variance
128259		Speed: Water referenced
128267		Water depth
129025		Position: Rapid update
129283		Cross track error
129284		Navigation data
129285		Navigation route and waypoint info
Receive	126992	System time
	127250	Vessel heading
	127489	Engine parameters: Dynamic
	127488	Engine parameters: Rapid update
	127493	Transmission parameters: Dynamic
	127505	Fluid level
	128259	Speed: water referenced
	128267	Water depth
	129025	Position: rapid update
	129038	AIS class A position report
	129039	AIS class B position report
	129040	AIS class B extended position report
	129539	GNSS DOPs
	129794	AIS class A static and voyage related data
	129809	AIS class B "CS" static data report, part A
	129810	AIS class B "CS" static data report, part B
	130310	Environmental parameters
	130311	Environmental parameters
130313	Humidity	
130314	Actual pressure	

Software License Agreement

BY USING THE DEVICE, YOU AGREE TO BE BOUND BY THE TERMS AND CONDITIONS OF THE FOLLOWING SOFTWARE LICENSE AGREEMENT. PLEASE READ THIS AGREEMENT CAREFULLY.

Garmin Ltd. and its subsidiaries ("Garmin") grant you a limited license to use the software embedded in this device (the "Software") in binary executable form in the normal operation of the product. Title, ownership rights, and intellectual property rights in and to the Software remain in Garmin and/or its third-party providers.

You acknowledge that the Software is the property of Garmin and/or its third-party providers and is protected under the United States of America copyright laws and international copyright treaties. You further acknowledge that the structure, organization, and code of the Software, for which source code is not provided, are valuable trade secrets of Garmin and/or its third-party providers and that the Software in source code form remains a valuable trade secret of Garmin and/or its third-party providers. You agree not to decompile, disassemble, modify, reverse assemble, reverse engineer, or reduce to human readable form the Software or any part thereof or create any derivative works based on the Software. You agree not to export or re-export the Software to any country in violation of the export control laws of the United States of America or the export control laws of any other applicable country.

Index

A

- aerial photos **5**
- AIS **5–7**
 - distress signal device **6**
 - radar **22**
 - SART **6**
 - targeting **5, 6**
 - threats **6, 22**
 - turning on **39**
- alarms **38**
 - anchor drag **38**
 - arrival **38**
 - collision **6, 39**
 - deep water **19**
 - engine **28**
 - gauges **28**
 - navigation **38**
 - off course **38**
 - shallow water **19**
 - sonar **19**
 - water temperature **19**
 - weather **38**
- anchor drag alarm **38**
- animated currents, tides **4**
- antenna, GPS **2**
- arrival alarm **38**
- Auto Guidance **8, 10, 11, 36**
 - line **11, 37**
 - paths **11**
 - shoreline distance **11, 37**
- autopilot **25**
 - adjusting the heading **25**
 - circles pattern **26**
 - cloverleaf pattern **26**
 - engaging **25**
 - orbit pattern **26**
 - pattern steering **26**
 - power saver **25**
 - reducing rudder activity **25**
 - search pattern **26**
 - Shadow Drive **25**
 - steering increment **25**
 - steering patterns **26**
 - u-turn pattern **26**
 - Williamson turn pattern **26**
 - zigzag pattern **26**

B

- backlight **3, 39**
- buoy reports **34**

C

- camera
 - configuration **35**
 - controlling **35**
 - home position **35**
 - pausing **35**
 - standby **35**
- celestial information **29, 30**
- charts **3, 5, 7**
 - appearance **7**
 - built-in **3**
 - details **4**
 - heading, line **7**
 - measuring distance **3**
 - navigation **4, 5**
 - selecting **3**
 - symbols **3**
- circuits **40**
- clock **38**
 - alarm **38**
- collision alarm **6, 39**
- color mode **3**
- combinations, customizing **2, 35**
- compass, rose **7**
- courses **8**

- current stations **29, 30**
- indicators **5**

D

- data
 - backup **40**
 - copying **40**
- data management **40**
- deleting, all user data **13**
- depth log **29**
- destinations
 - navigation chart **8**
 - selecting **8**
- device
 - cleaning **41**
 - registration **40**
- digital selective calling **26, 27**
 - channels **27**
 - contacts **27**
 - individual routine call **27, 28**
 - turning on **26, 39**
- digital switching **40**
- distress call **27**
- distress signal device **6**
- DownVu **15**
- DSC. See digital selective calling

E

- EBL **22**
 - adjusting **22**
 - measuring **22**
 - showing **22**
- engine gauges **28**
 - configuring **28**
 - status alarms **28**
- EPIRB **6**
- event log **36**

F

- factory settings **39**
 - stations **3**
- favorites **2**
- Fish Eye 3D
 - sonar cone **8**
 - suspended targets **8**
 - tracks **8**
- fishing chart **3, 34**
 - boundary line **7**
 - setup **7**
- fuel alarm **28, 38**
- fuel capacity **28, 38**
- fuel gauges **28**
 - status alarm **28, 38**
 - synchronizing with actual fuel **28**
- fuel onboard **38**

G

- Garmin Marine Network **12, 38**
- Garmin product support, contact information **1**
- gauges **28**
 - engine **28**
 - fuel **28**
 - limits **28**
 - status alarms **28**
 - trip **29**
 - wind **28, 29**
- Go To **9**
- GPS **41**
 - signals **2**
 - source **2**
- GPS accuracy **38**
- graphs
 - air temperature **29**
 - atmospheric pressure **29**
 - configuring **29**
 - depth **29**
 - water temperature **29**
 - wind angle **29**
 - wind speed **29**
- GRID **40**
- GRID pairing **36**

- gybing. See tacking and gybing

H

- hazard colors **7**
- heading **25**
 - adjusting **25**
 - heading hold **14**
 - holding **25**
 - Shadow Drive **25**
- helm application **40**
- help. See product support
- home screen **2**
 - customizing **2**

J

- jibing. See tacking and gybing
- joystick **40**

K

- keel offset **13, 38**
- keyboard **36**

L

- lane width **7**
- language **36**
- locking, screen **1**

M

- man overboard **9, 26, 27**
- manual viewer **1**
- marine services **8**
- mark location **9**
- MARPA **6**
 - navigation chart **7**
 - tagged object **22**
 - targeting **22**
 - threats **6, 22**
- measuring distance **16**
 - charts **3**
- media player **30**
 - alphabetical search **30**
 - Android device **30**
 - device name **31**
 - FUSION-Link **30**
 - iPod **30**
 - MTP **30**
 - muting **31**
 - preset **30, 34, 35**
 - radio **30, 31**
 - repeating **30**
 - shuffling **30**
 - SiriusXM Satellite Radio **31**
 - source **30**
 - tuner region **30**
 - tuning mode **30**
 - VHF **31**
 - Windows phone **30**
 - zones **31**
- memory card **40**
 - detailed maps **40**
 - installing **1**
- MOB, device **6**
- music player **30–32**. See media player

N

- navaids **4**
- navigation alarms **38**
- navigation chart **3, 5, 8, 34**
 - aerial photos **7**
 - marine service points **8**
 - MARPA **7**
 - radar overlay **23**
 - setup **7**
 - vessel trails **7, 27**
- networking. See Marine Network
- NMEA 0183 **26, 37**
- NMEA 2000 **26, 38**

O

- off course alarm **38**
- offset, front of boat **25**

other vessels
AIS 7
trails 7

P

Perspective 3D 34
photos, aerial 5
position, tracking 27
position report 27
power key 1, 36
powerboat 3, 13, 39
preferred data source 25
premium charts 4, 5, 7
aerial photos 5
Fish Eye 3D 8
tide and current indicators 4
product registration 40
product support 1
contact information 1

R

radar 20–23
AIS 22
bird mode 23
clutter 24
color scheme 24
custom park position 23
echo trails 24
field of view 24
front-of-boat offset 25
gain 23
MARPA 6
optimizing display 24
overlay screen 23
range 21
range rings 24
sentry mode 21
source 25
timed transmit 21
tracks, Fish Eye 3D 7
transmitting 21
waypoints 7, 21, 24
zoom scale 21
radar overlay 23
radio, SiriusXM 31
range rings 7
registering the device 40
remote control 39
disconnecting 40
resetting
settings 31
station layouts 3
Route To 8
routes
copying 40
creating 9, 10
deleting 10
editing 10
navigating 10
navigating parallel to 10
synchronizing 12
viewing list of 10
waypoints 40

S

safe depth 36
safe height 36
safe-zone collision alarm 6, 39
sailboat 3, 13, 39
sailing 8, 13
race timer 13
starting line 13
sailing gauges 29
sailingstarting line 13
SART 6
satellite imagery 5
satellite signals, acquiring 2
screen
brightness 3
locking 1

screenshots 41
capturing 41
sentry mode 21
guard zone 21
timed transmit 21
settings 36, 38
radar display 24
system information 36
Shadow Drive, enabling 25
shoreline distance 11, 37
SideVü 15
SiriusXM 32
Satellite Radio 31
SiriusXM Satellite Radio 31
software
updates 1
updating 1
software license agreement 42
sonar 14, 16, 20
a-scope 18, 19
alarms 19
appearance 19
bottom lock 17
color gain 17
color rejection 19
cone 8
depth 17
depth scale 17
DownVü 15
frequencies 18
gain 17
interference 19
measuring distances 16
noise 17
Panoptix 15, 16, 18, 19
recording 20
scroll speed 19
sharing 16, 17
SideVü 15
source 16, 17
surface noise 19
suspended targets 19
views 14–16
waypoint 16
whiteline 19
zoom 17
SOS 9, 27
stations 2
changing the station 36
customizing the home screen of 2
ordering the displays 36
restoring the layout 3, 36
suspended targets 8
symbols 5
synchronizing, user data 12
system information 36, 40

T

tacking and gybing 14
heading hold 14
wind hold 14
targeting 22
temperature log 29
tide stations 4, 29, 30
indicators 5
touchscreen 1
tracks 12
clearing 12
copying 40
deleting 12
editing 12
list 12
navigating 12
recording 12
saving 12
saving as route 12
showing 7, 12
transducer 14, 18, 20
trip gauges 29
troubleshooting 41

U

unit ID 36
units of measure 36
updates, software 1
user data
deleting 13
synchronizing 12

V

vessel trails 7, 27
VHF radio 26
calling an AIS target 28
distress calls 27
DSC channel 27
individual routine call 27, 28
video 34–36
configuring 34, 35
source 34, 35
viewing 34, 35
voltage 38
VRM 22
adjusting 22
measuring 22
showing 22

W

warning manager 30
messages 30
water
speed 39
temperature log 29
temperature offset 38
waypoints 9, 41
copying 40
creating 4, 9, 34
deleting 9
editing 9
man overboard 9
navigating to 9
radar 21
showing 7
sonar 16
synchronizing 12
tracked vessel 27
viewing list of 9
weather 34
weather 7, 32
alarms 38
broadcasts 32
charts 32, 34
fishing 33
fishing chart 34
forecast 32–34
navigation chart 34
overlay 34
precipitation 32
sea conditions 33
subscription 32, 34
surface pressure 33
visibility 33, 34
water temperature 33
wave information 33
winds 33
Wi-Fi technology 39
wind angle graph 29
wind gauges 28, 29
wind hold 14
adjusting 14
wind speed graph 29
wireless devices 39
connecting a wireless device 39
network configuration 39

Z

zoom
chart 3
radar 21
sonar 17

www.garmin.com/support



+43 (0) 820 220230



+ 32 2 672 52 54



0800 770 4960



1-866-429-9296



+385 1 5508 272
+385 1 5508 271



+420 221 985466
+420 221 985465



+ 45 4810 5050



+ 358 9 6937 9758



+ 331 55 69 33 99



+ 39 02 36 699699



(+52) 001-855-792-7671



0800 0233937



+47 815 69 555



00800 4412 454
+44 2380 662 915



(+35) 1214 447 460



+386 4 27 92 500



0861 GARMIN (427 646)
+27 (0)11 251 9999



+34 93 275 44 97



+ 46 7744 52020



+886 2 2642-9199 ext 2



0808 238 0000
+44 (0) 870 8501242



+49 (0)180 6 427646
20 ct./Anruf. a. d.
deutschen Festnetz,
Mobilfunk max. 60 ct./Anruf



913-397-8200
1-800-800-1020

(((SiriusXM)))
READY

