

SPECIFICATION CONTROL DRAWING	Revisions			
	Rev	Date	Description	ECO No.
	A	02/10/14	Initial Release	----

Dimensions and drawings for reference only. Drawings are not to scale.

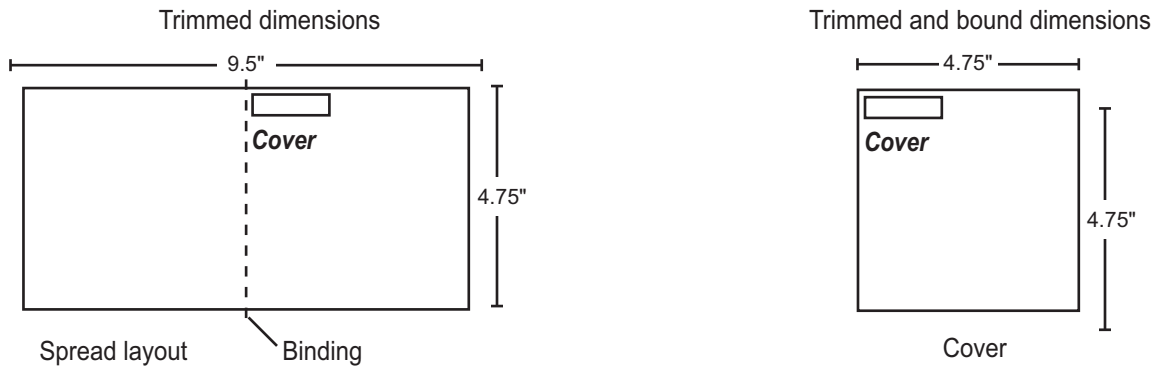

Printing Specifications

1. Tolerance $\pm 0.0787''$ (± 2 mm)
2. Material 120-lb matte-finish offset. Approved Equivalents Allowed.
3. Color 4-color process
4. Bindery Saddle-stitched (72 pages max)
5. Folds N/A
6. Notes This part shall comply with Garmin Banned and Restricted Substances (GPN 001-00211-00).

Content Management System Details

1. GUID GUID-CDF19EFA-ACBB-4F86-BD0F-784A30244955
2. Version 1
3. Language EN-US

Electronic Archive Contents

File Name	File Contents
Pro_Trashbreaker_OM_EN_Spec.indd	InDesign CS4, Document specification sheet
Pro_Trashbreaker_OM_EN.pdf	Portable Document Format, manual for posting online

<small>CONFIDENTIAL</small> This drawing and the specifications contained herein are the property of Garmin Ltd. or its subsidiaries and may not be reproduced or used in whole or part as the basis for manufacture or sale of products without written permission.					Garmin Ltd. or its subsidiaries C/O Garmin International, Inc. 1200 E. 151st Street Olathe, Kansas 66062 U.S.A					
Title		Pro Trashbreaker Owner's Manual (EN-US)								
Drawn By:	MBS	Date	02/10/14	Size	A	Part No	190-01726-00	Rev	A	
Scale				N/A		Sheet		1	Of	21

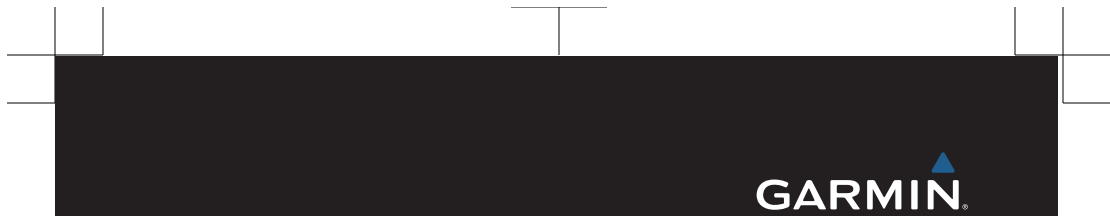

Pro Trashbreaker

Owner's Manual



February 2014

190-01726-00_0A

Printed in Taiwan

Getting Started

WARNING

See the *Important Safety and Product Information* guide in the product box for product warnings and other important information.

Setting Up the Pro Trashbreaker System

Before you can use the Pro Trashbreaker system, you must set up the devices.

- 1 Attach the dog collar device to the collar strap (page 3).
- 2 Charge the handheld device (page 3).
- 3 Charge the dog collar device (page 4).
- 4 Turn on the devices (page 5).
- 5 If necessary, pair the dog collar device with the handheld device (page 5).

Device Overviews

Pro Trashbreaker Handheld Device

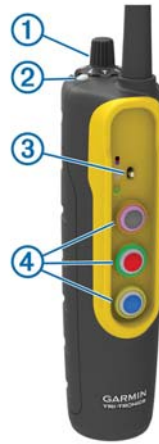

①	Intensity level and training mode dial
②	Battery level
③	Dog collar device toggle switch
④	Training keys

Pro Trashbreaker Dog Device



①	Power key
②	Status LED
③	Lights
④	Contact points
⑤	Charging clip contacts

Attaching the Dog Collar Device to the Collar Strap

- 1 With the buckle ① facing outward, insert the end of the collar strap through the slot ② on the collar device.



- 2 Pull most of the collar strap through the two slots ③ on the dog device.
- 3 Insert the end of the collar strap through the slot ④ on the opposite side of the device.
- 4 Pull the strap until it is tight across the front of the device.
- 5 Wrap the antenna keeper ⑤ around the collar strap.
- 6 **NOTE:** Do not bend the antenna sharply. You should lengthen the collar strap on the side with the antenna keeper to avoid bending the antenna sharply.
Slide the antenna ⑥ through the antenna keeper.

Charging the Handheld Device

You should fully charge the battery before you use the device for the first time. Charging a fully depleted battery takes about 2 hours.

NOTE: The device will not charge when it is outside the temperature range of 32° to 104°F (0° to 40°C).

- 1 Lift the weather cap ①.



Charging the Collar

NOTICE

To prevent corrosion, thoroughly dry the contacts on the collar and the surrounding area before connecting the charging clip.

You should fully charge the battery before you use the device for the first time. Charging a fully depleted battery takes about five hours. The device will not charge when outside the temperature range of 32° to 104°F (0° to 40°C).

- 2 Plug the small end of the power cable into the mini-USB port ② on the device.
- 3 Plug the other end of the power cable into an appropriate power source.
The status LED is solid red when the device is charging.
- 4 After the status LED turns solid green, unplug the power cable from the device.

- 1 Snap the charging clip ① onto the device ②.



- 2 Plug the power cable into a power source.

The status LED is solid red when the collar is charging.

- 3 After the status LED turns solid green, remove the charging clip from the collar.

Turning On the Dog Collar Device

- On the dog collar device, hold the power key until the status LED turns green and the collar beeps to turn it on in training mode.
- On the dog collar device, hold the power key until the status LED turns blue to turn on the BarkLimiter™ feature (page 9).
- On the dog collar device, hold the power key until the status LED turns yellow to enter pairing mode (page 5).

Turning Off the Device

- 1 On the dog collar device, hold the power key until the red LED appears.
- 2 Release the power key.

The dog collar device beeps to confirm powering off.

NOTE: If the device is powered off in BarkLimiter mode, the LED flashes

the number of corrected barks before powering off (page 10).

Dog Collar Device

You can use up to 9 dog collar devices with a single handheld device.

Each dog collar device must be paired with the handheld device before it can be used. During the pairing process, each dog collar device is associated with a different color on the handheld device.

Pairing a Dog Collar Device with the Handheld Device

NOTE: If your handheld device and dog collar device were included in the same package, the devices are paired from the factory.

- 1 On the handheld device, move the toggle switch and select a key to choose the color associated with the dog collar device.
- 2 On the handheld device, set the intensity level to a numbered position (page 9).
- 3 On the dog collar device, hold the power key for about 5 seconds until the status LED changes to yellow.

- 4 On the handheld device, select a training key.

The dog collar device beeps when the devices have paired successfully. If the device does not beep, pairing has not been successful.

TIP: If the devices did not pair successfully, you should verify the batteries in both devices are fully charged and the intensity level is set to a numbered position.

Selecting a Dog Collar Device

Before you can select and control a dog collar device, you must pair the dog collar device with the handheld device (page 5).

Select the color associated with a dog collar device:

- To select the button color, move the dog collar device toggle switch up.
- To select the inner ring color, move the toggle switch to the middle position.
- To select the outer ring color, move the toggle switch down.

The training keys control the dog collar device associated with the selected color.

Dog Training

You should research and investigate the training methods best suited for you, your dog, and your needs.

When used properly, the Pro Trashbreaker training system is an effective training tool to aid your dog in reaching its full potential. The use of the training system should be part of an overall training program.

Fitting the Collar on Your Dog

⚠ CAUTION

To prevent irritation from the contact points, remove the collar for at least eight hours out of every 24-hour period.

This device is not intended for human use. Do not attempt to use on any person.

In order to properly correct the dog, the collar and device must fit the dog properly. If the collar is too loose or positioned incorrectly, corrections may be inconsistent. This can delay or prevent successful training.

- 1 Place the collar around the middle of the dog's neck.
- 2 Position the device at the front of the dog's neck, with the status LED facing toward the dog's chin and the contact points against the throat.
- 3 Tighten the strap so that it is very snug around the dog's neck, and fasten the buckle.

NOTE: The collar should fit tightly and should not be able to rotate or slide on the dog's neck. The dog must be able to swallow food and water normally. You should observe your dog's behavior to verify the collar is not too tight.

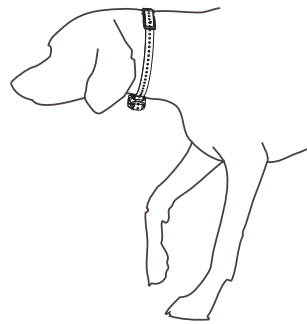

- 4 Wiggle the device to work the contact points through the dog's coat.
NOTE: The contact points must have contact with the dog's skin to be effective.
- 5 If the strap is too long, cut off the excess, leaving at least 3 in. (8 cm) to spare.
- 6 Mark the hole used to fasten the buckle for future reference (optional).

MURS Radio Interference

If your handheld device experiences interference from another transmitter, the

LED flashes yellow when you press a training key.

Selecting and Installing the Contact Points

For best results, select the correct contact points based on your dog's coat.

- 1 Select the correct contact point length for your dog's coat type:
 - For dogs with thicker coats, use the longer contact points.
 - For dogs with shorter coats, use the shorter contact points.
- 2 If necessary, use the included wrench to remove the contact points.
- 3 Twist the contact points into the collar.
- 4 Tighten with the included wrench, but do not overtighten.

When you put the collar on the dog, make sure the contact points are tight against the neck.

Training Intensities and Methods

You can use several methods to train your dog. The Pro Trashbreaker system provides 6 stimulation intensity levels, which increase sequentially from 1 to 6.

Continuous stimulation: Applies stimulation to the dog the entire time you press the training key, for a maximum of 8 seconds. Your stimulations should typically be much shorter than 8 seconds.

Tone: Activates an audible tone instead of stimulation. A tone can be used as either a positive or negative training cue, depending on your training program.

Choosing the Correct Intensity Level

- 1 Set the intensity to the lowest level (page 9).
- 2 Select a training key.
- 3 Observe the dog for a reaction, such as a head shake, neck movement, or just a change in expression.

Sometimes dogs will vocalize due to the surprise of the electrical stimulation. If the dog vocalizes more than once, the intensity level is too high for beginning training.
- 4 If there is no reaction, increase the intensity level by one level until the

dog has a slight but recognizable reaction to the stimulation.

The intensity level that causes a slight but recognizable reaction is your dog's baseline level for beginning collar training. You do not need to, and should not, apply this intensity selection test again.

After you begin training, the dog's performance guides your intensity selection. As the dog advances in training, you may need to change the level depending upon the training situation.

Changing the Intensity Level

You can select a different intensity level for each dog collar device.

- 1 Select a dog collar device (page 6).
- 2 Adjust the intensity dial to increase or decrease the intensity level.

BarkLimiter

When the dog collar device is active and properly fitted on the dog, it detects and corrects barks automatically. The dog collar device starts at the lowest intensity level and increases the intensity level gradually until the dog stops barking.

When the dog is quiet, the intensity decreases over time.

The status LED flashes briefly when the dog collar device detects motion or corrects a bark.

Green, amber, or red flash	Motion was detected, and no correction was applied.
Blue flash	A bark was detected, and a correction was applied.

NOTE: A green, amber, or red flash denotes how much charge is left in the dog device battery, ranging from high to low.

Enabling the BarkLimiter Feature

On the dog collar device, hold the power key until the LED flashes blue.

Bark Odometer™

When you turn off the device, the LED flashes red and green to report the number of times the device detected a bark since it was last turned on. This can help you track your dog's barking behavior.

Red flash	10 barks
Green flash	1 bark

For example, one red flash followed by four green flashes indicates the device detected 14 barks.

Zero flashes indicates the device detected zero barks.

Checking the Bark Odometer

- 1 Remove the device from the dog.
- 2 Position the device so that you can see the status LED.
- 3 Hold the power key until the status LED turns red, and release.
- 4 Count the red and green flashes.

Using the Light

You can use the light feature on your device to verify pairing, help locate your dog, and provide safety for your dog at night.

- 1 Select a dog collar device (page 6).
- 2 Rotate the intensity dial to **L**.
- 3 Select the training key.

Device Information

Pro Trashbreaker Handheld Device Specifications

Battery type	Rechargeable, replaceable lithium-ion
Battery life	60 hours typical use
Operating temperature range	From -4° to 140°F (from -20° to 60°C)
Charging temperature range	From 32° to 104°F (from 0° to 40°C)
Storage temperature range	From -4° to 104°F (from -20° to 40°C)
Water rating	IEC 60529 IPX7*
Wireless range	4 mi. (6.4 km)

*The device withstands incidental exposure to water of up to 1 meter for up to 30 minutes.

Pro Trashbreaker Dog Collar Device Specifications

Battery type	Rechargeable, replaceable lithium-ion
Battery life	40 hours typical use
Operating temperature range	From -4° to 140°F (from -20° to 60°C)
Charging temperature range	From 32° to 104°F (from 0° to 40°C)
Storage temperature range (up to 1 month)	From -4° to 122°F (from -20° to 50°C)
Storage temperature range (up to 3 months)	From -4° to 95°F (from -20° to 35°C)
Water rating	Up to 1 ATM*

*The device withstands pressure equivalent to a depth of 10 meters.

Checking the Battery Level

Turn on the dog collar device (page 5).

The status LED flashes every few seconds while the device is on. The color of the status LED indicates the battery charge level.

Green	The battery has a good charge.
Yellow	The battery should be charged soon.
Red	The battery is very low and should be charged immediately.
Flashing Red	The battery is depleted and must be charged. Training features are disabled.

Replacing the VHF Antenna in the Dog Collar Device

Before you replace the VHF antenna, you must remove all dirt, water, and debris from the device. You also need a small Phillips screwdriver and a larger Phillips screwdriver.

- 1 Remove the three screws ① from the cover over the VHF antenna.



- 2 Pry off the cover.
- 3 Remove the screw ② securing the VHF antenna to the back plate.
- 4 Pull the length of the antenna from the antenna guide to remove the old antenna.
- 5 Loop the antenna guide around the collar strap, and thread the new VHF antenna through the guide.
This helps to point the antenna up.
- 6 Replace the screw securing the VHF antenna to the back plate.
- 7 Replace the cover over the VHF antenna.
- 8 Replace the three screws on the cover.

Pro Trashbreaker Battery Replacement Instructions

⚠ WARNING

This product contains a lithium-ion battery. To prevent the possibility of personal injury or product damage caused by battery exposure to extreme heat, store the device out of direct sunlight.

Do not use a sharp object to remove batteries.

⚠ CAUTION

Contact your local waste disposal department to properly recycle the batteries.

Pro Trashbreaker Handheld Device Components

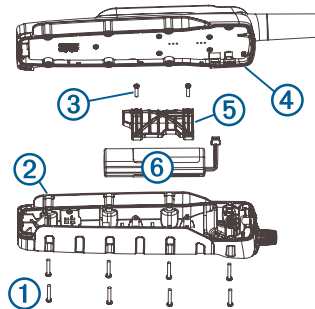

①	Security screws
②	Back plate
③	Battery plate screws
④	Gasket

⑤	Battery plate
⑥	Battery

Replacing the Pro Trashbreaker Handheld Device Battery

Before you replace the battery, you must remove all dirt, water, and debris from the device. You also need a small Phillips screwdriver and the security screwdriver included with the battery replacement kit.

You can purchase a replacement battery at <http://buy.garmin.com>. You should use only an official Garmin® replacement part.

- 1 Remove the eight security screws from the back of the device.
- 2 Lift up the back plate.
- 3 Grip the battery connector wires close to the connector, and pull the connector perpendicular to the circuit board to disconnect the battery connector from the device.
- 4 Grip the rotary switch connector wires close to the connector, and pull the connector perpendicular to the circuit board to disconnect the rotary switch connector from the device.
- 5 Remove the two screws from the battery plate.
- 6 Lift up the battery plate.
- 7 Remove the old battery from the back plate, noting the orientation of the battery.
The battery fits tightly. It may be necessary to pry the battery out of the back plate using a non-sharp, non-metal object.
- 8 Install the new battery into the back plate with the label side up, using the same orientation as the old battery.
The battery orientation is noted graphically inside the back plate.
- 9 Replace the battery plate to its original position.
- 10 Replace and tighten the battery plate screws.
- 11 With the new battery, connect the battery connector to the device.
When properly installed, the connector plug snaps into the port.
- 12 Reconnect the rotary switch connector to the device.

When properly installed, the connector plug snaps into the port.

- 13 Verify the gasket is not damaged and is completely seated in the groove on the front half of the device.
- 14 While ensuring the battery and rotary switch wires are not pinched, hold the back plate and the device firmly together, and replace all eight security screws without tightening.
- 15 Verify the back plate and the device are aligned with no gaps.
- 16 Tighten the screws evenly.
- 17 Verify the gasket is not sticking out of the device.

Pro Trashbreaker Dog Collar Device Components

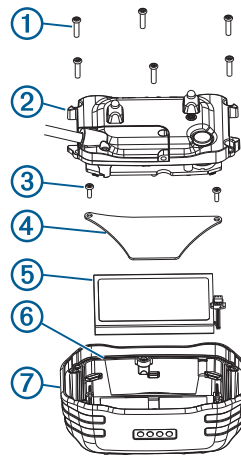

①	Security screws
②	Top plate
③	Battery plate screws
④	Battery plate
⑤	Battery
⑥	Gasket
⑦	Front enclosure

Replacing the Battery Assembly

Before you replace the battery, you must remove all dirt, water, and debris from the device. You also need a small Phillips screwdriver and the security screwdriver included with the battery replacement kit.

You can purchase a replacement battery at <http://buy.garmin.com>. You should use only an official Garmin replacement part.

- 1 Remove the three screws ① from the cover ② over the VHF antenna ③.

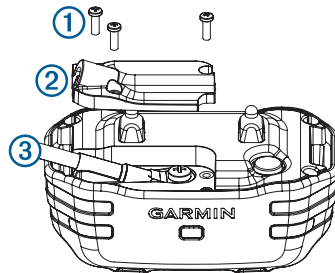

- 2 Pry off the cover.
- 3 Remove the screw securing the VHF antenna to the back plate.
- 4 Remove the six screws from the top plate, and remove the top plate.

- 5 Remove the two screws from the battery plate, and remove the battery plate.
- 6 Grip the battery connector wires close to the connector, and pull the connector perpendicular to the circuit board to disconnect the battery connector from the device.

- 7 Remove the battery.

The battery fits tightly. It may be necessary to pry the battery out of the back plate using a non-sharp, non-metal object.

- 8 Install the new battery into the front enclosure with the label side of the battery facing up, and the lead edge of the battery placed under the contact ledge of the device.
- 9 Replace the battery plate, and replace and tighten the two screws.

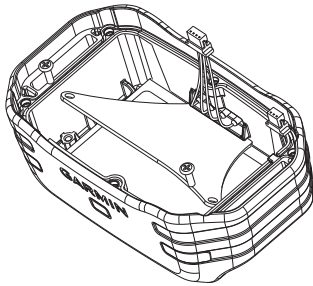

10 Verify the gasket is not damaged and is completely seated in the groove.

11 With the new battery, connect the battery connector to the device.

When properly installed, the connector plug snaps into the port.

12 Replace the front plate, and replace and tighten the six screws to secure the front plate.

13 Replace the screw securing the VHF antenna to the back plate.

14 Replace the cover over the VHF antenna.

15 Replace the three screws on the cover.

16 Verify the gasket is not sticking out of the device.

Getting More Information

You can find more information about this product on the Garmin website.

- Go to www.garmin.com/outdoor.
- Go to www.garmin.com/learningcenter.
- Go to <http://buy.garmin.com>, or contact your Garmin dealer for information about optional accessories and replacement parts.

Registering Your Device

Help us better support you by completing our online registration today.

- Go to <http://my.garmin.com>.
- Keep the original sales receipt, or a photocopy, in a safe place.

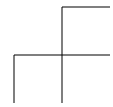
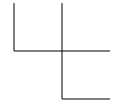
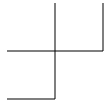

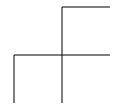
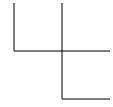
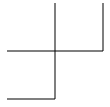

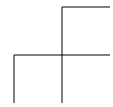
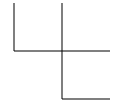
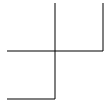

www.garmin.com/support

 913-397-8200 1-800-800-1020	 0808 238 0000 +44 (0) 870 8501242
 1-866-429-9296	 +43 (0) 820 220230
 +32 2 672 52 54	 +385 1 5508 272 +385 1 5508 271
 +420 221 985466 +420 221 985465	 +45 4810 5050
 +358 9 6937 9758	 +331 55 69 33 99
 +39 02 36 699699	 (+52) 001-855-792-7671
 0800 0233937	 +47 815 69 555
 00800 4412 454 +44 2380 662 915	 (+35) 1214 447 460
 +386 4 27 92 500	 0861 GARMIN (427 646) +27 (0)11 251 9999
 +34 93 275 44 97	 +49 (0)180 6 427646 20 ct./Anruf. a. d. deutschen Festnetz, Mobilfunk max. 60 ct./Anruf
 +46 7744 52020	

Garmin International, Inc.
1200 East 151st Street
Olathe, Kansas 66062, USA

Garmin (Europe) Ltd.
Liberty House, Hounsdown Business Park
Southampton, Hampshire, SO40 9LR UK

Garmin Corporation
No. 68, Zhongshu 2nd Road, Xizhi Dist.
New Taipei City, 221, Taiwan (R.O.C.)

All rights reserved. Under the copyright laws, this manual may not be copied, in whole or in part, without the written consent of Garmin®. Garmin® reserves the right to change or improve its products and to make changes in the content of this manual without obligation to notify any person or organization of such changes or improvements.

Garmin® and the Garmin logo are trademarks of Garmin Ltd. or its subsidiaries, registered in the USA and other countries. BarkLimiter™ and Bark Odometer™ are trademarks of Garmin Ltd. or its subsidiaries. These trademarks may not be used without the express permission of Garmin.



Part Information

GPN:	190-01726-00
Description:	Pro Trashbreaker Owner's Manual (EN-US)
Part Type:	Manuals / Printed Literature
Lifecycle Phase:	Production
Rev:	A IR#055352

Item Attribution

Document Review Required:	
Item Notes:	
Preferred Rating:	
ESD Sensitive:	
Moisture Sensitive:	
Limited Shelf Life:	
Magnetic Sensitive:	