

INSTALL GUIDE

ice▶Link Gateway 500 MOST



State of the art car integration for media players, USB and Bluetooth devices

GW5-9210-8



Introduction

Gateway 500 emulates a CD changer and uses CD changer controls to access offboard audio sources including iPod, USB devices and Dension Gateway accessories. If your car is not already equipped with a CD changer, it may be necessary to have the car programmed by your dealer in order to use the GW500 with it.

Programming the car for GW500

Audi

No programming required

BMW non iDrive-4

If original CD changer fitted and MP3 capability is available: no programming is required.

If original CD changer fitted and no MP3 capability is available:

- a) Retrofit "KMP3" option with service computer
- b) Used in non text capable BMW mode

If original CD changer not fitted or E60 M-ASK used: install GW500 and retrofit "IPOD" option with service computer

BMW with iDrive-4

If original CD changer fitted: no programming is required

If original CD changer not fitted: install an original BMW CD changer and retrofit "CD Changer" temporarily option with service computer

Mercedes

Generally no programming is required but in some cases (e.g. no device was connected onto the optical ring) it is needed to enable a CD changer with the service computer.

Porsche

Generally it is needed to enable a CD changer with the service computer but in rare cases the PCM accept the GW500 without this enabling process.

Saab 9-3

It is needed to enable a CD changer with the service computer using an original CD changer.

Package Content & Electrical Installation

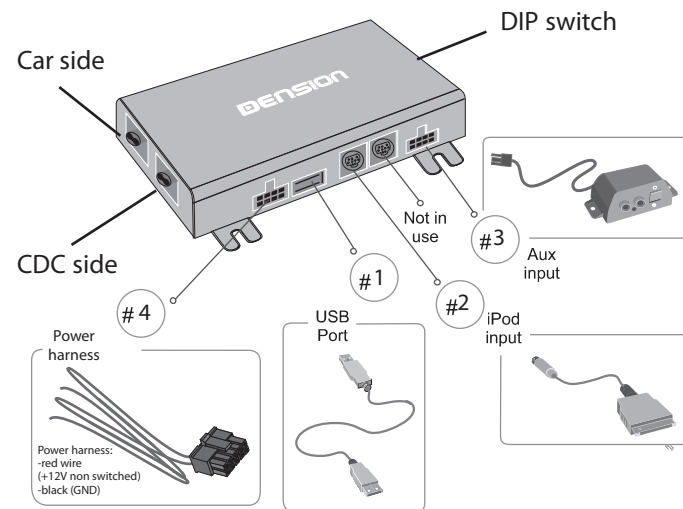

1

Installation Type 1:

Vehicles supporting multiple CD changers and equipped with a CD changer

- Audi A4/S4/RS4/A5/A6/S6/RS6/A8/Q7 with MMI-2 High (colour)

These vehicles allow selection of Gateway audio sources and the original CD changer through the existing car audio controls.

Set the DIP switches to the following position and install the Gateway 500 as illustrated below:

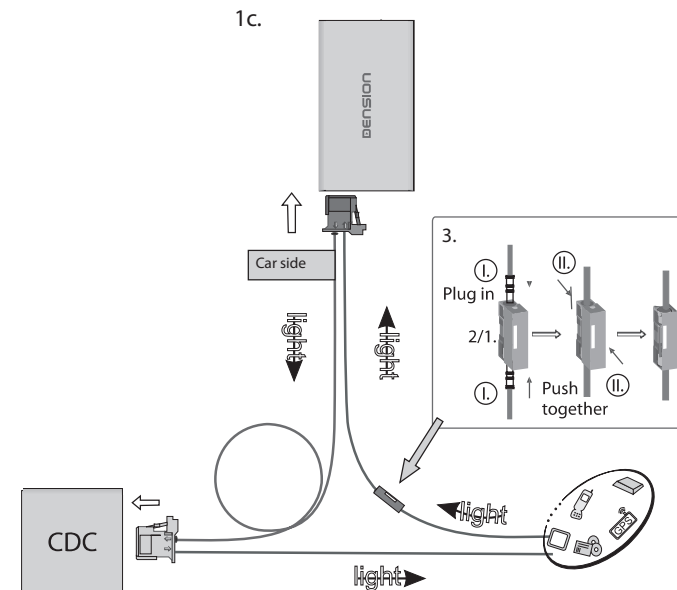
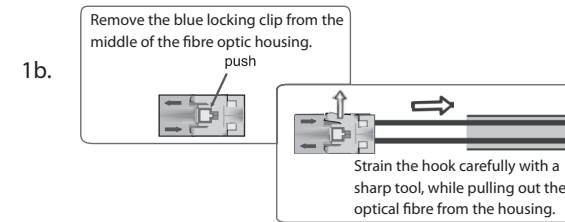
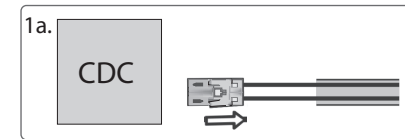
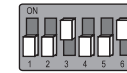

2

Installation Type 2a:

Vehicles with an existing CD changer

These vehicles allow selection of Gateway audio sources and the original CD changer by switching the mode between CD Changer and Gateway mode.

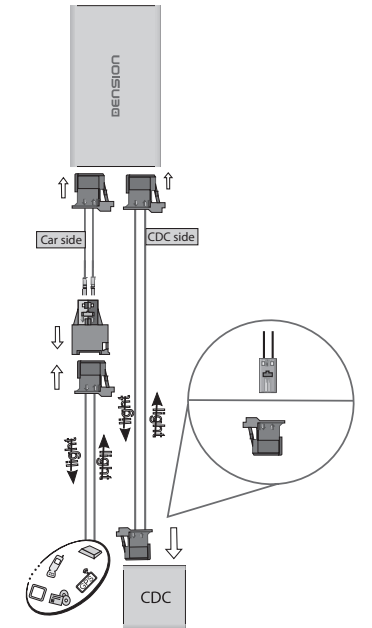

Audi (MMI-2 Basic Monochrome)



Text capable BMW E87, E90, E91, E92, E93, E60/61, E63/E64, E65/E66 (03/2005-), E70 and Mini (non iDrive-4)

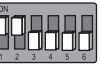

Non text capable BMW E65/E66 (-03/2005) (non iDrive-4)



BMW E90, E91, E92, E93 with iDrive-4

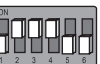

Mercedes (NTG1-, NTG2- Audio 20/50 and Comand)



Porsche (CDR 23/24 and PCM I/II/2.1) for longer CDC and car side cable use FOA1PO1

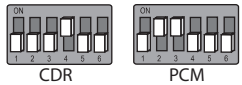

Saab 9-3 (Rear CDC)

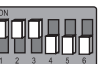

3

Saab 9-3 (Front CDC)

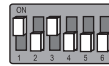

Volvo XC90 - MY 2002-2006, with High Performance and Premium sound system, without AUX input, with CDC

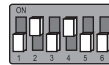

Installation Type 2b:

Volvo S40/V50 - MY 2004-2007 with Basic and High Performance sound system, without AUX input, with CDC

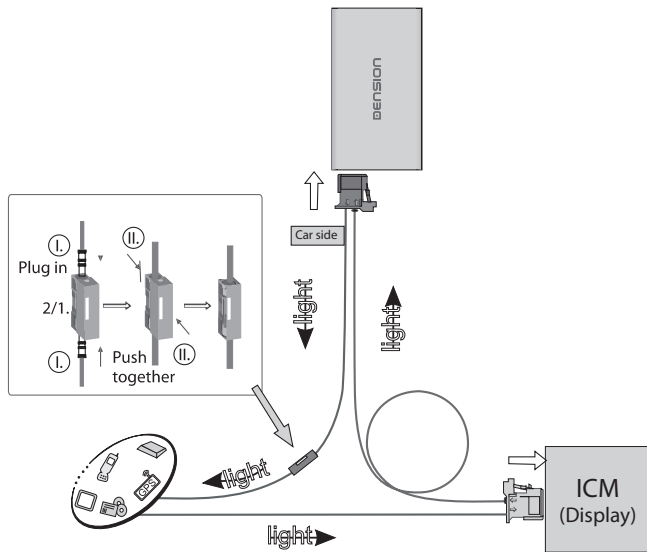
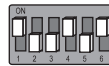

Installation Type 3a:

Vehicles with no existing CD changer

Set the DIP switches as shown below.

Audi (MMI-2 Basic Monochrome)

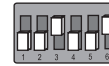

Text capable BMW E87, E90, E91, E92, E93, E60/61, E63/E64, E65/E66 (03/2005-), E70 and Mini (non iDrive-4)

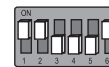

Non text capable BMW E65/E66 (-03/2005) (non iDrive-4)

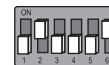

BMW E90, E91, E92, E93 with iDrive-4
Use a CDC for enabling

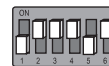

Mercedes (NTG1-, NTG2- Audio 20/50 and Comand)

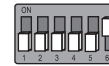

Porsche (CDR 23/24 and PCM I/II/2.1)

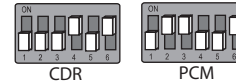

Saab 9-3 (Rear CDC)



Saab 9-3 (Front CDC)



If you are connecting Gateway 500 to the back of the head unit, use this diagram:

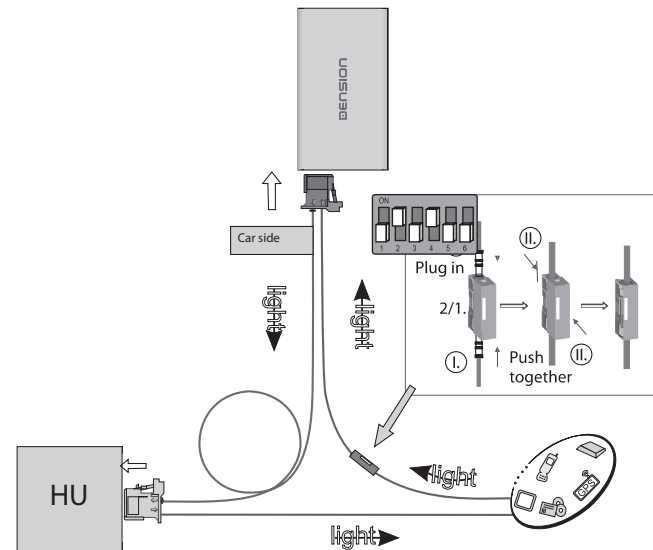

Installation Type 3b:

If you are installing to a free fibre optic connector in the car (CDC preparation) use this method:

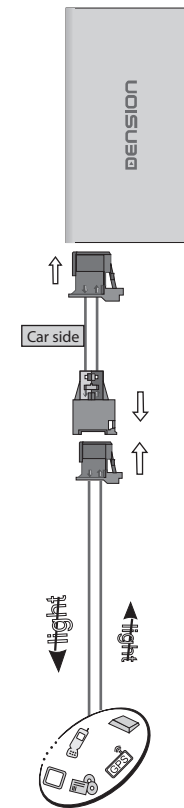

Text Configuration



Saab & Mercedes vehicles require final configuration of the Gateway to not all of the radios in these vehicles support text display. After Gateway 500 has been installed, toggle the mode selector switch six times (three times on/off) and a configuration menu will appear on the radio display. Select the configuration mode according to your head unit listed in the configuration table. To confirm the selection press and hold **▶▶**; to discard the selection press and hold **◀◀**

Track #	Config	Mercedes Command	Saab Text
# 1	NO TEXT	D	D
# 2	Timeout	-	-
# 3	Text	-	-
# 4	+Cache	-	-
# 5	+Paging	R	R
# 6	+Select	-	R

D: Default, R: Recommended

For detailed information visit:
<http://support.dension.com>

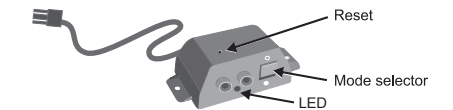

When servicing your vehicle



You must set the mode selector switch to service mode (bypass, CD Changer) position otherwise the service computer may detect an unknown device in the fibre optic system which can lead to errors reported.

