



# Gateway Tablet PC usersguide



Customizing

Troubleshooting





# Contents

<b>1</b>	<b>Checking Out Your Gateway M1300 Tablet PC</b>	<b>1</b>
	Box contents	2
	Button panel	3
	Buttons	4
	Status indicators	5
	Power switch side	6
	Ports side	7
	Speakers side	8
	Back	9
	Identifying your model	11
	Gateway model number and internal wireless label	11
	Gateway serial number	11
	Microsoft Certificate of Authenticity	12
	Finding your specifications	12
	Accessories	13
<b>2</b>	<b>Getting Started</b>	<b>17</b>
	Safety instructions	18
	General tips	18
	Using the battery	19
	Using the AC adapter	19
	Basic safety precautions	20
	Connecting the AC adapter	21
	Protecting from power source problems	24
	Starting your tablet PC	25
	Waking up your tablet PC	26
	Turning off your tablet PC	26
	Restarting (rebooting) your tablet PC	27
	Using the display	28
	Using the pen	28
	Calibration	29
	Gestures	30
	Pen button	30
	Tips	31
	Tablet Input Panel (TIP)	31
	Using the keyboard	33
	Key types	34
	System key combinations	35
	Status indicators	36

Using the touchpad .....	37
Connecting the modem .....	39
Connecting to a wired Ethernet network .....	40
Broadband Internet connections .....	41
Installing a printer, scanner, or other peripheral device .....	41
<b>3 Getting Help .....</b>	<b>43</b>
Using the tutorials .....	44
More helpful startup pages and programs .....	45
Help and Support Center .....	47
Searching for a topic .....	48
Do More with Gateway .....	49
Online help .....	50
Gateway Web site .....	51
Using eSupport .....	52
<b>4 Windows Basics .....</b>	<b>53</b>
About Windows XP Tablet PC Edition .....	54
About the Windows environment .....	55
Using the desktop .....	56
Using the Start menu .....	56
Adding icons to the desktop .....	58
Identifying window items .....	59
Working with files and folders .....	61
Viewing drives .....	61
Creating folders .....	62
Copying and moving files and folders .....	63
Deleting files and folders .....	65
Browsing for files and folders .....	66
Searching for files .....	68
Working with documents .....	71
Creating a new document .....	71
Saving a document .....	72
Opening a document .....	73
Printing a document .....	74
Keyboard shortcuts .....	75
<b>5 Using the Internet .....</b>	<b>77</b>
Learning about the Internet .....	78
Setting up an Internet account .....	79
Using the World Wide Web .....	80
Connecting to a Web site .....	81

Downloading files .....	82
Using e-mail .....	83
Sending e-mail .....	83
Checking your e-mail .....	84
<b>6 Using Multimedia .....</b>	<b>85</b>
Adjusting the volume .....	86
Recording and playing audio .....	89
Playing audio and video files with the Windows Media Player .....	91
Using the optional diskette drive .....	93
Using the optional DVD/CD-RW drive .....	94
Connecting the DVD/CD-RW drive .....	94
Inserting a CD or DVD .....	96
Listening to CDs .....	97
Playing a DVD .....	99
Creating CDs .....	100
Using an external monitor .....	111
Connecting a digital camera .....	112
Connecting a digital video camera .....	114
<b>7 Sending and Receiving Faxes .....</b>	<b>115</b>
Installing Fax .....	116
Configuring Fax .....	117
Sending a simple fax .....	120
Setting up your cover page template .....	121
Faxing from programs .....	122
Faxing a scanned document .....	122
Receiving and viewing a fax .....	123
Canceling a fax .....	123
Automatically retry sending a fax .....	124
Automatically cancelling a fax .....	125
<b>8 Managing Power .....</b>	<b>127</b>
Battery basics .....	128
Monitoring the battery charge .....	128
Recharging the battery .....	130
Changing batteries .....	131
Extending battery life .....	133
Conserving battery power .....	133
Using alternate power sources .....	133
Changing power modes .....	134
Changing power settings .....	135

Changing the power scheme .....	136
Changing alarm options .....	137
Changing advanced settings .....	139
Activating and using Hibernate mode .....	140
<b>9 Travel Tips .....</b>	<b>143</b>
Packing your tablet .....	144
Traveling by air .....	144
Modem .....	144
Radio frequency wireless connections .....	145
Files .....	145
Security .....	146
Power .....	147
Additional tips .....	147
<b>10 Customizing Your Tablet PC .....</b>	<b>149</b>
Using the display .....	150
Changing display orientation .....	150
Adjusting brightness .....	150
Adjusting the screen and desktop settings .....	151
Adjusting the color depth .....	151
Adjusting the screen resolution .....	152
Changing the colors on your Windows desktop .....	154
Changing the desktop background .....	155
Selecting a screen saver .....	157
Adjusting tablet and pen settings .....	158
Programming the buttons .....	159
Using the Motion Dashboard .....	160
Using speech recognition .....	162
Adding and modifying user accounts .....	162
<b>11 Networking Your Tablet PC .....</b>	<b>165</b>
Benefits of networking .....	166
Sharing a single Internet connection .....	166
Sharing drives .....	166
Sharing peripheral devices .....	167
Streaming audio and video files .....	167
Playing multi-player games .....	167
Selecting a network connection .....	168
Wired Ethernet network .....	168
Wireless Ethernet network .....	168
Using a wired Ethernet network .....	169

Ethernet, Fast Ethernet, or Gigabit Ethernet .....	169
Example wired Ethernet network .....	170
Equipment you need for a wired Ethernet network .....	171
Using a wireless Ethernet network .....	172
Example access point wireless Ethernet network .....	173
Equipment you need for an access point wireless Ethernet network .....	174
Example peer-to-peer wireless Ethernet network .....	175
Equipment you need for a peer-to-peer wireless Ethernet network .....	176
For more information .....	176
Using your tablet PC on a network .....	177
Installing and configuring your tablet PC for Ethernet networking .....	177
Turning your wireless Ethernet on or off .....	177
<b>12 Moving from Your Old Computer .....</b>	<b>179</b>
Using the Files and Settings Transfer Wizard .....	180
Transferring files .....	181
Finding your files .....	181
Transferring Internet settings .....	183
Setting up your ISP .....	183
Transferring your e-mail and address book .....	184
Transferring your Internet shortcuts .....	184
Installing your old printer or scanner .....	184
Installing your old programs .....	185
<b>13 Maintaining Your Tablet PC .....</b>	<b>187</b>
General Guidelines .....	188
Display screen .....	188
Pen .....	189
Replacing the pen point .....	189
Caring for your tablet PC .....	189
Creating an emergency startup diskette .....	191
Protecting your tablet PC from viruses .....	193
Managing hard drive space .....	196
Checking hard drive space .....	196
Using Disk Cleanup .....	196
Checking the hard drive for errors .....	198
Defragmenting the hard drive .....	199
Backing up files .....	201
Using the Scheduled Task Wizard .....	201
Cleaning your tablet PC .....	203
Cleaning the exterior .....	203
Cleaning the keyboard .....	203
Cleaning the tablet PC screen .....	204

Cleaning the mouse .....	204
<b>14 Restoring Software .....</b>	<b>207</b>
Using the Restoration CDs .....	208
Reinstalling device drivers .....	209
Updating device drivers .....	211
Reinstalling programs .....	212
Reinstalling Windows .....	214
<b>15 Upgrading Your Tablet PC .....</b>	<b>217</b>
Adding and removing a PC Card .....	218
Preventing static electricity discharge .....	221
Adding or replacing memory .....	222
<b>16 Using the Tablet PC FlexDock .....</b>	<b>227</b>
Front .....	228
Back .....	229
Using the FlexDock .....	231
<b>17 Troubleshooting .....</b>	<b>237</b>
Safety guidelines .....	238
First steps .....	239
Troubleshooting .....	240
Audio .....	240
Battery .....	240
Device installation .....	240
Diskette drive .....	241
Display .....	242
DVD/CD-RW Drive .....	243
Cleaning CDs or DVDs .....	245
File management .....	245
Hard drive .....	245
Internet .....	246
Interface/Ports .....	248
Keyboard .....	248
Memory .....	249
Modem .....	250
Mouse .....	254
Networks .....	254
Operating system .....	255
Passwords .....	255
PC Cards .....	256



Pen .....	256
Power .....	256
Printer .....	258
Sound .....	260
Video .....	260
Wireless Ethernet .....	260
FAQs .....	261
Telephone support .....	263
Before calling Gateway Technical Support .....	263
Telephone numbers .....	264
Tutoring and training .....	265
Self-help .....	265
Tutoring .....	265
Training .....	266
<b>A Safety, Regulatory, and Legal Information .....</b>	<b>267</b>
<b>Index .....</b>	<b>279</b>





# Checking Out Your Gateway M1300 Tablet PC

# 1

This chapter introduces you to the basic features of your tablet PC. Read this chapter to learn:

- How to identify the features of your Gateway tablet PC
- How to locate your tablet PC's model and serial number
- How to locate the Microsoft Certificate of Authenticity
- How to locate the specifications for your tablet PC
- What accessories are available for your tablet PC

## Tips & Tricks



To access the contents of this guide, tap **Start, All Programs**, then tap **Gateway Documentation**. You can also download an electronic copy from [support.gateway.com/support/manlib/](http://support.gateway.com/support/manlib/).



# Box contents

Your Gateway Tablet PC box includes:

- A pen, plus a spare and several replacement tips
- An AC power adapter and installed battery
- A soft cloth for cleaning the screen
- Operating system and software CDs
- An adjustable desktop stand
- A mobile USB keyboard with touchpad
- A hard top cover

Your box also contains any additional accessories you have ordered, such as a combination DVD/CD-RW drive. If you ordered a FlexDock, it will arrive in a separate box.



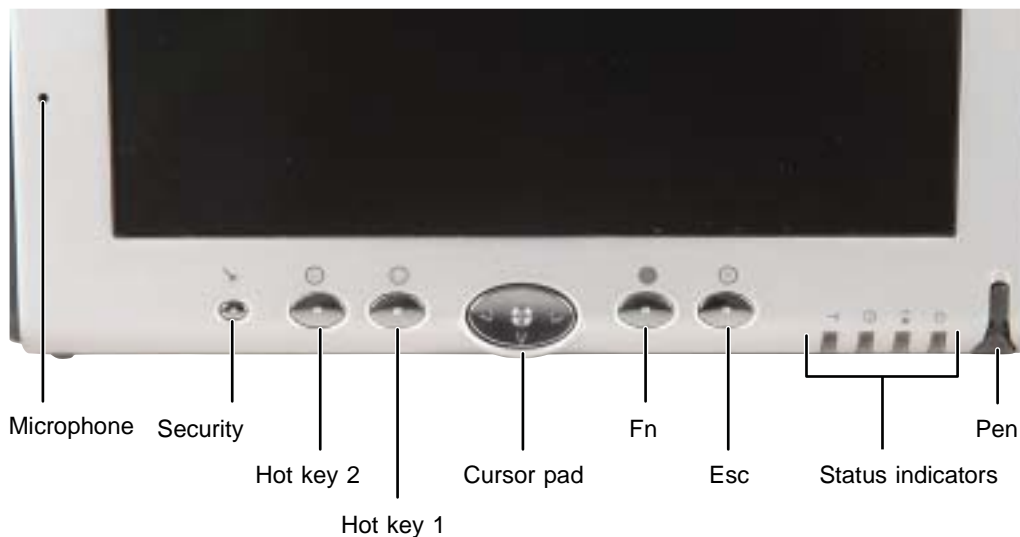

If any of these components appear on the packing slip but not in the box, search the packaging again and check the shipping invoice for information about back orders. If you still are unable to account for the component, contact Gateway.

# Button panel







Component	Description
Microphone	Record audio through this microphone. The built-in microphone is turned off while an external microphone is connected. For the location of your microphone jack, see “Ports side” on page 7.
Buttons	See “Buttons” on page 4 for a description of each button.
Status indicators	See “Status indicators” on page 5 for a description of each status indicator.
Pen	Write, tap, and input directly on the tablet’s display using the cordless pen.

## Buttons

Item	Icon	Primary function	Secondary function (Fn button+button)
Security		Opens the Windows Task Manager. Also used for domain authentication or logon screen.	None
Hot key 2		Rotates display orientation. Also opens the BIOS utility if pressed during startup.	Opens Tablet Input Panel. Can also be reprogrammed.
Hot key 1		Opens Motion Dashboard.	Opens Windows Journal. Can also be reprogrammed.
Cursor pad		<ul style="list-style-type: none"> <li>▪ The edges serve the same function as the arrow keys on a keyboard.</li> <li>▪ The center of the cursor pad is the <b>ENTER</b> key.</li> </ul>	Left arrow: <b>SHIFT+TAB</b> Right arrow: <b>TAB</b> Up arrow: <b>PAGE UP</b> Down arrow: <b>PAGE DOWN</b>
Fn		Press the Fn (Function) button with another button to activate the button's secondary function.	None
Esc		Equivalent to a keyboard's <b>ESC</b> key.	<b>ALT+TAB.</b>

## Status indicators

The status indicators show you the current activity of system components.

Status indicator		Meaning
Wireless activity		<ul style="list-style-type: none"> <li>▪ LED steady or blinking green - Wireless IEEE 802.11b is on</li> <li>▪ LED off - Wireless IEEE 802.11b is off</li> </ul>
Hard drive		<ul style="list-style-type: none"> <li>▪ LED blinking - The hard drive is being read from or written to</li> </ul>
Battery status		<ul style="list-style-type: none"> <li>▪ LED steady green - AC adapter plugged in and battery fully charged</li> <li>▪ LED steady yellow - AC adapter plugged in and battery charging</li> <li>▪ LED steady orange - Battery overheated or defective</li> <li>▪ LED blinking green and orange - Battery discharging abnormally and should be replaced</li> <li>▪ LED slow-blinking orange - AC unplugged and battery less than 10 percent</li> <li>▪ LED fast-blinking orange - AC unplugged and battery less than 5 percent</li> <li>▪ LED off - AC unplugged and battery fully discharged or removed</li> </ul>
Power		<ul style="list-style-type: none"> <li>▪ LED steady green - Tablet is turned on</li> <li>▪ LED blinking green - Tablet is in Standby mode</li> <li>▪ LED off - Tablet is off.</li> </ul>

# Power switch side

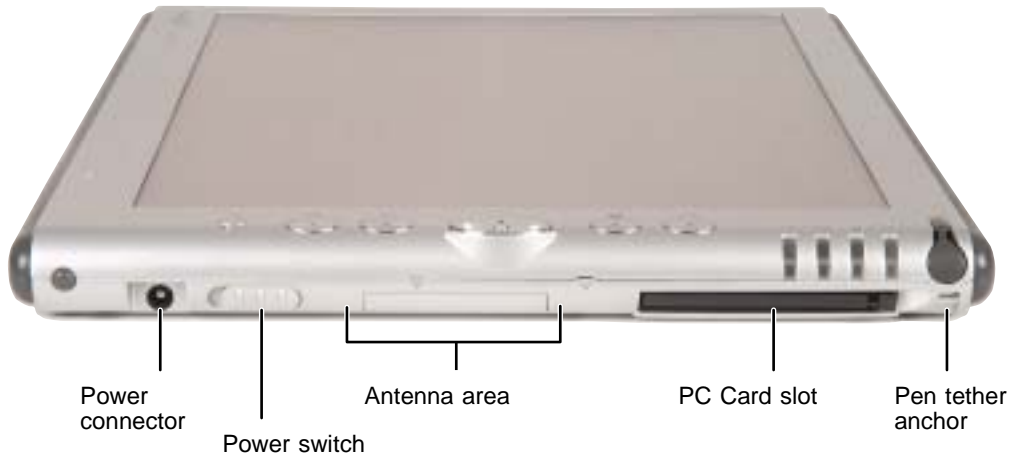







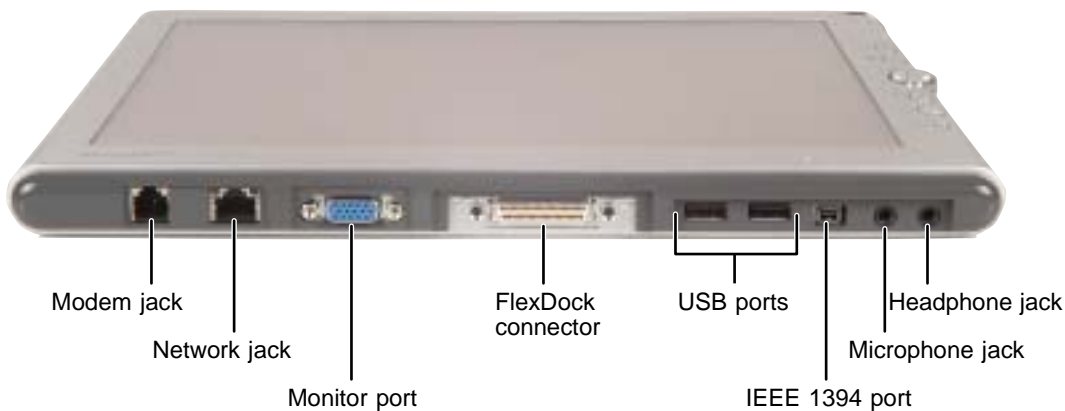

Component	Description
Power connector	Plug the AC adapter cable into this connector. Do not substitute another adapter or use this connector for any other purpose.
Power switch	<ul style="list-style-type: none"><li>Turn on the tablet by sliding and holding the switch for about 1 second.</li><li>When the Gateway Tablet PC is on, slide the switch briefly to activate Standby (or Hibernate if it is enabled through the Control Panel's <i>Power Options Properties</i> dialog box).</li><li>Sliding and holding the switch for more than 4 seconds (when the tablet is turned on) will cause a forced shutdown, which is the last resort when the tablet is completely unresponsive.</li></ul>
Antenna zone	The wireless networking antennas are located in this area. Make sure that you keep your hands clear of this zone when using wireless connectivity in areas where reception is weak.
PC Card slot	Insert one Type II PC Card into this slot. For more information, see "Adding and removing a PC Card" on page 218. A plastic blank ships with the Gateway Tablet PC, and you can leave it in place whenever the slot is not in use.
Pen tether anchor	Use this tether anchor to tether the pen to the tablet. You must purchase the pen tether separately.



# Ports side



Component	Icon	Description
Modem jack		Plug a modem cable into this jack. For more information, see “Connecting the modem” on page 39.
Network jack		Plug a 10/100 Ethernet network cable into this jack. For more information, see “Connecting to a wired Ethernet network” on page 40 and “Networking Your Tablet PC” on page 165.
Monitor port		Plug an analog VGA monitor into this port. For more information, see “Using an external monitor” on page 111.
FlexDock connector		Make sure that the Gateway Tablet PC sits firmly on the docking connector.
USB ports		Plug the port replicator or USB (Universal Serial Bus) devices (such as a diskette drive, lomega™ Zip™ drive, printer, scanner, camera, keyboard, or mouse) into these USB 2.0 ports.
IEEE 1394 port		Plug an IEEE 1394 (also known as Firewire® or i.Link®) device (such as a digital camcorder or DVD/CD-RW drive) into this 4-pin IEEE 1394 port. For more information, see “Connecting a digital video camera” on page 114.

Component	Icon	Description
Microphone jack		Plug an external microphone into this jack. The built-in microphone is turned off when a microphone is plugged into this jack.
Headphone jack		Plug amplified speakers or headphones into this jack. The built-in speakers are turned off when speakers or headphones are plugged into this jack.

## Speakers side

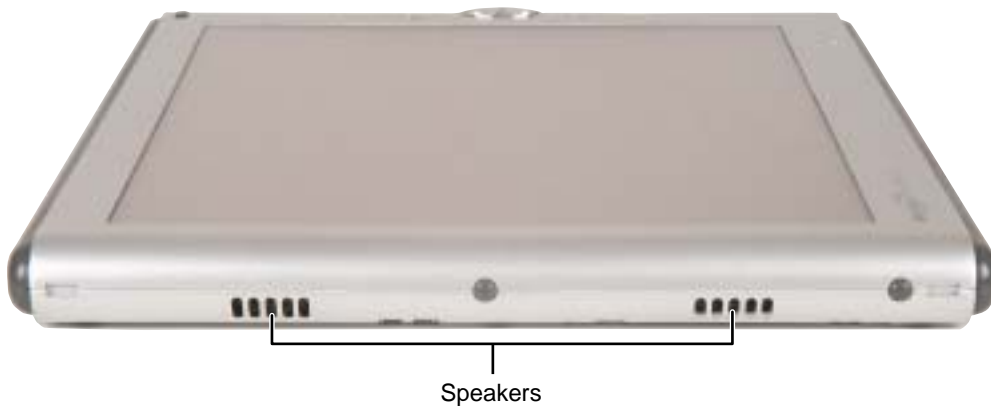

Component	Description
Speakers	Provide audio output when headphones or amplified speakers are not plugged in.

# Back

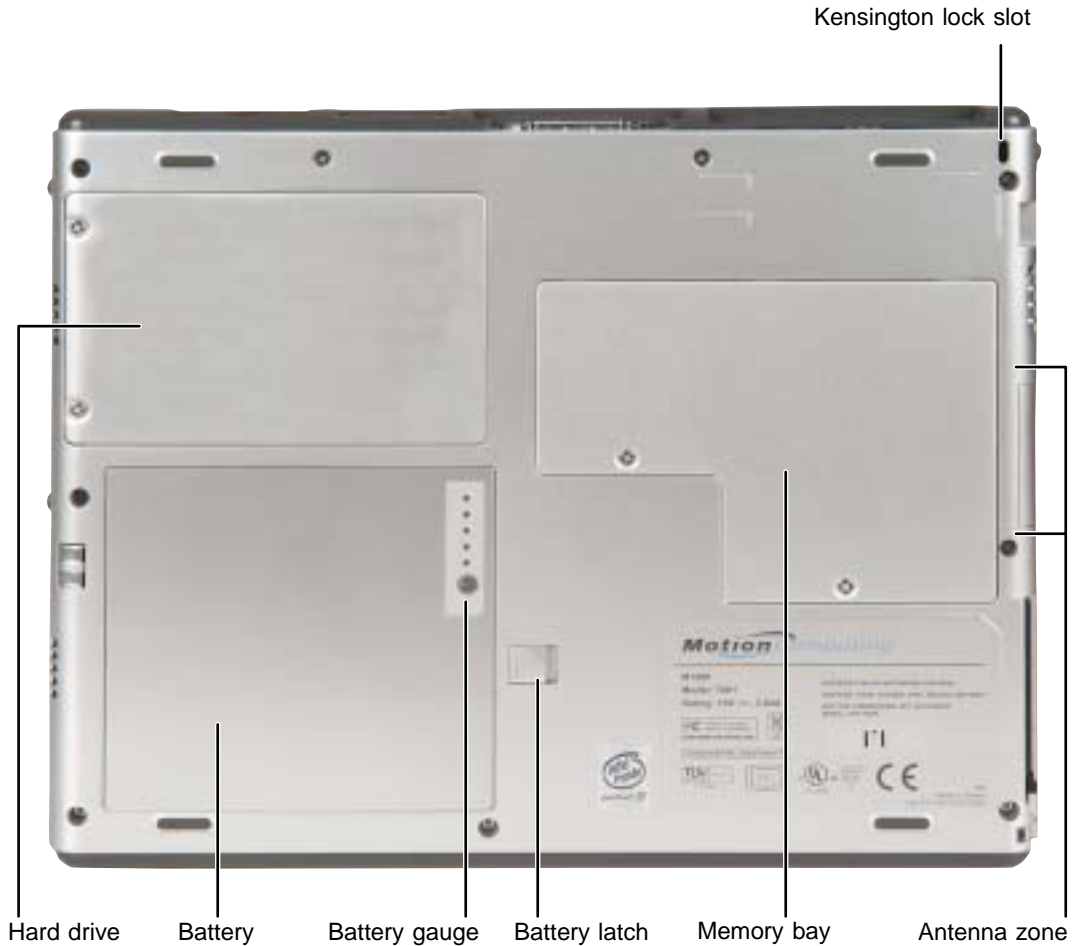

Component	Description
Kensington lock slot	Secure your tablet PC to an object by connecting a Kensington cable lock to this slot.
Hard drive bay	The hard drive is located in this bay.
Battery bay	Insert the battery into this bay. For more information, see “Changing batteries” on page 131.

Component	Description
Battery gauge	Push the button next to the LEDs to check the battery's charge.
Battery latch	Slide to release the battery.
Memory bay	Install as many as two memory modules into this bay. For more information, see "Adding or replacing memory" on page 222.
Antenna zone	The wireless networking antennas are located in this area.

# Identifying your model

## Important



The labels shown in this section are for informational purposes only. Label information varies by model, features ordered, and location.

## Gateway model number and internal wireless label

The label on the back of your tablet PC contains information that identifies your tablet PC model and its features. Gateway Technical Support will need this information if you call for assistance.

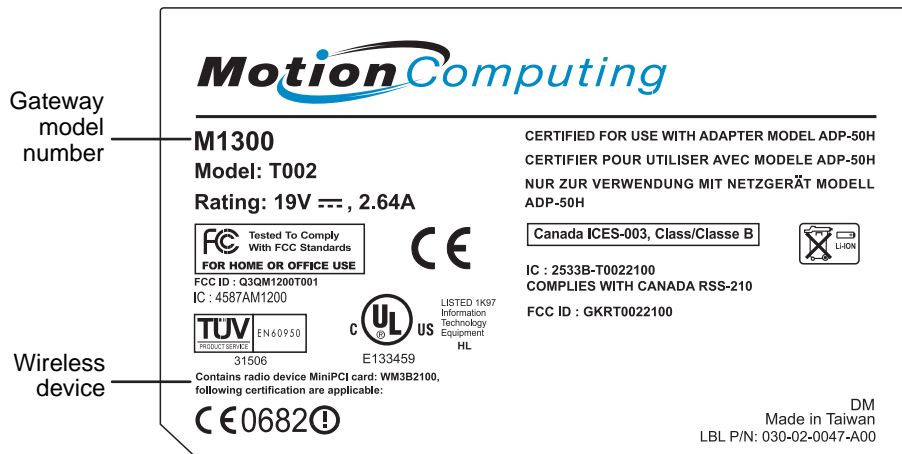

## Gateway serial number

You can locate the Gateway serial number:

- Printed on a white sticker on the back of your tablet PC.
- Printed on the customer invoice that came with your tablet PC. The invoice also contains your customer ID number.

## Microsoft Certificate of Authenticity

The Microsoft Certificate of Authenticity label found on the back of your tablet PC includes the product key code for your operating system.



## Finding your specifications

For more information about your tablet PC, such as memory size, memory type, and hard drive size, visit Gateway's *eSupport* page at [support.gateway.com](http://support.gateway.com). The *eSupport* page also has links to additional Gateway documentation and detailed specifications. For more information, see “Using eSupport” on page 52.



# Accessories

Gateway and Motion offer accessories that can help you make the most of using your tablet PC. To order accessories, visit the Gateway Accessory Store at [accessories.gateway.com](http://accessories.gateway.com) and the Motion Web site at [www.motioncomputing.com](http://www.motioncomputing.com).

## **Batteries and automobile/airplane power adapters**

If you run your tablet PC on battery power for extended periods, you may want to buy an additional battery so you can swap batteries when necessary. See “Changing batteries” on page 131 for more information about using an additional main battery in your tablet PC.

With an automobile/airplane power adapter, you can save battery power by plugging your tablet PC into an automobile cigarette lighter or an airplane in-flight power receptacle.

## **Carrying cases**

Gateway has large-capacity carrying cases if you need additional space for accessories or supplies.

## **Drives**

Use a diskette drive or USB flash drive for storing files or transferring files to another computer. See “Using the optional diskette drive” on page 93.

Use a combination DVD/CD-RW drive for installing programs, playing audio CDs, playing DVDs, accessing data, and recording music and data to CD-R or CD-RW discs. See “Using the optional DVD/CD-RW drive” on page 94 for more information.

## Motion FlexDock



The Motion FlexDock, a desktop docking station, includes most of the tablet's peripheral device connectors.

- LAN (RJ-45)
- IEEE 1394
- USB 2.0 ports (2 rear, 1 front)
- Microphone jack
- Headphone jack
- VGA monitor
- AC power adapter connector

See “Using the Tablet PC FlexDock” on page 227 for more information.



### **Peripheral devices**

You can attach devices (such as a keyboard, mouse, printer, or monitor) to your tablet PC or FlexDock.

### **Memory**

Large programs, such as multimedia games or graphics programs, use a lot of memory. If your programs are running more slowly than you think they should, try adding more memory. See “Adding or replacing memory” on page 222 for more information.

### **Printers**

You can attach almost any type of printer to your tablet PC. The most common types are inkjet and laser printers, which print in color or black and white. See “Installing a printer, scanner, or other peripheral device” on page 41 for more information about attaching a printer to your tablet PC.

Inkjet printers and cartridges are relatively inexpensive, but they are slower than laser printers. Using an inkjet color printer, you can print pictures, banners, and greeting cards, as well as documents.

Laser printers and cartridges are more expensive, but they print much faster than inkjet printers. Laser printers are better than inkjet printers when you are printing large documents.





# 2

## Getting Started

This chapter provides basic information about your Gateway tablet PC. Read this chapter to find out how to:

- Use the tablet PC safely
- Connect the AC adapter
- Start and turn off your tablet PC
- Use the display
- Use the pen
- Use the keyboard
- Identify the keyboard status indicators
- Use the touchpad
- Connect the modem
- Connect to an Ethernet network
- Install peripheral devices



# Safety instructions

Certain precautions should be observed to further reduce the risk of personal injury or damage to the tablet.

## General tips

- When setting up the tablet for work, place it on a level surface.
- Before you clean your tablet, turn it off, unplug it from its power source, and remove the battery.
- Do not push objects into air vents or openings of your tablet. Doing so can cause fire or electric shock by shorting out interior components.
- Handle components with care. Hold a component such as a memory module by its edges, not its pins.
- When you disconnect a cable, pull on its connector, not on the cable itself. As you pull out the connector, keep it evenly aligned to avoid bending any connector pins. Also, before you connect a cable make sure both connectors are correctly oriented and aligned.
- Use of mobile phones can interfere with the sound system. The tablet operation is not impaired but we recommend that a distance of 12 inches (30 cm) be maintained between the tablet and the mobile phone.
- When you move your tablet between environments with very different humidity or temperature ranges, condensation may form on or within the tablet. To avoid damaging the tablet, allow sufficient time for the moisture to evaporate before using the tablet.
- When traveling, do not check the tablet as baggage. You can put your tablet through an X-ray security machine, but never put your tablet through a metal detector. If you have the tablet checked by hand, be sure to have a charged battery available in case you are asked to turn on the tablet.
- When traveling, do not place the tablet in overhead storage compartments where it could slide around.
- Do not drop your tablet or subject it to other physical shocks.
- To completely turn off all tablet power, turn the tablet off, remove the battery, and disconnect the AC adapter from the electrical outlet.

- The base of the tablet can become warm with use. Although the temperature will not be too hot to the touch, we recommend that you attach the hard top cover to the back of the tablet while in use.
- Do not apply heavy pressure to the tablet or subject it to strong impact. Excessive pressure or impact can cause damage to tablet components or otherwise cause malfunctions.
- Some PC Cards can become hot with prolonged use. Overheating of a PC Card can result in errors or instability in the card's operation. Be careful when you remove a PC Card that has been used for extended periods.

## Using the battery

- Do not carry a battery in your pocket, purse, or other container where metal objects (such as car keys) could short-circuit the battery terminals. The resulting excessive current flow can cause extremely high temperatures and may result in heat damage.
- Protect your tablet, battery, and hard drive from environmental hazards such as dirt, dust, food, liquids, temperature extremes, and overexposure to sunlight.
- Replace only with a Gateway Tablet PC battery to avoid risk of fire or explosion.
- Dispose of used batteries according to the manufacturer's instructions. Do not dispose of batteries in a fire. They may explode.

## Using the AC adapter

- Place the adapter in a ventilated area, such as a desktop or on the floor, when you use it to run the tablet or to charge the battery. Do not cover the adapter with papers or other items that will reduce cooling, and do not use the adapter while it is inside a carrying case.
- Make sure that nothing rests on your adapter's power cable and that the cable is not located where it can be tripped over or stepped on.
- Use only the adapter and power cord approved for use with this tablet. Use of another type of adapter may create a risk of fire or explosion.
- If you use an extension cable with your adapter, ensure that the total ampere rating of the products plugged in to the extension cable does not exceed the ampere rating of the extension cable.

## Basic safety precautions

When using your tablet and peripheral devices, basic safety precautions should always be followed to reduce the risk of fire, electric shock, and injury to persons, including the following:

- Do not use this product near water. For example, do not use it near a bathtub or kitchen sink.
- Avoid using the wired modem or LAN during an electrical storm. There may be a remote risk of electric shock from lightning.
- The cable used with the modem should be manufactured with a minimum wire size of 26 American wire gauge (AWG) and an FCC-compliant RJ-11 modular plug.
- To help avoid the potential hazard of electric shock, do not connect or disconnect any cables or perform maintenance or reconfiguration of this product during an electrical storm.

### Warning



When working with peripheral devices or replacing memory modules, always follow installation instructions closely. Except for replacing memory, do not attempt to service the tablet yourself. (See “Using eSupport” on page 52 and “Telephone support” on page 263 for service information.)

# Connecting the AC adapter

Your tablet ships with a charged 6-cell lithium-ion (or an optional lightweight 3-cell) battery in its bay. You can run your tablet PC using an AC adapter or the tablet PC battery. You may own other devices that advise you to charge the battery before first use, but the Gateway Tablet PC battery does not require it. If a charge is needed, just plug in the AC adapter and let the battery charge while you are working.

## Important



- A full charge will take up to two hours. Press the button next to the battery gauge. When all five LEDs glow green, the battery is fully charged. See “Back” on page 9 for the location of the battery gauge.
- Whenever the tablet is connected to AC power and the battery is in place, the tablet will automatically charge the battery until it reaches 100 percent. The Battery Status indicator glows steady yellow while the battery is charging and changes to steady green when charging is complete. See “Status indicators” on page 5 for more information.

▶ **To connect the AC adapter:**

- 1** Connect the power cord to the AC adapter.

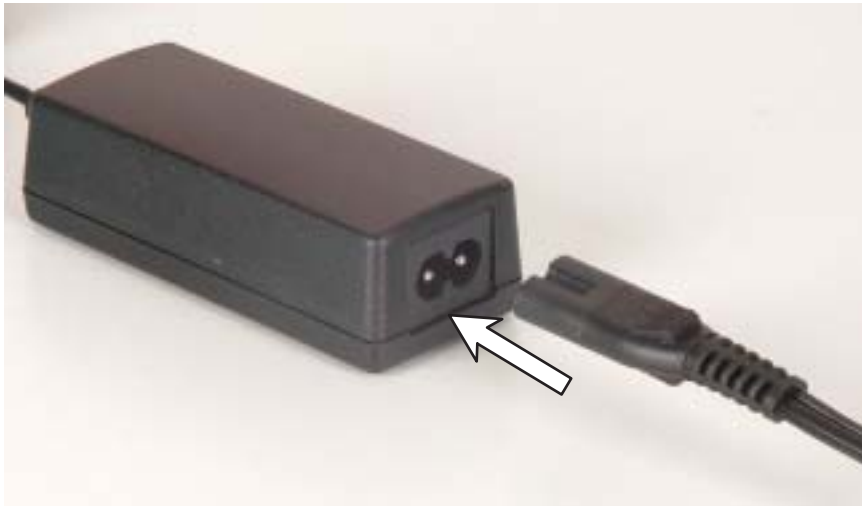

-OR-

Connect the AC mini-plug to the AC adapter.





**Warning**



Make sure that you use the AC adapter that came with your tablet PC.

Replace the power cord if it becomes damaged. The replacement cord must be of the same type and voltage rating as the original cord or your tablet PC may be damaged.

**2** Connect the AC adapter to your tablet PC's power connector.



**3** Plug the power cord or AC mini-plug into a wall outlet.

The battery status indicator turns on (see “Button panel” on page 3 for the location of the battery status indicator). If the battery status indicator does not turn on, unplug the adapter from your tablet PC, then plug it back in.

**4** When you finish using your tablet PC for the first time, turn your tablet PC off and leave your tablet PC connected to AC power for at least 2 hours. For more information about the battery charge meter on your model, see “Monitoring the battery charge” on page 128.

**5** If the battery charge meter does not show a full charge after 4 hours, contact Gateway Technical Support at [support.gateway.com](http://support.gateway.com), then tap **Contact Us**.



**Warning**



Do not attempt to disassemble the AC adapter. The AC adapter has no user-replaceable or user-serviceable parts inside. The AC adapter has dangerous voltages that can cause serious injury or death. Contact Gateway about returning defective AC adapters.



## Protecting from power source problems

During a power surge, the voltage level of electricity coming into your tablet PC can increase to far above normal levels and cause data loss or system damage. Protect your tablet PC and peripheral devices by connecting them to a *surge protector*, which absorbs voltage surges and prevents them from reaching your tablet PC.

**Warning**



High voltages can enter your tablet PC through both the power cord and the modem connection. Protect your tablet PC by using a surge protector. If you have a telephone modem, use a surge protector that has a modem jack. If you have a cable modem, use a surge protector that has an antenna/cable TV jack. During an electrical storm, unplug both the surge protector and the modem.

# Starting your tablet PC

**To start your tablet PC:**

- 1** If this is the first time turning on your tablet, connect the USB keyboard to a USB port.



- 2** Slide and hold the power switch for about 1 second. The tablet turns on.



**Important**



- While the tablet is on, sliding and holding the switch will activate the low-power Standby or Hibernate mode.
- While the tablet is on, sliding and holding the switch for more than four seconds will cause a forced shutdown, which should be the last resort when the tablet is completely unresponsive.

- 3 Use the keyboard to complete the Windows setup. The pen does not work during setup.
- 4 After setup is complete, remove the pen from its packing box, then tap the pen on the screen to control the pointer.



## Waking up your tablet PC

When you have not used your tablet PC for several minutes, it may enter a power-saving mode called *Standby*. While in Standby mode, the power indicator flashes.

If your tablet PC is in Standby mode, “wake” it up by sliding the power switch. For more information on changing power-saving settings, see “Changing power settings” on page 135.

## Turning off your tablet PC



### To turn off your tablet PC:

- 1 Tap **Start**, then tap **Turn Off Computer**. The *Turn Off Computer* dialog box opens.
- 2 Tap **Turn Off**. Windows shuts down and turns off your tablet PC.



**Important**



If for some reason you cannot use the Turn Off Computer option in Windows to turn off your tablet PC, slide and hold the power switch for about four seconds, then release it.

# Restarting (rebooting) your tablet PC

If your tablet PC does not respond to pen or keyboard input, you may have to close programs that are not responding. If closing unresponsive programs does not restore your tablet PC to normal operation, you may have to restart (reboot) your tablet PC.

## To close unresponsive programs and restart your tablet PC:

**1** Press the Security button . For more information, see “Button panel” on page 3.

-OR-

On the keyboard, press **CTRL+ALT+DEL**.

**2** Click **Task Manager**. A window opens that lets you close a program that is not responding.

**3** Tap the program that is not responding.

**4** Tap **End Task**.

**5** If your tablet PC does not respond, turn it off, wait ten seconds and turn it on again.

### Important



If your tablet PC does not turn off immediately, complete the following steps until the tablet PC turns off:

- 1 Slide and hold the power switch for about four seconds, then release it.
- 2 Remove AC power and the battery for more than 10 seconds.

As a part of the regular startup process, a program to check the disk status runs automatically. When the checks are finished, Windows starts.



# Using the display

The tablet's screen combines the eye-soothing readability of a liquid-crystal display with the responsiveness of a pen controller. The screen provides a hard writing surface, minimizes glare, and increases readability.

- Unlike other touchscreens and PDAs, the tablet's display responds only to the tablet's pen. The tablet will not respond to a PDA pen or the touch of a fingertip.
- Steady your hand on the display surface while writing. The pressure of your hand will not affect any open programs.
- Switching from AC to battery power dims the display slightly to save power.

# Using the pen

The tablet PC's pen is the only device that can write, tap, and input directly on the tablet's display.

## Warning



A finger-tap or PDA stylus has no effect on the tablet's display, and ink pens and other pointed objects could damage the surface, so always use the pen that came with your tablet. You can order extra pens from Gateway.

The pen can do everything a mouse does. Just think "tap" instead of "click".

With a mouse:	With a pen:
Point and click	Point and tap
Double-click	Double-tap
Click-and-drag	Tap-and-drag
Right-click	Button-tap (press the pen button while tapping or press and hold with the pen)

## Calibration

The first time you use your tablet, you should calibrate your pen for both portrait and landscape orientations. Calibration ensures the accuracy of the pen and adjusts the screen's performance for different users.

If the on-screen pointer does not seem to line up with the tip of the pen—for example, because someone else has used your tablet and adjusted it for their own use—recalibrate it to your tapping patterns.

Recalibrate if you write with the opposite hand from the previous user—right-handed writer to left-handed writer.



### To open the calibration program:

- Open the Motion Dashboard by pressing the Hot Key 1 , then tapping the **Calibrate** button.

- OR -

Double-tap  (Tablet and Pen Settings) in the taskbar, then tap the **Pen Options** tab.



## Gestures

A gesture is a shape you draw with your tablet pen to send a command to your tablet PC. In Input Panel, you can also use gestures to control the insertion point in the active program. When you use these gestures, you get the same result as pressing the corresponding key on a standard keyboard.

- Open the Tablet Input Panel by waving the pen back and forth over the screen.
- Backspace by drawing a right-to-left line on the display surface.
- In most text input programs, you can erase text by scratching it out. Windows interprets a scratchout as a *delete* command.
- To erase, draw a short, wide “Z.”

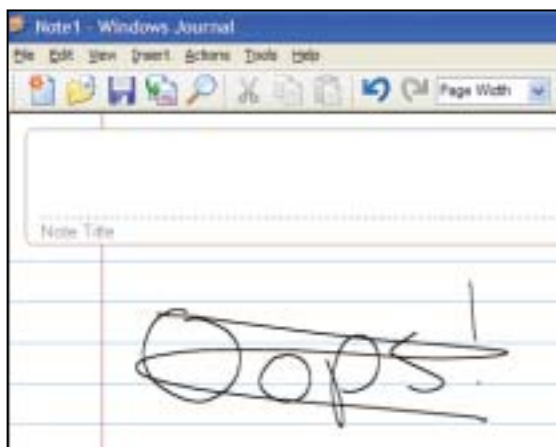

- You will find more information about gestures and gesture symbols, as well as handwriting tips, in the **Help** section of the TIP's **Tools** menu.

## Pen button

The pen button serves the same function as the right button on a mouse. Press it and tap (button-tap) to open right-click menus when they are available.



## Tips

- Hold the pen the same way you hold a writing pen, and steady your writing hand by resting it on the display surface.
- Line up the pointer before you tap, in cases where the pointer and pen point are out of alignment. The screen reads the position of the pointer, not the tap.
- Store the pen in the Gateway Tablet PC's pen holder. Store extra pens in a drawer to avoid prolonged pressure on the pen tip.
- The pen has internal electronics, so keep it dry and avoid contact with liquids.
- The tablet responds to most Penabled™ EMR pens manufactured by Wacom®.

## Tablet Input Panel (TIP)

Tap  (the **Keyboard** icon) near the Start button to open the Tablet Input Panel (TIP). Use the TIP to enter data by hand, soft keyboard, or voice into a word processing program or a text-entry form.

- Access the TIP keyboard and writing pad by tapping the tabs near the bottom of the window.



- To set up speech options, tap **Tools**, then tap **Speech**.

## TIP tips

- Open a program for your input (for example, a word processing program or a Web form) before using the writing pad or soft keyboard.
- To adjust writing pad and keyboard settings, tap **Tools**, then tap **Options**.

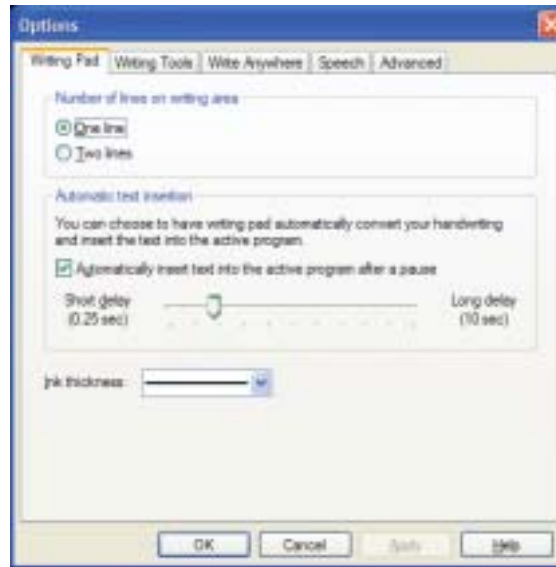

- For security and accuracy when entering masked text (such as passwords), use the Tablet PC Input Panel's soft keyboard instead of the writing pad.



# Using the keyboard

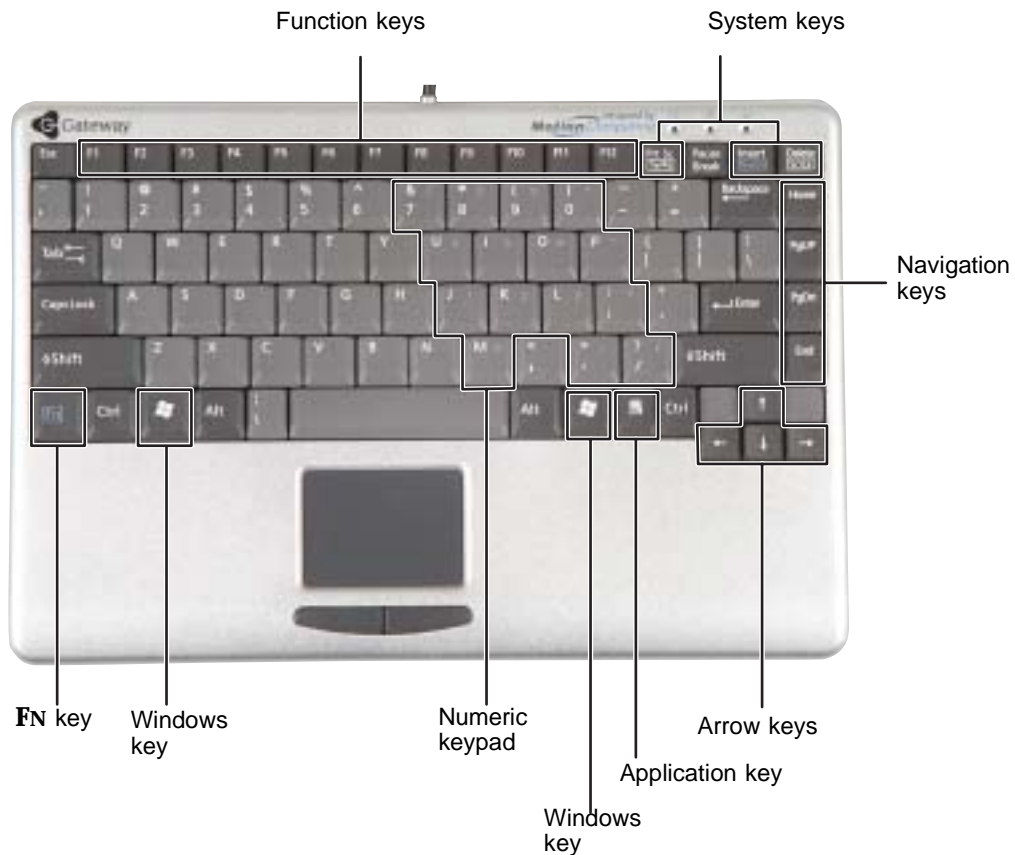

Your tablet PC came with a keyboard that functions the same as a desktop computer keyboard. Many of the keys have been assigned alternate functions, including shortcut keys for Windows, function keys for specific system operations, and the Pad Lock keys for the numeric keypad.

You attach the external keyboard to the tablet PC using a USB port. You do not need to shut down the tablet PC to connect the keyboard.





## Key types

The keyboard has several different types of keys. Some keys perform specific actions when pressed alone and other actions when pressed in combination with another key.

Key type	Icon	Description
Function keys		Press these keys labeled <b>F1</b> to <b>F12</b> to perform actions in programs. For example, pressing <b>F1</b> may open help. Each program uses different function keys for different purposes. See the program documentation to find out more about the function key actions.
System keys		Press these keys in combination with the <b>FN</b> key to perform specific actions.
Navigation keys		Press these keys to move the cursor to the beginning of a line, to the end of a line, up the page, down the page, to the beginning of a document, or to the end of a document.
Arrow keys		Press these keys to move the cursor up, down, right, or left.
Application key		Press this key for quick access to shortcut menus and help assistants in Windows.
Windows keys		Press one of these keys to open the Windows <b>Start</b> menu. This key can also be used in combination with other keys to open utilities like <b>F</b> (Search utility), <b>R</b> (Run utility), and <b>E</b> (Explorer utility).
Numeric keypad		Use these keys to type numbers when the numeric keypad is turned on. Press <b>FN+NUMLK</b> to turn on the numeric keypad.
<b>FN</b> key		Press the <b>FN</b> key in combination with a system key (such as <b>SYSRQ</b> , <b>NUMLK</b> , or <b>SCR LK</b> ) to perform a specific action.

## System key combinations

When you press the **FN** key and a system key at the same time, your tablet PC performs the action identified by the text on the key.

Press and hold <b>FN</b> , then press this system key...	To...
	Perform an action specified by the software currently running. (This function is only available in some programs.)
	Turn on Pad Lock so you can use the numeric keypad. Press this key combination again to turn off Pad Lock. The Pad Lock status indicator appears when this function is turned on.
	Pause the text scrolling in a DOS screen. Press this key combination again to continue scrolling. The Scroll Lock status indicator appears when this function is turned on. (This function is only available in some programs.)

## Status indicators

Status indicators inform you when a button has been pressed that affects how the keyboard is used.

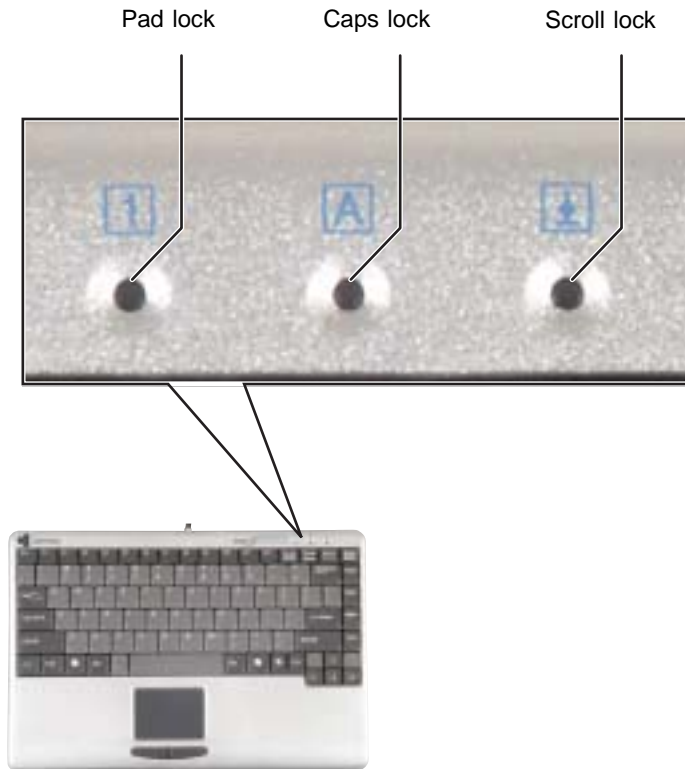

Indicator	Icon	Description
Pad Lock		Numeric keypad is turned on. For more information, see "System key combinations" on page 35.
Caps Lock		Caps Lock is turned on.
Scroll Lock		Scroll Lock is turned on. For more information, see "System key combinations" on page 35.

# Using the touchpad

The keyboard has a touchpad and two buttons.

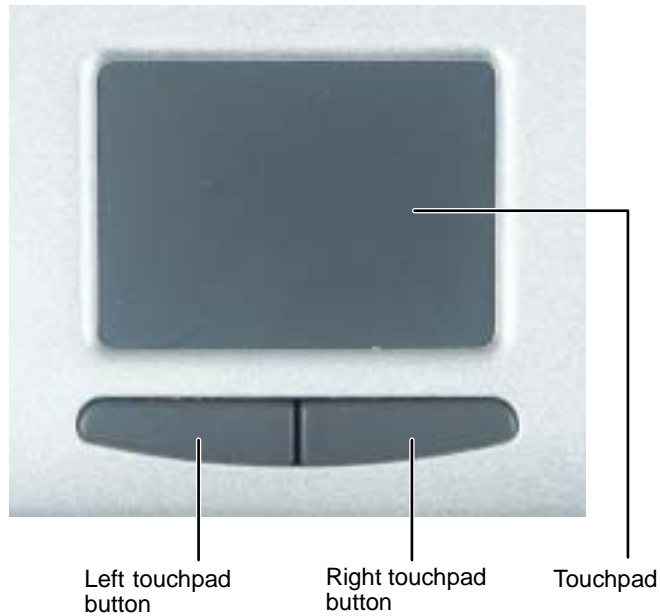

When you move your finger on the touchpad, the *pointer* (arrow) on the screen moves in the same direction.

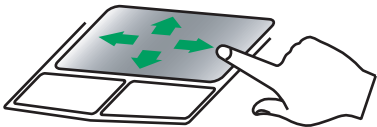
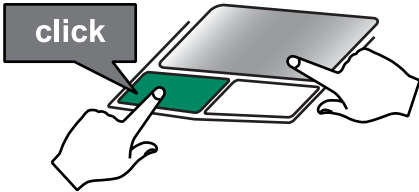
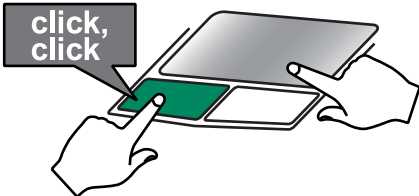
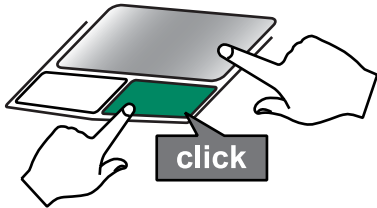
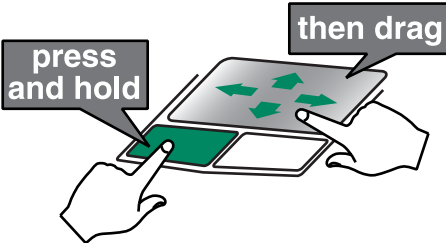

You can use the *left* and *right* buttons below the touchpad to select objects.

To...	Do this...	
Move the pointer on the screen.		Move your finger around on the touchpad. If you run out of space and need to move the pointer farther, lift your finger, move it to the middle of the touchpad, then continue moving your finger.
Select an object on the screen.		Position the pointer over the object. Quickly press and release the left button once. This action is called <i>clicking</i> .
Start a program or open a file or folder.		Position the pointer over the object. Press the left button twice in rapid succession. This action is called <i>double-clicking</i> .
Access a shortcut menu or find more information about an object on the screen.		Position the pointer over the object. Quickly press and release the right button once. This action is called <i>right-clicking</i> .
Move an object on the screen.		Position the pointer over the object. Press the left button and hold it down, then use the touchpad to move (drag) the object to the appropriate part of the screen. Release the button to drop the object where you want it.



# Connecting the modem

Your tablet PC has a built-in 56K modem that you can use to connect to a standard telephone line.

**Warning**

To reduce the risk of fire, use only No. 26 AWG or larger telecommunications line cord.

**To connect the modem:**

- 1 Insert one end of a modem cable into the modem jack  on the ports side of your tablet PC. For the location of the modem jack, see “Ports side” on page 7.



- 2 Insert the other end of the modem cable into a telephone wall jack. The modem will not work with digital or PBX telephone lines.
- 3 Start your tablet PC, then start your communications program.



# Connecting to a wired Ethernet network

Your tablet PC has a network jack that you can use to connect to a 10/100 wired Ethernet network.

## Important



Your tablet PC is equipped with built-in wireless Ethernet. For information about connecting to a wired or wireless Ethernet network, see “Networking Your Tablet PC” on page 165.

## ▶ To connect to a wired Ethernet network:

- 1 Insert one end of a network cable into the network jack  on the ports side of your tablet PC. For the location of the network jack, see “Ports side” on page 7 and “Back” on page 229.



- 2 Insert the other end of the network cable into a network jack. Ask your network administrator to help you select the correct network jack.



## Broadband Internet connections

You can use your tablet PC's Ethernet jack for more than just networking. Many broadband Internet connections, such as cable modems and DSL modems, connect to your tablet PC's Ethernet jack. For more information, see "Using the Internet" on page 77 and "Networking Your Tablet PC" on page 165.

# Installing a printer, scanner, or other peripheral device

### Important



Before you install a printer, scanner, or other peripheral device, see the device documentation and installation instructions.

Your tablet PC and optional FlexDock has one or more of the following ports: IEEE 1394 (also known as Firewire<sup>®</sup> or i.Link<sup>®</sup>) and Universal Serial Bus (USB). You use these ports to connect peripheral devices such as drives, printers, scanners, and digital cameras to your tablet PC. For more information about port locations, see "Checking Out Your Gateway M1300 Tablet PC" on page 1 and "Using the Tablet PC FlexDock" on page 227.

IEEE 1394 and USB ports support *plug-and-play* and *hot swapping*, which means that your tablet PC will usually recognize such a device whenever you plug it into the appropriate port. When you use an IEEE 1394 or USB device for the first time, your tablet PC will prompt you to install any software the device needs. After doing this, you can disconnect and reconnect the device at any time.

### Help and Support



For more information about installing peripheral devices, tap **Start**, then tap **Help and Support**.

Type the keyword **installing devices** in the Help and Support Center **Search** box  , then tap the arrow.





# 3

## Getting Help

This chapter tells you about additional information resources available to help you use your tablet PC. Read this chapter to learn how to access:

- Tutorials
- Help and Support Center
- Do More with Gateway
- Online help
- Gateway Web site



# Using the tutorials

To run the tutorials, tap the **Welcome to Tablet PC** link in the Help and Support Center.



**Help and Support**



To open the Help and Support Center, tap **Start**, then tap **Help and Support**.

## More helpful startup pages and programs

### Get Going with Tablet PC

This interactive introduction offers more hints on using your Tablet PC and helps you calibrate the pen and display. You should calibrate the pen right away.

#### To open **Get Going with Tablet PC**:

- Tap **Start**, **All Programs**, then tap **Get Going with Tablet PC**.



### Take a Tour of Windows XP

#### To open **Take a Tour of Windows XP**:

- 1 Tap **Start**, then tap **Help and Support Center**.
- 2 Tap **What's new in Windows XP**.
- 3 Tap **Taking a tour or tutorial**.
- 4 Tap **Take the Windows XP tour**.



## Inkball

After you finish the tutorials, you can play Inkball to hone your pen skills.



To play Inkball:

- Tap **Start**, **All Programs**, **Games**, then tap **Inkball**.





# Help and Support Center

Your tablet PC includes Windows Help and Support Center, an easily accessible collection of help information, troubleshooters, instructional videos, and automated support. Use Help and Support Center to answer questions about Windows and to help you quickly discover and use the many features of your Gateway Tablet PC.

Whenever you open the Help and Support Center while the Gateway Tablet PC is online, the Did You Know section checks for updates from Microsoft and Motion, such as tablet usage hints, and notices from Motion about your Gateway Tablet PC.

## To start Help and Support

- Tap **Start**, then tap **Help and Support**. The Windows Help and Support Center opens.

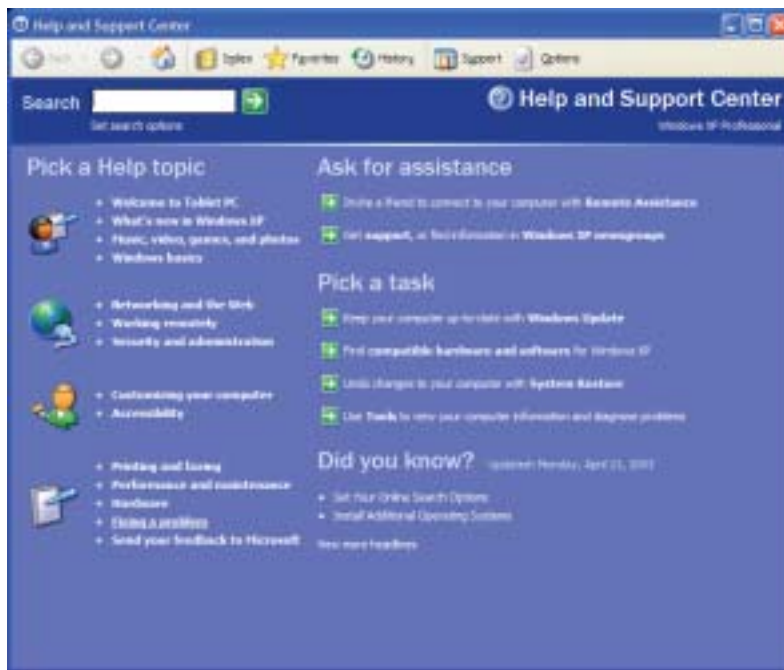

## Searching for a topic

To search for a topic in Help and Support Center, type a word or phrase (keyword) in the **Search** box located at the top of any Help and Support Center screen, then tap the arrow  button.



For each search, you receive the following search result types:

- **Suggested Topics** - These topics are located in Help and Support Center and are relevant to your search topic.
- **Full-text Search Matches** - These topics are located in Help and Support Center and contain the words you entered in the **Search** box.
- **Microsoft Knowledge Base** - These topics are located on the Microsoft Web site and contain the words you entered in the **Search** box. You must be connected to the Internet to search for and access these topics.

To view a list of your search results, tap the results header for the type of results you want to view.

To view a topic, tap the topic name in the **Search Results** list.

# Do More with Gateway

Your tablet PC includes *Do More with Gateway*, a tool that provides additional information about using your Gateway computer for digital music, digital photography, digital video, gaming, and other programs. To access Do More with Gateway, tap **Start**, then tap **Do More with Gateway**. Tap the topics listed on the left-side of the page to learn more about the software already installed on your tablet PC as well as partnerships and special offers available through Gateway.

# Online help

Many programs provide information online so you can research a topic or learn how to perform a task while you are using the program. You can access most online help information by selecting a topic from a **Help** menu or by tapping a **Help** button.



You can search for information by viewing the help contents, checking the index, searching for a topic or keyword, or browsing through the online help.



# Gateway Web site

Gateway's online support is available 24 hours per day, 7 days per week and provides the most current drivers, product specifications, tutorials, and personalized information about your system. Visit the Gateway eSupport Web site at [support.gateway.com](http://support.gateway.com). For more information about connecting to the Internet, see "Using the Internet" on page 77.



## Using eSupport

The eSupport site is divided into four major areas:

- Support Home
- Downloads
- Contact Us
- Account Info

Each of these areas is represented by a tab across the top of the Web page.

### Support Home tab

To get specific information about your tablet PC, type your serial number into the *My System Information* box, then tap **GO**, or tap **Look up my serial number for me**. For more information, see “Finding your specifications” on page 12.

The *Support Information* link lets you access product documentation, specifications, and manuals. By entering your serial number, you get specific documents related to your system. You can also browse through the reference area to locate an article specific to the question you have.

The *Tutorials* link lets you access an extensive library of how-to articles and videos on topics such as making audio CDs and installing memory.

### Downloads tab

The *Downloads* tab provides the latest software updates for BIOS and driver upgrades. By entering your serial number you get drivers specific to your system. Tap **All Downloads** to walk through a step-by-step wizard to locate your drivers.

### Contact Us tab

The *Contact Us* tab contains links to technical support with a live technician, including chat and e-mail. Tap **Call Us** to get a list of Gateway telephone numbers for both sales and support. For more information, see “Telephone numbers” on page 264.

### Account Info tab

The *Account Info* tab contains support for non-technical issues, like the status of your order or changing your account address.



# 4

## Windows Basics

Read this chapter to learn how to:

- Use the Windows desktop
- Manage files and folders
- Work with documents
- Use shortcuts



# About Windows XP Tablet PC Edition

The Microsoft Windows XP Tablet PC Edition operating system is a fully functioning version of Windows XP Professional with added pen-based computing features:

- *Tablet and Pen Settings* — set properties for the pen, tablet buttons, and display screen
- *Tablet PC Input Panel (TIP)* — use its writing pad, soft keyboard, and voice recognition for entering data
- *Windows® Journal* — hand-write documents, then turn them into text or image files
- *Sticky Notes* — make a quick note with your pen or voice and drop it into another program
- *Document annotation* — insert handwritten notes into Word documents and other programs
- *Enhanced speech and voice recognition* — say what you are thinking, and your tablet will understand
- *Inkball* — practice and master pen input with this game of strategy

The **What's New in Windows XP** link in the Help and Support Center and the *Windows XP Start Here* booklet that shipped with your tablet can help you learn more about using Windows XP Tablet PC Edition.



# About the Windows environment

After your tablet PC starts, the first screen you see is the Windows *desktop*. The desktop is like the top of a real desk. Think of the desktop as your personalized work space where you open programs and perform other tasks.

Your desktop may be different from this example, depending on how your tablet PC is set up.

## Help and Support





For more information about the desktop, tap **Start**, then tap **Help and Support**.

Type the keyword **Windows desktop** in the Help and Support Center **Search** box  **Search** , then tap the arrow.



# Using the desktop

The desktop contains the taskbar, the Start button, and the Recycle Bin icon.

Desktop elements	Description
	<p>The <i>taskbar</i> is the bar at the bottom of the tablet PC display containing the Start button on the left and a clock on the right. Other buttons on the taskbar represent programs that are running.</p> <p>Tap a program's <i>button</i> on the taskbar to open the program's window.</p>
	<p>The <i>Start button</i> provides access to programs, files, help for Windows and other programs, and tablet PC tools and utilities.</p> <p>Tap the <b>Start</b> button, then open a file or program by tapping an item on the menu that opens.</p>
	<p>The <i>Recycle Bin</i> is where files, folders, and programs that you discarded are stored. You must empty the Recycle Bin to permanently delete them from your tablet PC. For instructions on how to use the Recycle Bin, see "Deleting files and folders" on page 65.</p>

## Using the Start menu

You can start programs, open files, customize your system, get help, search for files and folders, and more using the Start menu.

### To use the Start menu:

- 1 Tap the **Start** button on the lower left of the Windows desktop. The Start menu opens showing you the first level of menu items.
- 2 Tap **All Programs** to see all programs and files in the Start menu. When you move the pointer over any menu item that has an arrow next to it, another menu, called a *submenu*, opens and reveals related files, programs, or commands.

- 3 Tap a file or program to open it.



### Help and Support



For more information about the Start menu, tap **Start**, then tap **Help and Support**.

Type the keyword **Windows Start menu** in the Help and Support Center **Search** box  , then tap the arrow.

## Adding icons to the desktop

You may want to add an icon (shortcut) to the desktop for a program that you use frequently.



### To add icons to the desktop:

- 1 Tap **Start**, then tap **All Programs**.
- 2 Button-tap (press the pen button) the program that you want to add to the desktop.
- 3 Tap **Send To**, then tap **Desktop (create shortcut)**. A shortcut icon for that program appears on the desktop.



#### Help and Support



For more information about desktop icons, tap **Start**, then tap **Help and Support**.



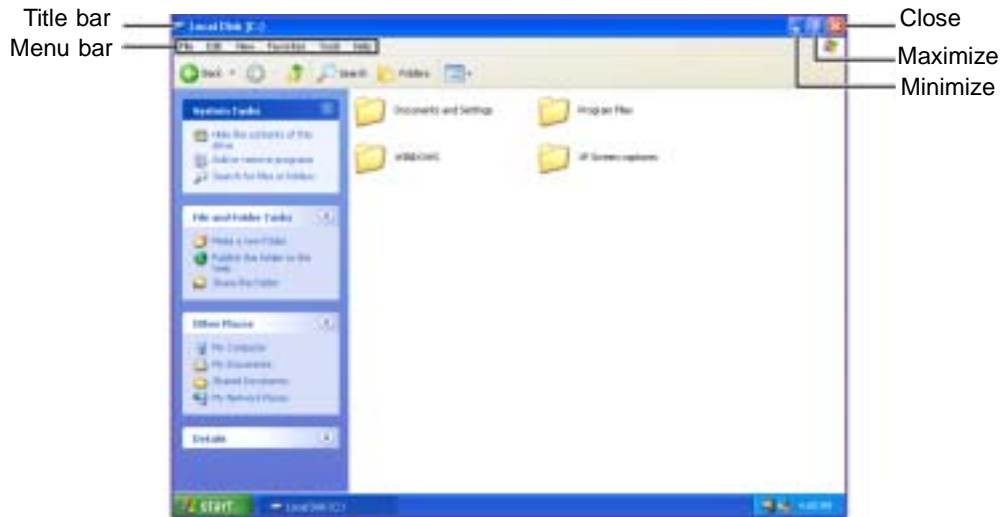

Type the keyword **desktop icons** in the Help and Support Center **Search** box  **Search** , then tap the arrow.

# Identifying window items

When you double-tap the icon for a drive, folder, file, or program, a *window* opens on the desktop. This example shows the Local Disk (C:) window, which opens after you double-tap the **Local Disk (C:)** icon in the *My Computer* window.

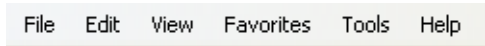

Every program window looks a little different because each has its own menus, icons, and controls. Most windows include these items:

Window item	Description
	The <i>title bar</i> is the horizontal bar at the top of a window that shows the window title.
	Tapping the <i>minimize button</i> reduces the active window to a button on the taskbar. Tapping the program button in the taskbar opens the window again.
	Tapping the <i>maximize button</i> expands the active window to fit the entire tablet PC display. Tapping the maximize button again restores the window to its former size.
	Tapping the <i>close button</i> closes the active window or program.
	Tapping an item on the <i>menu bar</i> starts an action such as Print or Save.

### Help and Support



For more information about windows, tap **Start**, then tap **Help and Support**.

Type the keyword **window** in the Help and Support Center **Search** box  , then tap the arrow.

# Working with files and folders

You can organize your files and programs to suit your preferences much like you would store information in a file cabinet. You can store these files in folders and copy, move, and delete the information just as you would reorganize and throw away information in a file cabinet.

## Viewing drives

*Drives* are like file cabinets because they hold files and folders. A tablet PC may have more than one drive. Each drive has a letter, usually Local Disk (C:) for the hard drive and 3½ Floppy (A:) for the optional diskette drive. You may also have an optional combination DVD/CD-RW drive.

### ▶ To view the drives on your tablet PC:

- Tap **Start**, then tap **My Computer** on the Start menu.

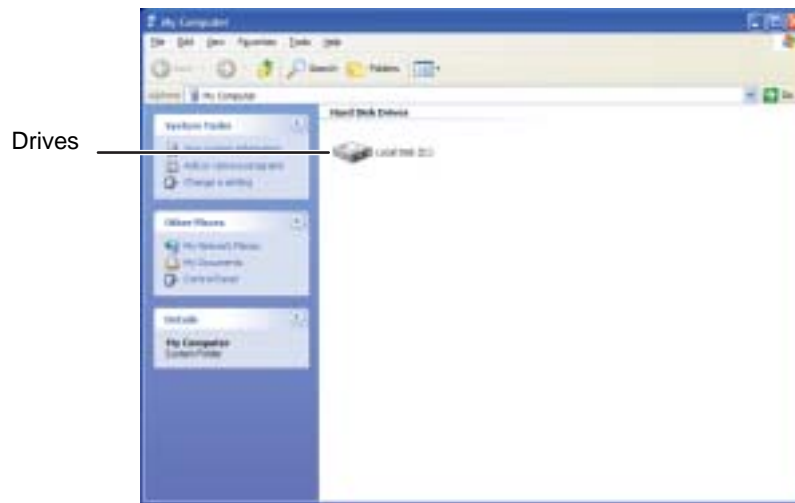

▶ To see the files and folders on a drive:

- Double-tap the drive icon. If you do not see the contents of a drive after you double-tap its icon, tap **Show the contents of this drive**.



**Help and Support**



For more information about files and folders, tap **Start**, then tap **Help and Support**.

Type the keyword **files and folders** in the Help and Support Center **Search** box  Search , then tap the arrow.

## Creating folders

*Folders* are much like the folders in a file cabinet. They can contain files and other folders.

*Files* are much like paper documents—letters, spreadsheets, and pictures—that you keep on your tablet PC. In fact, all information on a tablet PC is stored in files.







### To create a folder:

- 1 Tap **Start**, then tap **My Computer** on the Start menu.
- 2 Double-tap the drive where you want to put the new folder. Typically, Local Disk (C:) is your hard drive and 3½ Floppy (A:) is your optional diskette drive. If you do not see the contents of the drive, tap **Show the contents of this drive**.
- 3 If you want to create a new folder inside an existing folder, double-tap the existing folder. If you do not see the contents of the folder, tap **Show the contents of this drive** or **Show the contents of this folder**.
- 4 Tap **File, New**, then tap **Folder**. The new folder is created.
- 5 Type a name for the folder, then press **ENTER**. The new folder name appears by the folder icon.



#### Help and Support



For more information about creating files and folders, tap **Start**, then tap **Help and Support**.

Type the keyword **creating files and folders** in the Help and Support Center **Search** box  , then tap the arrow.

For information about renaming folders, see “Keyboard shortcuts” on page 75.

## Copying and moving files and folders

The skills you need to copy and move files are called *copying*, *cutting*, and *pasting*.

When you *copy and paste* a file or folder, you place a *copy* of the file or folder on the Windows *clipboard*, which temporarily stores it. Then, when you decide what folder you want the copy to go in (the *destination* folder), you *paste* it there.

When you *cut and paste* a file or folder, you remove the file or folder from its original location and place the file or folder on the Windows clipboard. When you decide where you want the file or folder to go, you paste it there.

**Important**



The clipboard stores whatever you cut or copy until you cut or copy again. Then the clipboard contains the new information only. Therefore, you can paste copies of a file or folder into more than one place, but as soon as you copy or cut a different file or folder, the original file or folder is deleted from the clipboard.

**▶ To copy a file or folder to another folder:**

- 1** Locate the file or folder you want to copy. For more information, see “Viewing drives” on page 61 and “Searching for files” on page 68.
- 2** Button-tap (press the pen button) the file or folder that you want to copy. A pop-up menu opens on the desktop.
- 3** Tap **Copy** on the pop-up menu.
- 4** Open the destination folder.
- 5** With the pointer inside the destination folder, button-tap.
- 6** Tap **Paste**. A copy of the file or folder appears in the new location.



**▶ To move a file or folder to another folder:**

- 1** Locate the file or folder you want to move. For more information, see “Viewing drives” on page 61 and “Searching for files” on page 68.
- 2** Button-tap (press the pen button) the file or folder that you want to move. A pop-up menu opens on the desktop.
- 3** Tap **Cut** on the pop-up menu.
- 4** Open the destination folder.
- 5** With the pointer inside the destination folder, button-tap.
- 6** Tap **Paste**. The file or folder you moved appears in its new location and is removed from its old location.



**Help and Support**

For more information about copying files and folders or moving files and folders, tap **Start**, then tap **Help and Support**.

Type the keyword **copying files and folders** or **moving files and folders** in the Help and Support Center **Search** box  , then tap the arrow.

## Deleting files and folders

When you throw away paper files and folders, you take them from the file cabinet and put them in a trash can. Eventually the trash can is emptied.

In Windows, you throw away files and folders by first moving them to the Windows trash can, called the *Recycle Bin*, where they remain until you decide to empty the bin.

You can recover any file in the Recycle Bin as long as the bin has not been emptied.



### To delete files or folders:

- 1 In My Computer or Windows Explorer, tap the files or folders that you want to delete. For instructions on how to select multiple files and folders, see “Keyboard shortcuts” on page 75.

If you cannot find the file you want to delete, see “Searching for files” on page 68.

- 2 Tap **File**, then tap **Delete**. Windows moves the files and folders to the Recycle Bin.

**Help and Support**

For more information about deleting files and folders, tap **Start**, then tap **Help and Support**.

Type the keyword **deleting files and folders** in the Help and Support Center **Search** box  , then tap the arrow.

▶ **To recover files or folders from the Recycle Bin:**

- 1 Double-tap the **Recycle Bin** icon. The *Recycle Bin* window opens and lists the files and folders you have thrown away since you last emptied it.
- 2 Tap the files or folders that you want to restore. For instructions on how to select multiple files and folders, see “Keyboard shortcuts” on page 75.
- 3 Tap **File**, then tap **Restore**. Windows returns the deleted files or folders to their original locations.



▶ **To empty the Recycle Bin:**

**Caution**



Emptying the Recycle Bin permanently erases any files or folders in the bin. These files cannot be restored.

- 1 Double-tap the **Recycle Bin** icon on the desktop. The *Recycle Bin* window opens.
- 2 Tap **File**, then tap **Empty Recycle Bin**. Windows asks you if you are sure that you want to empty the bin.
- 3 Tap **Yes**. Windows permanently deletes all files in the Recycle Bin.



**Help and Support**



For more information about emptying the Recycle Bin, tap **Start**, then tap **Help and Support**.

Type the keyword **emptying Recycle Bin** in the Help and Support Center **Search** box  , then tap the arrow.

## Browsing for files and folders

A file or folder that you need is rarely right on top of your Windows desktop. It is usually on a drive inside a folder that may be inside yet another folder, and so on.

Windows drives, folders, and files are organized in the same way as a real file cabinet in that they may have many levels (usually many more levels than a file cabinet, in fact). So you usually will have to search through levels of folders to find the file or folder that you need. This is called *browsing*.



### To browse for a file:

- 1 Tap **Start**, then tap **My Computer**. The *My Computer* window opens.
- 2 Double-tap the drive or folder that you think contains the file or folder that you want to find. If you do not see the contents of a folder, tap **Show the contents of this drive** or **Show the contents of this folder**.

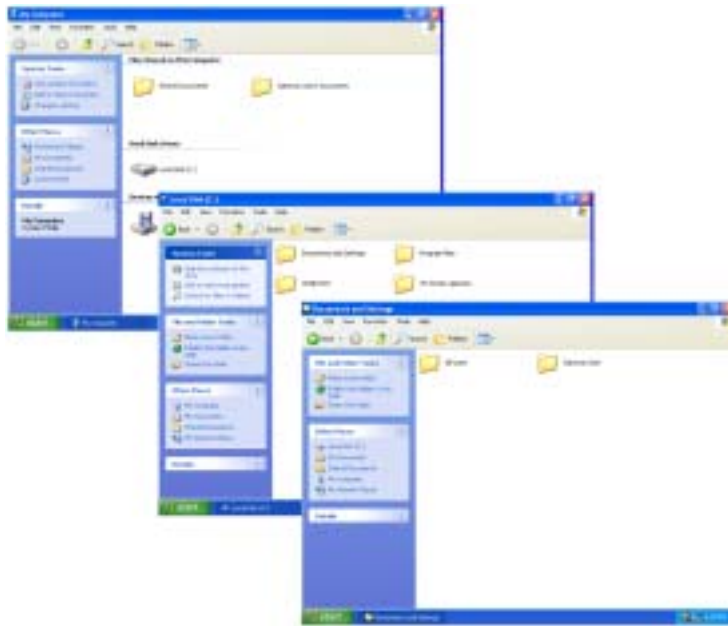

- 3 Continue double-tapping folders and their subfolders until you find the file or folder you want.



**Help and Support**



For more information about browsing for files and folders, tap **Start**, then tap **Help and Support**.

Type the keyword **files and folders** in the Help and Support Center **Search** box  , then tap the arrow.

## Searching for files

If you are looking for a particular file or folder or a set of files or folders that have characteristics in common, but you do not remember where they are stored on your hard drive, you can use the Search utility to search by:

- Name or part of a name
- Creation date
- Modification date
- File type
- Text contained in the file
- Time period in which it was created or modified

You can also combine search criteria to refine searches.

Files and folders found using this utility can be opened, copied, cut, renamed, or deleted directly from the list in the results window.

▶ **To find files and folders using the Search utility:**

- 1 Tap **Start**, then tap **Search**. The *Search Results* window opens. Tap **All files and folders**.

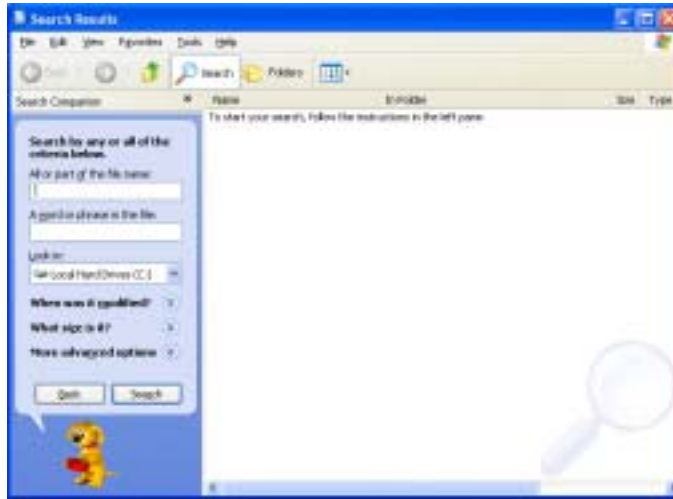

- 2 If you want to search by file or folder name, type in all or part of the file or folder name in the name box in the left pane of the window.
  - If you type all of the name, Search will list all files and folders of that name.
  - If you type part of the name, Search will list all of the file and folder names containing the letters you typed.



- 3 Tap **Search**. When the search is completed, Windows lists the files and folders whose names contain the text that you searched for.

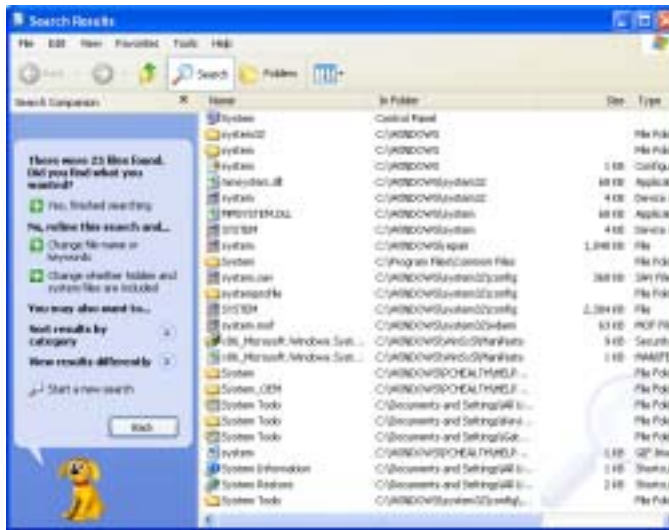

- 4 Open a file, folder, or program by double-tapping the name in the list.



### Help and Support



For more information about searching for files and folders, tap **Start**, then tap **Help and Support**.

Type the keyword **searching** in the Help and Support Center **Search** box  , then tap the arrow.

## Using advanced search options

Search can find files meeting more criteria than file name. You can narrow your search by selecting the search options that you want. You can search by the:

- Date the file was created or modified.
- Size of the file.
- Type of file, such as a program or a text document.



# Working with documents

Tablet PC documents include word processing files, spreadsheet files, or other similar files. The basic methods of creating, saving, opening, and printing a document apply to most of these types of files.

The following examples show how to create, save, open, and print a document using Microsoft® WordPad. Similar procedures apply to other programs such as Microsoft Word and Microsoft Excel.

For more information about using a program, tap **Help** on its menu bar.

## Creating a new document

▶ To create a new document:

- 1 Tap **Start**, **All Programs**, **Accessories**, then tap **WordPad**. Microsoft WordPad starts and a blank document opens.



- 2 Begin composing your document. Use the menus and toolbar buttons at the top of the window to format the document.



# Saving a document

After you create a document, you need to save it if you want to use it later.

 **To save a document:**

- 1 Tap **File**, then tap **Save**. The *Save As* dialog box opens.

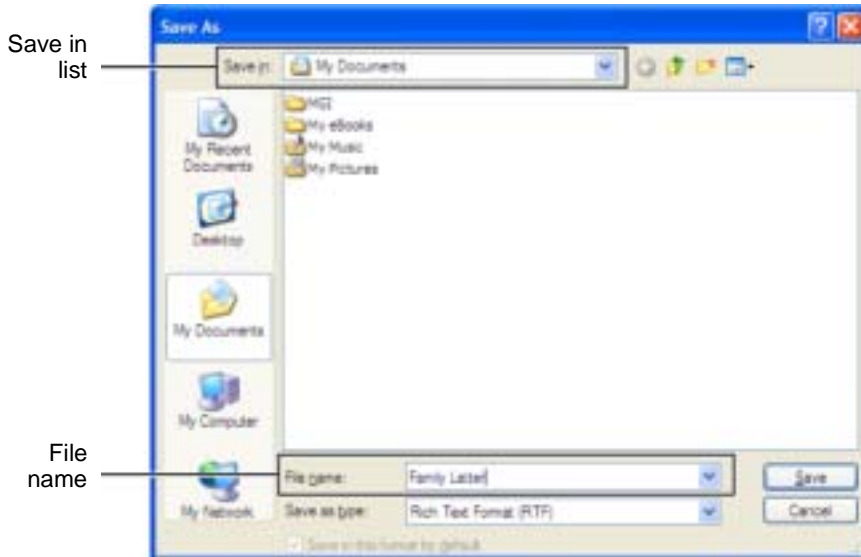

- 2 Tap the arrow button to open the **Save in** list, then tap the folder where you want to save the file. If you do not see the folder you want, browse through the folders listed below the *Save in* list.
- 3 Type a new file name in the **File name** box.
- 4 Tap **Save**.



## Help and Support



For more information about saving documents, tap **Start**, then tap **Help and Support**.

Type the keyword **saving** in the Help and Support Center **Search** box  , then tap the arrow.

# Opening a document

To view, revise, or print an existing document, first you need to open it. Open the document in the program that it was created in.

## ▶ To open a document:

- 1 Start the program.
- 2 Tap **File**, then tap **Open**.
- 3 Tap the arrow button to open the **Look in** list, then tap the folder you want to open. If you do not see the folder you want, browse through the folders listed below the **Look in** list.

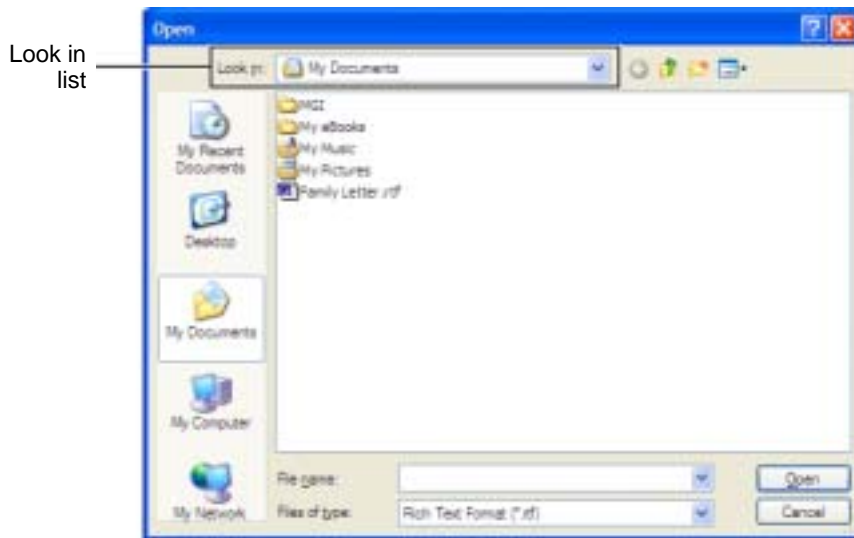

- 4 Double-tap the document file name. The document opens.



### Help and Support



For more information about opening documents, tap **Start**, then tap **Help and Support**.

Type the keyword **opening files** in the Help and Support Center **Search** box  , then tap the arrow.

## Printing a document

To print a document, you must have a printer connected to your tablet PC or have access to a network printer. For more information about installing or using your printer, see the printer documentation.



### To print a document:

- 1 Make sure that the printer is turned on and loaded with paper.
- 2 Start the program and open the document.
- 3 Tap **File**, then tap **Print**. The *Print* dialog box opens.
- 4 Set the print options, then tap **OK**. The document prints.



#### Help and Support



For more information about printing documents, tap **Start**, then tap **Help and Support**.

Type the keyword **printing** in the Help and Support Center **Search** box  , then tap the arrow.

# Keyboard shortcuts

The following table shows a few shortcuts that you can use in Windows and almost all programs that run in Windows. For more information about shortcuts, see your Windows or program documentation.

To...	Do this...
Copy a file, folder, text, or graphic	Click the item, then press <b>CTRL + C</b> .
Cut a file, folder, text, or graphic	Click the item, then press <b>CTRL + X</b> .
Paste a file, folder, text, or graphic	Click inside the folder or window where you want to paste the object, then press <b>CTRL + V</b> .
Select multiple items in a list or window	Click the first item, press and hold down the <b>CTRL</b> key, then click each of the remaining items.
Select multiple adjacent items in a list or window	Click the first item in the list, press and hold down the <b>SHIFT</b> key, then click the last item in the list.
Permanently delete a file or folder	Click the file or folder, then press <b>SHIFT + DELETE</b> . The file or folder is permanently deleted. The file or folder is <b>not</b> stored in the Recycle Bin.
Rename a file or folder	Click the file or folder, press <b>F2</b> , type the new name, then press <b>ENTER</b> .
Close the active window or program	Press <b>ALT + F4</b> .
Switch to a different file, folder, or running program	Press <b>ALT + TAB</b> .

## Help and Support



For more information about Windows keyboard shortcuts, tap **Start**, then tap **Help and Support**.

Type the keyword **Windows keyboard shortcuts** in the Help and Support Center **Search** box

Search  , then tap the arrow.





# Using the Internet

# 5

This chapter provides information about the Internet and the World Wide Web. Read this chapter to learn how to:

- Set up and access an Internet account
- Connect to a Web site using a browser
- Download files from the Internet
- Send and receive e-mail



# Learning about the Internet

The *Internet* is a worldwide network of computers linked together to provide information to people everywhere. The two most popular services on the Internet are e-mail and the World Wide Web. You can access this network by connecting your tablet PC to a telephone, DSL (Digital Subscriber Line), or cable line and signing up with an Internet service provider (ISP).

Cable and DSL modems, a connection known as broadband, use your TV cable or special telephone lines to connect to your ISP and access the Internet. Cable and DSL modems connect to your tablet PC through an Ethernet jack and provide a faster connection speed than a standard telephone modem.

**Important**



For the location of your modem and Ethernet jacks, see “Ports side” on page 7 and “Back” on page 229.

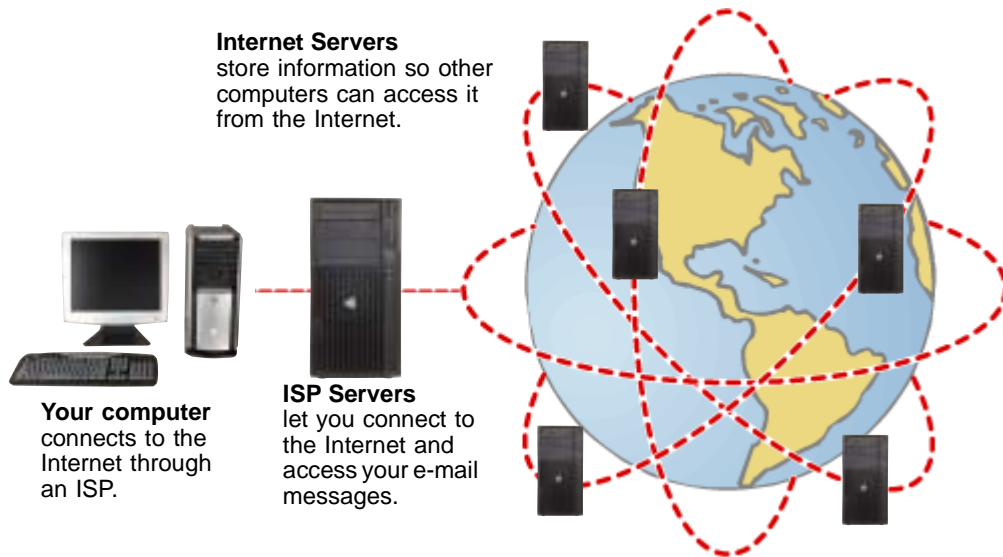



If you want to access the Internet you need:

- A **modem** – a device that connects your tablet PC to other computers or servers using a telephone, DSL, or cable line.
- An **Internet service provider** – a company that provides access to the Internet through an ISP server. When you connect to an ISP, the ISP server lets you access the Internet and your e-mail messages.
- A **Web browser** – a program that displays information from the World Wide Web.
- An **e-mail program** – a program that lets you create, send, and receive e-mail messages over the Internet.

## Setting up an Internet account

Before you can view the information on the World Wide Web, you need to set up an Internet account with an Internet service provider (ISP). To set up an ISP service or to transfer an existing account to this tablet PC, contact the ISP directly.

### Help and Support



For general information about using Internet accounts, tap **Start**, then tap **Help and Support**.

Type the keyword **ISP** in the Help and Support Center **Search** box  , then tap the arrow.

# Using the World Wide Web

The World Wide Web is a multimedia window to the Internet that gives you access to millions of information sources.

Information on the Web comes to you on *Web pages*, which are electronic documents that you view using a Web page display program called a *browser*. You can use any of the commercially available Web browsers, like Microsoft Internet Explorer (which comes installed on your new tablet PC) or Netscape Navigator.

Web pages can contain text, animations, music, and other multimedia features. A group of related Web pages is called a *Web site*. You can access Web sites to shop, track investments, read the news, download programs, and much more.

You can explore a Web site or visit other Web sites by tapping areas on a Web page called *links* or *hyperlinks*. A link may be colored or underlined text, a picture, or an animated image. You can identify a link by moving the pointer over it. If the pointer changes to a hand, the item is a link.

To learn more about using the Web browser features, tap **Help** in the menu bar.

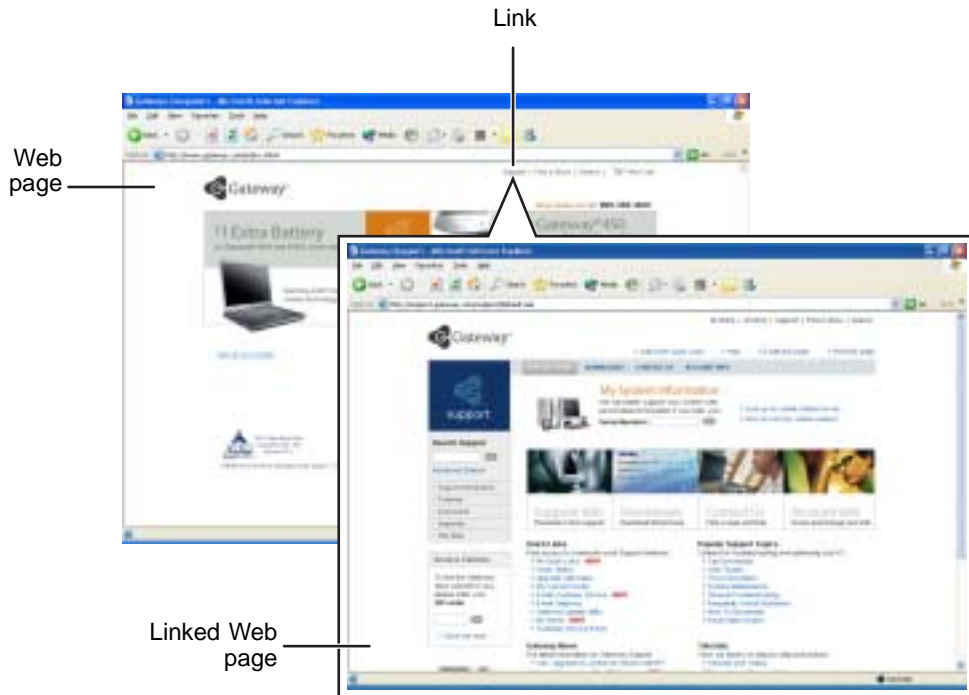

## Connecting to a Web site

After you set up an account with an Internet service provider (ISP), you can access the many information sources on the World Wide Web.

### To connect to a Web site:

- 1 Connect to your Internet account. After your tablet PC connects, a default opening page or welcome screen opens.
- 2 To go to a different Web site, type the *address* (called a *URL* for “Universal Resource Locator”) in the browser address bar (for example **www.gateway.com**), then tap **GO** on the browser address bar.



- OR -

On the current Web page, tap a link to a Web site.

The Web browser locates the server computer on the Internet, *downloads* (transfers) data to your tablet PC, and displays the page on the site that you requested.



#### Help and Support



For more information about connecting to a Web site, tap **Start**, then tap **Help and Support**.

Type the keyword **connecting to Web site** in the Help and Support Center **Search** box  **Search** , then tap the arrow.

Sometimes Web pages display slowly. The speed that a Web page displays on your screen depends on the complexity of the Web page and other Internet conditions. Additionally, the speed of your connection will determine how fast Web pages display.

## Downloading files

*Downloading* is the process of transferring files from a computer on the Internet to your tablet PC.

To protect your tablet PC against viruses, make sure that you scan the files you download. For more information, see “Protecting your tablet PC from viruses” on page 193.



### To download files or programs from a Web site:

- 1 Connect to your Internet account.
- 2 In the address bar, type the address of the Web site that contains the file or program you want to download, then tap **GO** on the browser address bar.  
- OR -  
Tap a link on a Web page to navigate to the Web site containing the file that you want to download.
- 3 Create or locate the folder where you want to store the file on your tablet PC. For more information, see “Working with files and folders” on page 61.
- 4 Tap the link on the Web page for the file that you want to download.
- 5 Follow the on-screen instructions for saving the file in the folder that you want. A copy of the file is downloaded to your tablet PC. The time that it takes to transfer the file to your tablet PC depends on file size and Internet conditions.
- 6 Open the folder that you created.
- 7 Install or view the downloaded file by double-tapping it. If applicable, follow the instructions provided on the Web site to run or install the program.



#### Help and Support



For more information about downloading files, tap **Start**, then tap **Help and Support**.

Type the keyword **downloading files** in the Help and Support Center **Search** box  , then tap the arrow.

# Using e-mail

*E-mail* (electronic mail) lets you send messages to anyone who has an Internet connection and e-mail address. E-mail is usually a free service of your Internet account.

The Internet never closes, so you can send e-mail messages at any time. Your e-mail messages arrive at most e-mail addresses in minutes.

An *e-mail address* consists of a user name, the @ symbol, and the Internet *domain name* of the Internet service provider (ISP) or company that “hosts” that user. Your e-mail address is assigned when you sign up for an account with an ISP. For example, a person with an account with America Online might have an e-mail address that is similar to this one:



## Sending e-mail

### To send e-mail using Microsoft Outlook:

- 1** Connect to your e-mail account.
- 2** Tap **New**.
- 3** Type the e-mail address of the recipient you want to send e-mail to in the **To** box.
- 4** Type the subject of your e-mail in the **Subject** box.
- 5** Type the e-mail message.
- 6** When finished, tap **Send**. Your e-mail is sent over the Internet to the e-mail address you specified.



## Checking your e-mail

### To check your e-mail using Microsoft Outlook:

- 1 Connect to your e-mail account.
- 2 Tap the Inbox.
- 3 Double-tap the message you want to read.



For more information about managing and organizing your e-mail messages, see the online help in your e-mail program.

#### Help and Support



For general information about using e-mail, tap **Start**, then tap **Help and Support**.

Type the keyword **e-mail** in the Help and Support Center **Search** box Search   , then tap the arrow.



# 6

## Using Multimedia

This chapter provides information on using the multimedia capabilities of your tablet PC. Read this chapter to learn how to:

- Adjust the volume
- Record and play audio files
- Use Windows Media Player
- Use a diskette or combination DVD/CD-RW drive
- Play CDs
- Play DVDs
- Create CDs
- Attach a digital camera to your tablet PC
- Attach a digital video camera to your tablet PC



# Adjusting the volume

You can use the volume controls to adjust the overall volume and the volume of specific sound devices in your tablet PC.

▶ **To adjust the overall volume level using hardware controls:**

- If you are using external speakers, turn the knob on the front of the speakers.



▶ **To adjust the overall volume level:**

- 1 Tap **Start**, then tap **Control Panel**. The *Control Panel* window opens. If your Control Panel is in Category View, tap **Sounds, Speech, and Audio Devices**.
- 2 Tap/Double-tap the **Adjust the system volume** or **Sounds and Audio Devices**. The *Sounds and Audio Devices Properties* dialog box opens.
- 3 Tap the **Volume** tab.





- 4 Drag the **Device Volume** slider to change the volume or tap to select the **Mute** check box, then tap **OK**.



### Help and Support



For more information about adjusting volume, tap **Start**, then tap **Help and Support**.

Type the keyword **adjusting volume** in the Help and Support Center **Search** box  , then tap the arrow.



### To adjust specific volume levels:

- 1 Tap **Start**, then tap **Control Panel**. The *Control Panel* window opens. If your Control Panel is in Category View, tap **Sounds, Speech, and Audio Devices**.
- 2 Tap/Double-tap the **Adjust the system volume** or **Sounds and Audio Devices**. The *Sounds and Audio Devices Properties* dialog box opens.
- 3 Tap the **Volume** tab.



- 4 Tap **Advanced** in the **Device volume** area.

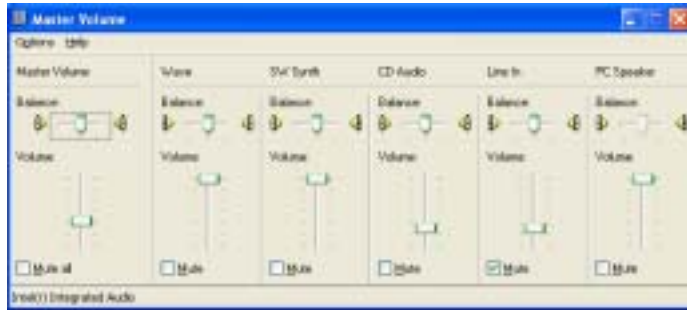

If the device you want to adjust does not appear in the window, tap **Options**, **Properties**, the check box next to the audio device you want to adjust, then tap **OK**.

- 5 Drag the volume level and balance sliders for the device you want to adjust. For more information about the volume controls, tap **Help** in the window.
- 6 Tap **X** in the top-right corner of the window to close it.



# Recording and playing audio

Use the following instructions to make an audio recording by speaking into a microphone.

## ▶ To make an audio recording:

1 Use the built-in microphone located on the front of the tablet PC.

-OR-

Plug a microphone into the microphone jack on your tablet PC. For the location of the microphone jack, see “Ports side” on page 7 or “Back” on page 229.

2 Tap **Start**, **All Programs**, **Accessories**, **Entertainment**, then tap **Sound Recorder**. The Sound Recorder opens.

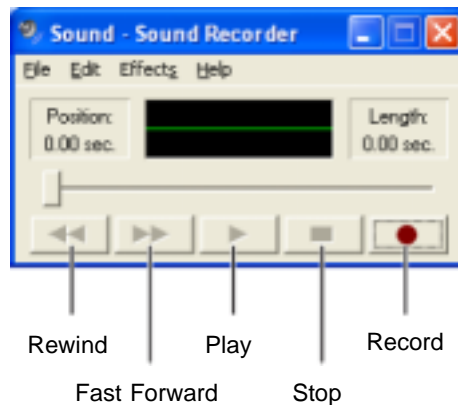

3 Tap ● (record), then speak into the microphone.



4 When you finish recording, tap ■ (stop).

5 Tap **File**, then tap **Save As**. The *Save As* dialog box opens.

6 Name the recording, specify the location where you want to save the recording, then tap **Save**. The recording is saved.



 **To play an audio recording in Sound Recorder:**

- 1** Open the Sound Recorder.
- 2** Tap **File**, then tap **Open**. The *Open* dialog box opens.
- 3** Tap the file you want to play, then tap **Open**.
- 4** Play the file by tapping  (play), then stop playing the file by tapping  (stop).



**Help and Support**



For more information about making or playing an audio recording, tap **Start**, then tap **Help and Support**.

Type the keyword **recording audio** or **playing audio** in the Help and Support Center **Search** box

Search  , then tap the arrow.

# Playing audio and video files with the Windows Media Player

The Windows Media Player can play several types of audio and video files, including WAV, MIDI, MP3, AU, AVI, and MPEG formats. For more information about using the Windows Media Player, tap **Help**.

## To play a file using the Windows Media Player:

- 1 Tap **Start**, **All Programs**, then tap **Windows Media Player**. The Windows Media Player opens.



- 2 Tap **File**, then tap **Open**. The *Open* dialog box opens.

**Important**



If the menu bar does not appear, tap the show menu bar  button.

- 3 Tap the file you want to play, then tap **Open**.
- 4 Play the file by tapping ► (play), then stop playing the file by tapping ■ (stop).



**Help and Support**



For more information about playing audio and video using the Windows Media Player, tap **Start**, then tap **Help and Support**.

Type the keyword **Media Player** in the Help and Support Center **Search** box  , then tap the arrow.

# Using the optional diskette drive

The diskette drive uses 3.5-inch diskettes (sometimes called *floppy disks*). Diskettes are useful for storing files or transferring files to another computer.

## Warning



Do not expose diskettes to water or magnetic fields. Exposure could damage the data on the diskette.

## Important



If you need to use a diskette drive, Gateway recommends purchasing a USB diskette drive. To order a USB diskette drive, visit the Accessory Store at [accessories.gateway.com](http://accessories.gateway.com).



Diskette activity indicator

Diskette eject button



## To use a diskette:

- 1 Plug the diskette drive into a USB port on the tablet PC or FlexDock. For the location of your USB ports, see “Ports side” on page 7, “Front” on page 228, and “Back” on page 229.
- 2 Insert the diskette into the diskette drive with the label facing up.



- 3 To access a file on the diskette, tap **Start**, then tap **My Computer**. Double-tap the drive letter (for example, the A: drive), then double-tap the file name.
- 4 To remove the diskette, make sure that the diskette activity indicator is off, then press the diskette eject button.



## Using the optional DVD/CD-RW drive

You can use your tablet PC to enjoy a wide variety of multimedia features. Use the optional combination DVD/CD-RW drive for installing programs, playing audio CDs, playing DVDs, accessing data, and recording music and data to CD-R or CD-RW discs. You cannot use this drive to create DVDs.

### Important



If you need to use a CD or DVD drive, Gateway recommends purchasing the combination DVD/CD-RW drive. To order a combination DVD/CD-RW drive, visit the Accessory Store at [accessories.gateway.com](http://accessories.gateway.com).

## Connecting the DVD/CD-RW drive

Everything you need to read from or write to a CD and to read from a DVD is included in this package:

- DVD/CD-RW drive with IEEE 1394 cable
- AC power adapter and power cord
- Installation card
- Software CDs:
  - Ahead Software's Nero Burning ROM™
  - CyberLink® PowerDVD™



**▶ To connect the DVD/CD-RW drive:**

- 1** Connect the AC adapter to your drive's power connector.



- 2** Connect the IEEE 1394 cable from the drive to the jack on the tablet PC or FlexDock.



## Inserting a CD or DVD

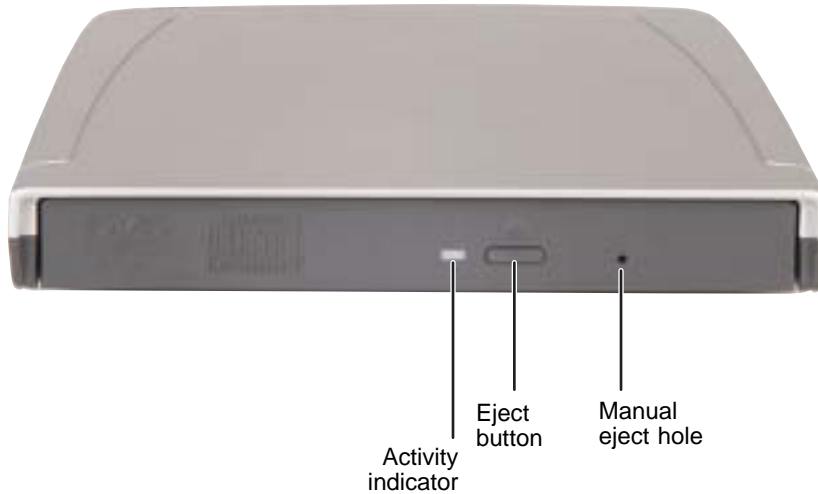

**Important**



Some music CDs have copy protection software. You may not be able to play these CDs on your tablet PC.

**To insert a CD or DVD:**

- 1** Press the eject button on the combination DVD/CD-RW drive. After the tray opens slightly, pull the disc tray completely open.
- 2** Place the disc in the tray with the label facing up, then press down carefully on the disc until it snaps into place.

**Important**



When you place a single-sided disc in the tray, make sure that the label side is facing up. If the disc has two playable sides, place the disc so the name of the side you want to play is facing up.

- 3** Push the tray in until it is closed.



## Listening to CDs

You can use the combination DVD/CD-RW drive on your tablet PC to listen to music CDs. Use the Windows Media Player to listen to CDs. For more information about the using the Windows Media Player, tap **Help**.

### Important



Some music CDs have copy protection software. You may not be able to play these CDs on your tablet PC.



### To play a CD using Windows Media Player:

- 1 Insert a CD into the combination DVD/CD-RW drive.
- 2 If a dialog box opens with a list of CD players, tap **Windows Media Player**. The Windows Media Player opens.

- OR -

If a dialog box does not open with a list of CD players, tap **Start, All Programs**, then tap **Windows Media Player**. The Windows Media Player opens.



- 3 When the media player opens, tap ► (play).

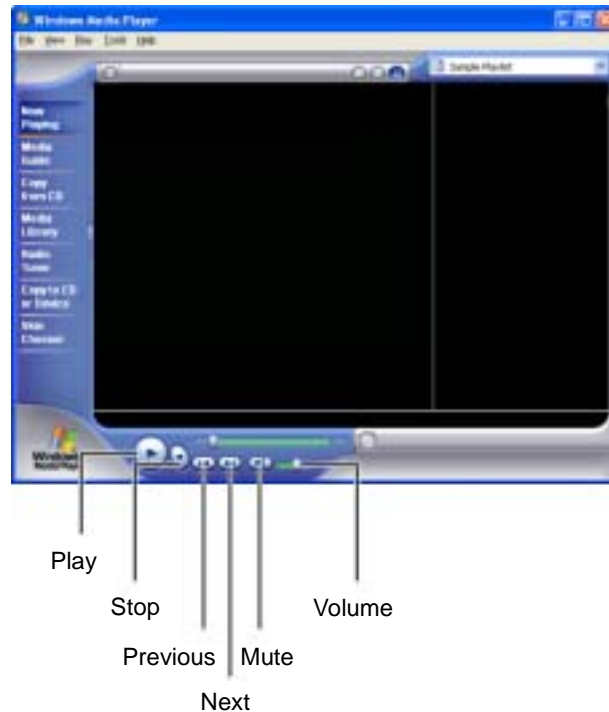

If you do not hear sound or you want to change the volume, see “Adjusting the volume” on page 86.



#### Help and Support



For more information about playing CDs, tap **Start**, then tap **Help and Support**.

Type the keyword **playing CDs** in the Help and Support Center **Search** box  **Search**  , then tap the arrow.

#### Tips & Tricks



See *Do More With Gateway* for more information about using your tablet PC to listen to music. Tap **Start**, then tap **Do More With Gateway**.

## Playing a DVD

A Digital Versatile Disc (DVD) is similar to a standard CD but has greater data capacity. Because of this increased capacity, full-length movies, several albums of music, or several gigabytes of data can fit on a single disc. If your tablet PC has a combination DVD/CD-RW drive, you can play DVDs with InterVideo WinDVD. For more information about playing DVDs, tap **Help** in WinDVD.

### Important



If InterVideo WinDVD is not on your Start menu, you will need to install it. To install InterVideo WinDVD, insert the InterVideo DVD Software disc into your DVD/CD-RW drive and follow the on-screen instructions.



### To play a DVD:

- 1 Make sure that the speakers are turned on or headphones are plugged in and that the volume is turned up.
- 2 Turn off your screen saver and standby timers.
- 3 To play a DVD using InterVideo WinDVD, tap **Start**, **All Programs**, **InterVideo WinDVD**, then tap **InterVideo WinDVD**.
- 4 Insert a DVD into the DVD drive, then tap ► (play). The DVD plays. To specifically control the DVD or adjust the volume, use the controls in the DVD player. For more information on using the DVD player, see its online help.



### Help and Support



For more information about playing DVDs, tap **Start**, then tap **Help and Support**.

Type the keyword **playing DVDs** in the Help and Support Center **Search** box  **Search** , then tap the arrow.

## Creating CDs

You can use your combination DVD/CD-RW drive to create data CDs, music CDs, or copies of CDs.

**Important**



If Nero Express is not on your Start menu, you will need to install the Nero Express program. To install the Nero Express program, insert the Nero Express disc into your DVD/CD-RW drive and follow the on-screen instructions.

**Important**



For more information about using Ahead Software's Nero Express, see the online documentation. Tap **Start, All Programs, Ahead Nero, User's Guides**, then tap **Nero Express**.

### Creating data CDs

Use Nero Express to create **data** CDs. Data CDs are ideal for backing up important files such as tax records, letters, MP3s, digital movies, or photos. For information on creating **music** CDs, see "Creating music CDs" on page 104.

**Important**



We recommend that you do not use your tablet PC for other tasks while creating CDs.

**Important**



If you record copyrighted material on a CD, you need permission from the copyright owner. Otherwise, you may be violating copyright law and be subject to payment of damages and other remedies. If you are uncertain about your rights, contact your legal advisor.

▶ **To create a data CD:**

- 1** Insert a blank, writable CD into your DVD/CD-RW drive.
- 2** If a *CD Drive* dialog box opens, tap **Create new CD using Ahead Nero**, then tap **OK**. Nero Express starts.

- OR -

If a dialog box does not open, tap **Start, All Programs, Ahead Nero**, then tap **Nero Express**. Nero Express starts.

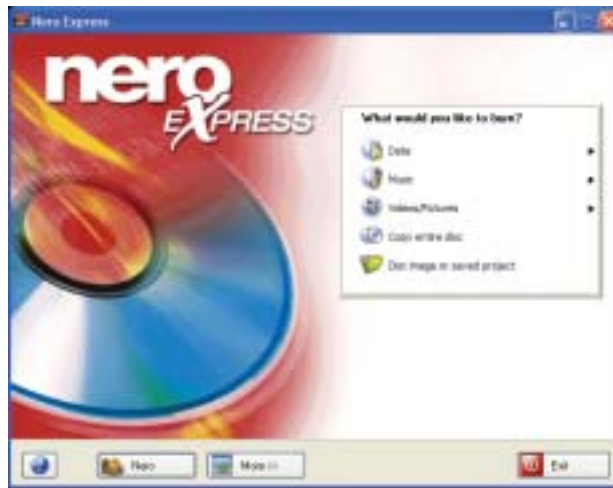

- 3 Tap **Data**, then tap **Data Disc**. The *Disc Content* screen opens.



- 4 Tap **Add**. The *Select Files and Folders* dialog box opens.
- 5 Tap the file(s) you want to record (hold down the **CTRL** or **SHIFT** key when you tap to select multiple files), then tap **Add**. The *Select Files and Folders* dialog box closes.





- 6 After you have added all of your files, tap **Next**. The *Final Burn Settings* screen opens.



- 7 Type a name for the disc in the **Disc Name** box.
- 8 Tap **Burn**. The *Burning Process* screen opens.

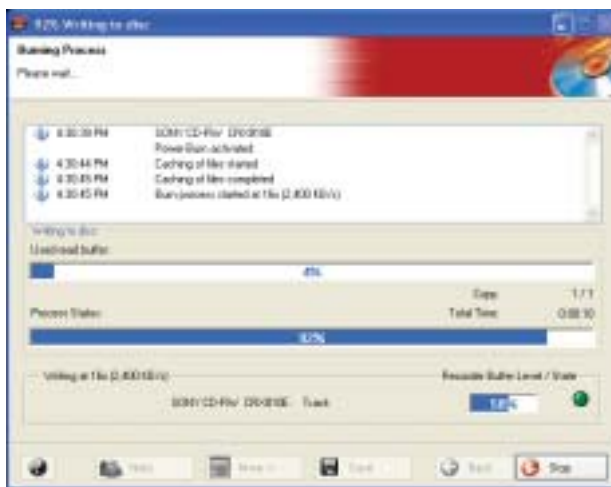

- 9 When you are notified that the burn has been completed successfully, tap **OK**.



**Help and Support**



For more information about creating CDs, tap **Start**, then tap **Help and Support**.

Type the keyword **creating CDs** in the Help and Support Center **Search** box  , then tap the arrow.

## Creating music CDs

Use Nero Express to create **music** CDs from other music CDs or MP3 files. For information on creating data CDs, see “Creating data CDs” on page 100.

**Important**



We recommend that you do not use your tablet PC for other tasks while creating CDs.

**Important**



If you record copyrighted material on a CD, you need permission from the copyright owner. Otherwise, you may be violating copyright law and be subject to payment of damages and other remedies. If you are uncertain about your rights, contact your legal advisor.

**Important**



Some CDs have copy protection software. You cannot create MP3 files from these CDs and you may not be able to listen to these CDs on your tablet PC.



### To create music CDs:

- 1 Insert a blank, writable CD into your DVD/CD-RW drive.

**Tips & Tricks**



Most home and car stereos can read CD-R discs, but cannot read CD-RW discs. To make sure that the CD that you create will play on home and car CD players, use a CD-R disc.

- 2 If a *CD Drive* dialog box opens, tap **Create new CD using Ahead Nero**, then tap **OK**. Nero Express starts.

- OR -

If a dialog box does not open, tap **Start, All Programs, Ahead Nero**, then tap **Nero Express**. Nero Express starts.



- 3 Tap **Music**, then tap the type of CD you want to create: **Audio CD**, **MP3 Disc**, or **WMA Disc**. The *My Audio CD* screen opens.

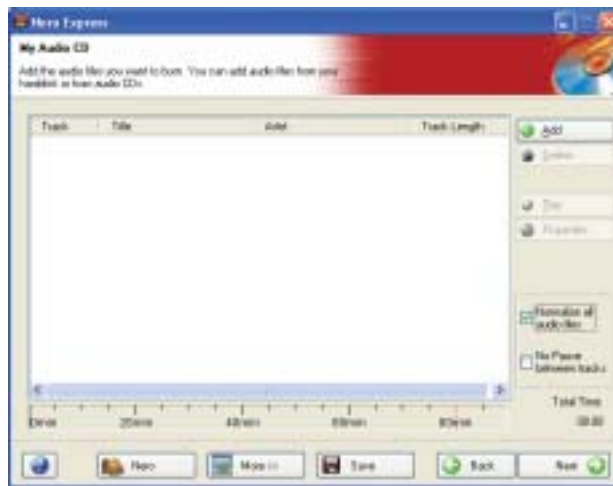

- 4 Tap **Add**. The *Select Files and Folders* dialog box opens.
- 5 Tap the file(s) you want to record (hold down the **CTRL** or **SHIFT** key when you tap to select multiple files), then tap **Add**. The *Select Files and Folders* dialog box closes.

**Tips & Tricks**



You can add any combination of music tracks or MP3 files to a music CD project. You can add up to 99 tracks and files, or up to 650 MB (74-minute CD) or 700 MB (80-minute CD) of tracks and files to a music CD project.

**Tips & Tricks**



To change the order of the songs on the CD, tap and drag the song to the appropriate location in the list.



- 6 After you have added all of your tracks and files, tap **Next**. The *Final Burn Settings* screen opens.



- 7 Type a name for the disc in the **Disc Name** box.
- 8 Tap **Burn**. The *Burning Process* screen opens.

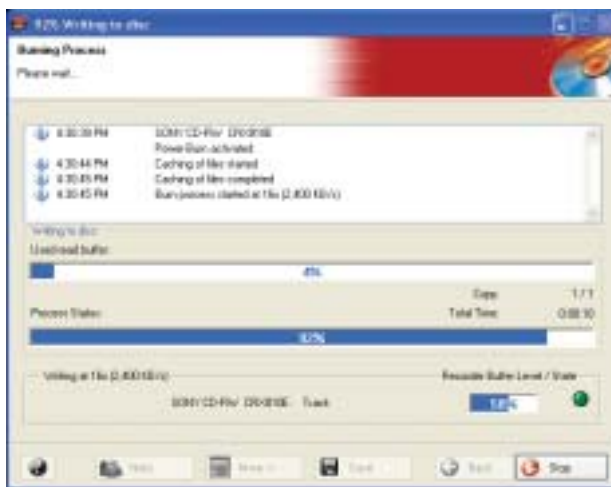

- 9 When you are notified that the burn has been completed successfully, tap **OK**.



**Help and Support**



For more information about creating CDs, tap **Start**, then tap **Help and Support**.

Type the keyword **creating CDs** in the Help and Support Center **Search** box  , then tap the arrow.

## Copying CDs

Nero Express can make backup copies of almost any type of CD.

**Important**



We recommend that you do not use your tablet PC for other tasks while creating a CD.

**Important**



If you record copyrighted material on a CD, you need permission from the copyright owner. Otherwise, you may be violating copyright law and be subject to payment of damages and other remedies. If you are uncertain about your rights, contact your legal advisor.



**To copy a CD:**

- 1** Insert the CD you want to copy into your DVD/CD-RW drive.
- 2** If a dialog box opens, click **Take no action**.

- 3 Tap **Start, All Programs, Ahead Nero**, then tap **Nero Express**. Nero Express starts.



- 4 Tap **Copy Entire Disc**. The *Select Source and Destination* screen opens.



- 5 Tap **Burn**. The *Burning Process* screen opens.

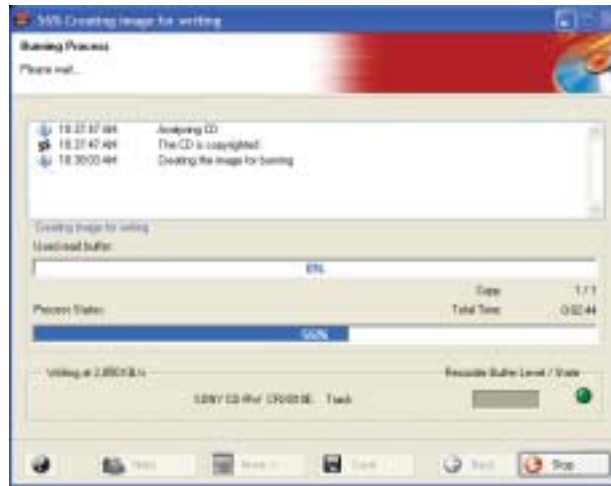

- 6 When the DVD/CD-RW drive tray opens, replace the source CD with a blank, writable CD, then close the drive tray.
- 7 When you are notified that the burn has been completed successfully, tap **OK**.



#### Help and Support



For more information about copying CDs and DVDs, tap **Start**, then tap **Help and Support**.

Type the keyword **copying CDs** in the Help and Support Center **Search** box  **Search** , then tap the arrow.



# Using an external monitor



## To attach an external monitor:

- 1 Turn off the Tablet PC.
- 2 Plug the monitor cable into the VGA port on the tablet or FlexDock. Turn on the tablet.
- 3 Plug the monitor's power cord into an AC power source and turn it on. Windows XP recognizes the new hardware and searches for its driver. You may need to install the driver from the disc supplied by the monitor's manufacturer or download the driver from the manufacturer's Web site. If you need to install a driver from the manufacturer's CD, you must first attach the optional DVD/CD-RW drive. For more information, see "Connecting the DVD/CD-RW drive" on page 94.
- 4 After the driver is installed, button-tap any empty space on the desktop, then tap **Properties**. The *Display Properties* dialog box opens.
- 5 Tap the **Settings** tab.
- 6 Button-tap the second monitor icon (labeled 2), then tap **Attached**.
- 7 Tap **Apply**.
- 8 Adjust properties such as **Screen Resolution** or **Color Quality** if necessary.
- 9 Tap **OK**.



# Connecting a digital camera

Most digital cameras connect to your tablet PC's USB port to transfer pictures.

▶ **To connect a digital camera:**

- 1 Connect one end of the USB cable to your digital camera, and connect the other end of the cable to the USB port on the tablet PC or FlexDock. For the location of your USB ports, see “Ports side” on page 7, “Front” on page 228, and “Back” on page 229.



- 2 Use the program that came with your digital camera to transfer the pictures to your tablet PC.

-OR-

Use the Scanner and Camera Wizard to transfer the pictures to your tablet PC.

-OR-

If your digital camera appears as a drive on your tablet PC in the *My Computer* window, see “Working with files and folders” on page 61 for information about moving files to your hard drive.



### Help and Support



For more information about using the Scanner and Camera Wizard, tap **Start**, then tap **Help and Support**.

Type the keyword **digital picture** in the Help and Support Center **Search** box  , then tap the arrow.

### Tips & Tricks



See *Do More With Gateway* for more information about using your tablet PC to edit, store, and print digital photos. Tap **Start**, then tap **Do More With Gateway**.

# Connecting a digital video camera

Your tablet PC has an IEEE 1394 (also known as Firewire or i.Link) port that can be used to connect to a digital video camera. NeroVision Express is a video capture program that lets you capture and edit full-motion video, single images, and audio through the IEEE 1394 port.

## ▶ To connect a digital video camera:

- 1 Connect one end of the IEEE 1394 cable to your video camera, and connect the other end of the cable to the IEEE 1394 port on the tablet PC or FlexDock. For the location of your IEEE 1394 ports, see “Ports side” on page 7, “Front” on page 228, and “Back” on page 229.



- 2 Tap **Start**, **All Programs**, **Ahead NeroVision**, then tap **NeroVision Express**. The program starts.



### Tips & Tricks



See *Do More With Gateway* for more information about using your tablet PC to edit videos. Tap **Start**, then tap **Do More With Gateway**.



# Sending and Receiving Faxes

# 7

Microsoft Fax lets you send and receive faxes using the modem. Read this chapter to learn how to:

- Install and configure Fax
- Create and send a new fax
- Set up a fax cover page template
- Fax a document you scanned or created in another program
- Receive, view, and print a fax



# Installing Fax

Microsoft Fax lets you send and receive faxes using your modem. When Windows XP was originally installed on your tablet PC, Fax was not installed. You need to install Fax from your blue *Operating System CD*.

## Important



Your modem cable must be installed before you can send and receive faxes. You cannot use your standard telephone modem to connect to the Internet while sending and receiving faxes.

## Help and Support



For more information about sending and receiving faxes, tap **Start**, then tap **Help and Support**.

Type the keyword **Fax** in the Help and Support Center **Search** box  , then tap the arrow.



## To install Fax:

- 1 Insert the blue *Operating System CD* in your combination DVD/CD-RW drive. For more information, see “Using the optional DVD/CD-RW drive” on page 94.
- 2 If the *Welcome to Microsoft Windows XP* dialog box opens, tap **Install optional Windows components**. The Windows Components Wizard opens.

-OR-

If the *Welcome to Microsoft Windows XP* dialog box does not open, tap **Start**, then tap **Control Panel**. The *Control Panel* window opens. Tap/Double-tap **Add and Remove Programs**. The *Add or Remove Programs* dialog box opens. Tap **Add/Remove Windows Components**. The Windows Components Wizard opens.

- 3 Tap **Fax Services**, then tap **Next**.
- 4 Tap **Finish** to exit the Windows Components Wizard.

**5** Tap **Exit** to close the *Welcome to Microsoft Windows XP* dialog box.

-OR-

Tap **Close** to close the *Add or Remove Programs* dialog box.



## Configuring Fax

Before you send your first fax, you need to set up your user information. Your fax cover sheets and fax headers contain this information, some of which is required by law. The Fax Configuration Wizard opens the first time you try to send a fax.

### Important



The first time you run the Fax Configuration Wizard, you may need to provide information in the *Location Information* and the *Phone and Modem Options* dialog boxes.

▶ To configure Microsoft Fax:

- 1 Tap **Start**, **All Programs**, **Accessories**, **Communications**, **Fax**, then tap **Fax Console**. The Fax Configuration Wizard opens.
- 2 On the *Welcome to Fax Configuration Wizard* screen, tap **Next**. The *Sender Information* screen opens.

Fax Configuration Wizard

Sender Information  
Enter sender information that will appear on fax cover pages:

Your full name: John Doe Fax number: 555-555-5555

E-mail address: JDoe@aol.com

Title: Manager Company: My Company

Office location: Department:

Home phone: 555-555-5454 Work phone: 555-555-5545

Address: 1234 My Street  
My Town, MS 35000

Billing code:

< Back Next > Cancel

- 3 Type the information about yourself that you want to appear on your fax cover page, then tap **Next**. The *Select Device for Sending or Receiving Faxes* screen opens.
- 4 Tap the arrow to open the **Please select the fax device** list, then tap the modem you are using to send and receive faxes.
- 5 If you want the modem to automatically answer the telephone in order to receive faxes, tap the **Enable Receive** check box.



- 6 Tap **Next**. The *Transmitting Subscriber Identification (TSID)* screen opens.

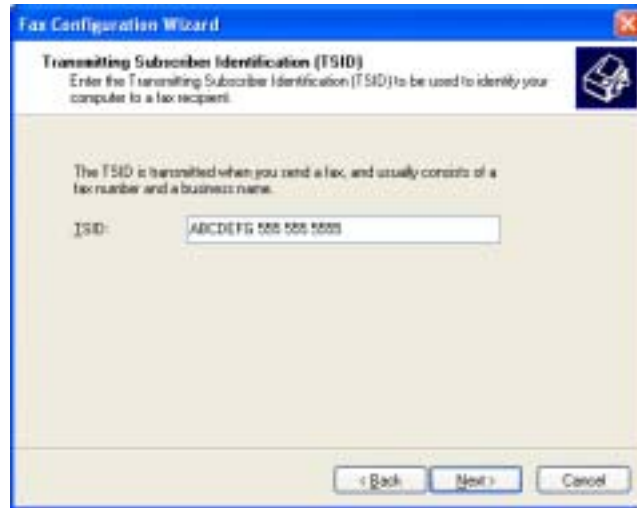

- 7 Type the transmitting fax identifier information. This identifier information is required by law. You can type up to 20 characters in the text box. We suggest using eight characters for your identifier name, followed by 12 characters for your telephone number.

**Important**



Some fax machines cannot use special characters such as hyphens. We suggest using spaces instead of hyphens in telephone and fax numbers.

- 8 Tap **Next**.
- 9 If you set up your tablet PC to receive faxes, type the receiving fax identifier information, then tap **Next**. This identifier information is required by law and can be the same identifier that you typed in Step 7. The *Routing Options* screen opens.
- 10 If you set up your tablet PC to receive faxes, select a folder you want to store received faxes in, then tap **Next**. The *Configuration Summary* screen opens.
- 11 Tap **Finish**.



# Sending a simple fax

You can use the Send Fax Wizard to send a simple one-page fax to one or more recipients.



## To send a simple fax:

- 1 Tap **Start**, **All Programs**, **Accessories**, **Communications**, **Fax**, then tap **Send a Fax**. The Send Fax Wizard opens.
- 2 On the *Welcome to Fax Configuration Wizard* screen, tap **Next**. The *Recipient Information* screen opens.
- 3 Type the name and fax number of the recipient of your fax.
- 4 If you need to use the area code for your recipient, tap **Use dialing rules** to type the full ten-digit fax number.
- 5 If you want to send your fax to more than one recipient, tap **Add** and type the name and fax number of the next recipient.

**Send Fax Wizard**

**Recipient Information**  
Enter the name and number of the person you want to send the fax to, or click Address Book to select a fax recipient.

To: Billy White Address Book...

Location: United States (T) Dialing rules...

Fax number: ( 999 ) 999-1234

Use dialing rules: My Location Dialing rules...

To send to multiple recipients, type each recipient's information above, and then click Add to add the recipient to the list below.

Recipient name	Fax number
May Sue Brown	+1 (999) 455-5456
Jen Bob-Jones	+1 (999) 455-5678

Add  
Remove  
Edit

< Back   Next >   Cancel

- 6 When you have added all your recipients, tap **Next**. The *Preparing the Cover Page* screen opens.
- 7 Tap the arrow to open the **Cover page template**, then tap the cover page template you want to use.

- 8 Type the subject text in the **Subject line** area.
- 9 Type the message text in the **Note** area, then tap **Next**. The *Schedule* screen opens.
- 10 Select when you want to send the fax and a priority for the fax, then tap **Next**. The *Completing the Send Fax Wizard* screen opens.
- 11 Tap **Finish**.



## Setting up your cover page template

You can create your own cover page template that you can use in place of the cover page templates that Microsoft Fax provides for you. To create a cover page template, you use the Fax Cover Page Editor. On this template, you insert information fields that automatically import values you enter in both the Send Fax Wizard and the Fax Configuration Wizard when you send your fax.



### To set up your fax cover page template:

- 1 Tap **Start, All Programs, Accessories, Communications, Fax**, then tap **Fax Cover Page Editor**. The Cover Page-Fax Cover Page Editor opens. If the *Cover Page Editor Tips* dialog box opens, tap **OK**.
- 2 If you want to include fields that are imported from either the Send Fax Wizard or the Fax Configuration Wizard (such as To or From), add them to the page by using the **Insert** menu, then move them to the appropriate place on your template. You can also use the Insert menu to include information that is automatically calculated (such as number of pages or date and time sent).
- 3 If you want to include text that always appears on your cover page (such as a letterhead or address), draw a box using the text box tool, type your text inside of it, then move the box to the appropriate place on your template.



- 4 If you want to include a logo that appears on your cover page, copy it to the Windows clipboard, then paste it into the Cover Page Editor and move it to the appropriate place on your template.
- 5 To save your cover page template, tap **File**, then tap **Save As**. The *Save As* dialog box opens with your personal cover pages folder already in the **Save in** list.
- 6 Type the new cover page template name.
- 7 Tap **Save**.



## Faxing from programs

### To fax a document directly from most programs:

- 1 Open your document in the program it was created in.
- 2 Tap **File**, then tap **Print**. The *Print* dialog box opens.
- 3 Tap the arrow button to open the **Name** list, then tap the **Fax** printer.
- 4 Tap **Print** or **OK**. The Send Fax Wizard opens.
- 5 Complete the wizard by following the instructions in “Sending a simple fax” on page 120.



## Faxing a scanned document

### To fax a document that you have scanned:

- 1 Scan the document using the program for your scanner.
- 2 With the scanned file open, tap **File**, then tap **Print**. The *Print* dialog box opens.
- 3 Tap the arrow button to open the **Name** list, then tap the **Fax** printer.

- 4 Tap **Print** or **OK**. The Send Fax Wizard opens.
- 5 Complete the wizard by following the instructions in “Sending a simple fax” on page 120.



## Receiving and viewing a fax

### To receive and view a fax:

- 1 Tap **Start**, **All Programs**, **Accessories**, **Communications**, **Fax**, then tap **Fax Console**. The Fax Console opens. When the Fax Console is open, it detects incoming faxes and stores them in the Inbox.
- 2 To view a fax, tap **Inbox**, then double-tap the fax you want to view. The fax viewer opens, where you can view and print the fax.



## Canceling a fax

You can cancel a fax that you have set up to send at a time in the future.

### To cancel a fax that has not been sent:

- 1 If Fax is not open, tap **Start**, **All Programs**, **Accessories**, **Communications**, **Fax**, then tap **Fax Console**. The Fax Console opens.
- 2 Tap **Outbox**, then button-tap the fax you want to cancel.
- 3 Tap **Delete** to cancel the fax.
- 4 Tap **Yes**.



# Automatically retry sending a fax

You can set up Fax so it continues to try sending your fax if the receiving fax machine is busy.

## Important



Fax is automatically set up to retry three times at ten minute intervals.

## To automatically retry sending a fax:

- 1 Tap **Start**, then tap **Control Panel**. The *Control Panel* window opens.
- 2 If your Control Panel is in Category View, tap **Printers and Other Hardware**. Tap **View installed printers or fax printers**. The *Printers and Faxes* window opens.  
-OR-  
If your Control Panel is in Classic View, double-tap the **Printers and Faxes** icon. The *Printers and Faxes* window opens.
- 3 Button-tap **Fax**, then tap **Properties**. The *Fax Properties* dialog box opens.
- 4 Tap the **Devices** tab, then tap **Properties**. The *Modem* dialog box opens.
- 5 Specify the number of retries and the amount of time between retries.
- 6 Tap **OK**.



# Automatically cancelling a fax

If your tablet PC tried to send a fax and failed to connect to a fax machine, you can automatically cancel a failed fax.

## To automatically cancel a failed fax:

- 1 Tap **Start**, then tap **Control Panel**. The *Control Panel* window opens.
- 2 If your Control Panel is in Category View, tap **Printers and Other Hardware**. Tap **View installed printers or fax printers**. The *Printers and Faxes* window opens.  
-OR-  
If your Control Panel is in Classic View, double-tap the **Printers and Faxes** icon. The *Printers and Faxes* window opens.
- 3 Button-tap **Fax**, then tap **Properties**. The *Fax Properties* dialog box opens.
- 4 Tap the **Devices** tab, then tap **Properties**. The *Modem* dialog box opens.
- 5 Tap the **Cleanup** tab.
- 6 Tap to select the **Automatically delete failed faxes after** check box and specify the number of days.
- 7 Tap **OK**.









# 8

## Managing Power

While your tablet PC is running on battery power, you should manage power consumption to get the most use out of the battery. Read this chapter to learn how to:

- Check and recharge the battery
- Change batteries
- Extend the life of the battery by conserving battery power and using alternate power sources
- Change power-saving settings



# Battery basics

A 6-cell lithium-ion prismatic battery comes installed in the Gateway Tablet PC. Fully charged, a new battery can power the tablet for several hours, depending on conditions and usage patterns.

Extra batteries are available through Motion. Use only Motion batteries in the Gateway Tablet PC.

Handle the battery with care. Do not open, puncture, short, or expose it to fire or water. Keep the battery in an ambient temperature of less than 140°F (60°C). Do not leave it in a closed car in hot weather.

## Monitoring the battery charge

Closely monitor the battery charge. When the battery charge gets low, change the battery or connect to AC power immediately to prevent losing any unsaved work.

Monitor the battery charge by any of the following ways.

### Power meter

Double-tapping the power cord icon  or battery icon  in the taskbar. The *Power Meter* dialog box opens.

#### Important



If the power cord or battery icon does not appear on the taskbar, tap the show hidden icons  button. If the icon still does not appear, make sure that **Always show icon on the taskbar** is checked on the Advanced tab. See “Changing advanced settings” on page 139 for more information.

## Battery status indicator

Looking at the battery status indicator. This indicator glows or flashes depending on the state of the battery:

Indicator	Meaning
Steady green	Battery charged (AC adapter plugged in)
Steady yellow	Battery charging (AC adapter plugged in)
Steady orange	Battery overheated or defective
Blinking green and orange	Battery discharging abnormally and should be replaced
Slow-blinking orange	Battery charge less than 10% (AC unplugged)
Fast-blinking orange	Battery charge less than 5% (AC unplugged)
Off	Battery discharged (AC unplugged) or battery removed

### Important



This indicator lights up only when the tablet PC is connected to AC power unless the tablet PC is in a very low power state. For the location of the battery status indicator, see "Button panel" on page 3.

## Battery status gauge

This gauge is on the battery on the back of the tablet, and its five lights each represent about 20 percent of available power. Read the gauge by pressing the button next to the LEDs.



Press here

## Low battery alarm

When Power Management issues a low-battery alarm (which it will do when the battery charge is 10% or less), save all work immediately and either connect to AC power or put the tablet in Standby and switch to a new battery.

### Important



When the battery reaches critical low capacity, the tablet puts itself into Hibernate to preserve data in any open programs.

# Recharging the battery

The battery recharges while it is installed and your tablet PC is connected to AC power. While the battery is recharging, the battery status indicator turns yellow and the battery icon in the taskbar has a lightning bolt .

### Important



If the power cord or battery icon does not appear on the taskbar, tap the show hidden icons  button. If the icon still does not appear, make sure that **Always show icon on the taskbar** is checked on the Advanced tab. See “Changing advanced settings” on page 139 for more information.

# Changing batteries

The battery may be changed while the tablet is turned on, even when the Gateway Tablet PC is not connected to an AC power source. Use only batteries obtained from Motion.

## Warning



Danger of explosion if battery is incorrectly replaced.

Replace only with a Gateway Tablet PC or Motion Tablet PC battery. Discard used batteries according to the manufacturer's instructions.

The battery used in this device may present a fire or chemical burn hazard if mishandled. Do not disassemble, heat above 212°F (100°C), or incinerate. Dispose of used battery promptly. Keep away from children.



## To change the battery:

- 1 If the tablet is turned on and is connected to AC power, go to Step 2.

-OR-

If the tablet is turned on and is not connected to AC power, save all active files, then place the tablet in Standby mode by tapping the **Standby** button in the Motion Dashboard. You may now switch batteries safely, but keep in mind that the tablet's internal battery can only hold the tablet in Standby for about thirty seconds when the battery is removed. Be sure to have a charged replacement battery close at hand before removing the first.



- 2 Push the battery release latch, then lift the battery away from the tablet.



- 3 Insert the new battery until it clicks into place.



After swapping batteries without connection to AC power, the internal battery needs to recharge for about three hours before it can support another battery swap.

# Extending battery life

## Conserving battery power

While using the battery to power your tablet PC, conserve power by:

- Modifying the power management settings for maximum power savings. For more information, see “Changing power settings” on page 135.
- Using Standby or Hibernate mode for maximum power savings while your tablet PC is not in use. For more information, see “Activating and using Hibernate mode” on page 140.
- Recharging the battery often, taking an extra battery, and fully recharging the batteries before traveling. For more information, see “Recharging the battery” on page 130 and “Changing batteries” on page 131.
- Keeping in mind that the display, processor, PC cards, wireless cards, and peripheral devices all draw on the battery, so adjust properties and disable unused devices and PC cards when operating on battery power.
- Using the optional diskette drive only when necessary. This drive uses a large amount of power.
- Before unplugging the AC adapter, adjust the power mode and display brightness to lower settings to prolong the battery’s charge. We recommend operating in Max Battery mode to prolong the battery’s charge—tap the taskbar’s **Power/Battery** icon to choose your power setting. For more information, see “Changing the power scheme” on page 136.
- Turning off the IEEE 802.11b wireless networking.

## Using alternate power sources

To extend battery life, use alternate power sources whenever possible.

- Use AC power whenever available to lengthen the battery’s usable life. Leave the battery in place when using AC.
- Use AC power when installing software, writing to a CD and, using the DVD player.
- If traveling internationally, take electrical adapters. Save the battery for times when you cannot use a power adapter. If you plan on taking your AC power adapter, also take a single-plug surge protector.

- If you will have access to an EmPower™ in-flight power receptacle or an automobile cigarette lighter, use an airplane/automobile power adapter or power inverter. Save the battery for times when you cannot use a power adapter.
- To find AC power outlets in airports, look for them next to support pillars, in large areas such as boarding gates, and under banks of telephones.

## Changing power modes

You can use the following power modes to lengthen the life of your tablet PC's battery:

- *Standby* - while your tablet PC is in Standby, it switches to a low power state where devices, such as the display and drives, turn off.
- *Hibernate* - (also called *save to disk*) writes all current memory (RAM) information to the hard drive, then turns your tablet PC completely off. The next time you turn on your tablet PC, it reads the memory information from the hard drive and opens the programs and documents that were open when you activated Hibernate mode. For more information on using Hibernate mode, see “Activating and using Hibernate mode” on page 140.

## Using power saving modes

Always save your work before using Standby mode. In Standby mode, your tablet PC reduces or turns off the power to most devices except memory. However, the information in memory is not saved to the hard drive. If power is interrupted, the information is lost.

When in Hibernate mode, your tablet PC saves all memory information to the hard drive, then turns the power completely off.

If your tablet PC is...	...and you want to...	...then
On	Enter Standby mode	Tap <b>Start, Turn Off Computer</b> , then tap <b>Standby</b> .
On	Enter Hibernate mode (must be activated)	Tap <b>Start</b> , then tap <b>Turn Off Computer</b> . Press and hold <b>SHIFT</b> , then tap <b>Hibernate</b> .
In Standby or Hibernate mode	Exit Standby or Hibernate mode	Slide the power switch.



# Changing power settings

You can change the function of the power switch, Standby system key, and power-saving timers by changing power settings on your tablet PC.

You can customize power settings from the Windows Control Panel by selecting power schemes, setting power alarms, adjusting advanced power settings, and activating Hibernate mode.

*Power schemes* (groups of power settings) let you change power saving options such as when the display or hard drive is automatically turned off. You can select one of the defined power schemes or create a custom power scheme.

The processor installed in your tablet PC may use Intel® SpeedStep™ technology to conserve battery power. A SpeedStep-equipped processor can change its operating speed according to the power source. Your tablet PC's default settings operate the processor at full speed while connected to AC power and at reduced speed (which uses less power) while using battery power. Power schemes also set the speed of an Intel® SpeedStep™-equipped processor.

*Alarms* can alert you when the battery charge is low.

*Advanced power settings* let you assign different power saving modes to the power switch and Standby system key.

## Changing the power scheme

▶ To change the power scheme:

- 1 Tap **Start**, then tap **Control Panel**. The *Control Panel* window opens. If your Control Panel is in Category View, tap **Performance and Maintenance**. Tap/Double-tap the **Power Options** icon. The *Power Options Properties* dialog box opens.

-OR-

Button-tap the **Power/Battery** icon in the taskbar, then tap **Adjust Power Properties**. The *Power Options Properties* dialog box opens.



- 2 Tap the arrow button to open the **Power Schemes** list, then tap the power scheme you want.

- OR -

Set the timers, then tap **Save As** and type a name for the scheme.

- 3 Tap **OK**.



**Help and Support**

For more information about changing the power scheme, tap **Start**, then tap **Help and Support**.

Type the keyword **power scheme** in the Help and Support Center **Search** box  , then tap the arrow.

## Changing alarm options

### ▶ To change the alarm options:

- 1 Tap **Start**, then tap **Control Panel**. The *Control Panel* window opens. If your Control Panel is in Category View, tap **Performance and Maintenance**. Tap/Double-tap the **Power Options** icon. The *Power Options Properties* dialog box opens.

-OR-

Button-tap the **Power/Battery** icon in the taskbar, then tap **Adjust Power Properties**. The *Power Options Properties* dialog box opens.

- 2 Tap the **Alarms** tab.

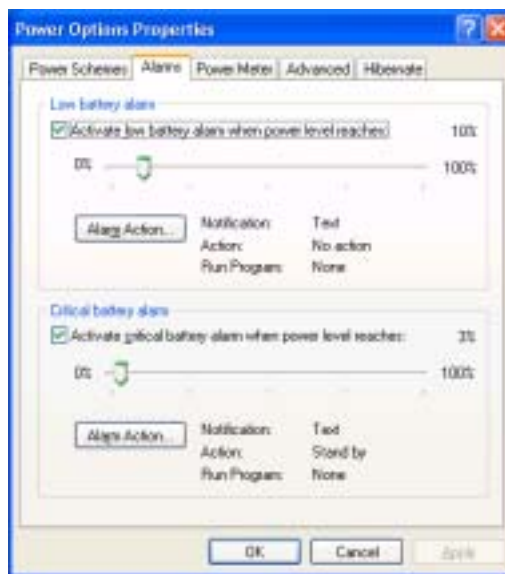

**3** Adjust the alarm settings.

**4** Tap **OK**.



**Help and Support**



For more information about changing the alarm options, tap **Start**, then tap **Help and Support**.

Type the keyword **alarm options** in the Help and Support Center **Search** box  , then tap the arrow.

## Changing advanced settings

### ▶ To change advanced power management settings:

**1** Tap **Start**, then tap **Control Panel**. The *Control Panel* window opens. If your Control Panel is in Category View, tap **Performance and Maintenance**. Tap/Double-tap the **Power Options** icon. The *Power Options Properties* dialog box opens.

-OR-

Button-tap the **Power/Battery** icon in the taskbar, then tap **Adjust Power Properties**. The *Power Options Properties* dialog box opens.

**2** Tap the **Advanced** tab.



**3** Tap the arrow button to open a **Power buttons** list, then tap the power setting mode you want to use.

**4** Tap **OK**.



**Help and Support**



For more information about changing the power management settings, tap **Start**, then tap **Help and Support**.

Type the keyword **power management** in the Help and Support Center **Search** box  , then tap the arrow.

## Activating and using Hibernate mode

 **To activate Hibernate mode:**

- 1 Tap **Start**, then tap **Control Panel**. The *Control Panel* window opens. If your Control Panel is in Category View, tap **Performance and Maintenance**. Tap/Double-tap the **Power Options** icon. The *Power Options Properties* dialog box opens.

-OR-

Button-tap the **Power/Battery** icon in the taskbar, then tap **Adjust Power Properties**. The *Power Options Properties* dialog box opens.

- 2 Tap the **Hibernate** tab.

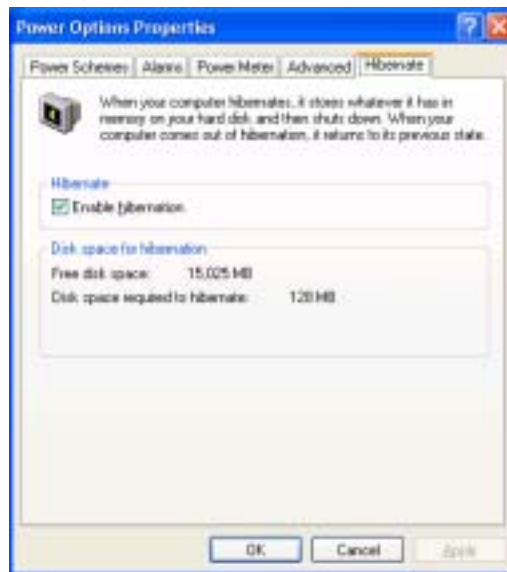

- 3** Tap the **Enable hibernation** check box, then tap **Apply**. *Hibernate* mode is now an option you can select on the **Advanced** tab in the **Power Options Properties** dialog box and in the *Turn Off Computer* dialog box.



 **To use Hibernate mode:**

- As an automatic power savings mode:

Open the *Power Options Properties* dialog box, then tap the **Power Schemes** tab. Tap the arrow button to open a **System hibernates** list, then tap the time you want to use.

- OR -

Open the *Power Options Properties* dialog box, then tap the **Advanced** tab. *Hibernate* is now an option in the **Power buttons** lists.

- As a manually-selected power savings mode:

Tap **Start**, then tap **Turn Off Computer**. Press and hold **SHIFT**, then tap **Hibernate**.



**Help and Support**



For more information about using Hibernate mode, tap **Start**, then tap **Help and Support**.

Type the keyword **hibernate** in the Help and Support Center **Search** box Search  , then tap the arrow.







# 9

## Travel Tips

These tips can make traveling with your tablet PC more convenient and trouble-free. Read this chapter to learn about:

- Using the modem
- Using your radio frequency wireless connections
- Transferring files
- Protecting your tablet PC from loss and theft
- Managing your tablet PC's power efficiently

### Tips & Tricks



To access the contents of this guide while you are traveling, tap **Start, All Programs**, then tap **Gateway Documentation**. You can also download an electronic copy from [support.gateway.com/support/manlib/](http://support.gateway.com/support/manlib/).



## Packing your tablet

- Remove all peripheral devices and cables. Remember to pack those you will need while traveling, and do not forget to pack at least one tablet pen.
- Attach the Hard Top or slip the Gateway Tablet PC into its portfolio to protect the display.
- Protect the pen by keeping it in the tablet's pen holder during travel.
- Pack the Gateway Tablet PC securely into a briefcase or hand-carried luggage, and keep it separate from toiletries, liquids, and food. Do not pack it in checked luggage.
- Keep the tablet stable during travel. Secure it to prevent it from sliding around in overhead bins and car trunks.

## Traveling by air

- Prepare for airport security by charging the battery in case Security asks you to start the tablet.
- Have it hand-inspected or sent through the X-ray scanner, but never carry it through the metal detector.
- Turn off the tablet for takeoff and landing.
- Do not check the tablet as baggage.

## Modem

- Take a telephone cord to connect the modem to telephone jacks. If you are traveling internationally, take telephone jack adapters or an acoustic handset coupler.
- Take a telephone line protector.
- Take a telephone line tester to check for unsafe lines, especially if you are traveling internationally.
- Take remote access information with you so you can connect to your ISP while outside of your usual calling area. A list of country dialing codes may be especially useful if you are traveling internationally.

# Radio frequency wireless connections

- Every country has different restrictions on the use of wireless devices. Check with the local radio approval authorities prior to your trip for any restrictions on the use of a wireless device in the destination country.
- See “Safety, Regulatory, and Legal Information” on page 267 for general wireless regulatory guidelines.
- Wireless communication can interfere with equipment on commercial aircraft. Current aviation regulations require wireless devices to be turned off while traveling in an airplane. IEEE 802.11a, IEEE 802.11b, and IEEE 802.11g communication devices are examples of devices which use wireless to communicate. For instructions on how to turn off your wireless device, see “Turning your wireless Ethernet on or off” on page 177.

## Files

- Copy your working files from your desktop computer to your tablet PC before you travel.
- If you need to access your desktop computer files from your tablet PC while traveling, set up your desktop computer for remote access. Contact your network administrator for more information about remote access.
- Take extra diskettes or recordable CDs for transferring files between computers and backing up files.

# Security

- Get a locking cable for your tablet PC so you can attach a cable lock and leave your tablet PC in your hotel room while you are away.
- Always keep your tablet PC with you while waiting in airports, train stations, or bus terminals. Be ready to claim your tablet PC as soon as it passes through the x-ray machine in security checkpoints.
- Write down your tablet PC model number and serial number (see “Identifying your model” on page 11) in case of theft or loss, and keep the information in a safe place. Also, tape your business card or an address label to your tablet PC and accessories.
- Whoever sits next to you or behind you can see your tablet PC display. Avoid working with confidential files until you can be sure of privacy.
- Use a startup password to restrict access to your tablet PC.

## Important



Use a password that you can remember, but that is difficult for someone else to guess. The password feature is very secure, with no easy way to recover a forgotten password. If you forget your password, you must return your tablet PC to Gateway for service. Call Gateway Technical Support for instructions.



## To create a startup password:

- 1 Restart your tablet PC. As soon as you see a startup screen, press Hot Key 2 . The BIOS Setup utility opens.
- 2 Open the **Security** menu.
- 3 Highlight **Set System Password**, then press **ENTER** and follow the instructions.
- 4 Highlight **Password on boot**, then press **ENTER**.
- 5 Highlight **Enabled**, then press **ENTER**.
- 6 Open the **Exit** menu, highlight **Exit Saving Changes**, then press **ENTER**. When you start your tablet PC, you are prompted to enter the password you set.



# Power

- Take your AC power adapter to recharge the battery. If you are traveling internationally, take power plug adapters. A current converter is not necessary.
- Take a portable surge protector to protect your tablet PC from power surges.
- To get the best performance from your tablet PC, avoid using the battery whenever possible, monitor the battery charge, and use the most efficient power management settings.
  - For information on conserving battery power, see “Conserving battery power” on page 133.
  - For information on using alternate power sources, see “Using alternate power sources” on page 133.
  - For information on monitoring the battery charge, see “Monitoring the battery charge” on page 128.

## Additional tips

- If you plan to use several USB peripheral devices, take a portable USB hub to provide additional USB ports.
- Take a network cable if you need to connect to a network. Some hotels provide Internet connectivity only through their networks.
- If your tablet PC has been exposed to cold temperatures, allow it to warm to room temperature before turning it on.
- Carry proof of ownership or a merchandise passport when traveling internationally.
- Consult your insurance company and credit card company to learn about emergency travel assistance if your tablet is lost or damaged.
- Take the optional DVD/CD-RW drive, its cables, and its power adapter in case you need to install software. Take your *System Restoration CDs* in case you need to install an additional driver, software, or the operating system.





# Customizing Your Tablet PC

# 10

This chapter provides information about customizing your tablet PC by changing settings in Windows or the Dashboard. Read this chapter to learn how to:

- Change screen and display settings
- Change the background and screen saver
- Adjust the touchpad settings
- Add, change, and switch user accounts



# Using the display

## Changing display orientation

You can change the display orientation from the default, landscape (horizontal), to portrait (vertical) or secondary landscape (180 degrees from the default) with either Hot Key 1 or Hot Key 2.

### To change display orientation:

- Press Hot Key 2  to scroll through display options.

- OR -

To use the Motion Dashboard, press Hot Key 1 , then tap the orientation you want in the **Display Orientation** section.



### To change orientation properties:

- Double-tap the **Tablet and Pen Settings** icon  in the taskbar, then tap the **Display** tab.



## Adjusting brightness

### To adjust screen brightness:

- Press Hot Key 1  to open the Dashboard, then drag the **Display Brightness** slider to the level you want.

- OR -

Double-tap the **Tablet and Pen Settings** icon  in the taskbar, then tap the **Display** tab. Click the arrow button to open the **Settings for** list, then click the power scheme you are adjusting. Drag the **Brightness** slider to the level you want.





# Adjusting the screen and desktop settings

Adjusting the color depth and screen area are two of the most basic display settings you may need to change. You can also adjust settings such as the screen background and screen saver.

## Adjusting the color depth

*Color depth* is the number of colors your screen displays. Various image types require various color depths for optimum appearance. For example, simple color drawings may appear adequately in 256 colors while color photographs need millions of colors to be displayed with optimum quality.

Windows lets you choose from several color depth settings. We recommend that you use the 32-bit True Color setting at all times.

If the color in your images seems “false” or “jumpy,” especially after you have played a game or run a video-intensive program, check the color depth setting and return it to 32-bit True Color, if necessary.



### To change the color depth:

- 1 Tap **Start**, then tap **Control Panel**. The *Control Panel* window opens. If your Control Panel is in Category View, tap **Appearance and Themes**.
- 2 Tap/Double-tap the **Display** icon. The *Display Properties* dialog box opens.



**3** Tap the **Settings** tab.



**4** Tap the arrow button to open the **Color quality** list, then tap the color depth you want.

**5** To save your changes, tap **OK**, then tap **Yes**.



**Help and Support**



For more information about adjusting display settings, tap **Start**, then tap **Help and Support**.

Type the keyword **changing display settings** in the Help and Support Center **Search** box  **Search** , then tap the arrow.

## Adjusting the screen resolution

You can increase the screen resolution to fit more icons on your desktop, or you can decrease the resolution to make reading the display easier. The higher the resolution, the smaller individual components of the screen (such as icons and menu bars) appear.

▶ **To adjust the screen resolution:**

- 1 Tap **Start**, then tap **Control Panel**. The *Control Panel* window opens. If your Control Panel is in Category View, tap **Appearance and Themes**.
- 2 Tap/Double-tap the **Display** icon. The *Display Properties* dialog box opens.
- 3 Tap the **Settings** tab.



- 4 Drag the **Screen resolution** slider to the size you prefer.
- 5 To save your changes, tap **OK**, then tap **Yes**.



**Help and Support**



For more information about adjusting screen resolution, tap **Start**, then tap **Help and Support**.

Type the keyword **changing screen resolution** in the Help and Support Center **Search** box

Search  , then tap the arrow.

## Changing the colors on your Windows desktop

You can change the colors of Windows desktop items, such as the background color and dialog box title bars.

### To change desktop colors:

- 1 Tap **Start**, then tap **Control Panel**. The *Control Panel* window opens. If your Control Panel is in Category View, tap **Appearance and Themes**.
- 2 Tap/Double-tap the **Display** icon. The *Display Properties* dialog box opens.
- 3 Tap the **Appearance** tab.



- 4 Tap the arrow button to open the **Color scheme** list, tap the color scheme you want, then tap **OK**. The new colors appear on your desktop.

- OR -

If you want to create a new color scheme as part of a desktop theme:

- a Tap **Advanced**. The *Advanced Appearance* dialog box opens.
- b Tap the arrow button to open the **Item** list, then tap the item you want to change.
- c Change the color or font settings for the item.
- d Tap **OK**, then tap the **Themes** tab.
- e Tap **Save As**, type a name for the new theme, then tap **OK** twice. The new colors appear on your desktop.



## Changing the desktop background

You can change the Windows desktop background picture. Windows provides several backgrounds, or you can use pictures that you have created or retrieved from other sources.



**To change the desktop background:**

- 1 Tap **Start**, then tap **Control Panel**. The *Control Panel* window opens. If your Control Panel is in Category View, tap **Appearance and Themes**.
- 2 Tap/Double-tap the **Display** icon. The *Display Properties* dialog box opens.



**3** Tap the **Desktop** tab.



**4** Tap a background picture in the **Background** list.

- OR -

Tap **Browse** to select a background picture from another location.

**5** If you want the picture you chose to cover the entire screen, tap the arrow button to open the **Position** list, then tap **Stretch** or **Tile**.

**6** If the picture you chose does not cover the entire screen and you did not choose to stretch or tile the image in Step 5, you can change the solid color behind the picture by tapping the arrow button to open the **Color** list, then tapping a color.

**7** Tap **OK**.



**Help and Support**



For more information about changing the desktop background, tap **Start**, then tap **Help and Support**.

Type the keyword **changing desktop background** in the Help and Support Center **Search** box

Search  , then tap the arrow.

## Selecting a screen saver

You can use a screen saver to keep others from viewing your display while you are away from your tablet PC. Windows supplies a variety of screen savers that you can choose from, and many more are available from the Internet and as commercial products.

### ▶ To select a screen saver:

- 1 Tap **Start**, then tap **Control Panel**. The *Control Panel* window opens. If your Control Panel is in Category View, tap **Appearance and Themes**.
- 2 Tap/Double-tap the **Display** icon. The *Display Properties* dialog box opens.
- 3 Tap the **Screen Saver** tab.



- 4 Tap the arrow button to open the **Screen Saver** list, then tap the screen saver you want. Windows previews the screen saver.
- 5 If you want to customize the screen saver, tap **Settings**, then make your changes. If the Settings button is not available, you cannot customize the screen saver you selected.



- 6 If you want to display the Welcome (Login) screen whenever you exit the screen saver, tap the **On resume, display Welcome screen** check box.
- 7 If you want to change the time before the screen saver is activated, tap the up or down arrows next to the **Wait** box.
- 8 Tap **OK**.



#### Help and Support



For more information about selecting a screen saver, tap **Start**, then tap **Help and Support**.

Type the keyword **screen savers** in the Help and Support Center **Search** box  , then tap the arrow.

## Adjusting tablet and pen settings

Windows XP Tablet PC Edition includes a control panel for adjusting pen, display, and button preferences such as:

- Right-handed vs. left-handed use
- Pen calibration in portrait and landscape modes
- Screen brightness
- Button functions
- Pen actions such as double-tapping



### To change tablet and pen settings:

- 1 Double-tap the **Tablet and Pen Settings** icon  in the taskbar. The *Tablet and Pen Properties* dialog box opens.
- 2 Tap the **Pen Options** tab.
- 3 Change the pen options settings, then tap **OK**.





# Programming the buttons

Most of the buttons on the tablet's front can be reprogrammed with new functions and secondary functions.

## To reprogram button functions:

- 1** Double-tap the **Tablet and Pen Settings** icon  in the taskbar. The *Tablet and Pen Properties* dialog box opens.
- 2** Tap the **Tablet Buttons** tab.
- 3** Change the button settings, then tap **OK**.



# Using the Motion Dashboard

The Motion Dashboard can act as a control panel, a status display, and a program launcher.



From Dashboard you can:

- Open the *Motion Welcome Page* for helpful information any time
- Adjust the Gateway Tablet PC's volume, power, and display options
- Check tablet status readings
- Turn on wireless operations
- Open programs
- Reprogram Hot Keys

## To open the Motion Dashboard:

- Press Hot Key 1 .



Properties adjust as soon as you change them.

<b>This feature:</b>	<b>Does this:</b>
Speaker Volume	Adjusts or mutes the volume of the Gateway Tablet PC's audio output: built-in speakers, external speakers, or headphones.
Display Brightness	Adjusts the display's brightness level.
Calibrate	Opens the Pen Calibration utility.
Display Rotation	Changes the display's orientation.
Graphics Properties	Adjusts the display properties for an external monitor.
Properties	Opens the <i>Power Management Properties</i> dialog box.
Power Scheme	Provides access to Power Schemes.
Power Button	Adjusts the function of the Power Switch.
Wireless Operation	Turns the mini-PCI wireless network feature on or off.
Battery	Displays battery status.
Wireless Status	Displays the status and strength of the optional wireless LAN's signal.
Quick Keys	Performs the keyboard equivalent of various keystrokes.
Shortcuts	Provides shortcut access to designated software programs.
Display Keyboard	Opens the on-screen Tablet Input Panel for typing, writing, and voice input.
Stand By	Puts the tablet in Standby mode for safe battery swapping or temporary suspension.

# Using speech recognition

The Gateway Tablet PC is designed to accept and interpret the human voice, both for dictation (speech recognition) and for keyboard-equivalent voice commands.

- Set up speech recognition through the Tablet PC Input Panel's **Tools** menu.
- Learn more about voice commands in the **Accessibility** section of the Help and Support Center.
- Use the built-in microphone or connect an external microphone.

# Adding and modifying user accounts

You can create and customize a user account for each person who uses your tablet PC. You can also *switch* (change) user accounts without turning off your tablet PC.

## User account tips

- If you want to create an account for someone, but you do not want that user to have full access to your tablet PC, be sure to make that account *limited*. Remember that limited accounts may not be able to install some older programs.
- If a program or peripheral device is installed in one account, it may not be available in other accounts. If this happens, install the program or device in the accounts that need it.
- Files created in one account are not accessible from other accounts unless the files are stored in the *Shared Documents* folder. The Shared Documents folder is accessible from all accounts on that tablet PC and from other computers on the network.

▶ **To add, delete, or modify user accounts:**

- 1 Tap **Start**, then tap **Control Panel**.
- 2 Tap/Double-tap the **User Accounts** icon. The *User Accounts* window opens.
- 3 Follow the on-screen instructions to add, delete, or modify a user account.



**Help and Support**



For more information about user accounts, tap **Start**, then tap **Help and Support**.

Type the keyword **user accounts** in the Help and Support Center **Search** box  , then tap the arrow.

▶ **To switch user accounts:**

- 1 Tap **Start**, then tap **Log Off**. The *Log Off Windows* dialog box opens.

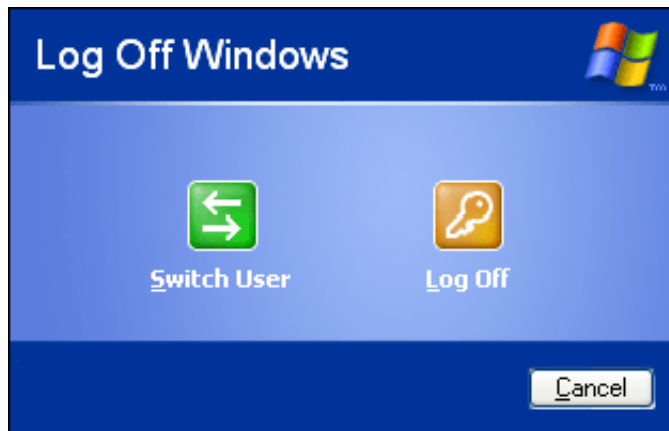

- 2 Tap **Switch User**. The Windows *Welcome* screen opens.
- 3 Tap the user account that you want to use. When you switch between user accounts, any programs that were running for the previous user continue to run.







# Networking Your Tablet PC

# 11

Connecting your home, small office, or home office computers lets you share drives, printers, and a single Internet connection among the connected computers.

Read this chapter to learn about:

- Benefits of using a network in your home, small office, or home office
- Types of network connections
- Purchasing additional network equipment
- Installing and configuring your tablet PC for Ethernet networking
- Turning wireless Ethernet on and off



# Benefits of networking

A network lets you:

- Share a single Internet connection
- Share computer drives
- Share peripheral devices
- Stream audio and video files
- Play multi-player games

## Sharing a single Internet connection

Each computer that is connected to the network can share the same broadband connection or modem and telephone line and access the Internet at the same time. This saves on the cost of installing another telephone line for your second computer and paying for a second Internet service provider (ISP) account.

**Help and Support**



For more information about sharing an Internet connection, tap **Start**, then tap **Help and Support**.

Type the keyword **internet sharing** in the Help and Support Center **Search** box  , then tap the arrow.

## Sharing drives

With a network, you can copy files from computer to computer by copying and pasting or dragging and dropping. You will no longer waste your time transferring files by using diskettes. In addition, you can *map* a drive on a networked computer to another computer, and access the files as if they were located on the hard drive of the computer you are using.

**Help and Support**



For more information about sharing network drives, tap **Start**, then tap **Help and Support**.

Type the keyword **sharing network drives** in the Help and Support Center **Search** box  , then tap the arrow.



## Sharing peripheral devices

Each computer that is connected to the network can share the same peripheral devices, such as a printer. Select print from the computer you are currently using and your file is automatically printed on your printer no matter where it is located on your network.

### Help and Support



For more information about sharing network devices, tap **Start**, then tap **Help and Support**.

Type the keyword **sharing** in the Help and Support Center **Search** box  , then tap the arrow.

## Streaming audio and video files

With a network, you can store audio files (such as the popular .MP3 files) and video files on any networked computer, then play them on any of the other computers or devices connected to your network. This process is called *streaming*.

### Help and Support



For more information about streaming files, tap **Start**, then tap **Help and Support**.

Type the keyword **streaming** in the Help and Support Center **Search** box  , then tap the arrow.

## Playing multi-player games

With a home network, you can play multi-player games. Load a game like *Microsoft Midtown Madness 2* on your computers, and in minutes, you and your friends can race in competing cars through the streets of San Francisco.

### Help and Support



For more information about playing multi-player games, tap **Start**, then tap **Help and Support**.

Type the keyword **games** or **network games** in the Help and Support Center **Search** box  , then tap the arrow.

# Selecting a network connection

The biggest decision you need to make when creating your network is what type of connection you will use. Gateway supports both wired and wireless Ethernet networks. Use the following criteria as a guide when selecting a network connection.

## Wired Ethernet network

Create a wired Ethernet network if:

- You are building a new home or your existing home already has Ethernet cable installed in each room that has a device you want to connect
- You are creating a network in an office or business where network speed is more important than moving about with your computer
- Your computer has an Ethernet jack for connecting to the network

## Wireless Ethernet network

Create a wireless Ethernet (IEEE 802.11a, IEEE 802.11b, or IEEE 802.11g) network if:

- You are looking for an alternative to installing cable for connectivity
- The ability to move about with your computer is as important as network speed
- Your computer has wireless Ethernet for networking

### Help and Support



For more information about selecting network connections, tap **Start**, then tap **Help and Support**.

Type the keyword **networks** or **network types** in the Help and Support Center **Search** box

**Search**  , then tap the arrow.

# Using a wired Ethernet network

A wired Ethernet network consists of two or more computers connected together through an Ethernet cable. This connection type is commonly used in offices around the world and can be used to build computer networks in the home.

## Ethernet, Fast Ethernet, or Gigabit Ethernet

Ethernet is available at three different speeds. Standard Ethernet runs at 10 Mbps, Fast Ethernet runs at 100 Mbps, and Gigabit Ethernet runs at 1000 Mbps. Most home networks are built using Standard or Fast Ethernet components. Business networks are typically built using Fast or Gigabit Ethernet components.

To create a wired Ethernet network, you or your electrician must:

- Install special Ethernet cables in your home or office

### Important



Check local code requirements before installing Ethernet cable or other wiring in your home or office. Your municipality may require you to obtain a permit and hire a licensed installer.

- Install an Ethernet card in each of your desktop computers (if your computers do not already have built-in Ethernet jacks)
- Install an Ethernet PC Card in each of your notebooks (if your notebooks do not already have built-in Ethernet jacks)
- Install an Ethernet *router*, *switch*, or *hub*

### Tips & Tricks



If you are connecting just two computers, you can eliminate the router, switch, or hub and use a special *crossover* cable.

## Example wired Ethernet network

The following is an example of a wired Ethernet network. The network is made up of a router, a cable or DSL modem, your computers, and cables connecting each of these components. The router is the central control point for the network. Attached to the router are all of your computers or Ethernet-ready devices. Also connected to the router is a cable or DSL modem that provides access to the Internet.



### Tips & Tricks



To add the ability to access a wireless Ethernet network to your wired Ethernet network, connect an access point to the router, switch, or hub. For more information about accessing a wireless Ethernet, see "Using a wireless Ethernet network" on page 172.

# Equipment you need for a wired Ethernet network

For a wired Ethernet network you need:

- An Ethernet jack on each desktop computer, notebook, and tablet PC.  
- OR -  
An Ethernet card installed in each desktop computer.  
- OR -  
An Ethernet PC Card installed in each notebook.
- An Ethernet router. Select a router that gives you the following features:
  - A jack for connecting to a cable or DSL modem.
  - The ability to assign IP addresses to your networked computers dynamically. This prevents intruders from seeing the computers over the Internet.
  - A built-in *firewall* to protect the computers on your network from intruders trying to access your data over the Internet.
  - Built-in switching (with enough ports for all computers and devices on the network) so you will not have to purchase a hub or switch.
- If you did not purchase a router that includes built-in switching or if the router does not have enough ports to attach all your computers, an Ethernet hub or switch with enough ports for all computers and devices in the network.
- Ethernet cable going from each computer to the router, hub, or switch.

## Important



For best results, all Ethernet components should be either standard Ethernet (10 Mbps), Fast Ethernet (100 Mbps or 10/100), or Gigabit Ethernet (1000 Mbps or 10/100/1000). A mixture of components rated at different speeds will result in your network running at the speed of the slowest rated component.

# Using a wireless Ethernet network

A wireless Ethernet network is ideal for creating a home or office network or adding mobility to an existing wired Ethernet.

## Warning



Radio frequency wireless communication can interfere with equipment on commercial aircraft. Current aviation regulations require wireless devices to be turned off while traveling in an airplane. IEEE 802.11a, IEEE 802.11b, and IEEE 802.11g communication devices are examples of devices that provide wireless communication. For instructions to turn wireless Ethernet on and off, see “Turning your wireless Ethernet on or off” on page 177.

## Important



See “Safety, Regulatory, and Legal Information” on page 267 for general wireless regulatory and safety guidelines.

Wireless Ethernet is available at two different speeds. IEEE 802.11a and IEEE 802.11g wireless Ethernet run at speeds up to 54 Mbps, or about half the speed of Fast Ethernet. 802.11b wireless Ethernet runs at speeds up to 11 Mbps, or approximately the same speed as standard wired Ethernet. This type of network allows you the freedom to move about your home or office with your tablet PC. For example, you can take your tablet PC from your home office to your patio without having an Ethernet jack available.

## Important



The speed of a wireless network is related to signal strength. Signal strength is affected by the distance between your wireless network devices, by radio interference, and by interference from natural obstructions such as walls, floors, and doors.

The two most common types of wireless Ethernet networks are access point and peer-to-peer.

## Example access point wireless Ethernet network

By using an *access point*, you can join a wireless Ethernet network and access a wired Ethernet network. An access point also lets you access the Internet.

The following is an example of an access point wireless Ethernet network. The network is made up of an access point, a cable or DSL modem, and your computers. The access point is the central control point for the network. Attached to the access point is the cable or DSL modem that provides access to the Internet. Each of the computers or Ethernet-ready devices communicate with the access point using radio waves. If your computer does not have built-in wireless Ethernet capabilities, you need to add a wireless PCI card (desktop), PC card (notebook), or USB adapter.

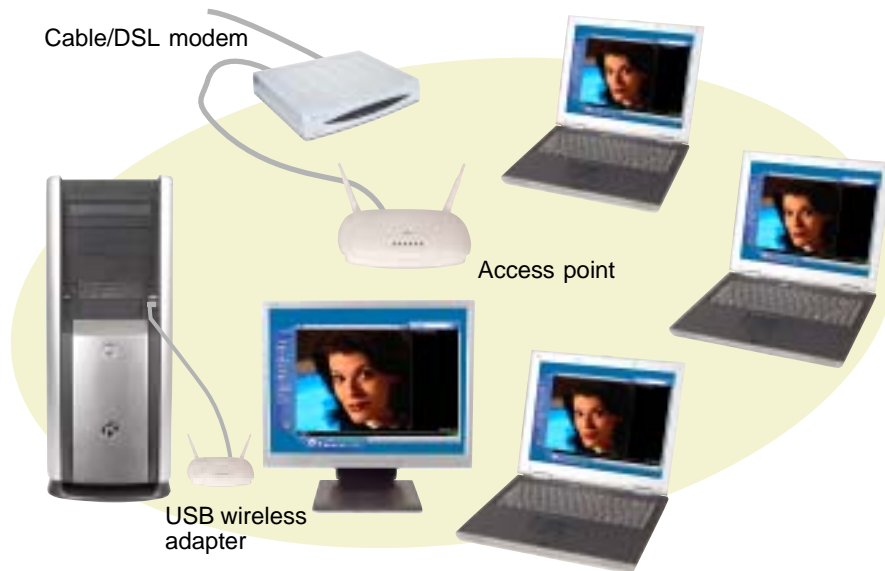

### Tips & Tricks



If you want to access a wireless Ethernet network from your wired Ethernet network, connect an access point to the router, switch, or hub. For more information about accessing a wired Ethernet, see “Using a wired Ethernet network” on page 169.

## Equipment you need for an access point wireless Ethernet network

For an access point wireless Ethernet network you need:

- A wireless Ethernet PCI card installed in each desktop computer
  - OR -
  - A wireless Ethernet USB adapter attached to each desktop computer
  - OR -
  - A notebook or tablet PC with wireless Ethernet built-in
  - OR -
  - A wireless Ethernet PC Card installed in each notebook that does not have wireless Ethernet built-in
- A wireless Ethernet access point to connect your wireless Ethernet network to the Internet or a wired Ethernet network

### Important



IEEE 802.11b and IEEE 802.11g use the same radio frequency. IEEE 802.11a uses a different radio frequency than IEEE 802.11b and IEEE 802.11g. All wireless Ethernet components should use the same frequency. A combination of IEEE 802.11a and IEEE 802.11b or IEEE 802.11a and IEEE 802.11g components will not work. Some wireless devices can broadcast and receive signals on both frequencies.

A mixture of IEEE 802.11b and IEEE 802.11g components will result in your network running at the speed of the slower IEEE 802.11b components.



## Example peer-to-peer wireless Ethernet network

Use a peer-to-peer (also known as ad hoc) wireless Ethernet network if you are setting up or joining a temporary computer-to-computer network. This type of network does not include access into a wired network or the Internet. You can create this type of network to quickly move files from one computer to another.



## Equipment you need for a peer-to-peer wireless Ethernet network

For a peer-to-peer wireless Ethernet network you need:

- A wireless Ethernet PCI card installed in each desktop computer

- OR -

A wireless Ethernet USB adapter attached to each desktop computer

- OR -

A notebook or tablet PC with wireless Ethernet built-in

- OR -

A wireless Ethernet PC Card installed in each notebook that does not have wireless Ethernet built-in

## For more information

For more information about purchasing equipment for your home or office Ethernet network, discuss your particular needs with your Gateway store representative. In addition, several books and Internet sites are dedicated to networking. See these sources for more information about networking your home or office with wired or wireless Ethernet.

### Help and Support



For more information about networking, tap **Start**, then tap **Help and Support**.

Type the keyword **networking** in the Help and Support Center **Search** box  , then tap the arrow.

# Using your tablet PC on a network

## Installing and configuring your tablet PC for Ethernet networking

A guide in .PDF format has been included on your hard drive that provides instructions for installing and configuring both wired and wireless Ethernet networking on your tablet PC. To access this guide, tap **Start, All Programs**, then tap **Gateway Documentation**.

## Turning your wireless Ethernet on or off

### Warning



Radio frequency wireless communication can interfere with equipment on commercial aircraft. Current aviation regulations require wireless devices to be turned off while traveling in an airplane. IEEE 802.11a, IEEE 802.11b, and IEEE 802.11g communication devices are examples of devices that provide wireless communication.

### Important



When using wireless connectivity in low-reception areas, be sure to keep your hands clear of the antenna zones.

### To turn wireless Ethernet on or off using the Dashboard:

- 1 Press Hot Key 1  to open the Dashboard.
- 2 To turn wireless Ethernet on, tap to check the **Wireless Operation** check box.

-OR-

To turn wireless Ethernet off, tap to clear the **Wireless Operation** check box.



See “Using the Motion Dashboard” on page 160 for more information.



### To turn wireless Ethernet on or off using Windows XP:

- 1 Tap **Start**, then tap **Control Panel**. The *Control Panel* window opens. If your Control Panel is in Category View, tap **Network and Internet Connections**. The *Network and Internet Connections* window opens.
- 2 Tap/Double-tap **Network Connections**. The *Network Connections* window opens.
- 3 Button-tap **Wireless Network Connection**, then tap **Enable** to turn on wireless Ethernet or tap **Disable** to turn off wireless Ethernet.





# Moving from Your Old Computer

# 12

If your new tablet PC is replacing an old computer, you may have personal data files, Internet settings, a printer or other peripheral devices, and other unique computer settings that you want to move from your old computer to your new one. Read this chapter to learn about:

- Using the Files and Settings Transfer Wizard
- Transferring Files
- Transferring Internet Settings
- Installing your old printer or scanner
- Installing your old programs



# Using the Files and Settings Transfer Wizard

You can move your data files and personal settings, such as display, Internet, and e-mail settings, from your old computer to your new one by using the Files and Settings Transfer Wizard. The wizard also moves specific files or entire folders, such as My Documents, My Pictures, and Favorites.

## To open the Files and Settings Transfer Wizard:

- Tap **Start, All Programs, Accessories, System Tools**, then tap **Files and Settings Transfer Wizard**.



### Help and Support



For more information about using the Files and Settings Transfer Wizard, tap **Start**, then tap **Help and Support**.

Type the keyword **using transfer wizard** in the Help and Support Center **Search** box  , then tap the arrow.

# Transferring files

You can manually transfer your personal data files by copying them to removable media, such as a diskette, writable CD, or Zip disk, or by using a network. For more information, see “Creating CDs” on page 100 and “Networking Your Tablet PC” on page 165.

## Finding your files

Many programs automatically save your personal data files in the My Documents folder. Look in your old computer’s My Documents folder for personal data files. Use Windows Find or Search to locate other personal data files. For more information, see “To find files using Find or Search:” on page 182, or see “Searching for files” on page 68.

### To find files in the My Documents folder:

**1** In Windows XP, click **Start**, then click **My Documents**. The *My Documents* window opens and displays many of your saved personal data files. Go to Step 4.

- OR -

In Windows 98, Windows Me, or Windows 2000, double-click the **My Computer** icon on the desktop. Go to the next step.

**2** Double-click the **C:\** drive icon.

**3** Double-click the **My Documents** folder. The *My Documents* window opens and displays many of your saved personal data files.

**4** Copy your personal data files to removable media or to another computer on your network.



You can often identify different data file types by looking at the file's *extension* (the part of the file name following the last period). For example, a document file might have a .DOC extension and a spreadsheet file might have an .XLS extension.

File type	File usually ends in...
Documents	.DOC, .TXT, .RTF, .HTM, .HTML, .DOT
Spreadsheets	.XLS, .XLT, .TXT
Pictures	.JPG, .BMP, .GIF, .PDF, .PCT, .TIF, .PNG, .EPS
Movies	.MPEG, .MPG, .AVI, .GIF, .MOV
Sound and Music	.WAV, .CDA, .MP3, .MID, .MIDI, .WMA

 **To find files using Find or Search:**

**1** In Windows XP, click **Start**, then click **Search**. The *Search Results* window opens.

- OR -

In Windows 98, Windows Me, or Windows 2000, click **Start**, **Find** or **Search**, then click **For Files or Folders**. The *Search Results* window opens.

**2** Use Windows Find or Search to locate data files by file name or file type. For help on finding files, click **Help**, then click **Help and Support Center** or **Help Topics**. For more information, see “Searching for files” on page 68.



**Help and Support**



For more information about finding files, tap **Start**, then tap **Help and Support**.

Type the keyword **searching for files** in the Help and Support Center **Search** box  , tap the arrow, then tap the **Full-text Search Matches** button.



# Transferring Internet settings

You can use different methods to transfer your Internet account from your old computer to your new one.

## Setting up your ISP

- If your current Internet service provider (ISP) software came preinstalled on your new tablet PC, run that setup program. If it asks to set up a new account or an existing one, choose to set up an existing account.
- If your current ISP software is not preinstalled on your new tablet PC, locate the original Internet setup program provided by your local ISP, or contact your ISP to see if they have an updated version of their software, and install it on your new tablet PC.
- If you use MSN as your ISP, or if you know your ISP settings, use the Windows Internet Connection Wizard.



### To use the Internet Connection Wizard:

- 1 Tap **Start**, **All Programs**, **Accessories**, **Communications**, then tap **New Connection Wizard**. The New Connection wizard opens.
- 2 Configure your Internet settings by following the on-screen instructions.



#### Help and Support



For more information about setting up an Internet connection, tap **Start**, then tap **Help and Support**.

Type the keyword **Internet connection** in the Help and Support Center **Search** box  , then tap the arrow.

## Transferring your e-mail and address book

See your old e-mail program's online help for information on *exporting* and *importing* e-mail messages and the address book. You can often export all of your old e-mail messages or address book to a diskette, then import them from the diskette into your new tablet PC's e-mail program. You may also want to consider printing the old information or using your old computer to send the e-mail messages to yourself, then using your new tablet PC to retrieve the e-mail messages.

## Transferring your Internet shortcuts

You can export and import your old Netscape Navigator bookmarks or Microsoft Internet Explorer favorites. For more information, see your Internet browser program's online help.

## Installing your old printer or scanner

Windows may have built-in support for older printers, scanners, or other peripheral devices. This means you do not need any additional software. Newer devices, however, usually require your original software installation CDs or diskettes.

If you have trouble after you install the software for your old devices, you can use System Restore to restore your tablet PC's previous settings.

### Help and Support



For information about restoring your tablet PC's previous settings, tap **Start**, then tap **Help and Support**.

Type the keyword **System Restore** in the Help and Support Center **Search** box  , then tap the arrow.

USB devices may have special installation instructions. See your USB device's installation guide.

# Installing your old programs

You probably use some programs that did not come installed on your new tablet PC, such as personal finance software, graphics programs, or games.

Spend some time going through your old computer's Start and Programs menus, making note of any programs you want to install on your new tablet PC. Locate your original program installation CDs and installation guides. Your original CDs and guides should contain any serial numbers or product ID keys that may be required for program installation and registration. Remember to check the publisher's Web site for important program updates.

## Tips & Tricks



If your new tablet PC comes with a newer version of a program, it is usually better to use the newer version than to reinstall the old one.

If you have trouble after installing your old programs, you can restore your tablet PC's previous settings using System Restore.

## Help and Support



For more information about restoring your tablet PC's previous settings, tap **Start**, then tap **Help and Support**.

Type the keyword **System Restore** in the Help and Support Center **Search** box  **Search** , then tap the arrow.





# Maintaining Your Tablet PC

# 13

This chapter provides basic information about maintaining your tablet PC hardware and software. Read this chapter to learn how to:

- Care for your tablet PC
- Create an emergency startup diskette
- Protect your tablet PC from viruses
- Manage hard drive space
- Back up files
- Clean your tablet PC



# General Guidelines

- Protect the Gateway Tablet PC from exposure to extreme temperatures, shock, liquids, strong magnetic fields, and turbulent conditions.
- Operate your Tablet PC in the temperature range of 41°F to 95°F (5°C to 35°C)
- Do not block the side heat vent.
- Do not open or disassemble the tablet other than to replace memory modules.
- When storing the tablet for an extended period of time, unplug AC power and remove the battery after discharging it partway.
- Do not place heavy objects on top of the tablet.

# Display screen

- Use only the tablet's pen on the display. Do not write on the surface with an ink pen or pencil.
- Nothing heavier than your writing hand should be placed on top of the display.
- Protect the display surface from unnecessary contact by using the Hard Top or a case when transporting the Gateway Tablet PC.
- Never spray or pour liquids directly on the display surface.
- Avoid prolonged exposure to direct sunlight.
- Use the included cleaning cloth or similar soft fabric to wipe away dust and fingerprints. Dampen the cloth with water but never spray anything directly on the surface. If liquid collects around the edges, wipe it up immediately.

# Pen

- Always store the pen in the Gateway Tablet PC's pen holder when not in use.
- Store extra pens horizontally in a box or drawer.
- Pens should not be stored vertically on the tip because constant tip pressure can affect pen-screen interaction.
- The pen has electronics in it, so it should not be exposed to or immersed in liquids.

## Replacing the pen point

Normal use wears down the pen's point, so the pen ships with extra points and a replacement tool. To use the tool, grasp the old point with the ring and pull. Insert a new point and apply slight pressure to set it in place.

## Caring for your tablet PC

To extend the life of your system:

- Be careful not to bump or drop your tablet PC, and do not put any objects on top of it. The case, although strong, is not made to support extra weight.
- When transporting your tablet PC, we recommend that you put it in a carrying case.
- Keep diskettes and your tablet PC away from magnetic fields. Magnetic fields can erase data on both diskettes and hard drives.
- Never turn off your tablet PC when the hard drive light is on because data on the hard drive could be lost or corrupted.
- Avoid subjecting your tablet PC to extreme temperature changes. The case and LCD panel can become brittle and easy to break in cold temperatures and can melt or warp in high temperatures. Damage due to either extreme is not covered by your warranty. As a general rule, your tablet PC is safest at temperatures that are comfortable for you.

- Keep all liquids away from your tablet PC. When spilled onto computer components, almost any liquid can result in extremely expensive repairs that are not covered under your warranty.
- Avoid dusty or dirty work environments. Dust and dirt can clog the internal mechanisms.

Use the following table to set up a regular maintenance schedule.

Maintenance task	Immediately after purchase	Monthly	When needed	See...
Create an emergency diskette	X			page 191
Check for viruses		X	X	page 193
Manage hard drive space			X	page 196
Clean up hard drives		X	X	page 196
Scan hard drive for errors		X	X	page 198
Defragment hard drive		X	X	page 199
Back up files		X	X	page 201
Clean tablet PC case			X	page 203
Clean keyboard			X	page 203
Clean tablet PC screen			X	page 204
Clean mouse			X	page 204



# Creating an emergency startup diskette

An *emergency startup diskette* is a diskette that contains critical information that you need to start your tablet PC if Windows fails to start. You should create a startup diskette as soon as you get your tablet PC.

## Important



This procedure uses a diskette drive. If you do not have a diskette drive, you can purchase a drive from the Gateway Accessories Store at [accessories.gateway.com](http://accessories.gateway.com).



## To create an emergency startup diskette:

- 1 Insert a blank diskette labeled **Startup** into the diskette drive.
- 2 Tap **Start**, then tap **My Computer**. The *My Computer* window opens.
- 3 Button-tap **3½ Floppy (A:)**, then tap **Format**. The *Format 3½ Floppy (A:)* dialog box opens.

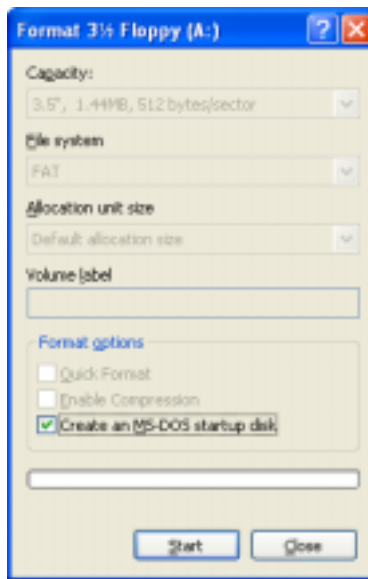

- 4 Tap to select the **Create an MS-DOS startup disk** check box, then tap **Start**. A message warns you that any information on the diskette will be erased.
- 5 When you see the warning message, tap **OK**. Windows copies files to the emergency startup diskette.
- 6 When Windows finishes copying files, remove the diskette from the diskette drive.
- 7 Slide the write-protect tab up to prevent the diskette from being erased or infected by viruses.

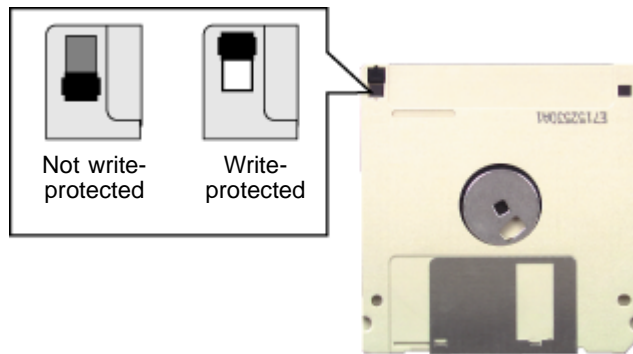

- 8 Store your emergency startup diskette in a safe place with your other backup software media.



# Protecting your tablet PC from viruses

A *virus* is a program that attaches itself to a file on a computer, then spreads from one computer to another. Viruses can damage data or cause your tablet PC to malfunction. Some viruses go undetected for a period of time because they are activated on a certain date.

Protect your tablet PC from a virus by:

- Using the Norton® AntiVirus program to check files and programs that are on diskettes, attached to e-mail messages, or downloaded from the Internet.
- Checking all programs for viruses before installing them.
- Disabling macros on suspicious Microsoft Word and Excel files. These programs will warn you if a document that you are opening contains a macro that might have a virus.
- Periodically updating the Norton AntiVirus program to protect against the latest viruses.

## Help and Support



For more information about protecting your tablet PC against viruses, tap **Start**, then tap **Help and Support**.

Type the keyword **viruses** in the Help and Support Center **Search** box  , then tap the arrow.

▶ To scan for viruses:

- 1 Tap **Start**, **All Programs**, **Norton AntiVirus**, then tap **Norton AntiVirus 2003**. Norton AntiVirus opens.

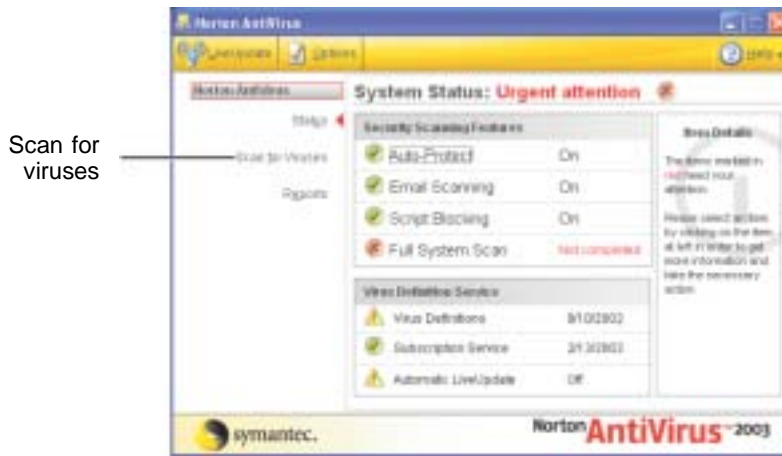

- 2 Tap **Scan for Viruses**.

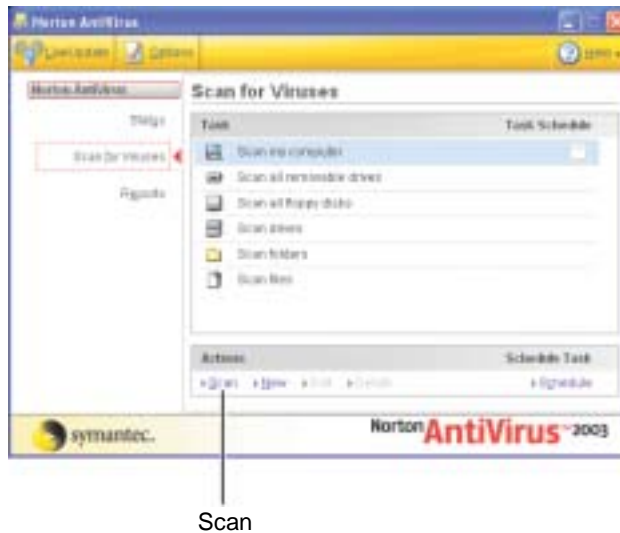

- 3 Tap the type of scan you want to make in the Scan for Viruses area, then under **Actions**, tap **Scan**.





### To remove a virus:

- 1 If Norton AntiVirus finds a virus, follow all on-screen instructions to remove the virus.
- 2 Turn off your tablet PC and leave it off for at least 30 seconds.
- 3 Turn on your tablet PC and rescan for the virus.



### To update Norton AntiVirus:

- 1 Make sure that you are connected to the Internet.
- 2 Tap **Start**, **All Programs**, **Norton AntiVirus**, then tap **LiveUpdate - Norton AntiVirus**. The LiveUpdate wizard opens.
- 3 Follow the on-screen instructions to update your Norton AntiVirus program with the latest virus protection files.
- 4 When the program has finished, tap **Finish**.



# Managing hard drive space

Windows provides several utilities you can use to manage your hard drive.

## Checking hard drive space

▶ To check hard drive space:

- 1 Tap **Start**, then tap **My Computer**. The *My Computer* window opens.
- 2 Button-tap the drive that you want to check for available file space, then tap **Properties**. Drive space information appears.

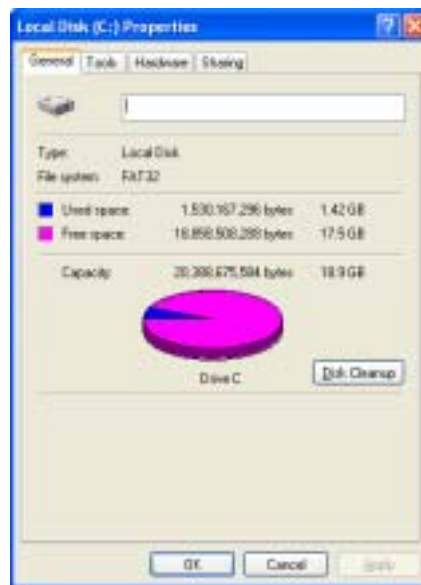

## Using Disk Cleanup

Delete unnecessary files, such as temporary Windows files, to free hard drive space.

▶ To use the Windows Disk Cleanup program:

- 1 Tap **Start**, then tap **My Computer**. The *My Computer* window opens.
- 2 Button-tap the hard drive that you want to delete files from, for example Local Disk (C:), then tap **Properties**. The *Properties* dialog box opens at the General tab.

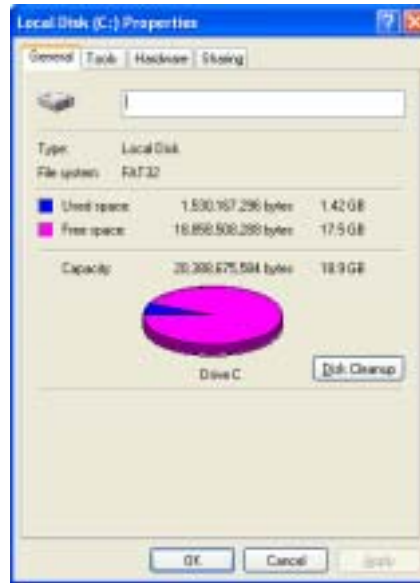

- 3 Tap **Disk Cleanup**. The *Disk Cleanup* dialog box opens.
- 4 Make sure that the check box beside each file type you want to delete is selected. For more information about file types you can delete, read the descriptions in the *Disk Cleanup* dialog box.
- 5 Tap **OK**, then tap **Yes**.



### Help and Support



For more information about keeping the hard drive space free of unnecessary files, tap **Start**, then tap **Help and Support**.

Type the keyword **disk cleanup** in the Help and Support Center **Search** box  , then tap the arrow.

## Checking the hard drive for errors

The Error-checking program examines the hard drive for physical flaws and file and folder problems. This program corrects file and folder problems and marks flawed areas on the hard drive so Windows does not use them.

If you use your tablet PC several hours every day, you probably want to run Error-checking once a week. If you use your tablet PC less frequently, once a month may be adequate. Also use Error-checking if you encounter hard drive problems.



### To check the hard drive for errors:

- 1 Tap **Start**, then tap **My Computer**. The *My Computer* window opens.
- 2 Button-tap the hard drive that you want to check for errors, for example Local Disk (C:), then tap **Properties**. The *Properties* dialog box opens.
- 3 Tap the **Tools** tab.



- 4 Tap **Check Now**.



- 5 Tap the options you want to use, then tap **Start**. For help, press **F1**. Windows checks the drive for errors. This process may take several minutes. After Windows has finished checking the drive for errors, it provides a summary of the problems that it found.
- 6 Correct any problems that are found by following the on-screen instructions.
- 7 Tap **OK**.



**Help and Support**



For more information about checking the hard drive for errors, tap **Start**, then tap **Help and Support**.

Type the keyword **checking for disk errors** in the Help and Support Center **Search** box  **Search** , then tap the arrow.

## Defragmenting the hard drive

When working with files, sometimes Windows divides the file information into pieces and stores them in different places on the hard drive. This is called *fragmentation*, and it is normal. In order for your tablet PC to use a file, Windows must search for the pieces of the file and put them back together. This process slows the hard drive performance.

The Disk Defragmenter program organizes the data on the drive so each file is stored as one unit rather than as multiple pieces scattered across different areas of the drive. Defragmenting the information stored on the drive can improve hard drive performance.

While the Disk Defragmenter program is running, do not use your pen or keyboard because using them may continuously stop and restart the defragmenting process. Also, if you are connected to a network, log off before starting Disk Defragmenter. Network communication may stop the defragmentation process and cause it to start over.

▶ To defragment the hard drive:

- 1 Tap **Start**, then tap **My Computer**. The *My Computer* window opens.
- 2 Button-tap the hard drive that you want to defragment, for example Local Disk (C:), then tap **Properties**. The *Properties* dialog box opens.
- 3 Tap the **Tools** tab.



- 4 Tap **Defragment Now**.
- 5 If Disk Defragmenter does not start automatically, tap **Defragment** or **Start**.  
Disk Defragmenter shows its progress on the tablet PC display. When finished, Disk Defragmenter asks if you want to quit the program.
- 6 Tap **Close** or **Yes**, then tap the X in the top-right corner to close the *Disk Defragmenter* window.



**Help and Support**

For more information about defragmenting the hard drive, tap **Start**, then tap **Help and Support**.

Type the keyword **defragmenting** in the Help and Support Center **Search** box  **Search** , then tap the arrow.

## Backing up files

Backing up files and removing them from the hard drive frees space for new files on the hard drive. It also protects you from losing important information if the hard drive fails or you accidentally delete files.

You should back up your files regularly to a writable CD (if you have a DVD/CD-RW drive) or to diskettes (if you have a diskette drive). Use a backup device, such as a DVD/CD-RW drive or Zip drive, to do a complete hard drive backup. For more information, see “Creating CDs” on page 100. If you do not have a high-capacity backup device and you want to purchase one, you can contact Gateway’s Add-on Sales department or visit the Accessories Store at [accessories.gateway.com](http://accessories.gateway.com).

**Help and Support**

For more information about backing up files, tap **Start**, then tap **Help and Support**.

Type the keyword **saving files** in the Help and Support Center **Search** box  **Search** , then tap the arrow.

## Using the Scheduled Task Wizard

The Scheduled Task Wizard lets you schedule maintenance tasks such as running Disk Defragmenter and Error-checking.

 **To start the Scheduled Task Wizard:**

- 1 Tap **Start**, **All Programs**, **Accessories**, **System Tools**, then tap **Scheduled Tasks**. The *Scheduled Tasks* window opens.
- 2 Double-tap the **Add Scheduled Task** icon. The Scheduled Task Wizard opens.

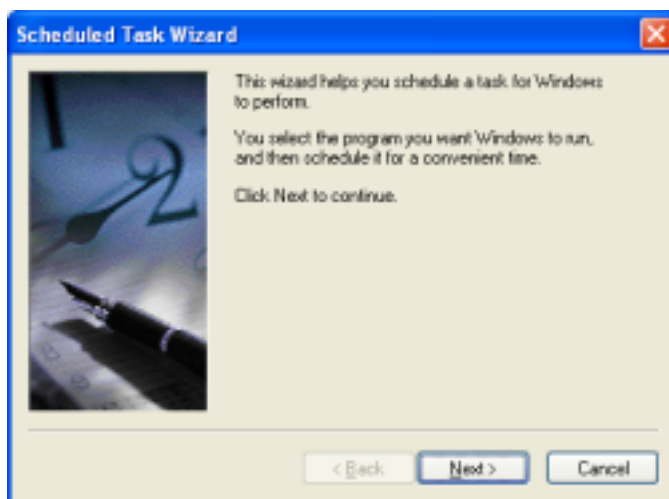

- 3 Tap **Next**, then tap the task or program you want to schedule and follow the on-screen instructions to customize the task.

**Important**



Your tablet PC must be on during scheduled tasks. If your tablet PC is off, scheduled tasks will not run.



**Help and Support**



For more information about using the Scheduled Tasks Wizard, tap **Start**, then tap **Help and Support**.

Type the keyword **Scheduled Task Wizard** in the Help and Support Center **Search** box  , then tap the arrow.

# Cleaning your tablet PC

Keeping your tablet PC clean and the vents free from dust helps keep your system performing at its best. You may want to gather these items and put together a tablet PC cleaning kit:

- A soft, lint-free cloth
- An aerosol can of air that has a narrow, straw-like extension
- Isopropyl alcohol
- Cotton swabs
- A CD or DVD drive cleaning kit

## Cleaning the exterior

### Warning



When you shut down your tablet PC, the power turns off, but some electrical current still flows through your tablet PC. To avoid possible injury from electrical shock, unplug the power cord and modem cable from the wall outlets.

Always turn off your tablet PC and other peripheral devices, then remove the battery before cleaning any components.

Use a damp, lint-free cloth to clean your tablet PC and other parts of your system. Do not use abrasive or solvent cleaners because they can damage the finish on components.

Your tablet PC is cooled by air circulated through the vents on the case, so keep the vents free of dust. With your tablet PC turned off and unplugged, brush the dust away from the vents with a damp cloth. Be careful not to drip any water into the vents. Do not attempt to clean dust from the inside of your tablet PC.

## Cleaning the keyboard

You should clean the keyboard occasionally by using an aerosol can of air with a narrow, straw-like extension to remove dust and lint trapped under the keys.

If you spill liquid on the keyboard, unplug the keyboard and turn it upside down. Let the liquid drain, then let the keyboard dry before trying to use it again. If the keyboard does not work after it dries, you may need to replace it.

## Cleaning the tablet PC screen

Use the soft cloth provided with the tablet PC to wipe the screen.

### Warning



The tablet PC screen is made of specially coated glass and can be scratched or damaged by abrasive or ammonia-based glass cleaners.

## Cleaning the mouse

If you have a mouse and the mouse pointer begins moving erratically across the tablet PC screen or becomes difficult to control precisely, cleaning the mouse will likely improve its accuracy.

Clean your optical mouse by wiping the bottom of the mouse with a damp lint-free cloth.

▶ **To clean your trackball mouse:**

- 1** Turn the mouse upside down.
- 2** Rotate the retaining ring on the bottom of the mouse counter-clockwise, then remove the retaining ring and mouse ball.



- 3** Remove any dust, lint, or dirt from the mouse ball with a soft cloth.
- 4** Clean the mouse rollers with a cotton swab dipped in isopropyl alcohol.

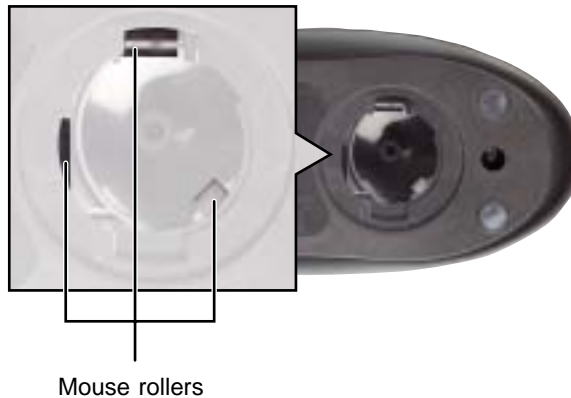

- 5** Replace the mouse ball and lock the retaining ring into place.









# Restoring Software

# 14

Read this chapter to learn how to:

- Reinstall device drivers
- Update device drivers
- Reinstall programs
- Reinstall Windows

## Important



The procedures in this chapter require using a CD or DVD drive. If you do not own one, Gateway recommends purchasing the combination DVD/CD-RW drive. To order a combination DVD/CD-RW drive, visit the Accessory Store at [accessories.gateway.com](http://accessories.gateway.com).



# Using the Restoration CDs

Use the Gateway *Restoration CDs* to reinstall device drivers, your operating system, and other programs that were preinstalled at the factory.

## Important



Before you try to fix a problem by reinstalling software from your Gateway *Restoration CDs*, make sure that you have tried these steps first:

- Use the diagnostics and troubleshooting tools found in Help and Support Center. For more information about diagnostics and troubleshooting tools, tap **Start**, then tap **Help and Support**.

Type the keyword **troubleshooting** in the Help and Support Center **Search** box  , then tap the arrow.

- Run System Restore. For more information about System Restore in Windows XP, click **Start**, then click **Help and Support**.

Type the keyword **System Restore** in the Help and Support **Search** box  , then click the arrow.

- See the Troubleshooting section of this guide.

If these steps do not resolve the problem, use the Gateway *Restoration CDs* to reinstall device drivers or programs.

If reinstalling device drivers or programs does not resolve the problem, reinstall Windows.

If you are not comfortable with the procedures covered in this chapter, seek help from a more experienced computer user or a computer service technician.

# Reinstalling device drivers

Device drivers are programs that control devices such as the tablet PC display, drives, and modems. Drivers translate information between computer devices and programs.

Drivers for your original tablet PC hardware are installed at Gateway. If you install a new device, you need to install the drivers provided by the device manufacturer.

You should reinstall device drivers:

- If directed to do so while troubleshooting
- If you see a message indicating that there is a problem with a device driver

If you need to reinstall device drivers because you are directed to do so while troubleshooting or if a message tells you that there is a problem with a device driver, reinstall the device drivers by completing the following task.

If you just reinstalled Windows XP, the device drivers were automatically reinstalled.



## To reinstall device drivers:

- 1 Insert the red Gateway CD into the DVD/CD-RW drive. If the program starts automatically, go to Step 5.
  - OR -
  - If the program does not start automatically, go to Step 2.
- 2 Tap **Start**, then tap **Run**. The *Run* dialog box opens.
- 3 In the **Open** text box, type **d:\runmenu.exe** (where **d** is the drive letter of your DVD/CD-RW drive).
- 4 Tap **OK**.
- 5 If this is the first time you have inserted the red Gateway CD, accept the End User License Agreement (EULA) by tapping **Yes, I accept it**, then tapping **Continue**. The Gateway Driver and Application Recovery program starts and the **Drivers and Application Recovery** tab appears.



**6** Select a single device driver to reinstall.

- OR -

Tap **Automatic Installation**, then select multiple device drivers to reinstall. (Grayed out drivers are not available for Automatic Installation. To select these drivers, tap **Manual Installation**.)

**7** Tap **Install**.

**8** Follow any additional on-screen instructions. Depending on the device driver you are reinstalling, you may only need to restart your tablet PC to complete the installation. However, if a setup wizard opens when you restart your tablet PC, follow the on-screen instructions.



**Help and Support**



For more information about reinstalling device drivers, tap **Start**, then tap **Help and Support**.

Type the keyword **drivers** in the Help and Support Center **Search** box  , then tap the arrow.

# Updating device drivers

The *Restoration CDs* contain a device driver update utility that works over the Internet. If you do not have an Internet service provider, the update utility works by direct-dialing the device driver update service.

## Important



Your system came equipped with a wireless device. Only use the drivers approved for the country the device will be used in. See the red Gateway CD or the Gateway Technical Support Web site ([support.gateway.com](http://support.gateway.com)).

See “Safety, Regulatory, and Legal Information” on page 267 for general wireless regulatory and safety guidelines.



## To update device drivers:

- 1 Insert the red Gateway CD into the DVD/CD-RW drive. If the program starts automatically, go to Step 5.  
- OR -  
If the program does not start automatically, go to Step 2.
- 2 Tap **Start**, then tap **Run**. The *Run* dialog box opens.
- 3 In the **Open** text box, type **d:\runmenu.exe** (where **d** is the drive letter of the DVD/CD-RW drive).
- 4 Tap **OK**.
- 5 If this is the first time you have inserted the red Gateway CD, accept the End User License Agreement (EULA) by tapping **Yes, I accept it**, then tapping **Continue**. The Gateway Driver and Application Recovery program starts and the **Drivers and Application Recovery** tab appears.
- 6 Tap the **Web Updates** tab.
- 7 Tap **Check Now**. The *Connect* window opens.



- 8 Install available updated device drivers by following the on-screen instructions. Depending on the device driver you are updating, you may only need to restart your tablet PC to complete the installation. However, if a setup wizard opens when you restart your tablet PC, follow the on-screen instructions.



#### Help and Support



For more information about updating device drivers, tap **Start**, then tap **Help and Support**.

Type the keyword **updating drivers** in the Help and Support Center **Search** box  **Search** , then tap the arrow.

## Reinstalling programs

If you have problems running a program or if you have reinstalled your operating system, you can reinstall programs from the red Gateway CD and other program CDs. If you are reinstalling programs from other program CDs, follow the installation instructions on each CD. If you want to **reinstall** a program, uninstall the old version first.



### To reinstall programs from the Applications CD(s):

- 1 If you just reinstalled Windows, go to Step 4. Otherwise, go to the next step.
- 2 Tap **Start**, **Control Panel**, then tap **Add or Remove Programs**.
- 3 In the *Currently Installed Programs* list, tap the program you want to uninstall, then tap **Change/Remove** and follow the on-screen instructions.

- 4** Insert the red Gateway CD into the DVD/CD-RW drive. If the program starts automatically, go to Step 8.

- OR -

If the program does not start automatically, go to Step 5.

- 5** Tap **Start**, then tap **Run**. The *Run* dialog box opens.
- 6** In the **Open** text box, type **d:\runmenu.exe** (where **d** is the drive letter of your DVD/CD-RW drive).
- 7** Tap **OK**.
- 8** If this is the first time you have inserted the red Gateway CD, accept the End User License Agreement (EULA) by tapping **Yes, I accept it**, then tapping **Continue**. The Gateway Driver and Application Recovery program starts and the **Drivers and Application Recovery** tab appears.
- 9** Select a single program to reinstall.

- OR -

Tap **Automatic Installation**, then select multiple programs to reinstall. (Grayed out programs are not available for Automatic Installation. To select these programs, tap **Manual Installation**.)

- 10** Tap **Install**.
- 11** Follow any additional on-screen instructions. Depending on the programs you are reinstalling, you may only need to restart your tablet PC to complete the installation. However, if a setup wizard opens when you restart your tablet PC, follow the on-screen instructions.



#### Help and Support



For more information about reinstalling programs, tap **Start**, then tap **Help and Support**.

Type the keyword **installing programs** in the Help and Support Center **Search** box  , then tap the arrow.

 **To reinstall other programs from a CD:**

- 1** If you just reinstalled Windows, go to Step 4. Otherwise, go to the next step.
- 2** Tap **Start**, **Control Panel**, then tap **Add or Remove Programs**.
- 3** In the *Currently Installed Programs* list, tap the program you want to uninstall, then tap **Change/Remove** and follow the on-screen instructions.
- 4** Insert the program CD into the DVD/CD-RW drive.
- 5** Complete the program reinstallation by following the instructions included with the program CD.



## Reinstalling Windows

If your tablet PC is not working correctly, try the following options to correct the problem:

- Troubleshooting. For more information, see “Troubleshooting” on page 237.
- Reinstalling device drivers. For more information, see “Reinstalling device drivers” on page 209.

If the options above do not correct the problem, you can use the *Restoration CDs* to reinstall Windows and other software.

The *Restoration CDs* step you through reinstalling Windows XP. If you are reinstalling Windows XP, the *Restoration CDs* automatically reinstall the hardware device drivers and some programs as well. You can install any remaining programs by using the program CDs that came with your tablet PC. To reinstall your programs, follow the instructions in “Reinstalling programs” on page 212.

**Important**



If you are prompted for your Windows product key when you reinstall Windows, you can find the key on the *Microsoft Certificate of Authenticity* label located on the back of your tablet PC case. For more information, see “Microsoft Certificate of Authenticity” on page 12.



 **To reinstall Windows XP and the device drivers:****Caution**

Back up your personal files before you use this option.  
**All files on your tablet PC will be deleted!**

- 1** Insert the red Gateway CD into the DVD/CD-RW drive.
- 2** Restart your tablet PC.
- 3** Select **2. Boot from CD-ROM.**
- 4** Select a language option.
- 5** Select **1. Delete all files (Automated Fdisk/Format).**
- 6** Select **1. Continue deleting all files and restart.**
- 7** When prompted, press any key to continue.
- 8** Select **2. Boot from CD-ROM.**
- 9** Select a language option.
- 10** Select **2. Automated installation of Windows XP.**
- 11** When prompted, remove the red Gateway CD and insert the blue *Operating System* CD into the DVD/CD-RW drive, then press any key to continue.
- 12** When prompted, accept the *License Agreement* by pressing **Y.**
- 13** Wait while the setup program copies files to your hard drive. **When your tablet PC restarts, do NOT press any key to boot from CD.**
- 14** When prompted, insert the red Gateway CD, then tap **Continue.** The Gateway Application Loader automatically installs your drivers and programs. Your tablet PC restarts several times during this process. Do **not** press any keys or buttons during this process unless prompted to do so.



- 15** When the Gateway Application Loader has finished, go to the Windows desktop by tapping **OK**.
- 16** Install additional programs by following the instructions in “Reinstalling programs” on page 212.
- 17** Install other software, such as Microsoft Works Suite and gaming software, by following the instructions in “To reinstall other programs from a CD:” on page 214.





# Upgrading Your Tablet PC

# 15

This chapter provides information about adding hardware devices to your tablet PC. Read this chapter to learn how to:

- Add and remove PC Cards
- Add and replace memory



# Adding and removing a PC Card

Your tablet PC has one PC Card slot (also known as a PCMCIA card slot). This slot accepts one Type II card.

You do not need to restart your tablet PC when changing most cards because your tablet PC supports *hot-swapping*. Hot-swapping means that you can insert a PC Card while your tablet PC is running. If your PC Card does not work after hot-swapping, see the PC Card manufacturer's documentation for further information.

## Important



The tablet PC ships with a spacer in the PC Card slot. Whenever the slot is not in use, leave the spacer in place.



## To add a PC Card:

- 1 If the spacer is in the PC Card slot, release the eject button by pressing the PC Card eject button once. Eject the spacer by pressing the eject button again. Remove the spacer.



- 2** Push the PC Card firmly into the PC Card slot label-side facing the front of the tablet until the outer edge of the card is flush with the side of your tablet PC.



 **To remove a PC Card:**

- 1 Tap the remove hardware  icon in the taskbar, the PC Card name, then tap **Stop**.

-OR-

Turn off your tablet PC.

**Important**



If the remove hardware icon does not appear on the taskbar, tap the show hidden icons  button.

- 2 Release the eject button by pressing the PC Card eject button once.
- 3 Eject the PC Card by pressing the eject button again.



- 4 Insert the spacer into the PC Card slot.



# Preventing static electricity discharge

The components inside your tablet PC are extremely sensitive to static electricity, also known as *electrostatic discharge* (ESD).

**Warning**



ESD can permanently damage electrostatic discharge-sensitive components in your tablet PC. Prevent ESD damage by following ESD guidelines every time you install memory.

**Warning**



To avoid exposure to dangerous electrical voltages and moving parts, turn off your tablet PC and unplug the power cord and modem and network cables before opening the case.

Before installing memory, follow these guidelines:

- Turn off your tablet PC.
- Wear a grounding wrist strap (available at most electronics stores) and attach it to a bare metal part of your workbench or other grounded connection.

**Warning**



To prevent risk of electric shock, do not insert any object into the vent holes of the tablet PC.

- Touch a bare metal surface on your workbench or other grounded object.
- Unplug the power cord and the modem and network cables.
- Remove the battery. For more information, see “Changing batteries” on page 131.
- Disconnect all peripheral devices and remove any PC Cards.

Before working with computer components, follow these guidelines:

- Avoid static-causing surfaces such as carpeted floors, plastic, and packing foam.
- Remove components from their antistatic bags only when you are ready to use them. Do not lay components on the outside of antistatic bags because only the inside of the bags provide electrostatic protection.
- Always hold components by their edges. Avoid touching the edge connectors. Never slide components over any surface.

## Adding or replacing memory

Your tablet PC uses memory modules called SO-DIMMs (Small Outline Dual Inline Memory Modules). The modules are available in various capacities and any module can be placed in any available slot. Use only memory modules designed for the Gateway Tablet PC for upgrading your memory.

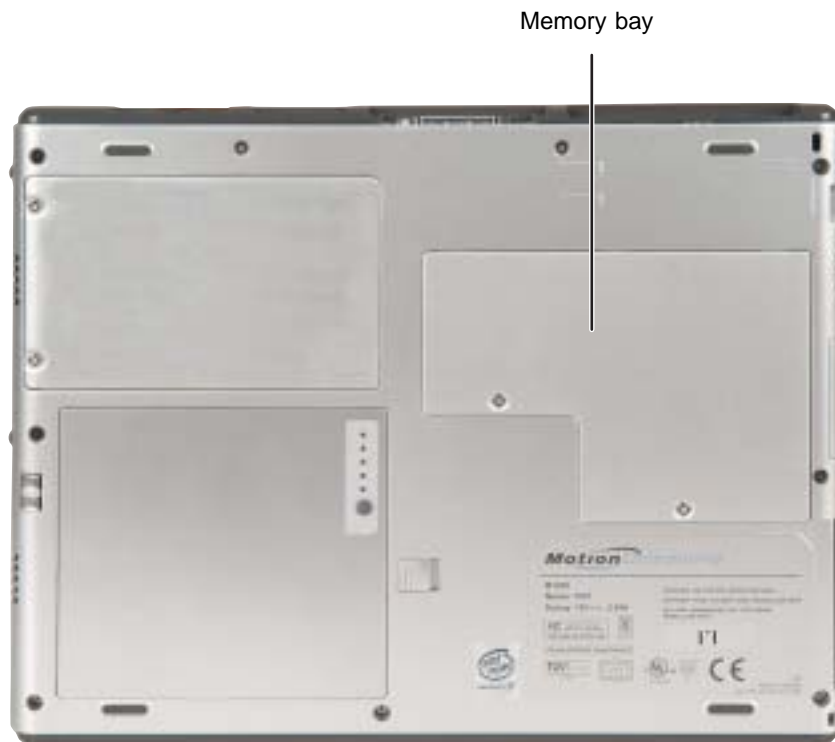



**To add or replace memory modules:**

- 1** Follow the instructions under “Preventing static electricity discharge” on page 221.
- 2** Turn off your tablet PC and disconnect the AC adapter and modem and network cables.
- 3** Disconnect your tablet PC from the optional FlexDock (see “Using the Tablet PC FlexDock” on page 227).
- 4** Place the hard top on the front of your tablet PC.
- 5** Turn your tablet PC over so the back is facing up.
- 6** Remove the battery. For more information, see “Changing batteries” on page 131.
- 7** Remove the two memory bay cover screws.



**8** Remove the memory bay cover.

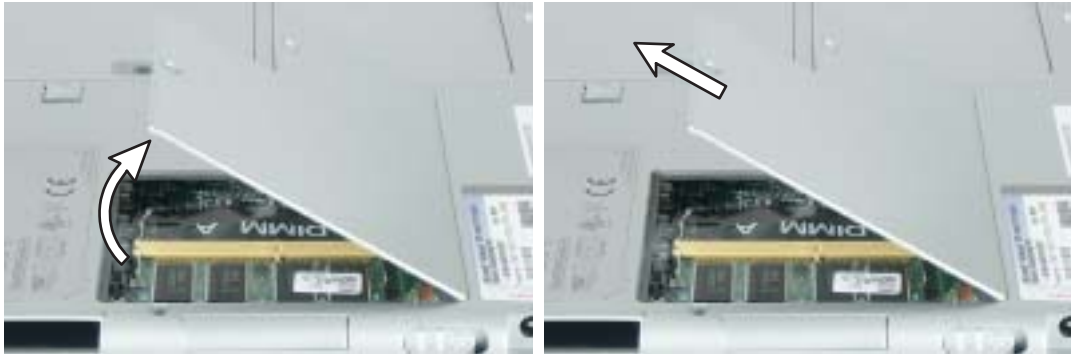

**9** If you are removing a module, gently press outward on the clip at each end of the memory module until the module tilts upward.

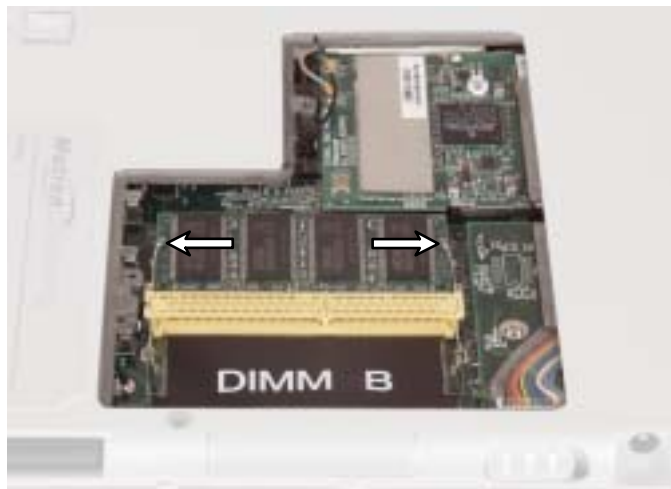

- 10** If you are removing a memory module, pull the module out of the slot.



- 11** Hold the new or replacement module at a 30-degree angle and press it into the empty memory slot. This module is keyed so it can only be inserted in one direction. If the module does not fit, make sure that the notch in the module lines up with the tab in the memory bay.



**Important**



Use only memory modules designed for the Gateway Tablet PC.



- 12** Gently push the module down until it clicks in place.
- 13** Replace the memory bay cover and replace the cover screws.
- 14** Insert the battery, then turn your tablet PC over.
- 15** Reconnect the optional FlexDock.
- 16** Connect the power adapter and modem and network cables, then turn on your tablet PC.
- 17** To check that the memory module has been installed successfully, tap **Start**, **My Computer**, then tap **View System Information**. The General tab shows the amount of memory now installed in your tablet.

**Important**



If the amount of memory shown and the memory you have just installed differ, the memory module may not be seated correctly. Remove the module and repeat the procedure.





# Using the Tablet PC FlexDock

# 16

This chapter introduces you to the basic features of your optional FlexDock. Read this chapter to learn:

- How to identify the features of your FlexDock
- How to connect your Gateway Tablet PC to the FlexDock









# Front

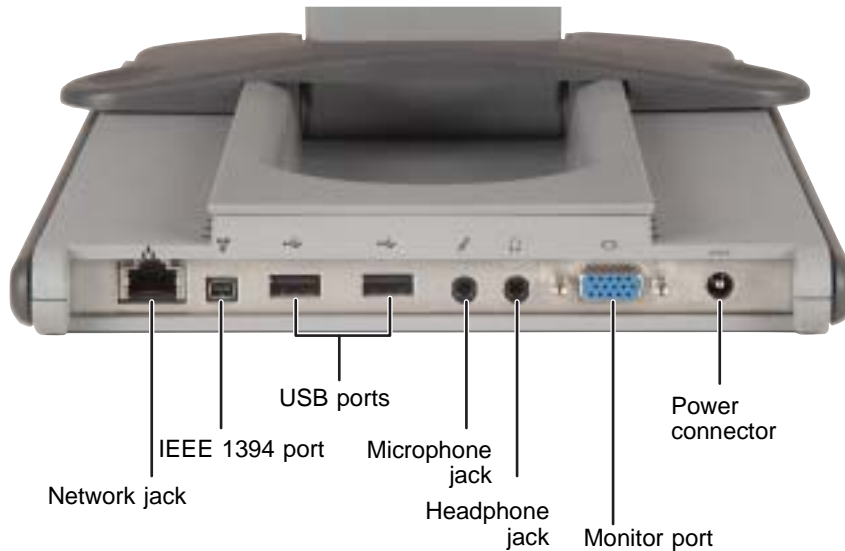



Indicator	Icon	Description
USB port		Plug USB (Universal Serial Bus) devices (such as a diskette drive, USB Iomega™ Zip™ drive, printer, scanner, camera, keyboard, or mouse) into this port.

# Back



Component	Icon	Description
Network jack		Plug a 10/100 Ethernet network cable into this jack. For more information, see “Connecting to a wired Ethernet network” on page 40 and “Networking Your Tablet PC” on page 165.
IEEE 1394 port		Plug an IEEE 1394 (also known as Firewire® or i.Link®) device (such as a digital camcorder or DVD/CD-RW drive) into this 4-pin IEEE 1394 port. For more information, see “Connecting a digital video camera” on page 114.
USB ports		Plug USB (Universal Serial Bus) devices (such as a diskette drive, USB Iomega™ Zip™ drive, printer, scanner, camera, keyboard, or mouse) into this port.
Microphone jack		Plug an external microphone into this jack. The built-in microphone is turned off when a microphone is plugged into this jack.
Headphone jack		Plug amplified speakers or headphones into this jack. The built-in speakers are turned off when speakers or headphones are plugged into this jack.

Component	Icon	Description
Monitor port		Plug an analog VGA monitor into this port.
Power connector		Plug the AC adapter cable into this connector. Do not substitute another adapter or use this connector for any other purpose.



# Using the FlexDock

The tablet joins the FlexDock at the docking connector in the center of the frame holder. Be sure the tablet sits firmly on the connector to access all ports.

- The silver crossbar adjusts to support the tablet at a range of angles for viewing and writing.
- In addition to the two USB ports on the back, the FlexDock includes an extra USB port on the front for convenience.
- When using the tablet's modem, plug the telephone cord into the tablet through the cutout on the front of the FlexDock.
- The FlexDock senses and automatically adjusts the tablet's display orientation when rotated between Primary Landscape and Primary Portrait modes. When you are ready to move from desktop to mobile mode, the FlexDock is completely Grab-and-Go. This means you can safely lift the tablet out of the FlexDock without shutting down, putting the tablet in *Standby* mode, or stopping any peripheral devices through Windows XP. However, you must disconnect the modem cable before removing the tablet.

The FlexDock lets you rotate the tablet from portrait to landscape and adjust the viewing angle. The FlexDock automatically changes the display orientation as you rotate the tablet. The unique design also lets you write on the tablet at any angle and stores flat for travel.



▶ **To set up the FlexDock:**

- 1** Lift and slide the crossbar on the FlexDock forward to set the desired viewing angle.

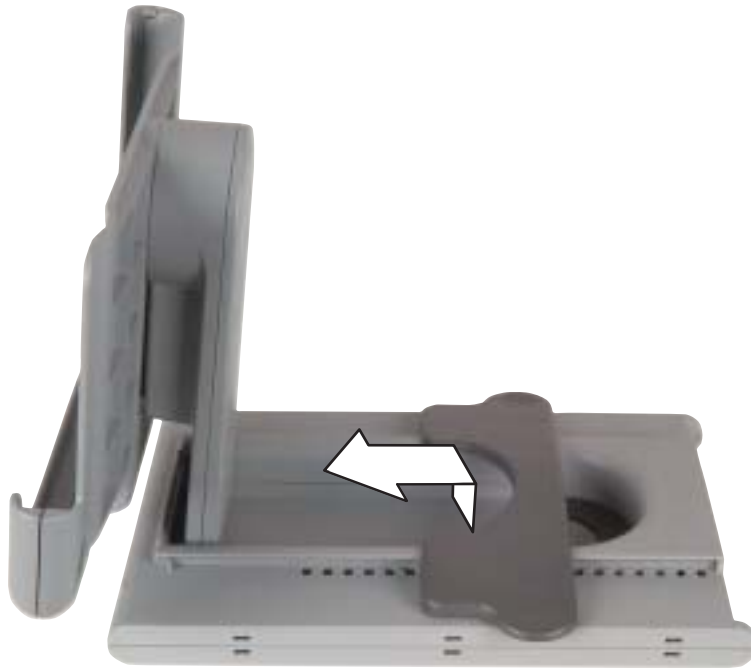

- 2 Install the end caps in the slots on each side of the FlexDock base, then slide them forward until they lock into the slots.

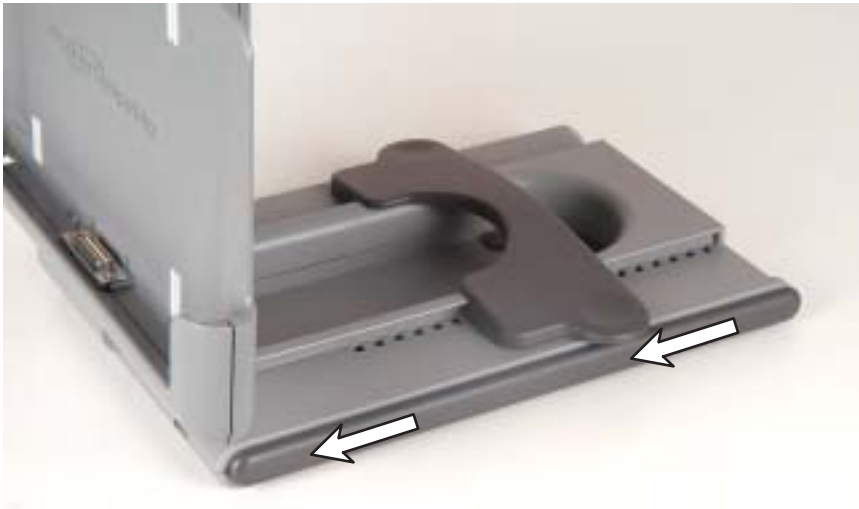
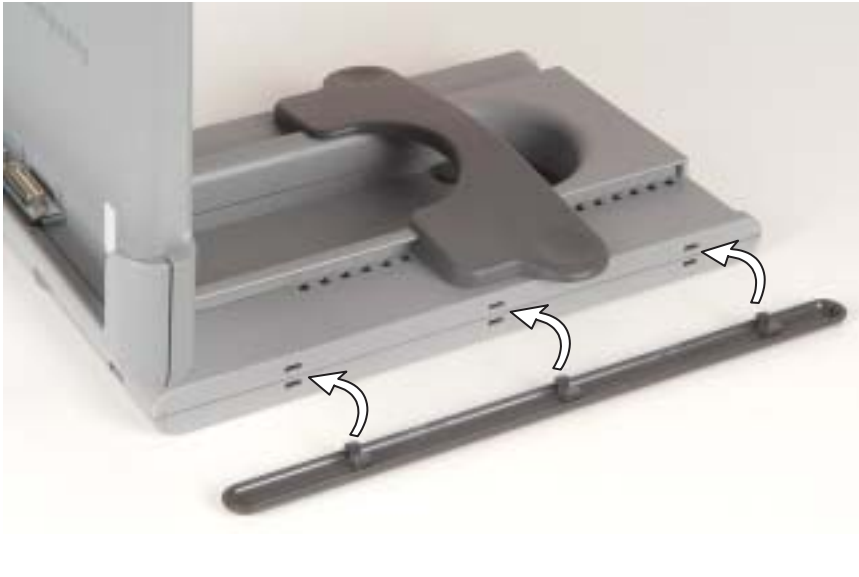

- 3 Verify that the FlexDock is horizontal (with the Motion logo horizontal) and the docking connector on the bottom.

- 4 With the docking connector pointing down, gently slide the tablet into the FlexDock until it clicks into place. (Spring tabs on each side secure it in place.)



- 5 Turn on the tablet by sliding the power switch, which is found on the right side of the tablet.
- 6 Test the screen rotation by turning the tablet in the FlexDock. The FlexDock will sense the change and automatically adjust the screen.
- 7 Install the optional equipment you have purchased. We recommend that you install one item at a time, waiting about two minutes before connecting the next accessory to ensure successful discovery and installation.







# 17

## Troubleshooting

This chapter provides some solutions to common tablet PC problems. Read this chapter to learn how to:

- Troubleshoot typical hardware and software problems
- Get telephone support
- Use automated troubleshooting systems
- Get tutoring and training

If the suggestions in this chapter do not correct the problem, see “Getting Help” on page 43 for more information about how to get help.



# Safety guidelines

While troubleshooting your tablet PC, follow these safety guidelines:

- Never remove the memory bay cover while your tablet PC is turned on, while the battery is installed, and while the modem cable, network cable, and AC power adapter are connected.
- Make sure that you are correctly grounded before accessing internal components. For more information about preventing damage from static electricity, see “Preventing static electricity discharge” on page 221.
- After you complete any maintenance tasks where you remove the memory bay, make sure that you replace the cover, reinstall any screws, then replace the battery before you start your tablet PC.

**Warning**



Do not try to troubleshoot your problem if power cords or plugs are damaged, if your tablet PC was dropped, or if the case was damaged. Instead, unplug your tablet PC and contact a qualified computer technician.



# First steps

If you have problems with your tablet PC, try these things first:

- Make sure that the AC power adapter is connected to your tablet PC and an AC outlet and that the AC outlet is supplying power.
- If you use a power strip or surge protector, make sure that it is turned on.
- If a peripheral device (such as a keyboard or mouse) does not work, make sure that all connections are secure.
- Make sure that your hard drive is not full.
- If an error message appears on the screen, write down the exact message. The message may help Gateway Technical Support in diagnosing and fixing the problem.
- If you added or removed peripheral devices, review the installation procedures you performed and make sure that you followed each instruction.
- If an error occurs in a program, see the program's printed documentation or the online help.

## Help and Support



For more information about troubleshooting, tap **Start**, then tap **Help and Support**.

Type the keyword **troubleshooting** in the Help and Support Center **Search** box Search  , then tap the arrow.

# Troubleshooting

The Gateway Tablet PC has passed a rigorous series of usage and quality-control tests, but now and then a problem may appear. If you do not see a solution among the following issues, see “Using eSupport” on page 52 and “Telephone support” on page 263.

## Audio

See “Sound” on page 260.

## Battery

See “Power” on page 256.

## Device installation

### You have computer problems after adding a new device

Sometimes a new device, such as a PC Card, can cause a system resource (IRQ) conflict. Check IRQ usage to determine if there is an IRQ conflict.



#### To check IRQ usage:

- 1 Tap **Start**, then tap **Control Panel**. The *Control Panel* window opens. If your Control Panel is in Category View, tap **Performance and Maintenance**.
- 2 Tap/Double-tap **System**, tap the **Hardware** tab, then tap **Device Manager**. The *Device Manager* window opens.
- 3 Tap **View**, then tap **Resources by type**. Double-tap **Interrupt request (IRQ)**. All IRQs and their hardware assignments are displayed.



#### Help and Support



For more information about IRQs, tap **Start**, then tap **Help and Support**.

Type the keyword **IRQs** in the Help and Support Center **Search** box  , then tap the arrow.

 **To free IRQ resources for the new device:**

- 1** In the *Device Manager* window, check the device list for a resource conflict. A resource conflict appears as a black exclamation point in a yellow circle.
- 2** Remove the device you are trying to install, then determine which one of the existing devices or ports you can disable.
- 3** Button-tap the device or port you want to disable, then tap **Disable**. The device or port is disabled.



## Diskette drive

### The diskette drive is not recognized

- Shut down and restart your tablet PC.
- The USB cable may not be inserted completely into the USB port. Press the cable into the port, then try to access the diskette again.

### You see an “Access Denied” or “Write protect” error message

- Move the write-protection tab in the upper-right corner of the diskette down (unprotected).
- The diskette may be full. Delete unnecessary files on the diskette and try again.
- Not all diskettes are IBM-compatible. Make sure that the diskette you are using is IBM-compatible.
- Try a different diskette. Occasionally diskettes are flawed and cannot be read by the diskette drive.

### You see a “Disk is full” error message

- Delete unnecessary files on the diskette.
- Try a different diskette. Occasionally diskettes are flawed and cannot be read by the diskette drive.
- Run Error checking on the diskette. For more information, see “Checking the hard drive for errors” on page 198. If errors are detected and corrected, try using the diskette again.

**You see a “Non-system disk”, “NTLDR is missing”, or “Disk error” error message**

- Eject the diskette from the diskette drive, then press **ENTER**.
- Make sure that the diskette you are using is IBM-compatible.

**The diskette drive status indicator is lit continuously**

- Remove the diskette from the drive. If the indicator stays on, try restarting your tablet PC.

## Display

**The screen is too dark**

- Adjust the brightness using the dashboard. For more information, see “Using the Motion Dashboard” on page 160.

**The screen resolution is not correct**

- Change the screen resolution from the *Display Properties* dialog box. For more information, see “Adjusting the screen resolution” on page 152.

**The screen is unreadable or distorted.**

- Adjust the brightness using the dashboard. For more information, see “Using the Motion Dashboard” on page 160.
- Screen resolution or color quality are set incorrectly. Reset resolution to 1024 × 768 and color quality to 32-bit under the **Settings** tab of the *Display Properties* dialog box. For more information, see “Adjusting the screen and desktop settings” on page 151
- Move your tablet PC away from sources of electrical interference, such as televisions, unshielded speakers, microwaves, fluorescent lights, and metal beams or shelves.
- Display driver has become corrupted or uninstalled.



**To reinstall the display driver:**

- 1** Tap **Start**, then tap **Control Panel**. The *Control Panel* window opens. If your Control Panel is in Category View, tap **Performance and Maintenance**.
- 2** Tap/Double-tap **System**, tap the **Hardware** tab, then tap **Device Manager**. The *Device Manager* window opens.

- 3 Double-tap **Monitors**.
- 4 Tap **Default Monitor**.
- 5 Choose **Update Driver** from the pull-down menu and follow the Wizard. You may need to attach the DVD/CD-RW drive.



### **The display has pixels that are always dark or too bright**

This condition is normal and inherent in the TFT technology used in active-matrix LCD screens. Gateway's inspection standards keep these to a minimum. If you feel these pixels are unacceptably numerous or dense on your display, contact Gateway Technical Support to identify whether a repair or replacement is justified based on the number of pixels affected.

## **DVD/CD-RW Drive**

### **Your tablet PC does not recognize a disc or the drive**

- The disc may not be seated correctly in the tray. When you place a disc on the tray, make sure that you press the disc firmly onto the spindle so the retainers hold the disc in place.
- Make sure that the disc label is facing up, then try again.
- Try a different disc. Occasionally discs are flawed and cannot be read by the drive.
- Some music CDs have copy protection software. You may not be able to play these CDs on your tablet PC.
- Your tablet PC may be experiencing some temporary memory problems. Shut down and restart your tablet PC.
- Clean the disc. For more information, see "Cleaning CDs or DVDs" on page 245.

### **An audio CD does not produce sound**

- Make sure that the CD label is facing up, then try again.
- Some music CDs have copy protection software. You may not be able to play these CDs on your tablet PC.
- Make sure that the Windows volume control is turned up. For more information, see "Adjusting the volume" on page 86.

- Make sure that Mute controls are turned off. For more information about the mute setting, see “Adjusting the volume” on page 86.
- Make sure that headphones are not plugged into the headphone jack. For the location of the headphone jack, see “Ports side” on page 7 and “Back” on page 229.
- If you are using powered speakers, make sure that they are plugged in and turned on.
- Clean the CD. For more information, see “Cleaning CDs or DVDs” on page 245.
- Your tablet PC may be experiencing some temporary memory problems. Shut down and restart your tablet PC.
- Reinstall the audio device drivers. For more information, see “Reinstalling device drivers” on page 209.

#### **A DVD movie will not play**

- Make sure that the label or side you want to play is facing up, then try again.
- Shut down and restart your tablet PC.
- Clean the DVD. For more information, see “Cleaning CDs or DVDs” on page 245.
- DVD discs and drives contain *regional codes* that help control DVD title exports and help reduce illegal disc distribution. To be able to play a DVD, the disc’s regional code and your DVD drive’s regional code must match.

The regional code on your DVD drive is determined by your tablet PC’s delivery address. The regional code for the United States and Canada is 1. The regional code for Mexico is 4. Your DVD drive’s regional code must match the regional code of the disc. The regional code for the disc is on the disc, disc documentation, or packaging.

If the DVD movie does not play, the disc’s regional code and your DVD drive’s regional code may not match.

- Make sure that a DVD player has been installed on your tablet PC. See “Playing a DVD” on page 99 for more information.

## Cleaning CDs or DVDs

Wipe from the center to the edge, not around in a circle, using a product made especially for the purpose.



## File management

### A file was accidentally deleted

If a file was deleted in Windows while holding down the **SHIFT** key, the file cannot be restored.

#### ▶ To restore deleted files:

- 1 Double-tap the **Recycle Bin** icon.
- 2 Button-tap the file you want to restore, then tap **Restore**. The file is restored to the place where it was originally deleted from.

If the Recycle Bin was emptied before you tried to restore a file, the file cannot be restored.



## Hard drive

### You see an “Insufficient disk space” error message

- Delete unnecessary files from the hard drive using Disk Cleanup. For more information, see “Using Disk Cleanup” on page 196.
- Empty the Recycle Bin by button-tapping the **Recycle Bin** icon, then tapping **Empty Recycle Bin**.

**Caution**



All deleted files will be lost when you empty the Recycle Bin.

- Save your files to a diskette or another drive. If the hard drive is full, copy any files not regularly used to diskettes or other backup media, then delete them from the hard drive.

**Help and Support**



For more information about file management, tap **Start**, then tap **Help and Support**.

Type the keyword **file management** in the Help and Support Center **Search** box  , then tap the arrow.

**You see a “Data error” message**

This may be the result of a defective area on the hard drive. To fix hard drive problems, run the Error checking program. For more information, see “Checking the hard drive for errors” on page 198.

**The hard drive cannot be accessed, or you see a “General failure reading drive C” error message**

- If a diskette is in the diskette drive, eject it and restart your tablet PC.
- If your tablet PC has been subjected to static electricity or physical shock, you may need to reinstall the operating system.

**You see a “Non-system disk”, “NTLDR is missing”, or “disk” error message**

- Eject the diskette from the diskette drive, then press **ENTER**.

## Internet

**You cannot connect to the Internet**

- Make sure that the modem cable is plugged into the modem jack and not the Ethernet network jack. See “Ports side” on page 7 and “Back” on page 229 to make sure that the connection has been made correctly.
- Make sure that your tablet PC is connected to the telephone line and the telephone line has a dial tone.



- If you have the call waiting feature on your telephone line, make sure that it is disabled.
- Make sure that you are not using a digital, rollover, or PBX line. These lines do not work with your modem.
- Make sure that your account with your Internet service provider (ISP) is set up correctly. Contact your ISP technical support for help.
- Make sure that you do not have a problem with your modem. For more information, see “Modem” on page 250.

**Help and Support**



For more information about troubleshooting Internet connections, tap **Start**, then tap **Help and Support**.

Type the keyword **troubleshooting connections** in the Help and Support Center **Search** box

Search  , then tap the arrow.

**You see an “Unable to locate host” message and are unable to browse the Internet**

This problem can occur when you have typed a URL (Web address) incorrectly, you have lost your Internet connection, or your ISP is having technical difficulties.

Double-check the URL or try a different URL. If the error message still appears, disconnect from the ISP connection and close your browser, then reconnect and open the browser. If you still get the error, your ISP may be having technical difficulties.

**Connecting to a Web site takes too long**

Many factors can affect Internet performance:

- The condition of the telephone lines in your residence or at your local telephone service
- The condition of the Internet computers to which you connect and the number of users accessing those computers
- The complexity of graphics and multimedia on Web pages
- Having multiple Web browsers open, performing multiple downloads, and having multiple programs open on your tablet PC

### **People are sending you e-mail messages, but you have not received any mail**

- Tap the receive button in your e-mail program.
- Make sure that your account with your Internet service provider (ISP) is set up correctly. Contact your ISP for technical support.

## **Interface/Ports**

### **The buttons on the Gateway Tablet's front do not do what they are supposed to**

- The button functions have been changed. Reset button functions in the Buttons tab of the *Tablet and Pen Settings* dialog box. For more information, see "Programming the buttons" on page 159.

### **The tablet does not recognize the PC Card**

- The card is incorrectly inserted. Eject the card and re-insert it with the label side up. For more information, see "Adding and removing a PC Card" on page 218

### **The tablet does not recognize a USB or 1394 peripheral device**

- The peripheral device is not connected to the Gateway Tablet PC correctly. Check the connection cable, and be sure it is inserted in the correct port on the tablet and the peripheral device.
- The correct driver is not built into Windows XP. Use the device's installation CD or check the manufacturer's Web site for the correct driver.

### **The tablet is sitting in the FlexDock but the tablet does not recognize peripheral devices**

- The Gateway Tablet PC is not fully seated in the FlexDock. Reseat the tablet in the FlexDock. For more information, see "Using the Tablet PC FlexDock" on page 227.

## **Keyboard**

### **The external keyboard does not work**

- Make sure that the keyboard cable is plugged in correctly.
- Remove all extension cables and switchboxes.

- Clean the keyboard by using an aerosol can of air with a narrow, straw-like extension to remove dust and lint trapped under the keys.
- Try a keyboard that you know works to make sure that the keyboard port works.
- If you spilled liquid in the keyboard, turn off your tablet PC and unplug the keyboard. Clean the keyboard and turn it upside down to drain it. Let the keyboard dry before using it again. If the keyboard does not work after it dries, you may need to replace it.

### A keyboard character keeps repeating or you see a “Keyboard stuck” or “Key failure” error message

- Make sure that nothing is resting on the keyboard.
- Make sure that a key is not stuck. Press each key to loosen a key that might be stuck, then restart your tablet PC.

## Memory

### You see a “Memory error” message

- Make sure that the memory modules are inserted correctly in the memory bay slots. For more information, see “Adding or replacing memory” on page 222.
- Use a third-party diagnostic program to help determine if a memory module is failing. For more information, see “Adding or replacing memory” on page 222.

### You see a “Not enough memory” error message

- Close all programs, then restart your tablet PC.

#### Help and Support



For more information about troubleshooting memory errors, tap **Start**, then tap **Help and Support**.

Type the keyword **memory error** in the Help and Support Center **Search** box  , then tap the arrow.

# Modem

## Your modem does not dial or does not connect

- Make sure that the modem cable is plugged into the modem jack and not the Ethernet network jack. See “Ports side” on page 7 and “Back” on page 229 to make sure that the connection has been made correctly.
- Make sure that your tablet PC is connected to the telephone line and the telephone line has a dial tone.
- Make sure that the modem cable is less than 6 feet (1.8 meters) long.
- Remove any line splitters or surge protectors from your telephone line, then check for a dial tone by plugging a working telephone into the telephone wall jack.
- If you have additional telephone services such as call waiting, call messaging, or voice mail, make sure that all messages are cleared and call waiting is disabled before using the modem. Contact your telephone service to get the correct code to temporarily disable the service. Also make sure that the modem dialing properties are set appropriately.



### To check the dialing properties:

- 1 Tap **Start**, then tap **Control Panel**. The *Control Panel* window opens. If your Control Panel is in Category View, tap **Printers and Other Hardware**.
- 2 Tap/Double-tap the **Phone and Modem Options** icon, then tap the **Dialing Rules** tab.
- 3 Tap the location from which you are dialing, then tap **Edit**.
- 4 Make sure that all settings are correct.



### Help and Support



For more information about dialing properties, tap **Start**, then tap **Help and Support**.

Type the keyword **dialing** in the Help and Support Center **Search** box  , then tap the arrow.

- Disconnect any answering machine, fax machine, or printer that is on the same line as the modem. Do not connect these devices to the same telephone line as the modem.
- Make sure that you are not using a digital, rollover, or PBX line. These lines do not work with your modem.
- Check for line noise (scratchy, crackling, or popping sounds). Line noise is a common problem that can cause the modem to connect at a slower rate, abort downloads, or even disconnect. The faster the modem, the less line noise it can tolerate and still work correctly.

Listen to the line using your telephone. Dial a single number (such as 1). When the dial tone stops, listen for line noise. Wiggle the modem cable to see if that makes a difference. Make sure that the connectors are free from corrosion and all screws in the wall or telephone wall jack are secure.

You can also call your telephone service and have the telephone line checked for noise or low line levels.

- Try another telephone line (either a different telephone number in your house or a telephone line at a different location). If you can connect on this line, call your telephone service.
- Try connecting with the modem at a lower connection speed. If reducing the connect speed lets you connect, call your telephone service. The telephone line may be too noisy.

### **You cannot connect to the Internet**

- The ISP may be having technical difficulties. Contact your ISP for technical support.
- See if the modem works with a different communications program. The problem may be with just one program.

### **Your 56K modem does not connect at 56K**

Current FCC regulations restrict actual data transfer rates over public telephone lines to 53K. Other factors, such as line noise, telephone service provider equipment, or ISP limitations, may lower the speed even further.

If your tablet PC has a v.90 modem, the speed at which you can upload (send) data is limited to 33.6K. If your tablet PC has a v.92 modem, the speed at which you can upload data is limited to 48K. Your ISP may not support 48K uploads.

You can check modem connection speeds and dial-up network (DUN) connections by accessing the *gateway.your.way dial-up server*. The server also contains drivers, patches, and updates for current Gateway hardware and software.

The server provides a secure connection and is a stand-alone server. You cannot use it to access the Internet. The server cannot be accessed Mondays from 8:00 a.m. to 12:00 p.m. CT.



### To access the *gateway.your.way dial-up server*:

- 1 Insert the red Gateway CD into the DVD/CD-RW drive.
- 2 Tap **Help**, then tap **Support Web Site**.
- 3 To check your modem connection speed, tap the **Direct Dial** option. After your modem connects, move the pointer over the **Dial-Up Networking** icon (located next to the clock on your taskbar). Your modem connection speed appears.



### **Your fax communications program only sends and receives faxes at 14,400 bps when you have a 56K modem**

Current fax technology only supports a maximum send and receive rate of 14,400 bps.

### **The modem is not recognized by your tablet PC**

- Make sure that the line connected to the modem is working and plugged into the appropriate port on your tablet PC. See “Ports side” on page 7 and “Back” on page 229 to make sure that the connections have been made correctly.
- If the modem shares the telephone line with another device, make sure that the telephone line is not in use (for example, someone is on the telephone, or another modem is in use).
- Use the modem cable that came with your tablet PC. Some telephone cables do not meet required cable standards and may cause problems with the modem connection.
- Shut down and restart your tablet PC.
- Run Windows modem diagnostics.

 **To run modem diagnostics:**

- 1** Close all open programs.
- 2** Tap **Start**, then tap **Control Panel**. The *Control Panel* window opens. If your Control Panel is in Category View, tap **Printers and Other Hardware**.
- 3** Tap/Double-tap the **Phone and Modem Options** icon, then tap the **Modems** tab.
- 4** Tap your modem, then tap **Properties**. The *Modem Properties* dialog box opens.
- 5** Tap the **Diagnostic** tab, then tap **Query Modem**. If information about the modem appears, the modem passed diagnostics. If no modem information is available, a white screen appears with no data, or if you get an error such as *port already open* or *the modem has failed to respond*, the modem did not pass diagnostics.



**Help and Support**



For more information about modem troubleshooting, tap **Start**, then tap **Help and Support**.

Type the keyword **modem troubleshooting** in the Help and Support Center **Search** box  , then tap the arrow.

**The modem is noisy when it dials and connects**

When your modem tries to connect to another modem, it begins *handshaking*. Handshaking is a digital “getting acquainted” conversation between the two modems that establishes connection speeds and communication protocols. You may hear unusual handshaking sounds when the modems first connect. If the handshaking sounds are too loud, you can turn down the modem volume.

 **To turn down the modem volume:**

- 1** Tap **Start**, then tap **Control Panel**. The *Control Panel* window opens. If your Control Panel is in Category View, tap **Printers and Other Hardware**.
- 2** Tap/Double-tap the **Phone and Modem Options** icon, then tap the **Modems** tab.



- 3 Tap the modem you want to adjust, then tap **Properties**.
- 4 Tap the **Modem** tab, then adjust the **Speaker volume** control.
- 5 Tap **OK** twice to close the *Phone and Modem Options* dialog box.



## Mouse

### The external mouse does not work

- Make sure that the mouse cable is plugged in correctly.
- Shut down and restart your tablet PC.
- Remove all extension cables and switch boxes.
- Try a mouse you know is working to make sure that the mouse port works.

### The external mouse works erratically

- Clean the mouse. For more information, see “Cleaning the mouse” on page 204.
- Some mouse pad patterns “confuse” optical mice. Try the mouse on a different surface.

## Networks

### You cannot connect to your company network

Every network is unique. Contact your company computer department or network administrator for help.

### Data does not transfer through wired Ethernet.

- The cable is not connected correctly. Reconnect and check for activity in green and orange lights next to the LAN port.

#### Help and Support



For more information about network troubleshooting, tap **Start**, then tap **Help and Support**.

Type the keyword **network troubleshooting** in the Help and Support Center **Search** box  **Search** , then tap the arrow.



## Operating system

**The program I am working in has stopped responding but the cursor moves and other programs work**

- The program has crashed. Press the Security button  on the Gateway Tablet PC's front to open the Task Manager and close the non-responsive program.

**The tablet keeps showing the wrong date and time even after resetting**

- The CMOS battery on the system board may need to be replaced. Contact Gateway technical support.

**The tablet seems to be operating more slowly than usual**

- The hard drive is full or nearly full. Run the Disk Cleanup utility to clear out unnecessary and temporary files, and remove unneeded programs and files. For more information, see “Using Disk Cleanup” on page 196.
- The hard drive needs defragmenting. Run Disk Defragmenter to consolidate files and folders on the hard drive. For more information, see “Defragmenting the hard drive” on page 199.
- The tablet is in Portrait or Secondary Landscape orientation. Though changing the orientation should not slow the tablet considerably, try changing back to Primary Landscape orientation.

## Passwords

**Your tablet PC does not accept your password**

Make sure that CAPS LOCK and PAD LOCK are turned off, then retype the password.

**You forgot your startup password**

The password feature (which is set in the BIOS Setup utility) is very secure, with no easy way to recover a forgotten password. You must return your tablet PC for repair. Call Gateway Technical Support for instructions.

## PC Cards

### **You installed a PC Card and now your tablet PC is having problems**

- Make sure that you have correctly installed required software for the PC Card. For more information, see your PC Card's documentation.
- Make sure that the PC Card you installed is not causing a system resource conflict. For more information on resource conflicts, see "Device installation" on page 240.

## Pen

### **The tablet does not respond to the pen**

- You are not using the correct pen. Use only Penabled digitizer pens by Wacom such as your tablet's pen. The Gateway Tablet PC does not respond to some other tablet pens or plastic pens.

### **The pen tip does not line up with the pointer when I tap the screen**

- The pen and display need recalibrating in both Landscape and Portrait mode. Recalibrate through the **Pen Settings** tab of the *Tablet and Pen Settings* dialog box. For more information, see "Adjusting tablet and pen settings" on page 158.

## Power

### **Your tablet PC is not working on AC power**

- Make sure that your AC power adapter is connected correctly to your tablet PC. For more information, see "Connecting the AC adapter" on page 21.
- If your tablet PC is plugged into a surge protector, make sure that the surge protector is connected securely to an electrical outlet, turned on, and working correctly. To test the outlet, plug a working device, such as a lamp, into the outlet and turn it on.
- Make sure that the AC power adapter cables are free from cuts or damage. Replace any damaged cables.

### **Your tablet PC is not working on battery power**

- Make sure that the battery is installed correctly. For more information, see "Changing batteries" on page 131.

- Make sure that the battery is fully recharged. For more information, see “Recharging the battery” on page 130.

### **Your tablet PC lost data during battery swap**

- Battery swap took too long.
  - Before swapping batteries, save all active files.
  - Make sure the replacement battery is charged.
  - Put the tablet into Standby.
  - Take no more than a minute swapping batteries—the quicker the better

### **The battery seems to run down very quickly**

- Peripheral devices and programs that make heavy use of the hard drive drain the battery more quickly. Use AC power whenever possible, and readjust the **Power Properties** to **Max Battery** when AC power is unavailable.
- The battery is weakening or defective. All batteries run down in time, but if a new battery appears to be defective, contact Gateway about replacing it.

### **The tablet will not turn on**

- The Power switch has not been fully engaged. Slide and hold the Power switch for at least a half-second, but no more than three seconds.
- The battery is fully discharged but AC power is not connected. Connect the AC adapter to power the tablet and charge the battery.

### **The tablet turns on and the hard drive status indicator flashes, but nothing appears on the display**

- Display brightness is set too low. Shut down and restart the tablet. If the problem continues, connect an external VGA monitor and adjust the brightness in Tablet and Pen Settings. For more information, see “Adjusting brightness” on page 150.

### **The tablet will not enter Hibernate mode**

- Hibernate mode is not activated. For more information, see “Activating and using Hibernate mode” on page 140.

### **The tablet will not come out of Standby or Hibernate mode when running on battery power.**

- The battery fully discharged and AC power is not connected. Connect the AC power adapter to power the tablet and charge the battery.

### The display goes black while the tablet is still turned on

- Tablet has gone into Standby after sitting idle (power status indicator is blinking green). Slide and hold the Power switch for about a second to resume operations.
- Tablet has gone into low-battery Hibernate (power status indicator is blinking green). Slide and hold the Power switch for about a second to resume operations, and charge the battery.

## Printer

### The printer will not turn on

- Make sure that the printer is online. Many printers have an online/offline button that you may need to press.
- Make sure that the power cable is plugged into an AC power source.

### The printer is on but will not print

- Check the cable between the printer and your tablet PC. Make sure that it is connected to the correct port.
- Make sure that the printer is online. Many printers have an online/offline button that you may need to press so the printer can start printing. Press the button to put the printer online.
- Check the port and cable for bent or broken pins.
- If the printer you want to print to is not the default printer, make sure that you have selected it in the printer setup.



### To set a default printer:

- 1 Tap **Start**, then tap **Control Panel**. The *Control Panel* window opens. If your Control Panel is in Category View, tap **Printers and Other Hardware**.
- 2 Tap/Double-tap the **Printers and Faxes** icon. The *Printers and Faxes* window opens.
- 3 Button-tap the name of the printer you want to be the default printer, then tap **Set as Default Printer**.



- Reinstall the printer driver. See the guide that came with your printer for instructions on installing the printer driver.

### You see a “Printer queue is full” error message

- Make sure that the printer is not set to work offline.



#### To make sure that the printer is not set to work offline:

- 1 Tap **Start**, then tap **Control Panel**. The *Control Panel* window opens. If your Control Panel is in Category View, tap **Printers and Other Hardware**.
- 2 Tap/Double-tap the **Printers and Faxes** icon. The *Printers and Faxes* window opens.
- 3 Button-tap the name of the printer you want to use. If the menu shows a check mark next to **Use Printer Offline**, tap **Use Printer Offline** to clear the check mark.



#### Help and Support



For more information about printer troubleshooting, tap **Start**, then tap **Help and Support**.

Type the keyword **printer troubleshooter** in the Help and Support Center **Search** box  **Search** , then tap the arrow.

- Wait until files have been printed before sending additional files to the printer.
- If you print large files or many files at one time, you may want to add additional memory to the printer. See the printer documentation for instructions for adding additional memory.

### You see a “Printer is out of paper” error message

After adding paper, make sure that the printer is online. Most printers have an online/offline button that you need to press after adding paper.

## Sound

### The built-in microphone does not seem to hear my voice correctly

- The built-in microphone's frequency response is too low for your purposes. Headset microphones are recommended for those using dictation frequently.
- Something is connected to the microphone jack. Unplug the device.

### You are not getting sound from the built-in speakers

- Make sure that headphones are not plugged into the headphone jack. For the location of the headphone jack, see "Ports side" on page 7 and "Back" on page 229.
- Make sure that the Windows volume control is turned up. For more information, see "Adjusting the volume" on page 86.
- Make sure that mute controls are turned off. For more information about the mute setting, see "Adjusting the volume" on page 86.

#### Help and Support



For more information about troubleshooting sound issues, tap **Start**, then tap **Help and Support**.

Type the keyword **sound troubleshooter** in the Help and Support Center **Search** box  , then tap the arrow.

## Video

### The external monitor is not working

- Make sure that the monitor is turned on and that the video cable is connected correctly.

## Wireless Ethernet

When using wireless connectivity in low-reception areas, be sure to keep your hands clear of the antenna zones.

### Wireless communications keeps connecting even when I do not want it to

- The default setting is **On**. For more information, see "Turning your wireless Ethernet on or off" on page 177.

# FAQs

## How long will the battery stay charged?

This can vary according to usage conditions, but a new, fully charged standard battery can last several hours.

## Are there ways to make the battery charge last longer?

- Adjust the Power properties to **Max Battery** (double-tap the taskbar's **Power** icon to open the menu)
- Dim the display brightness (double-tap the taskbar's **Tablet** icon and choose the **Display** tab)
- Disconnect LAN/modem connections and disable wireless communications when not in use (uncheck the **Wireless Communications** check box in the **Motion Dashboard**)
- Turn off optional and unnecessary background programs and turn off or disconnect unused peripheral devices from USB and IEEE 1394 ports

## What is the average life of the battery?

This varies widely, depending on usage patterns and conditions.

## What does the tablet need for use in another country?

Just an outlet adapter, which you can find in airports and travel stores. The AC adapter will adjust automatically to different voltage when plugged into the correct location-appropriate power adapter. You should also bring a modem adapter.

## What is the best way to clean the display screen?

Use the soft cloth, dry or dampened, that came with your Gateway Tablet PC. Do not use spray cleaners or spray/pour any liquid on any surface of the tablet.

## Will scratches affect the display's performance?

Testing has not found appreciable loss of performance on a scratched display.

## How sensitive is the screen to sunlight and the elements?

As with any computer or electronic device, the Gateway Tablet PC should be protected from liquids, dirt and sand, other contaminants, and extreme heat.

### **Will the tablet work with any monitor or USB peripheral keyboard, mouse, or drive?**

Any device will work as long as the device's driver is available either in Windows XP or from the manufacturer, and it carries the Windows XP logo or certification. See [www.microsoft.com/hcl](http://www.microsoft.com/hcl) for more information.

### **Why does the tablet and FlexDock not have parallel, serial, or PS2 ports?**

Microsoft Tablet PC certification requires the tablet to be completely Grab-and-Go—that is, to be able to dock with and undock from all peripheral devices without putting the tablet into suspend or shutting it down. Connection through legacy ports (serial, parallel, PS2) often requires suspending or restarting the tablet, which prevents you from moving between desktop mode and mobile mode seamlessly in one docking/undocking step.

### **How do I adjust the tablet for left-handed use?**

Through the **Settings** tab of the *Tablet and Pen Settings* dialog box. Access it by double-tapping on the **Tablet and Pen Settings** icon in the taskbar.

### **How can I improve the wireless signal?**

Make sure that the antenna zone is not covered up by hands, cases, or other objects.



# Telephone support

## Before calling Gateway Technical Support

If you have a technical problem with your tablet PC, follow these recommendations before contacting Gateway Technical Support:

- Make sure that your tablet PC is connected correctly to a grounded AC outlet that is supplying power. If you use a surge protector, make sure that it is turned on.
- If a peripheral device, such as a keyboard or mouse, does not appear to work, make sure that all cables are plugged in securely.
- If you have recently installed hardware or software, make sure that you have installed it according to the instructions provided with it. If you did not purchase the hardware or software from Gateway, see the manufacturer's documentation and technical support resources.
- If you have "how to" questions about using a program, see:
  - Online Help
  - Printed documentation
  - The Microsoft Windows documentation
  - The software publisher's Web site
- See the troubleshooting section of this chapter.

### Warning



To avoid bodily injury, do not attempt to troubleshoot your tablet PC problem if:

- Power cords or plugs are damaged
- Liquid has been spilled into your tablet PC
- Your tablet PC was dropped
- The case was damaged

Instead, unplug your tablet PC and contact a qualified computer technician.

- Have your customer ID, serial number, and order number available, along with a detailed description of your problem, including the exact text of any error messages, and the steps you have taken.
- Make sure that your tablet PC is nearby at the time of your call. The technician may have you follow troubleshooting steps.

## Telephone numbers

Gateway offers a wide range of customer service, technical support, and information services.

### Automated troubleshooting system

Service description	How to reach
Use an automated menu system and your telephone keypad to find answers to common problems.	800-846-2118 (US) 877-709-2945 (Canada)

### Telephone numbers

You can access the following services through your telephone to get answers to your questions:

Resource	Service description	How to reach
Fax on demand support	Order a catalog of documents on common problems, then order documents by document numbers. The documents will be faxed to you.	800-846-4526 (US) 877-709-2951 (Canada)
Gateway's fee-based software tutorial service	Get tutorial assistance for software issues billed by the minute.	800-229-1103 (charged to your credit card) 900-555-4695 (charged to your telephone bill)
Gateway Technical Support	Talk to a Gateway Technical Support representative about a non-tutorial technical support question. (See "Before calling Gateway Technical Support" on page 263 before calling.) TDD Technical Support (for hearing impaired) is available: Weekdays 6:00 a.m. - 8:00 p.m. Central Time Weekends 6:00 a.m. - 5:00 p.m. Central Time	800-846-2301 (US) 800-846-3609 (Canada and Puerto Rico) 605-232-2191 (all other countries) 800-846-1778 (TDD)
Sales, accounting, and warranty	Get information about available systems, pricing, orders, billing statements, warranty service, or other non-technical issues.	800-846-2000 (US) 888-888-2037 (Canada)

# Tutoring and training

Gateway's Technical Support professionals cannot provide hardware and software training or tutorial services. Instead, Gateway recommends the following tutoring and training resources.

## Self-help

If you have *how-to* questions about using your Gateway-supplied hardware or software, see the following resources:

- The printed or online documentation that came with your hardware or software. In many cases, additional product information and online documentation for Gateway-supplied hardware can be found in our Web site's Documentation Library.
- This user's guide.
- The software publisher's Web site.

### Help and Support



For more how-to information about Windows XP, tap **Start**, then tap **Help and Support**.

Type the keyword **practice** in the Help and Support Center **Search** box  **Search**  , then tap the arrow.

## Tutoring

For help on using hardware or software that came with your Gateway tablet PC, contact Gateway's fee-based tutorial hotline:

- 800-229-1103 (rate charged per minute; charged to a major credit card)
- 900-555-4695 (rate charged per minute; charged to your telephone bill)

# Training

Gateway provides the following in-person and computerized training:

Resource	Service description	For more information
In-Store Training at Gateway stores	Our friendly and knowledgeable software trainers can teach you how to use the Internet and the most popular software programs, including Microsoft Word, Excel, and PowerPoint.	<a href="http://www.gateway.com/store">www.gateway.com/store</a>
Gateway Learning Libraries	A variety of courses and tutorials are available on CD. Select from several easy-to-use learning libraries.	<a href="http://www.gateway.com/training">www.gateway.com/training</a>
Online Training from Learn@Gateway	More than 450 online courses are available from Learn@Gateway. All you have to do is go online and log in. You select the subject matter, and the learning format (self-paced tutorials or virtual classrooms), all from the comfort of your tablet PC.	<a href="http://www.learnatgateway.com/">www.learnatgateway.com/</a>



# Safety, Regulatory, and Legal Information

# A

## Important safety information

Your Gateway system is designed and tested to meet the latest standards for safety of information technology equipment. However, to ensure safe use of this product, it is important that the safety instructions marked on the product and in the documentation are followed.

### Warning



Always follow these instructions to help guard against personal injury and damage to your Gateway system.



## Setting up your system

- Read and follow all instructions marked on the product and in the documentation before you operate your system. Retain all safety and operating instructions for future use.
- Do not use this product near water or a heat source such as a radiator.
- The product should be operated only from the type of power source indicated on the rating label.
- Openings in the computer case are provided for ventilation. Do not block or cover these openings. Make sure you provide adequate space, at least 6 inches (15 cm), around the system for ventilation when you set up your work area. Never insert objects of any kind into the computer ventilation openings.
- If you use an extension cord with this system, make sure that the total ampere rating on the products plugged into the extension cord does not exceed the extension cord ampere rating.

## Care during use

- Do not walk on the power cord or allow anything to rest on it.
- Do not spill anything on the system. The best way to avoid spills is to avoid eating and drinking near your system.
- When the computer is turned off, a small amount of electrical current still flows through the computer. To avoid electrical shock, always unplug all power cables and modem cables from the wall outlets before cleaning the system.
- Unplug the system from the wall outlet and refer servicing to qualified personnel if:
  - The power cord or plug is damaged.
  - Liquid has been spilled into the system.
  - The system does not operate properly when the operating instructions are followed.
  - The system was dropped or the cabinet is damaged.
  - The system performance changes.

## Replacement parts and accessories

Use only replacement parts and accessories recommended by Gateway.

### Important



Do not use Gateway products in areas classified as hazardous locations. Such areas include patient care areas of medical and dental facilities, oxygen-laden environments, or industrial facilities.

### Warning



To reduce the risk of fire, use only No. 26 AWG or larger telecommunications line cord.

# Regulatory compliance statements

## Wireless Guidance

Low power, Radio transmitting type devices (radio frequency (RF) wireless communication devices), may be present (embedded) in your notebook system. These devices may operate in the 2.4 GHz (i.e. 802.11B/G LAN & Bluetooth), 5.2 GHz (i.e. 802.11A LAN), and traditional cellular or PCS cellular bands (i.e. Cellular data modem). The following section is a general overview of considerations while operating a wireless device.

Additional limitations, cautions, and concerns for specific countries are listed in the specific country sections (or country group sections). The wireless devices in your system are only qualified for use in the countries identified by the Radio Approval Marks on the system rating label. If the country you will be using the wireless device in, is not listed, please contact your local Radio Approval agency for requirements. Wireless devices are closely regulated and use may not be allowed.

The power output of the wireless device or devices that may be embedded in your notebook is well below the RF exposure limits as known at this time. Because the wireless devices (which may be embedded into your notebook) emit less energy than is allowed in radio frequency safety standards and recommendations, Gateway believes these devices are safe for use. Regardless of the power levels, care should be taken to minimize human contact during normal operation.

The wireless devices installed in this system are intended to be used indoors. In some areas, use of these devices outdoors is prohibited.

Some circumstances require restrictions on wireless devices. Examples of common restrictions are listed below:

### Warning



Radio frequency wireless communication can interfere with equipment on commercial aircraft. Current aviation regulations require wireless devices to be turned off while traveling in an airplane. 802.11B (also known as wireless Ethernet or Wifi) and Bluetooth communication devices are examples of devices that provide wireless communication.

### Warning



In environments where the risk of interference to other devices or services is harmful or perceived as harmful, the option to use a wireless device may be restricted or eliminated. Airports, Hospitals, and Oxygen or flammable gas laden atmospheres are limited examples where use of wireless devices may be restricted or eliminated. When in environments where you are uncertain of the sanction to use wireless devices, ask the applicable authority for authorization prior to use or turning on the wireless device.

**Warning**



Every country has different restrictions on the use of wireless devices. Since your system is equipped with a wireless device, when traveling between countries with your system, check with the local Radio Approval authorities prior to any move or trip for any restrictions on the use of a wireless device in the destination country.

**Warning**



If your system came equipped with an internal embedded wireless device, do not operate the wireless device unless all covers and shields are in place and the system is fully assembled.

**Warning**



Wireless devices are not user serviceable. Do not modify them in any way. Modification to a wireless device will void the authorization to use it. Please contact Gateway for service.

**Warning**



Only use drivers approved for the country in which the device will be used. See the Gateway System Restoration Kit, or contact Gateway Technical Support for additional information.

**Warning**



In order to comply with FCC requirements this transmitter must not be operated (or co-located) in conjunction with any other transmitter or antenna installed in the notebook.



# United States of America

## Federal Communications Commission (FCC) Intentional emitter per FCC Part 15

Low power, Radio transmitter type devices (radio frequency (RF) wireless communication devices), operating in the 2.4 GHz band and/or 5.15 – 5.35 GHz band, may be present (embedded) in your notebook system. This section is only applicable if these devices are present. Refer to the system label to verify the presence of wireless devices.

Wireless devices that may be in your system are only qualified for use in the United States of America if an FCC ID number is on the system label.

This equipment complies with FCC radio frequency electromagnetic signal (RF) exposure limits set forth for an uncontrolled environment of a portable transmitting device.

The wireless devices installed in this system are intended to be used indoors. In some areas, use of these devices outdoors is prohibited.

Operation of this device is subject to the following two conditions: (1) This device may not cause harmful interference, and (2) this device must accept any interference received, including interference that may cause undesired operation of the device.

### Warning



Wireless devices are not user serviceable. Do not modify them in any way. Modification to a wireless device will void the authorization to use it. Contact Gateway for service.

## Unintentional emitter per FCC Part 15

This device has been tested and found to comply with the limits for a Class B digital device, pursuant to Part 15 of the FCC rules. These limits are designed to provide reasonable protection against harmful interference in a residential installation. This equipment generates, uses, and can radiate radio frequency energy and, if not installed and used in accordance with the instructions, may cause harmful interference to radio or television reception. However, there is no guarantee that interference will not occur in a particular installation. If this equipment does cause interference to radio and television reception, which can be determined by turning the equipment off and on, the user is encouraged to try to correct the interference by one or more of the following measures:

- Reorient or relocate the receiving antenna
- Increase the separation between the equipment and receiver
- Connect the equipment into an outlet on a circuit different from that to which the receiver is connected
- Consult the dealer or an experienced radio/TV technician for help.

**Compliance Accessories:** The accessories associated with this equipment are: shielded video cable when an external monitor is connected. These accessories are required to be used in order to ensure compliance with FCC rules.

## FCC declaration of conformity

### Responsible party:

Gateway Companies, Inc.  
610 Gateway Drive, North Sioux City, SD 57049  
(605) 232-2000 Fax: (605) 232-2023

### Product:

- Gateway Tablet PC M1300

This device complies with Part 15 of the FCC Rules. Operation of this product is subject to the following two conditions: (1) this device may not cause harmful interference, and (2) this device must accept any interference received, including interference that may cause undesired operation.

### Caution



Changes or modifications not expressly approved by Gateway could void the FCC compliance and negate your authority to operate the product.

## **Telecommunications per FCC part 68 (applicable to products fitted with USA modems)**

Your modem complies with Part 68 of the Federal Communications Commission (FCC) rules. On the computer or modem card is a label that contains the FCC registration number and Ringer Equivalence Number (REN) for this device. If requested, this information must be provided to the telephone company.

An FCC-compliant telephone line cord with a modular plug is required for use with this device. The modem is designed to be connected to the telephone network or premises wiring using a compatible modular jack which is Part 68-compliant. See installation instructions for details.

The Ringer Equivalence Number (REN) is used to determine the number of devices which may be connected to the telephone line. Excessive RENs on a telephone line may result in the devices not ringing in response to an incoming call. In most areas, the sum of RENs should not exceed five (5.0). To be certain of the number of devices that may be connected to a line, as determined by the total RENs, contact the local telephone company.

If this device causes harm to the telephone network, the telephone company will notify you in advance that temporary discontinuance of service may be required. The telephone company may request that you disconnect the equipment until the problem is resolved.

The telephone company may make changes in its facilities, equipment, operations, or procedures that could affect the operation of this equipment. If this happens, the telephone company will provide advance notice in order for you to make necessary modifications to maintain uninterrupted service.

This equipment cannot be used on telephone company-provided coin service. Connection to party line service is subject to state tariffs. Contact the state public utility commission or public service commission for information.

When programming or making test calls to emergency numbers:

- Remain on the line and briefly explain to the dispatcher the reason for the call.
- Perform such activities in the off-peak hours such as early morning or late evenings.

The United States Telephone Consumer Protection Act of 1991 makes it unlawful for any person to use a computer or other electronic device to send any message via a telephone fax machine unless such message clearly contains, in a margin at the top or bottom of each transmitted page or on the first page of the transmission, the date and time it is sent, an identification of the business, other entity, or other individual sending the message, and the telephone number of the sending machine or such business, other entity, or individual. Refer to your fax communication software documentation for details on how to comply with the fax-branding requirement.

# Canada

## Industry Canada (IC)

### Intentional emitter per RSS 210

Low power, Radio transmitter type devices (radio frequency (RF) wireless communication devices), operating in the 2.4 GHz band and/or 5.15 – 5.35 GHz band, may be present (embedded) in your notebook system. This section is only applicable if these devices are present. Refer to the system label to verify the presence of wireless devices.

Wireless devices that may be in your system are only qualified for use in Canada if an Industry Canada ID number is on the system label.

This equipment complies with Industry Canada radio frequency electromagnetic signal (RF) exposure limits.

Operation of this device is subject to the following two conditions: (1) This device may not cause harmful interference, and (2) this device must accept any interference received, including interference that may cause undesired operation of the device.

#### Warning



To prevent radio interference to licensed service or co-channel Mobile Satellite systems, this device is intended to be operated indoors and away from windows to provide maximum shielding. Equipment (or its transmit antenna) that is installed outdoors is subject to licensing.

#### Warning



Wireless devices are not user serviceable. Do not modify them in any way. Modification to a wireless device will void the authorization to use it. Contact Gateway for service.

#### Warning



The transmitting device embedded in this system may not be used with any antenna other than provide with the system.

#### Warning



The 802.11A radio LAN your system may have been equipped with operates in the same frequency range as high power radar, which has priority use, and may damage the radio LAN if both are present and being used in the same area.

### Unintentional emitter per ICES-003

This digital apparatus does not exceed the Class B limits for radio noise emissions from digital apparatus as set out in the radio interference regulations of Industry Canada.

Le présent appareil numérique n'émet pas de bruits radioélectriques dépassant les limites applicables aux appareils numériques de Classe B prescrites dans le règlement sur le brouillage radioélectrique édicté par Industrie Canada.

### Telecommunications per Industry Canada CS-03 (for products fitted with an IC-compliant modem)

The Industry Canada label identifies certified equipment. This certification means that the equipment meets certain telecommunications network protective, operation, and safety requirements. The Department does not guarantee the equipment will operate to the users' satisfaction.

Before installing this equipment, users should make sure that it is permissible to be connected to the facilities of the local telecommunications company. The equipment must also be installed using an acceptable method of connection. In some cases, the inside wiring associated with a single-line individual service may be extended by means of a certified connector assembly. The customer should be aware that compliance with the above conditions may not prevent degradation of service in some situations.

Repairs to certified equipment should be made by an authorized Canadian maintenance facility designated by the supplier. Any repairs or alterations made by the user to this equipment, or equipment malfunctions, may give the telecommunications company cause to request the user to disconnect the equipment.

Users should make sure, for their own protection, that the electrical ground connections of the power utility, telephone lines, and internal metallic water pipe system, if present, are connected together. This precaution may be particularly important in rural areas.

#### Warning



To avoid electrical shock or equipment malfunction do not attempt to make electrical ground connections by yourself. Contact the appropriate inspection authority or an electrician, as appropriate.

The **Ringer Equivalence Number (REN)** assigned to each terminal device provides an indication of the maximum number of terminals allowed to be connected to a telephone interface. The termination on an interface may consist of any combination of devices subject only to the requirement that the sum of the Ringer Equivalence Numbers of all the devices does not exceed 5.

# Mexico

## Intentional emitter

Low power, Radio transmitter type devices (radio frequency (RF) wireless communication devices), operating in the 2.4 GHz band, may be present (embedded) in your notebook system. This section is only applicable if these devices are present. Refer to the system label to verify the presence of wireless devices.

Wireless devices that may be in your system are only qualified for use in Mexico if a COFETEL or SCT ID is on the system label.

This equipment complies with radio frequency electromagnetic signal (RF) exposure limits.

## Unintentional emitter

At this time there are no mandatory requirements for Unintentional Emitters. However, this device does comply with multiple requirements for other countries and regions as listed on the system label and in the user's manual.

# Laser safety statement

All Gateway systems equipped with CD and DVD drives comply with the appropriate safety standards, including IEC 825. The laser devices in these components are classified as "Class 1 Laser Products" under a US Department of Health and Human Services (DHHS) Radiation Performance Standard. Should the unit ever need servicing, contact an authorized service location.

### Warning



Use of controls or adjustments or performance of procedures other than those specified in this manual may result in hazardous radiation exposure. To prevent exposure to laser beams, do not try to open the enclosure of a CD or DVD drive.

# California Proposition 65 Warning

### Warning



This product contains chemicals, including lead, known to the State of California to cause cancer and/or birth defects or reproductive harm.

# Notices

Copyright © 2003 Gateway, Inc.  
 All Rights Reserved  
 14303 Gateway Place  
 Poway, CA 92064 USA

## All Rights Reserved

This publication is protected by copyright and all rights are reserved. No part of it may be reproduced or transmitted by any means or in any form, without prior consent in writing from Gateway.

The information in this manual has been carefully checked and is believed to be accurate. However, changes are made periodically. These changes are incorporated in newer publication editions. Gateway may improve and/or change products described in this publication at any time. Due to continuing system improvements, Gateway is not responsible for inaccurate information which may appear in this manual. For the latest product updates, consult the Gateway Web site at [www.gateway.com](http://www.gateway.com). In no event will Gateway be liable for direct, indirect, special, exemplary, incidental, or consequential damages resulting from any defect or omission in this manual, even if advised of the possibility of such damages.

In the interest of continued product development, Gateway reserves the right to make improvements in this manual and the products it describes at any time, without notices or obligation.

## Trademark Acknowledgments

1-800-GATEWAY, ActiveCPR, ALR, AnyKey, black-and-white spot design, CrystalScan, Destination, DestiVu, EZ Pad, EZ Point, Field Mouse, Gateway 2000, Gateway Country, gateway.net, Gateway stylized logo, Perfect Scholar, Solo, TelePath, Vivitron, stylized "G" design, and "You've got a friend in the business" slogan are registered trademarks and black-and-white spotted box logo, GATEWAY, Gateway Astro, Gateway@Work, Gateway Connected touch pad, Gateway Connected music player, Gateway Cyber:)Ware, Gateway Education:)Ware, Gateway Flex Case, Gateway Gaming:)Ware, Gateway GoBack, Gateway Gold, Gateway Learning:)Ware, Gateway Magazine, Gateway Micro Server, Gateway Money:)Ware, Gateway Music:)Ware, Gateway Networking Solutions, Gateway Online Network (O.N.) solution, Gateway Photo:)Ware, Gateway Professional PCs, Gateway Profile, Gateway Solo, green stylized GATEWAY, green stylized Gateway logo, Gateway Teacher:)Ware, Gateway Video:)Ware, HelpSpot, InforManager, Just click it!, Learn@Gateway, Kids BackPack, SERVE-TO-ORDER, Server Watchdog, the Spotted G Gateway Logo and the Spotted G Logo, SpotShop, Spotshop.com, and Your:)Ware are trademarks of Gateway, Inc. Intel, Intel Inside logo, and Pentium are registered trademarks and MMX is a trademark of Intel Corporation. Microsoft, MS, MS-DOS, and Windows are trademarks or registered trademarks of Microsoft Corporation. All other product names mentioned herein are used for identification purposes only, and may be the trademarks or registered trademarks of their respective companies.

## Macrovision statement

**If your computer has a DVD drive and an analog TV Out port, the following paragraph applies:**

This product incorporates copyright protection technology that is protected by method claims of certain U.S. patents and other intellectual property rights owned by Macrovision Corporation and other rights owners. Use of this copyright protection technology must be authorized by Macrovision Corporation, and is intended for home and other limited viewing uses only unless otherwise authorized by Macrovision Corporation. Reverse engineering or disassembly is prohibited.





# Index

## A

- AC adapter
  - connecting 21
  - connector 6, 230
  - conserving battery power 133
  - damaged 23
  - defective 24
  - FAQ 261
  - foreign use 261
  - international adapters 133
  - outlet 14
  - troubleshooting 257
- access point network 173
- accessories 13
  - safety precautions 268
- accounts
  - ISP 79
  - user 162
- acoustic handset coupler 144
- ad hoc networking 175, 176
- adding
  - icons to desktop 58
  - user accounts 162
  - See also* installing
- address
  - e-mail 83
  - Web 81
- airplane power adapter 13, 134
- alarms 135, 137
- antenna zone 6, 10
- application key 34
- arrow keys 34
- AU file 91
- audio
  - headphone jack 8, 229
  - microphone jack 8, 229
  - muting 86
  - playing 89, 91
  - recording 89
  - streaming 167

- troubleshooting 260

- audio CD

- See* CD

- audio file

- streaming 167

- automobile power adapter 13, 133, 134

- AVI file 91

## B

- background 155

- backing up files 201

- battery

- alarm options 135, 137

- alternate power sources 133

- bay 9, 131

- changing 131

- charge status 128

- charging 21, 130

- conserving power 133

- FAQ 261

- gauge 10, 129

- icons 128

- installing 131

- latch 10

- managing power 133

- meter 129

- monitoring charge 128

- purchasing 13

- recharging 21, 130

- release latch 10

- replacing 131

- safety guidelines 19

- status indicator 5, 23, 129

- storing 188

- troubleshooting 256

- bays

- battery 9, 131

- memory 10, 222

- BIOS Setup utility 146

- brightness

- adjusting 150, 161
- broadband Internet connection 41, 78, 166
- browser
  - Web 79, 80
- browsing for files and folders 66
- buttons 3
  - Esc 4
  - Fn 4
  - Hot Key 4
  - programming 159
  - security 4, 255
  - setting functions 248
- button-tapping 28

## C

- cable lock
  - tablet PC 9
  - using while traveling 146
- cable modem 41, 78, 170, 173
- calibrating 29, 161, 256
- camera
  - See* digital camera
  - See* digital video camera
- Caps Lock indicator 36
- capturing video 114
- cards
  - adding PC Card 218
  - eject button 218, 220
  - inserting PC Card 218
  - installing PC Card 218
  - PC Card eject button 218, 220
  - PC Card slot 6, 218
  - reinstalling PC Card 218
  - removing PC Card 218
  - replacing PC Card 218
  - troubleshooting PC Card 256
- care and maintenance 147, 188
- carrying case 13
- CD
  - cleaning 245
  - copying 108
  - creating data 100
  - creating music 104
  - inserting 96
  - playing music 97
  - troubleshooting 243
- CD drive
  - See* DVD/CD-RW drive
- CD-RW
  - See* CD
- CD-RW drive
  - See* DVD/CD-RW drive
- Certificate of Authenticity 12
- cleaning
  - audio CD 245
  - case 203
  - CD 245
  - DVD 245
  - keyboard 203
  - LCD panel 204
  - mouse 204
  - screen 204
  - tablet PC exterior 203
  - tablet PC screen 204
- clicking 28, 38
- clipboard 63
- close button 60
- closing
  - program 60, 75
  - unresponsive program 27
  - window 60, 75
- color
  - changing depth 151
  - changing desktop 155
  - changing number of 151
  - changing scheme 154
- connecting
  - AC adapter 21
  - camera 112, 114
  - digital camera 112
  - digital video camera 114
  - diskette drive 93
  - DVD/CD-RW drive 94
  - external keyboard 33
  - external monitor 111

- keyboard 33
- modem 39
- printer 41, 184
- scanner 41, 184
- surge protector 24
- to Ethernet 40
- to Internet 41
- to network 40
- to Web site 81
- video camera 114
- connections
  - AC adapter 6, 14, 230
  - audio 8, 229
  - digital camera 7, 228, 229
  - digital video camera 41, 114, 229
  - diskette drive 7, 228, 229
  - Ethernet 7, 40, 229
  - external speakers 8, 229
  - Firewire 7, 41, 114, 229
  - FlexDock 7
  - headphone 8, 14, 229
  - i.Link 7, 41, 114, 229
  - IEEE 1394 7, 14, 41, 114, 229
  - keyboard 7, 228, 229
  - LAN 7, 14, 40, 229
  - microphone 8, 14, 229
  - modem 7, 39
  - monitor (VGA) 7, 14, 111, 230
  - mouse 7, 228, 229
  - network 7, 40, 229
  - power 6, 21, 230
  - printer 7, 228, 229
  - scanner 7, 228, 229
  - speaker 8, 229
  - troubleshooting 248
  - USB 7, 14, 41, 228, 229
  - VGA 7, 14, 111, 230
  - video camera 7, 114, 229
  - Zip drive 7, 228, 229
- copying
  - CD 108
  - files and folders 63, 75
  - text and graphics 75
- copyright notice 277
- creating
  - data CD 100
  - data DVD 100
  - desktop icons 58
  - desktop shortcuts 58
  - documents 71
  - folders 62
  - movies 114
  - music CD 104
  - startup diskette 191
- cursor pad 4
- Customer Service
  - Accounting 264
  - Sales 264
  - Warranty 264
- customizing 149
- cutting
  - files and folders 63, 75
  - text and graphics 75
- D**
- Dashboard 4, 131, 160
  - Standby button 131
  - wireless operations 177
- default printer 258
- defragmenting hard drive 199
- deleting files and folders 56, 65, 66, 75, 196
- desktop 55
  - adding icons 58
  - adding shortcuts 58
  - adjusting settings 151
  - changing background 155
  - changing color depth 151
  - changing color scheme 154
  - changing number of colors 151
  - selecting screen saver 157
  - using 56
  - using Start menu 56
- device drivers
  - See drivers
- dialing codes 144

- digital camera
    - connecting 112
    - USB port 7, 228, 229
  - digital photography
    - connecting a digital camera 112
  - digital video camera
    - connecting 114
    - IEEE 1394 port 7, 229
  - directional keys 34
  - Disk Cleanup 196
  - Disk Defragmenter 199
  - diskette
    - creating startup 191
    - inserting 93
    - troubleshooting 241
    - write-protecting 192
  - diskette drive 93
    - activity indicator 93
    - eject button 93
    - troubleshooting 241
    - using 93
  - display
    - adjusting brightness 150
    - brightness 150
    - changing orientation 150
    - changing resolution 152
    - cleaning 261
    - conserving battery power 133
    - maintaining 188
    - orientation 150, 255
    - performance 261
    - properties 111
    - settings 151
    - troubleshooting 242, 243, 258
    - using 28
    - using screen saver 157
  - Do More With Gateway 49
  - docking connector 7, 231, 235
  - documentation
    - eSupport 51
    - Gateway Web site 51
    - help 47
    - HelpSpot 47
    - online help 50
  - documents
    - creating 71
    - opening 73
    - printing 74
    - saving 72
  - double-clicking 28, 38
  - double-tapping 28
  - downloading files 82
  - dragging 38
  - drivers 209
    - reinstalling 209
    - updating 52, 211
  - drives 133
    - backing up files 201
    - checking for errors 198
    - checking for free space 196
    - defragmenting 199
    - deleting files 196
    - diskette 93
    - DVD/CD-RW 94, 100
    - sharing 166
    - troubleshooting 241, 243, 245
    - viewing contents 61
    - viewing files and folders 61
  - DSL modem 41, 78, 170, 173
  - DVD
    - cleaning 245
    - creating data 100
    - inserting 96
    - playing 99
    - troubleshooting 243
  - DVD drive
    - See* DVD/CD-RW drive
  - DVD/CD-RW drive
    - activity indicator 96
    - eject button 96
    - manual eject hole 96
    - troubleshooting 243
    - using 94, 100
- E**
- eject button

- diskette drive 93
- DVD/CD-RW drive 96
- electrostatic discharge (ESD) 221
- e-mail 79, 83
  - address 83
  - checking for messages 84
  - sending 83
  - transferring settings from old computer 184
- emergency startup diskette 191
- EmPower power adapter 133
- Error-checking 198
- escape button 3, 4
- eSupport 12
  - using 52
- Ethernet
  - connecting 40
  - jack 7, 40, 229
  - troubleshooting 254
  - turning wireless Ethernet on or off 177
  - wired network 168, 169
  - wireless network 168, 172
- external monitor 230
- EZ Pad touchpad
  - See* touchpad

## F

- FAQs 261
- Fast Ethernet 169
- faxes 115
  - automatically canceling 125
  - canceling 123
  - configuring Fax 117
  - failed transmission 125
  - installing Fax 116
  - receiving and viewing 123
  - retrying 124
  - sending 120
  - sending from program 122
  - sending scanned image 122
  - setting up cover page template 121
  - troubleshooting 252

- files
  - backing up 201
  - copying 63, 75
  - cutting 63, 75
  - deleting 56, 65, 75, 196
  - downloading 82
  - finding 66, 68
  - moving 63
  - opening 38, 56
  - pasting 63, 75
  - recovering 65
  - renaming 75
  - searching for 66, 68, 181
  - transferring 145, 181
  - troubleshooting 245
  - types 181
  - viewing list 61
- Files and Settings Transfer Wizard 180
- finding
  - files and folders 66, 68, 181
  - HelpSpot topics 48
  - specifications 12
- Firewire port 7, 41, 114, 229
- FlexDock
  - docking connector 7
  - purchasing 14
  - setting up 233
  - troubleshooting 248
- floppy disk
  - See* diskette
- Fn button 3, 4
- Fn key 34, 35
- folders
  - copying 63, 75
  - creating 62
  - cutting 63, 75
  - deleting 56, 65, 75
  - finding 66, 68
  - moving 63
  - opening 38, 61
  - pasting 63, 75
  - recovering 65
  - renaming 75

- searching for 66, 68
- viewing list 61
- fragmentation 199
- Frequently Asked Questions (FAQs) 261
- function keys 34

## **G**

- game
  - multi-player 167
- Gateway
  - eSupport 12
  - model number 11
  - serial number 11, 12
  - Web address 51
  - Web site 51
- gateway.your.way dial-up server 251
- Get Going with Tablet PC 45
- gigabit Ethernet 169

## **H**

- hard drive
  - backing up files 201
  - bay 9
  - checking for errors 198
  - checking for free space 196
  - defragmenting 199
  - deleting files and folders 196
  - scanning for errors 198
  - status indicator 5
  - troubleshooting 245, 255
- hard top 188
- headphone
  - jack 8, 14, 229
- help
  - online 50
  - using 47
- Help and Support Center 44, 47, 54
  - searching 48
  - starting 47
- Hibernate mode 6, 26, 134, 140
  - troubleshooting 258
- home office network 165
- Hot Key 1 3, 4, 160

- Hot Key 2 3, 4, 150
- hot-swapping 41, 218
- hyperlinks 80

## **I**

- i.Link port 7, 41, 114, 229
- IEEE 1394 port 7, 41, 114, 229
- IEEE 802.11 168, 172
  - using while traveling 145
- indicators
  - See status indicators
- Inkball 46, 54
- inkjet printer 15
- installing
  - battery 131
  - camera 112
  - cards 218
  - device drivers 209
  - devices 41, 240
  - digital camera 41, 112
  - digital video camera 41
  - drivers 209
  - Fax 116
  - InterVideo DVD player 99
  - memory 222
  - Microsoft Fax 116
  - Nero Express 100
  - PC Card 218
  - peripheral devices 41, 184
  - printer 41, 184
  - programs 185, 212
  - scanner 41, 184
  - Windows 214
- Internal wireless label 11
- Internet 78
  - account 79
  - broadband connection 41
  - connecting to 81
  - downloading files 82
  - requirements to access 79
  - sharing access 166
  - transferring settings from old computer 183

- troubleshooting 246
- Internet connection
  - sharing 166
  - troubleshooting 246, 251
- Internet service provider (ISP) 78, 79
  - setting up account 79
  - transferring settings from old computer 183
- IRQ conflicts 240
- ISP
  - See* Internet service provider

## **J**

- jacks
  - See* connections

## **K**

- Kensington cable lock 146
  - lock slot 9
- key combinations 35
- keyboard
  - buttons 33
  - cleaning 203
  - connecting 33
  - features 33
  - icon 31
  - shortcuts 75
  - troubleshooting 248
  - USB port 7, 228, 229
- keys
  - application 34
  - arrow 34
  - directional 34
  - Fn 34, 35
  - function 34
  - navigation 34
  - numeric keypad 34
  - Pad Lock 35
  - Scroll Lock 35
  - system 34
  - system key combinations 35
  - Windows 34

## **L**

- label
  - internal wireless 11
  - Microsoft Certificate of Authenticity 12
  - model number 11
  - serial number 11
  - wireless networking 11
- laser printer 15
- latch
  - battery 10
- LCD panel
  - changing resolution 152
  - cleaning 204
  - troubleshooting 242
  - using screen saver 157
- line protector 144
- line tester 144
- links 80
- lock
  - Kensington cable 9, 146

## **M**

- maintenance 187
  - backing up files 201
  - checking for drive errors 198
  - checking hard drive space 196
  - cleaning case 203
  - cleaning component exteriors 203
  - cleaning computer display 204
  - cleaning keyboard 203
  - cleaning mouse 204
  - creating startup diskette 191
  - defragmenting 199
  - deleting files 196
  - display screen 188
  - general guidelines 188, 189
  - pen 189
  - suggested schedule 190
  - using Scheduled Task Wizard 201
  - virus protection 193
- Max Battery power setting 133, 257, 261

- maximize button 60
  - Media Player 91, 97
  - memory
    - adding 222
    - bay 10
    - installing 222
    - purchasing 15
    - removing 222
    - replacing 222
    - troubleshooting 249
    - upgrading 222
  - menu bar 60
  - messages
    - checking e-mail 84
    - sending e-mail 83
  - microphone
    - built-in 3
    - jack 8, 14, 229
    - troubleshooting 260
  - Microsoft
    - Certificate of Authenticity 12
    - Fax 115
    - Wordpad 71
  - MIDI file 91
  - minimize button 60
  - model number 11, 146
  - modem
    - cable 41, 78
    - connecting 39
    - connecting to Internet 79
    - connection speed 251
    - DSL 41, 78
    - international adapter 144
    - jack 7, 39
    - protecting from power surge 24
    - troubleshooting 250
  - monitor
    - adding an external 111
    - changing resolution 152
    - color quality 111
    - controls 151
    - display properties 111
    - port 7, 230
  - screen resolution 111
    - using screen saver 157
    - VGA port 7, 230
  - mouse
    - cleaning 204
    - troubleshooting 254
    - USB port 7, 228, 229
  - moving
    - files 63
    - files from old computer 179, 181
    - folders 63
    - Internet settings from old computer 183
    - pointer 38
    - screen objects 38
    - settings from old computer 179
  - MP3 file 91
    - playing 91
    - streaming 167
  - MPEG file
    - See* MP3 file
  - multimedia
    - adjusting volume 86
    - playing audio CD 97
    - playing DVD 99
    - recording audio 89
    - using CD drive 94
    - using diskette drive 93
    - using DVD drive 94
    - using Windows Media Player 91, 97, 99
  - multi-player game
    - playing 167
  - music
    - See* audio
  - muting sound 86
- N**
- navigation keys 34
  - Nero Express 100, 104, 108
  - NeroVision Express 114
  - network
    - jack 7, 40, 229



- troubleshooting 254
- network equipment shopping list 171, 174, 176
- networking
  - access point 173, 174
  - ad hoc 175, 176
  - computers 165
  - data transfer speed 169, 172
  - Ethernet 168, 169
  - games 167
  - internal wireless label 11
  - peer-to-peer 175, 176
  - selecting connection type 168
  - sharing devices 167
  - sharing drives 166
  - sharing Internet connections 166
  - sharing printers 167
  - signal strength 172
  - streaming audio 167
  - streaming video 167
  - turning off wireless Ethernet 177
  - turning on wireless Ethernet 177
  - wired connections 168, 169
  - wireless connections 168, 172
- non-technical support
  - Accounting 264
  - Sales 264
  - Warranty 264
- Norton Antivirus 193, 194
- numeric keypad 34
  - status indicator 35, 36
- O**
- online help 47, 50
- opening
  - documents 73
  - files 38, 56
  - folders 38, 61
  - programs 38, 56
  - shortcut menu 38
- operating system
  - troubleshooting 255
- orientation

changing 150

## **P**

- Pad Lock
  - status indicator 35, 36
  - system key 35
- password 146, 255
- pasting
  - files and folders 63, 75
  - text and graphics 75
- PC Card
  - See* cards
- PCMCIA card
  - See* cards
- peer-to-peer networking 175, 176
- pen 3, 28
  - button 30
  - calibrating 29, 256
  - care 189
  - gestures 30
  - replacing point 189
  - tether anchor 6
  - tips 31
  - troubleshooting 256
- peripheral devices
  - FlexDock 14, 227
  - installing 41
  - purchasing 15
  - troubleshooting 257
- photography
  - See* digital photography
- playing
  - audio CD 97
  - audio file 89, 91
  - DVD 99
  - Media Player file 91
  - multimedia files 91
  - multi-player games 167
  - music CD 97
  - Windows Media Player file 91
- Plug and Play devices
  - IEEE 1394 support for 41
  - USB support for 41

- pointer 37
    - moving 38
  - ports
    - See* connections
  - power
    - AC adapter 21, 133
    - advanced settings 135, 139
    - alarms 135, 137
    - automobile/airplane adapter 133, 134
    - battery 27, 128, 130, 131, 133
    - changing modes 134
    - changing schemes 136
    - changing settings 135
    - connector 6, 21, 230
    - conserving battery power 133
    - damaged cord 23, 24
    - EmPower adapter 133
    - extending battery life 133
    - Hibernate mode 134, 140
    - indicator 26
    - international adapter 147
    - management 127, 133
    - schemes 135, 136
    - source problems 24
    - SpeedStep settings 135
    - Standby mode 26, 134
    - status indicator 5
    - surge protector 24
    - switch 6, 25, 135
    - troubleshooting 256, 257
    - turning off tablet PC 26
    - turning on tablet PC 25
  - power adapter
    - airplane 13
    - automobile 13
  - power management
    - Max Battery setting 133
  - Power Options Properties 6
  - Power/Battery icon 133
  - printer
    - default 258
    - inkjet 15
    - installing 41, 184
    - laser 15
    - sharing 167
    - troubleshooting 258
    - USB port 7, 228, 229
  - printing documents 74
  - programs
    - closing 75
    - closing unresponsive 27
    - Dashboard 160
    - installing 185, 212
    - opening 38, 56
    - reinstalling 185, 212
- ## R
- radio approval authorities 145
  - radio frequency wireless connections 145
  - RAM
    - See* memory
  - rebooting tablet PC 27
  - recharging battery 130
  - recordable drive
    - activity indicator 96
    - eject button 96
    - manual eject hole 96
    - troubleshooting 243
    - using 94, 100
  - recording
    - audio file 89
    - data CD 100
    - data DVD 100
    - music CD 104
  - recovering files and folders 65
  - Recycle Bin 56
    - deleting files and folders 65
    - emptying 66
    - recovering files and folders 65
  - re-dialing telephone 124
  - reinstalling
    - drivers 209
    - peripheral devices 184
    - printer 184

- programs 185, 212
- scanner 184
- software 185, 212
- Windows 214
- removing files and folders 56, 65, 66, 75, 196
- renaming files and folders 75
- replacing
  - See* installing
- resetting tablet PC 27
- resolution
  - changing 152
- restarting tablet PC 27
- Restoration CDs 208
- restoring files and folders 65
- right-clicking 28, 38
- rotating
  - display orientation 161
  - tablet in FlexDock 232
- router 170, 171

## **S**

- safety
  - caring for computer 189
  - general precautions 18, 20, 267
  - guidelines for troubleshooting 238
  - static electricity 221
- saving documents 72
- ScanDisk
  - See* Error-checking
- scanner
  - installing 41, 184
  - USB port 7, 228, 229
- scanning drive
  - for errors 198
  - for viruses 193
- Scheduled Tasks Wizard 201
- screen
  - adjusting settings 151
  - changing color depth 151
  - changing number of colors 151
  - changing resolution 152
  - resolution 111
  - saver 157
  - troubleshooting 242, 260
- screen objects
  - getting information 38
  - moving 38
  - selecting 38
- Scroll Lock
  - status indicator 35, 36
  - system key 35
- Search utility 68
- searching
  - for files and folders 66, 68, 181
  - in Help and Support Center 48
- security button 3, 4
- security features
  - Kensington cable lock 9
- security while travelling 146
- serial number 11, 12, 146
- setting up
  - safety precautions 268
- sharing
  - devices 167
  - drives 166
  - Internet connection 166
  - printer 167
  - See also* networking
- shortcut menus
  - accessing 38
- shortcuts
  - adding to desktop 58
  - closing programs 75
  - closing windows 75
  - copying 75
  - cutting 75
  - deleting files and folders 75
  - keyboard 75
  - opening menu 38
  - pasting 75
  - renaming files and folders 75
  - selecting adjacent items in list 75
  - selecting items in list 75
  - switching between files, folders, or programs 75

- shutting down tablet PC 26, 27
- small office network 166
- SO-DIMM 222
- software
  - See programs
- sound
  - adjusting 86
  - controls 86
  - muting 86
  - troubleshooting 260
- Sound Recorder
  - making audio recordings 89
  - playing file 89
- speakers
  - built-in 8
  - jack 8, 229
- specifications 12
- speech recognition 31, 54, 162
- SpeedStep technology 135
- Standby 6, 26, 131, 231
  - troubleshooting 258
- Standby mode 26, 134
- Start button 56
- Start menu 56
- starting
  - programs 38, 56
  - tablet PC 25
- startup
  - diskette 191
  - password 146
- static electricity 221
- status indicators
  - battery status 5, 129
  - Caps Lock 36
  - hard drive 5
  - location 3
  - numeric keypad 35, 36
  - Pad Lock 35, 36
  - power 5
  - Scroll Lock 35, 36
  - wireless Ethernet activity 5
- Sticky Notes 54
- streaming audio and video 167

- support
  - Help and Support Center 44, 54
- surge protector 24
- system identification label 11
- system keys 34
  - combinations 35
- System Properties 242

## T

- Tablet and Pen Settings 54, 158, 262
- Tablet PC Input Panel 4, 31, 54
- Take a Tour of Windows XP 45
- tapping 28
- Task Manager 4
- taskbar 56
- Technical Support 264
- technical support
  - automated troubleshooting 264
  - eSupport 12
  - FaxBack support 264
  - resources 263
  - Technical Support 264
  - tips before contacting 263
  - tutorial service 264
- telephone
  - acoustic handset coupler 144
  - automatically canceling fax 125
  - canceling fax 123
  - configuring Fax 117
  - installing Fax 116
  - line protector 144
  - line tester 144
  - receiving and viewing faxes 123
  - retrying fax 124
  - sending fax 120
  - sending faxes from program 122
  - sending scanned image fax 122
  - setting up fax cover page template 121
  - using Fax 115
- telephone support 263
- tips
  - pen 31

- title bar 60
- touchpad
  - buttons 37
  - clicking 38
  - double-clicking 38
  - dragging screen objects 38
  - moving pointer 37, 38
  - moving screen objects 38
  - opening files, folders, and programs 38
  - opening shortcut menu 38
  - right-clicking 38
  - selecting screen objects 38
- training
  - CD 266
  - classroom 266
  - Gateway Learning Libraries 266
  - Learn@Gateway 266
- transferring
  - files from Internet 82
  - files from old computer 179, 181
  - Internet settings from old computer 183
  - settings from old computer 179
- travel 261
  - international 147
  - travel tips 143
  - wireless on airplanes 145
- troubleshooting 240
  - audio 260
  - automated system 264
  - cleaning CD 245
  - cleaning DVD 245
  - device installation 240
  - diskette drive 241
  - display 242
  - DVD/CD-RW drive 243
  - Error-checking 198
  - faxed answers 264
  - faxes 252
  - files 245
  - FlexDock 248
  - gateway.your.way dial-up server 251
  - general guidelines 239
  - hard drive 245
  - Internet connection 246, 251
  - IRQ conflict 240
  - keyboard 248
  - LCD panel 242
  - memory 249
  - modem 250
  - mouse 254
  - network 254
  - passwords 255
  - PC Cards 256
  - power 256
  - printer 258
  - reinstalling drivers 209
  - safety guidelines 238
  - screen 242, 260
  - screen area 242
  - screen resolution 242
  - sound 260
  - technical support 263
  - telephone support 263
  - video 260
  - Web site connection speed 247
- turning off
  - tablet PC 26, 27
  - wireless Ethernet 177
- turning on
  - tablet PC 25
  - wireless Ethernet 177
- tutorial 44
- tutoring
  - fee-based 265

**U**

- updating
  - device drivers 52, 211
  - Norton Antivirus 193
- upgrading 217
- USB flash drive 13
- USB port 7, 41, 228, 229
- user accounts
  - adding 162

switching 162

## V

VGA port 111

video

capture 114

playing 91, 99

streaming 167

troubleshooting 260

video camera

connecting 114

video file

streaming 167

virus

protecting against 193

removing with Norton AntiVirus  
193

voice recognition 54

volume

adjusting 86, 161

adjusting modem 253

controls 86

muting 86

troubleshooting 260

## W

waking up tablet PC 26

WAV file 91

Web browser 79, 80

Web page 80

Web site 80

connecting to 81

downloading files 82

Gateway 51

window 59

close button 60

closing 60, 75

maximize button 60

menu bar 60

minimize button 60

title bar 60

Windows

clipboard 63

desktop 55

Files and Settings Transfer Wizard  
180

installing 214

Product Key Code 12

reinstalling 214

reinstalling drivers 209

Search utility 68

updating drivers 211

Windows Journal 4, 54

Windows key 34

Windows Media Player 91, 97, 99

Windows Movie Maker 114

Windows XP Tablet PC Edition 54

wired Ethernet network 168, 169

equipment list 171

example 170

wireless Ethernet

antenna zone 6, 10

conserving battery power 133

FAQ 261

label 11

status indicator 5

troubleshooting 260

using while traveling 145

wireless Ethernet network 168, 172

access point equipment list 174

access point example 173

ad hoc equipment list 176

ad hoc example 175

peer-to-peer equipment list 176

peer-to-peer example 175

turning off 177

turning on 177

Wordpad 71

World Wide Web (WWW) 80

downloading files 82

write-protection for diskettes 192

writing 28, 31

## Z

Zip drive 201

USB port 7, 228, 229



MAN US TABLET PC USR GDE R2 5/03



8509095