

Remote controller

Model No.: EL0678

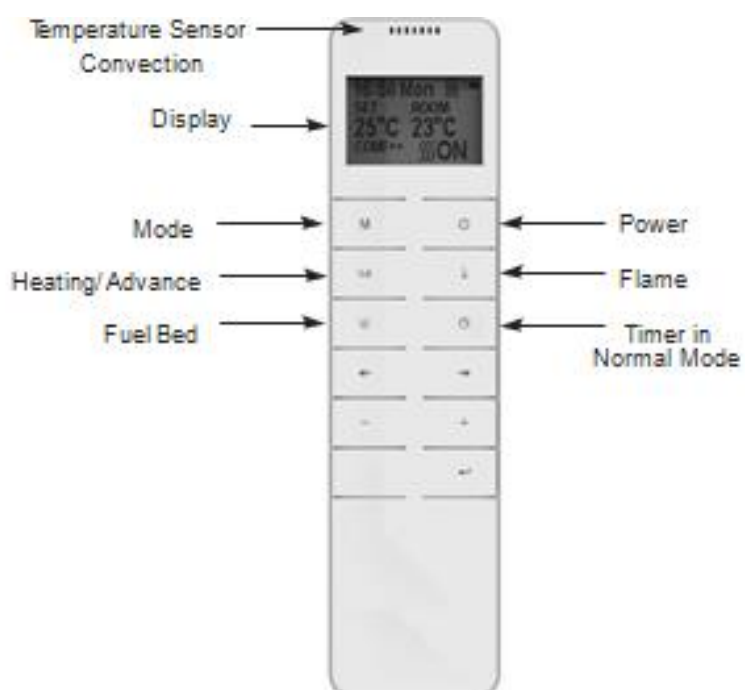

Please read the instructions carefully before use of this remote controller and retained for future reference.

User Instructions

1. APPLIANCE DATA AND IMPORTANCE WARNINGS

1.1 Appliance data

Voltage.....3VDC
Frequency.....ASK/OOK 433.92MHZ
Maximum transmit power.....10Mw
Hardware version: RF290A-TX-V1.3
Software version:RF290A_C_V0.6.0.hex

1.2 Importance warnings

1.2.1 FCC Statement:

This device complies with Part 15 of the FCC Rules. Operation is subject to the following two conditions:
(1) This device may not cause harmful interference, and
(2) This device must accept any interference received, including interference that may cause undesired operation.

Note: This product has been tested and found to comply with the limits for a Class B digital device, pursuant to Part 15 of the FCC Rules. These limits are designed to provide reasonable protection against harmful interference in a residential installation. This product generates, uses, and can radiate radio frequency energy and, if not installed and used in accordance with the instructions, may cause harmful interference to radio communications. However, there is no guarantee that interference will not occur in a particular installation. If this product does cause harmful interference to radio or television reception, which can be determined by turning the equipment off and on, the user is encouraged to try to correct the interference by one or more of the following measures:

- Reorient or relocate the receiving antenna.
- Increase the separation between the equipment and receiver.
- Connect the equipment into an outlet on a circuit different from that to which the receiver is connected.
- Consult the dealer or an experienced radio/TV technician for help.

Please take attention that changes or modification not expressly approved by the party responsible for compliance could void the user's authority to operate the equipment.

1.2.2 IC Statement :

This device complies with Industry Canada licence-exempt RSS standard(s). Operation is subject to the following two conditions:

- (1) this device may not cause interference, and
- (2) this device must accept any interference, including interference that may cause undesired operation of the device.

Le présent appareil est conforme aux CNR d'Industrie Canada applicables aux appareils radioexempts de licence. L'exploitation est autorisée aux deux conditions suivantes :

- (1) l'appareil ne doit pas produire de brouillage, et
- (2) l'utilisateur de l'appareil doit accepter tout brouillage radioélectrique subi, même si le brouillage est susceptible d'en compromettre le fonctionnement.

Under Industry Canada regulations, this radio transmitter may only operate using an antenna of a type and maximum (or lesser) gain approved for the transmitter by Industry Canada. To reduce potential radio interference to other users, the antenna type and its gain should be so chosen that the equivalent isotropically radiated power (e.i.r.p.) is not more than that necessary for successful communication.

Conformément à la réglementation d'Industrie Canada, le présent émetteur radio peut fonctionner avec une antenne d'un type et d'un gain maximal (ou inférieur) approuvé pour l'émetteur par Industrie Canada. Dans le but de réduire les risques de brouillage radioélectrique à l'intention des autres utilisateurs, il faut choisir le type d'antenne et son gain de sorte que la puissance isotrope rayonnée équivalente (p.i.r.e.) ne dépasse pas l'intensité nécessaire à l'établissement d'une communication satisfaisante.

2. Operations

2a. Manual Control Panel

- 2a.1 The manual controls on appliance are located at the upper right of appliance.
- 2a.2 Turning on the appliance with the main power switch on '—' position. A long beep will be heard.
- 2a.3 Press "LIGHTS ON/OFF" to turn on or turn off both the flame and fuel bed at the same time.
- 2a.4 There are 3 flame colour options:
Press "FLAME" button to select the colour of flame (3 kinds of flame colour with flame) or return to the OFF position.
- 2a.5 Press "FUEL BED" button to select the colour of fuel bed (14 kinds of fuel bed) or return to the OFF position.

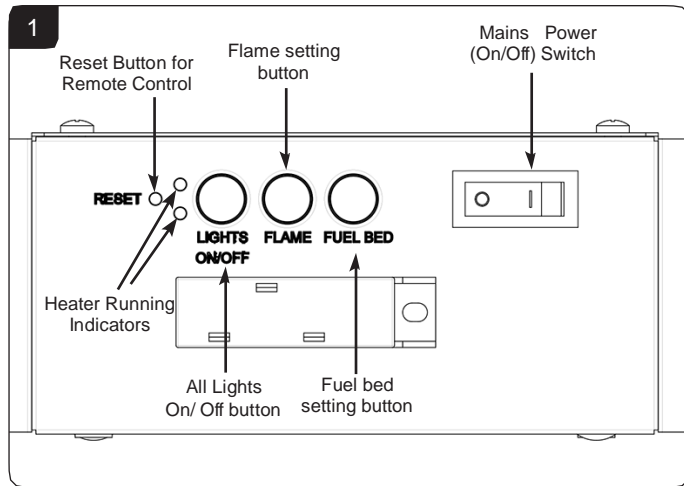

Note: The remote control will lose the memory for all function settings when the switch is set to the Off Position. When the remote runs out of power, only the light functions will lose memory.

Heater Running Indicators (see Diagram 1)

- 2a.6 When the fan heater is used in conjunction with the flame or fuel bed effects the heater running indicators will light up for 10 seconds.

The LEDs will illuminate for 10 seconds if the flame or fuel bed effect is On.
If the fan heater is used independently, the heater running indicators will stay on.

Reset Button for Remote Control

- 2a.7 If the handset loses signal or needs to be replaced then, see Section 17 in Servicing Section for details.

2b. Remote Controls

The remote control should be left on a flat surface in the room where the appliance is installed and away from any direct flow of hot air.

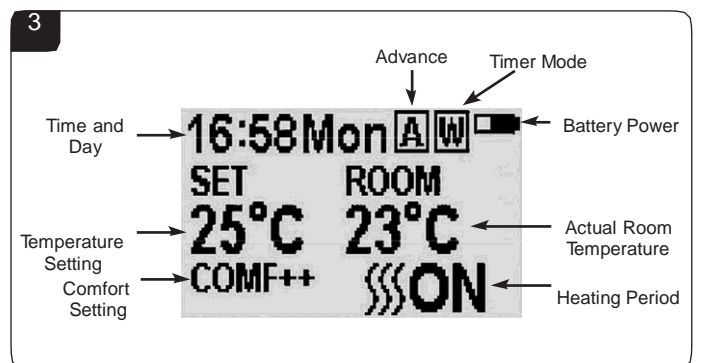
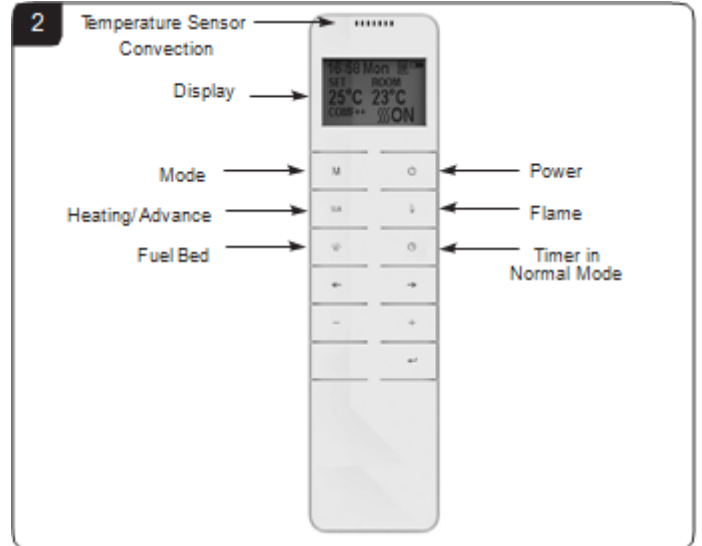



Signal Code

- 2b.1 The remote control works by radio signal.
The handheld transmitter is configured in the factory with a unique signal code.

IMPORTANT: If the handset loses signal or needs to be replaced then, see Section 17 in Servicing Section for details.

Turn on/off.

- 2b.2 Press  button to turn on the flame effect.
- 2b.3 Press  button to turn off all the functions under the normal heating control mode including flame effect and fan heater.
- 2b.4 Press  button to turn off the flame effect under daily and week timer heating mode.

User Instructions

Flame Colour Adjustment

2b.5 Press  button to enter the flame adjustment screen.

There are 3 flame colour options, indicated by the number shown in Diagram 4.

There are 6 levels of brightness, including off. This is indicated by the bar, with the blank bar indicating off, see Diagram 4.

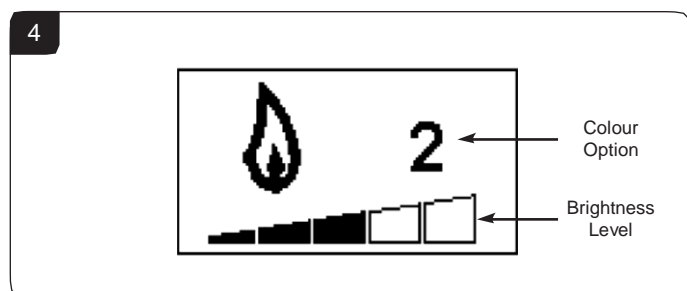

2b.6 Press the '←' or '→' button to cycle through the flame colour options.

2b.7 Press the '+' button to increase the flame brightness.

Press the '-' button to decrease the flame brightness until off.

Fuel Bed Colour Adjustment

2b.8 Press  to enter the fuel bed light adjustment screen.

There are 14 fuel bed colour options, indicated by the number shown in Diagram 5.

There are 6 levels of brightness, including off. This is indicated by the bar, with the blank bar indicating off, see Diagram 5.

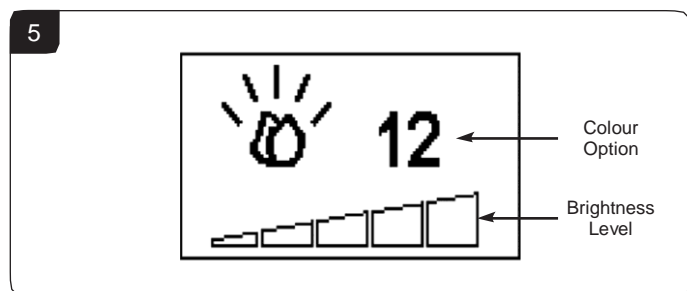

2b.9 Press the '←' or '→' button to cycle through the fuel bed colour options.

2b.10 Press the '+' button to increase the fuel bed brightness.

Press the '-' button to decrease the fuel bed brightness until off.



Normal Control Mode

2b.11 Normal Control Mode is the default setting.

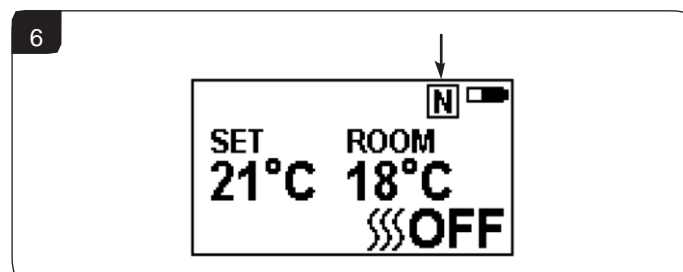
Alternatively press **M** button until the **N** logo is shown at the upper right corner of the screen, see Diagram 6.



2b.12 Press the '+' or '-' button to adjust the setting temperature from 17 °C to 25°C.

2b.13 Press  **A** button to turn the heat on/off,  ON or  OFF will show at the lower right corner of the screen, see Diagram 7.

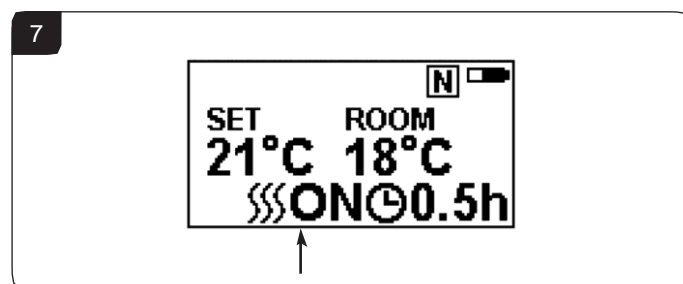

Note: It is normal for the fan heater to stop running for periods of time. This happens if the room temperature is higher than the temperature set on the control.

The heater indicator will be turned off after 10s if the flame is switched ON. The heater indicator will stay ON if only the heating function is used.

When in Normal Control Mode switching the appliance off with the remote will stop both the light and heat output.

Count Down Timer

This setting is only in normal heating control mode. It allows the appliance to be returned to Standby after a set period of time. The heater must be switched on to use this function.



2b.14 Press  to cycle through the setting from Off and 0.5 hours to 9 hours. Timer logo and remaining time will show on the screen.

The heater of appliance can be automatically run by using daily timer and weekly timer on the remote.

User Instructions

Battery

The battery power level is indicated at the top right of the remote control screen, see Diagram 3.

	Battery Full	No action required
	Battery Half Power	Ensure new batteries are available.
	Battery Empty	Replace batteries immediately

Battery replacement is recommended after 1 year. The Remote requires two 1.5V alkaline AAA batteries.

Changing the batteries will not affect the Timer Mode settings, however, the clock may need adjusting.

Week Days/ Time/ Comfort Temperature and Unit Setting

2b.15 Keep pressing **M** button for 3 seconds to enter the setting screen.

2b.16 Press the '←' or '→' button to choose setting to change.

The selected character will be highlighted, see Diagram 8.

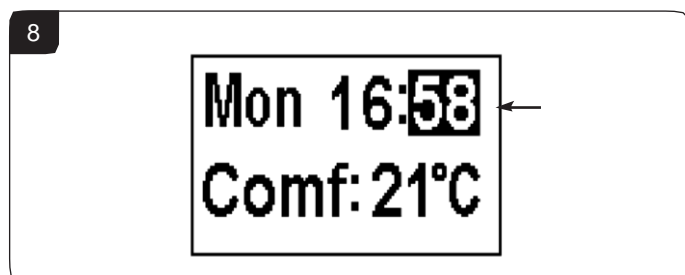

2b.17 Press the '+' or '-' button to adjust the number.

Time: 24-hour system.
Select Comfort temperature from 15–25°C.
Temperature unit: °C/°F.

2b.18 Press the ← button for 3 seconds or wait 10 seconds to save and exit the week, time and heating temperature setting.

Daily Timer Heating

2b.19 The following heating periods have been preset, these can be altered if desired:

06:00 until 08:00
17:00 until 22:00

2b.20 Press **M** until **D** shows at the upper right corner of the screen to enter the daily timer heating mode.

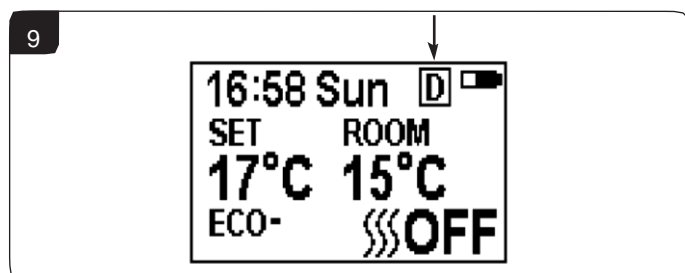

2b.21 Hold the ← button for 6 seconds to enter the daily heating setting.

A maximum of 3 timed heating periods can be set per day.

2b.22 Press '←' or '→' to choose hour or minute,

2b.23 Press '+' or '-' to set the number.

The minute increment / decrement by 15min per press.

10

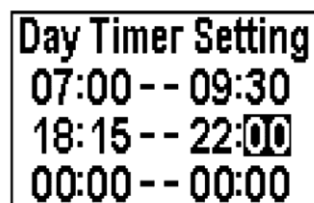

2b.24 Hold the ← button for 3 seconds or wait for 10 seconds to save and exit the heating time period setting.

2b.25 Check the timer setting. Press ← to check the daily timer mode.

2b.26 If the heating needs to be turned off, it will be necessary to go back to the Normal Control Mode to it turn off.

When in Daily Timer Mode switching the appliance off with the remote will stop the light output. The heat output will continue according to the timer settings.

Adjusting the Set Temperature

2b.27 Press the '+' or '-' button to increase or decrease the temperature on the basis of COMF temperature.

COMF means the actual temperature is the same as setting.

ECO means the actual temperature is 2°C lower than the setting temperature.

ECO- means 4°C lower, COMF+ means 2°C higher.

COMF++ means 4°C higher.

Adaptive start control

According to room temperature and set-pointed temperature, the heater will automatically determine the appropriate time to heat to ensure that it will reach the set-pointed temperature in the set time (up to 45 minutes prior to the set time.)

User Instructions

Week Timer Heating

2b.28 The following heating periods have been preset, these can be altered if desired:



From Monday to Friday
06:00 until 08:30
17:00 until 22:00

From Saturday to Sunday
06:30 until 09:30
11:00 until 13:00
17:00 until 22:00

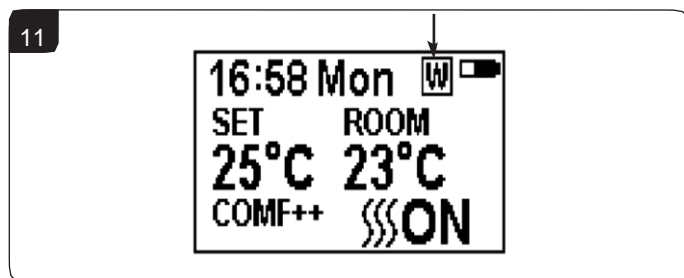
2b.29 Press **M** until  shows at the upper right corner of the screen to enter the week heating mode.





2b.30 Hold the  button for 6 seconds to enter the week timer heating mode setting.

2b.31 Press '' or '

2b.32 Press the  button in the corresponding week position

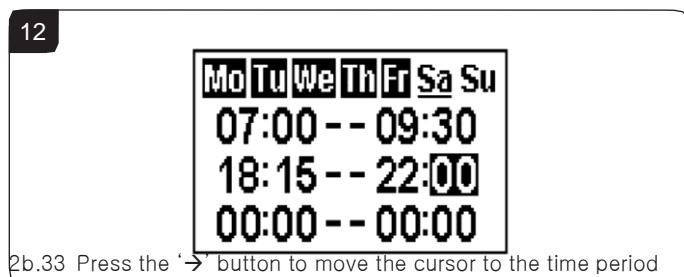
to select (the character is highlighted) or cancel (the character is displayed normally) the current setting, the same time period can be selected together.



2b.33 Press the '

2b.34 Press '



2b.35 Press '+' or '-' to set the number.

A maximum of 3 timed heating periods can be set per day.

Minute increment / decrement by 15min per press.

2b.36 Press  to set the heating time for the selected day and return to the week line.

2b.37 Hold the  button for 3 seconds or wait for 10 seconds to save and exit the heating time period setting.

2b.38 Press  '

2b.39 If the heating needs to be turned off, it will be necessary to go back to the Normal Control Mode to it turn off.

When in Weekly Timer Mode switching the appliance off with the remote will stop the light output. The heat output will continue according to the timer settings.

Adjusting the Set Temperature

2b.40 Press the '+' or '-' button to increase or decrease the temperature on the basis of COMF temperature.

COMF means the actual temperature is the same as setting.

ECO means the actual temperature is 2°C lower than the setting temperature.

ECO- means 4°C lower.

COMF+ means 2°C higher.

COMF++ means 4°C higher.

Adaptive start control

According to room temperature and set-pointed temperature, the heater will automatically determine the appropriate time to heat to ensure that it will reach the set-pointed temperature in the set time (up to 45 minutes prior to the set time.)

Advance mode

2b.41 The heating state can be advanced to the next period is under both the daily and week timer heating mode.

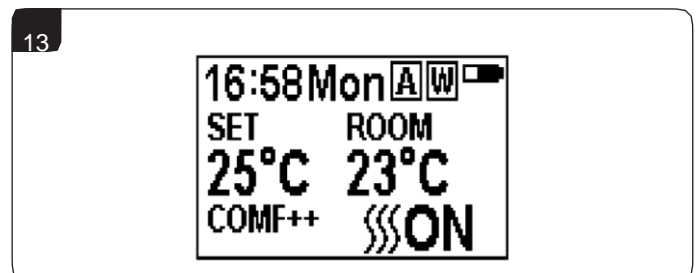

If the heater is on in the current period, pressing the button will turn the heater off.

If the heater is off in the current period, pressing the button will turn the heater on.

Whether the actual heating will be on/off also depends on the room temperature and setting temperature.

User Instructions

2b.42 Press **[[[A** to enter the Advance mode under the daily and week timer heating mode, **A** will show at the upper right corner of the screen.

2b.43 Press **[[[A** again or timer period ends will exit the Advance mode.

Window open detecting

2b.44 When the transmitter detects a rapid drop in room temperature, it will be judged as an open window: the warning icon will be displayed and the heating will be turned off automatically.



2b.45 After indoor temperature rise or manual intervention (by operating remote control), it will return to normal working state.

3. Principle of operation and block diagram

Principle of operation instructions

MCU (STM8L151) detected the valid keys operation, the blue indicator light of remote turn on (Loosen the button light will put out), at the same time, MCU change head code, address code, remote control button code value and the check code four groups of data into a binary data and then through port transmit to RF chip A7302. RF chip in the form of ASK/OOK put the binary data modulate to 433 MHz carrier, send out by the antenna network.

BLOCK DIAGRAM

