

# How to get the best from **Your Built-In Oven**



Use and Care of  
gas models  
JGKS15GEH  
JGKC15GEH  
JGKC16GEH

Features p4

Using the oven p6

Special care of  
continuous-cleaning oven p11

Questions?  
Use the Problem Solver p15



Your Direct Line to GE  
The GE Answer Center

JGKC15GEH  
JGKC16GEH  
JGKS15GEH

EFFDATE  
07-02-86

GENERAL  ELECTRIC

PUB.  
49-47602

## Contents

Safety Instructions . . . . .	2-3
Features of Your Oven . . . . .	4
Automatic Oven Timer, Clock and Minute Timer . . . . .	5
Using Your Oven . . . . .	6
Baking . . . . .	7
Baking Chart . . . . .	8
Roasting, Chart . . . . .	9
Broiling, Chart . . . . .	10
Special Care of Continuous-Cleaning Oven . . . . .	11
Care and Cleaning . . . . .	11-13
Cleaning Chart . . . . .	14
Problem Solver . . . . .	15
If You Need Service . . . . .	15
Warranty . . . . .	Back Cover

### FOR YOUR SAFETY

Turn OFF all range controls

If you smell gas:

1. Open windows
2. Don't touch electrical switches\*
3. Extinguish any open flame
4. Immediately call your gas supplier

\*Don't turn electric switches on or off because sparks may ignite the gas.

### FOR YOUR SAFETY

Keep the appliance area clear and free from combustible materials, gasoline and other flammable vapors and liquids.

## Help us help you . . .

### Read this book carefully.

It is intended to help you operate and maintain your new oven properly.

Keep it handy for answers to your questions.

If you don't understand something or need more help, write (include your phone number):

Consumer Affairs  
General Electric Company  
Appliance Park  
Louisville, KY 40225

### Write down the model and serial numbers.

You'll find them on a label located inside the oven on the left side. See page 4.

These numbers are also on the Consumer Product Ownership Registration Card that came with your oven.

## IMPORTANT SAFETY INSTRUCTIONS

### Read all instructions before using this appliance.

- When you get your oven have the installer show you the location of the oven gas cut-off valve and how to shut it off if necessary.
- Have your oven installed and properly grounded by a qualified installer, in accordance with the Installation Instructions. Any adjustment and service should be performed only by qualified gas range installers or service technicians.
- Plug your oven into a 120-volt grounded outlet only. Do not remove the round grounding prong from the plug. If in doubt about the grounding of the home electrical system, it is your personal

Before sending in this card, please write these numbers here:

Model Number

Serial Number

Use these numbers in any correspondence or service calls concerning your oven.

### If you received a damaged oven . . .

Immediately contact the dealer (or builder) that sold you the oven.

### Save time and money. Before you request service . . .

Check the Problem Solver on page 15. It lists minor causes of operating problems that you can correct yourself.

responsibility and obligation to have an ungrounded outlet replaced with a properly-grounded three-prong outlet in accordance with the National Electrical Code. Do not use an extension cord with this appliance.

- Be sure all packing materials are removed from the oven before operating it, to prevent fire or smoke damage should the packing material ignite.

- Be sure your oven is correctly adjusted by a qualified service technician or installer for the type of gas (Natural or LP) on which it is to be used. Gas can be converted from one type to the other. See Installation Instructions.

# IMPORTANT SAFETY INSTRUCTIONS (continued)

## Using Your Oven

- Don't leave children alone or unattended where an oven is hot or in operation. They could be seriously burned.
- Don't allow anyone to climb, stand or hang on the door or broiler compartment. They could damage the oven and even tip it over causing severe personal injury.
- **CAUTION: DO NOT STORE ITEMS OF INTEREST TO CHILDREN IN CABINETS ABOVE AN OVEN—CHILDREN CLIMBING ON THE OVEN TO REACH ITEMS COULD BE SERIOUSLY INJURED.**
- Never wear loose fitting or hanging garments while using the appliance. Flammable material could be ignited if brought in contact with flame or hot oven surfaces and may cause severe burns.
- Never use your appliance for warming or heating the room. Prolonged use of the oven without adequate ventilation can be hazardous.
- Do not use water on grease fires. Never pick up a flaming pan. Turn off burner, then smother flaming pan by covering pan completely with well fitting lid, cookie sheet or flat tray. Flaming grease outside a pan can be put out by covering with baking soda or, if available, a multi-purpose dry chemical or foam.

- Do not store flammable materials in an oven.
- Do not let cooking grease or other flammable materials accumulate in or near the oven.
- Do not use oven for a storage area.
- Stand away from the oven when opening oven door. The hot air or steam which escapes can cause burns to hands, face and/or eyes.
- Keep oven free from grease buildup.
- Place oven shelves in desired position while oven is cool.
- Pulling out shelf to the shelf stop is a convenience in lifting heavy foods. It is also a precaution against burns from touching hot surfaces of the door or oven walls.
- Don't use aluminum foil anywhere in the oven except as described in this book. Misuse could result in a fire hazard or damage to the range.
- Don't heat unopened food containers in the oven. Pressure could build up and the container could burst causing an injury.
- Use only glass cookware that is recommended for use in gas oven.
- When using cooking or roasting bags in oven, follow the manufacturer's directions.
- When cooking pork, follow our directions exactly and always cook the meat to at least 170°F. This assures that, in the remote possibility that trichina may be present in the meat, it will be killed and meat will be safe to eat.

- Always remove broiler pan from broiler compartment as soon as you finish broiling. Grease left in the pan can catch fire if oven is used without removing the grease from the broiler pan.
- When broiling, if meat is too close to the flame, the fat may ignite. Trim excess fat to prevent excessive flare-ups.
- Make sure broiler pan is in place correctly to reduce the possibility of grease fires.
- If you should have a grease fire in the broiler pan, turn off oven, and keep drawer closed to contain fire until it burns out.
- Clean only parts listed in this Use and Care Book.
- Keep oven clean and free of accumulations of grease or spillovers which may ignite.

## If You Need Service

- Read "The Problem Solver" on page 15 of this book.
- Don't attempt to repair or replace any part of your oven unless it is specifically recommended in this book. All other servicing should be referred to a qualified technician.

**SAVE THESE INSTRUCTIONS**

# Features of Your Oven

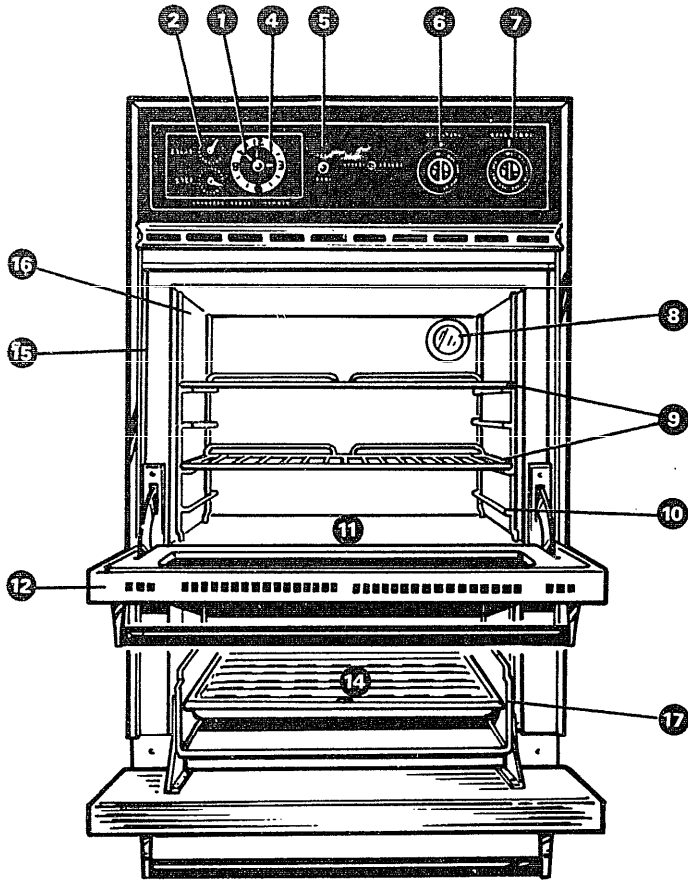

Models JGKS15GEH (Standard Oven)  
JGKC15GEH (Continuous-Cleaning Oven)

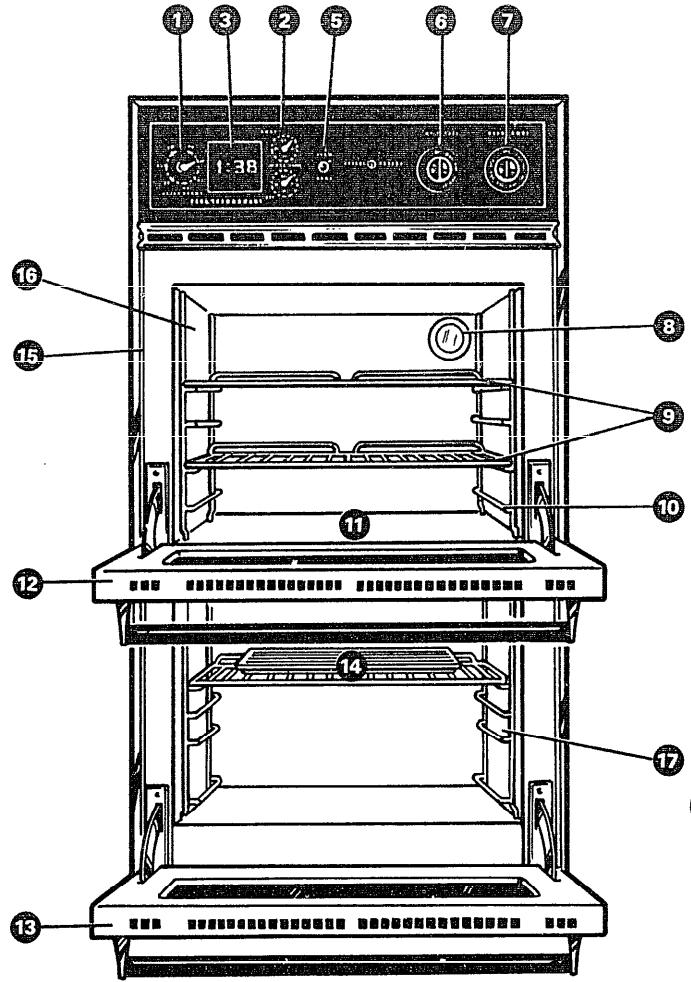

Model JGKC16GEH (Continuous-Cleaning Oven)

Feature Index	See page	JGKS15GEH	JGKC15GEH	JGKC16GEH
1 Minute Timer	5	•	•	•
2 Automatic Oven Timer	5	•	•	•
3 Digital Electric Clock	5			•
4 Radial Electric Clock	5	•	•	
5 Oven Light Switch	6	•	•	•
6 Oven Set Knob	5	•	•	•
7 Oven Temp Knob	6	•	•	•
8 Oven Interior Light	6	•	•	•
9 Oven Shelves	6	•	•	•
10 Oven Shelf Supports	6	•	•	•
11 Removable Oven Bottom	12	•	•	•
12 Removable Oven Door	12	•	•	•
13 Removable Broiler Compartment Door	12			•
14 Broiler Pan and Rack	10, 13	•	•	•
15 Model and Serial Numbers	2	•	•	•
16 Continuous-Cleaning Oven Interior	11		•	•
17 Broiler Compartment	10, 13	•	•	•

# Minute Timer, Automatic Oven Timer and Clock

## Minute Timer

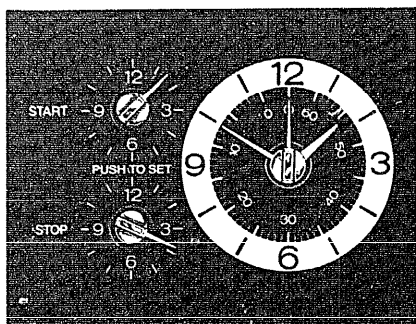

### JGKS15GEH & JGKC15GEH

The Minute Timer has been combined with the oven clock. Use it to time all your precise cooking operations. You'll recognize it as the pointer which is different in color than the clock hands.

Minutes are marked up to 60 on the center ring of the clock.

To set the Minute Timer, turn the knob to the left, *without pushing in*, until the pointer reaches the number of minutes you want to time.

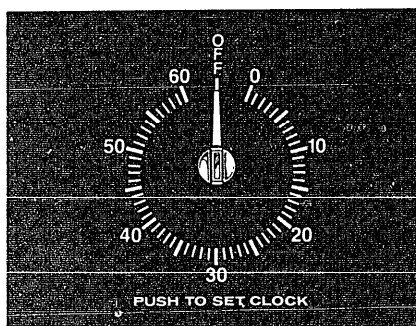

### Model JGKC16GEH

The Minute Timer is the large dial to the left of the digital clock. Use it to time all your precise cooking operations. This dial also changes the digital clock.

To set the Minute Timer, turn the center knob clockwise, *without pushing in*, until the pointer reaches the number of minutes you want to time (up to 60).

At the end of the time set on either Minute Minder, a buzzer sounds to tell you time is up. Turn the knob, *without pushing in*, until the pointer reaches OFF and the buzzer stops.

## The Clock

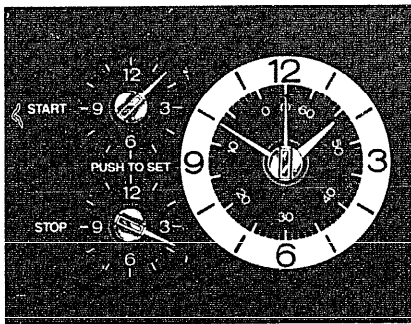

### JGKS15GEH & JGKC15GEH

To set the Clock, push the knob in and turn the clock hands to the right to the correct time. Then let the knob out and continue turning to OFF.

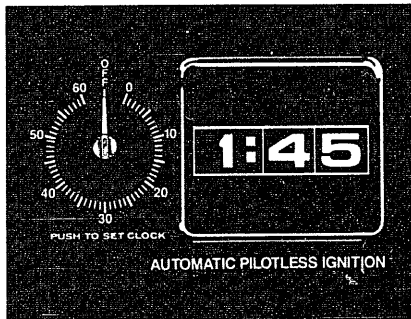

### Model JGKC16GEH

To set the Clock, push in the center knob of the Minute Timer and turn the knob in either direction to set the digital clock numerals to the correct time. (After setting the clock, let the knob out and turn the Minute Timer pointer to OFF.)

## Automatic Oven Timer

This Timer will automatically start and stop your oven for you. Here's what you do:

1. Make sure both your oven clock and the START dial show the correct time of day. When the START knob is pushed in and turned, it will "pop" into place when the time shown on the oven clock is reached.

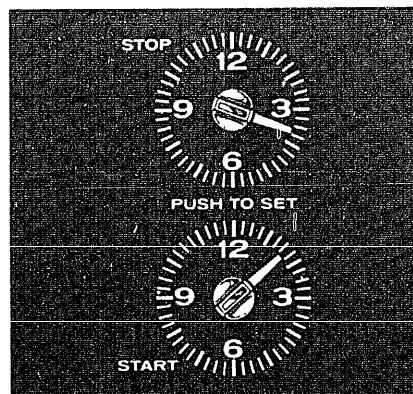

2. Set the START control. Push in and turn the START knob to the time you want the oven to turn itself on. (If you want it to start cooking immediately, do not set the Start time.)

3. Set the STOP control. Push in and turn the STOP knob to the time you want the oven to turn itself off.

Note: There must be at least a half hour difference between the START and STOP dials for the automatic control to work.

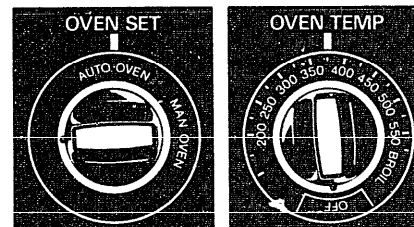

4. Set the OVEN SET knob to AUTO OVEN.

5. Set the OVEN TEMP knob to the desired cooking temperature.

Now the oven will turn itself on immediately or at a later Start time that you set, cook at the temperature you selected and turn itself off at the Stop time you selected.

After taking food out of the oven, be sure to turn the OVEN TEMP control to off and the OVEN SET knob to the MAN. OVEN setting where it should be kept for normal oven use.

# Using Your Oven

## Automatic Ignition

The oven and broiler burners on your oven are lighted by electric ignition eliminating the need for standing pilot lights with constantly burning flame.

**CAUTION: DO NOT MAKE ANY ATTEMPT TO OPERATE THE ELECTRIC IGNITION OVEN DURING AN ELECTRICAL POWER FAILURE.** Resumption of electrical power when OVEN TEMP control is in any position other than OFF will result in automatic ignition of the oven burner and could cause severe burns if, at the time, you were attempting to light the burner with a match.

## To Light the Oven Burner

Turn the OVEN TEMP knob to the desired temperature. The burner should ignite within 60 seconds.

## Air Adjustment

An air adjustment shutter for the oven burner regulates the flow of air to the flame.

Remove the broiler pan and rack, pull the broiler compartment drawer out to the "stop" position or remove the broiler compartment shelf and you'll find the shutter against the back wall of the compartment.

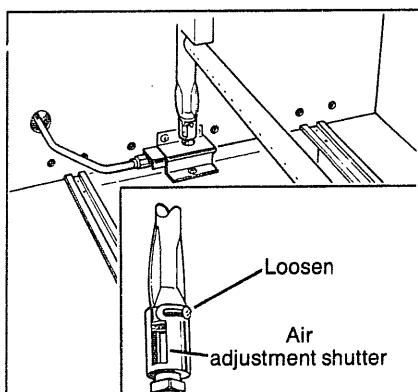

To adjust the flow of air to the burner, loosen the Phillips head

screw and rotate the shutter to allow more or less air into the burner tube as needed.

**When the right amount of air flows into the burner,** the flame should be steady, with approximately 1-inch blue cones and should not extend out over the baffle edges.

## Before Using Your Oven

1. Look at the control. Be sure you understand how to set it properly.
2. Check the inside of the oven. Look at the shelves. Practice removing and replacing them while the oven is cool.
3. Read the information and tips on the following pages.
4. Keep this book handy where you can refer to it—especially during the first few weeks of getting acquainted with your oven.

## Oven Temperature Control

The OVEN TEMP control is located on the upper oven control panel.

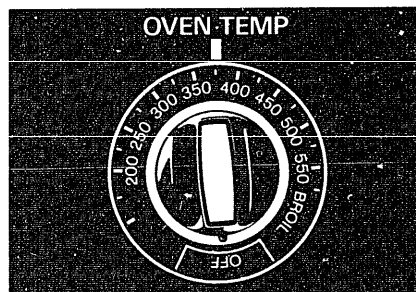

Simply turn the knob to the desired cooking temperatures, which are marked in 25°F. increments on the dial. It will normally take 30 to 60 seconds before the flame comes on.

After the oven reaches the selected temperature, the oven burner cycles off completely, then on with a full flame to keep the oven temperature controlled.

## Oven Shelves

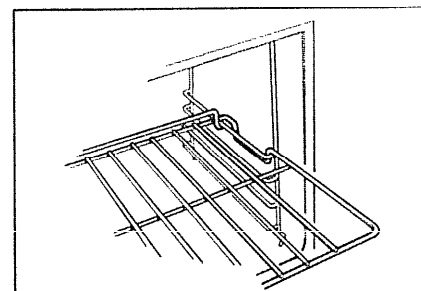

The shelves are designed with stop-locks so when placed correctly on the shelf supports, they will stop before coming completely out of the oven and will not tilt when you are removing food or placing food on them.

When placing cookware on a shelf, pull the shelf out to the "stop" position. Place the cookware on the shelf, then slide the shelf back into the oven. This will eliminate reaching into the hot oven.

To remove the shelves from the oven for cleaning, pull out to stop position, lift up on front and pull them out.

## Shelf Positions

The oven has four shelf supports—A (bottom), B, C and D (top). Shelf positions for cooking are suggested on Baking and Roasting pages.

## Oven Light

Use switch on control panel to turn light on and off.



# Baking

## How to Set Your Range for Baking

1. Position the shelf or shelves in the oven.
2. Close oven door, turn OVEN TEMP knob to desired temperature and preheat oven for about 10 minutes if preheating is necessary.
3. Place food in oven on center of shelf. Allow at least an inch between edge of bakeware and oven wall or adjacent utensils.

If cooking on two shelves at the same time, place shelves about 4 inches apart and stagger food on them.

4. Check food for doneness at minimum time on recipe. Cook longer if necessary. Switch off heat and remove food.

## Preheating

Preheating is important when using temperatures below 225°F. and when baking foods such as biscuits, cookies, cakes and other pastries.

Preheating is not necessary when roasting or for long-time cooking of whole meals.

## Shelf Positions

Most baking is done on the second shelf position (B) from the bottom.

When baking three or four items, use two shelves positioned on the second and fourth sets of supports (B & D) from bottom of oven.

Bake angel food cakes on first shelf position (A) from bottom of oven.

## Baking Tips

- Follow a tested recipe and measure the ingredients carefully. If you are using a package mix, follow label directions.

- If moisture is noticeable on the front of the oven or on the oven window when first turning on the oven, leave the oven door ajar for a few minutes or until the oven is warm.

- Do not open the oven door during a baking operation—heat will be lost and the baking time might need to be extended. This could cause poor baking results.

- Do not disturb the heat circulation in the oven with the use of aluminum foil. If foil is used, place a small sheet of it, about 10 by 12 inches at the most, on a lower shelf several inches below the food. Do not place foil on the oven bottom.

## Common Baking Problems and Possible Solutions

### PIES

#### Burning around edges

- Oven too full; avoid overcrowding.
- Edges of crust too thin.
- Incorrect baking temperature.

#### Bottom crust soggy and unbaked

- Allow crust and/or filling to cool sufficiently before filling pie shell.
- Filling may be too thin or juicy.
- Filling allowed to stand in pie shell before baking. (Fill pie shells and bake immediately.)
- Ingredients and proper measuring affect the quality of the crust. Use a tested recipe and good technique. Make sure there are no tiny holes or tears in a bottom crust. "Patching" a pie crust could cause soaking.

#### Pie filling runs over

- Top and bottom crust not well sealed together.
- Edges of pie crust not built up high enough.
- Too much filling.
- Check size of pie plate.

#### Pastry is tough; crust not flaky

- Too much handling.
- Fat too soft or cut in too fine. Roll dough lightly and handle as little as possible.

## CAKES

### Cake rises higher on one side

- Batter spread unevenly in pan.
- Oven shelves not level.
- Using warped pans.
- Incorrect pan size.

### Cakes cracking on top

- Check oven temperature.
- Batter too thick, follow recipe or exact package directions.
- Check for proper shelf position.
- Check pan size called for in recipe.
- Improper mixing of cake.

### Cake falls

- Too much shortening, sugar or liquid.
- Check leavening agent, baking powder or baking soda to assure freshness. Make a habit to note expiration dates of packaged ingredients.
- Cake not baked long enough or at correct temperature.
- If adding oil to a cake mix, make certain the oil is the type and amount specified.

### Crust is hard

- Check temperature.
- Check shelf position.

### Cake has soggy layer or streaks at bottom

- Undermixing ingredients.
- Shortening too soft for proper creaming.
- Too much liquid.

## COOKIES & BISCUITS

### Doughy center; heavy crust on surface

- Check temperature.
- Check shelf position.
- Follow baking instructions carefully as given in reliable recipe or on convenience food package.
- Flat cookie sheets will give more even baking results. Don't overcrowd foods on a baking sheet.
- Convenience foods used beyond their expiration date.

### Browning more noticeable on one side

- Oven door not closed properly, check gasket seal.
- Check shelf position.

# Baking Chart

1. Aluminum pans conduct heat quickly. For most conventional baking, light, shiny finishes give best results because they help prevent over-browning in the time it takes for heat to cook the center areas. We recommend dull (satin-finish) bottom surfaces of pans for cake pans and pie plates to be sure those areas brown completely.

2. Dark or non-shiny finishes, also glass and pyroceram, generally absorb heat which may result in dry, crisp crusts. Reduce oven heat 25°F. if lighter crusts are desired. Preheat cast iron for baking some foods for rapid browning when food is added.

Food	Cookware	Shelf Positions	Oven Temperatures	Time, Minutes	Comments
<b>Bread</b>					
Biscuits (½-in. thick)	Shiny Cookie Sheet	B, C	400°-475°	15-20	Canned, refrigerated biscuits take 2 to 4 minutes less time.
Coffee cake	Shiny Metal Pan with satin-finish bottom	B, A	350°-400°	20-30	
Corn bread or muffins	Cast Iron or Glass Pan	B	400°-450°	20-40	Preheat cast iron pan for crisp crust.
Gingerbread	Shiny Metal Pan with satin-finish bottom	B	350°	45-55	
Muffins	Shiny Metal Muffin Pans	A, B	400°-425°	20-30	Decrease about 5 minutes for muffin mix.
Popovers	Deep Glass or Cast Iron Cups	B	375°	45-60	Or bake at 450°F. for 25 minutes, then at 350°F. for 10 to 15 minutes.
Quick loaf bread	Metal or Glass Loaf Pans	B	350°-375°	45-60	Dark metal or glass gives deepest browning.
Yeast bread (2 loaves)	Metal or Glass Loaf Pans	A, B	375°-425°	45-60	
Plain rolls	Shiny Oblong or Muffin Pans	A, B	375°-425°	10-25	For thin rolls, Shelf B may be used.
Sweet rolls	Shiny Oblong or Muffin Pans	B, A	350°-375°	20-30	For thin rolls, Shelf B may be used.
<b>Cakes</b> (without shortening)					
Angel food	Aluminum Tube Pan	A	325°-375°	30-55	Two piece pan is convenient.
Jelly roll	Metal Jelly Roll Pan	B	375°-400°	10-15	Line pan with waxed paper.
Sponge	Metal or Ceramic Pan	A	325°-350°	45-60	
<b>Cakes</b>					
Bundt cakes	Metal or Ceramic Pan	A, B	325°-350°	45-65	Paper liners produce more moist crusts.
Cupcakes	Shiny Metal Muffin Pans	B	350°-375°	20-25	Use 300°F. and Shelf B for small or individual cakes.
Fruit cakes	Metal or Glass Loaf or Tube Pan	A, B	275°-300°	2-4 hrs.	
Layer	Shiny Metal Pan with satin-finish bottom	B	350°-375°	20-35	
Layer, chocolate	Shiny Metal Pan with satin-finish bottom	B	350°-375°	25-30	
Loaf	Metal or Glass Loaf Pans	B	350°	40-60	
<b>Cookies</b>					
Brownies	Metal or Glass Pans	B, C	325°-350°	25-35	Bar cookies from mix use same time.
Drop	Cookie Sheet	B, C	350°-400°	10-20	Use Shelf C and increase temperature 25 to 50°F. for more browning.
Refrigerator	Cookie Sheet	B, C	400°-425°	6-12	
Rolled or sliced	Cookie Sheet	B, C	375°-400°	7-12	
<b>Fruits, Other Desserts</b>					
Baked apples	Glass or Metal Pans	A, B, C	350°-400°	30-60	Reduce temperature to 300°F. for large custard.
Custard	Glass Custard Cups or Casserole (set in pan of hot water)	B	300°-350°	30-60	Cook bread or rice pudding with custard base 80 to 90 minutes.
Puddings, rice and custard	Glass Custard Cups or Casserole	B	325°	50-90	
<b>Pies</b>					
Frozen	Foil Pan on Cookie Sheet	A	400°-425°	45-70	Large pies use 400°F. and increase time.
Meringue	Spread to crust edges	B, A	325°-350°	15-25	To quickly brown meringue use 400°F. for 8 to 10 minutes.
One crust	Glass or Satin-finish Metal	A, B	400°-425°	45-60	Custard fillings require lower temperature, longer time.
Two crust	Glass or Satin-finish Metal	B	400°-425°	40-60	
Pastry shell	Glass or Satin-finish Metal	B	450°	12-15	
<b>Miscellaneous</b>					
Baked potatoes	Set on Oven Shelf	A, B, C	325°-400°	60-90	Increase time for large amount or size.
Scalloped dishes	Glass or Metal	A, B, C	325°-375°	30-60	
Souffles	Glass	B	300°-350°	30-75	



# Roasting

Roasting is cooking by dry heat. Tender meat or poultry can be roasted uncovered in your oven. Roasting temperatures, which should be low and steady, keep spattering to a minimum. When roasting, it is not necessary to sear, baste, cover, or add water to your meat. Roasting is easy, just follow these steps:

**Step 1:** Position oven shelf at second from bottom position (B) for small size roast (3 to 5 lbs.) and at bottom position (A) for larger roasts.

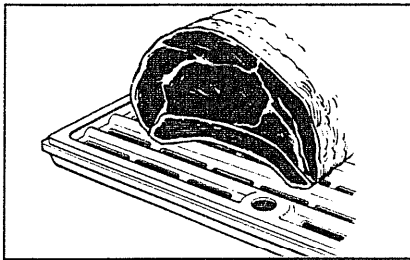

**Step 2:** Check weight of roast. Place meat fat-side-up or poultry breast-side-up on roasting rack in a shallow pan. The melting fat will baste the meat. Select a pan as close to the size of meat as possible. (Broiler pan with rack is a good pan for this.)

**Step 3:** Turn OVEN TEMP control to desired temperature. Check the Roasting Chart for temperatures and approximate cooking times.

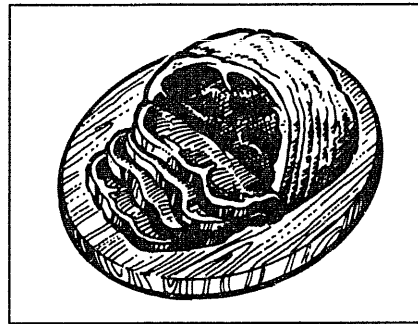

**Step 4:** Most meats continue to cook slightly while standing after being removed from the oven. For rare or medium internal doneness, if meat is to stand 10 to 20 minutes while making gravy or for easier carving, you may wish to remove meat from oven just before it is done. If no standing is planned, cook meat to suggested temperature.

## Frozen Roasts

Frozen roasts of beef, pork, lamb, etc., can be started without thawing, but allow 10 to 25 minutes per pound additional time (10 minutes per pound for roasts under 5 pounds, more time for larger roasts).

Thaw most frozen poultry before roasting to ensure even doneness. Some commercial frozen poultry can be cooked successfully without thawing. Follow directions given on packer's label.

## Roasting Chart

Type	Oven Temperature	Doneness	Approximate Roasting Time in Minutes per Pound		Internal Temperature °F
Meat	325°	Rare:	3 to 5-lbs. 24-30	6 to 8-lbs. 18-22	130°-140°
		Medium:	30-35	22-25	150°-160°
		Well Done:	35-45	28-33	170°-185°
	325°	Rare:	21-25	20-23	130°-140°
		Medium:	25-30	24-28	150°-160°
325°	Well Done:	30-35	28-33	170°-185°	
Veal shoulder, leg or loin*	325°	Well Done:	35-45	30-40	170°-180°
Pork loin, rib or shoulder*	325°	Well Done:	35-45	30-40	170°-180°
Ham, pre-cooked	325°	To Warm:	10 minutes per lb. (any weight)		125°-130°
Ham, raw	325°	Well Done:	Under 10 lbs.	10 to 15-lbs.	160°
			20-30	17-20	
*For boneless rolled roasts over 6-inches thick, add 5 to 10 minutes per lb. to times given above.					
Poultry	325°	Well Done:	3 to 5-lbs.	Over 5 lbs.	185°-190°
			35-40	30-35	
	375°	Well Done:	10 to 15-lbs.	Over 15 lbs.	In thigh: 185°-190°
			20-25	15-20	

# Broiling

Broiling is cooking food by direct heat from above the food. Your range has a convenient compartment below the oven for broiling. It also has a specially designed broiler pan and rack that allow dripping fat to drain away from the foods and be kept away from the high heat of the gas flame.

Distance from the heat source may be changed by positioning the broiler pan and rack on one of three shelf positions in the broiler compartment—A (bottom of broiler compartment), B (middle) and C (top).

## How to Broil

1. If meat has fat or gristle near the edge, cut vertical slashes through it about 2 inches apart, but don't cut into meat. We recommend that you trim fat to prevent excessive smoking, leaving a layer about 1/8-inch thick.
2. Remove broiler pan and rack from broiler compartment and place food on rack.
3. Pull out broiler drawer or broiler shelf and position broiler pan in compartment. Placing food closer to flame increases exterior browning of food, but also increases spattering and the possibility of fats and meat juices igniting.
4. Close broiler door and, for most foods, turn OVEN TEMP knob to BROIL. Exceptions are chicken and ham which are broiled at a lower setting in order to cook food through before overbrowning it.
5. Turn most foods once during cooking; (the exception is thin fillets of fish; oil one side, place that side down on broiler rack and cook without turning until done). Time foods for about one-half the total cooking time, turn food, then continue to cook to preferred doneness.
6. Turn OVEN TEMP knob to OFF. Remove broiler pan from compartment and serve food immediately. Leave pan outside compartment to cool.

## Broiling Tips

• **Broiling is usually done with oven and broiler doors closed.** However, if you like your steaks very rare inside and charred on the outside, leave the oven door slightly ajar.

• **Use tongs to turn meat over—**piercing meat loses juices.

• **Steaks and chops should be at least 1 inch thick** for best broiling results. Pan broil thinner ones.

Food	Quantity and/or Thickness	Broil Position	1st Side Time, Minutes	2nd Side Time, Minutes	Comments
Bacon	½-lb. (about 8 thin slices)	C	3½	3½	Arrange in single layer.
Ground Beef Well Done	1-lb. (4 patties) ½ to ¾-in. thick	C	9-10	7-8	Space evenly. Up to 8 patties take about same time.
Beef Steaks					
Rare	1-in. thick	A	9	7	Steaks less than 1 inch cook through before browning. Pan frying is recommended. Slash fat.
Medium	(1-1½ lbs.)	A	12	5-6	
Well Done		A	13	8-9	
Rare	1½-in. thick	A	10	6-7	Slash fat.
Medium	(2-2½ lbs.)	A	15	12-14	
Well Done		A	25	16-18	
Chicken (450°)	1 whole (2 to 2½-lbs.), split lengthwise	A	30-35	25-30	Reduce times about 5 to 10 minutes per side for cut-up chicken. Brush each side with melted butter. Broil with skin side down first and broil with door closed.
Bakery Products					
Bread (Toast) or Toaster Pastries	2-4 slices	C	2-3	½-1	Space evenly. Place English muffins cut-side-up and brush with butter if desired.
English Muffins	1 pkg. (2) 2-split	C	3-4		
Lobster tails (6 to 8-oz. each)	2-4	B	13-16	Do not turn over.	Cut through back of shell, spread open. Brush with melted butter before and after half time.
Fish	1-lb. fillets ¼ to ½-in. thick	C	5	5	Handle and turn very carefully. Brush with lemon butter before and during cooking if desired. Preheat broiler to increase browning.
Ham slices (450°) Precooked	1-in. thick	B	8	8	Increase times 5 to 10 minutes per side for 1½-in. thick or home cured.
Pork chops Well Done	2 (½-in.) 2 (1-in. thick), about 1 lb.	A A	10 13	4-5 10-12	Slash fat.
Lamb chops					
Medium Well Done	2 (1 inch) about 10-12 oz.	B B	8 10	4-7 10	Slash fat.
Medium Well Done	2 (1½ inch), about 1 lb.	B B	10 17	4-6 12-14	
Wieners, similar precooked sausages, bratwurst	1-lb. pkg. (10)	C	6	1-2	If desired, split sausages in half lengthwise into 5 to 6-inch pieces.

# Care and Cleaning

Proper care and cleaning are important so your oven will give you efficient and satisfactory service. Follow these directions carefully in caring for it to help assure safe and proper maintenance.

**BE SURE ELECTRIC POWER IS OFF BEFORE CLEANING ANY PART OF YOUR OVEN.**

## Special Care of Continuous-Cleaning Oven Interior

Models JGKC15, JGKC16

Your oven has a **Continuous-Cleaning oven that cleans itself while cooking**. The inside of the oven—top, sides, and back—is finished with a *special coating* which cannot be cleaned in the usual manner with soap, detergents, commercial oven cleaners, coarse abrasive pads or coarse brushes.

Their use and/or the use of oven sprays will cause permanent damage.

The **special coating is a porous ceramic material** which is dark in color and feels slightly rough to the touch. If magnified, the surface would appear as peaks, valleys, and sub-surface “tunnels.” This rough finish tends to prevent grease spatters from forming little beads or droplets which run down the side walls of a hard-surface oven liner leaving unsightly streaks that require hand cleaning. Instead, when spatter hits the porous finish it is dispersed and is partially absorbed. This spreading action increases the exposure of oven soil to heated air, and makes it somewhat less noticeable.

**Soil may not disappear completely** and at some time after extended usage, stains may appear which cannot be removed.

The **special coating works best on small amounts of spatter**. It does not work well with larger spills, especially sugars, egg or dairy mixtures.

The **special coating is not used on oven shelves**. Shelves should be cleaned *outside the oven*, to avoid damage to the special coating.

### To Clean the Continuous-Cleaning Oven:

1. Let oven parts cool before handling. It is recommended that rubber gloves be worn when cleaning oven parts manually.
2. Remove shelves and cookware.
3. Soil visibility may be reduced by operating the oven at 450°F. Close the door and turn OVEN TEMP knob to 450°F. Time for at least 4 hours. Repeated cycles may be necessary before improvement in appearance is apparent.

**REMEMBER: DURING THE OPERATION OF THE OVEN, THE DOOR, WINDOW AND OTHER SURFACES WILL GET HOT ENOUGH TO CAUSE BURNS. DO NOT TOUCH. LET THE OVEN COOL BEFORE REPLACING SHELVES.**

4. If a spillover or heavy soiling occurs on the porous surface, as soon as practical after the oven has cooled, remove as much of the soil as possible using a small amount of water and a stiff bristle nylon brush. When using water, use it sparingly and change it frequently, keeping it as clean as possible, and be sure to blot it up with paper towels, cloths, or sponges. *Do not rub or scrub* with paper towels, cloths or sponges, since they will leave unsightly lint on the oven finish. If water leaves a white ring on the finish as it dries, apply water again and *blot* it with a clean sponge, starting at the edge of the ring and working toward the center.

**Do not use soap, detergent, commercial oven cleaner, silicone oven sprays, coarse steel pads or coarse brushes on the porous surface.** These products will spot, clog, and mar the porous surface and reduce its ability to work.

**Do not scrape the porous surface with a knife or spatula**—they could permanently damage the finish.

## Porcelain Oven Interior

With proper care, the porcelain enamel walls will retain their good-looking finish for many years.

Soap and water will normally do the job. Heavy spattering or spillovers may require cleaning with a mild abrasive cleanser. Soapy, wet pads may also be used. Do not allow food spills with a high sugar or acid content (such as milk, tomatoes, sauerkraut, fruit juices or pie filling) to remain on the surface. They may cause a dull spot even after cleaning.

Household ammonia may make the cleaning job easier. Place 1/2 cup in a shallow glass or pottery container in a cold oven overnight. The ammonia fumes will help loosen the burned-on grease and food.

If necessary, you may use a caustic cleaner. Follow the package directions.

### Cautions about using spray-on oven cleaners:

Be careful where the oven cleaner is sprayed.

- **Do not spray on the electrical controls and switches** (on models so equipped) because it could cause a short circuit and result in sparking or fire.

- **Do not allow a film from the cleaner to build up on the temperature sensing bulb**—it could cause the oven to heat improperly. (The bulb is located at the top of the oven.) Carefully wipe the bulb clean after each oven cleaning, being careful not to move the bulb as a change in its position could affect how the oven bakes.

- **Do not spray any oven cleaner on the oven door, handles or any exterior surface of the oven, wood or painted surfaces.** The cleaner can damage these surfaces.

(continued next page)

## Care and Cleaning (continued)

### Removable Oven Door

The oven door is removable to make cleaning the oven easier.

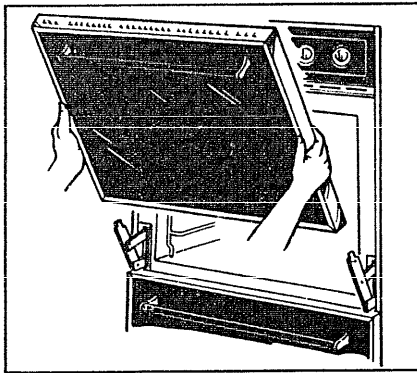

To remove the door, open it a few inches to the special stop position that will hold the door open. Grasp firmly on each side and lift the door straight up and off the hinges. (Due to the large amount of insulation and the construction of the door, it is heavy.)

**Note:** Be careful not to place hands between the spring hinge and the oven door frame. The hinge could snap back and pinch fingers.

Wash with hot, soapy water. For stubborn spots, use a solution of ammonia and water. Do not immerse the door in water.

**To replace the door,** position slots in bottom of door over the hinges that are in the "out" position. Then lower the door slowly and evenly over both hinges at the same time. If hinges snap back against the oven frame, pull them back out.

Model JGKC16GEH also has a removable broiler compartment door which may be removed for cleaning.

### Removable Oven Bottom

The raised section of the oven bottom is removable for cleaning. Take it out of the oven and you can apply effective cleaners to clean up excessive spillovers or remove baked-on soil—cleaners that should never be used near the special porous ceramic oven interior.

#### To remove the oven bottom:

1. Remove the oven shelves.

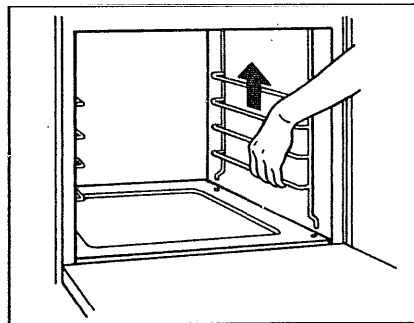

2. Lift upward on shelf supports. Swing bottom of supports toward center of oven and remove.

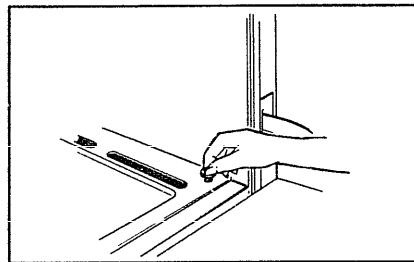

3. Remove the two knurled hold-down screws at each front corner. If screws are too tight to remove by hand, use a screwdriver.

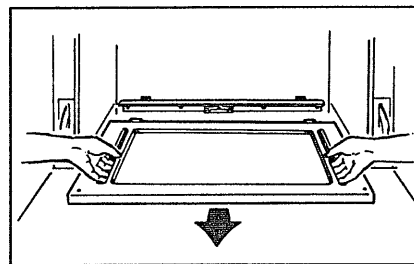

4. Place your fingers in the slots in the bottom and lift up the front edge of the oven bottom until it is clear of the oven front frame.

5. Pull the bottom forward and out of the oven, keeping the rear of the oven bottom gliding on the bottom of the lowest shelf glide. This keeps it from catching on the burner ignitor shield. To replace the bottom, just reverse this procedure, making sure the two tabs on the rear of the oven bottom go into the slots at the rear.

The oven bottom has a porcelain enamel finish. To make cleaning easier, protect the oven bottom from excessive spillovers. This is particularly important when baking a fruit pie or other foods with high acid content. Hot fruit fillings or foods that are acid in content such as milk, tomato or sauerkraut, and sauces with vinegar or lemon juice, may cause pitting and damage to the porcelain enamel surface.

To protect the oven bottom surface, place a piece of aluminum foil slightly larger than the baking dish or small cookie sheet on a lower rack or under the baking dish to catch any boilovers. It should not completely cover the rack as this would cause uneven heat in the oven. Aluminum foil should not be placed on the oven bottom.

If a spillover does occur on the oven bottom, allow the oven to cool first. You can clean the bottom with soap and water, a mild abrasive cleanser, soap-filled abrasive pads, or caustic oven cleaner following manufacturer's directions.

When applying oven cleaner, be careful not to get it on the countertop, floor, continuous-cleaning oven parts or any other surface.

**Note:** Porcelain oven door liner and oven bottom may be cleaned with a commercial oven cleaner. They must be removed and cleaned away from the oven to prevent damage to the continuous-cleaning oven liner.

## Oven Shelves

Oven shelves may be cleaned with a mild abrasive cleanser following manufacturer's directions. After cleaning, rinse the shelves with clean water and dry with a dry cloth. To remove heavy, burned-on soil, soapy metal pads may be used following manufacturer's directions. After scrubbing, wash with soapy water, rinse and dry.

## Broiler Pan & Rack

After broiling, remove the broiler rack and carefully pour off the grease. Wash and rinse the pan and rack in hot, soapy water.

If food has burned on, sprinkle the broiler rack while hot with detergent and cover with wet paper towels or a dish cloth. That way, burned-on foods will soak loose while the meal is being served.

Do not store a soiled broiler pan and rack in the oven or broiler compartment.

## Oven Light Bulb Replacement

**Before replacing any light bulb, disconnect electric power to the range at the main fuse or circuit breaker panel.** Let the bulb cool completely before removing it. Do not touch a hot bulb with a damp cloth—the bulb will break.

The light bulb in your oven is located in the upper right corner. Reach in and unscrew it after taking precautions mentioned above. Replace it with a high-temperature appliance bulb of the same wattage.

## Adjusting the Oven Thermostat

The temperature control in your new oven has been carefully adjusted to provide accurate temperatures. However, if this oven has replaced one you have used for several years, you may notice a difference in the degree of browning or the length of time required when using your favorite recipes. Oven temperature controls have a tendency to "drift" over a period of years and since this drift is very gradual, it is not readily noticed. Therefore, you may have become accustomed to your previous oven which may have provided a higher or lower temperature than you selected.

Before attempting to have the temperature of your new oven changed, be sure you have followed the baking time and temperature of the recipe carefully. Then, after you have used the oven a few times and you feel the oven is too hot or too cool, there is a simple adjustment you can make yourself on the OVEN TEMP knob.

Pull the knob off the control shaft and look at the back side. There is a disc in the center of the knob skirt with a series of notches on the inner edge next to the knob shaft. One of these notches is positioned over a pointer on the side of the knob shaft.

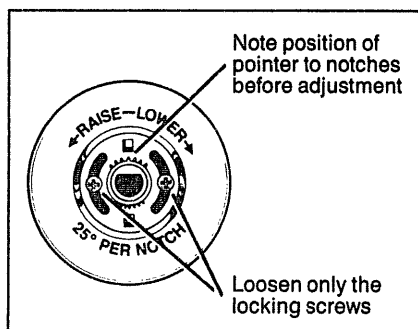

Note which notch the pointer is located in. To make an adjustment, carefully loosen (approximately one turn), but do not completely remove the two screws that hold the skirt to the knob. Hold the knob in one hand and with the other hand carefully tilt the skirt until the notch in the disc clears the pointer on the knob shaft.

To raise the oven temperature, turn the **dial** in the direction of the arrow for "Raise." To lower the temperature, turn the **dial** in the direction of arrow for "Lower." Each notch will change the oven temperature approximately 25°F.

We suggest that you make the adjustment one notch from the original setting and check oven performance before making any additional adjustments.

After the adjustment is made, make sure the pointer on the knob shaft is aligned with the notch in the disc. Press skirt and knob together and retighten screws so they are snug, but be careful not to overtighten.

Re-install knob on range and check performance. Note: After an adjustment has been made the "Off" and "Broil" positions will not line up with the indicator mark on the control panel as they previously did. This condition is normal and will not create a problem.

(continued next page)

# Cleaning Guide

Note: Let range parts cool before cleaning.

PART	MATERIALS TO USE	GENERAL DIRECTIONS
Broiler Pan and Rack	<ul style="list-style-type: none"> <li>• Soap and Water</li> <li>• Soap-Filled Scouring Pad</li> <li>• Commercial Oven Cleaner</li> </ul>	Drain fat, cool pan and rack slightly. (Do not let soiled pan and rack stand in broiler compartment to cool.) Sprinkle on detergent. Fill the pan with warm water and spread cloth or paper towel over the rack. Let pan and rack stand for a few minutes. Wash; scour if necessary. Rinse and dry. <b>OPTION:</b> The broiler pan and rack may also be cleaned in a dishwasher.
Control Knobs	<ul style="list-style-type: none"> <li>• Mild Soap and Water</li> </ul>	Pull off knobs. Wash gently but do not soak. Dry and return controls to range making sure to match flat area on the knob and shaft.
Outside Glass Finish	<ul style="list-style-type: none"> <li>• Soap and Water</li> </ul>	Clean outside of cooled black glass door with a glass cleaner that does not contain ammonia. Wash other glass with cloth dampened in soapy water. Rinse and polish with a dry cloth. If knobs are removed, do not allow water to run down inside the surface of glass while cleaning.
Metal, including Side Trims and Trim Strips	<ul style="list-style-type: none"> <li>• Soap and Water</li> </ul>	Wash, rinse, and then polish with a dry cloth. <b>DO NOT USE</b> steel wool, abrasives, ammonia, acids, or commercial oven cleaners which may damage the finish.
Porcelain Enamel Finish	<ul style="list-style-type: none"> <li>• Paper Towel</li> <li>• Dry Cloth</li> <li>• Soap and Water</li> </ul>	Avoid cleaning powders or harsh abrasives which may scratch the enamel. If acids should spill on the range while it is hot, use a dry paper towel or cloth to wipe up right away. When the surface has cooled, wash and rinse. For other spills, such as fat splatterings, etc., wash with soap and water when cooled and then rinse. Polish with dry cloth.
Painted Surfaces	<ul style="list-style-type: none"> <li>• Soap and Water</li> </ul>	Use a mild solution of soap and water. Do not use any harsh abrasives or cleaning powders which may scratch or mar surface.
Inside Oven Door*	<ul style="list-style-type: none"> <li>• Soap and Water</li> <li>• Soap-Filled Scouring Pad</li> <li>• Commercial Oven Cleaner</li> </ul>	To clean oven door; remove by opening a few inches and grasping door at sides. Lift door up and away from hinges. Clean with any and all mentioned materials. Replace by grasping door at sides and lining up door with hinges. Push door firmly into place.
Oven Interior*— Top, Sides and Back (Models JGKCI5 and JGKCI6) (CAUTION: When in use, light bulbs can become warm enough to break if touched with moist cloth or towel. When cleaning, avoid warm lamps with cleaning cloths.)	<ul style="list-style-type: none"> <li>• Stiff Bristle Nylon Brush</li> </ul>	Cool before cleaning.  If heavy soiling has occurred on the <i>porous surface</i> , remove as much of the soil as possible using a small amount of water and a stiff bristle nylon brush. Use water sparingly and change it frequently, keeping it as clean as possible, and be sure to blot it up with paper towels, cloths, or sponges. <i>Do not rub or scrub</i> with paper towels, cloths or sponges, since they will leave unsightly lint on the oven finish. If water leaves a white ring on the finish as it dries, apply water again and <i>blot</i> it with a clean sponge, starting at the edge of the ring and working toward the center.  <b>For special cleaning instructions, see page 11.</b>
Oven Liner* (Model JGKSI5) (CAUTION: When in use, light bulbs can become warm enough to break if touched with moist cloth or towel. When cleaning, avoid warm lamps with cleaning cloths if lamp cover is removed.)	<ul style="list-style-type: none"> <li>• Soap and Water</li> <li>• Soap-Filled Scouring Pad</li> <li>• Commercial Oven Cleaner</li> </ul>	Cool before cleaning.  <b>FOR LIGHT SOIL:</b> Frequent wiping with mild soap and water (especially after cooking meat) will prolong the time between major cleaning. Rinse thoroughly. <b>NOTE:</b> Soap left on liner causes additional stains when oven is reheated.  <b>FOR HEAVY SOIL:</b> Choose a nonabrasive cleaner and follow label instructions, using thin layer of cleaner. Use of rubber gloves is recommended. Wipe or rub lightly on stubborn spots. Rinse well. Wipe off any oven cleaner that gets on thermostat bulb. When rinsing oven after cleaning also wipe thermostat bulb.
Removable Oven Bottom	<ul style="list-style-type: none"> <li>• Soap and Water</li> <li>• Soap-Filled Scouring Pad (Non-metallic)</li> </ul>	The oven bottom panel can be removed for easy cleaning (see page 12). Use the same directions for cleaning as explained above for Porcelain Enamel Finish.
Shelves	<ul style="list-style-type: none"> <li>• Soap and Water</li> <li>• Soap-Filled Scouring Pad</li> <li>• Commercial Oven Cleaner</li> </ul>	Remove shelves and clean them outside of the oven to avoid damaging the specially coated oven top, sides and back. Use any and all mentioned materials. Rinse thoroughly to remove all materials after cleaning. <b>NOTE:</b> Some commercial oven cleaners cause darkening and discoloration. When using for first time, test cleaner on small part of shelf and check for discoloration before completely cleaning.

\*Spillage of marinades, fruit juices, and basting materials containing acids may cause discoloration. Spillovers should be blotted up immediately, with care being taken not to touch any hot portion of the oven. When the surface is cool, clean and rinse.





# Questions? Use This Problem Solver

PROBLEM	POSSIBLE CAUSE AND REMEDY
OVEN WILL NOT WORK	<ul style="list-style-type: none"> <li>• Plug on range is not completely inserted into the outlet receptacle.</li> <li>• Circuit breaker in house has been tripped, or fuse has been blown.</li> <li>• Oven controls are not properly set.</li> </ul>
OVEN LIGHT DOES NOT WORK	<ul style="list-style-type: none"> <li>• Light bulb is loose.</li> <li>• Bulb is defective. Replace.</li> <li>• Switch which operates oven light is broken. Call for service.</li> </ul>
FOOD DOES NOT BROIL PROPERLY	<ul style="list-style-type: none"> <li>• OVEN TEMP knob not set at BROIL. Broiler will not operate if OVEN TEMP knob is turned past BROIL.</li> <li>• Food is being cooked on hot pan.</li> <li>• Utensils are not suited for broiling.</li> </ul>
FOOD DOES NOT ROAST OR BAKE PROPERLY	<ul style="list-style-type: none"> <li>• OVEN SET knob not set on AUTO. OVEN when using Automatic Oven Timer.</li> <li>• OVEN TEMP knob not set correctly.</li> <li>• Shelf position is incorrect. Check Roasting and Baking pages.</li> <li>• Oven shelf is not level.</li> <li>• Wrong cookware is being used. When roasting, pan is too small.</li> <li>• Foil tent not used when needed to slow down browning during roasting.</li> </ul>
MOISTURE INSIDE AND OUTSIDE OVEN	<ul style="list-style-type: none"> <li>• Be sure oven vent duct is not blocked or covered.</li> </ul>

**If you need more help...call, toll free:  
The GE Answer Center®  
800.626.2000  
consumer information service**

## If You Need Service

To obtain service, see your warranty on the back page of this book.  
We're proud of our service and want you to be pleased. If for some reason you are not happy with the service you receive, here are three steps to follow for further help.  
**FIRST**, contact the people who serviced your appliance. Explain

why you are not pleased. In most cases, this will solve the problem.  
**NEXT**, if you are still not pleased, write all the details—including your phone number—to:  
Manager, Consumer Relations  
General Electric  
Appliance Park  
Louisville, Kentucky 40225

**FINALLY**, if your problem is still not resolved, write:  
Major Appliance  
Consumer Action Panel  
20 North Wacker Drive  
Chicago, Illinois 60606

Problem Solver

# YOUR GENERAL ELECTRIC RANGE WARRANTY

Save proof of original purchase date such as your sales slip or cancelled check to establish warranty period.

## WHAT IS COVERED

### FULL ONE-YEAR WARRANTY

For one year from date of original purchase, we will provide, free of charge, parts and service labor in your home to repair or replace **any part of the range** that fails because of a manufacturing defect.

This warranty is extended to the original purchaser and any succeeding owner for products purchased for ordinary home use in the 48 mainland states, Hawaii and Washington, D.C. In Alaska the warranty is the same except that it is LIMITED because you must pay to ship the product to the service shop or for the service technician's travel costs to your home.

All warranty service will be provided by our Factory Service Centers or by our authorized Customer Care® servicers during normal working hours.

Look in the White or Yellow Pages of your telephone directory for GENERAL ELECTRIC COMPANY, GENERAL ELECTRIC FACTORY SERVICE, GENERAL ELECTRIC-HOTPOINT FACTORY SERVICE or GENERAL ELECTRIC CUSTOMER CARE® SERVICE.

## WHAT IS NOT COVERED

- Service trips to your home to teach you how to use the product.

### Read your Use and Care material.

If you then have any questions about operating the product, please contact your dealer or our Consumer Affairs office at the address below or call, toll-free:

The GE Answer Center®  
800.626.2000  
consumer information service

- Improper installation.

If you have an installation problem, contact your dealer or installer. You are responsible for providing adequate electrical, gas, exhausting and other connecting facilities.

- Replacement of house fuses or resetting of circuit breakers.
- Failure of the product if it is used for other than its intended purpose or used commercially.
- Damage to product caused by accident, fire, floods or acts of God.

WARRANTOR IS NOT RESPONSIBLE FOR CONSEQUENTIAL DAMAGES.

Some states do not allow the exclusion or limitation of incidental or consequential damages, so the above limitation or exclusion may not apply to you. This warranty gives you specific legal rights, and you may also have other rights which vary from state to state. To know what your legal rights are in your state, consult your local or state consumer affairs office or your state's Attorney General.

**Warrantor: General Electric Company**

**If further help is needed concerning this warranty, contact:**

**Manager—Consumer Affairs, General Electric Company, Appliance Park, Louisville, KY 40225**

Part No. 205C1026 P105

Pub. No. 49-4762

P/N 560T691 P355

GENERAL  ELECTRIC

JCKS15GEH  
JGKC15GEH  
JGKC16GEH