PoChannel User Manual



Version 1.0

Copyright Notice

Rights

All rights reserved. This publication may not be reproduced, transmitted, transcribed, stored in a retrieval system, or translated into any language or computer language, in any form or by any means, electronic, mechanical, magnetic, optical, chemical, manual or otherwise, without the prior written consent.

Trademarks

-  Youtube is a registered trademark of Google, Inc.
- Miracast is a registered trademark of
-  DLNA is a registered trademark of

All other names, brands, products or services are trademarks or registered trademarks of their respective owners.

Safety Precautions

Read these instructions carefully before you install, operate, or transport the unit.

Installation and Operation

- The unit and its accessories are designed for indoor use only!
- Install the unit on a flat and clean surface.
- Install the unit at a location where the ambient temperature stays lower than 45°C.
- Install the unit near the power outlet and keep cables (power cable, HDMI cable, etc. away from foot traffic).
- Install the device at a location where there is sufficient air circulation.
- Ensure that the correct power range is being used before powering on the device.
- DO NOT disassemble the device. Please contact technical support if you think the device is faulty.
- If the device is not going to be used for a long period of time, disconnect it from the mains to avoid transient over-voltage.

Table of contents

COPYRIGHT NOTICE	2
SAFETY PRECAUTIONS.....	3
INSTALLATION AND OPERATION	3
TABLE OF CONTENTS.....	4
ABOUT THIS MANUAL.....	5
REVISION HISTORY.....	5
INTRODUCTION.....	6
PACKAGE CONTENT.....	6
POCHANNEL BOX.....	7
REMOTE CONTROL.....	8
PREREQUISITES (USER SELF-PROVIDED)	9
INITIALIZATION	10

About This Manual

This manual introduces the procedures on how to install, setup, and operate the PoChannel Box and its relevant accessories.

Revision History

Version	Date	Description
1.0	Nov. 2013	Initial release

Introduction

PoChannel Box offer the best and latest online entertainment to you!
Through internet access, PoChannel Box can effectively manage your favorite Youtube channels.

Package Content



PoChannel Box

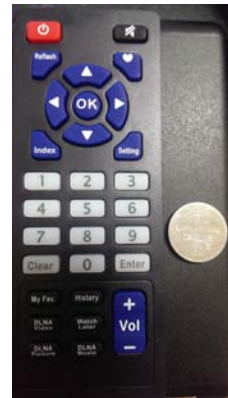

Remote control (button battery included)



HDMI cable



Power Adaptor (micro-USB connector)

PIC

Quick installation guide

PoChannel Box



1. HDMI output port	The HDMI port can deliver high definition video and audio.
2. USB port	The USB port is reserved for maintenance purposes only!
3. Mini USB port	The mini USB port is for use with the power adaptor
4. Reset button	The reset button is situated at the bottom of the device, it can used to reset the device to default settings.

Remote Control

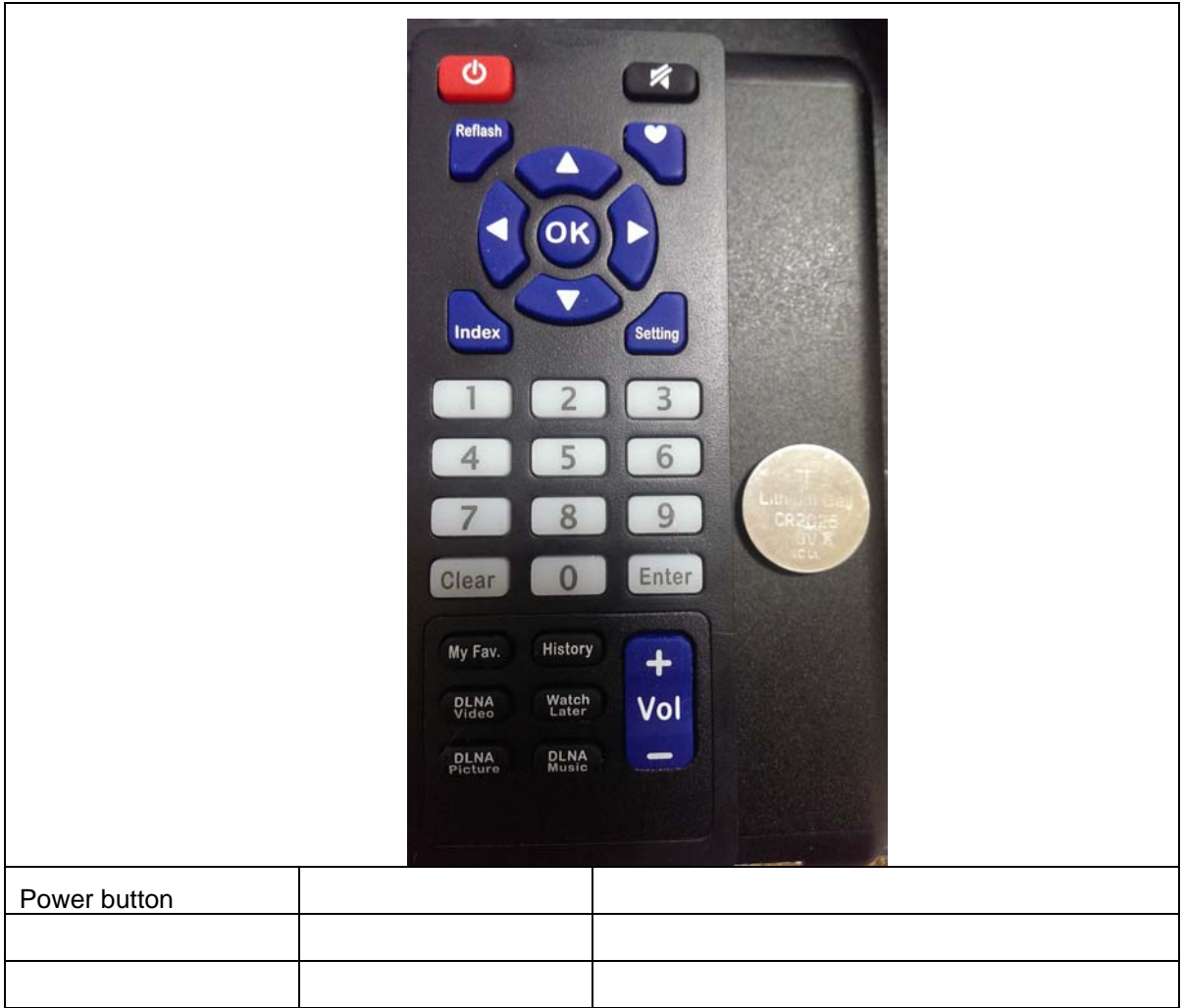

Prerequisites (User Self-Provided)

- a. Wireless (wireless router 802.11 a, b, g, n compatible) with internet access (must have access rights).
- b. Android, Apple handheld device (phone or tablet) or Windows PC with internet access.
- c. A display (TV or monitor) with HDMI input connection.
- d. A valid [gmail](#) or [Youtube](#) account.

Initialization

1. Inserting the button battery

- a. Open the battery cover by placing your index finger's nail underneath the clip (blue circle) and gently lift the battery cover



- b. Place the battery on a 30 ~ 45 degree angle and insert it into the remote control battery socket.







- c. Place the battery cover back onto the socket and gently press downwards until you hear a click.

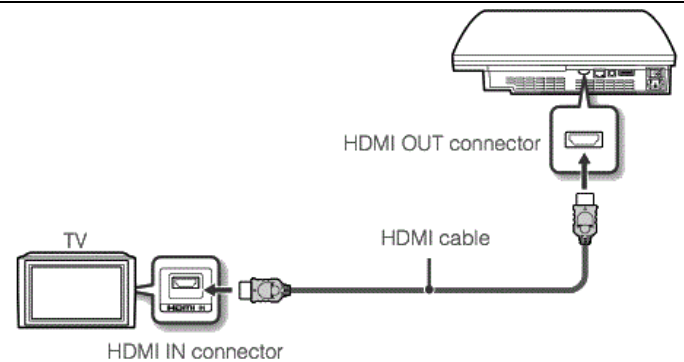

2. HDMI cable connection

Connect the HDMI cable to PoChannel Box HDMI output port and to display's HDMI input port.

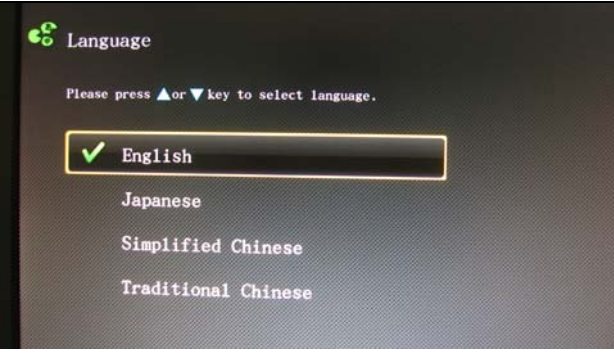

<p>3. Plugging in the power adaptor</p> <p>Plug in the micro-USB connector into the micro-USB port at the rear of your PoChannel Box and plug the adaptor into a household wall socket.</p>	
<p>4. Turn on your TV / monitor, select the HDMI input source (please refer to your display's instruction manual) and the PoChannel Welcome screen should appear for a few seconds.</p>	
<p>5. The language selection menu should appear, use the ▲▼ button on the remote control to select the preferred language and press the "OK" button to continue.</p>	
<p>6. PoChannel will automatically search for WiFi signal.</p>	
<p>7. Use the ▲▼◀▶ button to select the Wi-Fi you have access and wish to connect to. Press the "OK" button and PoChannel Box will prompt you to enter the password to connect to the Wi-Fi signal. Use the ▲▼◀▶ to enter your password. When done, use the buttons again to highlight "Done" and press the "OK" button on the remote control.</p>	

Note: If you are sure the password is correct and am unable to connect to the Wi-Fi router. You may need to consult the person that set up your Wi-Fi network as it may be restricted by MAC address filtering.

8. Connecting to Wi-Fi network should appear.

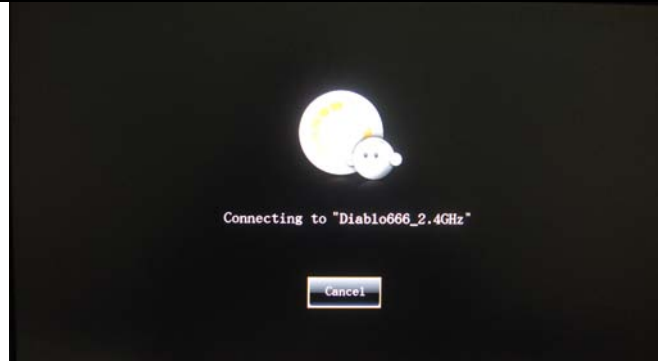

9. When connected, the PoChannel Box activation screen will appear and it will self-generate a code on its own for you to activate the PoChannel Box.



10.
a. Open a browser on your PC and enter "www.pochannel.com" in the address bar. Enter the code and choose a name for your PoChannel Box. Click on the "OK" button.

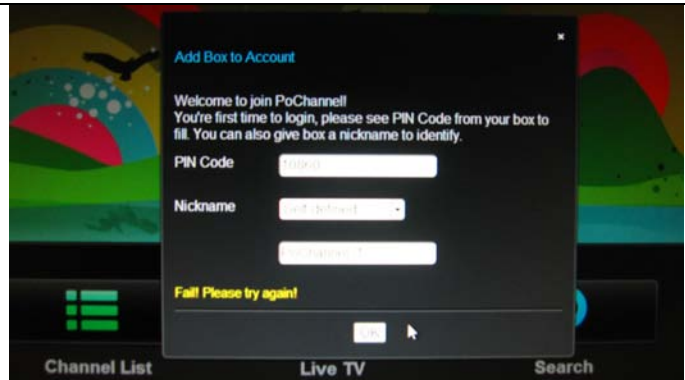

The "activation successful" screen will appear and you may begin using your PoChannel Box

b. Or alternatively, you can download the PoChannel APP

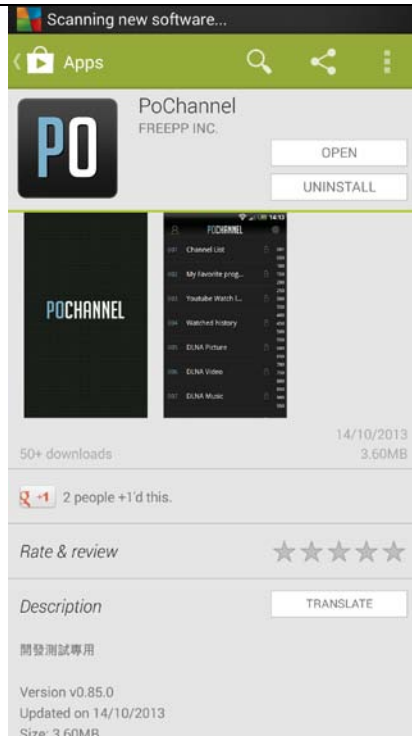

Once installed, sign in with your gmail account