

TOSHIBA

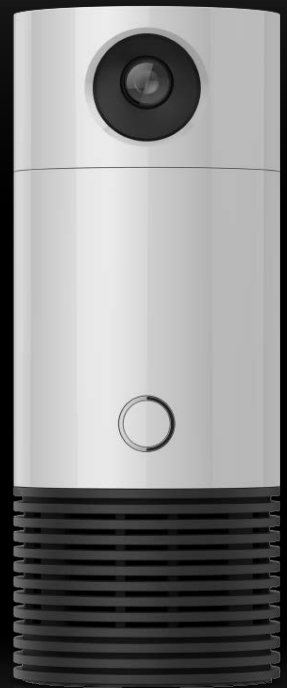

# *Symbio*<sup>TM</sup>

Smart Home Solution



# Table of Contents



**Cautions and Disclaimers**

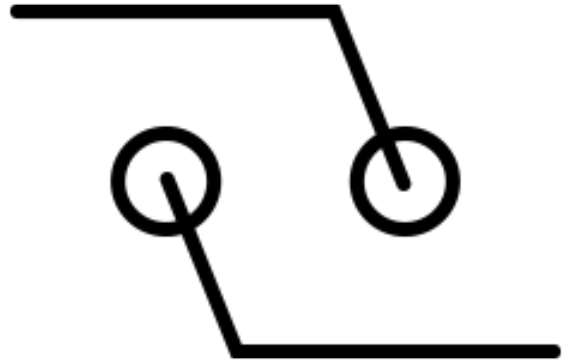

**Preparation**



**Part Names**



**Symbio Setup**



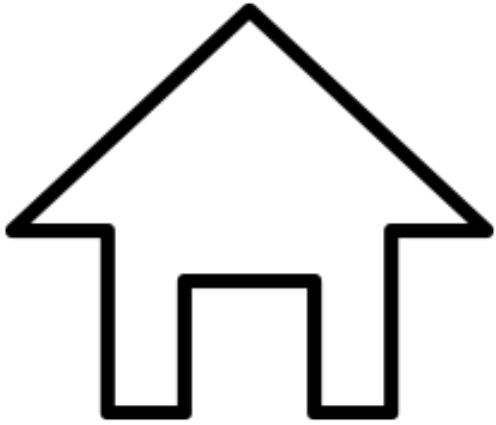

**Icon Glossary**

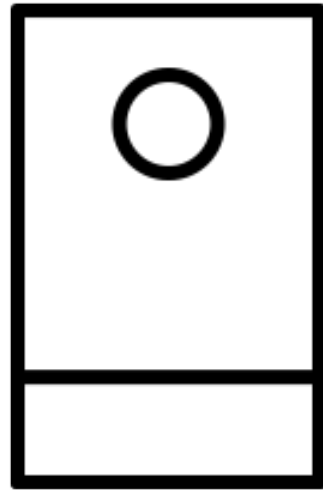

**Using Symbio**



**Troubleshooting**

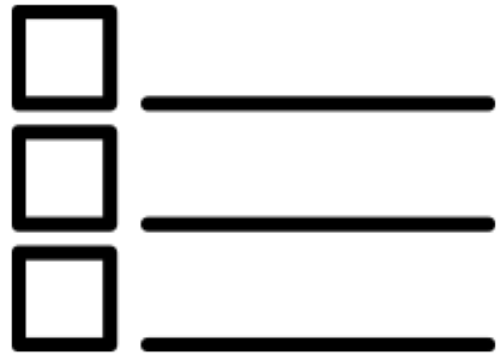

**Specifications**

# Cautions and Disclaimers

---

Safety Precautions

Disclaimers, Trademarks, etc.

# Safety Precautions

---

The rating plate is on the bottom of the product.

## **WARNING:**

TO REDUCE THE RISK OF ELECTRIC SHOCK, DO NOT REMOVE COVER. NO USER SERVICEABLE PARTS INSIDE. REFER SERVICING TO QUALIFIED SERVICE PERSONNEL.

TO PREVENT ELECTRIC SHOCK, MATCH WIDE BLADE OF PLUG TO WIDE SLOT OF AC POWER OUTLET, THEN FULLY INSERT.

## **Warnings:**

- Handling the cord on this product will expose you to lead, a chemical known to the State of California to cause cancer and birth defects or other reproductive harm. Wash hands after handling.
- Do not expose the product to liquids. Do not place items containing liquid on top of the product, such as glasses or vases.
- Keep the product away from direct sunlight, extreme cold, or heat sources. Exposure to extreme temperatures may damage or reduce the life of the product.

## **IMPORTANT SAFETY INSTRUCTIONS**

1. Do not use this product near water.
2. Clean only with a dry cloth.
3. Do not block any of the ventilation openings.
4. Do not install near any heat sources such as radiators, heat registers, stoves, or other devices that produce heat.
5. Protect the AC adapter and cord from being on damaged or pinched.
6. Only use approved attachments and accessories.
7. Unplug this product during lightning storms.

8. Refer all servicing to qualified service personnel.

Servicing is required when the product has been damaged in any way, including when the power cord or plug is damaged, liquid has been spilled or objects have fallen into the product, the product has been exposed to rain or moisture, the product does not operate normally, or the product has been dropped.

9. Never pull on a power cord/cable to remove a plug from a socket. Always grasp the plug directly. Failure to follow this instruction may damage the cord/cable, and/or result in a fire or electric shock, possibly resulting in serious injury. Always confirm that the power plug (and extension cable plug if used) has been fully inserted into the socket, to ensure a secure electrical connection. Failure to do so may result in a fire or electric shock, possibly resulting in serious injury. Be careful if you use a power strip. An overload on one socket could cause a fire or electric shock, possibly resulting in serious injury.

## Critical Applications

This product is not designed for any "critical applications."

"Critical applications" means life support systems, medical applications, connections to implanted medical devices, commercial transportation, nuclear facilities or systems, or any other applications where product failure could lead to injury to persons, loss of life, or catastrophic property damage.

**ACCORDINGLY, TOSHIBA VISUAL SOLUTIONS CORPORATION (hereinafter "TVS"), ITS AFFILIATES AND SUPPLIERS DISCLAIM ANY AND ALL LIABILITY ARISING OUT OF THE USE OF THE PRODUCT IN ANY CRITICAL APPLICATIONS. IF YOU USE THE PRODUCT IN A CRITICAL APPLICATION, YOU, AND NOT TVS, ASSUME FULL RESPONSIBILITY FOR SUCH USE.**

## ADDITIONAL SAFETY INSTRUCTIONS

1. If the product should emit smoke or an unusual odor, immediately disconnect the AC adapter from the wall outlet and obtain service from an authorized service provider.

### USA

#### Federal Communications Commission Statement

#### FCC Compliance Statement

This device complies with Part 15 of the FCC Rules.

Operation is subject to the following two conditions:

(1) This device may not cause harmful interference, and (2) This device must accept any interference received, including interference that may cause undesired operation

### ***Interference***

*This equipment has been tested and found to comply with the limits for a Class B digital device, pursuant to Part 15 of the FCC Rules. These limits are designed to provide reasonable protection against harmful interference in a residential installation. This equipment generates, uses, and can radiate radio frequency energy and, if not installed and used in accordance with the instructions, may cause harmful interference to radio communications. However, there is no guarantee that interference will not occur in a particular installation. If this equipment does cause harmful interference to radio or television reception, which can be determined by turning the equipment off and on, the user is encouraged to try to correct the interference by one of the following measures:*

- *Reorient or relocate the receiving antenna.*
- *Increase the separation between the equipment and receiver.*
- *Connect the equipment into an outlet on a circuit different from that to which the receiver is connected.*
- *Consult the dealer or an experienced radio/TV technician for help.*
- *Bluetooth® and Wireless LAN devices operate within the same radio frequency range and may interfere with one another. If you use Bluetooth and Wireless LAN devices simultaneously, you may occasionally experience a less than optimal network performance or even lose your network connection. If you should experience any such problem, immediately turn off your Bluetooth or Wireless LAN device.*

### **Wireless Radio**

#### **Radio Frequency Interference Requirements**

This device is restricted to indoor use due to its operation in the 5.15 GHz to 5.25 GHz frequency range. FCC requires this product to be used indoors for frequency range 5.15 GHz to 5.25 GHz to reduce the potential for harmful interference to co-channel Mobile Satellite systems.

High power radars are allocated as primary users of the 5.25 GHz to 5.35 GHz and 5.65 GHz to 5.85 GHz bands. These radar stations can cause interference with and/or damage this device.

***Important:*** Any changes or modifications not expressly approved by the party responsible for compliance could void the user's authority to operate this equipment. This device and its antenna(s)

*must not be co-located or operating in conjunction with any other antenna or transmitter.*

## **FCC Notice "Declaration of Conformity Information"**

This equipment has been tested and found to comply with the limits for a Class B digital device, pursuant to Part 15 of the FCC rules. These limits are designed to provide reasonable protection against harmful interference in a residential installation.

This equipment generates, uses and can radiate radio frequency energy and, if not installed and used in accordance with the instructions, it may cause harmful interference to radio communications. However, there is no guarantee that interference will not occur in a particular installation. If this equipment does cause harmful interference to radio or television reception, which can be determined by turning the equipment off and on, the user is encouraged to try to correct the interference by one or more of the following measures:

- Reorient or relocate the receiving antenna.
- Increase the separation between the equipment and receiver.
- Connect the equipment to an outlet on a circuit different from that to which the receiver is connected.
- Consult the dealer or an experienced radio/TV technician for help.

Changes or modifications made to this equipment not expressly approved by TVS or parties authorized by TVS could void the user's authority to operate the equipment.

## **FCC Radiation Exposure Statement**

This equipment complies with FCC radiation exposure limits set forth for an uncontrolled environment. This equipment should be installed and operated with minimum distance 20cm between the radiator & your body.

## **Wireless LAN and Your Health**

Wireless LAN products, like other radio devices, emit radio frequency electromagnetic energy. The level of energy emitted by Wireless LAN devices however is far much less than the electromagnetic energy emitted by wireless devices such as mobile phones.

Because Wireless LAN products operate within the guidelines found in radio frequency safety standards and recommendations, TVS believes Wireless LAN is safe for use by consumers. These standards and recommendations reflect the consensus of the scientific community and result from deliberations of panels and committees of scientists who continually review and interpret the extensive research literature.



In some situations or environments, the use of Wireless LAN may be restricted by the proprietor of the building or responsible representatives of the organization if the risk of interference to other devices or services is perceived or identified as harmful.

If you are uncertain of the policy that applies on the use of wireless devices in a specific organization or environment, you are encouraged to ask for authorization to use the Wireless LAN device prior to turning on the equipment.

## **Bluetooth® Wireless Technology and Your Health**

Products with Bluetooth® wireless technology, like other radio devices, emit radio frequency electromagnetic energy. The level of energy emitted by devices with Bluetooth wireless technology however is much less than the electromagnetic energy emitted by wireless devices such as mobile phones.

Because products with Bluetooth wireless technology operate within the guidelines found in radio frequency safety standards and recommendations, TVS believes Bluetooth wireless technology is safe for use by consumers.

These standards and recommendations reflect the consensus of the scientific community and result from deliberations of panels and committees of scientists who continually review and interpret the extensive research literature.

In some situations or environments, the use of Bluetooth wireless technology may be restricted by the proprietor of the building or responsible representatives of the organization if the risk of interference to other devices or services is perceived or identified as harmful.

If you are uncertain of the policy that applies on the use of wireless devices in a specific organization or environment, you are encouraged to ask for authorization to use the device with Bluetooth wireless technology prior to turning on the equipment.

# **PRECAUTIONS**

## **Notes on handling**

- When shipping the product, the original shipping carton and packing materials come in handy. For maximum protection, repack the product as it was originally packed at the factory. Take care not to give it a shock or shake when carrying.
- Do not use volatile liquids, such as insect spray, near the product. Do not leave rubber or plastic products in contact with this product for a long time. They will leave marks on the finish.

- The product may become warm after a long period of use. This is not a malfunction.
- When the product is not in use for a long period, disconnect the power.
- If you do not use the product for a long period, the product may not function properly. Turn on and use the product occasionally.

### **Notes on locating**

- Place the product on a level surface. Do not use it on a shaky or unstable surface such as a wobbling table or inclined stand.
- When you place this product near a TV, radio, or VCR, the playback picture may become poor and the sound may be distorted. In this case, place the product away from the TV, radio, or VCR.
- Do not use this product in places which are extremely hot, cold, dusty or humid.
- Do not restrict the air flow of this product by placing somewhere with poor air flow, by covering it with a cloth, or by placing it on bedding or carpeting.

### **Notes on cleaning**

Use a soft, dry cloth for cleaning.

- For stubborn dirt, soak the cloth in a weak detergent solution, wring well and wipe. Use a dry cloth to wipe it dry. Do not use any type of solvent, such as thinners and benzene, as they may damage the surface of the product.
- If you use a chemical saturated cloth to clean the product, follow that product's instructions.

### **Notes on moisture condensation**

Moisture condensation damages the product.

Moisture condensation may occur:

- When you bring the product directly from a cold place to a warm place.
- When you use the product in a room where you just turned on the heater, or a place where the cold wind from the air conditioner directly hits the product.

### **About "disposal" and "transfer" of this product**

When you dispose of this product, abide by local ordinance or regulation.

We recommend removing personal information by initializing all settings when disposing or transferring this product. Press and hold the Reset button to initialize all settings.

⇒ [Part Names](#)

## **On Recycling**

This product's packaging materials are recyclable and can be reused.

Please dispose of any materials in accordance with your local recycling regulations.

# Disclaimers, Trademarks, etc.

---

## PRODUCT DISCLAIMERS AND LEGAL INFORMATION

Important Legal Disclaimers. Please note that some Legal Disclaimers are product or feature specific and may not be applicable to you.

### GENERAL DISCLAIMER

#### 1. Product specifications

The information contained in this manual, including but not limited to any product specifications, is subject to change without notice.

#### 2. Warranty

Toshiba Visual Solutions Corporation ("TVS") does not give any additional warranties beyond those contained in TVS's description of the individual product or as provided by law. **TVS PROVIDES NO WARRANTY WITH REGARD TO THIS MANUAL OR ANY OTHER INFORMATION CONTAINED HEREIN AND HEREBY EXPRESSLY DISCLAIMS ANY IMPLIED WARRANTIES OF MERCHANTABILITY OR FITNESS FOR ANY PARTICULAR PURPOSE WITH REGARD TO ANY OF THE FOREGOING. TVS ASSUMES NO LIABILITY FOR ANY DAMAGES INCURRED DIRECTLY OR INDIRECTLY FROM ANY TECHNICAL OR TYPOGRAPHICAL ERRORS OR OMISSIONS CONTAINED HEREIN OR FOR DISCREPANCIES BETWEEN THE PRODUCT AND THE MANUAL. IN NO EVENT SHALL TVS BE LIABLE FOR ANY INCIDENTAL, CONSEQUENTIAL, SPECIAL, OR EXEMPLARY DAMAGES, WHETHER BASED ON TORT, CONTRACT OR OTHERWISE, ARISING OUT OF OR IN CONNECTION WITH THIS MANUAL OR ANY OTHER INFORMATION CONTAINED HEREIN OR THE USE THEREOF.**

#### 3. Internet Capability

Some features may require an always-on broadband internet connection, firmware update and/or additional bandwidth. Internet services may not be available to you in your region. Third party internet services are not provided by TVS, may change or be discontinued at any time and may be subject to third party restrictions.

TVS makes no representations or warranties about these services, which may require the creation of a user account through a computer with internet access and one-time and/or recurring charges.

#### **4. Third party internet services**

Third party internet services are not provided by TVS, may change or be discontinued at any time and may be subject to internet service provider restrictions. TVS makes no warranties, representations, or assurances about the content, accuracy, availability or functionality of third party content or services. Use of third party internet services may require the creation of a separate account through a computer with internet access and/or payment of one-time and/or recurring charges and membership. Not all third party services may be available on or compatible with this product. In order to experience the full capabilities of this product, fully-compatible devices may be required.

#### **5. Third party trademarks, service marks and trade names**

All the trademarks, service marks and trade names belong to their respective owners. TVS disclaims any proprietary interest in the trademarks and names of other parties and their publication does not grant third parties any right or license with respect to them.

## **Disclaimer**

Home IoT cloud service may be temporarily shut down without prior notice due to maintenance or for security reasons. During such shutdowns, certain functions of the product may not work properly or may be restricted, including interoperability with your smartphone and video recording.

Amazon cloud service may be temporarily shut down without prior notice due to maintenance, security reasons or other server issues. During such a time, the Alexa function of the product may not function properly or may be restricted.

## **Trademarks**

- The Wi-Fi CERTIFIED Logo is a certification mark of the Wi-Fi Alliance.
- Bluetooth is owned by the trademark holder, and Toshiba Visual Solutions Corporation uses it under license.
- Z-Wave and Z-Wave Plus are registered trademarks of Sigma Designs and its subsidiaries in the United States and other countries.
- ZigBee® Certified is a registered trademark of the ZigBee Alliance.

- Amazon Alexa is a registered trademark of Amazon.com, Inc.
- Pandora is a registered trademark of Pandora Media, Inc.
- Spotify is a registered trademark of Spotify Technology S.A.
- App Store is a service mark of Apple Inc.
- GooglePlay <sup>™</sup> logo is registered trademark of Google Inc.

## Copyright

Under the copyright laws, this guide cannot be reproduced in any form without the prior written permission of Toshiba Visual Solutions Corporation. No patent liability is assumed, however, with respect to the use of the information contained herein. ©TOSHIBA VISUAL SOLUTIONS CORPORATION 2017 All rights reserved.

## Need Help?

Save time with one of these simple solutions.

### **Consult the electronic User's Guide**

To access the electronic User's Guide please visit <http://www.TSB-SmartHome.com>. For solutions to the most common problems, refer to the Troubleshooting section of the User's Guide.

### **Visit Toshiba's Support Web site**

<http://www.TSB-SmartHome.com>



# Part Names

---

Front

Back

Bottom

Accessories

# Front

---

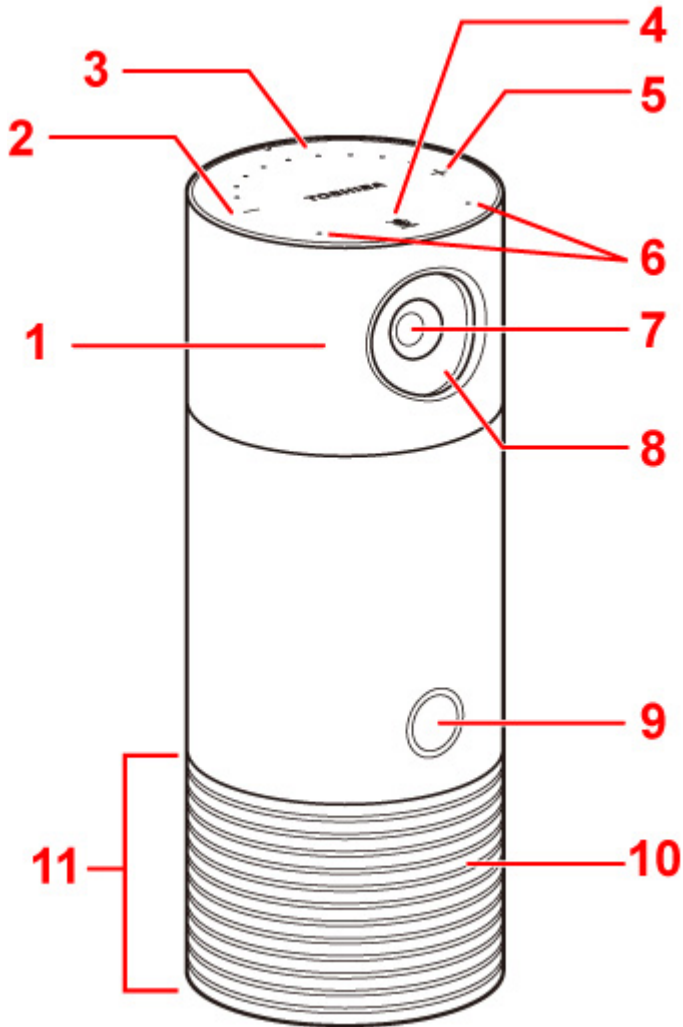

**1. Lens cover**

Can be rotated to cover and turn off the video camera.

**2. Volume down button**

Press to decrease the volume.

**3. Volume indicator**

Dots lights up as the volume is changed.

**4. Microphone mute/Talk button**

Press to turn off the microphones. The icon will turn red when the microphones are off. Press again to turn them back on.

Press and hold this button for 2 seconds to wake up Alexa, then talk directly to your Symbio.



5. **Volume up button**

Press to increase the volume.

6. **Microphone holes**

Used for voice operations.

7. **Camera**

Used for monitoring.

8. **Night vision LED**

Infrared LED for night vision.

9. **Light ring**

Lights up in different colors to let you know what Symbio is doing.

⇒ [Light Ring Status](#)

10. **Camera indicator**

Lights up when the camera is on.

11. **Speaker**

Emits sound when playing back an audio source.

# Back

---

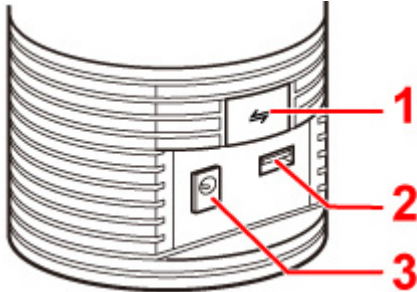

## 1. Network/Pairing button

Press briefly to activate Bluetooth® pairing mode.

Press and hold for about 10 seconds to activate Wi-Fi pairing mode.

### Note

- Bluetooth pairing mode is activated for 60 seconds.
- Wi-Fi access point pairing mode is activated for 30 minutes.

## 2. USB terminal

Used in the manufacturing process and after-sales service. This is not for consumer use like charging mobile devices or copying files.

## 3. Power input

Connect the supplied AC adapter.

# Bottom

---

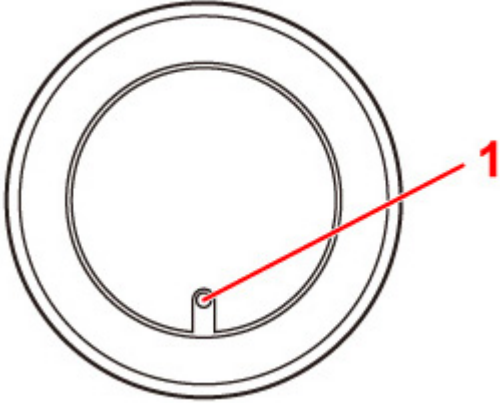

## 1. Reset button

### **Important**

- This process will reset Symbio to the factory default settings. This means all rules will be deleted, all sensors will be orphaned and any device settings will be lost. This is not reversible.

Press and hold the button using a paper clip or something similar.

Pressing and holding the button makes the Volume and Microphone mute indicators start blinking. After they stop blinking and shut off, release the button. This will restore the factory default settings. If this is the primary Z-Wave controller for your network, resetting it will orphan the nodes in your network and it will become necessary to exclude and re-include all of the nodes in the network.

# Accessories

---



**AC adapter**

This is used to power Symbio.

# Light Ring Status

Symbio's light ring lights up/flashes in different colors to indicate its status.

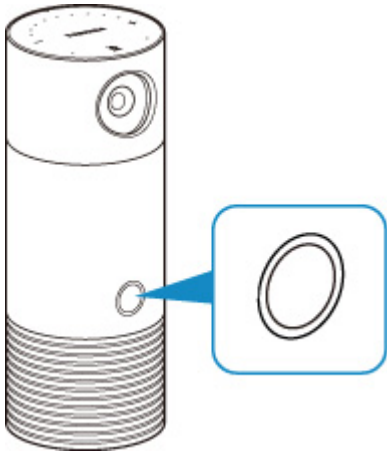

Ring LED color and status	Status of Symbio
Lights up white.	Symbio is connected to Wi-Fi.
	Symbio has been turned on.
	Ready for initial setup.
Flashes blue slowly.	Symbio is searching for a target wireless router.
Flashes yellow slowly.	A network connection error has occurred.
Flashes red slowly.	Symbio is unable to update its firmware.
Flashes white slowly.	Symbio is updating its firmware.
Flashes white rapidly.	Symbio has entered Wi-Fi pairing mode (AP mode).
Flashes blue rapidly.	Symbio has entered Bluetooth pairing mode.
Flashes red rapidly.	Symbio is sounding a siren.



# Preparation

---

Follow the steps below to use Symbio.

## 1. Placement of your Symbio.

Because Symbio includes a security camera, you should place it where the camera can see what you want to monitor. On a shelf or on the kitchen counter are great options.

## 2. Plug in your Symbio.

Plug the included AC adapter into your Symbio and connect to an AC outlet. When you first plug in, the light ring will be white.

## 3. Download the Toshiba Smart Home app.

Download the Toshiba Smart Home app to your smartphone or tablet from the App Store or Google Play. The app is where you will control most of the features and settings of the Symbio.

## 4. Open the Toshiba Smart Home app.

The setup process will start automatically when you open the app. During setup, you will be connecting Symbio to the Internet.

You will need:

- Your Wi-Fi password
- An Amazon account sign-in

See [Symbio Setup](#) for details.

### Important

- You must agree to Terms of Use and Privacy Policy when you use the Toshiba Smart Home app. Please read these carefully. By using the Toshiba Smart Home app, you agree to the Terms of Use and Privacy Policy.

# Symbio Setup

---

Setting Up a New Symbio

Adding a Second Symbio

Adding a Second Phone

Re-pair a Symbio to a New Phone

Removing a Phone from a Symbio

Removing a Symbio from a Phone



# Setting Up a New Symbio

---

Follow the steps below to perform initial setup and pairing Symbio with Toshiba Smart Home app.

Before performing initial setup, check the OS version of your smartphone. You can use Toshiba Smart Home app on the following OS versions.

- iOS: 10.0 or later
- Android: 5.0 or later

## 1. Plug in Symbio.

Plug the included AC adapter into Symbio and connect it to an AC outlet. After plugging in the Symbio, the led ring will turn white.

## 2. Open Toshiba Smart Home app.

The screen below appears.

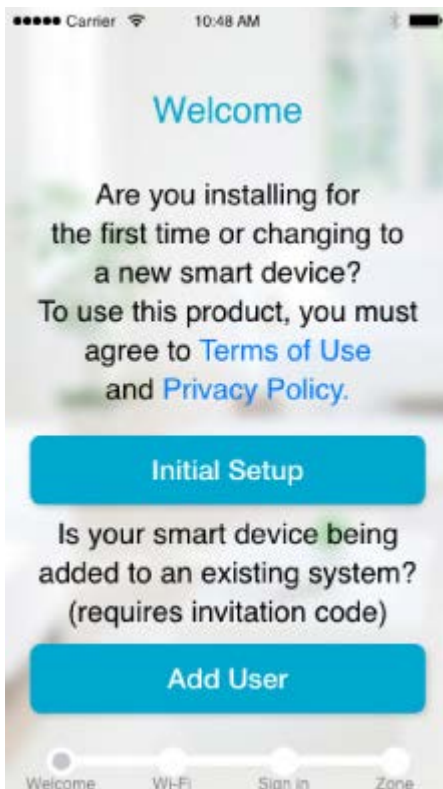

## 3. Tap **Initial Setup**.



4. Tap **Connect Device** on the displayed screen.

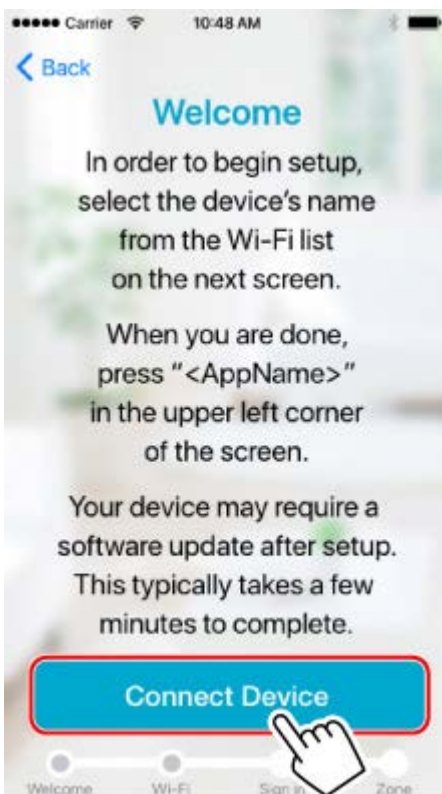

5. You now need to connect your phone to the Symbio's internal wifi.

- **If you are using iOS**

In iOS settings, navigate to Wi-Fi settings

Select "THINGS\_XXXXXX" from the list of networks.

Tap on the upper left arrow to return to the "Toshiba Smart Home" app.

- **If you are using Android**

The app will automatically connect to the Symbio if it is the only one available.

If the app finds multiple Symbio units, you will need to select yours from the list. *(Info on how to determine which one is yours)*

6. Change default name of Symbio (if desired). Tap **Next** to continue.

7. When the screen below appears, tap to select the wireless router from the list.

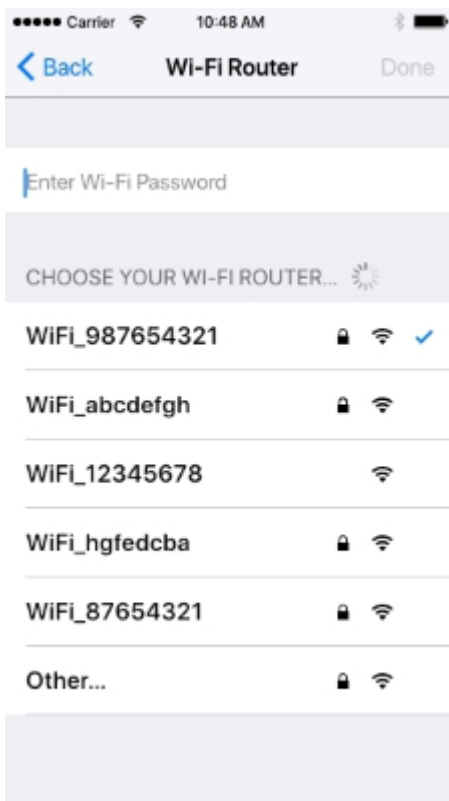

Enter the password for the selected wireless router and tap **Done**.

8. When LED stops pulsing and becomes solid white, please tap **Go to Pairing** below.

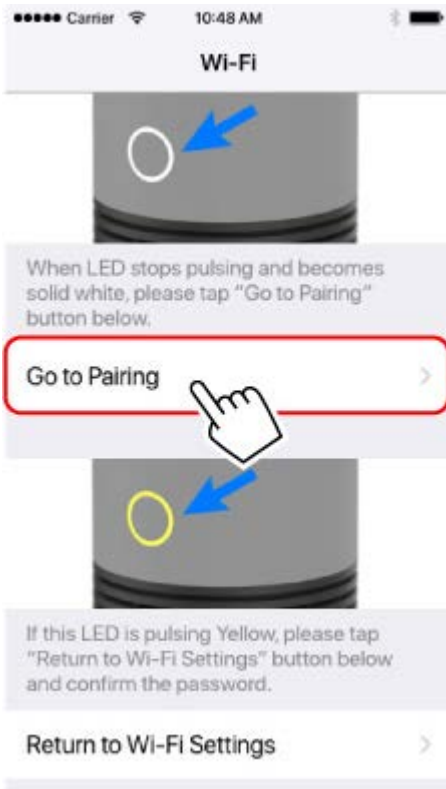

9. At this point you will use your Amazon account to register your Symbio with the Toshiba Cloud. Tap on the Amazon icon and enter your Amazon account login information.



## Note

- If you plan on using Amazon Alexa, check "Keep Me Signed In" to prevent having to entering your Amazon login again

10. You will now log into Alexa. This step is optional, if you do not plan on using Alexa press **Skip**.

Tap **Sign in with Amazon**. If you checked **Keep Me Signed In** in the previous step, press **Continue**, otherwise you will need to enter your Amazon login information.



11. Select a zone where Symbio will operate. This will determine the zone where the Symbio's internal sensors are listed in the app

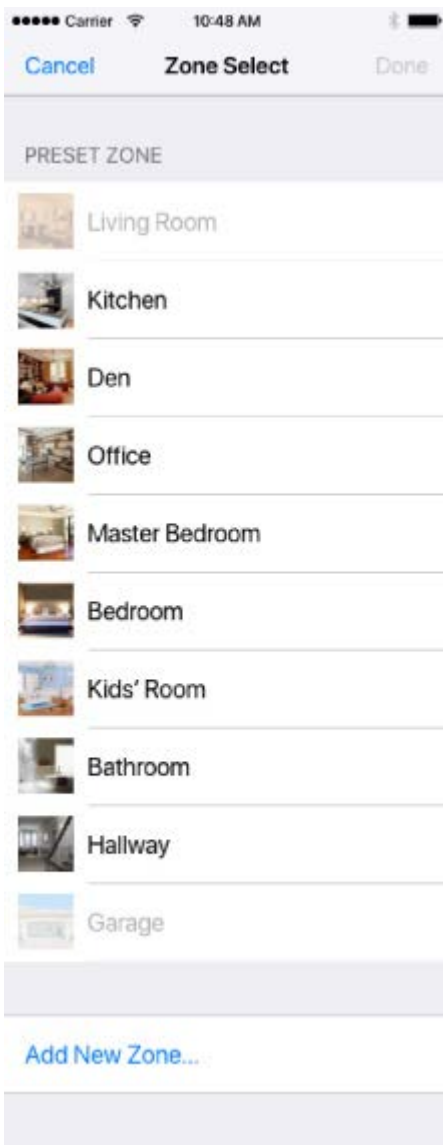

### Important

- When you select a zone where water is present (e.g. kitchen), avoid placing Symbio where it may be subject to water exposure.

12. Tap **Done** on the **Zone Select** screen.

Initial setup is now complete.

### Note

- Your device may require a software update after setup. This typically takes a few minutes to complete.

# Adding a Second Symbio

---

You can have multiple Symbios paired to one phone. After pairing two Symbios to your phone you can switch between them by going to **Device Select** in **Settings**. Sensors and Rules are device specific, so you must have selected the correct device to view or edit them. Live view is also specific to each device, when you go into Live View you will see the view from the Symbio you have currently selected.

Follow the steps below to add another Symbio to a smartphone.

1. Open Toshiba Smart Home app.
2. Tap  on the Home screen to go to the **Settings Manager**.
3. Tap **Device**.
4. Tap **Device Select**.
5. Tap **Tap Add New Device**.
6. Follow the steps for [Setting Up a New Symbio](#)

# Adding a Second Mobile Device

---

You can allow another phone to pair to your Symbio to allow friends and family members to use it. These can be guest users with limited access or administrators with full access.

When a new phone is paired with a Symbio it is by default a guest account with no privileges. An administrator can give the new user access to Sensors, Live View and/or Recordings. To become a Admin all that is needed is for the user to login using the owners Amazon login info.

Follow the steps below to add another smartphone to Symbio.

## Perform operations below on the smartphone already connected to Symbio.

1. Open Toshiba Smart Home app.

2. Tap  on the Home screen.

3. Tap **Account**.

4. Tap **Add User**.

5. Enter the e-mail address to which you send an invitation code.

6. Tap **Done**.

## Perform the operations below on the smartphone to connect to Symbio.

1. Open Toshiba Smart Home app.

2. Tap **Add User**.

3. Enter the invitation code you received.

4. Tap **Done**.



This smartphone now has a Guest account on your Symbio.

## Note

- The invitation code will expire, so perform the above procedures soon after receiving it.

# Perform the operations below to give permissions to the new guest account using the first phone

1. Tap  on the Home screen.
2. Tap **Accounts**.
3. Tap **Other Accounts**
4. Tap on the name of the new account.
5. Enable the permissions you want to give this user.

# Perform the operations below to make the guest account an administrator

1. Tap  on the Home screen.
2. Tap **Account**.
3. Tap **Login**.
4. Enter the Amazon ID and password used for your smartphone already connected to Symbio.

# Re-pair a Symbio to a New Mobile Device

---

If you have lost or replaced the phone that was initially paired to the Symbio, you can pair a new phone to it without having to do a factory reset.

Follow these steps to pair a new phone to the Symbio.

1. Open Toshiba Smart Home app.

The screen below appears.

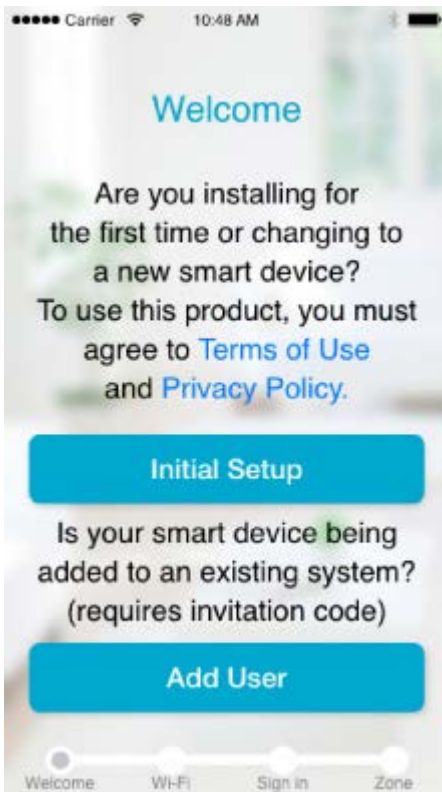

2. Tap **Initial Setup**.



3. Tap **Connect Device** on the displayed screen.

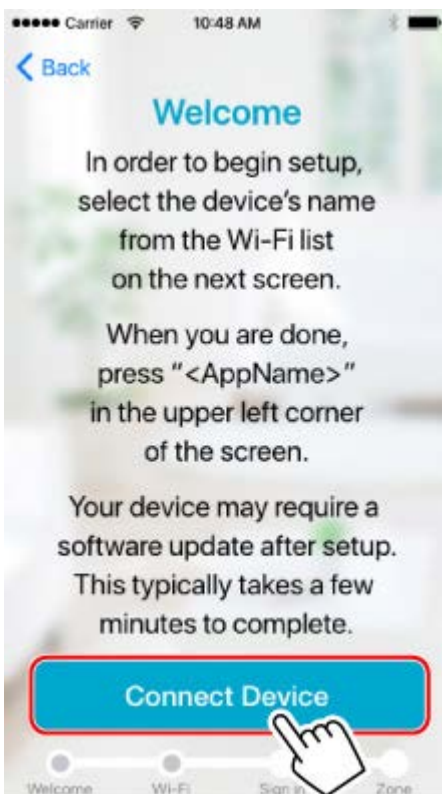

4. Hold the **Pairing Button** on the back of the Symbio for approximately 10 seconds until the Front LED starts to pulse white.

5. You now need to connect your phone to the Symbio's internal wifi.

- **If you are using iOS**

In iOS settings, navigate to Wi-Fi settings

Select "THINGS\_XXXXXX" from the list of networks.

Tap on the upper left arrow to return to the "Toshiba Smart Home" app.

- **If you are using Android**

The app will automatically connect to the Symbio if it is the only one available.

If the app finds multiple Symbio units, you will need to select yours from the list. *(Info on how to determine which one is yours)*

6. Change default name of Symbio (if desired). Tap **Next** to continue.

7. When the screen below appears, tap to select the wireless router from the list.

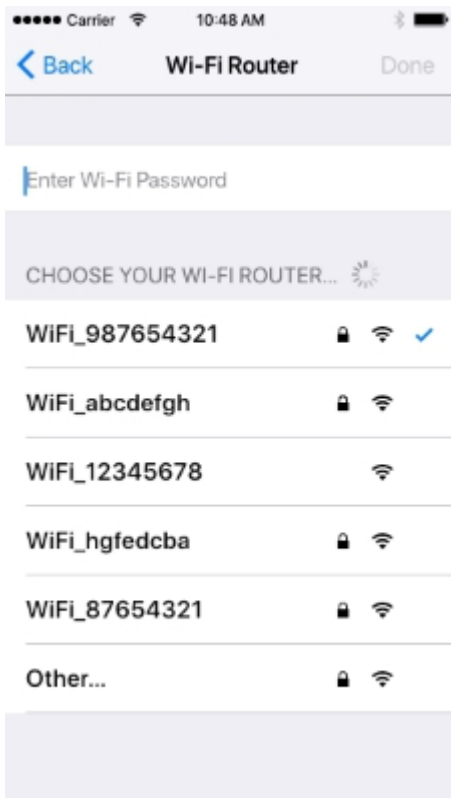

Enter the password for the selected wireless router and tap **Done**.

8. When LED stops pulsing and becomes solid white, please tap **Go to Pairing** below.

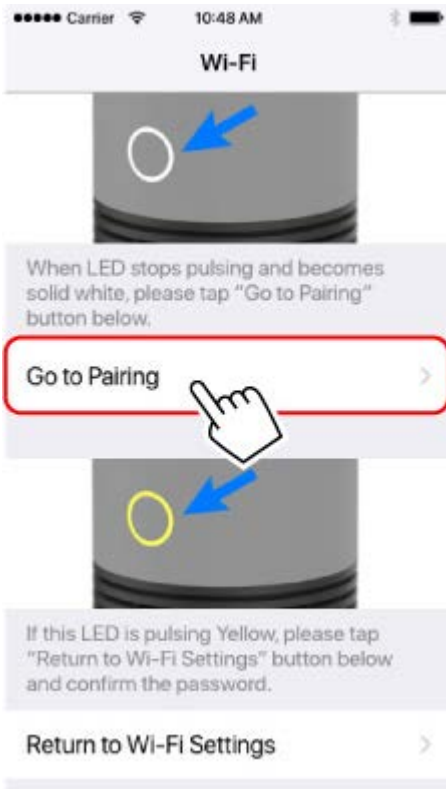

9. You will now use your Amazon account to log into the Symbio as an administrator.  
Tap on the Amazon icon and enter your Amazon account login information.



## Note

- You must use the Amazon account used during initial setup. If you do not know what that account is, you will have to factory reset the Symbio

10. Your phone is now paired to the Symbio.



# Removing a Mobile Device from a Symbio

---

Occasionally it will be necessary to remove a smart device from Symbio's list of paired devices. This can only be done from an admin account.

1. Tap  on the Home screen.
2. Tap **Account**.
3. Tap **Other Account** to get a list of additional devices connected to Symbio.
4. On the account you wish to remove, tap and swipe it left so the trash icon appears on the right. Tap the trash icon to delete the device.

# Deleting a Symbio from a Mobile Device

---

Occasionally it will be necessary to remove an outdated Symbio from the Toshiba Smart Home app. This cannot be done on the active Symbio.

1. Tap  on the Home screen.
2. Tap **Device**.
3. Tap **Device Select** to get a list of Symbios associated to this instance of the Toshiba Smart Home app.
4. On the Symbio you wish to remove, tap and swipe it left so the trash icon appears on the right. Tap the trash icon to delete the device.



# Icon Glossary

---

Home Manager

Settings Manager

Live Video

Sensors Manager

Rules Manager

History

# Home Manager Screen

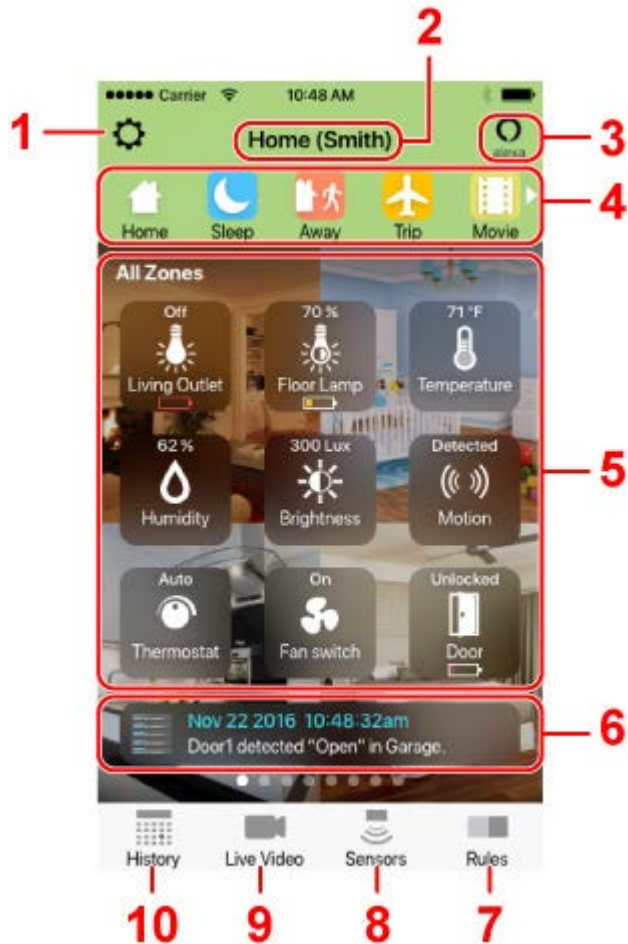

\* The screen appearance is subject to change without notice.

## 1. Settings button

Tap to display the **Setting Manager** screen. This is where you can change the device and app settings.

⇒ [Setting Manager Screen](#)

## 2. Current mode and device name

## 3. Alexa button

Tap to open Live Video, turn on Talkback and activate Amazon Alexa's voice services to allow you to access Alexa's voice services from anywhere with an Internet connection.

## 4. Mode icons

Displays the mode icons currently registered.

"Home", "Sleep", and "Away" icons are displayed by default.

You can register up to three additional, custom modes.

## 5. **Zone view**

Displays registered zones and all sensor icons currently connected to Symbio.

Tap a sensor's icon to display its pop-up menu and change its settings.

Swipe left and right to switch the zone.

## 6. **Notification**

Displays notification when received.

Tap to display the notification history.

Notification history is stored in the device's temporary memory, this means this history bar will be wiped clean if the system is power cycled.

## 7. **Rules button**

Tap to display the **Rules Manager** screen. This is where you can automate your smart home system with an easy to use rules engine.

⇒ [Rules Manager Screen](#)

## 8. **Sensors button**

Tap to display the **Sensor Manager** screen. This is where you can add, remove and edit devices connected to your Symbio.

⇒ [Sensors Manager Screen](#)

Notes on Z-Wave

- This product is a Z-Wave Plus Security Enabled Gateway device in the Central Static Controller Role type.
- This product does not support the Basic Command class and will ignore it.

## 9. **Live Video button**

Tap to display the **Live Video Screen** screen. This is where you can view the real-time image Symbio is monitoring.

⇒ [Live Video Screen](#)

## 10. **History button**

Tap to display the **History** screen. This is where you can watch past recordings and view internal sensor data.

⇒ [History Manager Screen](#)

# Setting Manager Screen

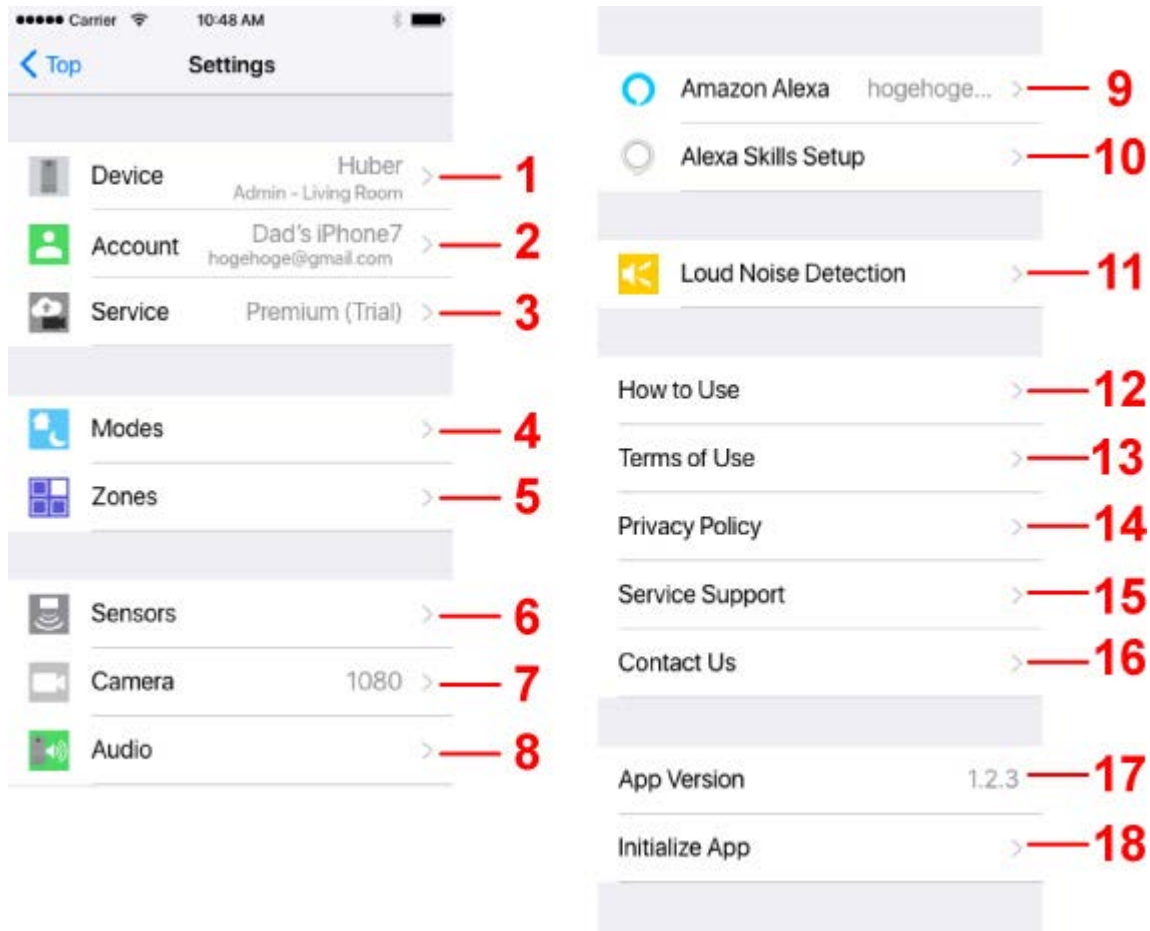

\* The screen appearance is subject to change without notice.

## 1. Device

Tap to perform following operations.

- Select a Symbio to control or to change the name.
- Display information on Symbio(s) currently connected.
- Update firmware of Symbio(s) currently connected.
- Select whether to enable Talkback function on Live Video while the lens cover is closed.
- Choose the behavior of the LED dim feature. You can have the front LED always lit, never lit or base it on the brightness of the room.
- Display information on the Wi-Fi network to which Symbio is connected. You can also change the

Wi-Fi from the same page.

- Set the time zone for Symbio.
- Set the unit of temperature displayed on the app.

## 2. Account

Tap to perform following operations.

- Change your mobile device name.
- Display the login screen.
- Display the screen to add a user on a guest account. This will send an invitation code to a provided email address that the new user can use to pair to Symbio as a guest.\*
- Display the screen to change permissions for other devices.\*
- Delete other mobile devices paired to your Symbio.\*

\* Available only for the administrator.

## 3. Service

Tap to select the account service screen.

### **Important**

- When you are buying a service, your personal information will be transferred to a website of the service supplier. Please note that Toshiba Visual Solutions Corporation bears no responsibility for issues regarding your personal information.

## 4. Modes

Tap to perform the following operations.

- Enable/Disable a custom mode.\*
- Change the mode name.\*
- Change the color or icon for each mode.\*
- Enable/Disable a Rule

### **Note**

- \* This is not available for default modes of Home, Sleep or Away.

---

## 5. Zones

Displays the registered zone list.

Tap the zone name to change the name or the zone's background photo.

### Note

- You can only choose a photo from those available in the app.

By tapping **Add Zone...** you can add other zones to your device. See [Using Zones](#) for more information.

## 6. Sensors

Displays the sensors manager.

⇒ [Sensors Manager screen](#)

## 7. Camera

Tap to perform following operations.

- Change the camera resolution
- Specify the area for motion detection
- Specify the time length for one-touch recording
- Change the sensitivity and area for motion detection. Symbio detects motion by calculating the percentage of pixels changed in a designated window. You can change the window in which Symbio will look for motion and how sensitive it should be to trigger a motion detection.

## 8. Audio

Tap to select the volume adjustment screen.

- Change Master Volume
- Change Talkback Volume
- Change Siren Length and Siren Volume
- Change Bluetooth Speaker Volume
- Add a Bluetooth device

## 9. Amazon Alexa

Tap to log in to/log out from Amazon Alexa.

## 10. **Alexa Skills Setup**

Tap to receive pairing code to enable to the Toshiba skills. See [Setting up Toshiba Custom Skills](#) for more information.

## 11. **Loud Noise Detection**

Tap to adjust the noise detection level. The farther left the slider, the less sound will be necessary to trigger a loud noise detection.

## 12. **How to Use**

Tap to access the How to Use page.

## 13. **Terms of Use**

Tap to access the Terms of Use page.

## 14. **Privacy Policy**

Tap to access the Privacy Policy page.

## 15. **Service Support**

Tap to access the Support page.

## 16. **Contact us**

Tap to access you can send an inquiry email.

## 17. **App Version**

The version of app is displayed.

## 18. **Initialize App**

Tap to reset the app. Information about all connected Symbios will be deleted from the app.

### **Warning**

- This cannot be reversed.



# Live Video Screen

## Important

- Be sure to open the lens cover of Symbio fully when you use the Live Video function. If the lens cover is closed, you will be unable to view the image.

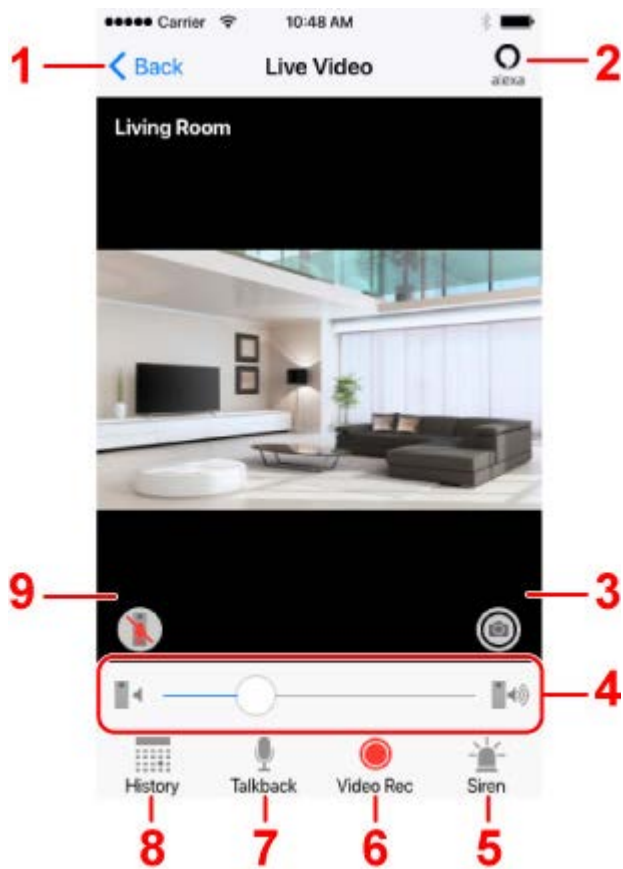

1. Tap to return to previous screen.

## 2. Alexa button

Tap to turn on Talkback and activate Amazon Alexa's voice services to allow you to access Alexa's voice services from anywhere with an Internet connection.

3. Tap to take a snapshot of the current view on the screen.

4. Slide to increase/decrease the speaker volume of Symbio.

## 5. Siren button

Tap to activate Symbio's siren.

When you want to start, tap this button and then tap OK on the next screen.

Tap this button again to stop the sound.

The length of the siren can be changed in the **Audio** menu under **Settings**.

## 6. Video Rec button

Tap to record/stop video recording from Symbio.

### Important

- To use this function, you need to purchase an account service from **Service option** on the **Setting Manager** screen.

⇒ [Setting Manager Screen](#)

## 7. Talkback button

Tap to activate/deactivate voice intercom from the app to Symbio.

## 8. History button

Tap to display the **History** screen. This is where you can watch past recordings and view internal sensor data.

⇒ [History Manager Screen](#)

## 9. Appears when the microphone mute button is enabled.

# Sensors Manager Screen

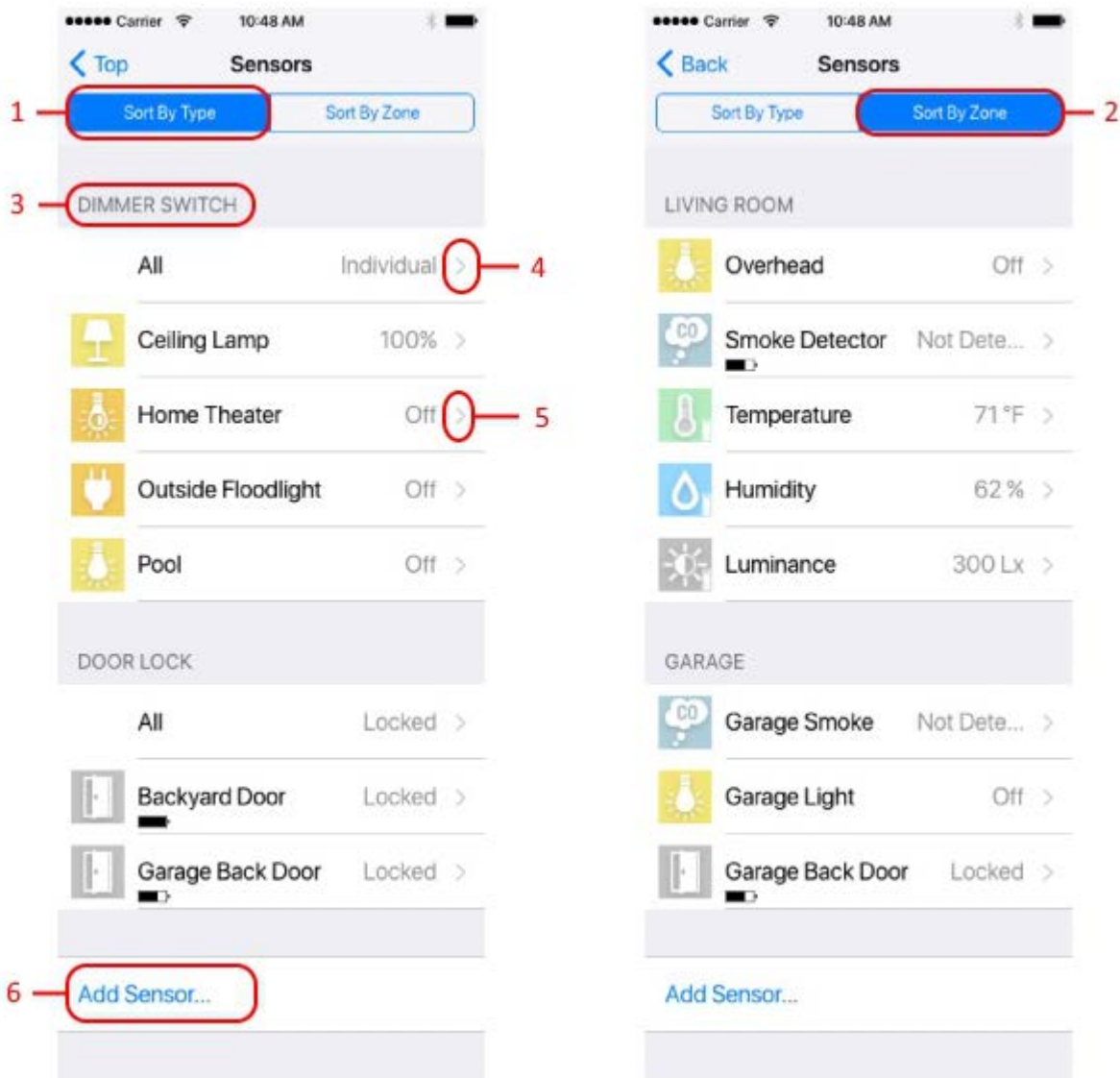

## 1. Sort By Type

Tap to sort sensors by their sensor type.

## 2. Sort By Zone

Tap to sort sensors by their Zone.

## 3. Sensor Grouping

Sensors are sorted by each Type or Zone.

#### 4. **All Sensors in Type**

Depending on the sensor type, the entire group of sensors may be controlled at once.

#### 5. **Individual Sensor**

Tap to control an individual sensor.

#### 6. **Add Sensor**

Tap to add a new sensor.

# Rules Manager Screen

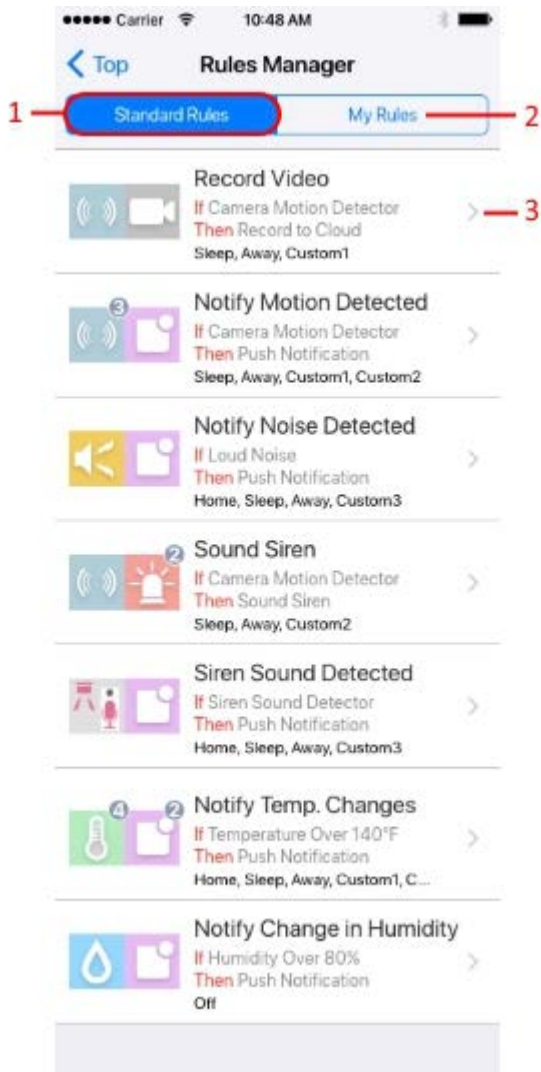

## 1. Standard Rules

Tap to show the list of pre-configured rules.

## 2. My Rules

Tap to show the list of custom created rules.

## 3. Edit Rule

Tap to edit a rule.

# History Screen

---

Recording history on the cloud is displayed on the **History** screen. Up to 64 Notification Events will be stored.

In addition, you can change order of the list according to the cause of recording.

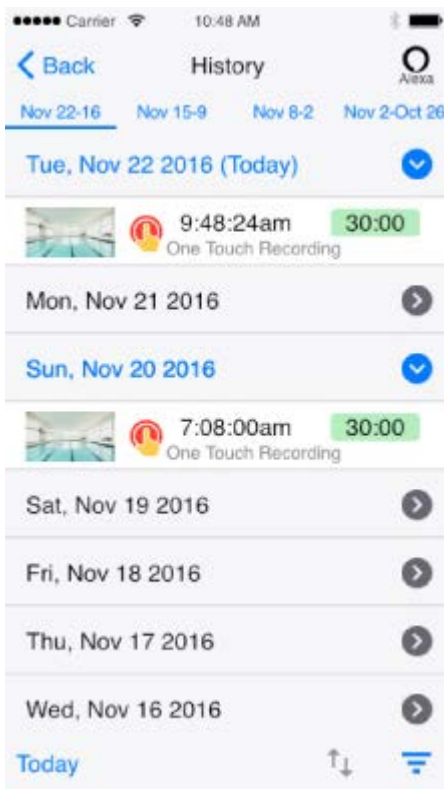

\* The screen appearance is subject to change without notice.

# Using Symbio

---

Modes

Rules

Zones

Symbio's Internal Sensors

External Sensors and Smart Devices

Enjoying Audio on Symbio

Amazon Alexa

# Modes

---



Utilizing modes is the first step in making your Symibo smarter. You can automate your motion detector, turn off your lights or change your thermostat by the tap of a button.

By default there are three standard modes, **Home**, **Sleep** and **Away**, and you can add an additional three custom modes.

From the Home Screen you can easily change the mode by tapping on the corresponding icon. For example, we could change to the sleep mode by pressing the button below.

## Creating a Custom Mode

1. Tap  on the Home screen.
2. Tap **Modes**.
3. Tap **Custom1** or any of the custom mode buttons.





4. Tap the **Enable** switch on.
5. Your custom mode is now enabled, feel free to change the name by tapping the **Name** button or the icon by its corresponding button.
6. From here you can easily activate any desired rules. For more information see [Rules](#).

# Rules

---

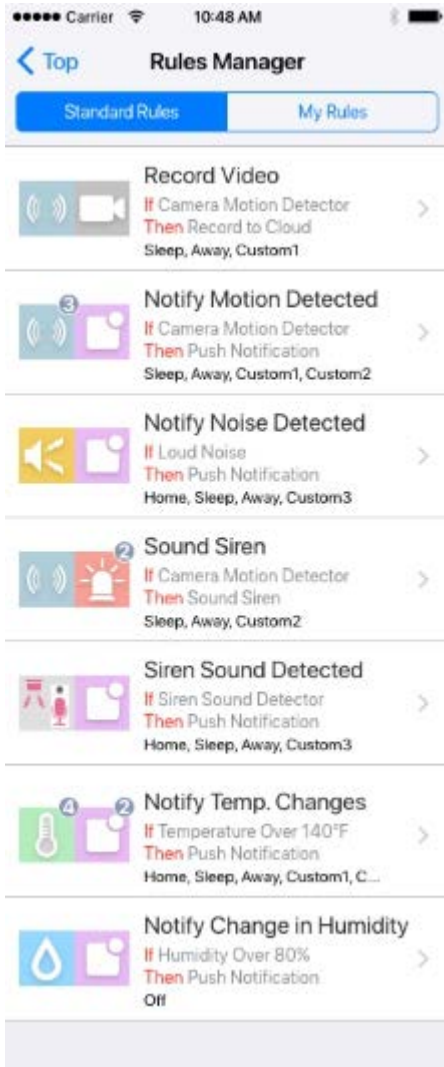

\* The screen appearance is subject to change without notice.

Rules allow you to transition from controlling your smart home to automating it. Rules allow Symbio act automatically without any input from you. You can make the lights come on when motion is detected, turn down the thermostat at night, or sound an alarm when a loud noise is detected.

There are a number of Standard Rules that Symbio suggests or you can create you own custom rules using Symbio's internal sensors or even external ZigBee or Z-Wave smart devices.

You can add/edit rules following the procedure below. Up to 100 rules can be registered (including Standard Rules).

⇒ [Adding Rules](#)

# Standard Rules

1. Tap **Standard Rules** on the **Rules Manager** screen.

The screen below appears.



2. Tap any of the options:

- Record Video - If the camera detects a motion, Symbio will start recording.
- Notify Motion Detected - If the camera detects a motion, Symbio will send you a push notification.
- Notify Noise Detected - If the microphone detects a noise, Symbio will send you a push notification.
- Sound Siren - If the camera detects a motion, sound the internal siren.
- Siren Sound Detected - If the microphone detects a legacy siren (smoke detector or

carbon monoxide detector), Symbio will send you a push notification.

- Notify Temp. Change - If Symbio's internal sensor registers a temperature higher than the desired temperature, it will send you a push notification.
- Notify Change in Humidity - If Symbio's internal sensor registers a humidity value higher than the desired humidity, it will send you a push notification.

3. Select a mode to which the Rule applies.

## Adding Rules

1. Tap **My Rules** on the **Rules Manager** screen.

The screen below appears.

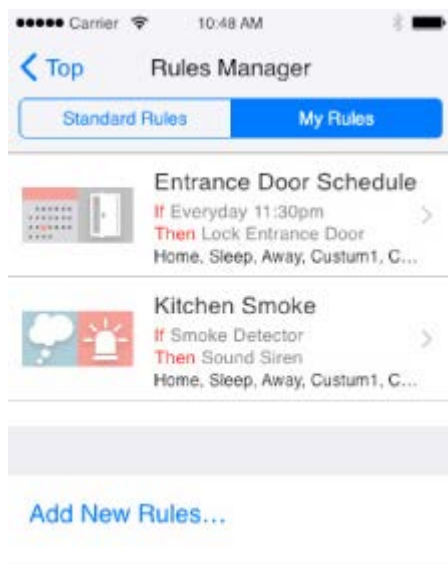

2. Tap **Add New Rules**.

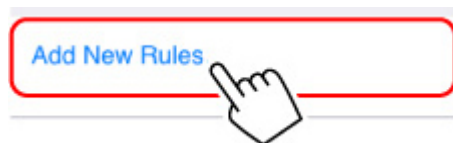

3. Select an "If" trigger event that will cause the Rule to occur. Not inputting an "If" event will cause the Rule to trigger any time you change to the desired mode.

4. Select a "Then" action that will happen when the Rule triggers.

5. Select a mode to which the Rule applies..

### Note

- You can have multiple "If" triggers and "Then" actions. If you have multiple "If" triggers,

all must trigger before the Rule will occur.

## Editing Rules

1. Tap an item to edit on the **Rules Manager** screen.

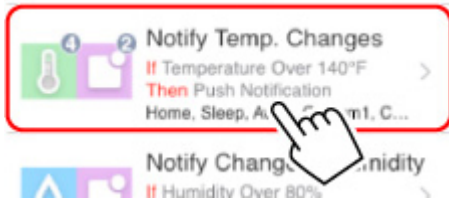

The **Edit Rule** screen appears.

2. Tap an item to edit on the **Edit Rule** screen.

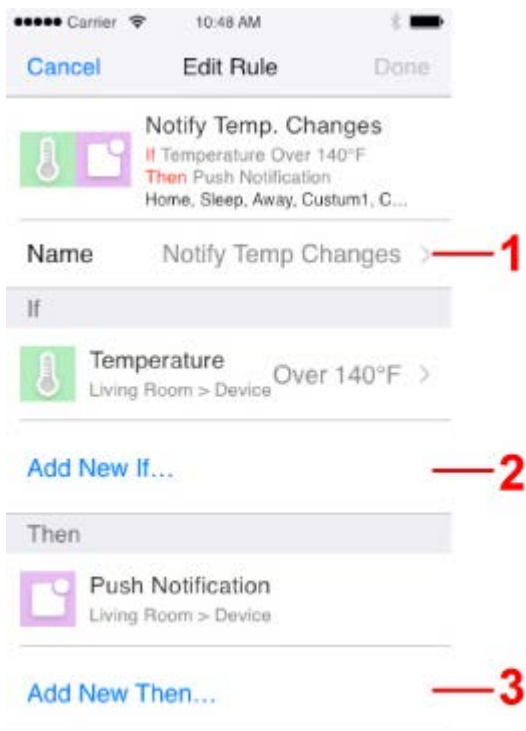

1. Tap to edit the name of the rule.

2. Tap to display the condition list.

Select a condition from the list or tap **Back** to return to the previous screen.

3. Tap to display the action list.

Select an action from the list or tap **Back** to return to the previous screen.

3. Tap **Done**.

Rule editing is completed.

## Deleting Rules

1. Tap **My Rules** on the **Rules Manager** screen.

The screen below appears.

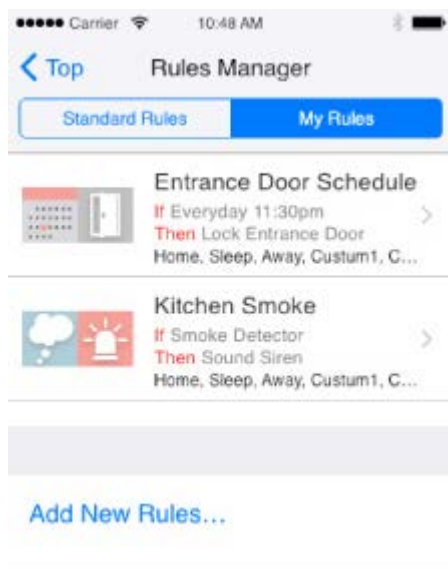

2. Press and hold the rule you wish to delete.
3. Swipe the rule left and press the red trash can button.

# Zones

---

Utilizing zones helps organize any sensors you have paired to your Symbio.

The three internal sensors of Temperature, Humidity and Brightness, will be placed in the zone that the device is placed in by default.

## Creating a New Zone

1. Tap  on the Home screen.
2. Tap **Zones**.
3. Tap **Add Zone...**
4. Select a preset zone or add a new zone by tapping **Add New Zone....**
5. Tap **Done** to finalize creating your new Zone.

## Move a Sensor to a Different Zone

1. From the Home Screen, tap on a sensor icon and tap **Edit**.
2. On the Edit Sensor page, tap the **Zone** button.
3. Choose the sensor's desired zone or create a new zone altogether.
4. Tap **Done** to finalize moving your sensor.

## Hide a Sensor

1. From the Home Screen, press on and hold a sensor icon until a small x appear in the upper left corner.
2. Tap on the x.
3. A message box will pop up informing you how to unhide your sensor. Tap **Yes** to finalize

hiding your sensor.

## Show a Sensor

1. Tap  on the Home screen.
2. Tap **Zones**.
3. Tap on the zone where the hidden sensor is.
4. Scroll down to find your hidden sensor and flip the switch on.
5. Tap **Done** to finalize showing your sensor.



# Symbio's Internal Sensors

---

Symbio is equipped with the sensors below.

- **Temperature sensor**

You can monitor the room temperature using the Toshiba Smart Home app.

- **Humidity sensor**

You can monitor the room humidity using the Toshiba Smart Home app.

- **Brightness sensor**

You can monitor the room brightness using the Toshiba Smart Home app.

- **Motion sensor**

The camera on Symbio detects motion within the camera's view. This detection window is adjustable through the Settings Manager.

- **Sound sensor**

Symbio will detect loud sounds. This detection level is adjustable through the Settings Manager.

# Sensors

---

The Symbio acts as a smart home hub and is compatible with standard ZigBee and Z-Wave products for the US market.

>

Tapping **Sensor** on the **Settings Manager** screen or on the Home Screen displays the **Sensors** screen below.

Sensors registered by default are shown on the screen. In addition, you can add/remove/delete/edit sensors. Up to 40 sensors can be registered in addition to the default internal sensors.

## Important

- Do not use sensors from countries other than from the US market.  
The sensor may not operate correctly if you use one from another country.



\* The screen appearance is subject to change without notice.

## Note

- Tap **Sort By Type** to sort sensors by type.
- Tap **Sort By Zone** to sort sensors by location.

Examples of available sensors are listed below. Visit <http://www.TSB-SmartHome.com> for the latest information.

- On/Off Switch  
You can turn on/off electric appliances such as a lamp.
- Dimmer Switch  
You can dim or brighten a room lamp, for example.
- Binary sensor  
You can see whether the door is open or closed, whether something moves within the camera range of Symbio, or whether there has been water leakage. In addition, this sensor

detects smoke or carbon monoxide (CO).

- Alarm

You can detect things such as motion or a water leak.

- Temperature/Humidity/Brightness Sensor

You can see the room temperature, humidity, or brightness.

- Power

You can see an estimation of power consumption.

- Door Lock

You can lock/unlock the door.

- Thermostat

You can change the room temperature.

## Adding a Sensor

Follow the steps below to add a sensor. Pairing a sensor allows Symbio absolute control of the device and its functionality. To see the values of a sensor or control a smart device one must first pair it to Symbio.

1. Tap **Sensors** on the Home screen.

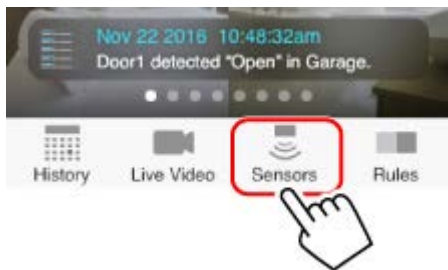

2. Tap **Add Sensor**.

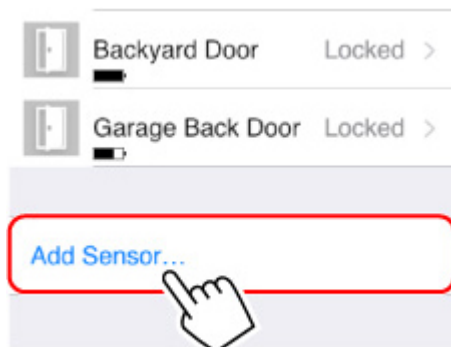

3. Tap **Add Sensor** on the displayed screen.



The app starts searching for a sensor and the screen below appears.

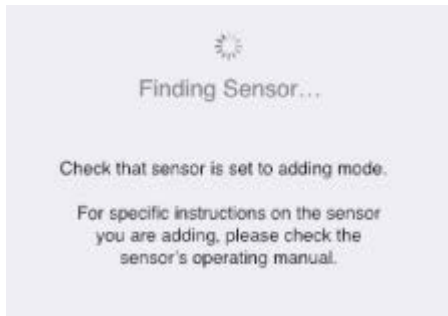

- Put the sensor in discovery mode (sometimes called "inclusion" mode). Refer to the sensor's instruction manual for details.

When the app finds a sensor, the screen below appears.

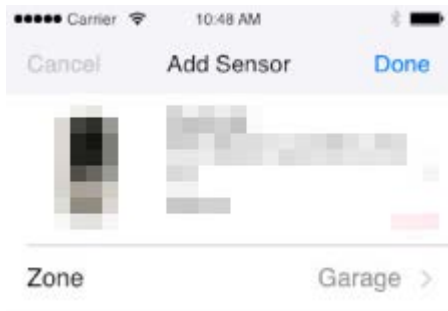

- Tap **Done**.

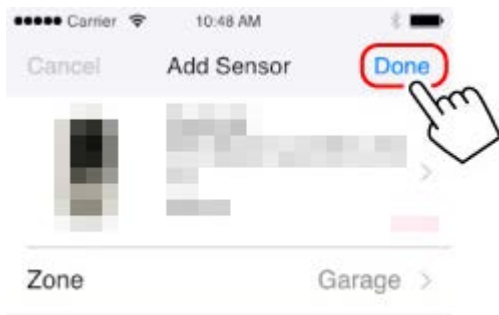

The sensor has been added to the app.

## Removing a Z-Wave sensor

Follow the steps below to remove a Z-Wave sensor. You can tell whether the device is a Z-Wave or ZigBee device from the manual it provides you.

This will unpair the device and any rules or settings associated with it.

1. Tap **Sensors** on the Home screen.

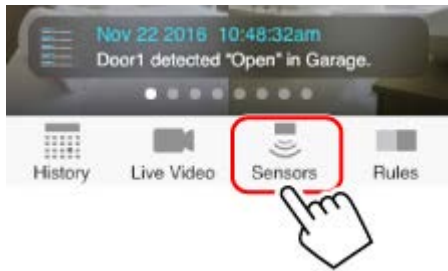

2. Tap **Add Sensor**.

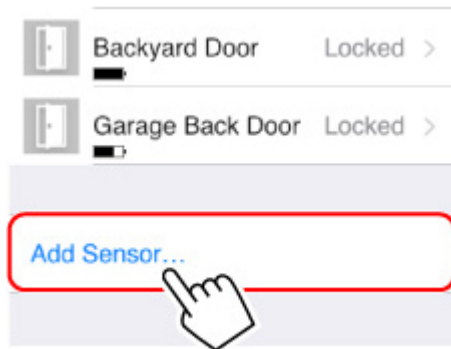

3. Tap **Remove Sensor** on the displayed screen.



The screen below appears and the app starts removing the sensor.



Put sensor in exclusion mode. Refer to the sensor's instruction manual for details.

4. Tap **OK** on the displayed screen.

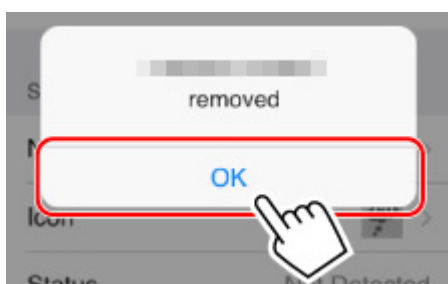

The sensor has been removed.

# Removing a Zigbee Sensor

Follow the steps below to delete a remove a ZigBee sensor. You can tell whether the device is a Z-Wave or ZigBee device from the manual it provides you. This will also work with Z-Wave devices.

This will unpair the device and any rules or settings associated with it.

1. Tap **Sensors** on the Home screen.

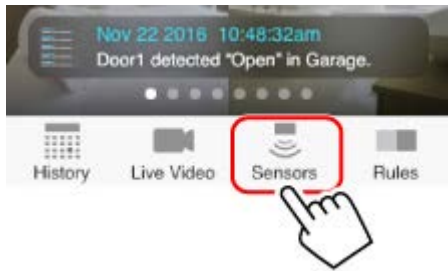

2. Tap a sensor you want to delete.



3. Tap **Edit** on the displayed screen.



4. Tap **Remove Sensor** on the displayed screen.

5. Tap **Remove Sensor** again on the popup.

The screen below appears and the app starts removing the sensor.



6. Tap **OK** on the displayed screen.

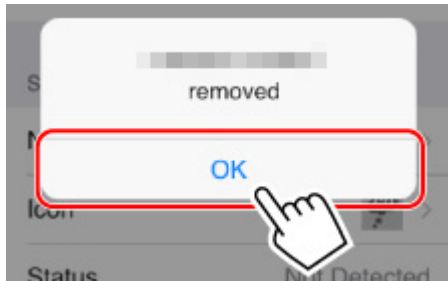

The sensor has been removed.

## Editing a Sensor

On the **Edit Sensor** screen, you can edit following items.

- Product name of the sensor
- Zone where the sensor is placed
- Name of each sensor class to control
- Design of icon to display on the Home screen

To display the **Edit Sensor** screen, tap a sensor icon you want to edit on the Home screen.



# Enjoying Audio on Symbio

---

Symbio can act as a Bluetooth speaker. You can easily connect your mobile device or computer and wirelessly play your music or podcast through Symbio.

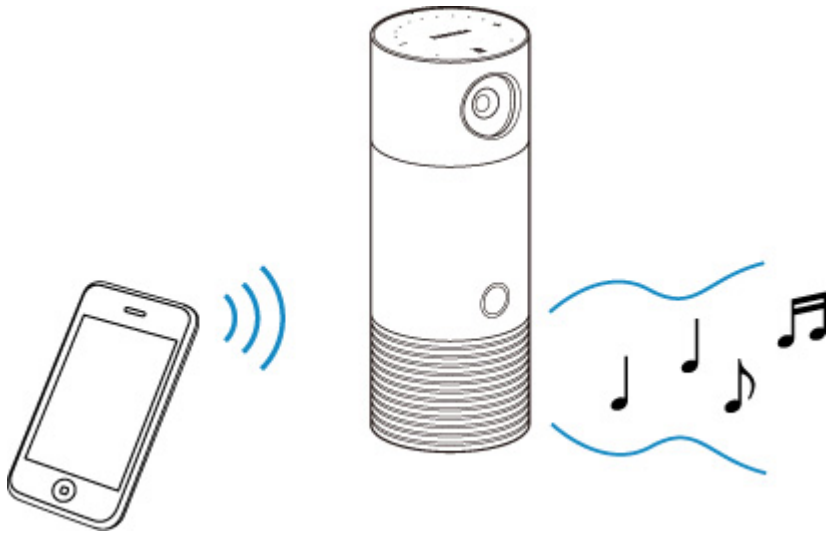

Follow the steps below to begin listening through Symbio.

1. Press the Network/Pairing button once to activate Bluetooth pairing mode on your Symbio. You can also activate the Bluetooth pairing mode remotely through the Audio section in the Settings Manager. See [Settings Manager](#) for more details.

The Light ring LED flashes rapidly blue.

2. Make sure Bluetooth is activated on the mobile device you wish to connect.
3. Open the Bluetooth menu on your mobile device.
4. Tap "THINGS\_XXXXXX" specified for your Symbio from the device list.

Your mobile device has been connected to Symbio.

5. Play an audio source on your mobile device.

## Important

- Be sure to decrease the volume both on your mobile device and Symbio before you start playing an audio source.

# Amazon Alexa

---

Symbio is Alexa-enabled, so you can ask Alexa to play music, hear the news, check weather, control smart home devices, and more.

If you did not sign into Amazon Alexa during Initial Setup, do so by going to **Settings Manager** and select **Amazon Alexa**.

⇒ [Symbio Setup](#)

To use Alexa on Symbio, simply say "Alexa", or press and hold the Microphone mute/Talk button for 2-3 seconds. When the light ring starts pulsing light blue, Symbio is ready for your command.

You can say things like "Alexa, what's the weather" or "Alexa, play some relaxing music". For more examples of things you can say, look for "Things To Try" on the Alexa app.

## Alexa Skills for Symbio

In order to use Alexa to control Symbio's functions or to control devices connected to Symbio's hub, you will need to link special "Alexa Skills", developed by Toshiba, to your Amazon account. To voice control 3rd party devices connected to Symbio's hub you will also need to perform "Alexa Device Discovery".

Setup for both of these steps will require use of the "Alexa" app in addition to the Symbio app. If you have not already installed the "Alexa" app, do so before proceeding. Toshiba has developed the following sets of Alexa Skills:

### Toshiba Smart Home Skills

These skills allow you to use your voice to control devices such as lights, switches, bulbs, door locks, and thermostats that are connected to Symbio's hub.

To link the skills:

1. Tap  on the Home screen.
2. Tap **Alexa Skills Setup**.

3. Either write down the "Skills Pairing Code" or tap the copy button to store it in your phone's memory.
4. Open **Alexa** app on your phone.
5. Open the **skills** section, search for **Toshiba Smart Home Skills**, and tap the icon.
6. On the Toshiba Skills page, tap **ENABLE**.
7. Enter or paste the pairing code you copied in step 3 into the box marked **authorization code** and tap **approve enabling the skill**.

The skill should now be linked. Now Alexa will need to learn about the devices you have connected in order to control with your voice. This can be done in 2 ways:

1. Go to your Symbio and say "Alexa, discover devices".
2. On the Alexa app, go into **Smart Home** , select **Devices**, and tap **Discover**.

Once you have linked skills and had Alexa discover devices, there are other useful things you can do on the Alexa app to improve your Symbio voice control experience. You can do things like change the names that you call devices and combine multiple devices into one group. See the Alexa app for details.

Depending on which devices you have connected to Symbio, you can now control with your voice by saying things like:

- "Alexa, turn on the lamp"
- "Alexa, set thermostat to 72"
- "Alexa, lock the back door"

## **Toshiba Custom Skills**

These skills allow you to use your voice to control Symbio's internal functions such as changing mode or to start camera recording.

To link the skills:

1. Tap  on the Home screen.
2. Tap **Alexa Skills Setup**.

3. Either write down the "Skills Pairing Code" or tap the copy button to store it in your phone's memory.
4. Open **Alexa** app on your phone.
5. Open the **skills** section, search for **Toshiba Custom Skills**, and tap the icon.
6. On the Toshiba Skills page, tap **ENABLE**.
7. Enter or paste the pairing code you copied in step 3 into the box marked **authorization code** and tap **approve enabling the skill**.

With Toshiba Custom Skills, the command structure is a bit different. With the Toshiba Custom Home Skills linked, you can now use your voice to do things like:

- Change modes - "Alexa, tell Toshiba to set 'Away' mode"
- Control the camera - "Alexa, ask Toshiba to start recording"
- Get status of internal sensors - "Alexa, ask Toshiba what is the current temperature"
- Control security – "Alexa, tell Toshiba to sound the siren"

# Troubleshooting

---

Problems with Pairing

No Sound

Cannot View Image from Live Video

Amazon Alexa Does Not Function Properly

More Help

# Problems with Pairing

---

**Check1**

Make sure Symbio is plugged in.

**Check2**

Make sure Symbio is in pairing mode.

**Check3**

Place Symbio near your wireless router or wireless bridge.

**Check4**

Make sure your smartphone's battery is sufficiently charged.

# No Sound

---

**Check1**

Make sure Symbio is plugged in.

**Check2**

Make sure Bluetooth or Wi-Fi is activated on your smartphone.

**Check3**

Check the pairing status between Symbio and your smartphone.

**Check4**

Check the volume level of Symbio and the application on your smartphone.

# Cannot View Image from Live Video

---

**Check1**

Make sure Symbio is plugged in.

**Check2**

Make sure Symbio's lens cover is fully open.

**Check3**

Make sure Wi-Fi is activated on your smartphone.

**Check4**

Check the connection between Symbio and the app.



# Amazon Alexa Does Not Function Properly

---

**Check1**

Make sure Symbio is plugged in.

**Check2**

Make sure Wi-Fi connection is working properly.

**Check3**

Check the connection between Symbio and the app.

**Check4**

Make sure Alexa Voice Service (AVS) is activated.

**Check5**

Try talking to Symbio or the app more slowly or clearly, or press and hold the Mute button on Symbio and then talk.

**Check6**

Make sure the Microphone mute button is not enabled.

# Specifications

## General Specifications

<b>Operation button</b>	<p>Volume up/down button (top)</p> <p>Microphone mute button (top)</p> <p>Network/Pairing button (back)</p> <p>Reset button (bottom)</p> <p>⇒ <a href="#">Part Names</a></p>
<b>Indicator</b>	<p>Volume indicator (9 white LEDs at the top)</p> <p>Microphone mute indicator (2 red LEDs at the top)</p> <p>Mode indicator (7 color LEDs at the front)</p> <p>Camera indicator (Red LED at the front)</p> <p>⇒ <a href="#">Part Names</a></p>
<b>Built-in microphone</b>	<p>Equipped with two microphone holes at the top.</p> <p>Compatible with echo cancellation, beamforming, and sound detection.</p>
<b>Built-in camera</b>	<p>Maximum resolution: 1080 p</p> <p>Imaging range: 114° (horizontal), 78° (vertical), 135° (diagonal)</p> <p>Motion sensor: Available when used with Toshiba Smart Home app.</p> <p>Compatible with automatic night vision.</p> <p>Equipped with infrared LED and rotating camera cover.</p>
<b>Built-in sensor</b>	<p>Temperature sensor (Range: 32 to 104 °F (0 to 40 °C))</p> <p>Humidity sensor (Range: 10 % to 90 %)</p> <p>Brightness sensor (Range: 0 lux to 3,000 lux)</p>
<b>Built-in speaker</b>	<p>5 W (5 Ω) x 1 ONKYO system speaker</p> <p>Equipped with enclosure.</p> <p>Sound output similar to a siren.</p>

<b>Terminals</b>	DC input jack x 1 USB 2.0 terminal (Type-A) x 1
<b>Power consumption</b>	8.5 W (on standby) 30 W (when Wi-Fi, Live video, IR, USB connection, and Siren functions are enabled)
<b>Operating environment</b>	Temperature: 32 to 104 °F (0 to 40 °C) Humidity: 10 to 90 %
<b>External dimensions</b>	Approx. 3.46 (W) x 3.46 (D) x 8.66 (H) inches (Approx. 88 (W) x 88 (D) x 220 (H) mm)
<b>Weight</b>	1.46 lb (660 g)
<b>AC adapter (supplied)</b>	Input: AC 100-240 V Output: DC 12 V, 3A Cable length: 70.9 inches (1,800 mm) Wall Mount Type

## Network Interface

<b>Wireless LAN</b>	IEEE802.11a/b/g/n/ac 2x2
<b>Bluetooth</b>	Bluetooth 3.0
<b>Z-Wave controller</b>	US: 908.42 MHz
<b>ZigBee controller</b>	2.4 GHz

Specifications and appearance are subject to change without notice.