



Operating Manual
GT110D / GTV110D / GT211D
Non-programmable Thermostats



69-2106ES

This manual covers the following models:

GT110D: for 1-Heat / 1-Cool systems

GTV110D: for 1-Heat / 1-Cool systems

GT211D: for 2-Heat / 1-Cool heat pump systems

(Remove thermostat from wallplate and turn over to find model number.)



CAUTION: EQUIPMENT DAMAGE HAZARD.

To prevent possible compressor damage, do not use Cooling mode when the outdoor temperature is below 50 °F (10 °C).

Read and save these instructions.

Table of contents

Overview

Controls	1
Display.....	2

Operation

System switch	3
Fan switch	4
Temperature adjustment buttons	5

Appendices

Battery replacement	6
In case of difficulty	7
Customer assistance	9

Controls

Screen (see page 2)
Illuminates for 12 seconds
when you press any button.

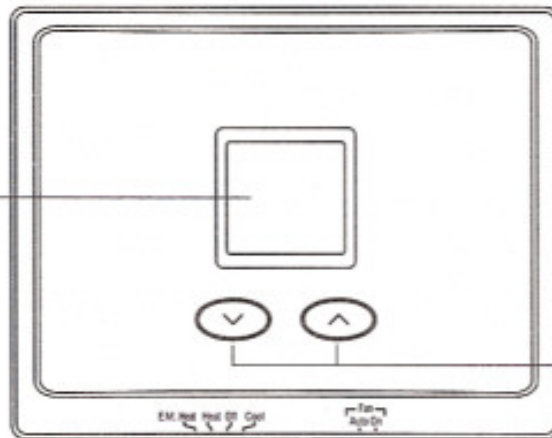

**Temperature
Adjustment Buttons**
(see page 5)

System Switch (see page 3)

Fan Switch (see page 4)

Display

Setpoint indicator

Appears when the setpoint temperature is displayed.

Low-battery warning (see page 6)

System Status

- **Cool On:** Cooling is activated. *
- **Heat On:** Heating is activated. *
- **Aux On:** Auxiliary heat is activated. **

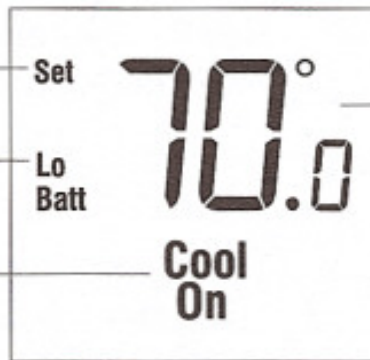

Temperature display

The ambient (measured) temperature is normally displayed. To view the setpoint temperature, press either of the temperature adjustment buttons once. The setpoint temperature will appear for five seconds.

* If **Heat On** or **Cool On** is flashing, compressor protection is enabled. Your thermostat has a feature that helps prevent damage to the compressor of your air conditioning or heat pump system. Because damage can occur if the compressor is restarted too soon after shutdown, this feature forces the compressor to wait 5 minutes before restarting. During the wait time, the message **Heat On** (in heat pump applications only) or **Cool On** flashes on the screen. When the safe wait time has elapsed, the message stops flashing and the compressor starts.

** Applies to GT211D model only.

System switch

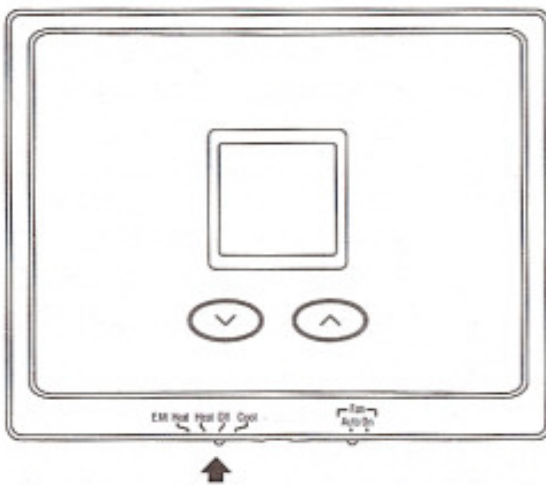

Use the **System** switch to place the system in one of the following modes.

- **Cool:** System is in Cooling mode.
- **Off:** System is off.
- **Heat:** System is in Heating mode.
- **Em Heat:** System is in Emergency Heat mode. Only auxiliary heating can be activated. The compressor is disabled. This mode is available on GT211D model only.



CAUTION: EQUIPMENT DAMAGE HAZARD

Do not use Cooling mode when the outdoor temperature is below 50 °F (10 °C).

Fan switch

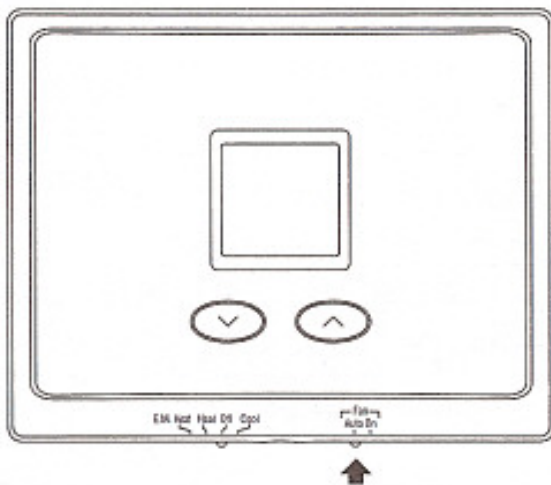

Use the **Fan** switch to select the fan operation.

- **Auto:** The fan runs only when heating or cooling is taking place.*
- **On:** The fan runs continuously. Use this setting for improved air circulation or for more efficient air cleaning.

* In a gas or oil heating system, in heating mode, the fan will run only when the air that will be coming out of the vents is sufficiently warm. Thus, when there is a call for heat, there might be a delay before the fan starts.

Temperature adjustment buttons

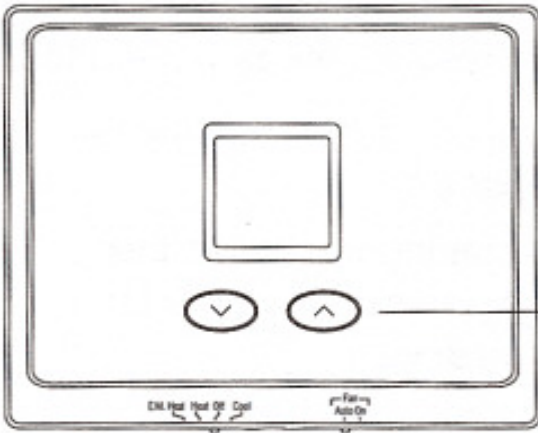

Press the \wedge or ∇ button once to display the setpoint temperature. The setpoint temperature will be displayed for 5 seconds. Press either button while the setpoint is displayed to change the setpoint.

Battery replacement

NOTE: Batteries are NOT needed if your thermostat is connected to 24 VAC.



Set the **System** switch to **Off** before removing the batteries. Otherwise, the heating/cooling system could remain activated even when batteries are removed.

Install two fresh AAA batteries when the low-battery icon flashes on the screen. If the batteries are not replaced within 60 days, the thermostat disables the system operation and displays only the low-battery icon. Replace batteries once a year, or when you will be away for more than a month.

The settings are stored in non-volatile (permanent) memory and are thus preserved when the thermostat is without AC power or batteries.

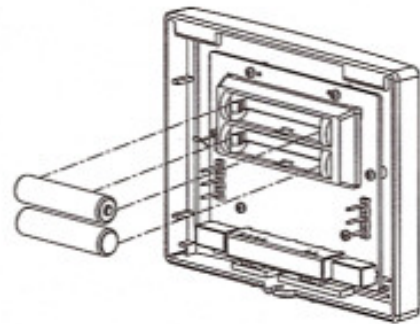

In case of difficulty

- | | |
|--|---|
| <p>Screen is blank.</p> | <ul style="list-style-type: none">• Check circuit breaker and reset if necessary.• Ensure the heating/cooling system is powered up.• Ensure the furnace door is properly closed.• Ensure two fresh AAA alkaline batteries are correctly installed. |
| <p>Cool On or Heat On is flashing.</p> | <ul style="list-style-type: none">• Wait for the compressor to start (maximum of 5 minutes). This delay protects the compressor from damage. |
| <p>HI appears on the screen.</p> | <ul style="list-style-type: none">• The thermostat has disabled the system operation because the ambient (measured) temperature is above 122 °F (50 °C). |
| <p>LO appears on the screen.</p> | <ul style="list-style-type: none">• The thermostat has disabled the system operation because the ambient (measured) temperature is below 32 °F (0 °C). |

- E1** appears on the screen.
- The thermostat has disabled the system operation because the temperature sensor circuit is opened. Replace the thermostat.
- E2** appears on the screen.
- The thermostat has disabled the system operation because the temperature sensor circuit is shorted. Replace the thermostat.
- Temperature settings cannot be changed.
- The **System** switch is off.
 - You are setting the temperatures outside their allowable ranges:
 - Heat: 40 °F to 90 °F (4.5 °C to 32 °C)
 - Cool: 50 °F to 99 °F (10 °C to 37 °C)
- The thermostat is displaying 99 °F (37 °C) when the ambient temperature is above that value.
- The thermostat can display up to 99 °F (37 °C) but it can control the temperature up to 122 °F (50 °C).

Customer assistance

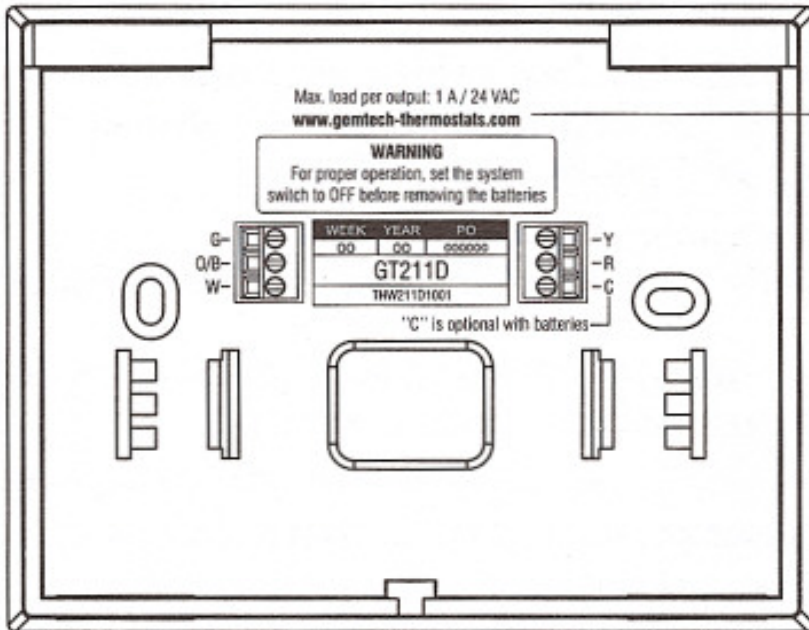

For assistance with this product,
visit our website:
www.gemtech-thermostats.com