

DRAFT OF ADMINISTRATION MANUAL

DRAFT COPY
NOMAD MXU Administration Manual

3:33 PM 02/12/99

NOMAD MXU Configuration Manager (MCM) Software License Agreement (on the CDs)

NOMAD MXU Application Software License Agreement

Technical Support Numbers

DRAFT COPY

DRAFT COPY

NOMAD MXU Administration Manual

3:33 PM 02/12/99

<u>Version</u>	<u>Date</u>	<u>Name</u>	<u>Reason</u>	
Version	Date	name	Reason	Change

DRAFT COPY

DRAFT COPY

NOMAD MXU Administration Manual

3:33 PM 02/12/99

1.

TABLE OF CONTENTS

1	INTRODUCTION.....	7
1.1	Purpose.....	7
1.2	Acronyms and Definitions	7
1.3	Safety	7
2	NOMAD SYSTEM OVERVIEW	9
2.1	System Description	9
2.2	NOMAD MXU Configuration Manager (MCM)	10
2.2.1	MCM Overview	10
2.2.2	MCM Features	11
2.2.2.1	Main Screen	11
2.2.2.2	Date Fields	11
2.2.2.3	NOMAD MXU Location Information	12
2.2.2.4	NOMAD MXU Connection Data	12
2.2.2.5	Nomad Airtime Recharge	13
2.2.2.6	Security Configuration	14
2.2.2.7	Define Groups	15
2.2.2.8	Selecting a Group to Display	16
2.2.2.9	Add NOMAD ISU Button	16
2.2.2.10	NOMAD ISU Display Window	17
2.2.2.11	Changing Entries.....	17
2.2.2.12	Menu Bar	18
2.2.2.12.1	File Menu.....	18
2.2.2.12.2	Connect Menu.....	19
2.2.2.12.3	Diagnostics Menu	19
2.2.2.12.4	Security Menu.....	20
2.2.2.12.5	Support Menu	21
2.2.2.13	Display / File Options	21
2.3	NOMAD Console	21
2.3.1	Front Panel	22
2.3.2	Back Panel	23
3	INSTALLATION.....	25
3.1	Overview.....	25
3.2	Install NOMAD MXU Console	26
3.3	Install Admin and Monitors PCs.....	26
3.3.1	PC Configuration	26
3.3.2	Windows NT	26
3.3.3	Remote Access Services	26
3.4	Install MCM Program	27
3.4.1	Install Program.....	27
3.4.2	Execute MCM Program	27
4	INITIALIZATION and OPERATION.....	27
4.1	Creating a New NOMAD MXU Configuration.....	27
4.1.1	Get Required Information	27
4.1.2	MCM New Configuration Screen	28
4.1.3	Enter Connection Data	28
4.1.4	Enter Security Data	29
4.1.5	Configure Pooled Time Groups	29
4.1.6	Enter MSISDNs	29
4.1.7	Set Nomad Airtime Recharge	29
4.1.8	Allocate Airtime.....	29
4.1.9	Save the Configuration Document	30
4.1.10	First NOMAD MXU Communication (Initialization)	30

DRAFT COPY

DRAFT COPY

NOMAD MXU Administration Manual

3:33 PM 02/12/99

4.1.11	Country Code Setting.....	30
4.2	Administration Issues.....	30
4.2.1	Operator Security.....	31
4.2.2	Air Time Recharge Control.....	31
4.2.3	Maintaining Consistency with the NOMAD MXU.....	31
4.2.4	Creating a Field Unit.....	31
4.3	Files and Directories.....	31
5	TROUBLE SHOOTING GUIDELINES	32
5.1	Troubleshooting VS. Security.....	32
5.2	How TO Retrieving NOMAD MXU Diagnostics Files.....	32
5.3	Initialization.....	32
5.4	NOMAD MXU Operation Problems.....	33
5.5	Administrative Station Problems.....	33
5.6	Monitor Station Problems.....	33
5.7	NOMAD MXU System Problems.....	34
	APPENDIX "A" - Null Modem Cable	37
	APPENDIX "B" - Example Create Text File	37
	APPENDIX "C" - Specifications.....	84
	APPENDIX "D" - Warranty.....	86

DRAFT COPY

DRAFT COPY

NOMAD MXU Administration Manual

3:33 PM 02/12/99

TABLE OF FIGURES

Figure 2.1-1: NOMAD System.....	9
Figure 2.2.2.1-1: MCM Main Screen.....	11
Figure 2.2.2.3-1: NOMAD MXU Location Information	12
Figure 2.2.2.4-1: NOMAD MXU Connection Data Fields.....	12
Figure 2.2.2.5-1: Nomad Airtime Recharge Fields.....	13
Figure 2.2.2.6-1: Security Configuration Fields	14
Figure 2.2.2.7-1: Pooled Airtime Group Fields	15
Figure 2.2.2.8-1: Group Selection for Display.....	16
Figure 2.2.2.9-1: New NOMAD ISU Data Fields.....	16
Figure 2.2.2.10-1: NOMAD ISU Display Window	17
Figure 2.2.2.11-1: Change Entry Fields.....	18
Figure 2.2.2.12.1-1: File Menu	18
Figure 2.2.2.12.2-1: Connect Menu	19
Figure 2.2.2.12.3-1: Diagnostics Menu.....	19
Figure 2.2.2.12.3-2: LBT Update Selection.....	20
Figure 2.2.2.12.4-1: Security Menu	20
Figure 2.2.2.12.5-1: Support Menu.....	21
Figure 2.2.2.13-1: Group to Display	21
Figure 3.2-1: NOMAD Console.....	22
Figure 3.2.1-1: NOMAD Front Panel.....	22
Figure 3.3.2-1: Nomad Back Panel.....	23
Figure 3.1-1: Installation Overview	25
Figure 4.1.2-1: New MCM Screen.....	28

DRAFT COPY

1 INTRODUCTION

1.1 Purpose

This administration manual has been written for the following purposes:

1. Administration of the NOMAD MXU from a remote location over PSTN telephone lines.
2. Administration of the NOMAD MXU from a local location over the RS232 port.
3. Monitoring only of the NOMAD MXU from a remote location over PSTN telephone lines.
4. Monitoring only of the NOMAD MXU from a local location over the RS232 port.

1.2 Acronyms and Definitions

NOMAD System	
NOMAD MXU	
MXU	
NOMAD ISU	
ISU	
PC	Personal Computer
CDR	Call Detail Record
CD ROM	Compact Disk Read Only Memory
CFB	Call Forward on subscriber Busy
DTMF	Dual tone Multi-Frequency
ISU	Iridium Subscriber Unit
LBT	L Band Transceiver
LEO	Low Earth Orbit
ISDM	Integrated Service Digital network
MCM	MXU Configuration Management
MSISDN	Mobile Service Integrated Service Digital Network
MXU	MultiExchange Unit
PBX	Public Branch Exchange
PC	Personal Computer
PSTN	Public Switched Telephone Network
SIM	Subscriber Identity Module

1.3 Safety

The NOMAD MXU has been designed and tested to comply with UL 1950, EN 60950 and IEC 950 safety standards. These standards are accepted in most of the industrialized world and are considered defacto standards worldwide.

Warnings, cautions, and notes listed below are used in various sections of the Installation and Administration Manuals.

WARNING IMPROPER GROUNDING HAZARD
--

High voltage is produced by commercial power access points and generator sets. Never attempt to connect to commercial power or start a generator set if it is not properly grounded. Failure to observe this warning can result in serious injury or death by electrocution.

WARNING
HIGH VOLTAGE HAZARD

This equipment contains lethal voltages. Remove power from equipment before handling. Failure to observe this warning can result in serious injury or death.

CAUTION

CAUTION

Antenna Radiation Emission

As a precaution, maintain a minimum distance of 30 centimeters (12 inches) from the antenna array while in operation.

CAUTION
LITHIUM BATTERY

Danger of explosion if battery is incorrectly replaced.
Replace only with the same or equivalent type recommended by the manufacturer.
Dispose of used batteries according to the manufacturer's instructions

2 NOMAD SYSTEM OVERVIEW

2.1 System Description

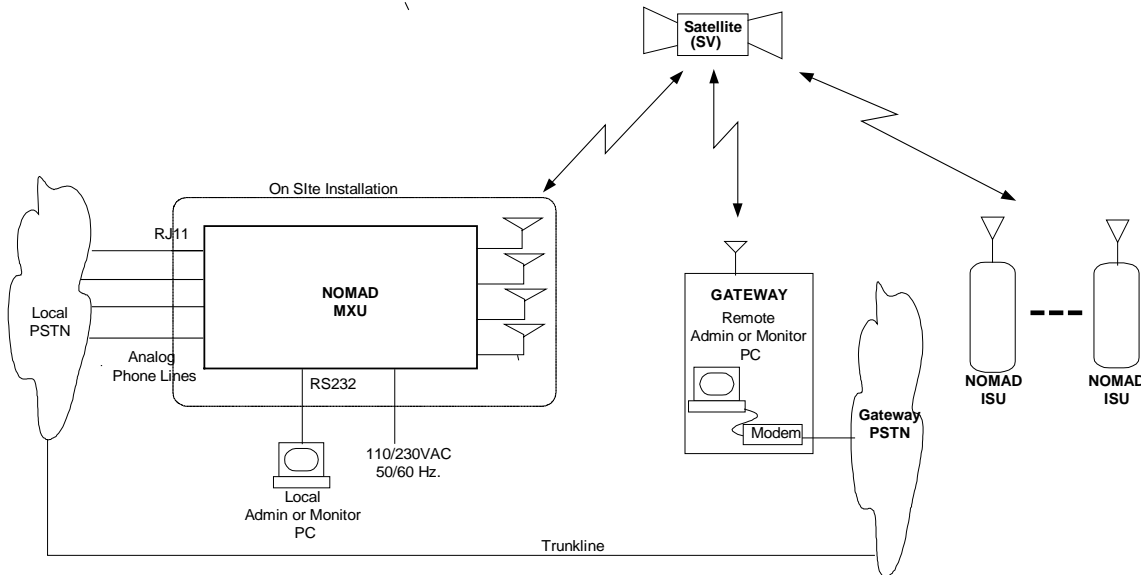

Figure 2.1-1: NOMAD System

NOMAD System

The NOMAD System consists of the following major subassemblies:

- a. Local Public Telephone Switched Network (PSTN):
- b. NOMAD Multi-Channel Unit (NOMAD MXU):
- c. Optional Control PC: Allows monitoring of the NOMAD system if desired.
- d. Constellation of LEO Satellites:
- e. Gateway: Controls the Iridium network and the NOMAD System.
- f. NOMAD Control PC: Used by the Gateway to control the NOMAD MXU unit.
- g. Gateway PSTN: Public Switched telephone network attached to the Gateway
- h. Trunk Line: The communications path between the local PSTN and the Gateway PSTN. This path is used by the Gateway Control PC to initialize and control the NOMAD MXU.
- i. Iridium Subscriber Units (NOMAD ISU): Iridium portable handsets/telephones.

The equipment supplied to the user's site consists of the NOMAD MXU, antenna, mast, wiring and documentation as indicated by the rectangle in FIGURE 2.1-1. Once the NOMAD MXU is installed per the instructions in the Administrative and Installation Manuals, the NOMAD system will enable NOMAD ISU calls (from anywhere within a region defined by the Gateway) to be connected to the local PSTN.

The NOMAD system will provide up to four channels of Iridium based global voice communication services from a NOMAD ISU to a local PSTN via the NOMAD MXU. The NOMAD MXU attaches to the local PSTN using four standard, two-wire, analog phone lines and appears as four additional telephones to the PSTN. The NOMAD MXU connects to the Iridium Constellation via four L-Band Transceivers (LBT)

DRAFT COPY

NOMAD MXU Administration Manual

3:33 PM 02/12/99

located inside the NOMAD MXU. Phones attached to the local PSTN will be able to receive NOMAD ISU calls via the NOMAD MXU and IRIDIUM global system.

A call placed from a NOMAD ISU to a person on the local PSTN will require the dual dialing procedure illustrated in the following steps:

- a. The NOMAD ISU caller will dial the Iridium phone number of the NOMAD MXU's channel one LBT.
- b. When answered by the NOMAD MXU, a tone will indicate to the NOMAD ISU user that he is required to enter his account number.
- c. The account number is then entered by the NOMAD ISU caller.
- d. The NOMAD MXU will check the account number to insure the caller is allowed on the NOMAD system. If the caller is a valid user, the NOMAD MXU will connect the caller to the local PSTN and the caller will hear a 2nd dial tone.
- e. The NOMAD ISU caller will then dial the PSTN destination number.
- f. The dialed number will be passed through the IRIDIUM constellation, NOMAD MXU and then to the local PSTN. The PSTN will ring the destination phone and the call will be completed when the called party answers.

2.2 NOMAD MXU Configuration Manager (MCM)

2.2.1 MCM Overview

This section describes the NOMAD MXU Configuration Manager (MCM) software package for the Iridium Nomad program.

The NOMAD MXU devices are configured and monitored by the NOMAD MXU Configuration Manager (MCM) program. The NOMAD MCM is installed on a PC at an Iridium Gateway site and connects to the NOMAD MXUs over a modem/phone line connection. It is also possible to directly connect an NOMAD MXU and a PC running the MCM program by using a null modem cable between serial ports on each machine. One MCM installation can control a large number of NOMAD MXUs. Each NOMAD MXU configuration is stored in a file with the extension *.mxu*.

Each Nomad phone is assigned both a standard Iridium phone number (called an MSISDN) and a unique seven digit account number. The account number is for keeping track of airtime for each NOMAD ISU. The account number is created for each MSISDN by the MCM software. The account is then either programmed into the SIM card of the phone or entered into the phone's re-dial memory. This account must be entered after the Iridium phone user dials and connects to the NOMAD MXU.

The NOMAD MCM software is installed on a PC running Microsoft NT 4.0. It presents an interface that the administrator can use to communicate with the NOMAD MXU for the purpose of enabling service, monitoring airtime usage and allocating airtime for individual or pooled groups of phones. It also allows the administrator to retrieve and view airtime usage logs and diagnostic reports.

The software is released in three versions:

- The Administration version described in this document (MCM_Admin.exe).
- A Monitor or "read only" version which is a subset of the Administration version (MCM_Monitor.exe)
- A Support version, which contains extra functions, used to diagnose or recover from error situations (MCM_Support.exe).

DRAFT COPY

DRAFT COPY

NOMAD MXU Administration Manual

3:33 PM 02/12/99

Typically, the Gateway Nomad administrator uses the Administration version of the MCM to configure and control the NOMAD MXUs. A Monitor version of the MCM may be installed at each NOMAD MXU site to allow the Nomad program participants to view airtime usage and system logs, etc. It is possible to use the administration and monitor versions of the MCM software at either location; however, **read the cautions** in the trouble shooting section (5.0) before trying to do so.

Nomad program support personnel use the Support version of the MCM

2.2.2 MCM Features

2.2.2.1 Main Screen

Figure 2.2.2.1-1 is an example of a small NOMAD MXU configuration. It has been saved with the filename Phoenix.mxu. The next sections will describe the fields and menus, and their functions.

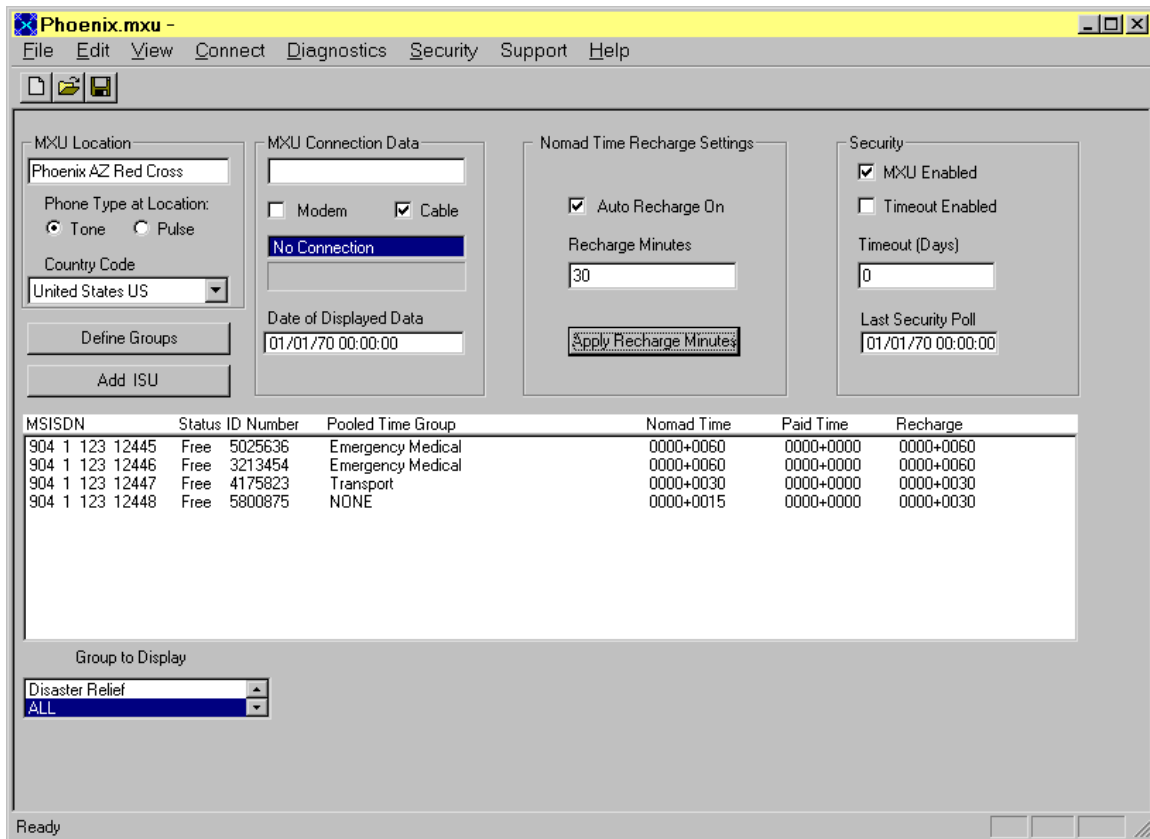

Figure 2.2.2.1-1: MCM Main Screen

2.2.2.2 Date Fields

The date fields are for display only and cannot be edited by the user. All dates are displayed in Universal Coordinated (GMT) time.

The **Date of Displayed Data** field is valid only after the first successful configuration update. Until then it will display the NT system "zero" time: Midnight, Jan. 1, 1970. The **Last Security Poll** field will also show this date until a successful contact is made with the administered NOMAD MXU.

DRAFT COPY

The **Date of Displayed Data** is set when a connection to upload or download configuration data to/from the NOMAD MXU completes successfully. It is the date when the MCM and the NOMAD MXU were last in agreement on the Nomad and Paid airtime values shown in the configuration.

The **Last Security Poll** field is set whenever the MCM and the NOMAD MXU make contact. If the security timeout were enabled for 5 days, then the NOMAD MXU would shut down 5 days from the date shown in this field.

2.2.2.3 NOMAD MXU Location Information



The screenshot shows a dialog box titled "MXU Location". It contains a text input field with the value "Phoenix AZ Red Cross". Below this is a section labeled "Phone Type at Location:" with two radio buttons: "Tone" (which is selected) and "Pulse". At the bottom, there is a "Country Code" section with a dropdown menu currently showing "United States US".

Figure 2.2.2.3-1: NOMAD MXU Location Information

The NOMAD MXU location field, figure 2.2.2.3-1, is a text description of the NOMAD MXU site, intended to identify the site in printed reports. It will be included in the header information when the configuration is printed. The administrator can edit this field to be whatever is wanted.

The Pulse/Tone selection buttons describe the local phone system to which the NOMAD MXU is attached. As shown in the above illustration, the phones attached to the NOMAD MXU for the Phoenix Red Cross uses TONE dialing.

The Country Code is a drop-down selection box containing phone system configuration selections based on the installation country for the NOMAD MXU.

2.2.2.4 NOMAD MXU Connection Data

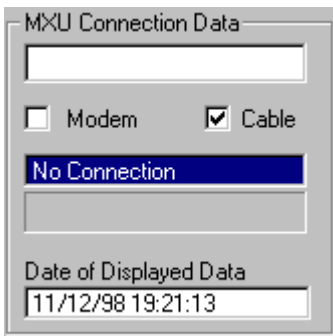

The screenshot shows a dialog box titled "MXU Connection Data". It features a text input field at the top which is currently empty. Below it are two checkboxes: "Modem" (unchecked) and "Cable" (checked). Underneath the checkboxes is a dropdown menu with "No Connection" selected. At the bottom, there is a "Date of Displayed Data" section with a text input field containing the value "11/12/98 19:21:13".

Figure 2.2.2.4-1: NOMAD MXU Connection Data Fields

DRAFT COPY

NOMAD MXU Administration Manual

3:33 PM 02/12/99

The upper text entry field must contain the entire phone digit text string required to dial up the remote site, including digits to get an outside line, country code, prefix, etc. This field is ignored when a direct connection is configured. Here is an example of a typical dial string:

9, 1 602 441 7705 (Note, spacing is not required)

9 **allow the modem to connect to an outside line**
, causes the modem to pause to allow the outside line to connect

1 long distance prefix
602 area code
441 7705 number in area

The **Modem** or **Cable** selection tells the program what RAS device to use to make the connection; either use the dial-up number over a modem, or use a serial cable connecting the two machines. Clicking in either box will cause the program to attempt to find the correct driver for the selection, configure the connection, and then save the configuration data. This procedure will fail if the selected connection type does not find a RAS –capable device (modem or serial driver). When RAS is configured, one or both types of devices must be added – refer to Microsoft documentation.

If the current configuration file has not yet been saved (If it is named Untitled) then you will be prompted to supply a name for the new configuration file.

Directly below the Modem/Cable selection boxes are two display fields. The upper display field contains a text status field that shows the current connection state: **Connected**, **NoConnection**, **Connecting...**, **Updating Software**. The lower display field is a "thermometer" type gauge that will show progress in setting up a connection or large file transfer.

2.2.2.5 Nomad Airtime Recharge

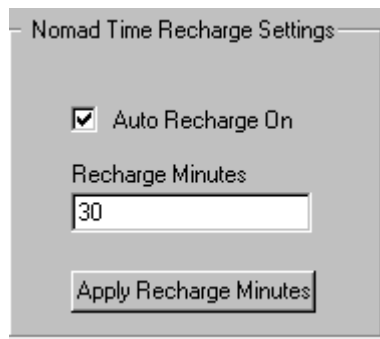

Figure 2.2.2.5-1: Nomad Airtime Recharge Fields

The **Nomad** Program is designed to allow each Iridium account that is configured on an NOMAD MXU to receive an allotment of airtime at the beginning of each month. This is “automatic recharge.” The automatic recharge may be turned on or off for a given NOMAD MXU by setting or clearing **Auto Recharge On**. The number of minutes allotted for each account associated with the NOMAD MXU is entered into the **Recharge Minutes** field. When the **Apply Recharge Minutes** field is clicked, each phone account is configured with that amount of recharge time. Then, at the start of the next calendar month, the recharge time is converted to usable Iridium Nomad Airtime. Pooled airtime groups will be allocated the number of minutes in the **Recharge Minutes** field times the number of phones in the group.

2.2.2.6 Security Configuration

Security

MXU Enabled

Timeout Enabled

Timeout (Days)

9

Last Security Poll

11/12/98 19:21:13

Figure 2.2.2.6-1: Security Configuration Fields

The Security functions allow the administrator to enable or disable the NOMAD MXU. If disabled (box not checked), the NOMAD MXU will ignore all Iridium call attempts except a call from the NOMAD MXU Configuration Manager program. The administrator can set a timeout feature that causes the NOMAD MXU to disable itself if the administrator (using the MCM program) does not contact it within the specified number of days. Whenever the MCM program successfully contacts the NOMAD MXU, the **Last Security Poll** field will be set to the current UCT (Universal Coordinated Time). This "resets the clock" and the timeout period will begin counting again.

2.2.2.7 Define Groups

The **Define Groups** button brings up a dialog box that allows the administrator to create and name groups of Iridium phones. Group member phones will share the airtime that is allotted to them. For example, if each phone in a group account is allotted 30 minutes, and there are 5 phones in the group, than each phone in the group can call on a pool of 150 minutes of shared time.

The screenshot shows a dialog box titled "Define ISU Groups". It has three text input fields for group names. The first field is labeled "First Group Name" and contains the text "Emergency Medical". To its right is a checked checkbox labeled "Group Enabled". The second field is labeled "Second Group Name" and contains the text "Disaster Relief". To its right is a checked checkbox labeled "Group Enabled". The third field is labeled "Third Group Name" and is empty. To its right is an unchecked checkbox labeled "Group Enabled". At the bottom of the dialog are two buttons: "APPLY" on the left and "Cancel" on the right.

Figure 2.2.2.7-1: Pooled Airtime Group Fields

A group is created by typing in a name, checking the **Group Enabled** box and exiting the dialog by clicking on the **APPLY** button

After a group is created, Iridium Subscriber Units (NOMAD ISUs) may be assigned to it when they are configured with the **Add NOMAD ISU** button.

A group is deleted by clearing the **Group Enabled** box and clicking the **APPLY** button. All current member NOMAD ISUs will be removed from the group, and will no longer share air times. Each NOMAD ISU will show "**NONE**" as its group in the main display window and its airtime fields will be zero.

A group is renamed by simply typing a new name and leaving the "Group Enabled" box checked.

To exit the dialog without applying the changes, use the "Cancel" button.

2.2.2.8 Selecting a Group to Display

The scroll box below the **NOMAD ISU Display Window** (figure 9) selects a group to be displayed in the window. The user can select a group, or select "NONE" to show phones which are not assigned to any group, or select "ALL" to show all phones at the NOMAD MXU site, whether they are group members or not.



Figure 2.2.2.8-1: Group Selection for Display

The group selection also applies to the text file report that is created by clicking on the "File" menu and selecting **Create Text File**. In other words, the NOMAD ISU entries currently shown in the NOMAD ISU Display window are the same ones that will be included in the text file when the **Create Text File** menu command is used.

2.2.2.9 Add NOMAD ISU Button

Clicking the button creates the following dialog:

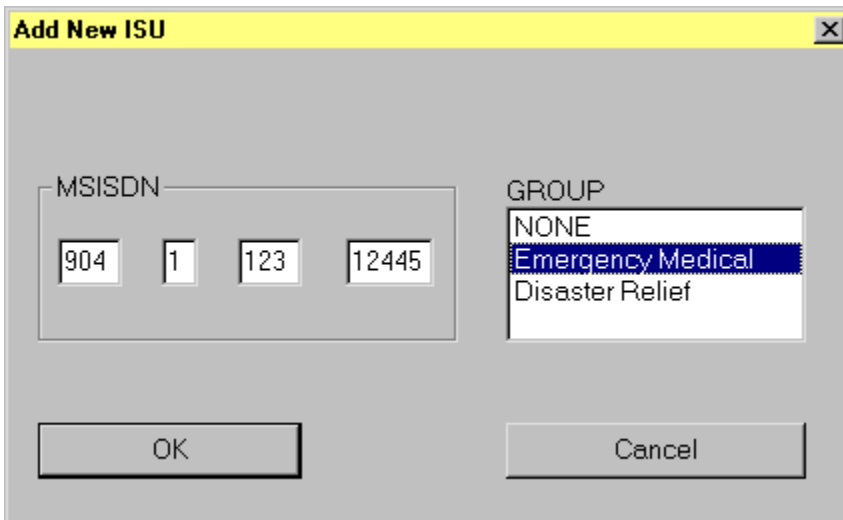

Figure 2.2.2.9-1: New NOMAD ISU Data Fields

This dialog accepts the Iridium phone numbers (MSISDN) and allows the creator to assign the phone to a group for pooled time-sharing. If the phone is not a group member, select NONE. When OK is clicked, the new entry is added to the scroll box display and assigned a unique ID Number that will be used by the phone to access the NOMAD MXU. This ID number can be programmed into the SIMS used in the Iridium Phones (called NOMAD ISUs, or Iridium Subscriber Units), or the ID number may be given to the Iridium phone end-user to enter after connecting to the NOMAD MXU. The number is used by the Nomad program to charge airtime.

2.2.2.10 NOMAD ISU Display Window

MSISDN	Status	ID Number	Pooled Time Group	Nomad Time	Paid Time	Recharge
907 1 123 44441	Free	3128646	Emergency Medical	0000+0080	0000+0000	0000+0120
907 1 123 44442	Free	8599206	Emergency Medical	0000+0080	0000+0000	0000+0120
907 1 123 44443	Free	2205128	Emergency Medical	0000+0080	0000+0000	0000+0120
907 1 123 44444	Free	6377958	Emergency Medical	0000+0080	0000+0000	0000+0120
907 1 123 44445	Free	5983705	Disaster Relief	0000+0000	0000+0000	0000+0180
907 1 123 44446	Free	5818191	Disaster Relief	0000+0000	0000+0000	0000+0180
907 1 123 44447	Free	1357869	Disaster Relief	0000+0000	0000+0000	0000+0180
907 1 123 44448	Free	7606740	Disaster Relief	0000+0000	0000+0000	0000+0180
907 1 123 44449	Free	1994456	Disaster Relief	0000+0000	0000+0000	0000+0180
907 1 123 44450	Free	7474509	Disaster Relief	0000+0000	0000+0000	0000+0180

Figure 2.2.2.10-1: NOMAD ISU Display Window

The large display box at the bottom of the screen shows each Iridium Phone that is configured for an NOMAD MXU site. Entries are displayed in ascending MSISDN order. All groups or a single group are displayed by use of the selection box beneath the display. When the "group" **NONE** is selected, all phones which are not members of a time-sharing group will be displayed.

The fields shown in the display are:

- MSISDN - The Iridium system phone number
- Status - "Busy" if the phone is in use when the NOMAD MXU configuration is downloaded, otherwise "Free"
- ID Number - Created when the Phone is added, must be programmed into the SIM or dialed by the Iridium phone user after the NOMAD MXU answers.
- Pooled Time Group - Name of the group or NONE if not in a group
- Nomad Time - Current Nomad time available to each group member or single phone
- Paid Time - Current Paid time available to each group member or single phone
- Recharge Time - Nomad time to be automatically added at end of each month

The times are displayed as base times plus or minus changes made but not yet sent to the NOMAD MXU: EXAMPLE: 0120+0030 would mean that the phone or group had 120 minutes in that category and that the administrator added 30 minutes. After sending the configuration to the NOMAD MXU, the same field would display as 0150+0000.

2.2.2.11 Changing Entries

Double Clicking on any existing entry in the **NOMAD ISU Display Window** (figure 9) will bring up the following dialog box:

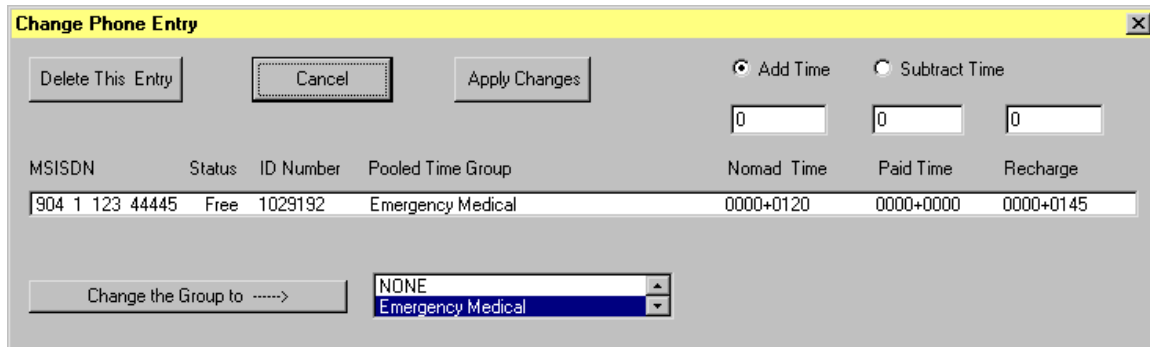

Figure 2.2.2.11-1: Change Entry Fields

The administrator can change the airtimes, delete the MSISDN entry or change the group membership of the MSISDN.

2.2.2.12 Menu Bar

This section covers the drop down menus available from the main screen of MCM.

2.2.2.12.1 File Menu

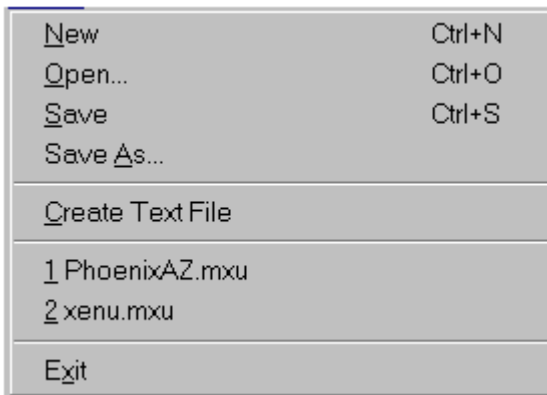

Figure 2.2.2.12.1-1: File Menu

The **New** menu selection creates a blank configuration document that can be changed and then saved with a name by using either the **Save** or **Save As** menu selections. **Open** displays the installation directory so that an existing configuration (.mxu) file can be selected

The **Create Text File** selection outputs the configuration data to a formatted text file and allows the user to bring up the default text editor to edit and print it. The file will be created in the MCM sub-directory that has the same name as the configuration file. The file extension will be .txt instead of .NOMAD MXU. Refer to Appendix B for an example of the data format.

The list of files above the **Exit** selection contains the names of the last files opened using the MCM program. Selecting from this list will re-open that file.

2.2.2.12.2 Connect Menu

This menu allows the administrator to retrieve the current configuration and airtime values from the NOMAD MXU and to apply a changed configuration to the NOMAD MXU. It is also used to configure the NOMAD MXU telephone system interface for the country of the NOMAD MXU site.

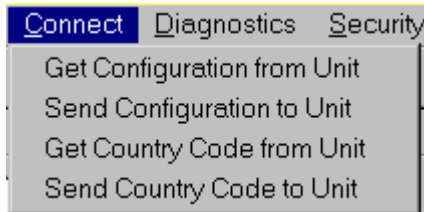

Figure 2.2.2.12.2-1: Connect Menu

The **Get Configuration from Unit** command connects to the NOMAD MXU unit over the modem connection or direct connect cable (whichever is currently configured) and then uploads and displays the current configuration. This allows the administrator to see how much airtime has been used and to get an updated base for changing the configuration. After a configuration is successfully uploaded, the "Date of Displayed Data" time is set to the current GMT time

The **Send Current Configuration** command connects to the NOMAD MXU unit over the currently configured interface and sends the displayed configuration values. Any changes to airtime categories, new or deleted phones, changes to groups, etc. will be applied by the NOMAD MXU. After a successful update, the time fields displayed as plus or minus base times are added to base times, and the +/- changes become zero in the MCM display. The administrator should save the current configuration file after sending a changed configuration and (recommended) use the **Get Configuration from Unit** command to verify that the changes have been applied.

The Get/Send Country Code commands allow the administrator to change the telephone configuration for the NOMAD MXU. This should only be done when the PC running the MCM program is directly connected to the NOMAD MXU by a serial cable. The settings can be changed to allow an MCM installation on another PC to dial in over a modem from anywhere in the world. When the setting is working, than the modem-connected PC running MCM must not be used to change it or it could "lock itself out" from connecting again. Refer to the section on creating a new NOMAD MXU configuration.

2.2.2.12.3 Diagnostics Menu

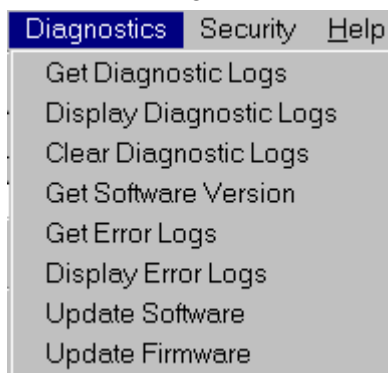

Figure 2.2.2.12.3-1: Diagnostics Menu

The **Get Diagnostic Logs** command connects to the NOMAD MXU and uploads the latest logs, which contain information on system usage and system health. The **Display Diagnostic Logs** command shows the directory contents of the file directory created for the NOMAD MXU. The administrator can display, edit or print the files by selecting them. The files are opened by whatever default text editor is configured for the system (Notepad, for example).

The **Clear Diagnostic Logs** command resets the logs on the NOMAD MXU to zero entries. NOTE: This should only be done if advised by support personnel

The **Get Software Version** command connects to the NOMAD MXU and retrieves and displays the currently installed version numbers for software and firmware.

The **Get Error Logs** and **Display Error Logs** commands function like the Diagnostic Logs commands but upload error reports, instead of diagnostic logs.

The **Update Software** and **Update Firmware** commands check the installation directory to see if code updates are included in the installation. If updates are found, the NOMAD MXU is contacted and the new code is transferred.

Update Firmware presents the following dialog box to allow the Administrator to control which Iridium transceiver will be upgraded. There will be directions with the upgrade software distribution to explain if any selection other than “ALL LBTs” should be used.

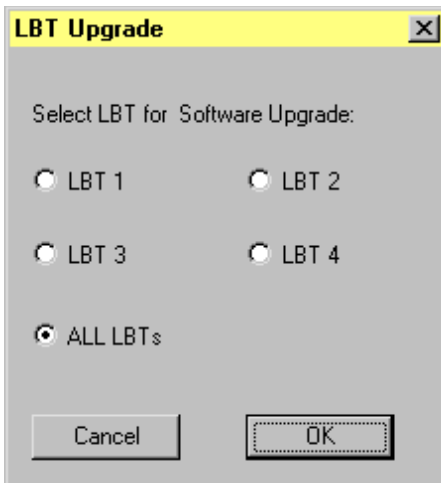

Figure 2.2.2.12.3-2: LBT Update Selection

2.2.2.12.4 Security Menu

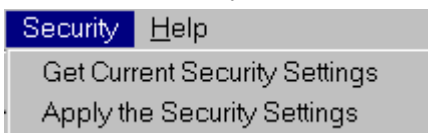

Figure 2.2.2.12.4-1: Security Menu

DRAFT COPY

NOMAD MXU Administration Manual

3:33 PM 02/12/99

The **Get Current Security Settings** command connects to the NOMAD MXU to retrieve and display the settings that are currently in force. The **Apply the Security Settings** command sends the currently displayed settings (**NOMAD MXU Enabled**, **Timeout Enabled**, and **Timeout Interval**) to the NOMAD MXU.

2.2.2.12.5 Support Menu



Figure 2.2.2.12.5-1: Support Menu

The support menu is grayed out for the Administration and Monitor releases of the Configuration Manager software. These functions are intended for use by support personnel only.

2.2.2.13 Display / File Options

The main screen window has a selection control underneath it that allows the user to select what is shown in the display. The administrator can choose to display any one of the defined groups, or all of the groups and phones (**ALL**, the default), or just those phones that are not members of a pooled-time group (**NONE**). In each case the entries will be ordered in ascending MSISDN value. Only the MSISDN entries that are currently displayed will be included in text file output for printing or editing. See the **File Menu** section, **Create Text File**.

The scroll arrows on the right of the box are used to show each defined group, or the **ALL** or **NONE** selections.



Figure 2.2.2.13-1: Group to Display

2.3 NOMAD Console

DRAFT COPY

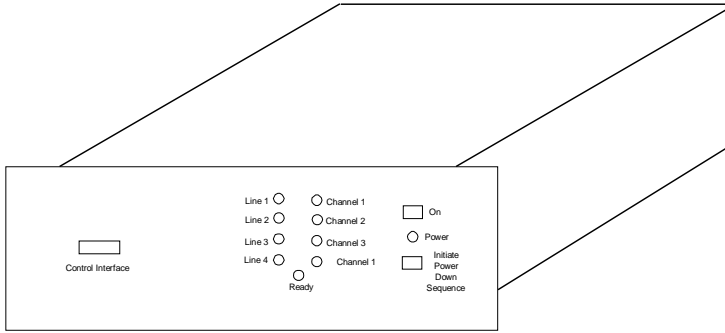

Figure 3.2-1: NOMAD Console

The NOMAD MXU Console is illustrated in Figure 3.2-1. The console is a standard 19 inch rack mountable drawer. The displays on the front panel, and the connections on the rear panel, are described in the following paragraphs.

2.3.1 Front Panel

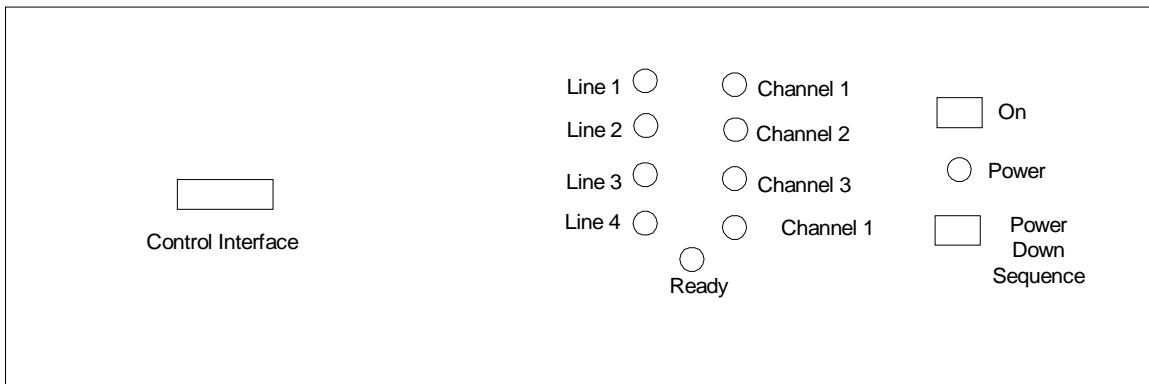

Figure 3.2.1-1: NOMAD Front Panel

The controls and indicators on the front panel are illustrated in Figure 3.2.1-1 and defined as follows:

Control Interface: RS232 interface that allows the operation of the NOMAD MXU to be administered or monitored via the Personal Computer (PC) defined in paragraph 4.1.3.1

Line 1 Indicator: Illuminated when Line 1, attached to the PSTN, is active.

Line 2 Indicator: Illuminated when Line 2, attached to the PSTN, is active.

Line 3 Indicator: Illuminated when Line 3, attached to the PSTN, is active.

Line 4 Indicator: Illuminated when Line 4, attached to the PSTN, is active.

Ready Indicator: Illuminated when the NOMAD MXU has passed the power on diagnostics and is ready to pass data.

Channel 1 Indicator: Illuminated when NOMAD MXU is making a call over the Constellations.

Channel 2 Indicator: Illuminated when NOMAD MXU is making a call over the Constellations.

Channel 3 Indicator: Illuminated when NOMAD MXU is making a call over the Constellations.

Channel 4 Indicator: Illuminated when NOMAD MXU is making a call over the Constellations.

Power Indicator: Illuminated whenever the NOMAD MXU is powered on.

On Push Button Switch: Activates NOMAD MXU on. Note: Due to the NOMAD MXU running self tests, there will be a delay of approximately 60 seconds before the ready indicator is activated.

Power Down Sequence Push Button Switch: This switch instructs the NOMAD MXU to power down. NOTE: there will be a delay of approximately 60 seconds from the time the pushbutton is pushed and the power light goes out. This is caused by the microprocessor processing data and storing the results on the internal hard drive.

2.3.2 Back Panel

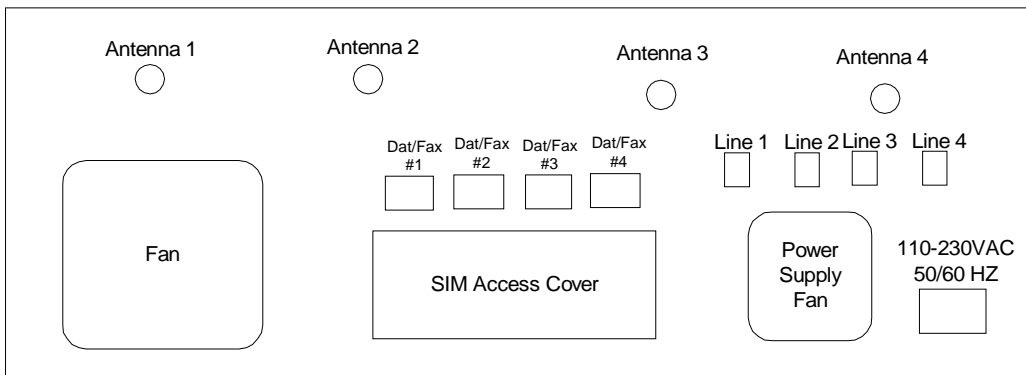

Figure 2.3.2-1: Nomad Back Panel

The connections and access panel on the on the back panel are illustrated in Figure 2.3.2-1 and defined as follows:

Antenna 1 Connector: Connects the NOMAD MXU's internal LBT to the antenna located outside the building.

Antenna 2 Connector: Connects the NOMAD MXU's internal LBT to the antenna located outside the building.

Antenna 3 Connector: Connects the NOMAD MXU's internal LBT to the antenna located outside the building.

Antenna 4 Connector: Connects the NOMAD MXU's internal LBT to the antenna located outside the building.

Line 1 Connector: RJ11 connector for connecting the NOMAD MXU to the Local PSTN

Line 2 Connector: RJ11 connector for connecting the NOMAD MXU to the Local PSTN

Line 3 Connector: RJ11 connector for connecting the NOMAD MXU to the Local PSTN

Line 4 Connector: RJ11 connector for connecting the NOMAD MXU to the Local PSTN

DRAFT COPY

NOMAD MXU Administration Manual

3:33 PM 02/12/99

SIM Access Cover: Panel to allow access to the four Subscriber Identification Modules (SIM).

Data/Fax #1: This connector is not used on the NOMAD MXU configuration.

Data/Fax #2: This connector is not used on the NOMAD MXU configuration.

Data/Fax #3: This connector is not used on the NOMAD MXU configuration.

Data/Fax #4: This connector is not used on the NOMAD MXU configuration.

110 – 230 VAC, 50/60 HZ Connector: **External power connector. Refer to the power specifications in Appendix “C”.**

DRAFT COPY

3 INSTALLATION

3.1 Overview

The administration and installation manuals are intended to identify and clearly describe the procedure for a successful installation and configuration of the NOMAD MXU. Before proceeding, the local installer and the gateway personnel are highly encouraged to read both manuals to completely understand the responsibilities of all parties.

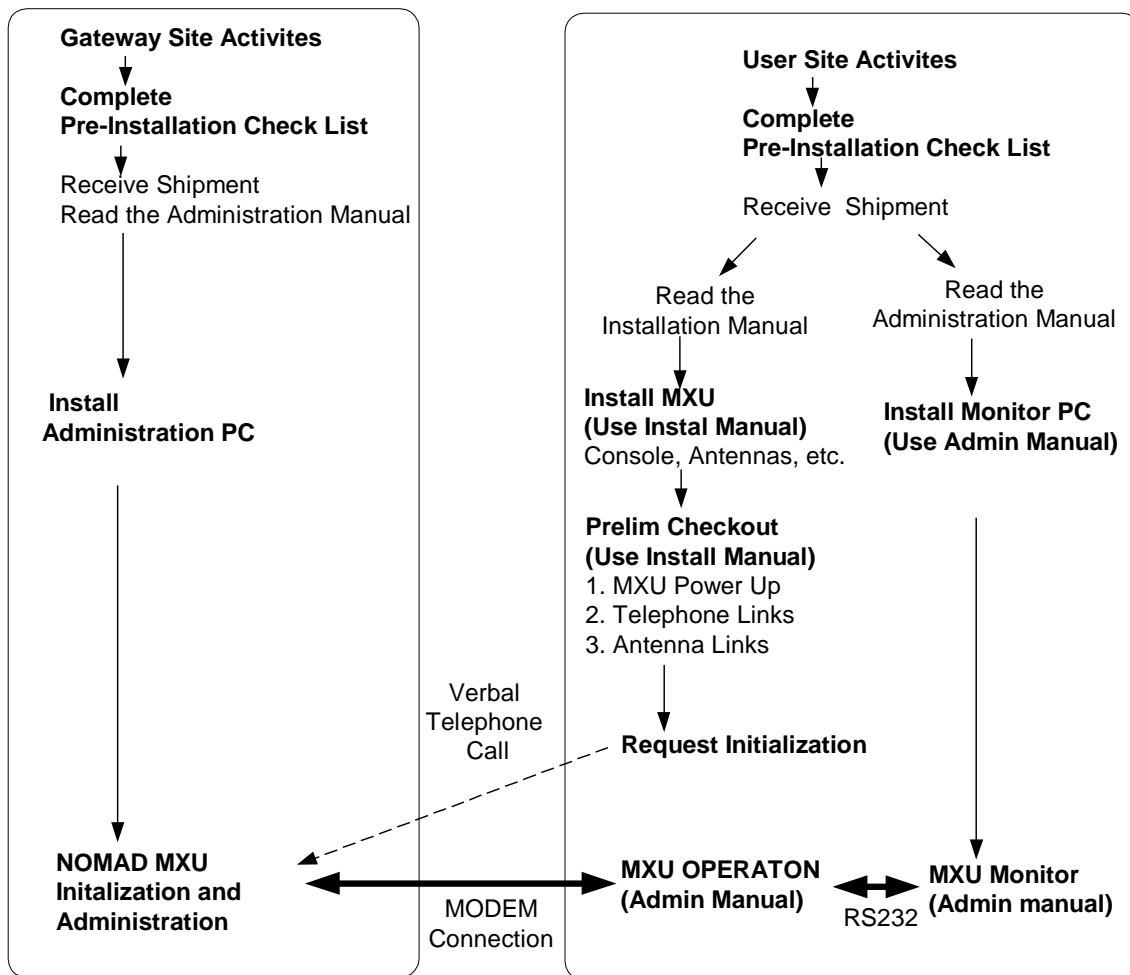

Figure 3.1-1: Installation Overview

The installation of the NOMAD MXU and control monitors can proceed simultaneously in three areas as illustrated in figure 3.1-1.

- The installation and configuration of the Gateway Control PC, (Administrative Manual)
- The installation and configuration of the Users Monitor PC. (Administrative Manual)
- The installation and preliminary checkout of the NOMAD MXU equipment. (Installation Manual)

DRAFT COPY

NOMAD MXU Administration Manual

3:33 PM 02/12/99

Both the administration and installation manuals should be reviewed and understood before installation is started.

Once the installation and checkout of the equipment is completed, the initialization of the NOMAD MXU is completed and the unit is operational

3.2 Install NOMAD MXU Console

Refer to the NOMAD MXU Installation Manual for installation of the console, antennas, etc at the users site.

3.3 Install Admin and Monitor PCs

3.3.1 PC Configuration

The requirements for both the administration and monitor PCs are:

- a Pentium class PC
- at least 50 MB of free disk space,
- Microsoft NT 4.0 installed
- NT Service Pack Three
- CDROM drive is required for installing the NOMAD MCM
- Haynes type modem (if removed from the NOMAD MXU's site)
- Null Modem cable (if located at the NOMAD MXU Console site)

3.3.2 Windows NT

- *Windows* and *Windows NT* are registered trademarks of Microsoft Corporation.
- This section does not cover the administration or use of the Microsoft Windows NT operating system or the Microsoft Remote Access System. Please refer to Microsoft documentation and help files for information on these subjects.
- It is assumed that the user of the NOMAD MXU Configuration Manager software is familiar with the goals and structure of the Iridium Nomad program.

3.3.3 Remote Access Services

The MCM software requires the Microsoft Remote Access Services package. Microsoft Service Pack 3 must be applied to the PC AFTER the installation of RAS. The Remote Access Services package is included with NT 4.0. Service Pack 3 can be obtained from Microsoft. If the PC has already had Service Pack 3 installed, but RAS is not installed, then Service Pack 3 must be re-applied after the RAS installation.

If the PC will not be directly connected to an NOMAD MXU, then it must have a modem installed and the modem must be configured to be a RAS device.

The RAS configuration must include the NetBEUI protocol in its network configuration. Refer to the Windows NT online help for guidance.

NT 4.0 comes with a direct cable driver, and this driver should also be configured to be a RAS device. The serial port that is used for a direct connection must be configured with a baud rate of 115200, and with 8 data bits, 1 stop bit, no parity. A direct connect cable must be used to connect the PC serial port to the

DRAFT COPY

DRAFT COPY

NOMAD MXU Administration Manual

3:33 PM 02/12/99

control port on the NOMAD MXU. This cable must be a “null-modem” cable that supports hardware handshake; these cables are commonly sold for PC to PC connections. Refer to Appendix A for a pin out of the required cable type.

3.4 Install MCM Program

3.4.1 Install Program

The following procedure installs the NOMAD MXU Configuration Manager Software.

1. Insert the MCM CDROM disk into the computer.
2. Use the Start Menu Run command to execute Startup.exe on the CDROM.
3. Follow the InstallShield directions.

3.4.2 Execute MCM Program

Use the Start->Programs Menu to select MCM_Admin.exe from within the installation directory or double-click on the Desktop Shortcut icon that is created by the installation.

4 INITIALIZATION and OPERATION

4.1 Creating a New NOMAD MXU Configuration

This section covers the data and activities involved in setting up a new NOMAD MXU configuration.

4.1.1 Get Required Information

The NOMAD MXU site or Nomad administration must be able to supply the following information for each NOMAD MXU site to be configured:

- If pooled time groups are to be used, then the number (1-3) of groups must be known. The administrator uses the **Configure Groups** menu to create the groups and assign descriptive names to them.
- The MSISDN (Iridium Phone Number) for each Iridium phone at the remote site must be known. If groups are configured then the group membership (group 1,2,3 or no group) for each phone must be supplied. This data is entered into the configuration by means of the **Add NOMAD ISU** menu, which allows the new MSISDN entry to be assigned to a group.
- The phone number of the NOMAD MXU at the remote site must be known. This number is entered into the **NOMAD MXU Connection Data** Dial-up number box. It goes after any digits required for accessing an outside line or to get to Long Distance, etc.
- The type of signaling used at the remote site, Pulse or Tone, must be known. This is set in the **NOMAD MXU Location** box, using the **Phone Type at Location** buttons.

DRAFT COPY

DRAFT COPY

NOMAD MXU Administration Manual

3:33 PM 02/12/99

- The amount of Nomad program airtime that will be allowed per month for each phone should be known.

This information is entered into the Configuration for the NOMAD MXU, along with Gateway-supplied data, such as the desired security configuration.

The MCM program creates a unique 7-digit ID code when each MSISDN is entered. This ID number will then be programmed into the Iridium Subscriber Unit (phone) SIM card, or given to the NOMAD MXU site to be used by the callers. The code identifies the Nomad time charging account when a call is made.

4.1.2 MCM New Configuration Screen

When the NOMAD MXU Configuration Manager program icon is double clicked, it will present the following screen representing a blank configuration:

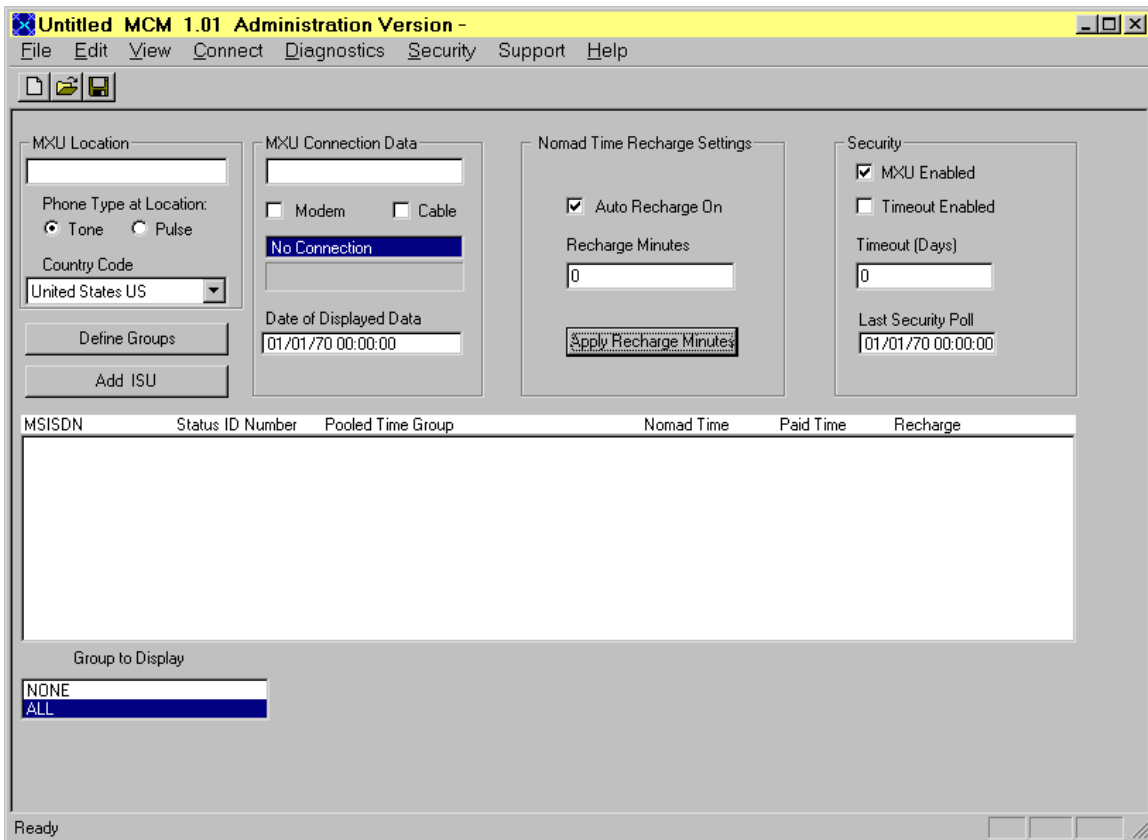

Figure 4.1.2-1: New MCM Screen

4.1.3 Enter Connection Data

- Type in the **NOMAD MXU Location** text description. This can be any text that the administrator chooses.

DRAFT COPY

DRAFT COPY

NOMAD MXU Administration Manual

3:33 PM 02/12/99

- Click on the **Tone** or **Pulse** button, depending on the type of phone system to which the NOMAD MXU will be connected.
- Type in the phone number for the NOMAD MXU. This field (at the top of the **NOMAD MXU Connection Data** section) must contain any digits required to get an outside line, long distance, any national code, area code and the local exchange number of the NOMAD MXU connection. This data is not required if the MCM PC will be directly connected to the NOMAD MXU via serial cable.
- Select the **Modem** button for a phone connection or the **Cable** button for a direct connection to the NOMAD MXU. If you have not already saved the configuration, you will be prompted to save it with a descriptive name at this time.

4.1.4 Enter Security Data

If the **Timeout Enabled** box is checked, the NOMAD MXU will shut down automatically when not contacted by the MCM program (by doing a security poll, or configuration change, or diagnostic log retrieval, etc.). The number of days that the NOMAD MXU will continue to work without contact before shutting down is set in the **Timeout** field

Uncheck the **NOMAD MXU Enabled** box if you want to be able to configure the NOMAD MXU but restrict it from answering calls from the Iridium phones until you enable it again.

4.1.5 Configure Pooled Time Groups

Use the **Define Groups** button to bring down a dialog box, which will allow you to name and enable up to three groups whose MSISDN members will share airtime.

4.1.6 Enter MSISDNs

Use the **Add NOMAD ISU** (Iridium Subscriber Unit) button to bring down a dialog box to enter the assigned MSISDN number and group (if any) for each Iridium phone at the NOMAD MXU site. As each phone number is entered, a new entry will appear in the main screen display, and the unique Charge ID for that phone will be allocated. If an MSISDN account is not a member of an airtime pooling group, leave the selection in the group selection box at **NONE** (see figure 8).

4.1.7 Set Nomad Airtime Recharge

If this site is to receive Nomad program airtime at the start of each month, enter the number of minutes to be allocated for each phone and click on the **Apply Recharge Minutes** button. Phones that are members of a pooled airtime group will be shown with the available pooled time for the whole group in the **Recharge** column of the main display window.

4.1.8 Allocate Airtime

If paid airtime or partial month Nomad airtime is to be assigned to any group, double click on any group member entry in the main display window. Add the airtime minutes into the edit field for the desired airtime category. Do the same for any non-group members that need to be changed.

DRAFT COPY

4.1.9 Save the Configuration Document

When the initial configuration document is first saved, the administrator must assign it a unique name. This name should be descriptive, because the file names will be displayed in the Windows **Open** Dialogue when the administrator wants to contact a particular NOMAD MXU. The document will be assigned the postfix ".NOMAD MXU". The file should be saved by use of the **File...Save** menu command whenever the configuration is changed. At certain critical times, the program will save the current configuration to disk with out the user's request. If changes have not been saved when the file is closed, the user will be prompted to save the file before closing it.

4.1.10 First NOMAD MXU Communication (Initialization)

The first time that an NOMAD MXU is configured it must be initialized. Before this can be done, the following conditions must be met:

- The NOMAD MXU at the remote site is installed and has passed the installation tests.
- The NOMAD MXU configuration has been created by the MCM program using the preceding steps.

Click on the **Connect** menu and select **Send Configuration to Unit**. A message will appear to inform you that the NOMAD MXU must be initialized. Click on the OK button

The MCM program connects to the NOMAD MXU and tells it to initialize. This is only done the first time that the NOMAD MXU is configured. You will receive a success/fail message after the initialization request is acknowledged by the NOMAD MXU. If it is a success, then please wait the requested amount of time while the NOMAD MXU finishes initialization. Then repeat the steps above to send the displayed configuration to the NOMAD MXU. This time, the configuration is accepted and the NOMAD MXU will begin to allow calls to be made (unless the configuration contains no current airtime or the security parameter **NOMAD MXU Enabled** is turned off).

4.1.11 Country Code Setting

The NOMAD MXU is shipped to the installation site with its telephone interface pre-configured for the destination country. If the initialization is successful, the country code is correct and should never be changed by the remotely connected NOMAD MXU. To display the configured country code, use the **Connect** menu command **Get Country Code from Unit** after the initialization completes.

If the unit does not initialize, it may be necessary to change the code on the NOMAD MXU by connecting a PC to the NOMAD MXU on site with a direct connect cable, and then using the **Send Country Code to Unit** command after selecting a different country from the drop down list in the Country Code display. This should be done only with advice from Nomad program support personnel. After the connection is working, the remote MCM PC can us the **Get Country Code from Unit** command to display the correct telephone configuration for the NOMAD MXU

4.2 Administration Issues

DRAFT COPY

NOMAD MXU Administration Manual

3:33 PM 02/12/99

4.2.1 Operator Security

Problem: it is desirable to have different Nomad administration operators control separate groups of NOMAD MXUs and it is required that each operator be restricted to just the assigned NOMAD MXUs.

Solution: After the initial configuration (.NOMAD MXU) file has been saved and named, set the NT file permissions of the configuration (.NOMAD MXU) file and the subdirectory that has the same name as the configuration file.

Set the permissions to allow read/write access to only the assigned operator/logon and the NT Administrator. Refer to the **Files and Directories** section for more information. Also check the NT help facility on the NT Start Menu for "files:permissions".

4.2.2 Air Time Recharge Control

If the **Auto Recharge On** box is checked, the NOMAD MXU will automatically credit the amount of time displayed under the "Recharge" heading for the group or phone to the "Nomad Time" account at the start of each month. If the administrator removes the check from this box and sends the configuration, the recharge will still be applied for one more month. If the Auto Recharge is turned on again, monthly recharge will resume until the expiration of the Nomad program.

4.2.3 Maintaining Consistency with the NOMAD MXU

It is important to realize that the local configuration file and the actual airtime values on the remote NOMAD MXU are only in agreement after the configuration has been read from the NOMAD MXU and saved to the file by using the

Connect...Get Configuration from Unit and the **File...Save** menu commands.

The correct procedure for changing the NOMAD MXU configuration is to first upload the current values from the NOMAD MXU, make the desired changes and then send the updated configuration to the NOMAD MXU.

4.2.4 Creating a Field Unit

The .NOMAD MXU file must be present in order to communicate with a specific NOMAD MXU installation. If more than one PC must be able to communicate with an NOMAD MXU, use the following procedure AFTER initializing the NOMAD MXU by sending a first configuration:

1. Install the MCM software on the second PC (either the ADMIN or MONITOR versions, depending on whether the second PC is allowed to change the configuration at the NOMAD MXU or only read it). Refer to the
2. Copy the .NOMAD MXU file for the site to be administered from the original PC to the MCM directory on the second PC.
3. Run the MCM program on the second PC and use the File..Open menu command to open the NOMAD MXU file, and then save it. This will create the directories associated with the configuration file.
4. Make any connection changes that are required. For example, if the second PC is a laptop that will be directly connected to the NOMAD MXU, change the **NOMAD MXU Connection Data** selection from **Modem to Cable**.

The PC is now ready to make connections to the NOMAD MXU. Repeat the above process for each NOMAD MXU that the new PC will need to administer.

4.3 Files and Directories

DRAFT COPY

DRAFT COPY

NOMAD MXU Administration Manual

3:33 PM 02/12/99

The InstallShield installation process will allow the user to select the top-level directory for the MCM. The following directory tree will then be created whenever a new configuration is saved/named for the first time.

The tree is shown together with typical files that may be created.

MCM\
MCM_Admin.exe - Top directory created by Install
mxumgr.pbk - The MCM program
PhoenixAZ.mxu - RAS phone book file
- A saved Configuration file

PhoenixAZ\
- Subdirectory for this NOMAD MXU configuration
PhoenixAZ.txt - File created with the **File...Create Text File** menu
Diagnostics\
Diag1.txt - Subdirectory for diagnostics logs
- Uploaded diagnostic log.

Errors\
Error1.txt -Subdirectory for error logs
-Uploaded error log

SoftUpdate\
MXU\
LBT\
-Will exist if an update is included in the MCM distribution
-MXU Software
-LBT Firmware

5 TROUBLE SHOOTING GUIDELINES

5.1 Troubleshooting VS. Security

5.2 How TO Retrieving NOMAD MXU Diagnostics Files

5.3 Initialization

NOMAD MXU INITIALIZATION PROBLEMS

Problem(s)	Possible Cause(s)	Solution(s)

DRAFT COPY

DRAFT COPY

5.4 NOMAD MXU Operation Problems

NOMAD MXU OPERATIONAL PROBLEMS

Problem(s)	Possible Cause(s)	Solution(s)

5.5 Administrative Station Problems

NOMAD MXU ADMINISTRATION STATION PROBLEMS

Problem(s)	Possible Cause(s)	Solution(s)

5.6 Monitor Station Problems

NOMAD MXU MONITOR STATION PROBLEMS

Problem(s)	Possible Cause(s)	Solution(s)

DRAFT COPY

5.7 NOMAD MXU System Problems

Iridium NOMAD Service

Equipment: Iridium Satellite Phone

Problem(s)	Possible Cause(s)	Solution(s)
The NOMAD User cannot make or receive any calls.	The appropriate SIM (FDN) card may not be in the phone.	Provide directions to the NOMAD User on how to put the appropriate SIM card in the phone. Refer to the equipment Instruction Manual.
	Iridium homed #8817: The NOMAD User may be trying to make a call while outside of his or her home country.	Explain that the Iridium homed #8817 network may only be accessed when the NOMAD User is making calls from within his or her home country.
	Iridium homed #8817: The NOMAD User may be near a country border (within 10 km or 6 miles).	Explain that the Iridium homed #8817 calls may not go through when the NOMAD User is within 10 km of a country border.
	The equipment may not be turned on. OR The battery may not be charged.	Provide directions to the NOMAD User on how the phone operates or on how to change the battery. Refer to the equipment Instruction Manual.
	The appropriate provisioning contracts may not be activated.	Check the Telephony Contract Window to verify the appropriate contract is activated. Verify the service package supports the desired use (e.g. service package does not restrict outbound or inbound calls).
	The NOMAD User may be misinformed about dialing directions.	Instruct the NOMAD User on the dialing directions for a specific area. Refer to the equipment Instruction Manual.
	Potential network problem.	Check the Network Advisory system for any information in the Iridium Network.

Iridium NOMAD Service

Equipment: Iridium Satellite Phone

Problem(s)	Possible Cause(s)	Solution(s)
The NOMAD User experiences difficulties during the call: <ul style="list-style-type: none">• Transmission problems (cross-talk, echo, noise, static, distortion)• Dropped calls	A structure or the environment (i.e. building, tunnel) may be blocking the line of sight between the NOMAD User's phone and the satellite.	Advise the NOMAD User to move to a new location so a visible line of sight to the satellite can be established.
	The NOMAD User may be misinformed about the dialing directions.	Instruct the NOMAD User on the dialing directions for a specific area. Refer to the equipment Instruction Manual.

DRAFT COPY

Iridium NOMAD Service Equipment: Iridium Satellite Phone

Problem(s)	Possible Cause(s)	Solution(s)
	Potential network problem.	Check the Network Advisory system for any information in the Iridium Network.
The NOMAD User receives an announcement when placing a call.	The NOMAD User may not understand the content of the announcement.	If the NOMAD User repeats the announcement to the Customer Service Representative (CSR), explain it to the NOMAD User.
	The NOMAD User may not understand the purpose of the announcement.	Explain why announcements are distributed.
The NOMAD User cannot use a feature associated with the Iridium service.	The appropriate service package may not be activated through the contract.	Access the Telephony Contract Window for the appropriate contract and verify the requested feature is available. Then verify the appropriate service package is selected.
	The NOMAD User may have activated or deactivated the service or feature through a NOMAD User Service Session.	Verify the NOMAD User did not turn off the feature during a NOMAD User Service Session.
The NOMAD User experiences the following difficulty: <ul style="list-style-type: none">Equipment is lost, stolen, defective or damaged.	The equipment has been misplaced, stolen, or broken.	Follow local policies and procedures for the handling of Lost, Stolen, Defective and Damaged equipment.

Iridium NOMAD Service* Equipment: NOMAD MXU

Problem(s)	Possible Cause(s)	Solution(s)
NOMAD Mobile Access users unable to make calls on the PSTN	Pin code problem or user education	
NOMAD MXU not working	SIM Card problem	
	End user problem	
	Incorrect SIM cards installed in NOMAD MXU	
	Sim card failure in NOMAD MXU	
	Faulty Hardware in NOMAD MXU	
	NOMAD ISU board in NOMAD MXU	
	Dialogic board in NOMAD MXU	
	PC hardware in NOMAD MXU	
	Site Problem	
PSTN problem	Interconnection issues	

DRAFT COPY

NOMAD MXU Administration Manual

3:33 PM 02/12/99

Iridium NOMAD Service*

Equipment: NOMAD MXU

Problem(s)	Possible Cause(s)	Solution(s)
	Protocol incompatibilities	
	Network failures	

DRAFT COPY

APPENDIX “A” - Null Modem Cable

The diagram below shows the pin connections for a 9 pin direct connect cable used to connect a PC running the MCM program and an NOMAD MXU:

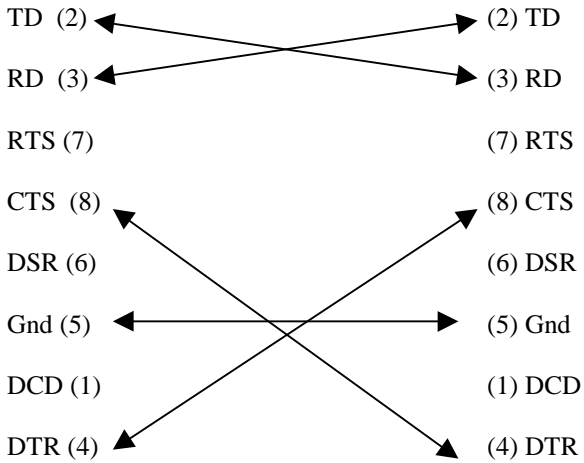

Figure 1 Cable Pinout

APPENDIX “B” - Example Create Text File

The following is an example file produced with the **Create Text File** menu command.

```
Iridium Nomad Configuration for: Phoenix, AZ Red Cross
Printed at: 01/04/99 20:02:22
```

```
The Site is enabled. The Security Timeout is not enabled.
The Site uses Tone Dial Method. The Site Dialup Number is:
Automatic Recharge of Nomad Airtime is enabled.
```

MSISDN	Status	ID Number	Pooled	Time Group	Nomad	Paid	Recharge
907 1 123 04441	Free	5381289	Emergency	Medical	0120+0000	0000+0000	0145+0060
907 1 123 04442	Free	3303364	Emergency	Medical	0120+0000	0000+0000	0145+0060
907 1 123 04444	Free	3833844	Disaster	Relief	0000+0030	0000+0000	0000+0030
907 1 123 04446	Free	1092135	NONE		0000+0045	0000+0000	0000+0000

Appendix “C” – Logs

NOTICE: This file has been newly created. This means:

- (1) The MXU may be new.
- (2) Log files may have been cleared manually or by a Gateway command.

DRAFT COPY

NOMAD MXU Administration Manual

3:33 PM 02/12/99

(3) Backup files may have just been created.
(4) Both redundant files of this log may have been corrupted.
In the last case, if this is an Error (Diagnostics) Log, all data is also in the Activity Log. If this is an Activity Log, data entries MAY HAVE BEEN LOST.

Coordinated Universal Time is Thu Jan 28 13:23:22 1999
LBT 4 signal level for successful call: 5

Coordinated Universal Time is Thu Jan 28 13:28:15 1999
Gateway connected via RS232 port.

Coordinated Universal Time is Thu Jan 28 13:28:19 1999
Remote Connection established. Computer:PC-EPB94 User: factory

Coordinated Universal Time is Thu Jan 28 15:03:56 1999
LBT 4 signal level for successful call: 5

Coordinated Universal Time is Thu Jan 28 15:10:37 1999
LBT 4 signal level for successful call: 5

Coordinated Universal Time is Thu Jan 28 15:18:02 1999
Gateway connected via RS232 port.

Coordinated Universal Time is Thu Jan 28 15:18:20 1999
Remote Connection established. Computer:PC-EPB94 User: factory

Coordinated Universal Time is Thu Jan 28 15:22:03 1999
LBT 4 signal level for successful call: 5

Coordinated Universal Time is Thu Jan 28 15:27:29 1999
LBT 4 signal level for successful call: 5

Coordinated Universal Time is Thu Jan 28 15:33:11 1999
LBT 2 signal level for successful call: 5

Coordinated Universal Time is Thu Jan 28 15:33:11 1999
LBT 1 signal level for successful call: 5

Coordinated Universal Time is Thu Jan 28 15:33:11 1999
LBT 4 signal level for successful call: 5

Coordinated Universal Time is Thu Jan 28 15:33:12 1999
LBT 3 signal level for successful call: 5

Coordinated Universal Time is Thu Jan 28 15:58:25 1999
SC2000 version register value: 0x00

Coordinated Universal Time is Thu Jan 28 15:58:40 1999
The MXU has been powered up.

Results of Initialization:
LBT Interface startup complete. Waiting for LBT Response.
LBT Interface startup complete. Waiting for LBT Response.
LBT Interface startup complete. Waiting for LBT Response.

DRAFT COPY

DRAFT COPY
NOMAD MXU Administration Manual

3:33 PM 02/12/99

LBT Interface startup complete. Waiting for LBT Response.
Dialogic Channel 1 is available.
Dialogic Channel 2 is available.
Dialogic Channel 3 is available.
Dialogic Channel 4 did not detect dial tone.

Coordinated Universal Time is Thu Jan 28 15:58:52 1999
SC2000 version register value: 0x00

Coordinated Universal Time is Thu Jan 28 15:59:46 1999
The MXU has been powered up.

Results of Initialization:
LBT Interface startup complete. Waiting for LBT Response.
LBT Interface startup complete. Waiting for LBT Response.
LBT Interface startup complete. Waiting for LBT Response.
LBT Interface startup complete. Waiting for LBT Response.
Dialogic Channel 1 is available.
Dialogic Channel 2 is available.
Dialogic Channel 3 is available.
Dialogic Channel 4 did not detect dial tone.

Coordinated Universal Time is Thu Jan 28 15:59:48 1999
LBT 1 SW Version = 0x00 0x00 0x00

Coordinated Universal Time is Thu Jan 28 16:00:01 1999
D:\mxusrc\db\Logwrite.cpp: Opening AT from Master!

Coordinated Universal Time is Thu Jan 28 16:00:01 1999
D:\mxusrc\db\Logwrite.cpp: Opening SC from Master!

Coordinated Universal Time is Thu Jan 28 16:00:01 1999
MODEM Successfully programmed. MODEM Identifier :V2.096-K56_2M_DLP_CSMT

Coordinated Universal Time is Thu Jan 28 16:00:01 1999
MODEM Data Pump Identifier :RC56DPF L8565A Rev 47.22/47.22

Coordinated Universal Time is Thu Jan 28 16:00:01 1999
LBT:1 is now ready for calls.

Coordinated Universal Time is Thu Jan 28 16:00:13 1999
LBT 2 SW Version = 0x00 0x00 0x00

Coordinated Universal Time is Thu Jan 28 16:00:18 1999
LBT:2 is now ready for calls.

Coordinated Universal Time is Thu Jan 28 16:00:37 1999
LBT 3 SW Version = 0x00 0x00 0x00

Coordinated Universal Time is Thu Jan 28 16:00:44 1999
LBT:3 is now ready for calls.

DRAFT COPY

DRAFT COPY
NOMAD MXU Administration Manual

3:33 PM 02/12/99

Coordinated Universal Time is Thu Jan 28 16:01:02 1999
LBT 4 SW Version = 0x00 0x00 0x00

Coordinated Universal Time is Thu Jan 28 16:01:09 1999
LBT:4 is now ready for calls.

Coordinated Universal Time is Thu Jan 28 16:01:24 1999
LBT 4 signal level for successful call: 5

Coordinated Universal Time is Thu Jan 28 16:04:01 1999
PBX:4 is now ready for calls.

Coordinated Universal Time is Thu Jan 28 16:04:07 1999
LBT 3 signal level for successful call: 5

Coordinated Universal Time is Thu Jan 28 16:04:08 1999
LBT 2 signal level for successful call: 5

Coordinated Universal Time is Thu Jan 28 16:04:08 1999
LBT 4 signal level for successful call: 5

Coordinated Universal Time is Thu Jan 28 16:04:10 1999
LBT 1 signal level for successful call: 5

Coordinated Universal Time is Thu Jan 28 16:09:18 1999
SC2000 version register value: 0x00

Coordinated Universal Time is Thu Jan 28 16:09:47 1999
The MXU has been powered up.

Results of Initialization:
LBT Interface startup complete. Waiting for LBT Response.
LBT Interface startup complete. Waiting for LBT Response.
LBT Interface startup complete. Waiting for LBT Response.
LBT Interface startup complete. Waiting for LBT Response.
Dialogic Channel 1 is available.
Dialogic Channel 2 is available.
Dialogic Channel 3 is available.
Dialogic Channel 4 did not detect dial tone.

Coordinated Universal Time is Thu Jan 28 16:10:01 1999
D:\mxusrc\db\Logwrite.cpp: Opening AT from Master!

Coordinated Universal Time is Thu Jan 28 16:10:02 1999
D:\mxusrc\db\Logwrite.cpp: Opening SC from Master!

Coordinated Universal Time is Thu Jan 28 16:11:25 1999
SC2000 version register value: 0x00

Coordinated Universal Time is Thu Jan 28 16:11:54 1999
The MXU has been powered up.

DRAFT COPY

DRAFT COPY

NOMAD MXU Administration Manual

3:33 PM 02/12/99

Results of Initialization:
LBT Interface startup complete. Waiting for LBT Response.
LBT Interface startup complete. Waiting for LBT Response.
LBT Interface startup complete. Waiting for LBT Response.
LBT Interface startup complete. Waiting for LBT Response.
Dialogic Channel 1 is available.
Dialogic Channel 2 is available.
Dialogic Channel 3 is available.
Dialogic Channel 4 did not detect dial tone.

Coordinated Universal Time is Thu Jan 28 16:12:09 1999
D:\mxusrc\db\Logwrite.cpp: Opening AT from Master!

Coordinated Universal Time is Thu Jan 28 16:12:09 1999
D:\mxusrc\db\Logwrite.cpp: Opening SC from Master!

Coordinated Universal Time is Thu Jan 28 16:12:17 1999
LBT 1 SW Version = 0x00 0x00 0x00

Coordinated Universal Time is Thu Jan 28 16:12:22 1999
LBT:1 is now ready for calls.

Coordinated Universal Time is Thu Jan 28 16:12:42 1999
LBT 2 SW Version = 0x00 0x00 0x00

Coordinated Universal Time is Thu Jan 28 16:12:47 1999
LBT:2 is now ready for calls.

Coordinated Universal Time is Thu Jan 28 16:13:06 1999
LBT 3 SW Version = 0x00 0x00 0x00

Coordinated Universal Time is Thu Jan 28 16:13:13 1999
LBT:3 is now ready for calls.

Coordinated Universal Time is Thu Jan 28 16:13:31 1999
LBT 4 SW Version = 0x00 0x00 0x00

Coordinated Universal Time is Thu Jan 28 16:13:38 1999
LBT:4 is now ready for calls.

Coordinated Universal Time is Thu Jan 28 16:14:05 1999
LBT 2 signal level for successful call: 5

Coordinated Universal Time is Thu Jan 28 16:14:05 1999
LBT 3 signal level for successful call: 5

Coordinated Universal Time is Thu Jan 28 16:14:06 1999
LBT 4 signal level for successful call: 5

Coordinated Universal Time is Thu Jan 28 16:14:06 1999
LBT 1 signal level for successful call: 5

Coordinated Universal Time is Thu Jan 28 16:15:42 1999

DRAFT COPY

DRAFT COPY
NOMAD MXU Administration Manual

3:33 PM 02/12/99

LBT 4 signal level for successful call: 5

Coordinated Universal Time is Thu Jan 28 16:16:34 1999
PBX:4 is now ready for calls.

Coordinated Universal Time is Thu Jan 28 16:18:01 1999
SC2000 version register value: 0x00

Coordinated Universal Time is Thu Jan 28 16:18:30 1999
The MXU has been powered up.

Results of Initialization:

LBT Interface startup complete. Waiting for LBT Response.
LBT Interface startup complete. Waiting for LBT Response.
LBT Interface startup complete. Waiting for LBT Response.
LBT Interface startup complete. Waiting for LBT Response.
Dialogic Channel 1 is available.
Dialogic Channel 2 is available.
Dialogic Channel 3 is available.
Dialogic Channel 4 did not detect dial tone.

Coordinated Universal Time is Thu Jan 28 16:18:45 1999
D:\mxusrc\db\Logwrite.cpp: Opening AT from Master!

Coordinated Universal Time is Thu Jan 28 16:18:45 1999
D:\mxusrc\db\Logwrite.cpp: Opening SC from Master!

Coordinated Universal Time is Thu Jan 28 16:18:53 1999
LBT 1 SW Version = 0x00 0x00 0x00

Coordinated Universal Time is Thu Jan 28 16:18:58 1999
LBT:1 is now ready for calls.

Coordinated Universal Time is Thu Jan 28 16:19:18 1999
LBT 2 SW Version = 0x00 0x00 0x00

Coordinated Universal Time is Thu Jan 28 16:19:23 1999
LBT:2 is now ready for calls.

Coordinated Universal Time is Thu Jan 28 16:19:42 1999
LBT 3 SW Version = 0x00 0x00 0x00

Coordinated Universal Time is Thu Jan 28 16:19:49 1999
LBT:3 is now ready for calls.

Coordinated Universal Time is Thu Jan 28 16:20:07 1999
LBT 4 SW Version = 0x00 0x00 0x00

Coordinated Universal Time is Thu Jan 28 16:20:14 1999
LBT:4 is now ready for calls.

Coordinated Universal Time is Thu Jan 28 16:20:49 1999
LBT 4 signal level for successful call: 5

DRAFT COPY

DRAFT COPY
NOMAD MXU Administration Manual

3:33 PM 02/12/99

Coordinated Universal Time is Thu Jan 28 16:20:57 1999
Connected channel LBT:4 to PBX:1

Coordinated Universal Time is Thu Jan 28 16:21:06 1999
LBT 3 signal level for successful call: 5

Coordinated Universal Time is Thu Jan 28 16:21:13 1999
Connected channel LBT:3 to PBX:3

Coordinated Universal Time is Thu Jan 28 16:21:22 1999
LBT 2 signal level for successful call: 5

Coordinated Universal Time is Thu Jan 28 16:21:29 1999
Connected channel LBT:2 to PBX:2

Coordinated Universal Time is Thu Jan 28 16:21:38 1999
LBT 1 signal level for successful call: 5

Coordinated Universal Time is Thu Jan 28 23:32:06 1999
SC2000 version register value: 0x00

Coordinated Universal Time is Thu Jan 28 23:33:06 1999
The MXU has been powered up.

Results of Initialization:
LBT Interface startup complete. Waiting for LBT Response.
LBT Interface startup complete. Waiting for LBT Response.
LBT Interface startup complete. Waiting for LBT Response.
LBT Interface startup complete. Waiting for LBT Response.
Dialogic Channel 1 is available.
Dialogic Channel 2 is available.
Dialogic Channel 3 is available.
Dialogic Channel 4 did not detect dial tone.

Coordinated Universal Time is Thu Jan 28 23:33:18 1999
MODEM Successfully programmed. MODEM Identifier :V2.096-K56_2M_DLP_CSMT

Coordinated Universal Time is Thu Jan 28 23:33:18 1999
MODEM Data Pump Identifier :RC56DPF L8565A Rev 47.22/47.22

Coordinated Universal Time is Thu Jan 28 23:33:18 1999
D:\mxusrc\db\Logwrite.cpp: Opening AT from Master!

Coordinated Universal Time is Thu Jan 28 23:33:19 1999
D:\mxusrc\db\Logwrite.cpp: Opening SC from Master!

Coordinated Universal Time is Thu Jan 28 23:33:28 1999
LBT 1 SW Version = 0x00 0x00 0x00

Coordinated Universal Time is Thu Jan 28 23:33:33 1999
LBT:1 is now ready for calls.

DRAFT COPY

DRAFT COPY
NOMAD MXU Administration Manual

3:33 PM 02/12/99

Coordinated Universal Time is Thu Jan 28 23:33:53 1999
LBT 2 SW Version = 0x00 0x00 0x00

Coordinated Universal Time is Thu Jan 28 23:33:59 1999
LBT:2 is now ready for calls.

Coordinated Universal Time is Thu Jan 28 23:34:17 1999
LBT 3 SW Version = 0x00 0x00 0x00

Coordinated Universal Time is Thu Jan 28 23:34:24 1999
LBT:3 is now ready for calls.

Coordinated Universal Time is Thu Jan 28 23:34:42 1999
LBT 4 SW Version = 0x00 0x00 0x00

Coordinated Universal Time is Thu Jan 28 23:34:50 1999
LBT:4 is now ready for calls.

Coordinated Universal Time is Thu Jan 28 23:34:56 1999
LBT 2 signal level for successful call: 5

Coordinated Universal Time is Thu Jan 28 23:35:06 1999
Connected channel LBT:2 to PBX:2

Coordinated Universal Time is Thu Jan 28 23:35:22 1999
LBT 1 signal level for successful call: 5

Coordinated Universal Time is Thu Jan 28 23:35:35 1999
Connected channel LBT:1 to PBX:1

Coordinated Universal Time is Thu Jan 28 23:35:50 1999
LBT 4 signal level for successful call: 5

Coordinated Universal Time is Thu Jan 28 23:36:01 1999
Connected channel LBT:4 to PBX:3

Coordinated Universal Time is Thu Jan 28 23:36:16 1999
LBT 3 signal level for successful call: 5

Coordinated Universal Time is Thu Jan 28 23:36:59 1999
PBX:4 is now ready for calls.

Coordinated Universal Time is Thu Jan 28 23:37:23 1999
LBT 2 signal level for successful call: 5

Coordinated Universal Time is Thu Jan 28 23:37:34 1999
Connected channel LBT:2 to PBX:2

Coordinated Universal Time is Thu Jan 28 23:37:49 1999
LBT 1 signal level for successful call: 5

Coordinated Universal Time is Thu Jan 28 23:38:02 1999
Connected channel LBT:1 to PBX:1

Coordinated Universal Time is Thu Jan 28 23:38:17 1999

DRAFT COPY

DRAFT COPY
NOMAD MXU Administration Manual

3:33 PM 02/12/99

LBT 4 signal level for successful call: 5

Coordinated Universal Time is Thu Jan 28 23:38:28 1999
Connected channel LBT:4 to PBX:4

Coordinated Universal Time is Thu Jan 28 23:38:44 1999
LBT 3 signal level for successful call: 5

Coordinated Universal Time is Thu Jan 28 23:38:54 1999
Connected channel LBT:3 to PBX:3

Coordinated Universal Time is Thu Jan 28 23:42:26 1999
LBT 2 signal level for successful call: 5

Coordinated Universal Time is Thu Jan 28 23:42:36 1999
Connected channel LBT:2 to PBX:2

Coordinated Universal Time is Thu Jan 28 23:42:52 1999
LBT 1 signal level for successful call: 5

Coordinated Universal Time is Thu Jan 28 23:43:04 1999
Connected channel LBT:1 to PBX:1

Coordinated Universal Time is Thu Jan 28 23:43:21 1999
LBT 4 signal level for successful call: 5

Coordinated Universal Time is Thu Jan 28 23:43:31 1999
Connected channel LBT:4 to PBX:4

Coordinated Universal Time is Thu Jan 28 23:43:46 1999
LBT 3 signal level for successful call: 5

Coordinated Universal Time is Thu Jan 28 23:43:57 1999
Connected channel LBT:3 to PBX:3

Coordinated Universal Time is Thu Jan 28 23:48:19 1999
LBT 2 signal level for successful call: 5

Coordinated Universal Time is Thu Jan 28 23:48:29 1999
Connected channel LBT:2 to PBX:2

Coordinated Universal Time is Thu Jan 28 23:48:45 1999
LBT 1 signal level for successful call: 5

Coordinated Universal Time is Thu Jan 28 23:48:57 1999
Connected channel LBT:1 to PBX:1

Coordinated Universal Time is Thu Jan 28 23:49:14 1999
LBT 4 signal level for successful call: 5

Coordinated Universal Time is Thu Jan 28 23:49:24 1999
Connected channel LBT:4 to PBX:4

Coordinated Universal Time is Thu Jan 28 23:49:39 1999
LBT 3 signal level for successful call: 5

DRAFT COPY

DRAFT COPY
NOMAD MXU Administration Manual

3:33 PM 02/12/99

Coordinated Universal Time is Thu Jan 28 23:49:49 1999
Connected channel LBT:3 to PBX:3

Coordinated Universal Time is Fri Jan 29 00:17:32 1999
Power Interrupt Values: 31

Coordinated Universal Time is Fri Jan 29 00:17:32 1999
Power Switched Off

Coordinated Universal Time is Fri Jan 29 14:37:21 1999
SC2000 version register value: 0x00

Coordinated Universal Time is Fri Jan 29 14:38:12 1999
The MXU has been powered up.

Results of Initialization:
LBT Interface startup complete. Waiting for LBT Response.
LBT Interface startup complete. Waiting for LBT Response.
LBT Interface startup complete. Waiting for LBT Response.
LBT Interface startup complete. Waiting for LBT Response.
Dialogic Channel 1 did not detect dial tone.
Dialogic Channel 2 did not detect dial tone.
Dialogic Channel 3 did not detect dial tone.
Dialogic Channel 4 did not detect dial tone.

Coordinated Universal Time is Fri Jan 29 14:38:24 1999
MODEM Successfully programmed. MODEM Identifier :V2.096-K56_2M_DLP_CSMT

Coordinated Universal Time is Fri Jan 29 14:38:25 1999
MODEM Data Pump Identifier :RC56DPF L8565A Rev 47.22/47.22

Coordinated Universal Time is Fri Jan 29 14:38:25 1999
D:\mxusrc\db\Logwrite.cpp: Opening AT from Master!

Coordinated Universal Time is Fri Jan 29 14:38:25 1999
D:\mxusrc\db\Logwrite.cpp: Opening SC from Master!

Coordinated Universal Time is Fri Jan 29 14:40:12 1999
LBT 1 is not operational

Coordinated Universal Time is Fri Jan 29 14:40:12 1999
LBT 2 is not operational

Coordinated Universal Time is Fri Jan 29 14:40:12 1999
LBT 3 is not operational

Coordinated Universal Time is Fri Jan 29 14:40:13 1999
LBT 4 is not operational

Coordinated Universal Time is Fri Jan 29 14:42:04 1999
Power Interrupt Values: 31

DRAFT COPY

DRAFT COPY
NOMAD MXU Administration Manual

3:33 PM 02/12/99

Coordinated Universal Time is Fri Jan 29 14:42:04 1999
Power Switched Off

Coordinated Universal Time is Fri Jan 29 14:44:10 1999
SC2000 version register value: 0x00

Coordinated Universal Time is Fri Jan 29 14:44:59 1999
The MXU has been powered up.

Results of Initialization:

LBT Interface startup complete. Waiting for LBT Response.
LBT Interface startup complete. Waiting for LBT Response.
LBT Interface startup complete. Waiting for LBT Response.
LBT Interface startup complete. Waiting for LBT Response.
Dialogic Channel 1 did not detect dial tone.
Dialogic Channel 2 did not detect dial tone.
Dialogic Channel 3 did not detect dial tone.
Dialogic Channel 4 did not detect dial tone.

Coordinated Universal Time is Fri Jan 29 14:45:11 1999
MODEM Successfully programmed. MODEM Identifier :V2.096-K56_2M_DLP_CSMT

Coordinated Universal Time is Fri Jan 29 14:45:11 1999
MODEM Data Pump Identifier :RC56DPF L8565A Rev 47.22/47.22

Coordinated Universal Time is Fri Jan 29 14:45:12 1999
D:\mxusrc\db\Logwrite.cpp: Opening AT from Master!

Coordinated Universal Time is Fri Jan 29 14:45:12 1999
D:\mxusrc\db\Logwrite.cpp: Opening SC from Master!

Coordinated Universal Time is Fri Jan 29 14:46:59 1999
LBT 1 is not operational

Coordinated Universal Time is Fri Jan 29 14:46:59 1999
LBT 2 is not operational

Coordinated Universal Time is Fri Jan 29 14:46:59 1999
LBT 3 is not operational

Coordinated Universal Time is Fri Jan 29 14:46:59 1999
LBT 4 is not operational

Coordinated Universal Time is Fri Jan 29 14:47:24 1999
Power Interrupt Values: 31

Coordinated Universal Time is Fri Jan 29 14:47:24 1999
Power Switched Off

Coordinated Universal Time is Fri Jan 29 14:50:35 1999
SC2000 version register value: 0x00

Coordinated Universal Time is Fri Jan 29 14:51:29 1999

DRAFT COPY

DRAFT COPY
NOMAD MXU Administration Manual

3:33 PM 02/12/99

The MXU has been powered up.

Results of Initialization:

LBT Interface startup complete. Waiting for LBT Response.
LBT Interface startup complete. Waiting for LBT Response.
LBT Interface startup complete. Waiting for LBT Response.
LBT Interface startup complete. Waiting for LBT Response.
Dialogic Channel 1 did not detect dial tone.
Dialogic Channel 2 did not detect dial tone.
Dialogic Channel 3 did not detect dial tone.
Dialogic Channel 4 did not detect dial tone.

Coordinated Universal Time is Fri Jan 29 14:51:41 1999
MODEM Successfully programmed. MODEM Identifier :V2.096-K56_2M_DLP_CSMT

Coordinated Universal Time is Fri Jan 29 14:51:41 1999
MODEM Data Pump Identifier :RC56DPF L8565A Rev 47.22/47.22

Coordinated Universal Time is Fri Jan 29 14:51:42 1999
D:\mxusrc\db\Logwrite.cpp: Opening AT from Master!

Coordinated Universal Time is Fri Jan 29 14:51:42 1999
D:\mxusrc\db\Logwrite.cpp: Opening SC from Master!

Coordinated Universal Time is Fri Jan 29 14:53:29 1999
LBT 1 is not operational

Coordinated Universal Time is Fri Jan 29 14:53:29 1999
LBT 2 is not operational

Coordinated Universal Time is Fri Jan 29 14:53:29 1999
LBT 3 is not operational

Coordinated Universal Time is Fri Jan 29 14:53:30 1999
LBT 4 is not operational

Coordinated Universal Time is Fri Jan 29 14:53:50 1999
Power Interrupt Values: 31

Coordinated Universal Time is Fri Jan 29 14:53:50 1999
Power Switched Off

Coordinated Universal Time is Fri Jan 29 14:56:18 1999
SC2000 version register value: 0x00

Coordinated Universal Time is Fri Jan 29 14:57:07 1999
The MXU has been powered up.

Results of Initialization:

LBT Interface startup complete. Waiting for LBT Response.
LBT Interface startup complete. Waiting for LBT Response.
LBT Interface startup complete. Waiting for LBT Response.
LBT Interface startup complete. Waiting for LBT Response.

DRAFT COPY

DRAFT COPY
NOMAD MXU Administration Manual

3:33 PM 02/12/99

Dialogic Channel 1 did not detect dial tone.
Dialogic Channel 2 did not detect dial tone.
Dialogic Channel 3 did not detect dial tone.
Dialogic Channel 4 did not detect dial tone.

Coordinated Universal Time is Fri Jan 29 14:57:19 1999
MODEM Successfully programmed. MODEM Identifier :V2.096-K56_2M_DLP_CSMT

Coordinated Universal Time is Fri Jan 29 14:57:20 1999
MODEM Data Pump Identifier :RC56DPF L8565A Rev 47.22/47.22

Coordinated Universal Time is Fri Jan 29 14:57:20 1999
D:\mxusrc\db\Logwrite.cpp: Opening AT from Master!

Coordinated Universal Time is Fri Jan 29 14:57:21 1999
D:\mxusrc\db\Logwrite.cpp: Opening SC from Master!

Coordinated Universal Time is Fri Jan 29 14:58:39 1999
Power Interrupt Values: 31

Coordinated Universal Time is Fri Jan 29 14:58:39 1999
Power Switched Off

Coordinated Universal Time is Fri Jan 29 15:00:47 1999
SC2000 version register value: 0x00

Coordinated Universal Time is Fri Jan 29 15:01:36 1999
The MXU has been powered up.

Results of Initialization:
LBT Interface startup complete. Waiting for LBT Response.
LBT Interface startup complete. Waiting for LBT Response.
LBT Interface startup complete. Waiting for LBT Response.
LBT Interface startup complete. Waiting for LBT Response.
Dialogic Channel 1 did not detect dial tone.
Dialogic Channel 2 did not detect dial tone.
Dialogic Channel 3 did not detect dial tone.
Dialogic Channel 4 did not detect dial tone.

Coordinated Universal Time is Fri Jan 29 15:01:48 1999
MODEM Successfully programmed. MODEM Identifier :V2.096-K56_2M_DLP_CSMT

Coordinated Universal Time is Fri Jan 29 15:01:49 1999
MODEM Data Pump Identifier :RC56DPF L8565A Rev 47.22/47.22

Coordinated Universal Time is Fri Jan 29 15:01:49 1999
D:\mxusrc\db\Logwrite.cpp: Opening AT from Master!

Coordinated Universal Time is Fri Jan 29 15:01:50 1999
D:\mxusrc\db\Logwrite.cpp: Opening SC from Master!

DRAFT COPY

DRAFT COPY
NOMAD MXU Administration Manual

3:33 PM 02/12/99

Coordinated Universal Time is Fri Jan 29 15:03:36 1999
LBT 1 is not operational

Coordinated Universal Time is Fri Jan 29 15:03:36 1999
LBT 2 is not operational

Coordinated Universal Time is Fri Jan 29 15:03:36 1999
LBT 3 is not operational

Coordinated Universal Time is Fri Jan 29 15:03:37 1999
LBT 4 is not operational

Coordinated Universal Time is Fri Jan 29 15:04:10 1999
Power Interrupt Values: 31

Coordinated Universal Time is Fri Jan 29 15:04:10 1999
Power Switched Off

Coordinated Universal Time is Fri Jan 29 15:10:15 1999
SC2000 version register value: 0x00

Coordinated Universal Time is Fri Jan 29 15:11:04 1999
The MXU has been powered up.

Results of Initialization:
LBT Interface startup complete. Waiting for LBT Response.
LBT Interface startup complete. Waiting for LBT Response.
LBT Interface startup complete. Waiting for LBT Response.
LBT Interface startup complete. Waiting for LBT Response.
Dialogic Channel 1 did not detect dial tone.
Dialogic Channel 2 did not detect dial tone.
Dialogic Channel 3 did not detect dial tone.
Dialogic Channel 4 did not detect dial tone.

Coordinated Universal Time is Fri Jan 29 15:11:18 1999
D:\mxusrc\db\Logwrite.cpp: Opening AT from Master!

Coordinated Universal Time is Fri Jan 29 15:11:18 1999
D:\mxusrc\db\Logwrite.cpp: Opening SC from Master!

Coordinated Universal Time is Fri Jan 29 15:11:19 1999
MODEM Successfully programmed. MODEM Identifier :V2.096-K56_2M_DLP_CSMT

Coordinated Universal Time is Fri Jan 29 15:11:19 1999
MODEM Data Pump Identifier :RC56DPF L8565A Rev 47.22/47.22

Coordinated Universal Time is Fri Jan 29 15:11:54 1999
Gateway connected via RS232 port.

Coordinated Universal Time is Fri Jan 29 15:13:04 1999
LBT 1 is not operational

Coordinated Universal Time is Fri Jan 29 15:13:06 1999

DRAFT COPY

DRAFT COPY
NOMAD MXU Administration Manual

3:33 PM 02/12/99

LBT 2 is not operational

Coordinated Universal Time is Fri Jan 29 15:13:06 1999
LBT 3 is not operational

Coordinated Universal Time is Fri Jan 29 15:13:06 1999
LBT 4 is not operational

Coordinated Universal Time is Fri Jan 29 15:13:07 1999
Remote Access failed to log on.

Coordinated Universal Time is Fri Jan 29 15:13:31 1999
Gateway connected via RS232 port.

Coordinated Universal Time is Fri Jan 29 15:17:53 1999
Power Interrupt Values: 31

Coordinated Universal Time is Fri Jan 29 15:17:53 1999
Power Switched Off

Coordinated Universal Time is Fri Jan 29 15:20:25 1999
SC2000 version register value: 0x00

Coordinated Universal Time is Fri Jan 29 15:21:16 1999
The MXU has been powered up.

Results of Initialization:
LBT Interface startup complete. Waiting for LBT Response.
LBT Interface startup complete. Waiting for LBT Response.
LBT Interface startup complete. Waiting for LBT Response.
LBT Interface startup complete. Waiting for LBT Response.
Dialogic Channel 1 did not detect dial tone.
Dialogic Channel 2 did not detect dial tone.
Dialogic Channel 3 did not detect dial tone.
Dialogic Channel 4 did not detect dial tone.

Coordinated Universal Time is Fri Jan 29 15:21:28 1999
MODEM Successfully programmed. MODEM Identifier :V2.096-K56_2M_DLP_CSMT

Coordinated Universal Time is Fri Jan 29 15:21:29 1999
MODEM Data Pump Identifier :RC56DPF L8565A Rev 47.22/47.22

Coordinated Universal Time is Fri Jan 29 15:21:29 1999
D:\mxusrc\db\Logwrite.cpp: Opening AT from Master!

Coordinated Universal Time is Fri Jan 29 15:21:29 1999
D:\mxusrc\db\Logwrite.cpp: Opening SC from Master!

Coordinated Universal Time is Fri Jan 29 15:23:16 1999
LBT 1 is not operational

Coordinated Universal Time is Fri Jan 29 15:23:16 1999
LBT 2 is not operational

DRAFT COPY

DRAFT COPY
NOMAD MXU Administration Manual

3:33 PM 02/12/99

Coordinated Universal Time is Fri Jan 29 15:23:16 1999
LBT 3 is not operational

Coordinated Universal Time is Fri Jan 29 15:23:17 1999
LBT 4 is not operational

Coordinated Universal Time is Fri Jan 29 15:26:46 1999
Power Interrupt Values: 31

Coordinated Universal Time is Fri Jan 29 15:26:46 1999
Power Switched Off

Coordinated Universal Time is Fri Jan 29 15:28:51 1999
SC2000 version register value: 0x00

Coordinated Universal Time is Fri Jan 29 15:29:43 1999
The MXU has been powered up.

Results of Initialization:
LBT Interface startup complete. Waiting for LBT Response.
LBT Interface startup complete. Waiting for LBT Response.
LBT Interface startup complete. Waiting for LBT Response.
LBT Interface startup complete. Waiting for LBT Response.
Dialogic Channel 1 did not detect dial tone.
Dialogic Channel 2 did not detect dial tone.
Dialogic Channel 3 did not detect dial tone.
Dialogic Channel 4 did not detect dial tone.

Coordinated Universal Time is Fri Jan 29 15:29:55 1999
MODEM Successfully programmed. MODEM Identifier :V2.096-K56_2M_DLP_CSMT

Coordinated Universal Time is Fri Jan 29 15:29:56 1999
MODEM Data Pump Identifier :RC56DPF L8565A Rev 47.22/47.22

Coordinated Universal Time is Fri Jan 29 15:29:56 1999
D:\mxusrc\db\Logwrite.cpp: Opening AT from Master!

Coordinated Universal Time is Fri Jan 29 15:29:56 1999
D:\mxusrc\db\Logwrite.cpp: Opening SC from Master!

Coordinated Universal Time is Fri Jan 29 15:31:43 1999
LBT 1 is not operational

Coordinated Universal Time is Fri Jan 29 15:31:43 1999
LBT 2 is not operational

Coordinated Universal Time is Fri Jan 29 15:31:43 1999
LBT 3 is not operational

Coordinated Universal Time is Fri Jan 29 15:31:43 1999
LBT 4 is not operational

DRAFT COPY

DRAFT COPY

NOMAD MXU Administration Manual

3:33 PM 02/12/99

Coordinated Universal Time is Fri Jan 29 16:04:51 1999
Gateway connected via RS232 port.

Coordinated Universal Time is Fri Jan 29 16:05:00 1999
Remote Connection established. Computer:MXUSITE1 User: Administrator

Coordinated Universal Time is Fri Jan 29 16:09:22 1999
Gateway connected via RS232 port.

Coordinated Universal Time is Fri Jan 29 16:09:43 1999
Remote Connection established. Computer:MXUSITE1 User: Administrator

Coordinated Universal Time is Fri Jan 29 16:14:15 1999
Power Interrupt Values: 31

Coordinated Universal Time is Fri Jan 29 16:14:15 1999
Power Switched Off

Coordinated Universal Time is Fri Jan 29 23:25:50 1999
SC2000 version register value: 0x00

Coordinated Universal Time is Fri Jan 29 23:26:39 1999
The MXU has been powered up.

Results of Initialization:
LBT Interface startup complete. Waiting for LBT Response.
LBT Interface startup complete. Waiting for LBT Response.
LBT Interface startup complete. Waiting for LBT Response.
LBT Interface startup complete. Waiting for LBT Response.
Dialogic Channel 1 did not detect dial tone.
Dialogic Channel 2 did not detect dial tone.
Dialogic Channel 3 did not detect dial tone.
Dialogic Channel 4 did not detect dial tone.

Coordinated Universal Time is Fri Jan 29 23:26:54 1999
D:\mxusrc\db\Logwrite.cpp: Opening AT from Master!

Coordinated Universal Time is Fri Jan 29 23:26:54 1999
D:\mxusrc\db\Logwrite.cpp: Opening SC from Master!

Coordinated Universal Time is Fri Jan 29 23:26:54 1999
MODEM Successfully programmed. MODEM Identifier :V2.096-K56_2M_DLP_CSMT

Coordinated Universal Time is Fri Jan 29 23:26:54 1999
MODEM Data Pump Identifier :RC56DPF L8565A Rev 47.22/47.22

Coordinated Universal Time is Fri Jan 29 23:27:01 1999
LBT 1 SW Version = 0xB6 0x01 0x03

Coordinated Universal Time is Fri Jan 29 23:28:39 1999
LBT 2 is not operational

Coordinated Universal Time is Fri Jan 29 23:28:39 1999

DRAFT COPY

DRAFT COPY
NOMAD MXU Administration Manual

3:33 PM 02/12/99

LBT 3 is not operational

Coordinated Universal Time is Fri Jan 29 23:28:39 1999
LBT 4 is not operational

Coordinated Universal Time is Fri Jan 29 23:31:38 1999
SC2000 version register value: 0x00

Coordinated Universal Time is Fri Jan 29 23:32:02 1999
The MXU has been powered up.

Results of Initialization:

LBT Interface startup complete. Waiting for LBT Response.
LBT Interface startup complete. Waiting for LBT Response.
LBT Interface startup complete. Waiting for LBT Response.
LBT Interface startup complete. Waiting for LBT Response.
Dialogic Channel 1 did not detect dial tone.
Dialogic Channel 2 did not detect dial tone.
Dialogic Channel 3 did not detect dial tone.
Dialogic Channel 4 did not detect dial tone.

Coordinated Universal Time is Fri Jan 29 23:32:16 1999
D:\mxusrc\db\Logwrite.cpp: Opening AT from Master!

Coordinated Universal Time is Fri Jan 29 23:32:16 1999
D:\mxusrc\db\Logwrite.cpp: Opening SC from Master!

Coordinated Universal Time is Fri Jan 29 23:32:24 1999
LBT 1 SW Version = 0xB6 0x01 0x03

Coordinated Universal Time is Fri Jan 29 23:34:02 1999
LBT 2 is not operational

Coordinated Universal Time is Fri Jan 29 23:34:02 1999
LBT 3 is not operational

Coordinated Universal Time is Fri Jan 29 23:34:02 1999
LBT 4 is not operational

Coordinated Universal Time is Fri Jan 29 23:34:32 1999
Power Interrupt Values: 31

Coordinated Universal Time is Fri Jan 29 23:34:42 1999
Power Interrupt Values: 31

Coordinated Universal Time is Fri Jan 29 23:34:51 1999
Power Interrupt Values: 31

Coordinated Universal Time is Fri Jan 29 23:35:01 1999
Power Interrupt Values: 31

Coordinated Universal Time is Fri Jan 29 23:37:02 1999
LBT 1 SW Version = 0x00 0x00 0x00

DRAFT COPY

DRAFT COPY
NOMAD MXU Administration Manual

3:33 PM 02/12/99

Coordinated Universal Time is Fri Jan 29 23:37:10 1999
Power Interrupt Values: 31

Coordinated Universal Time is Fri Jan 29 23:41:40 1999
SC2000 version register value: 0x00

Coordinated Universal Time is Fri Jan 29 23:42:31 1999
The MXU has been powered up.

Results of Initialization:

LBT Interface startup complete. Waiting for LBT Response.
LBT Interface startup complete. Waiting for LBT Response.
LBT Interface startup complete. Waiting for LBT Response.
LBT Interface startup complete. Waiting for LBT Response.
Dialogic Channel 1 did not detect dial tone.
Dialogic Channel 2 did not detect dial tone.
Dialogic Channel 3 did not detect dial tone.
Dialogic Channel 4 did not detect dial tone.

Coordinated Universal Time is Fri Jan 29 23:42:43 1999
MODEM Successfully programmed. MODEM Identifier :V2.096-K56_2M_DLP_CSMT

Coordinated Universal Time is Fri Jan 29 23:42:43 1999
MODEM Data Pump Identifier :RC56DPF L8565A Rev 47.22/47.22

Coordinated Universal Time is Fri Jan 29 23:42:44 1999
D:\mxusrc\db\Logwrite.cpp: Opening AT from Master!

Coordinated Universal Time is Fri Jan 29 23:42:44 1999
D:\mxusrc\db\Logwrite.cpp: Opening SC from Master!

Coordinated Universal Time is Fri Jan 29 23:42:53 1999
LBT 1 SW Version = 0xB6 0x01 0x03

Coordinated Universal Time is Fri Jan 29 23:44:31 1999
LBT 2 is not operational

Coordinated Universal Time is Fri Jan 29 23:44:31 1999
LBT 3 is not operational

Coordinated Universal Time is Fri Jan 29 23:44:31 1999
LBT 4 is not operational

Coordinated Universal Time is Fri Jan 29 23:45:15 1999
Power Interrupt Values: 31

Coordinated Universal Time is Fri Jan 29 23:45:23 1999
Power Interrupt Values: 31

Coordinated Universal Time is Fri Jan 29 23:45:30 1999
Power Interrupt Values: 31

DRAFT COPY

DRAFT COPY
NOMAD MXU Administration Manual

3:33 PM 02/12/99

Coordinated Universal Time is Fri Jan 29 23:45:35 1999
Power Interrupt Values: 31

Coordinated Universal Time is Fri Jan 29 23:46:47 1999
LBT 1 SW Version = 0x00 0x00 0x00

Coordinated Universal Time is Fri Jan 29 23:51:47 1999
LBT 1 SW Version = 0x00 0x00 0x00

Coordinated Universal Time is Fri Jan 29 23:56:48 1999
LBT 1 SW Version = 0x00 0x00 0x00

Coordinated Universal Time is Sat Jan 30 00:01:48 1999
LBT 1 SW Version = 0x00 0x00 0x00

Coordinated Universal Time is Sat Jan 30 00:06:48 1999
LBT 1 SW Version = 0x00 0x00 0x00

Coordinated Universal Time is Sat Jan 30 00:11:48 1999
LBT 1 SW Version = 0x00 0x00 0x00

Coordinated Universal Time is Sat Jan 30 00:11:50 1999
Power Interrupt Values: 31

Coordinated Universal Time is Sat Jan 30 00:30:03 1999
SC2000 version register value: 0x00

Coordinated Universal Time is Sat Jan 30 00:30:52 1999
The MXU has been powered up.

Results of Initialization:
LBT Interface startup complete. Waiting for LBT Response.
LBT Interface startup complete. Waiting for LBT Response.
LBT Interface startup complete. Waiting for LBT Response.
LBT Interface startup complete. Waiting for LBT Response.
Dialogic Channel 1 did not detect dial tone.
Dialogic Channel 2 did not detect dial tone.
Dialogic Channel 3 did not detect dial tone.
Dialogic Channel 4 did not detect dial tone.

Coordinated Universal Time is Sat Jan 30 00:31:06 1999
D:\mxu_fcc\db\Logwrite.cpp: Opening AT from Master!

Coordinated Universal Time is Sat Jan 30 00:31:06 1999
MODEM Successfully programmed. MODEM Identifier :V2.096-K56_2M_DLP_CSMT

Coordinated Universal Time is Sat Jan 30 00:31:07 1999
D:\mxu_fcc\db\Logwrite.cpp: Opening SC from Master!

Coordinated Universal Time is Sat Jan 30 00:31:07 1999
MODEM Data Pump Identifier :RC56DPF L8565A Rev 47.22/47.22

Coordinated Universal Time is Sat Jan 30 00:31:14 1999

DRAFT COPY

DRAFT COPY

NOMAD MXU Administration Manual

3:33 PM 02/12/99

LBT 1 SW Version = 0xB6 0x01 0x03

Coordinated Universal Time is Sat Jan 30 00:31:47 1999
LBT:1 is now ready for calls.

Coordinated Universal Time is Sat Jan 30 00:32:52 1999
LBT 2 is not operational

Coordinated Universal Time is Sat Jan 30 00:32:52 1999
LBT 3 is not operational

Coordinated Universal Time is Sat Jan 30 00:32:52 1999
LBT 4 is not operational

Coordinated Universal Time is Sat Jan 30 00:33:20 1999
Power Interrupt Values: 31

Coordinated Universal Time is Sat Jan 30 00:33:24 1999
Power Interrupt Values: 31

Coordinated Universal Time is Sat Jan 30 00:33:28 1999
Power Interrupt Values: 31

Coordinated Universal Time is Sat Jan 30 00:35:42 1999
Power Interrupt Values: 31

Coordinated Universal Time is Sat Jan 30 00:35:46 1999
Power Interrupt Values: 31

Coordinated Universal Time is Sat Jan 30 00:35:50 1999
Power Interrupt Values: 31

Coordinated Universal Time is Sat Jan 30 00:36:42 1999
Power Interrupt Values: 31

Coordinated Universal Time is Sat Jan 30 00:39:22 1999
Power Interrupt Values: 31

Coordinated Universal Time is Sat Jan 30 00:42:56 1999
SC2000 version register value: 0x00

Coordinated Universal Time is Sat Jan 30 00:46:21 1999
SC2000 version register value: 0x00

Coordinated Universal Time is Sat Jan 30 00:47:13 1999
The MXU has been powered up.

Results of Initialization:

LBT Interface startup complete. Waiting for LBT Response.
LBT Interface startup complete. Waiting for LBT Response.
LBT Interface startup complete. Waiting for LBT Response.
LBT Interface startup complete. Waiting for LBT Response.
Dialogic Channel 1 did not detect dial tone.
Dialogic Channel 2 did not detect dial tone.
Dialogic Channel 3 did not detect dial tone.

DRAFT COPY

DRAFT COPY
NOMAD MXU Administration Manual

3:33 PM 02/12/99

Dialogic Channel 4 did not detect dial tone.

Coordinated Universal Time is Sat Jan 30 00:47:25 1999
MODEM Successfully programmed. MODEM Identifier :V2.096-K56_2M_DLP_CSMT

Coordinated Universal Time is Sat Jan 30 00:47:25 1999
MODEM Data Pump Identifier :RC56DPF L8565A Rev 47.22/47.22

Coordinated Universal Time is Sat Jan 30 00:47:26 1999
D:\mxu_fcc\db\Logwrite.cpp: Opening AT from Master!

Coordinated Universal Time is Sat Jan 30 00:47:26 1999
D:\mxu_fcc\db\Logwrite.cpp: Opening SC from Master!

Coordinated Universal Time is Sat Jan 30 00:49:13 1999
LBT 1 is not operational

Coordinated Universal Time is Sat Jan 30 00:49:13 1999
LBT 2 is not operational

Coordinated Universal Time is Sat Jan 30 00:49:13 1999
LBT 3 is not operational

Coordinated Universal Time is Sat Jan 30 00:49:14 1999
LBT 4 is not operational

Coordinated Universal Time is Sat Jan 30 00:49:41 1999
Power Interrupt Values: 31

Coordinated Universal Time is Sat Jan 30 00:50:50 1999
Power Interrupt Values: 31

Coordinated Universal Time is Sat Jan 30 00:50:55 1999
Power Interrupt Values: 31

Coordinated Universal Time is Sat Jan 30 00:50:59 1999
Power Interrupt Values: 31

Coordinated Universal Time is Sat Jan 30 00:51:07 1999
LBT 1 SW Version = 0xB6 0x01 0x03

Coordinated Universal Time is Sat Jan 30 00:51:14 1999
LBT:1 is now ready for calls.

Coordinated Universal Time is Sat Jan 30 00:55:23 1999
SC2000 version register value: 0x00

Coordinated Universal Time is Sat Jan 30 00:56:12 1999
The MXU has been powered up.

Results of Initialization:
LBT Interface startup complete. Waiting for LBT Response.
LBT Interface startup complete. Waiting for LBT Response.

DRAFT COPY

DRAFT COPY

NOMAD MXU Administration Manual

3:33 PM 02/12/99

LBT Interface startup complete. Waiting for LBT Response.
LBT Interface startup complete. Waiting for LBT Response.
Dialogic Channel 1 did not detect dial tone.
Dialogic Channel 2 did not detect dial tone.
Dialogic Channel 3 did not detect dial tone.
Dialogic Channel 4 did not detect dial tone.

Coordinated Universal Time is Sat Jan 30 00:56:24 1999
MODEM Successfully programmed. MODEM Identifier :V2.096-K56_2M_DLP_CSMT

Coordinated Universal Time is Sat Jan 30 00:56:25 1999
MODEM Data Pump Identifier :RC56DPF L8565A Rev 47.22/47.22

Coordinated Universal Time is Sat Jan 30 00:56:25 1999
D:\mxu_fcc\db\Logwrite.cpp: Opening AT from Master!

Coordinated Universal Time is Sat Jan 30 00:56:26 1999
D:\mxu_fcc\db\Logwrite.cpp: Opening SC from Master!

Coordinated Universal Time is Sat Jan 30 00:56:34 1999
LBT 1 SW Version = 0xB6 0x01 0x03

Coordinated Universal Time is Sat Jan 30 00:56:41 1999
LBT:1 is now ready for calls.

Coordinated Universal Time is Sat Jan 30 00:58:12 1999
LBT 2 is not operational

Coordinated Universal Time is Sat Jan 30 00:58:12 1999
LBT 3 is not operational

Coordinated Universal Time is Sat Jan 30 00:58:12 1999
LBT 4 is not operational

Coordinated Universal Time is Sat Jan 30 00:59:51 1999
Power Interrupt Values: 31

Coordinated Universal Time is Mon Feb 01 16:16:14 1999
Power Interrupt Values: 31

Coordinated Universal Time is Mon Feb 01 16:16:19 1999
Power Interrupt Values: 31

Coordinated Universal Time is Tue Feb 02 18:56:01 1999
SC2000 version register value: 0x00

Coordinated Universal Time is Tue Feb 02 18:56:50 1999
The MXU has been powered up.

Results of Initialization:
LBT Interface startup complete. Waiting for LBT Response.
LBT Interface startup complete. Waiting for LBT Response.
LBT Interface startup complete. Waiting for LBT Response.

DRAFT COPY

DRAFT COPY
NOMAD MXU Administration Manual

3:33 PM 02/12/99

LBT Interface startup complete. Waiting for LBT Response.
Dialogic Channel 1 did not detect dial tone.
Dialogic Channel 2 did not detect dial tone.
Dialogic Channel 3 did not detect dial tone.
Dialogic Channel 4 did not detect dial tone.

Coordinated Universal Time is Tue Feb 02 18:57:05 1999
D:\mxu_fcc\db\Logwrite.cpp: Opening AT from Master!

Coordinated Universal Time is Tue Feb 02 18:57:05 1999
MODEM Successfully programmed. MODEM Identifier :V2.096-K56_2M_DLP_CSMT

Coordinated Universal Time is Tue Feb 02 18:57:05 1999
D:\mxu_fcc\db\Logwrite.cpp: Opening SC from Master!

Coordinated Universal Time is Tue Feb 02 18:57:05 1999
MODEM Data Pump Identifier :RC56DPF L8565A Rev 47.22/47.22

Coordinated Universal Time is Tue Feb 02 18:58:44 1999
LBT 4 SW Version = 0xB6 0x01 0x03

Coordinated Universal Time is Tue Feb 02 18:58:50 1999
LBT 1 is not operational

Coordinated Universal Time is Tue Feb 02 18:58:50 1999
LBT 2 is not operational

Coordinated Universal Time is Tue Feb 02 18:58:50 1999
LBT 3 is not operational

Coordinated Universal Time is Tue Feb 02 18:58:53 1999
LBT:4 is now ready for calls.

Coordinated Universal Time is Tue Feb 02 19:15:03 1999
SC2000 version register value: 0x00

Coordinated Universal Time is Tue Feb 02 19:15:27 1999
The MXU has been powered up.

Results of Initialization:
LBT Interface startup complete. Waiting for LBT Response.
LBT Interface startup complete. Waiting for LBT Response.
LBT Interface startup complete. Waiting for LBT Response.
LBT Interface startup complete. Waiting for LBT Response.
Dialogic Channel 1 did not detect dial tone.
Dialogic Channel 2 did not detect dial tone.
Dialogic Channel 3 did not detect dial tone.
Dialogic Channel 4 did not detect dial tone.

Coordinated Universal Time is Tue Feb 02 19:15:41 1999
D:\mxu_fcc\db\Logwrite.cpp: Opening AT from Master!

DRAFT COPY

DRAFT COPY
NOMAD MXU Administration Manual

3:33 PM 02/12/99

Coordinated Universal Time is Tue Feb 02 19:15:41 1999
D:\mxu_fcc\db\Logwrite.cpp: Opening SC from Master!

Coordinated Universal Time is Tue Feb 02 19:17:21 1999
LBT 4 SW Version = 0xB6 0x01 0x03

Coordinated Universal Time is Tue Feb 02 19:17:27 1999
LBT 1 is not operational

Coordinated Universal Time is Tue Feb 02 19:17:27 1999
LBT 2 is not operational

Coordinated Universal Time is Tue Feb 02 19:17:27 1999
LBT 3 is not operational

Coordinated Universal Time is Tue Feb 02 19:17:30 1999
LBT:4 is now ready for calls.

Coordinated Universal Time is Tue Feb 02 19:18:09 1999
Power Interrupt Values: 31

Coordinated Universal Time is Tue Feb 02 19:19:26 1999
Power Interrupt Values: 31

Coordinated Universal Time is Tue Feb 02 19:19:48 1999
Power Interrupt Values: 31

Coordinated Universal Time is Tue Feb 02 19:21:04 1999
Power Interrupt Values: 31

Coordinated Universal Time is Tue Feb 02 19:22:21 1999
Power Interrupt Values: 31

Coordinated Universal Time is Tue Feb 02 20:05:57 1999
SC2000 version register value: 0x00

Coordinated Universal Time is Tue Feb 02 20:06:20 1999
The MXU has been powered up.

Results of Initialization:
LBT Interface startup complete. Waiting for LBT Response.
LBT Interface startup complete. Waiting for LBT Response.
LBT Interface startup complete. Waiting for LBT Response.
LBT Interface startup complete. Waiting for LBT Response.
Dialogic Channel 1 did not detect dial tone.
Dialogic Channel 2 did not detect dial tone.
Dialogic Channel 3 did not detect dial tone.
Dialogic Channel 4 did not detect dial tone.

Coordinated Universal Time is Tue Feb 02 20:06:35 1999
D:\mxu_fcc\db\Logwrite.cpp: Opening AT from Master!

DRAFT COPY

DRAFT COPY
NOMAD MXU Administration Manual

3:33 PM 02/12/99

Coordinated Universal Time is Tue Feb 02 20:06:35 1999
D:\mxu_fcc\db\Logwrite.cpp: Opening SC from Master!

Coordinated Universal Time is Tue Feb 02 20:08:15 1999
LBT 4 SW Version = 0xB6 0x01 0x03

Coordinated Universal Time is Tue Feb 02 20:08:20 1999
LBT 1 is not operational

Coordinated Universal Time is Tue Feb 02 20:08:20 1999
LBT 2 is not operational

Coordinated Universal Time is Tue Feb 02 20:08:20 1999
LBT 3 is not operational

Coordinated Universal Time is Tue Feb 02 20:08:24 1999
LBT:4 is now ready for calls.

Coordinated Universal Time is Tue Feb 02 22:12:07 1999
SC2000 version register value: 0x00

Coordinated Universal Time is Tue Feb 02 22:12:31 1999
The MXU has been powered up.

Results of Initialization:
LBT Interface startup complete. Waiting for LBT Response.
LBT Interface startup complete. Waiting for LBT Response.
LBT Interface startup complete. Waiting for LBT Response.
LBT Interface startup complete. Waiting for LBT Response.
Dialogic Channel 1 did not detect dial tone.
Dialogic Channel 2 did not detect dial tone.
Dialogic Channel 3 did not detect dial tone.
Dialogic Channel 4 did not detect dial tone.

Coordinated Universal Time is Tue Feb 02 22:12:45 1999
D:\mxu_fcc\db\Logwrite.cpp: Opening AT from Master!

Coordinated Universal Time is Tue Feb 02 22:12:46 1999
D:\mxu_fcc\db\Logwrite.cpp: Opening SC from Master!

Coordinated Universal Time is Tue Feb 02 22:14:25 1999
LBT 4 SW Version = 0xB6 0x01 0x03

Coordinated Universal Time is Tue Feb 02 22:14:31 1999
LBT 1 is not operational

Coordinated Universal Time is Tue Feb 02 22:14:31 1999
LBT 2 is not operational

Coordinated Universal Time is Tue Feb 02 22:14:31 1999
LBT 3 is not operational

Coordinated Universal Time is Tue Feb 02 22:14:34 1999

DRAFT COPY

DRAFT COPY
NOMAD MXU Administration Manual

3:33 PM 02/12/99

LBT:4 is now ready for calls.

Coordinated Universal Time is Wed Feb 03 16:57:00 1999
SC2000 version register value: 0x00

Coordinated Universal Time is Wed Feb 03 16:57:24 1999
The MXU has been powered up.

Results of Initialization:

LBT Interface startup complete. Waiting for LBT Response.
LBT Interface startup complete. Waiting for LBT Response.
LBT Interface startup complete. Waiting for LBT Response.
LBT Interface startup complete. Waiting for LBT Response.
Dialogic Channel 1 did not detect dial tone.
Dialogic Channel 2 did not detect dial tone.
Dialogic Channel 3 did not detect dial tone.
Dialogic Channel 4 did not detect dial tone.

Coordinated Universal Time is Wed Feb 03 16:57:38 1999
D:\mxu_fcc\db\Logwrite.cpp: Opening AT from Master!

Coordinated Universal Time is Wed Feb 03 16:57:38 1999
D:\mxu_fcc\db\Logwrite.cpp: Opening SC from Master!

Coordinated Universal Time is Wed Feb 03 16:58:19 1999
Gateway connected via RS232 port.

Coordinated Universal Time is Wed Feb 03 16:59:18 1999
LBT 4 SW Version = 0xB6 0x01 0x03

Coordinated Universal Time is Wed Feb 03 16:59:28 1999
LBT 1 is not operational

Coordinated Universal Time is Wed Feb 03 16:59:28 1999
LBT 2 is not operational

Coordinated Universal Time is Wed Feb 03 16:59:33 1999
LBT 3 is not operational

Coordinated Universal Time is Wed Feb 03 16:59:50 1999
Remote Access failed to log on.

Coordinated Universal Time is Wed Feb 03 17:00:08 1999
Gateway connected via RS232 port.

Coordinated Universal Time is Wed Feb 03 17:00:14 1999
LBT:4 is now ready for calls.

Coordinated Universal Time is Wed Feb 03 17:00:23 1999
Power Interrupt Values: 31

Coordinated Universal Time is Wed Feb 03 17:01:41 1999
SC2000 version register value: 0x00

DRAFT COPY

DRAFT COPY
NOMAD MXU Administration Manual

3:33 PM 02/12/99

Coordinated Universal Time is Wed Feb 03 17:01:44 1999
The MXU has been powered up.

Results of Initialization:
LBT Interface startup complete. Waiting for LBT Response.
LBT Interface startup complete. Waiting for LBT Response.
LBT Interface startup complete. Waiting for LBT Response.
LBT Interface startup complete. Waiting for LBT Response.
Dialogic Channel 1 did not detect dial tone.
Dialogic Channel 2 did not detect dial tone.
Dialogic Channel 3 did not detect dial tone.
Dialogic Channel 4 did not detect dial tone.

Coordinated Universal Time is Wed Feb 03 17:02:14 1999
SC2000 version register value: 0x00

Coordinated Universal Time is Wed Feb 03 17:02:38 1999
The MXU has been powered up.

Results of Initialization:
LBT Interface startup complete. Waiting for LBT Response.
LBT Interface startup complete. Waiting for LBT Response.
LBT Interface startup complete. Waiting for LBT Response.
LBT Interface startup complete. Waiting for LBT Response.
Dialogic Channel 1 did not detect dial tone.
Dialogic Channel 2 did not detect dial tone.
Dialogic Channel 3 did not detect dial tone.
Dialogic Channel 4 did not detect dial tone.

Coordinated Universal Time is Wed Feb 03 17:02:52 1999
D:\mxu_fcc\db\Logwrite.cpp: Opening AT from Master!

Coordinated Universal Time is Wed Feb 03 17:02:53 1999
D:\mxu_fcc\db\Logwrite.cpp: Opening SC from Master!

Coordinated Universal Time is Wed Feb 03 17:03:12 1999
Gateway connected via RS232 port.

Coordinated Universal Time is Wed Feb 03 17:06:48 1999
SC2000 version register value: 0x00

Coordinated Universal Time is Wed Feb 03 17:07:40 1999
The MXU has been powered up.

Results of Initialization:
LBT Interface startup complete. Waiting for LBT Response.
LBT Interface startup complete. Waiting for LBT Response.
LBT Interface startup complete. Waiting for LBT Response.
LBT Interface startup complete. Waiting for LBT Response.
Dialogic Channel 1 did not detect dial tone.

DRAFT COPY

DRAFT COPY
NOMAD MXU Administration Manual

3:33 PM 02/12/99

Dialogic Channel 2 did not detect dial tone.
Dialogic Channel 3 did not detect dial tone.
Dialogic Channel 4 did not detect dial tone.

Coordinated Universal Time is Wed Feb 03 17:07:55 1999
D:\mxu_fcc\db\Logwrite.cpp: Opening AT from Master!

Coordinated Universal Time is Wed Feb 03 17:07:55 1999
D:\mxu_fcc\db\Logwrite.cpp: Opening SC from Master!

Coordinated Universal Time is Wed Feb 03 17:07:55 1999
MODEM Successfully programmed. MODEM Identifier :V2.096-K56_2M_DLP_CSMT

Coordinated Universal Time is Wed Feb 03 17:07:55 1999
MODEM Data Pump Identifier :RC56DPF L8565A Rev 47.22/47.22

Coordinated Universal Time is Wed Feb 03 17:08:30 1999
Gateway connected via RS232 port.

Coordinated Universal Time is Wed Feb 03 17:09:34 1999
LBT 4 SW Version = 0xB6 0x01 0x03

Coordinated Universal Time is Wed Feb 03 17:09:40 1999
LBT 1 is not operational

Coordinated Universal Time is Wed Feb 03 17:09:44 1999
LBT 2 is not operational

Coordinated Universal Time is Wed Feb 03 17:09:44 1999
LBT 3 is not operational

Coordinated Universal Time is Wed Feb 03 17:09:44 1999
LBT 4 is not operational

Coordinated Universal Time is Wed Feb 03 17:10:06 1999
Remote Access failed to log on.

Coordinated Universal Time is Wed Feb 03 17:10:24 1999
Gateway connected via RS232 port.

Coordinated Universal Time is Wed Feb 03 17:10:33 1999
LBT:4 is now ready for calls.

Coordinated Universal Time is Wed Feb 03 17:10:49 1999
Power Interrupt Values: 31

Coordinated Universal Time is Wed Feb 03 17:11:02 1999
Power Interrupt Values: 31

Coordinated Universal Time is Wed Feb 03 17:11:14 1999
Power Interrupt Values: 31

Coordinated Universal Time is Wed Feb 03 17:11:25 1999

DRAFT COPY

DRAFT COPY
NOMAD MXU Administration Manual

3:33 PM 02/12/99

Power Interrupt Values: 31

Coordinated Universal Time is Wed Feb 03 17:11:50 1999
Power Interrupt Values: 31

Coordinated Universal Time is Wed Feb 03 17:11:55 1999
Remote Access failed to log on.

Coordinated Universal Time is Wed Feb 03 17:12:16 1999
Gateway connected via RS232 port.

Coordinated Universal Time is Wed Feb 03 17:13:39 1999
SC2000 version register value: 0x00

Coordinated Universal Time is Wed Feb 03 17:13:43 1999
The MXU has been powered up.

Results of Initialization:
LBT Interface startup complete. Waiting for LBT Response.
LBT Interface startup complete. Waiting for LBT Response.
LBT Interface startup complete. Waiting for LBT Response.
LBT Interface startup complete. Waiting for LBT Response.
Dialogic Channel 1 did not detect dial tone.
Dialogic Channel 2 did not detect dial tone.
Dialogic Channel 3 did not detect dial tone.
Dialogic Channel 4 did not detect dial tone.

Coordinated Universal Time is Wed Feb 03 17:14:19 1999
SC2000 version register value: 0x00

Coordinated Universal Time is Wed Feb 03 17:14:43 1999
The MXU has been powered up.

Results of Initialization:
LBT Interface startup complete. Waiting for LBT Response.
LBT Interface startup complete. Waiting for LBT Response.
LBT Interface startup complete. Waiting for LBT Response.
LBT Interface startup complete. Waiting for LBT Response.
Dialogic Channel 1 did not detect dial tone.
Dialogic Channel 2 did not detect dial tone.
Dialogic Channel 3 did not detect dial tone.
Dialogic Channel 4 did not detect dial tone.

Coordinated Universal Time is Wed Feb 03 17:14:57 1999
D:\mxu_fcc\db\Logwrite.cpp: Opening AT from Master!

Coordinated Universal Time is Wed Feb 03 17:14:57 1999
D:\mxu_fcc\db\Logwrite.cpp: Opening SC from Master!

Coordinated Universal Time is Wed Feb 03 17:16:37 1999
LBT 4 SW Version = 0xB6 0x01 0x03

DRAFT COPY

DRAFT COPY
NOMAD MXU Administration Manual

3:33 PM 02/12/99

Coordinated Universal Time is Wed Feb 03 17:16:43 1999
LBT 1 is not operational

Coordinated Universal Time is Wed Feb 03 17:16:43 1999
LBT 2 is not operational

Coordinated Universal Time is Wed Feb 03 17:16:43 1999
LBT 3 is not operational

Coordinated Universal Time is Wed Feb 03 17:16:46 1999
LBT:4 is now ready for calls.

Coordinated Universal Time is Wed Feb 03 17:44:06 1999
SC2000 version register value: 0x00

Coordinated Universal Time is Wed Feb 03 17:49:34 1999
SC2000 version register value: 0x00

Coordinated Universal Time is Wed Feb 03 17:50:23 1999
The MXU has been powered up.

Results of Initialization:
LBT Interface startup complete. Waiting for LBT Response.
LBT Interface startup complete. Waiting for LBT Response.
LBT Interface startup complete. Waiting for LBT Response.
LBT Interface startup complete. Waiting for LBT Response.
Dialogic Channel 1 did not detect dial tone.
Dialogic Channel 2 did not detect dial tone.
Dialogic Channel 3 did not detect dial tone.
Dialogic Channel 4 did not detect dial tone.

Coordinated Universal Time is Wed Feb 03 17:50:35 1999
MODEM Successfully programmed. MODEM Identifier :V2.096-K56_2M_DLP_CSMT

Coordinated Universal Time is Wed Feb 03 17:50:35 1999
MODEM Data Pump Identifier :RC56DPF L8565A Rev 47.22/47.22

Coordinated Universal Time is Wed Feb 03 17:50:36 1999
D:\mxu_fcc\db\Logwrite.cpp: Opening AT from Master!

Coordinated Universal Time is Wed Feb 03 17:50:36 1999
D:\mxu_fcc\db\Logwrite.cpp: Opening SC from Master!

Coordinated Universal Time is Wed Feb 03 17:52:17 1999
LBT 4 SW Version = 0xB6 0x01 0x03

Coordinated Universal Time is Wed Feb 03 17:52:23 1999
LBT 1 is not operational

Coordinated Universal Time is Wed Feb 03 17:52:23 1999
LBT 2 is not operational

DRAFT COPY

DRAFT COPY
NOMAD MXU Administration Manual

3:33 PM 02/12/99

Coordinated Universal Time is Wed Feb 03 17:52:23 1999
LBT 3 is not operational

Coordinated Universal Time is Wed Feb 03 17:52:26 1999
LBT:4 is now ready for calls.

Coordinated Universal Time is Wed Feb 03 17:52:55 1999
Power Interrupt Values: 31

Coordinated Universal Time is Wed Feb 03 17:53:06 1999
Power Interrupt Values: 31

Coordinated Universal Time is Wed Feb 03 17:54:04 1999
Power Interrupt Values: 31

Coordinated Universal Time is Wed Feb 03 17:55:26 1999
Power Interrupt Values: 31

Coordinated Universal Time is Wed Feb 03 17:56:00 1999
Power Interrupt Values: 31

Coordinated Universal Time is Wed Feb 03 17:58:53 1999
SC2000 version register value: 0x00

Coordinated Universal Time is Wed Feb 03 17:59:16 1999
The MXU has been powered up.

Results of Initialization:
LBT Interface startup complete. Waiting for LBT Response.
LBT Interface startup complete. Waiting for LBT Response.
LBT Interface startup complete. Waiting for LBT Response.
LBT Interface startup complete. Waiting for LBT Response.
Dialogic Channel 1 did not detect dial tone.
Dialogic Channel 2 did not detect dial tone.
Dialogic Channel 3 did not detect dial tone.
Dialogic Channel 4 did not detect dial tone.

Coordinated Universal Time is Wed Feb 03 17:59:31 1999
D:\mxu_fcc\db\Logwrite.cpp: Opening AT from Master!

Coordinated Universal Time is Wed Feb 03 17:59:31 1999
D:\mxu_fcc\db\Logwrite.cpp: Opening SC from Master!

Coordinated Universal Time is Wed Feb 03 18:01:11 1999
LBT 4 SW Version = 0xB6 0x01 0x03

Coordinated Universal Time is Wed Feb 03 18:01:16 1999
LBT 1 is not operational

Coordinated Universal Time is Wed Feb 03 18:01:16 1999
LBT 2 is not operational

Coordinated Universal Time is Wed Feb 03 18:01:17 1999

DRAFT COPY

DRAFT COPY
NOMAD MXU Administration Manual

3:33 PM 02/12/99

LBT 3 is not operational

Coordinated Universal Time is Wed Feb 03 18:01:19 1999
LBT:4 is now ready for calls.

Coordinated Universal Time is Wed Feb 03 22:07:30 1999
SC2000 version register value: 0x00

Coordinated Universal Time is Wed Feb 03 22:08:21 1999
The MXU has been powered up.

Results of Initialization:

LBT Interface startup complete. Waiting for LBT Response.
LBT Interface startup complete. Waiting for LBT Response.
LBT Interface startup complete. Waiting for LBT Response.
LBT Interface startup complete. Waiting for LBT Response.
Dialogic Channel 1 did not detect dial tone.
Dialogic Channel 2 did not detect dial tone.
Dialogic Channel 3 did not detect dial tone.
Dialogic Channel 4 did not detect dial tone.

Coordinated Universal Time is Wed Feb 03 22:10:51 1999
SC2000 version register value: 0x00

Coordinated Universal Time is Wed Feb 03 22:11:15 1999
The MXU has been powered up.

Results of Initialization:

LBT Interface startup complete. Waiting for LBT Response.
LBT Interface startup complete. Waiting for LBT Response.
LBT Interface startup complete. Waiting for LBT Response.
LBT Interface startup complete. Waiting for LBT Response.
Dialogic Channel 1 did not detect dial tone.
Dialogic Channel 2 did not detect dial tone.
Dialogic Channel 3 did not detect dial tone.
Dialogic Channel 4 did not detect dial tone.

Coordinated Universal Time is Wed Feb 03 22:11:29 1999
D:\mxu_fcc\db\Logwrite.cpp: Opening AT from Master!

Coordinated Universal Time is Wed Feb 03 22:11:30 1999
D:\mxu_fcc\db\Logwrite.cpp: Opening SC from Master!

Coordinated Universal Time is Wed Feb 03 22:13:09 1999
LBT 4 SW Version = 0xB6 0x01 0x03

Coordinated Universal Time is Wed Feb 03 22:13:15 1999
LBT 1 is not operational

Coordinated Universal Time is Wed Feb 03 22:13:15 1999
LBT 2 is not operational

DRAFT COPY

DRAFT COPY
NOMAD MXU Administration Manual

3:33 PM 02/12/99

Coordinated Universal Time is Wed Feb 03 22:13:15 1999
LBT 3 is not operational

Coordinated Universal Time is Wed Feb 03 22:13:18 1999
LBT:4 is now ready for calls.

Coordinated Universal Time is Wed Feb 03 22:22:19 1999
SC2000 version register value: 0x00

Coordinated Universal Time is Wed Feb 03 22:23:39 1999
SC2000 version register value: 0x00

Coordinated Universal Time is Wed Feb 03 22:24:02 1999
The MXU has been powered up.

Results of Initialization:
LBT Interface startup complete. Waiting for LBT Response.
LBT Interface startup complete. Waiting for LBT Response.
LBT Interface startup complete. Waiting for LBT Response.
LBT Interface startup complete. Waiting for LBT Response.
Dialogic Channel 1 did not detect dial tone.
Dialogic Channel 2 did not detect dial tone.
Dialogic Channel 3 did not detect dial tone.
Dialogic Channel 4 did not detect dial tone.

Coordinated Universal Time is Wed Feb 03 22:24:17 1999
D:\mxu_fcc\db\Logwrite.cpp: Opening AT from Master!

Coordinated Universal Time is Wed Feb 03 22:24:17 1999
D:\mxu_fcc\db\Logwrite.cpp: Opening SC from Master!

Coordinated Universal Time is Wed Feb 03 22:25:57 1999
LBT 4 SW Version = 0xB6 0x01 0x03

Coordinated Universal Time is Wed Feb 03 22:26:02 1999
LBT 1 is not operational

Coordinated Universal Time is Wed Feb 03 22:26:02 1999
LBT 2 is not operational

Coordinated Universal Time is Wed Feb 03 22:26:02 1999
LBT 3 is not operational

Coordinated Universal Time is Wed Feb 03 22:26:06 1999
LBT:4 is now ready for calls.

NOTICE: This file has been newly created. This means:
(1) The MXU may be new.
(2) Log files may have been cleared manually or by a Gateway command.

DRAFT COPY

DRAFT COPY
NOMAD MXU Administration Manual

3:33 PM 02/12/99

(3) Backup files may have just been created.
(4) Both redundant files of this log may have been corrupted.
In the last case, if this is an Error (Diagnostics) Log, all data is also in the Activity Log. If this is an Activity Log, data entries MAY HAVE BEEN LOST.

Coordinated Universal Time is Thu Jan 28 15:58:40 1999
The MXU has been powered up.

Results of Initialization:
LBT Interface startup complete. Waiting for LBT Response.
LBT Interface startup complete. Waiting for LBT Response.
LBT Interface startup complete. Waiting for LBT Response.
LBT Interface startup complete. Waiting for LBT Response.
Dialogic Channel 1 is available.
Dialogic Channel 2 is available.
Dialogic Channel 3 is available.
Dialogic Channel 4 did not detect dial tone.

Coordinated Universal Time is Thu Jan 28 15:59:46 1999
The MXU has been powered up.

Results of Initialization:
LBT Interface startup complete. Waiting for LBT Response.
LBT Interface startup complete. Waiting for LBT Response.
LBT Interface startup complete. Waiting for LBT Response.
LBT Interface startup complete. Waiting for LBT Response.
Dialogic Channel 1 is available.
Dialogic Channel 2 is available.
Dialogic Channel 3 is available.
Dialogic Channel 4 did not detect dial tone.

Coordinated Universal Time is Thu Jan 28 16:00:01 1999
D:\mxusrc\db\Logwrite.cpp: Opening AT from Master!

Coordinated Universal Time is Thu Jan 28 16:00:01 1999
D:\mxusrc\db\Logwrite.cpp: Opening SC from Master!

Coordinated Universal Time is Thu Jan 28 16:09:47 1999
The MXU has been powered up.

Results of Initialization:
LBT Interface startup complete. Waiting for LBT Response.
LBT Interface startup complete. Waiting for LBT Response.
LBT Interface startup complete. Waiting for LBT Response.
LBT Interface startup complete. Waiting for LBT Response.
Dialogic Channel 1 is available.
Dialogic Channel 2 is available.
Dialogic Channel 3 is available.
Dialogic Channel 4 did not detect dial tone.

DRAFT COPY

DRAFT COPY
NOMAD MXU Administration Manual

3:33 PM 02/12/99

Coordinated Universal Time is Thu Jan 28 16:10:01 1999
D:\mxusrc\db\Logwrite.cpp: Opening AT from Master!

Coordinated Universal Time is Thu Jan 28 16:10:02 1999
D:\mxusrc\db\Logwrite.cpp: Opening SC from Master!

Coordinated Universal Time is Thu Jan 28 16:11:54 1999
The MXU has been powered up.

Results of Initialization:
LBT Interface startup complete. Waiting for LBT Response.
LBT Interface startup complete. Waiting for LBT Response.
LBT Interface startup complete. Waiting for LBT Response.
LBT Interface startup complete. Waiting for LBT Response.
Dialogic Channel 1 is available.
Dialogic Channel 2 is available.
Dialogic Channel 3 is available.
Dialogic Channel 4 did not detect dial tone.

Coordinated Universal Time is Thu Jan 28 16:12:08 1999
D:\mxusrc\db\Logwrite.cpp: Opening AT from Master!

Coordinated Universal Time is Thu Jan 28 16:12:09 1999
D:\mxusrc\db\Logwrite.cpp: Opening SC from Master!

Coordinated Universal Time is Thu Jan 28 16:18:30 1999
The MXU has been powered up.

Results of Initialization:
LBT Interface startup complete. Waiting for LBT Response.
LBT Interface startup complete. Waiting for LBT Response.
LBT Interface startup complete. Waiting for LBT Response.
LBT Interface startup complete. Waiting for LBT Response.
Dialogic Channel 1 is available.
Dialogic Channel 2 is available.
Dialogic Channel 3 is available.
Dialogic Channel 4 did not detect dial tone.

Coordinated Universal Time is Thu Jan 28 16:18:45 1999
D:\mxusrc\db\Logwrite.cpp: Opening AT from Master!

Coordinated Universal Time is Thu Jan 28 16:18:45 1999
D:\mxusrc\db\Logwrite.cpp: Opening SC from Master!

Coordinated Universal Time is Thu Jan 28 23:33:05 1999
The MXU has been powered up.

Results of Initialization:
LBT Interface startup complete. Waiting for LBT Response.

DRAFT COPY

DRAFT COPY
NOMAD MXU Administration Manual

3:33 PM 02/12/99

LBT Interface startup complete. Waiting for LBT Response.
LBT Interface startup complete. Waiting for LBT Response.
LBT Interface startup complete. Waiting for LBT Response.
Dialogic Channel 1 is available.
Dialogic Channel 2 is available.
Dialogic Channel 3 is available.
Dialogic Channel 4 did not detect dial tone.

Coordinated Universal Time is Thu Jan 28 23:33:18 1999
D:\mxusrc\db\Logwrite.cpp: Opening AT from Master!

Coordinated Universal Time is Thu Jan 28 23:33:19 1999
D:\mxusrc\db\Logwrite.cpp: Opening SC from Master!

Coordinated Universal Time is Fri Jan 29 14:38:12 1999
The MXU has been powered up.

Results of Initialization:
LBT Interface startup complete. Waiting for LBT Response.
LBT Interface startup complete. Waiting for LBT Response.
LBT Interface startup complete. Waiting for LBT Response.
LBT Interface startup complete. Waiting for LBT Response.
Dialogic Channel 1 did not detect dial tone.
Dialogic Channel 2 did not detect dial tone.
Dialogic Channel 3 did not detect dial tone.
Dialogic Channel 4 did not detect dial tone.

Coordinated Universal Time is Fri Jan 29 14:38:25 1999
D:\mxusrc\db\Logwrite.cpp: Opening AT from Master!

Coordinated Universal Time is Fri Jan 29 14:38:25 1999
D:\mxusrc\db\Logwrite.cpp: Opening SC from Master!

Coordinated Universal Time is Fri Jan 29 14:44:59 1999
The MXU has been powered up.

Results of Initialization:
LBT Interface startup complete. Waiting for LBT Response.
LBT Interface startup complete. Waiting for LBT Response.
LBT Interface startup complete. Waiting for LBT Response.
LBT Interface startup complete. Waiting for LBT Response.
Dialogic Channel 1 did not detect dial tone.
Dialogic Channel 2 did not detect dial tone.
Dialogic Channel 3 did not detect dial tone.
Dialogic Channel 4 did not detect dial tone.

Coordinated Universal Time is Fri Jan 29 14:45:11 1999
D:\mxusrc\db\Logwrite.cpp: Opening AT from Master!

DRAFT COPY

DRAFT COPY
NOMAD MXU Administration Manual

3:33 PM 02/12/99

Coordinated Universal Time is Fri Jan 29 14:45:12 1999
D:\mxusrc\db\Logwrite.cpp: Opening SC from Master!

Coordinated Universal Time is Fri Jan 29 14:51:29 1999
The MXU has been powered up.

Results of Initialization:
LBT Interface startup complete. Waiting for LBT Response.
LBT Interface startup complete. Waiting for LBT Response.
LBT Interface startup complete. Waiting for LBT Response.
LBT Interface startup complete. Waiting for LBT Response.
Dialogic Channel 1 did not detect dial tone.
Dialogic Channel 2 did not detect dial tone.
Dialogic Channel 3 did not detect dial tone.
Dialogic Channel 4 did not detect dial tone.

Coordinated Universal Time is Fri Jan 29 14:51:42 1999
D:\mxusrc\db\Logwrite.cpp: Opening AT from Master!

Coordinated Universal Time is Fri Jan 29 14:51:42 1999
D:\mxusrc\db\Logwrite.cpp: Opening SC from Master!

Coordinated Universal Time is Fri Jan 29 14:57:07 1999
The MXU has been powered up.

Results of Initialization:
LBT Interface startup complete. Waiting for LBT Response.
LBT Interface startup complete. Waiting for LBT Response.
LBT Interface startup complete. Waiting for LBT Response.
LBT Interface startup complete. Waiting for LBT Response.
Dialogic Channel 1 did not detect dial tone.
Dialogic Channel 2 did not detect dial tone.
Dialogic Channel 3 did not detect dial tone.
Dialogic Channel 4 did not detect dial tone.

Coordinated Universal Time is Fri Jan 29 14:57:20 1999
D:\mxusrc\db\Logwrite.cpp: Opening AT from Master!

Coordinated Universal Time is Fri Jan 29 14:57:20 1999
D:\mxusrc\db\Logwrite.cpp: Opening SC from Master!

Coordinated Universal Time is Fri Jan 29 15:01:36 1999
The MXU has been powered up.

Results of Initialization:
LBT Interface startup complete. Waiting for LBT Response.
LBT Interface startup complete. Waiting for LBT Response.
LBT Interface startup complete. Waiting for LBT Response.
LBT Interface startup complete. Waiting for LBT Response.
Dialogic Channel 1 did not detect dial tone.
Dialogic Channel 2 did not detect dial tone.

DRAFT COPY

DRAFT COPY
NOMAD MXU Administration Manual

3:33 PM 02/12/99

Dialogic Channel 3 did not detect dial tone.
Dialogic Channel 4 did not detect dial tone.

Coordinated Universal Time is Fri Jan 29 15:01:49 1999
D:\mxusrc\db\Logwrite.cpp: Opening AT from Master!

Coordinated Universal Time is Fri Jan 29 15:01:49 1999
D:\mxusrc\db\Logwrite.cpp: Opening SC from Master!

Coordinated Universal Time is Fri Jan 29 15:11:04 1999
The MXU has been powered up.

Results of Initialization:
LBT Interface startup complete. Waiting for LBT Response.
LBT Interface startup complete. Waiting for LBT Response.
LBT Interface startup complete. Waiting for LBT Response.
LBT Interface startup complete. Waiting for LBT Response.
Dialogic Channel 1 did not detect dial tone.
Dialogic Channel 2 did not detect dial tone.
Dialogic Channel 3 did not detect dial tone.
Dialogic Channel 4 did not detect dial tone.

Coordinated Universal Time is Fri Jan 29 15:11:18 1999
D:\mxusrc\db\Logwrite.cpp: Opening AT from Master!

Coordinated Universal Time is Fri Jan 29 15:11:18 1999
D:\mxusrc\db\Logwrite.cpp: Opening SC from Master!

Coordinated Universal Time is Fri Jan 29 15:21:16 1999
The MXU has been powered up.

Results of Initialization:
LBT Interface startup complete. Waiting for LBT Response.
LBT Interface startup complete. Waiting for LBT Response.
LBT Interface startup complete. Waiting for LBT Response.
LBT Interface startup complete. Waiting for LBT Response.
Dialogic Channel 1 did not detect dial tone.
Dialogic Channel 2 did not detect dial tone.
Dialogic Channel 3 did not detect dial tone.
Dialogic Channel 4 did not detect dial tone.

Coordinated Universal Time is Fri Jan 29 15:21:29 1999
D:\mxusrc\db\Logwrite.cpp: Opening AT from Master!

Coordinated Universal Time is Fri Jan 29 15:21:29 1999
D:\mxusrc\db\Logwrite.cpp: Opening SC from Master!

Coordinated Universal Time is Fri Jan 29 15:29:43 1999
The MXU has been powered up.

DRAFT COPY

DRAFT COPY
NOMAD MXU Administration Manual

3:33 PM 02/12/99

Results of Initialization:
LBT Interface startup complete. Waiting for LBT Response.
LBT Interface startup complete. Waiting for LBT Response.
LBT Interface startup complete. Waiting for LBT Response.
LBT Interface startup complete. Waiting for LBT Response.
Dialogic Channel 1 did not detect dial tone.
Dialogic Channel 2 did not detect dial tone.
Dialogic Channel 3 did not detect dial tone.
Dialogic Channel 4 did not detect dial tone.

Coordinated Universal Time is Fri Jan 29 15:29:56 1999
D:\mxusrc\db\Logwrite.cpp: Opening AT from Master!

Coordinated Universal Time is Fri Jan 29 15:29:56 1999
D:\mxusrc\db\Logwrite.cpp: Opening SC from Master!

Coordinated Universal Time is Fri Jan 29 23:26:39 1999
The MXU has been powered up.

Results of Initialization:
LBT Interface startup complete. Waiting for LBT Response.
LBT Interface startup complete. Waiting for LBT Response.
LBT Interface startup complete. Waiting for LBT Response.
LBT Interface startup complete. Waiting for LBT Response.
Dialogic Channel 1 did not detect dial tone.
Dialogic Channel 2 did not detect dial tone.
Dialogic Channel 3 did not detect dial tone.
Dialogic Channel 4 did not detect dial tone.

Coordinated Universal Time is Fri Jan 29 23:26:53 1999
D:\mxusrc\db\Logwrite.cpp: Opening AT from Master!

Coordinated Universal Time is Fri Jan 29 23:26:54 1999
D:\mxusrc\db\Logwrite.cpp: Opening SC from Master!

Coordinated Universal Time is Fri Jan 29 23:32:02 1999
The MXU has been powered up.

Results of Initialization:
LBT Interface startup complete. Waiting for LBT Response.
LBT Interface startup complete. Waiting for LBT Response.
LBT Interface startup complete. Waiting for LBT Response.
LBT Interface startup complete. Waiting for LBT Response.
Dialogic Channel 1 did not detect dial tone.
Dialogic Channel 2 did not detect dial tone.
Dialogic Channel 3 did not detect dial tone.
Dialogic Channel 4 did not detect dial tone.

DRAFT COPY

DRAFT COPY
NOMAD MXU Administration Manual

3:33 PM 02/12/99

Coordinated Universal Time is Fri Jan 29 23:32:16 1999
D:\mxusrc\db\Logwrite.cpp: Opening AT from Master!

Coordinated Universal Time is Fri Jan 29 23:32:16 1999
D:\mxusrc\db\Logwrite.cpp: Opening SC from Master!

Coordinated Universal Time is Fri Jan 29 23:42:31 1999
The MXU has been powered up.

Results of Initialization:
LBT Interface startup complete. Waiting for LBT Response.
LBT Interface startup complete. Waiting for LBT Response.
LBT Interface startup complete. Waiting for LBT Response.
LBT Interface startup complete. Waiting for LBT Response.
Dialogic Channel 1 did not detect dial tone.
Dialogic Channel 2 did not detect dial tone.
Dialogic Channel 3 did not detect dial tone.
Dialogic Channel 4 did not detect dial tone.

Coordinated Universal Time is Fri Jan 29 23:42:43 1999
D:\mxusrc\db\Logwrite.cpp: Opening AT from Master!

Coordinated Universal Time is Fri Jan 29 23:42:44 1999
D:\mxusrc\db\Logwrite.cpp: Opening SC from Master!

Coordinated Universal Time is Sat Jan 30 00:30:52 1999
The MXU has been powered up.

Results of Initialization:
LBT Interface startup complete. Waiting for LBT Response.
LBT Interface startup complete. Waiting for LBT Response.
LBT Interface startup complete. Waiting for LBT Response.
LBT Interface startup complete. Waiting for LBT Response.
Dialogic Channel 1 did not detect dial tone.
Dialogic Channel 2 did not detect dial tone.
Dialogic Channel 3 did not detect dial tone.
Dialogic Channel 4 did not detect dial tone.

Coordinated Universal Time is Sat Jan 30 00:31:06 1999
D:\mxu_fcc\db\Logwrite.cpp: Opening AT from Master!

Coordinated Universal Time is Sat Jan 30 00:31:07 1999
D:\mxu_fcc\db\Logwrite.cpp: Opening SC from Master!

Coordinated Universal Time is Sat Jan 30 00:47:13 1999
The MXU has been powered up.

Results of Initialization:
LBT Interface startup complete. Waiting for LBT Response.
LBT Interface startup complete. Waiting for LBT Response.
LBT Interface startup complete. Waiting for LBT Response.

DRAFT COPY

DRAFT COPY
NOMAD MXU Administration Manual

3:33 PM 02/12/99

LBT Interface startup complete. Waiting for LBT Response.
Dialogic Channel 1 did not detect dial tone.
Dialogic Channel 2 did not detect dial tone.
Dialogic Channel 3 did not detect dial tone.
Dialogic Channel 4 did not detect dial tone.

Coordinated Universal Time is Sat Jan 30 00:47:26 1999
D:\mxu_fcc\db\Logwrite.cpp: Opening AT from Master!

Coordinated Universal Time is Sat Jan 30 00:47:26 1999
D:\mxu_fcc\db\Logwrite.cpp: Opening SC from Master!

Coordinated Universal Time is Sat Jan 30 00:56:12 1999
The MXU has been powered up.

Results of Initialization:
LBT Interface startup complete. Waiting for LBT Response.
LBT Interface startup complete. Waiting for LBT Response.
LBT Interface startup complete. Waiting for LBT Response.
LBT Interface startup complete. Waiting for LBT Response.
Dialogic Channel 1 did not detect dial tone.
Dialogic Channel 2 did not detect dial tone.
Dialogic Channel 3 did not detect dial tone.
Dialogic Channel 4 did not detect dial tone.

Coordinated Universal Time is Sat Jan 30 00:56:25 1999
D:\mxu_fcc\db\Logwrite.cpp: Opening AT from Master!

Coordinated Universal Time is Sat Jan 30 00:56:25 1999
D:\mxu_fcc\db\Logwrite.cpp: Opening SC from Master!

Coordinated Universal Time is Tue Feb 02 18:56:50 1999
The MXU has been powered up.

Results of Initialization:
LBT Interface startup complete. Waiting for LBT Response.
LBT Interface startup complete. Waiting for LBT Response.
LBT Interface startup complete. Waiting for LBT Response.
LBT Interface startup complete. Waiting for LBT Response.
Dialogic Channel 1 did not detect dial tone.
Dialogic Channel 2 did not detect dial tone.
Dialogic Channel 3 did not detect dial tone.
Dialogic Channel 4 did not detect dial tone.

Coordinated Universal Time is Tue Feb 02 18:57:05 1999
D:\mxu_fcc\db\Logwrite.cpp: Opening AT from Master!

Coordinated Universal Time is Tue Feb 02 18:57:05 1999
D:\mxu_fcc\db\Logwrite.cpp: Opening SC from Master!

DRAFT COPY

DRAFT COPY
NOMAD MXU Administration Manual

3:33 PM 02/12/99

Coordinated Universal Time is Tue Feb 02 19:15:27 1999
The MXU has been powered up.

Results of Initialization:
LBT Interface startup complete. Waiting for LBT Response.
LBT Interface startup complete. Waiting for LBT Response.
LBT Interface startup complete. Waiting for LBT Response.
LBT Interface startup complete. Waiting for LBT Response.
Dialogic Channel 1 did not detect dial tone.
Dialogic Channel 2 did not detect dial tone.
Dialogic Channel 3 did not detect dial tone.
Dialogic Channel 4 did not detect dial tone.

Coordinated Universal Time is Tue Feb 02 19:15:41 1999
D:\mxu_fcc\db\Logwrite.cpp: Opening AT from Master!

Coordinated Universal Time is Tue Feb 02 19:15:41 1999
D:\mxu_fcc\db\Logwrite.cpp: Opening SC from Master!

Coordinated Universal Time is Tue Feb 02 20:06:20 1999
The MXU has been powered up.

Results of Initialization:
LBT Interface startup complete. Waiting for LBT Response.
LBT Interface startup complete. Waiting for LBT Response.
LBT Interface startup complete. Waiting for LBT Response.
LBT Interface startup complete. Waiting for LBT Response.
Dialogic Channel 1 did not detect dial tone.
Dialogic Channel 2 did not detect dial tone.
Dialogic Channel 3 did not detect dial tone.
Dialogic Channel 4 did not detect dial tone.

Coordinated Universal Time is Tue Feb 02 20:06:34 1999
D:\mxu_fcc\db\Logwrite.cpp: Opening AT from Master!

Coordinated Universal Time is Tue Feb 02 20:06:35 1999
D:\mxu_fcc\db\Logwrite.cpp: Opening SC from Master!

Coordinated Universal Time is Tue Feb 02 22:12:31 1999
The MXU has been powered up.

Results of Initialization:
LBT Interface startup complete. Waiting for LBT Response.
LBT Interface startup complete. Waiting for LBT Response.
LBT Interface startup complete. Waiting for LBT Response.
LBT Interface startup complete. Waiting for LBT Response.
Dialogic Channel 1 did not detect dial tone.
Dialogic Channel 2 did not detect dial tone.
Dialogic Channel 3 did not detect dial tone.
Dialogic Channel 4 did not detect dial tone.

DRAFT COPY

DRAFT COPY
NOMAD MXU Administration Manual

3:33 PM 02/12/99

Coordinated Universal Time is Tue Feb 02 22:12:45 1999
D:\mxu_fcc\db\Logwrite.cpp: Opening AT from Master!

Coordinated Universal Time is Tue Feb 02 22:12:45 1999
D:\mxu_fcc\db\Logwrite.cpp: Opening SC from Master!

Coordinated Universal Time is Wed Feb 03 16:57:24 1999
The MXU has been powered up.

Results of Initialization:
LBT Interface startup complete. Waiting for LBT Response.
LBT Interface startup complete. Waiting for LBT Response.
LBT Interface startup complete. Waiting for LBT Response.
LBT Interface startup complete. Waiting for LBT Response.
Dialogic Channel 1 did not detect dial tone.
Dialogic Channel 2 did not detect dial tone.
Dialogic Channel 3 did not detect dial tone.
Dialogic Channel 4 did not detect dial tone.

Coordinated Universal Time is Wed Feb 03 16:57:38 1999
D:\mxu_fcc\db\Logwrite.cpp: Opening AT from Master!

Coordinated Universal Time is Wed Feb 03 16:57:38 1999
D:\mxu_fcc\db\Logwrite.cpp: Opening SC from Master!

Coordinated Universal Time is Wed Feb 03 17:01:44 1999
The MXU has been powered up.

Results of Initialization:
LBT Interface startup complete. Waiting for LBT Response.
LBT Interface startup complete. Waiting for LBT Response.
LBT Interface startup complete. Waiting for LBT Response.
LBT Interface startup complete. Waiting for LBT Response.
Dialogic Channel 1 did not detect dial tone.
Dialogic Channel 2 did not detect dial tone.
Dialogic Channel 3 did not detect dial tone.
Dialogic Channel 4 did not detect dial tone.

Coordinated Universal Time is Wed Feb 03 17:02:38 1999
The MXU has been powered up.

Results of Initialization:
LBT Interface startup complete. Waiting for LBT Response.
LBT Interface startup complete. Waiting for LBT Response.
LBT Interface startup complete. Waiting for LBT Response.
LBT Interface startup complete. Waiting for LBT Response.
Dialogic Channel 1 did not detect dial tone.
Dialogic Channel 2 did not detect dial tone.

DRAFT COPY

DRAFT COPY
NOMAD MXU Administration Manual

3:33 PM 02/12/99

Dialogic Channel 3 did not detect dial tone.
Dialogic Channel 4 did not detect dial tone.

Coordinated Universal Time is Wed Feb 03 17:02:52 1999
D:\mxu_fcc\db\Logwrite.cpp: Opening AT from Master!

Coordinated Universal Time is Wed Feb 03 17:02:52 1999
D:\mxu_fcc\db\Logwrite.cpp: Opening SC from Master!

Coordinated Universal Time is Wed Feb 03 17:07:40 1999
The MXU has been powered up.

Results of Initialization:
LBT Interface startup complete. Waiting for LBT Response.
LBT Interface startup complete. Waiting for LBT Response.
LBT Interface startup complete. Waiting for LBT Response.
LBT Interface startup complete. Waiting for LBT Response.
Dialogic Channel 1 did not detect dial tone.
Dialogic Channel 2 did not detect dial tone.
Dialogic Channel 3 did not detect dial tone.
Dialogic Channel 4 did not detect dial tone.

Coordinated Universal Time is Wed Feb 03 17:07:54 1999
D:\mxu_fcc\db\Logwrite.cpp: Opening AT from Master!

Coordinated Universal Time is Wed Feb 03 17:07:55 1999
D:\mxu_fcc\db\Logwrite.cpp: Opening SC from Master!

Coordinated Universal Time is Wed Feb 03 17:13:43 1999
The MXU has been powered up.

Results of Initialization:
LBT Interface startup complete. Waiting for LBT Response.
LBT Interface startup complete. Waiting for LBT Response.
LBT Interface startup complete. Waiting for LBT Response.
LBT Interface startup complete. Waiting for LBT Response.
Dialogic Channel 1 did not detect dial tone.
Dialogic Channel 2 did not detect dial tone.
Dialogic Channel 3 did not detect dial tone.
Dialogic Channel 4 did not detect dial tone.

Coordinated Universal Time is Wed Feb 03 17:14:43 1999
The MXU has been powered up.

Results of Initialization:
LBT Interface startup complete. Waiting for LBT Response.
LBT Interface startup complete. Waiting for LBT Response.
LBT Interface startup complete. Waiting for LBT Response.
LBT Interface startup complete. Waiting for LBT Response.

DRAFT COPY

DRAFT COPY
NOMAD MXU Administration Manual

3:33 PM 02/12/99

Dialogic Channel 1 did not detect dial tone.
Dialogic Channel 2 did not detect dial tone.
Dialogic Channel 3 did not detect dial tone.
Dialogic Channel 4 did not detect dial tone.

Coordinated Universal Time is Wed Feb 03 17:14:57 1999
D:\mxu_fcc\db\Logwrite.cpp: Opening AT from Master!

Coordinated Universal Time is Wed Feb 03 17:14:57 1999
D:\mxu_fcc\db\Logwrite.cpp: Opening SC from Master!

Coordinated Universal Time is Wed Feb 03 17:50:23 1999
The MXU has been powered up.

Results of Initialization:
LBT Interface startup complete. Waiting for LBT Response.
LBT Interface startup complete. Waiting for LBT Response.
LBT Interface startup complete. Waiting for LBT Response.
LBT Interface startup complete. Waiting for LBT Response.
Dialogic Channel 1 did not detect dial tone.
Dialogic Channel 2 did not detect dial tone.
Dialogic Channel 3 did not detect dial tone.
Dialogic Channel 4 did not detect dial tone.

Coordinated Universal Time is Wed Feb 03 17:50:35 1999
D:\mxu_fcc\db\Logwrite.cpp: Opening AT from Master!

Coordinated Universal Time is Wed Feb 03 17:50:36 1999
D:\mxu_fcc\db\Logwrite.cpp: Opening SC from Master!

Coordinated Universal Time is Wed Feb 03 17:59:16 1999
The MXU has been powered up.

Results of Initialization:
LBT Interface startup complete. Waiting for LBT Response.
LBT Interface startup complete. Waiting for LBT Response.
LBT Interface startup complete. Waiting for LBT Response.
LBT Interface startup complete. Waiting for LBT Response.
Dialogic Channel 1 did not detect dial tone.
Dialogic Channel 2 did not detect dial tone.
Dialogic Channel 3 did not detect dial tone.
Dialogic Channel 4 did not detect dial tone.

Coordinated Universal Time is Wed Feb 03 17:59:31 1999
D:\mxu_fcc\db\Logwrite.cpp: Opening AT from Master!

Coordinated Universal Time is Wed Feb 03 17:59:31 1999
D:\mxu_fcc\db\Logwrite.cpp: Opening SC from Master!

DRAFT COPY

DRAFT COPY
NOMAD MXU Administration Manual

3:33 PM 02/12/99

Coordinated Universal Time is Wed Feb 03 22:08:21 1999
The MXU has been powered up.

Results of Initialization:
LBT Interface startup complete. Waiting for LBT Response.
LBT Interface startup complete. Waiting for LBT Response.
LBT Interface startup complete. Waiting for LBT Response.
LBT Interface startup complete. Waiting for LBT Response.
Dialogic Channel 1 did not detect dial tone.
Dialogic Channel 2 did not detect dial tone.
Dialogic Channel 3 did not detect dial tone.
Dialogic Channel 4 did not detect dial tone.

Coordinated Universal Time is Wed Feb 03 22:11:15 1999
The MXU has been powered up.

Results of Initialization:
LBT Interface startup complete. Waiting for LBT Response.
LBT Interface startup complete. Waiting for LBT Response.
LBT Interface startup complete. Waiting for LBT Response.
LBT Interface startup complete. Waiting for LBT Response.
Dialogic Channel 1 did not detect dial tone.
Dialogic Channel 2 did not detect dial tone.
Dialogic Channel 3 did not detect dial tone.
Dialogic Channel 4 did not detect dial tone.

Coordinated Universal Time is Wed Feb 03 22:11:29 1999
D:\mxu_fcc\db\Logwrite.cpp: Opening AT from Master!

Coordinated Universal Time is Wed Feb 03 22:11:30 1999
D:\mxu_fcc\db\Logwrite.cpp: Opening SC from Master!

Coordinated Universal Time is Wed Feb 03 22:24:02 1999
The MXU has been powered up.

Results of Initialization:
LBT Interface startup complete. Waiting for LBT Response.
LBT Interface startup complete. Waiting for LBT Response.
LBT Interface startup complete. Waiting for LBT Response.
LBT Interface startup complete. Waiting for LBT Response.
Dialogic Channel 1 did not detect dial tone.
Dialogic Channel 2 did not detect dial tone.
Dialogic Channel 3 did not detect dial tone.
Dialogic Channel 4 did not detect dial tone.

Coordinated Universal Time is Wed Feb 03 22:24:17 1999
D:\mxu_fcc\db\Logwrite.cpp: Opening AT from Master!

Coordinated Universal Time is Wed Feb 03 22:24:17 1999

DRAFT COPY

DRAFT COPY
NOMAD MXU Administration Manual

3:33 PM 02/12/99

D:\mxu_fcc\db\Logwrite.cpp: Opening SC from Master!

APPENDIX “C” – Specifications

Dimensions 19.0”W X 16.0” L X 5.25”H

Weight less than 20 lbs.

Operating Temperature +15°C to +35°C

Storage Temperature -20°C to +60°C

Humidity 80% RH at 40°C

Service Life 5 years

Power 110/230 VAC, 50/60 Hertz

Interface to PBX/PSTN Four analog phone lines

MXU shall emulate the following phone types:

(UK), BAPT 223 ZV5 (Germany), B 11-23A (France), FCC Part 68 (USA), TS-002 (Australia), JATE (Japan)

Operating (transmit and receive) 1616 - 1625.5 MHz

OSC Stability +/- 1.5 ppm

Duplexing Method Time Division Duplex

Multiplexing Method TDMA/FDMA

Link Margin (w/exterior Antenna) 12.5 dB average

Sensitivity -117.9 dBm (Measured at the RF Connector)

TX Spurs General -71 dBc (Measured at the RF Connector)

TX Spurs GNSS 1559-1605 MHz -91dBc (Measured at the RF Connector)

TX Noise GNSS 1559-1605 MHz -81dBc (Measured at the RF Connector)

Distance between Antennas 3 feet Min

DRAFT COPY

APPENDIX "D" - Warranty