

English**Deutsch****Français**

Getting Started

Congratulations on your purchase of the Itronix GoBook PRO II computer! Your new GoBook PRO II features the most innovative advances in portable computing technology. It combines state-of-the-art ergonomics with sophisticated architecture to provide you with a personal computer that is compact, powerful, and easy to use.

Designed for a wide range of general, business, and personal productivity applications, the semi-rugged, wireless ready GoBook PRO II is an ideal choice wherever you need a computer; in the office, at home, and on the road.

Your GoBook II is both expandable and portable, supporting the [features](#) you expect in a desktop computer but with the mobility of a laptop.

This online document, GoBook PRO II Help, contains all the information you need to set up and use your new GoBook PRO II. For information on printing, navigating or otherwise using GoBook PRO II Help see the [How to Use This Help System](#) topics.



GoBook® PRO II Help

Unpacking Your System

Inside your packaging you will find:

[Standard](#)

[Options](#)

[Where to Look For Information](#)

72_0128_001

16 May 2005

[© 2005 Itronix Corporation. All rights reserved.](#)

ITRONIX[®]

GoBook[®] PRO II Help

Features

This computer was designed with the user in mind. Here are just a few of its many features:

[Performance](#)

[Multimedia](#)

[Connectivity](#)

[Human-centric design and ergonomics](#)

[Expansion](#)

See [Specifications](#) for more information.

72_0128_001

16 May 2005

[© 2005 Itronix Corporation. All rights reserved.](#)

ITRONIX[®]

GoBook[®] PRO II Help

The First Time. . .

Before using your computer, install the battery and then attach the computer to AC power.

Installing the battery:

1. Line up the battery connectors.
2. Press gently on the battery until it clicks into place.



3. Slide the battery locks toward the outside of the computer to lock the battery.

Attaching AC Power:

1. Connect the AC adapter power cord to the AC adapter. insert picture
2. Connect the AC adapter to the DC power port on the rear panel of your computer.
3. Connect the AC adapter power cord to a properly grounded AC outlet.

NOTE It is recommended you use a quality [surge protector](#).

Begin Using the Computer

1. Slide the display cover release latch to the right.
2. Open the display to a comfortable viewing angle.
3. Press the power switch to turn on the power.

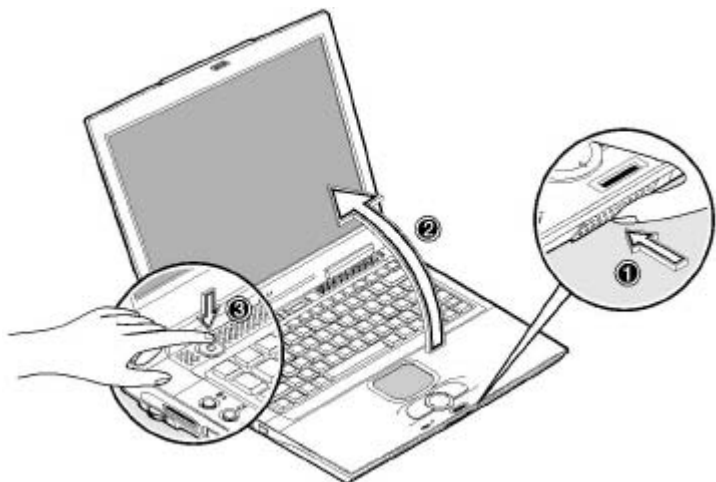

The [POST](#) (power-on self-test) routine executes and [Windows begins loading](#).

NOTE When using a battery pack for the first time, fully charge the battery, then

disconnect the adapter to use up the battery before recharging again. Perform this action twice to condition the battery pack.

[Calibrating the battery](#) before use is also highly recommended. Refer to [Power Management](#), for more information.

Turning off Your Computer

Turning off the computer properly is important to maintaining your computer. Select Start, **Shut Down** and follow the instructions on the screen.

If you are going to be away from the computer for a short period, there are ways to conserve power without shutting down the system. See [Power Saving Modes](#) for details.

NOTE If you are unable to shut down your computer normally, press and hold the power button more than four seconds to turn off the computer. If you turn off the computer and want to turn it on again, wait at least two seconds before powering up.

CAUTION Shutting off the computer improperly may result in data loss.

72_0128_001

16 May 2005

© 2005 Itronix Corporation. All rights reserved.

ITRONIX[®]

GoBook[®] PRO II Help

Loading Windows

This section is for installing the Windows operating system only. If you are installing a different operating system, please check with your vendor for installation details.

Your computer will begin loading Windows once you turn on the power. Wait a few seconds for Windows setup to load. The Windows setup will prompt you for the product key number. You can find the product key number on a sticker attached to the bottom of the computer.



1. Type your name, and, if applicable, the name of your company.
2. Read the End User's License Agreement. Click **Next** to accept it.
3. Enter the product key number. You can find this on the Certificate of Authenticity on a sticker attached to the computer. Click **Finish**.
4. The Start Wizard will prompt you to set the date, and your local time.

Some software comes pre-loaded with Windows. New users can familiarize themselves with this software by selecting All Programs from the start menu, then clicking on programs to run them.

CAUTION When you are installing the Windows operating system and enter the product key number, we strongly recommend connecting the AC adapter - DO NOT use battery alone to avoid warning messages.

72_0128_001

16 May 2005

© 2005 Itronix Corporation. All rights reserved.

ITRONIX[®]

GoBook[®] PRO II Help

Startup Problems?

If your computer does not operate, try these solutions.

- Connect the AC adapter to charge the battery if it is not charged.
NOTE The Power LED on the AC adapter should be lit as well as the [External Power Indicator](#) on the GoBook PRO II if the AC adapter is connected and functioning properly. Additionally, one of the power icons should appear in the task tray.
- If the AC adapter is connected but the unit will still not turn on, make sure the electrical outlet you are using works.
- Check to make sure the battery is installed and charged properly.
- If the battery does not begin charging, remove the battery, connect the AC adapter, and turn on the computer by pressing the Power Button. Reinstall the battery. The Battery Indicator  is solid orange while the battery is charging.

The [Troubleshooting](#) section lists additional solutions you can try.

72_0128_001

16 May 2005

© 2005 Itronix Corporation. All rights reserved.

ITRONIX[®]

GoBook[®] PRO II Help

Safety and Ergonomics

Important safety instructions

1. Read these instructions carefully. Save these instructions for future reference.

2. Follow all warnings and instructions marked on the product.
3. Unplug this product from the wall outlet before cleaning. Do not use liquid cleaners or aerosol cleaners. Use a damp cloth for cleaning.
4. Do not use this product near water.
5. Do not place this product on an unstable cart, stand, or table. The product may fall, causing serious damage to the product.
6. Slots and openings in the cabinet and the back or bottom are provided for ventilation; to ensure reliable operation of the product and to protect it from overheating, these openings must not be blocked or covered. The openings should never be blocked by placing the product on a bed, sofa, rug, or other similar surface. This product should never be placed near or over a radiator or heat register, or in a built-in installation unless proper ventilation is provided.
7. This product should be operated from the type of power indicated on the marking label. If you are not sure of the type of power available, consult your dealer or local power company.
8. Do not allow anything to rest on the power cord. Do not locate this product where persons will walk on the cord.
9. If an extension cord is used with this product, make sure that the total ampere rating of the equipment plugged into the extension cord does not exceed the extension cord ampere rating. Also, make sure that the total rating of all products plugged into the wall outlet does not exceed the fuse rating.
10. Never push objects of any kind into this product through cabinet slots as they may touch dangerous voltage points or short out parts that could result in a fire or electric shock. Never spill liquid of any kind on the product.
11. Do not attempt to service this product yourself, as opening or removing covers may expose you to dangerous voltage points or other risks. Refer all servicing to qualified service personnel.
12. Unplug this product from the wall outlet and refer servicing to qualified service personnel under the following conditions:
 1. When the power cord or plug is damaged or frayed
 2. If liquid has been spilled into the product
 3. If the product has been exposed to rain or water
 4. If the product does not operate normally when the operating instructions are followed. Adjust only those controls that are covered by the operating instructions since improper adjustment of other controls may result in damage and will often require extensive work by a qualified technician to restore the product to normal condition.
 5. If the product has been dropped or the cabinet has been damaged

6. If the product exhibits a distinct change in performance, indicating a need for service.
13. Replace the battery with the same type as the product's battery we recommend. Use of another battery may present a risk of fire or explosion. Refer battery replacement to a qualified serviceman.
14. **WARNING!** Batteries may explode if not handled properly. Do not disassemble or dispose of them in fire. Keep them away from children and dispose of used batteries promptly.
15. Use only the proper type of power supply cord set (provided in your accessories box) for this unit. It should be a detachable type: UL listed/CSA certified, type SPT-2, rated 7A 125V minimum, VDE approved or its equivalent. Maximum length is 15 feet (4.6 meters).

Ergonomics

72_0128_001

16 May 2005

© 2005 Itronix Corporation. All rights reserved.

ITRONIX[®]

GoBook[®] PRO II Help

Tips for New Owners

- Take responsibility for backup

Back up files often. Users who need to manage large amounts of data may wish to use backup devices such as a ZIP drive.

- **Don't leave passwords anywhere on your notebook or carrying case**
- **Be careful when placing your notebook on an airport security conveyor belt**

In most airports, security conveyor belts are safe for computers. If you are not sure, ask the security staff. You should keep a close eye on your computer.

- Tape your business card to the notebook and accessories

In the workplace, notebooks and accessories may often look exactly alike, leading to equipment mix-ups. Prevent such mix-ups by placing your name on your equipment.

- Develop ergonomic work habits

The science of ergonomics studies the relationship between health and a suitable work environment. For more information on ergonomics, contact your nearest computer bookstore, or local library. See [Safety and Ergonomics](#).

- Consider using a lock

For added security, consider purchasing a Kensington lock to put into the [Security Slot](#) on the [right side](#) of your computer. Use the Kensington lock to secure the computer to a desk or table.

NOTE Using a computer for extended periods of time with a poor workstation setup and incorrect work habits can cause health problems.

72_0128_001

16 May 2005

[© 2005 Itronix Corporation. All rights reserved.](#)

Getting Familiar with Your Computer

This chapter introduces the different components and controls of your notebook computer, including the hardware components, the software, and the audio and video systems.

Before you begin using your GoBook PRO II, read this chapter to familiarize yourself with the main components installed in the system.

This computer combines high-performance, versatility, power management features and multimedia capabilities with a unique style and ergonomic design. Work with unmatched productivity and reliability with your new power computing partner.

This chapter gives an in-depth "tour" of the computer's many features.

ITRONIX®

GoBook® PRO II Help

Front View

Hover the mouse over each number on the picture to see a description

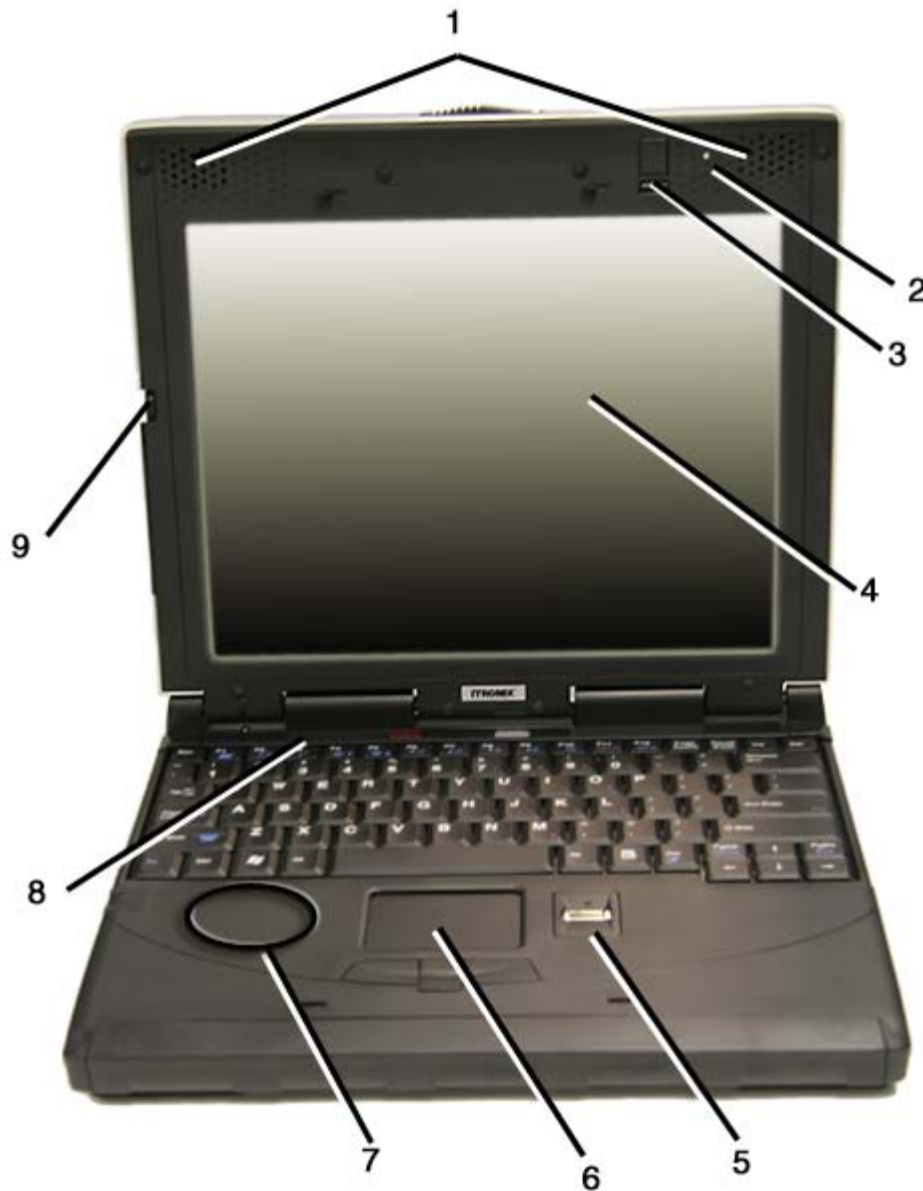

#	Feature	Description
1	Speakers	
2	Photo Sensor	
3	Keyboard Light	
4	Touch Screen Display	
5	Fingerprint Scanner	Optional feature
6	Touchpad	
7	Bluetooth / Diversity for EVDO Antenna	

8	LEDs	Lights that turn on, of or blink to show the status of the computer and its functions
---	------	---

72_0128_001

16 May 2005

© 2005 Itronix Corporation. All rights reserved.

ITRONIX®

GoBook® PRO II Help

Top View

Hover the mouse over each number on the picture to see a description

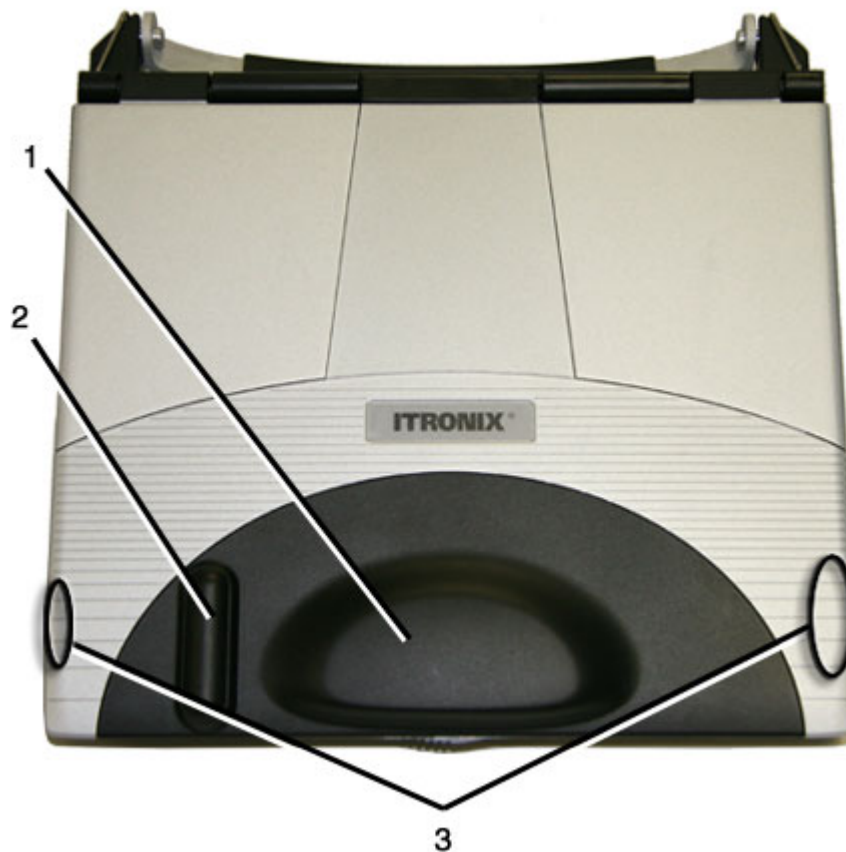

#	Feature	Description
1	CRMA Express Antenna	Antenna for WAN Communications
2	GPS Antenna	Antenna for GPS Communications
3	WLAN Antennas	Antenna for WLAN Communications

CAUTION Please avoid hitting wireless communication antennas as this may adversely affect communications quality.

72_0128_001

16 May 2005

© 2005 Itronix Corporation. All rights reserved.

ITRONIX[®]GoBook[®] PRO II Help

Left Side View

Hover the mouse over each number on the picture to see a description

*** insert picture ***

#	Feature	Description
1	Volume Control Knob	Use to adjust the volume
2	Memory Stick / Secure Digital Card Slot (optional)	Use with a Memory Stick, Secure Digital (SD) or MultiMediaCard (MMC) memory card.
3	PC Card Slot	
4	Infrared Port (optional)	
5		
6		

72_0128_001

16 May 2005

© 2005 Itronix Corporation. All rights reserved.

ITRONIX[®]GoBook[®] PRO II Help

Right Side View

Hover the mouse over each number on the picture to see a description

insert picture

#	Feature	Description
1		
2		
3		
4		
5		
6		
7		
8		
9		
10		

- | | |
|-----------------------|-------------------------------|
| 1. USB ports | 5. DVD-ROM drive eject button |
| 2. S-Video port | 6. GPRS Headset Jack |
| 3. DVD-ROM drive | 7. Shoulder strap hole |
| 4. DVD-ROM drive lock | |

72_0128_001

16 May 2005

© 2005 Itronix Corporation. All rights reserved.

ITRONIX[®]GoBook[®] PRO II Help

Back Edge View

Hover the mouse over each number on the picture to see a description

****insert picture****

#	Feature	Description
1	DC-in jack	Connects to an AC adapter.
2	S-video out port	Connects to a television or display device with S-video input.
3	External monitor port	Connects to a display monitor (up to 2048x1536 resolution).
4	Parallel port	Connects to a parallel device (e.g., parallel printer).
5	Modem jack	Connects a phone line (only for models with an internal fax/data modem).
6	Network jack	Connects to an Ethernet-based network.
7	IEEE 1394 port (firewire)	Connects to a IEEE 1394-compatible (4-pin) device (e.g., digital video camera).
8	USB ports	Connect to USB devices (e.g., USB digital camera).
9	Line-in jack	Accepts audio line-in devices (e.g., audio CD player, stereo walkman).
10	S/PDIF line-out jack	Connects to audio line-out devices (e.g., speakers, headphones); supports S/PDIF connections.

72_0128_001

16 May 2005

© 2005 Itronix Corporation. All rights reserved.

ITRONIX[®]GoBook[®] PRO II Help

Bottom View

Hover the mouse over each number on the picture to see a description

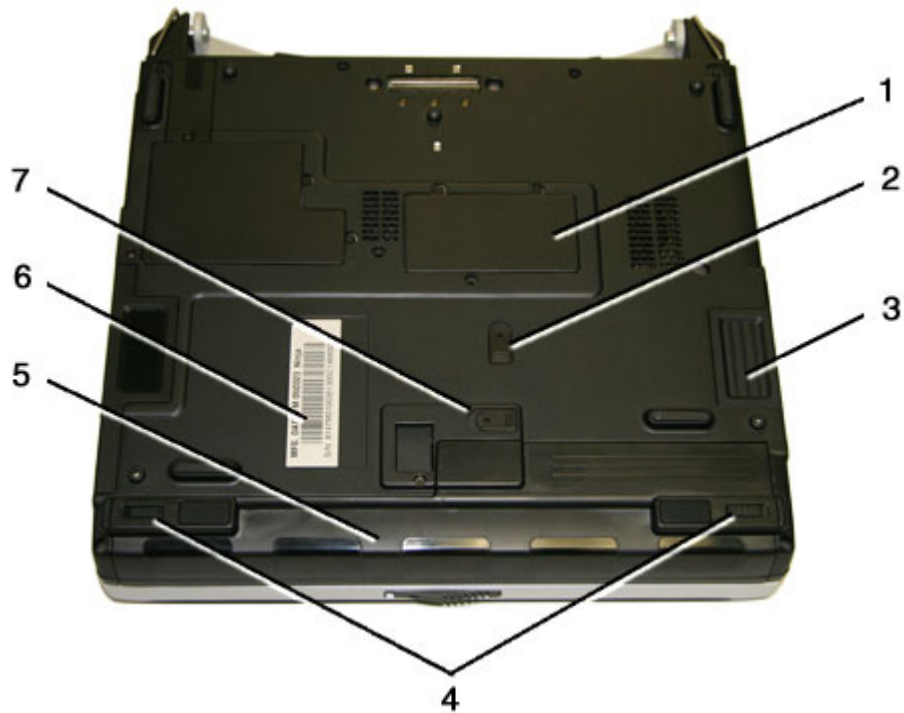

#	Feature	Description
1	Memory compartment	User expandable memory slot
2	Hard Disk Lock	Slide this to lock or unlock the hard disk drive
3	Hard Disk Drive	Removable hard disk drive for data storage
4	Battery Locks	Slide these locks toward the outer edges of the computer to lock the battery.
5	Battery	
6	Serial Number Label	
7	Battery Release Latch	Slide this latch to the left to remove the battery. NOTE You must first unlock the battery.

72_0128_001

16 May 2005

© 2005 Itronix Corporation. All rights reserved.

Keyboard Basics

The GoBook PRO II computer features:

- Full size keys 85-key US keyboard; 87-key international keyboard
- Twelve function keys
- Embedded numeric keypad

- Mouse keys and cursor control keys
- USB port that enables you to [connect an external keyboard](#)

Keyboard ergonomics

Located below the keyboard, the wide and curved palm rest is ergonomically designed to provide you with a very comfortable place to rest your hands while you type.



Primary Keys

Key	Description
-----	-------------

ALTThe ALT (alternate) key is used with other keys to perform special tasks. On some operating systems pressing CTRL+ALT+DEL twice soft reboots the computer .

ALT GRThe ALT GR key, a special function key found on the 87-key international keyboard, when pressed and held, allows you to use characters in the bottom right of a three character key.

BACKSPACEThe BACKSPACE key, sometimes represented on the keyboard as a left arrow, moves the cursor one position to the left. The character to the left of the cursor is erased.

CAPS LOCKPressing the caps lock key one time locks keys A through Z in the UPPER CASE position. Pressing the caps lock key again returns the letters to lower case. While in the upper case mode, pressing the shift key results in lowercase characters when entered. You still have to use the shift key to display characters located on the upper portion of the keyboard. For example, press shift+8 to type an asterisk (*), even when the caps lock key is activated.

The CAPS LOCK activity indicator is on when the keyboard is in CAPS LOCK mode.

CTRLThe ctrl (control) key works with other keys to perform a variety of functions.

ENTERThe enter key signals the computer that you have completed your entry. This is your way of telling the computer to process the information that you have entered.

ESCThe esc (escape) key allows you to exit a pop-up window or message box.

PRTSCIn Windows, pressing the prtsc (print screen) key or ALT+PRTSC key copies the current screen or window to the clipboard so you can paste it into documents.

SHIFTThe shift key changes the keys A through Z to the UPPER CASE position. When you press an alphabetic key, the character appears as a capital letter. When you press shift with other keys, the characters on the upper part of the keys appear. For example, pressing shift+7 displays an ampersand (&).

FnSome special [Fn \(function\) keys](#) have been established to perform important tasks when pressed and held with the Fn key. These keys are described later in this document. The Fn key legend is color keyed to other special keys on the

keyboard
 spacebar Use the spacebar to enter a space and move the cursor one character to the right.

TAB The tab key moves the cursor to the next tab stop or field. Tab stops are defined by your operating system or application program. Press the tab key to move from one field or text box to another.

72_0128_001

16 May 2005

© 2005 Itronix Corporation. All rights reserved.

ITRONIX[®]GoBook[®] PRO II Help

Arrow Keys

The arrow keys are defined by the [software](#) application.

The up arrow key usually moves the cursor up one line. In some cases, you can use the up arrow to make selections from menus and scrollable list boxes.

The down arrow key usually moves the cursor down one line. In Windows, you can use the down arrow to make selections from menus and scrollable list boxes.

The right arrow key usually moves the cursor one character position to the right.

The Left arrow key usually moves the cursor one character position to the left.

72_0128_001

16 May 2005











© 2005 Itronix Corporation. All rights reserved.

ITRONIX[®]GoBook[®] PRO II Help

Function Keys and Key Combinations

When using function keys, press and hold the **Fn** key before pressing the other key in the key combination.

Function Key	Function	Icon	Description
Fn+F1	Display toggle		Switches the display output between the display screen, external monitor (if connected) and both the display screen and external monitor NOTE When a DVD or VCD is playing, this hotkey is disabled.

Fn+F2	Screen blank		Turns off the display screen backlight and turns off the external monitor, if attached. Press any key to turn it back on.
Fn+F3	Standby		Puts the computer in standby mode, which can be defined via the advanced section of the Power Management Properties in the Windows Control Panel
Fn+F4	Tasklight Brightness Down		Dims the keyboard tasklight. NOTE You must first turn on the tasklight by pressing Fn+Shift
Fn+F5	Tasklight Brightness Up		Increases the brightness of the keyboard tasklight. NOTE You must first turn on the tasklight by pressing Fn+Shift
Fn+F6	Brightness Down		Decreases the screen brightness
Fn+F7	Brightness Up		Increases the screen brightness
Fn+F8	Speaker Volume Down		Decreases the speaker volume
Fn+F9	Speaker Volume Up		Increases the speaker volume
Fn+F10	Speaker on/off		Turns the speakers on and off; mutes the sound
Fn+F12		Scr Lk	Scroll Lock
Fn+PgUp	Home	Home	Functions as the “Home” key
Fn+PgDn	End	End	Functions as the “End” key
Fn+ Right Ctrl	Touchpad on/off		Toggles the touchpad on and off
Fn+ Left Shift	Keyboard Task Light		Toggles the keyboard tasklight on and off
Fn+Caps Lock	Wireless		Toggles the power on and off to all radio devices. The radio devices include GPS, Bluetooth, WLAN, and WWAN radios.

NOTE If radio wakeup is enabled, radio power will turn back on before the system suspends.

72_0128_001

16 May 2005

© 2005 Itronix Corporation. All rights reserved.

ITRONIX



GoBook® PRO II Help

Quick Launch Buttons

Five Quick Launch Buttons, located at the top of the keyboard, launch frequently used applications. The Quick Launch Buttons automatically lock when the



cover is closed so you don't have to worry about the GoBook PRO II getting turned on accidentally.

#	Item	Icon	Description
1	Wireless Communication		This button is used to enable or disable the wireless LAN (optional) function.
2	Email		The mail button is used to launch the email application.
3	Internet browser		By default, is used to launch your internet browser.
4	P1		This button is user-programmable
5	P2		This button is user-programmable

For more information, see [Launch Manager](#).

72_0128_001

16 May 2005

© 2005 Itronix Corporation. All rights reserved.

ITRONIX

GoBook® PRO II Help

Numeric Keypad

The embedded numeric keypad consists of ten keys that make number intensive input more convenient. It is indicated by small characters located on the upper right corner of the keycaps. To simplify the keyboard legend, cursor-control key symbols are not printed on the keys. Press FN+NumLock to enable or disable the numeric keypad.

insert picture

Desired Access	Num Lock On	Num Lock Off
Number keys on embedded keypad	Type numbers in a normal manner.	Type numbers in a normal manner.
Cursor-control keys on embedded keypad	Hold Shift while using cursor-control keys.	Hold Fn while using cursor-control keys.
Main keyboard keys	Hold Fn while typing letters on embedded keypad.	Type the letters in a normal manner.

72_0128_001

16 May 2005

© 2005 Itronix Corporation. All rights reserved.

ITRONIX

GoBook® PRO II Help

Lock Keys

The keyboard has three lock keys which you can toggle on and off.

Lock Key	Description
CAPS LOCK	When Caps Lock is on, all alphabetic characters typed are in uppercase.
NUM LOCK (Fn-F11)	When Num Lock is on, the embedded keypad is in numeric mode. The keys function as a calculator (complete with the arithmetic operators +, -, *, and /). Use this mode when you need to do a lot of numeric data entry. A better solution would be to connect an external keypad. See External keyboard
SCROLL LOCK (Fn-F12)	When Scroll Lock is on, the screen moves one line up or down when you press \uparrow or \downarrow respectively. Scroll Lock does not work with some applications.

72_0128_001

16 May 2005

© 2005 Itronix Corporation. All rights reserved.





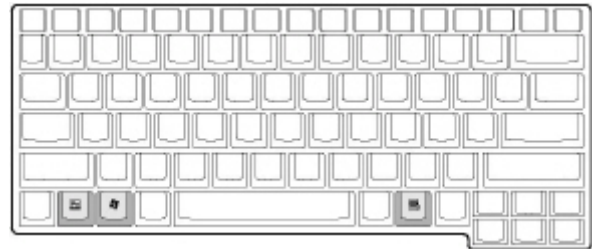

ITRONIX[®]

GoBook[®] PRO II Help

Windows Keys

The keyboard has two keys that perform Windows-specific functions.



Key	Icon	Description
Windows Logo Key		Start button. Combinations with this key perform special functions. Below are a few examples: <ul style="list-style-type: none">  + TAB (Activates next Taskbar button)  + E (Explores My Computer)  + M (Undoes Minimize All) SHIFT +  + M (Undoes Minimize All)  + R (Displays Run dialog box)
Application Key		Opens the application's context menu (same as right-click).

72_0128_001

16 May 2005

© 2005 Itronix Corporation. All rights reserved.

Keyboard Light

72_0128_001

16 May 2005

[© 2005 Itronix Corporation. All rights reserved.](#)

Restarting the Computer

Restarting the Computer

Press...	To do this
CTRL+ALT+DEL twice	Soft reboot the computer. CAUTION All open and unsaved data will be lost.
Press and hold the Power Button for approximately ten seconds and then release it.	Reset the computer CAUTION All open and unsaved data will be lost.

72_0128_001

16 May 2005

[© 2005 Itronix Corporation. All rights reserved.](#)

Activity Status LEDs













Thirteen easy-to-read LEDs under the display screen indicate activity status for common functions.

***insert picture with callout of LEDs



The Power indicators are visible even when you close the display cover so you can see the status of the computer while the cover is closed.

#	Icon	Function	LED	Description
		Power	Steady Green	Computer is on and operating

1			Blinking Green	Computer has suspended to RAM
	External Power		Steady Green	Power is on and external power is applied from one of the following:
				1. The AC Adapter connected to a wall outlet, or
				2. A vehicle-mounted cradle, or
				3. A vehicle power adapter.
2			Blinking Green	AC adapter is in use and computer is in suspend mode
			Steady Green	Battery is charging
3		Battery Power	Blinking Green	Battery is low
			Steady Green	NOTES If the computer is not plugged into external power within a few minutes, it will go into a Suspend Power Mode.
			No Light	If the computer is radio-equipped and is in the middle of communication, it will suspend power to the radio when the battery is low. The computer must then be plugged into external power to continue radio communication. The battery is fully charged or a main battery pack is not fitted.
4		Touch Pad	Steady Green	
		Hard Disk	Blinking Green	Computer is reading from, or writing to the built-in hard disk
5		Disk Drive		
6		Media Bay	Blinking Green	Computer is reading information from the DVD ROM or Combo DVD/CD-RW drive in the Media Bay.
7		Num Lock	Steady Green	Keyboard is in Num Lock mode
8		Caps Lock	Steady Green	Keyboard is in Caps Lock mode
9		Scroll Lock	Steady Green	Keyboard is in Scroll Lock mode
10		WLAN Communication	Steady Green	Wireless LAN radio is on
11		Bluetooth Communication	Steady Green	Bluetooth radio is on
12		GPS Communication	Steady Green	GPS radio is on
		WWAN	Steady Green	WWAN radio is on

72_0128_001

16 May 2005

[© 2005 Itronix Corporation. All rights reserved.](#)**ITRONIX**[®]GoBook[®] PRO II Help

Touchpad

The built-in touchpad is a pointing device that senses movement on its surface. This means the cursor responds as you move your finger over of the touchpad. It also provides all the features of a two-button mouse.

How to Use the Touchpad

1. First, place your fingers on the keyboard in the normal typing position. The touchpad is easily accessible by moving either your left or right thumb off the space bar and onto the touchpad.
2. Gently move your thumb across the pressure-sensitive touchpad in the direction you want the cursor to move. The pad detects the change in pressure and moves the cursor in the corresponding direction.
3. You can also make selections by double-tapping. This function corresponds to double-clicking with a mouse. Once the cursor has been moved to the object you want to select, lightly double-tap the pressure sensitive touchpad. This double-tapping on the touchpad will select the desired item and prompt the software to perform the related operation.
4. The buttons located directly below the touchpad are the same in function as those on a two-buttoned mouse. Clicking these buttons makes selections, drags objects, or performs a variety of other functions depending on the software. To select an object, first move the pointer over the object you want to select, and then press the left button one time. The functions of these buttons are software specific.
5. Double-clicking is a common technique for selecting objects or launching programs from icons. Once you have moved the pointer over the object you wish to select, rapidly press the left button two times. This action is commonly referred to as "double-clicking" an object.



Dragging

- Move the pointer to the desired location then press down the left button. While still holding down the left button, move the pointer to the desired location. Release the button.

- Move the pointer to the desired location. Tap the touchpad twice quickly as if you were double-clicking, however do not remove your finger after the second tap. Move the cursor to the desired location. Lift your finger to finish dragging.

Adjust the touchpad settings by selecting Settings/Control Panel/Mouse/Buttons. These settings allow you to change the orientation of the joystick from right-handed to left-handed, and fine-tune the pointer movement and timing of clicks.

Touchpad Precautions

The touchpad is a pressure-sensitive device. If not properly cared for, it can be easily damaged. Please take note of the following precautions:

- Make sure the touchpad does not come into contact with dirt, liquids or grease.
- Do not touch the touchpad if your fingers are dirty.
- Do not rest heavy objects on the touchpad or the touchpad buttons.

Scrolling buttons

If you are scrolling through a document, you may find that using the scrolling button is more restful to your hand than holding down a mouse button. The scrolling button is located between the touchpad buttons. Push the top of the button to scroll up in a document or Web page; press the bottom of the button to scroll down in a document or web page.

Touchpad basics

The following teaches you how to use the touchpad:

- Move your finger across the touchpad to move the cursor.
- Press the left (1) and right (3) buttons located below the touchpad to do selection and execution functions. These buttons are similar to the left and right buttons on a mouse. Tapping on the touchpad produces similar results.
- Press the center 4-way scroll button (2) to scroll up, down, left, and right on a page. This button mimics the cursor pressing the right and bottom scroll bars of your Windows applications.



Function	Left Button	Right Button	Center Button	Tap
Execute	Click twice quickly.	Tap twice (at the same speed as double-clicking the mouse button).		
Select	Click once.	Tap once.		
Drag	Click and hold, then	Tap twice (at the same speed as double-clicking		

	use finger to drag the cursor on the touchpad.	the mouse button) and hold finger to the touchpad on the second tap to drag the cursor.
Access context menu	Click once.	
Scroll	Click and hold the button in the desired direction (up/down/left/right).	

NOTES

Keep your fingers dry and clean when using the touchpad and keep the touchpad dry and clean.

The touchpad is sensitive to finger movements. It responds best to light touches. Tapping too hard will not increase the touchpad's responsiveness.

72_0128_001

16 May 2005

© 2005 Itronix Corporation. All rights reserved.

ITRONIX[®]

GoBook[®] PRO II Help

The Graphics System

Your computer has a high-performance graphics system that can easily handle the demands of today's multimedia computing. The display offers excellent viewing, display quality and desktop-performance graphics. The computer supports a large Thin-Film Transistor (TFT) liquid crystal display (LCD) displaying up to 16.7 million colors at 1024x768 XGA or 1400x1050 SXGA+ resolution, depending on the LCD display model.

Screen Controls

Adjusting Display Brightness

Function keys can increase or decrease the display brightness.

- FN + F6 decreases the LCD panel brightness
- FN + F7 increases the LCD panel brightness

Adjusting Display Resolution

1. Select My Computer, Control Panel, Display, Settings. Select the Settings tab. The dialog box indicates the monitor resolution.
2. Use the slide bar to adjust the resolution. Normally, you should use the resolution suggested for the LCD or monitor.

NOTE Using a lower resolution than the screen was designed for will reduce the area of the display. You can stretch low resolution displays to full screen size by selecting either the Expanded Display or Display Expansion Mode features in the [BIOS utility](#). However, the stretching may cause distortion, especially to fonts.

Higher resolution modes may be used, as long as the monitor supports them.

Photo Sensor

The built in photo sensor automatically adjusts the display brightness unless you use the function keys to manually adjust display brightness.

NOTE Fn+F6 and Fn+F7 override the photo sensor. Once they have been used, the photo sensor is disabled until the next resume or reboot.

The sensitivity of photo sensor is adjustable in [BIOS Setup Utility](#). The photo sensor does not have a time out setting.

Auto Dim Feature

To save the battery power, your GoBook PRO II automatically dims the display when the computer is not attached to external power.

NOTE You may still use the display brightness function keys (Fn+F6 and Fn+F7) to adjust display brightness.

See [Power management](#) for more information on power management features.

Simultaneous display

The computer's crisp display and multimedia capabilities are great for viewing movies or giving presentations. If you prefer, you can also connect an external monitor when giving presentations. This computer supports simultaneous LCD and external display output via the external display port or the S-video output port. Simultaneous display allows you to control the presentation from your computer and at the same time face your audience. You can also connect other output display devices such as LCD projection panels for large-audience presentations.

Opening and closing the display

To open the display, press the display cover latch and lift up the cover, then tilt it to a comfortable viewing position. See [Connecting your computer](#). The computer employs a microswitch that turns off the display (e.g., enters standby mode) to conserve power when you close the display cover, and turns it back on when you open the display cover.

To close the display cover, fold it down gently until the display cover latch clicks into place.

CAUTION To avoid damaging the display, do not slam it when you close it. Also, do not place any object on top of the computer when the display is closed.

Cursor Visibility

The mobile computer uses a Liquid Crystal Display (LCD), a type of screen used on many notebook and sub-notebook computers. One problem experienced on computers with an LCD display, especially in cold environments, is that the cursor seems to “disappear” whenever the mouse is moved quickly. To improve the visibility of the mouse cursor, you should:

- Enable the “Pointer Trails” feature to add trailing cursors.
- Use a slow or medium speed/sensitivity level.

You can combine a higher level of acceleration with a slow or medium speed/sensitivity level. This allows you to move the mouse cursor quickly by increasing your finger pressure, while still providing a finer degree of control when you apply minimum pressure.

NOTE To change the speed of the mouse, from the Start Menu select Settings, Control Panel, and then choose Mouse to make adjustments.

72_0128_001

16 May 2005

[© 2005 Itronix Corporation. All rights reserved.](#)

ITRONIX[®]

GoBook[®] PRO II Help

Memory

Adding memory allows the computer to operate faster, handle more tasks simultaneously, and work more smoothly with large files. Users who increase memory demands - by adding additional programs, for example - may notice a slowdown in operating speed, and wish to increase memory. The notebook includes a memory card slot for adding additional memory.

Calculate memory size by adding the size of the memory module to the existing built-in memory. For example: 128 MB (module) + 128 MB (built-in memory) = 256 MB Total

Replacing a Memory Card

CAUTION Memory modules can be easily damaged by static electricity. Leave the module inside its static-proof bag until it is ready for installation.

Removing a Memory Card

1. Turn off the computer and disconnect the AC adapter.



Turn the computer upside down and lay it on a flat surface.

2. Carefully remove the two RAM compartment cover screws and remove the RAM compartment cover.
3. Gently pull tabbed latched in the direction of the arrows (1). The card will pop up slightly.
4. Pull upwards on the card and then slide the card out (2).

Inserting a Memory Card

1. Hold the memory card by its edges with the edge-connector side towards the slot.
2. Hold the card at a shallow angle (about 25 degrees) and insert the edge connector into the connector slot. The "gold teeth" of the edge connector should no longer be visible when the card is fully inserted.
3. Press the card downwards so that it is flat inside the compartment. You may hear an audible click as the latches of the connector lock the card in place.
4. Replace the RAM compartment cover and secure it with the two screws.

Your notebook computer will automatically detect the change in RAM capacity when it restarts. You can verify RAM capacity has changed in the [Setup Utility](#) or in Windows:

1. Setup: Press DEL during boot-up when you see the "Hit DEL if you want to run Setup" prompt. Then select Standard CMOS Setup. This screen shows the base memory and the extended memory.
2. Windows: Right click on my computer and select properties. The bottom of the system Properties General tab lists the memory detected by Windows.

72_0128_001

16 May 2005

© 2005 Itronix Corporation. All rights reserved.

ITRONIX[®]

GoBook[®] PRO II Help

Audio

Your computer includes 16-bit high-fidelity stereo audio. The speaker is located above the display.

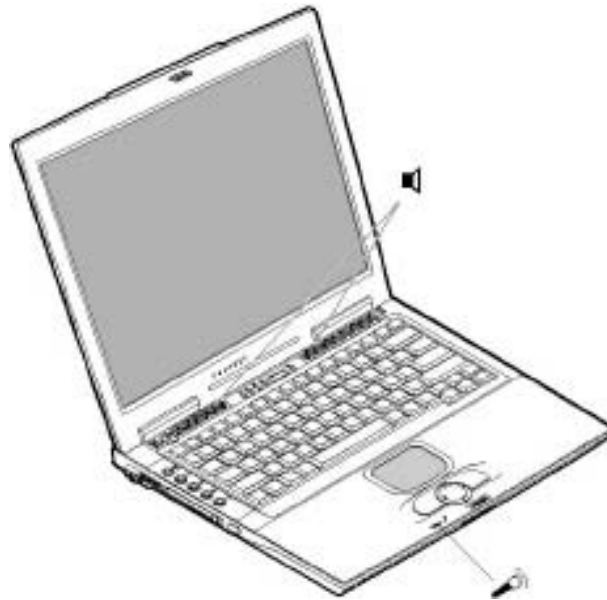

You can attach [external audio devices](#) via the audio ports on the left side of the computer.

Adjusting the Volume

- To increase volume, press FN+F9
- To decrease volume, press FN+F8

You can also adjust the volume with the Windows volume control applet located on the taskbar. However, the volume control function keys override the Windows volume control applet. If your volume is too low or too high after setting the volume in the applet, adjust the volume with the function keys.

72_0128_001

16 May 2005

[© 2005 Itronix Corporation. All rights reserved.](#)

ITRONIX[®]

GoBook[®] PRO II Help

The PC Card Slot

The computer has a built-in CardBus PC Card slot on the left panel of the computer that can accommodate one Type II PC Card. It accepts credit-card sized cards that enhance the usability and expandability of the computer. The PC card slot can be used as an interface between your computer and a variety of communications devices, such as network adapters, SCSI adapters, or fax/modems. They can also be used to provide additional data storage capacity. Please consult your dealer for PC Card options available that you can purchase for your computer.

PC Cards (formerly PCMCIA) are add-on cards for portable computers, giving you expansion possibilities long afforded by desktop PCs. Popular type II cards include flash memory, SRAM, fax/data

modem, LAN and SCSI cards. CardBus improves on the 16-bit PC card technology by expanding the data path to 32 bits.

NOTE Refer to your card's manual for details on how to install and use the card and its functions.

Inserting a Card

1. The top side of a PC Card is usually identified with a label. Insert the card into the slot with the top up and the edge with pinhole contacts going in first. You will feel some resistance as the card slides into the back of the slot.
2. PC Cards require drivers, or a program that allows the [operating system](#) to use a specific device. Many drivers are included with Windows, but if not, you will be prompted to install the driver included with your card.
3. The computer will beep twice to indicate successful installation. A single beep means that there was a problem recognizing the card.

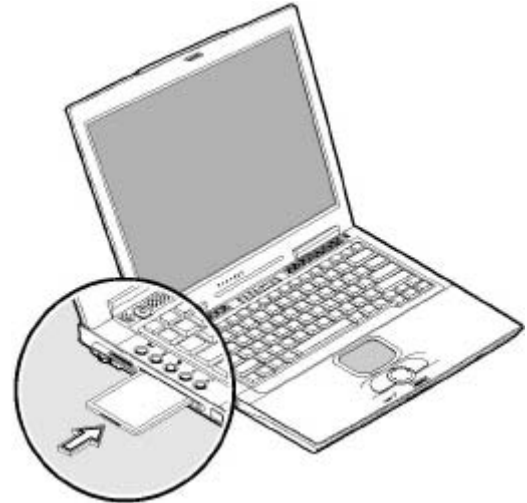

NOTE Please read the instructions included with individual PC Cards. Some cards may be inserted with power on, while others require that the computer be turned off.

Ejecting a Card

1. First, exit the application using the card.
2. Left-click on the [Safely Remove Hardware icon](#) on the taskbar and stop the card operation.
3. Press the slot eject button once (1) to pop it out (2); then press it again (3) to eject the PC Card.

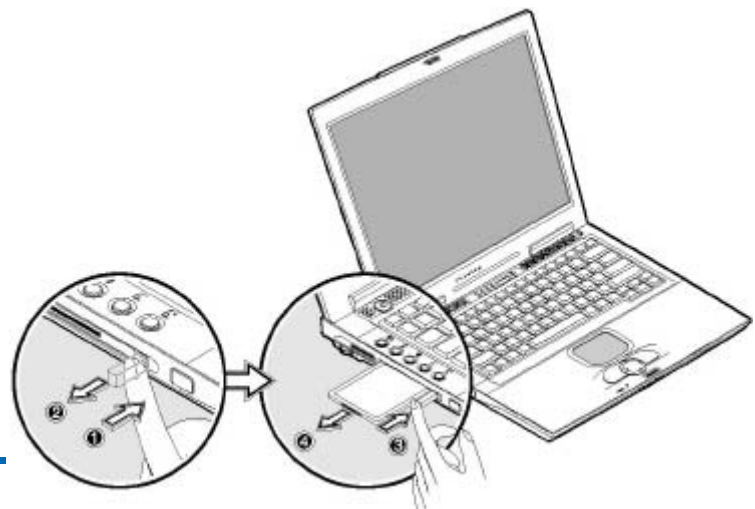

72_0128_001

16 May 2005

© 2005 Itronix Corporation. All rights reserved.

ITRONIX

GoBook® PRO II Help

Memory Stick/SD combo slot (option)

Your computer comes with a Memory Stick/Secure Digital (SD) combo slot (option). This slot is useful

for transferring data to and from a Memory Stick, SD or MultiMediaCard (MMC). Memory cards are used in a variety of digital devices such as digital cameras, digital camcorders and mobile phones.

Insert a card (label side up) into the slot until it clicks into place.

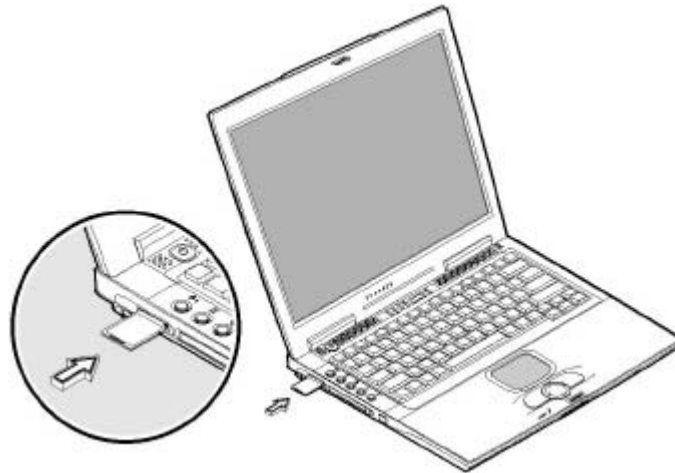

The card now appears on My Computer as a removable storage device that you can copy files to and from.

To remove the card from the slot, do the following:





1. Make sure no operation (e.g., file copying or deletion) is using the card.
2. Press the card further into the slot to release the card (you hear a click); then pull out and remove the card.

72_0128_001

16 May 2005

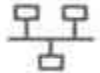
© 2005 Itronix Corporation. All rights reserved.

Ports and Connectors

Icon	Ports and Connectors	Connection	Location
	RJ-11	Phone line/modem (internet and fax)	
	RJ-45	Ethernet	
	DC-in	AC Adapter (power)	
	2 USB 2.0	USB Peripherals such as a mouse or printer	
	Multi-I/O Extension Slot	Vehicle Dock, Desk Mount	
	Audio In	Microphone	

**Audio Out**

Speakers or headphones

**PC Card Slot**

Type II PC Cards

**CompactFlash Slot**

CompactFlash Cards

no icon

Security Slot

Computer lock such as a Kensington lock

Making Connections

Your computer is equipped with a full array of ports and connectors, including standard input/output (I/O) ports for quickly and easily adding peripheral devices such as printers, keyboards, and mice. Refer to documentation included with individual devices for details on connecting these devices to your computer. Your computer also includes IEEE 1394 ports, modem and LAN ports, offering advanced communications technology.

ITRONIX®GoBook® PRO II Help

Attaching Power

insert picture with callout of port

Connect the DC power cable from the AC adapter or the vehicle adapter to this jack.

72_0128_001

16 May 2005

[© 2005 Itronix Corporation. All rights reserved.](#)**ITRONIX®**GoBook® PRO II Help

Attaching an External Monitor or Video Device

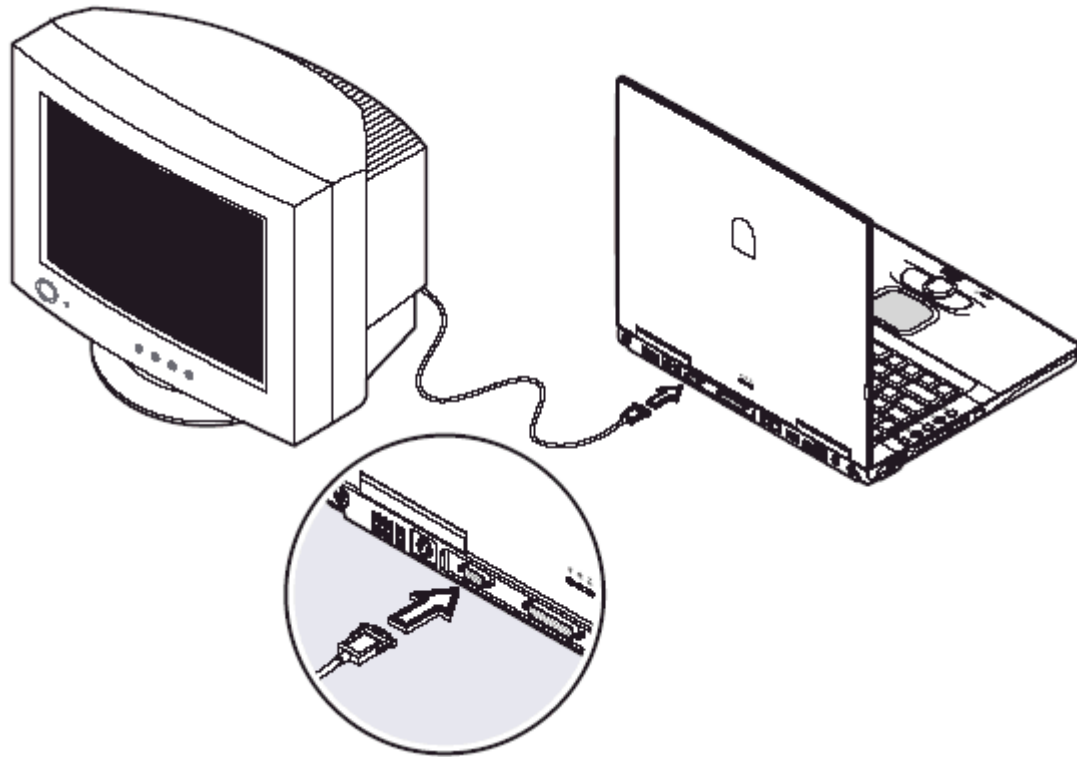

1. The 15-pin VGA port can be used to connect your computer to an external monitor. See [The Graphics System](#) for more information.
2. S-Video technology provides sharper video image on a video or television device than traditional TV-out connections, provided your video display device supports S-Video input.

You can connect an external monitor to the external monitor port on the rear panel. Read the monitor manual for additional instructions.

NOTE If an external monitor is not connected, closing the display cover puts the computer into Standby mode.

Using simultaneous display

Your computer takes advantage of Windows multi-display capability, allowing you to use your computer for presentation purposes. So whatever is displayed in your computer will likewise be displayed on the other external display.

To use simultaneous display, connect an external display device to the external monitor port or S-video output jack. You can then toggle the display output location by pressing Fn-F3 to make the image appear on both the computer LCD and external display device.

Connecting to an External Monitor

The notebook has a VGA monitor port to connect your computer to an external monitor.

Using the VGA monitor port.

1. Locate the 15-pin VGA monitor port on the left side of your notebook and connect the video signal cable from the external monitor (or the VGA adapter) to the monitor port.
2. Connect the power cable from the external monitor to a power outlet and turn on the monitor.
3. On your notebook, click the right touchpad button on the Windows desktop to open the desktop menu. Click Properties to open the Display Properties window.
4. In the Display Properties window, click Advanced in the Settings tab. Click the Display Modes tab.
5. Under Driver mode, you can select the appropriate options to change the display to an external monitor or FN+F2.

Adjustments to screen resolution and color depth can also be made in this dialog box.

Dual Displays

With a Windows system, you may use an external monitor simultaneously with your notebook's LCD. You may also use the external monitor only and disable the LCD or only use the LCD. To do this you may first need to enable the multiple display settings in Windows.

1. Open the Control Panel and double-click Display. The Display Properties window will open.
2. Click the Settings tab, then click the Advanced button.
3. Select the S3 Display tab.

There are two display mode options: Single and Mirror.

Single: In Display Combination, there are two options available: VGA1 or LCD2. You can choose which device to apply as the Primary display. VGA1 is the default value for Primary if an external CRT is available. If an external CRT is not connected to the notebook, only LCD2 is available. In Single mode, the video display hot key combination is available-you can cycle the video output by pressing the FN + F2 keys.

Mirror: In Display Combination, there is no Primary display option available. Only LCD2 is available as Secondary display even when an external CRT is connected. In Mirror mode, the video display hot key combination is available-you can cycle the video output by pressing the FN + F2 keys. If the external CRT is connected, the display on the LCD and the CRT is the same.

TIP To ensure trouble-free video output, the first time you use an external monitor, change the output in the Display Properties dialog box. After successfully switching modes, you may use the video function keys.

NOTE Light or dark dots may appear on the LCD due to technical limitations of LCD manufacturing. This will not effect normal operation of the LCD.

72_0128_001

16 May 2005

[© 2005 Itronix Corporation. All rights reserved.](#)**ITRONIX**[®]GoBook[®] PRO II Help

Attaching USB Devices

The Universal Serial Bus (USB) is the latest standard for attaching keyboards, mice, scanners, and other devices to a PC. USB devices can be chained together on a single cable.

CAUTION To eliminate electromagnetic waves, it is strongly recommended that you thread the USB cable or phone cord through the clip provided when using USB peripherals, audio-out jack or connecting to a phone line.

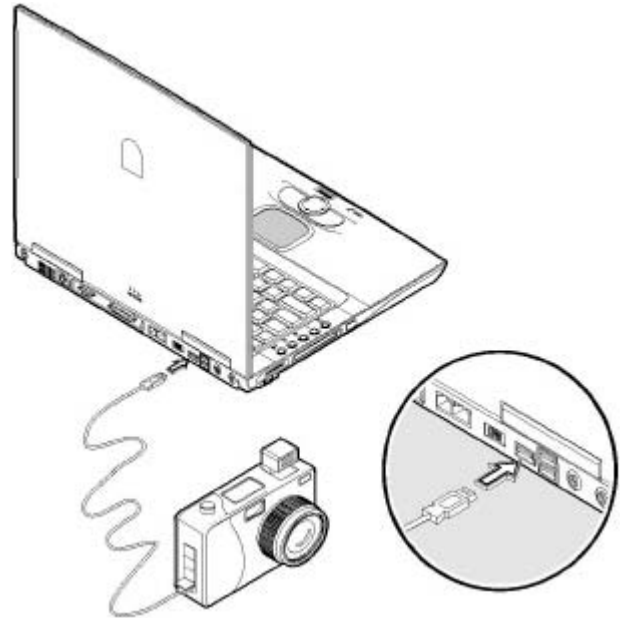

The computer has three USB (Universal Serial Bus) 2.0 ports on the rear of the computer, that allow you to connect peripherals without occupying too many resources. Common USB devices include a mouse, keyboard, and digital camera.

Before disconnecting a USB device from your computer, click on the Safely Remove Hardware icon on the taskbar and click on the device. When the device can be safely removed, disconnect the device from the computer. See your peripheral's documentation for details.

72_0128_001

16 May 2005

[© 2005 Itronix Corporation. All rights reserved.](#)**ITRONIX**[®]GoBook[®] PRO II Help

Ethernet (LAN)

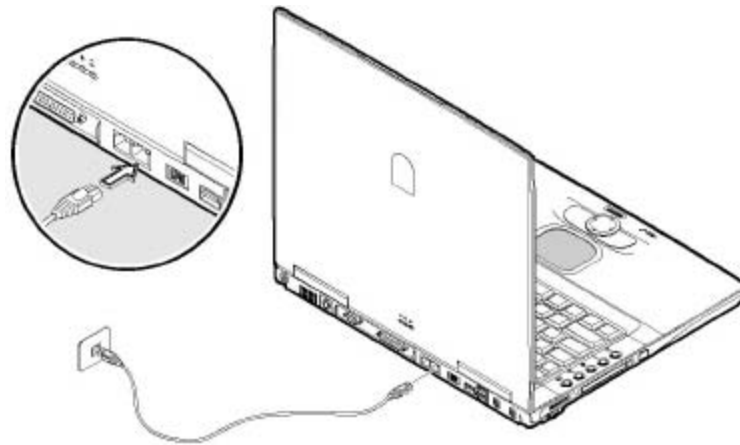

With the built-in Ethernet LAN combo, you can make LAN connections without installing PC cards. Connection speed is 10/100 Mbps standard; 10/100/1000 Mbps optional. When using the LAN function, wrap your LAN cable around the EMI ferrite suppression box to inhibit electromagnetic interference.

To use the network feature, connect an Ethernet cable from the network jack on the rear of the computer to a network jack or hub on your network.

72_0128_001

16 May 2005

[© 2005 Itronix Corporation. All rights reserved.](#)

ITRONIX

GoBook® PRO II Help

Fax/data modem

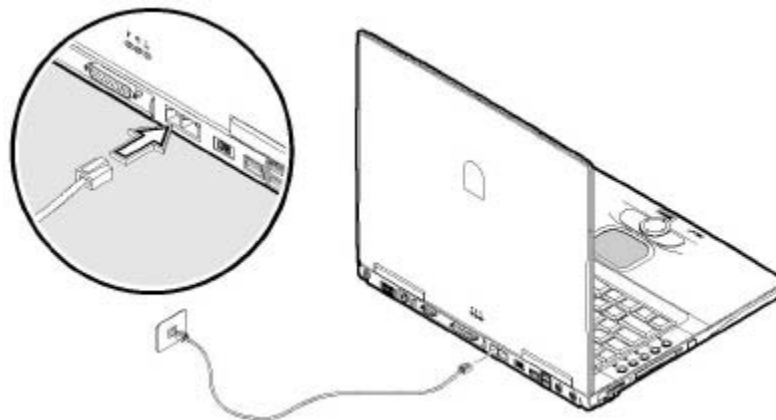

You can use the fax/modem to connect to the Internet to send and receive data using the 56 Kbps V.90 protocol. When used with fax software, it can be used as a fax at 14.4 Kbps. In some countries, local regulations may not permit the use of the fax/modem designed for this system. In this case, you may use a PCMCIA modem. To use the fax/data modem port, connect a phone cable from the modem port to a telephone jack.

CAUTION Plug your modem into an analog telephone jack only. Most homes use analog lines. Do not use digital lines, such as the PBX and ISDN systems found in many offices. Digital lines may damage your modem.

CAUTION To eliminate electromagnetic waves, it is strongly recommended that you thread the USB cable or phone cord through the clip provided when using USB peripherals, audio-out jack or connecting to a phone line.



72_0128_001

16 May 2005

© 2005 Itronix Corporation. All rights reserved.

ITRONIX

GoBook® PRO II Help

Attaching Audio Devices

1. Connect a stereo headset or external speakers to this jack to listen to multimedia.
2. Connect a microphone this jack to record audio.

Audio devices are easy to connect with the audio ports accessible from the rear of the computer. You can plug an external microphone (or an audio line-in device) into the line-in jack. Amplified speakers or headphones connect to the line-out jack. The line-out jack also supports digital audio output (S/PDIF).

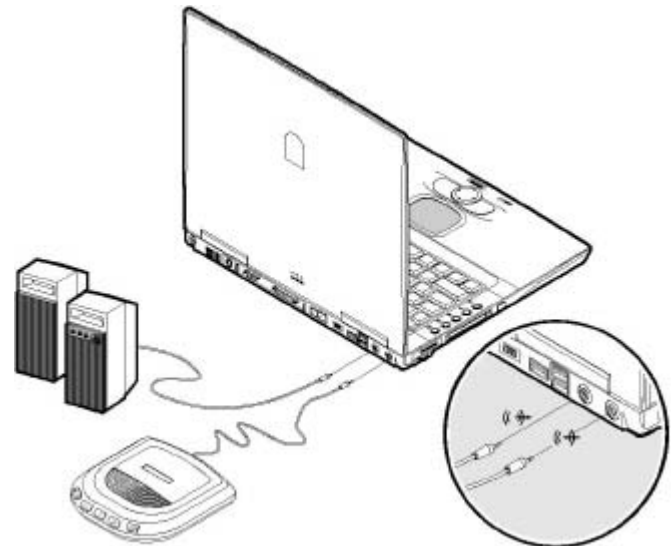

72_0128_001

16 May 2005

© 2005 Itronix Corporation. All rights reserved.

ITRONIX

GoBook® PRO II Help

IEEE 1394 Port (4-pin)

insert picture with callout of port

The IEEE 1394 port is able to transfer large amounts of data at high speed. Because of this ability, the IEEE 1394 port is often used with multimedia devices, such as video cameras. However, a variety of devices that support the IEEE 1394 standard can be connected to this port.

The computer's fast IEEE 1394 ports allow you to connect IEEE 1394 supported devices like a digital video camera or external storage devices.

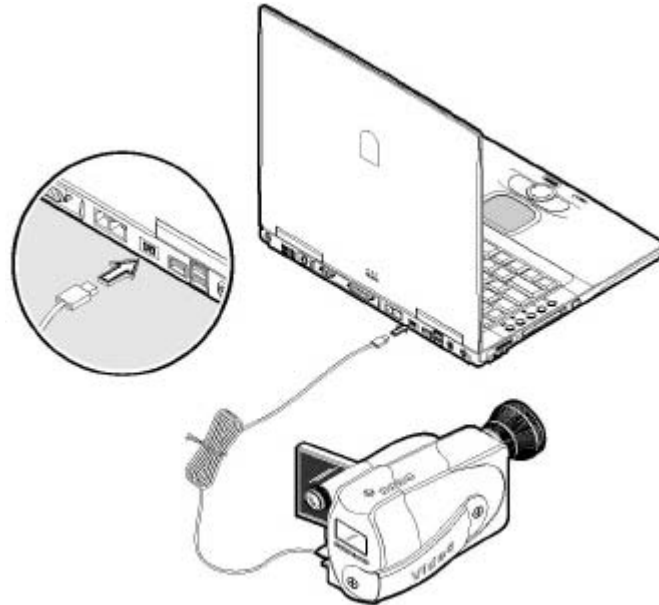

Before disconnecting an IEEE 1394 device from your computer, click on the Safely Remove Hardware icon on the taskbar and click on the device. When the device can be safely removed, disconnect the device from the computer. See your peripheral's documentation for details.

72_0128_001

16 May 2005

[© 2005 Itronix Corporation. All rights reserved.](#)

External keyboard

This computer has a keyboard with full-sized keys and an embedded keypad. If you feel more comfortable using a desktop keyboard, you can connect a USB external keyboard to an available USB port.

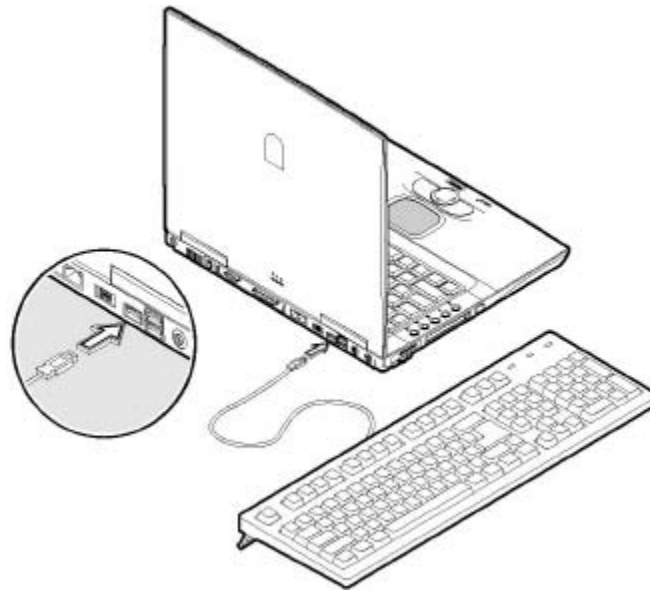

External pointing device

This computer accepts a USB mouse or a similar pointing device. Simply plug it into an available USB port.

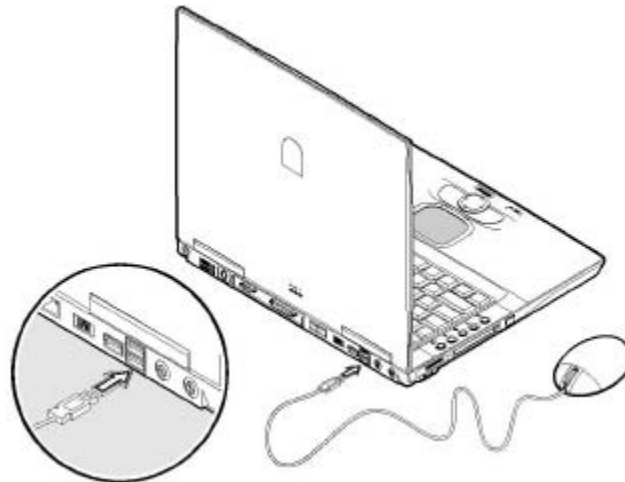

ITRONIX®

GoBook® PRO II Help

Attaching Mobile Phone Earphones

insert picture with callout of port

If your GoBook PRO II has an integrated [GPRS radio](#), you can plug in mobile phone three-pin earphones to the GPRS-in jack to receive phone calls.

See the [Wireless Communication Section](#) for more information.

72_0128_001

16 May 2005

[© 2005 Itronix Corporation. All rights reserved.](#)**ITRONIX**[®]GoBook[®] PRO II Help

Securing Your Computer

Your computer includes a Kensington lock hole to be used with a standard Kensington lock. You can connect the notebook to a large object with the Kensington lock to prevent theft of your notebook. See the documentation that comes with your Kensington lock for more information.

Security features include hardware and software locks — a security slot and password.

Security slot

A security slot located on the [right side](#) of the computer lets you connect a Kensington compatible computer security lock.

Wrap a computer security lock cable around an immovable object such as a table or locked drawer handle. Insert the lock into the notch and turn the key to secure the lock. Some keyless models are also available.

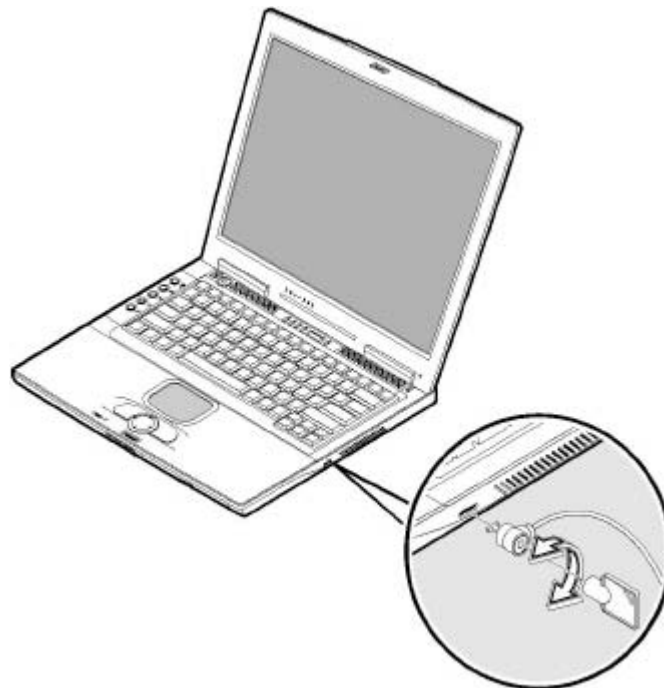

Passwords

Passwords protect your computer from unauthorized access. When set, no one can access the computer without entering the correct password.

There are three types of passwords you can set:

- Supervisor Password secures your computer against unauthorized entry to critical parameters in the [BIOS Utility](#).
- User Password secures your computer against unauthorized use, and allows limited access to the BIOS Utility.
- Hard Disk Password protects your data by preventing unauthorized access to your hard disk, even if the hard disk is physically removed from the computer and installed in another computer.

NOTE Do not forget your Setup and Hard Disk password! If you forget your password, please get in touch with your dealer or an authorized service center.

Fingerprint Scanner (Option)

I/O Security

In a high security environment, sensitive and classified data stored in the computer is restricted to authorized users. Other users cannot communicate with the outside world when using the computer. All the communication IO interfaces (listed below) are selectively enabled/disabled by the supervisor.

- All USB ports (USB1.1 and USB 2.0).
- Audio
- Modem
- LAN (the on-board Ethernet controller)
- WLAN
- 1394 (TI7611 CardBus Controller)
- Express card
- Serial port
- Parallel port

When the device has been disabled, it is completely non-accessible.

Smart Card Security

16 May 2005

© 2005 Itronix Corporation. All rights reserved.

Wireless Communication

Your GoBook PRO supports up to four integrated radios for superior wireless communication.

- WAN
- LAN
- PAN
- GPS

NOTE The radios do NOT function in suspend mode.

ITRONIX®

GoBook® PRO II Help

Antennas

The GoBook PRO II may contain several embedded antenna options to support wireless communications.



#	Antenna
1	CRMA Express Antenna
2	GPS Antenna
3	WLAN Antennas
4	Bluetooth / Diversity for EVDO

CAUTION Please avoid hitting wireless communication antennas as this may adversely affect communications quality.

72_0128_001

16 May 2005

© 2005 Itronix Corporation. All rights reserved.

ITRONIX[®]

GoBook[®] PRO II Help

Bluetooth

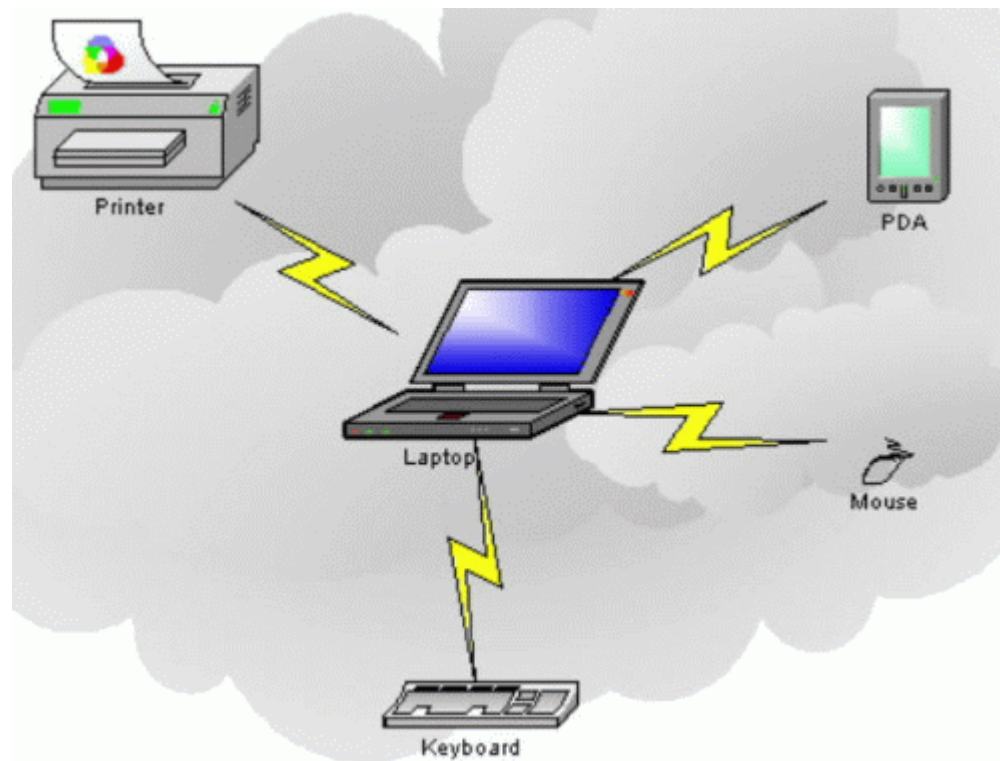

Bluetooth systems create a personal-area network (PAN), or **piconet**, that may fill a room or may encompass no more distance than that between the cell phone on a belt-clip and the headset on your head.

When Bluetooth-capable devices come within range of one another, an electronic conversation takes place to determine whether they have data to share or whether one needs to control the other. The user doesn't have to press a button or give a command -- the electronic conversation happens automatically. Once the conversation has occurred, the devices -- whether they're part of a computer system or a stereo -- form a network.

Once a piconet is established, the members randomly hop frequencies in unison so they stay in touch with one another and avoid other piconets that may be operating in the same room.

One of the ways Bluetooth devices avoid interfering with other systems is by sending out very weak

signals of 1 milliwatt. By comparison, the most powerful cell phones can transmit a signal of 3 watts. The low power limits the range of a Bluetooth device to about **10 meters**, cutting the chances of interference between your computer system and your portable telephone or television. Even with the low power, the walls in your house won't stop a Bluetooth signal, making the standard useful for controlling several devices in different rooms.

72_0128_001

16 May 2005

© 2005 Itronix Corporation. All rights reserved.

ITRONIX[®]GoBook[®] PRO II Help

GPRS Network

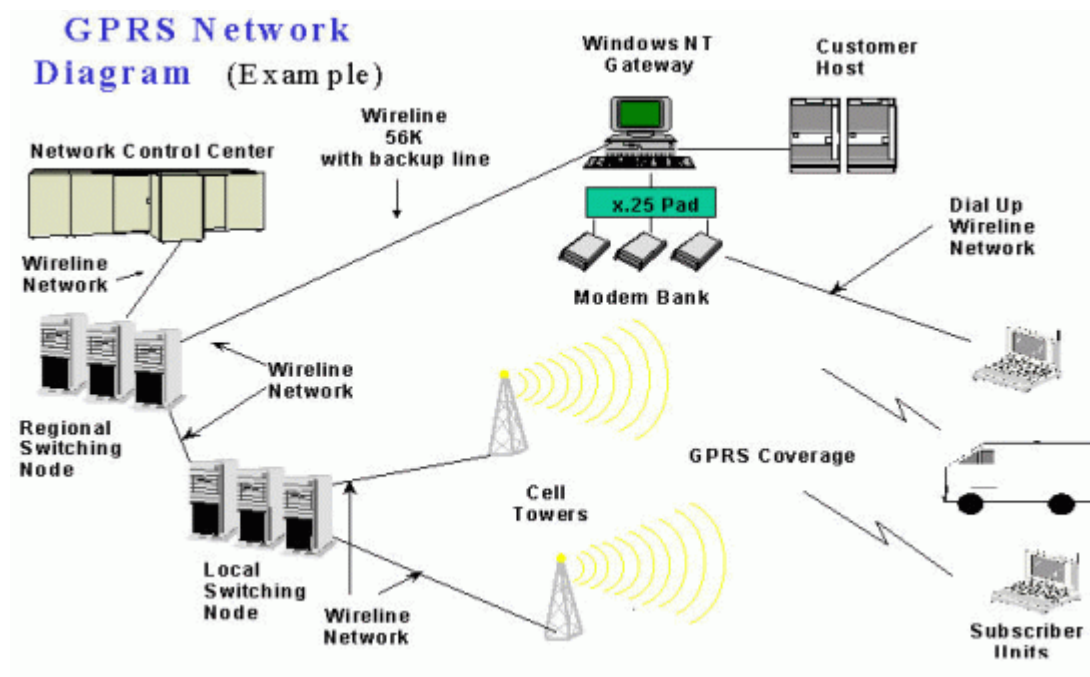

A radio system must be able to generate a radio frequency signal that contains information and then transmit that signal through the atmosphere with enough strength to be received at the appropriate location.

72_0128_001

16 May 2005

© 2005 Itronix Corporation. All rights reserved.

ITRONIX[®]GoBook[®] PRO II Help

Improving Radio Coverage

Wireless connectivity between radio-equipped portable terminals and host computers is unique and maintaining this wireless connectivity over a wide area is fundamental to the usefulness of the network. As such, the scope and reliability of radio coverage is a primary concern. Therefore, one of the most important features of the wireless network is the degree of radio coverage provided. Coverage is influenced by terrain, buildings or a crowded room. There are many things that can be done to improve coverage depending on location.

In any location

1. Performance can vary significantly at different times of the day.
2. Weather can affect performance.

On the street

1. Try all sides of a building to see which side provides the strongest radio signal.
2. Move from under trees. Pine needles absorb radio signals more than leaves.
3. Move away from overhead electrical wires.
4. Radio signals reflect off other buildings. Even in the signal shadow, the signal could be reflected back by another building.
5. Try not to hold the unit. If possible, place it in vehicle, on a cabinet or desk.
6. If holding the unit, turn the unit in 90-degree increments to avoid shielding it with your body.
7. The signal is 1 - 2 feet across; therefore, moving several feet in any direction may give different results.

Inside a Building

1. Move toward windows.
2. Signals do not penetrate ground, therefore, there will probably be no signal in basements.
3. Reflective coatings on windows reflect radio signals. Try the side of the building, the least likely to have coated windows.
4. Closed metal blinds can reflect radio signals.
5. Dropped ceilings sometimes hide an accumulation of electrical cable.

Electromagnetic Interference (EMI)

1. Electromagnetic Interference (EMI) is generated by switching circuitry closets or Un-interruptable Power Source (UPS) systems found near computer rooms and can block the radio signal.

2. Look for significant sources of electromagnetic radiation. The problem may emanate from a source between location and the radio base station.

When to use landline communication

If these tips do not improve radio signal strength, switch to landline communication. Switching to landline communication is faster than searching for and trying to improve the radio signal.

72_0128_001

16 May 2005

© 2005 Itronix Corporation. All rights reserved.

ITRONIX[®]

GoBook[®] PRO II Help

WLAN

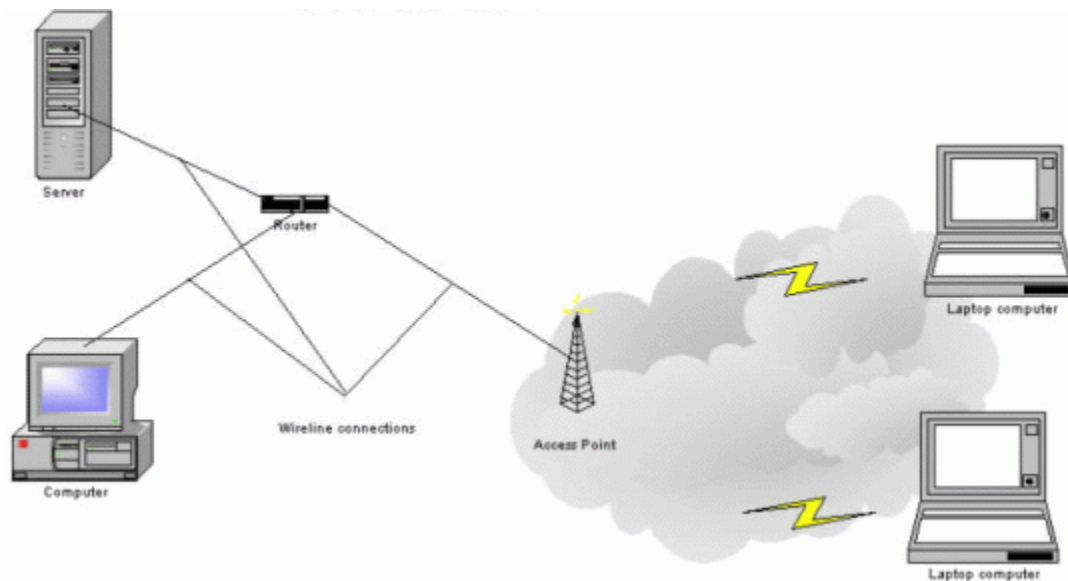

In the simplest of terms, a wireless local-area network (WLAN) does exactly what the name implies: it provides all the features and benefits of traditional LAN technologies, such as Ethernet and Token Ring, without the limitations of wires or cables. But to view a WLAN just in terms of the cables it does not have is to miss the point: WLANs redefine the way we view LANs. Connectivity no longer implies attachment. An infrastructure need not be buried in the ground or hidden behind the walls—an "infrastructure" can move and change at the speed of the organization. This technology has several immediate applications, including:

- IT professionals or business executives who want mobility within the enterprise, perhaps in addition to a traditional wired network
- Business owners or IT directors who need flexibility for frequent LAN wiring changes, either throughout the site or in selected areas
- Any company whose site is not conducive to LAN wiring because of building or budget

limitations, such as older buildings, leased space, or temporary sites

- Any company that needs the flexibility and cost savings offered by wireless, building-to-building bridge to avoid expensive trenches, leased lines, or right-of-way issues

WLANs use a transmission medium, just like wired LANs. Instead of using twisted-pair or fiber-optic cable, WLANs use either infrared light (IR) or radio frequencies (RF). Of the two, RF is far more popular for its longer-range, higher-bandwidth, and wider coverage. Most wireless LANs today use the 2.4-gigahertz (GHz) frequency band, the only portion of the RF spectrum reserved around the world for unlicensed devices. The freedom and flexibility of wireless networking can be applied both within buildings and between buildings.

In-Building WLANs

WLAN technology can take the place of a traditional wired network or extend its reach and capabilities. Much like their wired counterparts, in-building WLAN equipment consists of USB, Personal Computer Interface (PCI), and Industry-Standard Architecture (ISA) client adapters, as well as access points, which perform functions similar to wired networking hubs. Similar to wired LANs for small or temporary installations, a WLAN can be arranged in a peer-to-peer or ad hoc topology using only client adapters. For added functionality and range, access points can be incorporated to act as the center of a star topology and function as a bridge to an Ethernet network as well.

Within a building, wireless enables computing that is both mobile and connected. With a PC Card client adapter installed in a notebook or hand-held PC, users can move freely within a facility while maintaining access to the network.

Applying wireless LAN technology to desktop systems provides an organization with flexibility impossible with a traditional LAN. Desktop client systems can be located in places where running cable is impractical or impossible. Desktop PCs can be redeployed anywhere within a facility as frequently as needed, making wireless ideal for temporary workgroups and fast-growing organizations.

Building-to-Building WLANs

In much the same way that a commercial radio signal can be picked up in all sorts of weather miles from its transmitter, WLAN technology applies the power of radio waves to truly redefine the "local" in LAN. With a wireless bridge, networks located in different buildings can be integrated into a single local-area network. When bridging between buildings with traditional copper or fiber-optic cable, freeways, lakes, and even local governments can be impassible obstacles. A wireless bridge makes them irrelevant, transmitting data through the air and requiring no license or right of way.

Without a wireless alternative, organizations frequently resort to wide area networking (WAN) technologies to link together separate LANs. Contracting with a local telephone provider for a leased line presents a variety of drawbacks. Installation is typically expensive and rarely immediate. Monthly fees are often quite high for bandwidth that by LAN standards is very low. A wireless bridge can be purchased and then installed in an afternoon for a cost that is often comparable to a T1 installation charge alone. Once the investment is made, there are no recurring charges. In addition, today's wireless bridges provide the bandwidth one would expect from a technology rooted in data, rather than voice, communications.

Combination WLANs

Recently a combination of the in building and building to building WLAN has been developed. Two examples are parking lots that are equipped with outdoor access points and vehicles that are equipped with access points.

In the first example, a user is connected and disconnected with the company LAN as they approach or leave the parking area. This allows the user full fast access while in the vehicle. In most cases, the user will still be able to gain access to a portion of the company LAN through a slower and more expensive RF or landline WAN while they are outside of the WLAN area.

In the second example, a user connects to the company WAN with an RF modem located inside the vehicle. When the user leaves the vehicle, the computer is connected to the vehicle using a WLAN connection. The vehicle can either contain a store of information or simply be a pass through to the WAN.

72_0128_001

16 May 2005

© 2005 Itronix Corporation. All rights reserved.

ITRONIX

GoBook® PRO II Help

Fast Infrared

The computer's fast infrared (FIR) port (option) allows you to do wireless data transfer with other IR-aware computers and peripherals such as PDAs (personal digital assistants), mobile phones, and infrared printers. The infrared port can transfer data at speeds of up to 4 Mb/s at a distance of up to one meter.



To use FIR, position two IR-aware devices such that their IR ports are no more than one meter apart and offset no more the 15 degrees.

When the two computers are in position, simply begin the data transfer as you normally would. See your file transfer software for details.

IrDA Communications is used to carry information between components via beams of light in the infrared spectrum. **Infrared** refers to light waves of a lower frequency than human eyes can receive and interpret. Infrared is used in most television remote control systems, and with a standard called IrDA (Infrared Data Association) it's used to connect some computers with peripheral devices. With IrDA communications there are a couple of drawbacks. First, infrared is a "line of sight" technology. For example, you have to point the remote control at the television or DVD player to make things happen.

NOTE In practice, the components should be no closer than 12 inches and no further apart than three feet.

The second drawback is that infrared is almost always a "one to one" technology. You can send data between your desktop computer and your laptop computer, but not your laptop computer and your PDA at the same time.

These two qualities of infrared are actually advantageous in some regards. Because infrared transmitters and receivers have to be lined up with each other, interference between devices is uncommon. The one-to-one nature of infrared communications is useful in that you can make sure a message goes only to the intended recipient, even in a room full of infrared receivers.

72_0128_001
16 May 2005
[© 2005 Itronix Corporation. All rights reserved.](#)

Operating with Battery Power

The computer operates on AC or battery power. This chapter contains the information you need to know to operate the computer on battery power. It also includes information on how your computer manages and saves power.

ITRONIX

GoBook® PRO II Help

Battery pack

The computer uses a battery pack that gives you long use between charges.

Battery pack characteristics

The battery pack has the following characteristics:

- Employs current battery technology standards

The computer uses a Lithium-Ion battery pack which does not have the memory effect problem of Nickel Cadmium (NiCd) batteries. Li-Ion batteries consistently provide the longest battery life, best-suited for road warriors.

- Battery-low warning

When the battery charge level becomes low, the status indicator of the computer flashes at regular intervals. This tells you that the battery power is critically low (and you should save your work). You can correct this situation by recharging the battery pack.

Whenever possible, use the AC adapter. The battery will come in handy when you travel or during a power failure. It is advisable to have an extra fully-charged battery pack available as backup.

Using a battery pack for the first time

When using a battery pack for the first time, follow these steps:

1. Connect the AC adapter to a power source and to the computer and fully recharge the battery.
2. Disconnect the adapter to use up the battery before recharging again.

You only need to do this once or twice with a new battery or with a battery that's been stored without being used for a long time. If the computer is to be stored for more than two weeks, we suggest you remove the battery pack. Battery power from a fully charged battery pack depletes in roughly a day with the computer in Standby mode, a month in Hibernation mode or when power is off.

WARNING Do not expose battery packs to temperatures below 0°C (32°F) or above 60°C (140°F). This may adversely affect the battery pack.

72_0128_001

16 May 2005

© 2005 Itronix Corporation. All rights reserved.

ITRONIX[®]

GoBook[®] PRO II Help

Installing and removing the battery pack

Important! Before removing the battery pack, make sure that you have an AC adapter connected to the computer; otherwise, turn off the computer.

To install a battery pack:

1. Line up battery connectors.
2. Press gently on the battery until it clicks into place.
3. Then slide the battery lock to the lock position.

To remove the battery pack:

1. Slide the battery lock to the unlock position

2. Slide and hold the two battery release latches
3. Gently slide the battery out of the computer.



72_0128_001

16 May 2005

[© 2005 Itronix Corporation. All rights reserved.](#)

ITRONIX

GoBook®
PRO II Help

Battery Calibration

The first time you use a battery, you should calibrate it. The calibration process empties and charges the battery one time. This allows the Windows battery gauge to accurately monitor battery status. To calibrate a battery, follow these steps:

1. Plug in the AC adapter.
2. Restart the computer and when the startup screen appears, press DEL key to enter the Setup Utility.
3. In the Setup Utility, select Power Management Setup , choose Battery Auto Calibration, then press PgDn.
4. You will be prompted to make sure the AC adapter and Battery are present. Do this and then Select Yes to begin "battery auto-learning". Please press Space Bar to select option, and Enter to continue.

Battery Calibration will take from 10 to 16 hours, depending on how much power the battery may already contain.

NOTE For optimum performance, we recommend calibrating the battery every three months.

72_0128_001

16 May 2005

[© 2005 Itronix Corporation. All rights reserved.](#)

Battery Charging

To charge the battery, install the battery pack and plug the AC adapter into the computer and an electrical outlet.

Charging modes

The adapter has two charging modes:

- Rapid mode

The computer uses rapid charging when power is turned off and a powered AC adapter is connected to it. In rapid mode, a fully depleted battery gets 95% charged in approximately 2 hours.

- Charge-in-use mode

When the computer is in use with the AC adapter plugged in, the computer also charges the battery pack if installed. This mode will take longer to fully charge a battery than rapid mode. In charge-in-use mode, a fully depleted battery gets 95% charged in approximately 4 hours.

NOTE We suggest that you charge the battery pack before retiring for the day, letting it charge overnight before traveling. This ensures a fully charged battery for use the next day.

When you use the [AC adapter](#) to connect your GoBook PRO II to a power outlet, the internal battery will automatically begin to recharge. While the battery is charging, the Battery Power Indicator  will be active after 6-12 seconds and will stay solid orange. When the battery is fully charged, the Battery Power Indicator will turn green.

If your computer is turned off, a fully discharged battery will take about 3 hours to recharge. If your computer is turned on and is not in suspend mode, it will take about 6-13 hours to recharge the battery. Refer to the following table:

	Charging	Discharging
System On	6-13 hours	2.5 hours
System Off (Suspend to RAM and Suspend to Disk)	3 hours	—

NOTE A fully charged Li-Ion battery can run the Notebook for approximately 2.5 hours of normal use. (According to Battery Mark benchmark tests). Use of external devices, the media bay and wireless radio

causes increased battery consumption.

When to Replace the Battery

Over time, the battery's capacity gradually decreases. We recommend that you replace your battery when you notice that it begins to store significantly less charge.

Changing the Battery

Change the main battery pack as follows:

1. Turn off the computer.
2. Close the screen and turn the computer over.
3. Slide the side battery latch (1) away from the battery. Continue to hold it until the battery is removed.
4. Gently lift the battery out of the compartment (2).
5. Make sure the replacement battery is properly orientated. Slide back the battery latch (1) then insert the battery into the battery compartment. Check that the latch locks back into position.

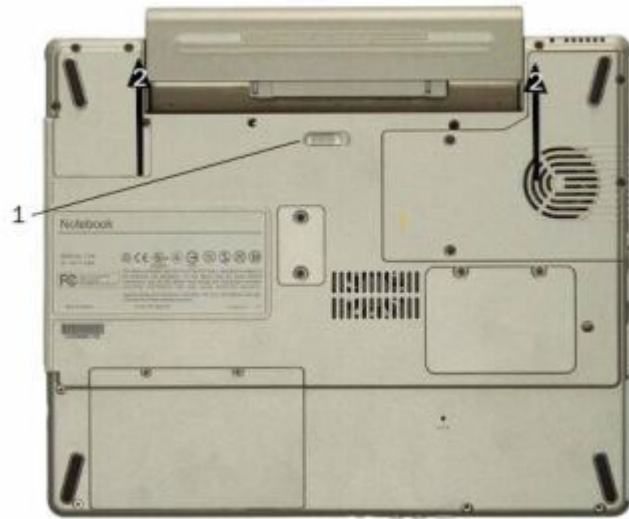

Heat Considerations

The computer's processor has been specially designed to consume as little power as possible, and generates very little heat. However, working in a hot environment, or working for long periods may raise the temperature. The GoBook PRO II takes the following steps to lower temperature:

1. The cooling fan turns on automatically. You may feel air coming from a vent at the left side of the computer when this happens.
2. If the temperature continues to rise, processor activity will be reduced. You may notice a slight loss of performance when this happens.

WARNING If the operating temperature exceeds 40°C (104°F) the system will slowdown to prevent the heat from damaging the computer's infrastructure. If you continue to operate the computer at these high temperatures it will eventually shutdown. When the computer cools to a normal temperature you can restart the system. The higher the temperature, the longer the period the computer will need to cool down.

© 2005 Itronix Corporation. All rights reserved.



GoBook® PRO II Help

Monitoring Battery Power

There are two ways to monitor how much power the battery has left:

1. Select Start, Settings, Control Panel, Power Options; then select the Power Meter.
2. Moving the cursor to the battery icon on the taskbar is the simplest way to check on battery power status. The status will show as a pop-up when you mouse-over the icon.

NOTE If you do not see the battery icon on the taskbar, enable it in Start, Settings, Control Panel, Power Options. Choose the Advanced tab and select "Always show icon on the taskbar."

Low Battery Alarms

How your computer responds to a low battery condition can be set by going to Start, Settings, Control Panel, Power Options, Alarms.

Two different power alarms can be enabled or disabled: the Low Battery Alarm, and the Critical Battery Alarm. Use the slide bar to set the power level at which the alarms are activated. Click on the Action button to choose whether the alarm sounds, displays a message, or both.

CAUTION When battery power is low, the Battery Power Indicator  flashes red and the alarm beeps or displays a warning on your screen. Take immediate action, such as saving files or connecting to the [AC adapter](#), or data may be lost.

When the computer alerts you that the battery is low, immediately do one of the following:

- Connect the AC power adapter
- Save your work and then select Shut Down from the Start menu
- Turn off the computer and replace the discharged battery with a charged battery (See [Battery Charging](#)).

NOTE Do not restart the computer until you have connected to an AC adapter or replaced the discharged battery with a charged battery.

Checking the battery level

The Windows battery meter indicates the present battery level. Simply rest your cursor on the battery meter (or AC plug) icon on the taskbar to see the present charge level of your battery.

Optimizing battery life

This section helps you get the most out of battery operation. Optimizing battery life prolongs the

charge/recharge cycle and improves recharge efficiency. Follow these suggestions to optimize and maximize battery power:

•	Purchase an extra battery pack.
•	Use the AC adapter whenever possible so that the battery is reserved for on-the-go computing.
•	Keep the battery pack in the computer powered by the AC adapter. The constant trickle charge maintains the battery level to eliminate the battery self-discharge effect. The charge-in-use function also charges the battery pack.
•	Eject the PC card from the card slot when it is not in use, since the PC card draws extra power. See Ejecting a card .
•	Store the battery pack in a cool, dry place. The recommended storage temperature for battery packs ranges from 10 to 30 degrees Celsius. The higher the storage temperature, the faster the battery pack self-discharges.
•	The batteries can be recharged about 400 times when used as directed. Excessive recharging decreases battery life.
•	Take care of your battery pack and AC adapter. See Safety and maintenance .

Battery-low warning

You never have to worry about battery power as long as you are using the AC adapter. However, when you operate the computer on battery power, pay extra attention to the power indicator on the display panel.

During a battery-low condition, the power indicator flashes at regular intervals until battery power is depleted.

WARNING Connect the AC adapter to the computer as soon as possible. Data is lost when computer power is cut off during Standby mode.

The following table shows the recommended course of action to take when you encounter a battery-low condition.

Situation	Recommended Action
AC adapter and power outlet available	<ol style="list-style-type: none"> 1. Connect the AC adapter to the computer. 2. Save all necessary files. 3. Resume work. Power off the computer if you wish to recharge the battery rapidly.
An extra fully-charged battery pack available	<ol style="list-style-type: none"> 1. Save all necessary files. 2. Exit the application. 3. Power off the computer. 4. Replace the battery pack. 5. Power on the computer and resume work.

AC adapter or power outlet not available	<ol style="list-style-type: none">1. Save all necessary files.2. Exit the application.3. Power off the computer.
--	--

Power management

The GoBook PRO II has power management capability so you can reduce the amount of energy used, especially during periods of inactivity. Effective use of power management options can greatly conserve and extend your battery life.

This computer has a built-in power management unit that monitors system activity. System activity refers to any activity involving one or more of the following devices: keyboard, mouse, floppy drive, hard disk, peripherals connected to the serial and parallel ports, and video memory. If no activity is detected for a period of time (called an inactivity timeout), the computer stops some or all of these devices in order to conserve energy.

This computer employs a power management scheme that supports ACPI (Advanced Configuration and Power Interface) which allows for maximum power conservation and maximum performance at the same time. Windows handles all power-saving chores for your computer.

Advanced Configuration and Power Interface

Advanced Configuration and Power Interface (ACPI) is a power management specification jointly developed by Compaq, Intel, Microsoft, Phoenix and Toshiba. ACPI enables Windows to control the amount of power given to each device attached to the computer. With ACPI, Windows can turn off peripheral devices when they are not in use, thereby saving power.

NOTE We recommend you enable power management to prolong your battery life.

Refer to Windows help for more details.

72_0128_001
16 May 2005
[© 2005 Itronix Corporation. All rights reserved.](#)

ITRONIX

GoBook® PRO II Help

Power Management

Power Saving Modes

Adjust the default power management settings in the Power Options / Advanced dialog box in the Control panel. The Power Options Properties dialog box allows you to set different actions to take when the computer is left idle for a certain amount of time.

Suspend Mode

There are several possible settings for suspend mode, which can be selected in the Power Management dialog box: You may have the notebook standby, hibernate, or you can power off the computer altogether.

[Standby](#)

[Hibernate](#)

[Power Off](#)

Initiating Suspend Mode

There are five ways to initiate suspend mode. The settings can be adjusted in the Power Management profile dialog box:

1. The computer will automatically enter suspend mode when not used for a set period of time
2. Selecting the Standby button in the Shut Down Windows dialog box
3. Closing the screen cover (assuming no external monitor has been connected)
4. Pressing the Power Button (if enabled in Power Settings)
5. Pressing the suspend function key FN+F3

Using the Setup Utility for Power Management

With Windows running in ACPI mode, power can be controlled through the Power Management dialog box only. With operating systems that use ACPI power management, Setup power settings have no effect.

Power Button Settings

The function of the Power Button can be set to Shutdown, Hibernate, or Standby in the Power Management Properties dialog box in the Control Panel. However, holding the Power Button down for more than four seconds will force a power off while operating under any situation, resulting in the loss of any unsaved information.

72_0128_001

16 May 2005

© 2005 Itronix Corporation. All rights reserved.

ITRONIX[®]

GoBook[®] PRO II Help

Battery Tips

Tip 1. Avoid excessive heat and cold

- Your battery will last longer during the day if it is used, charged and stored between 50°F and 86°F (10°C and 30°C).
- Charge the battery nightly where the temperature will remain around 68°F (20°C). Your battery may not last as long through the day if you charge it at higher or lower temperatures.
- Allow unrestricted airflow while the computer is connected to external power. Make sure that the fan inlet and outlet are unobstructed.
- Avoid exposing batteries to hot or cold temperatures for long periods.

[How your battery behaves in warm conditions](#)

[How your battery behaves in cold conditions](#)

Tip 2. Prevent wasted power

- Manually turn off or suspend your computer whenever you are not using it.
- Reduce the screen brightness. Decrease brightness by pressing FN+F6. Increase it by pressing FN+F7.
- Use the AC adapter or vehicle adapter whenever possible.
- Select either the Portable/Laptop or Max Battery power scheme. Both of these power schemes help to conserve battery power. Max Battery provides the most battery conservation by always keeping the processing speed lower. However, this may affect your application performance. Portable/Laptop automatically adjusts the processing speed as required by your applications.
- When running on battery power, make sure your system suspends automatically after a few minutes of inactivity. PC Cards, radios, custom applications, or modified system settings may affect this.
- Remove PC Cards and unplug peripherals when you are not using them. They may draw power from the system even when not in use.
- Avoid operating the fax/modem, or audio and video applications when using battery power. Operating a fax/modem, video, or audio equipment increases the computer's power requirements.
- Don't use screen savers as they draw excessive current, especially "3D" screen savers.
- Avoid or minimize using applications that keep the CPU busy a large percentage of the time. The following will help you determine if your system is running such applications:
- Turn off the Wireless LAN when not using it. Turning on the Wireless LAN increases the computer's power requirements.

Identifying power wasting programs

What to do if applications are keeping the CPU busy

Tip 3. Calibrate your battery

- Over time, the accuracy of the Windows battery gas gauge may be affected by repeated charging and discharging of the battery. Calibrating the battery every three or four months helps to keep the gas gauge accurate. For information on calibrating the battery, refer to [Battery Calibration](#).

Tip 4. Get a good charge

- Your computer will charge more quickly if it is turned off or suspended.
- In warmer or cooler temperatures, your battery can take much longer to fully charge.
- If your battery is charged in a cold (less than 41°F/5°C) or very warm (greater than 122°F/50°C) environment, it is possible that the Battery Charge LED will indicate that the charge has stopped; however, this does not necessarily mean that your battery is fully charged.

Tip 5. Prevent data loss

Follow these guidelines to prevent data loss when removing your battery or storing your computer:

- You will lose data if you remove the battery while the computer is operating or suspended. To prevent this, shutdown your computer or put it into hibernate (suspend-to-disk) mode before removing your battery.
- If you plan to store your computer for more than a few days, shutdown your computer or put it into hibernate mode. Remove the battery before storing the computer.

Tip 6. Clean terminals

- Dirty terminals can be a cause of charging problems. Clean battery terminals with a cotton swab dipped in isopropyl alcohol. Make sure that the alcohol has evaporated before reinstalling the battery.

Tip 7. Storing batteries

- Store the battery within the recommended temperature range: 10°C to 30°C (50°F to 86°F).
 - Unused or stored batteries can lose power over time. When you install a battery that has not been used for awhile, connect external power to the computer and fully charge your battery.
 - Battery calibration may increase the capacity of a battery stored for a period of time. For information on calibrating the battery, refer to [Battery Calibration](#).
 - It is recommended that the battery is recharged every six months while in storage.
-

72_0128_001

16 May 2005

© 2005 Itronix Corporation. All rights reserved.

System Software

This chapter discusses the important system utilities bundled with your computer.

ITRONIX®

GoBook® PRO II Help

Launch Manager

Launch Manager allows you to set the launch keys (excluding the wireless LAN button) located to the left of the keyboard. See [Quick Launch Buttons](#) for the location of these keys.

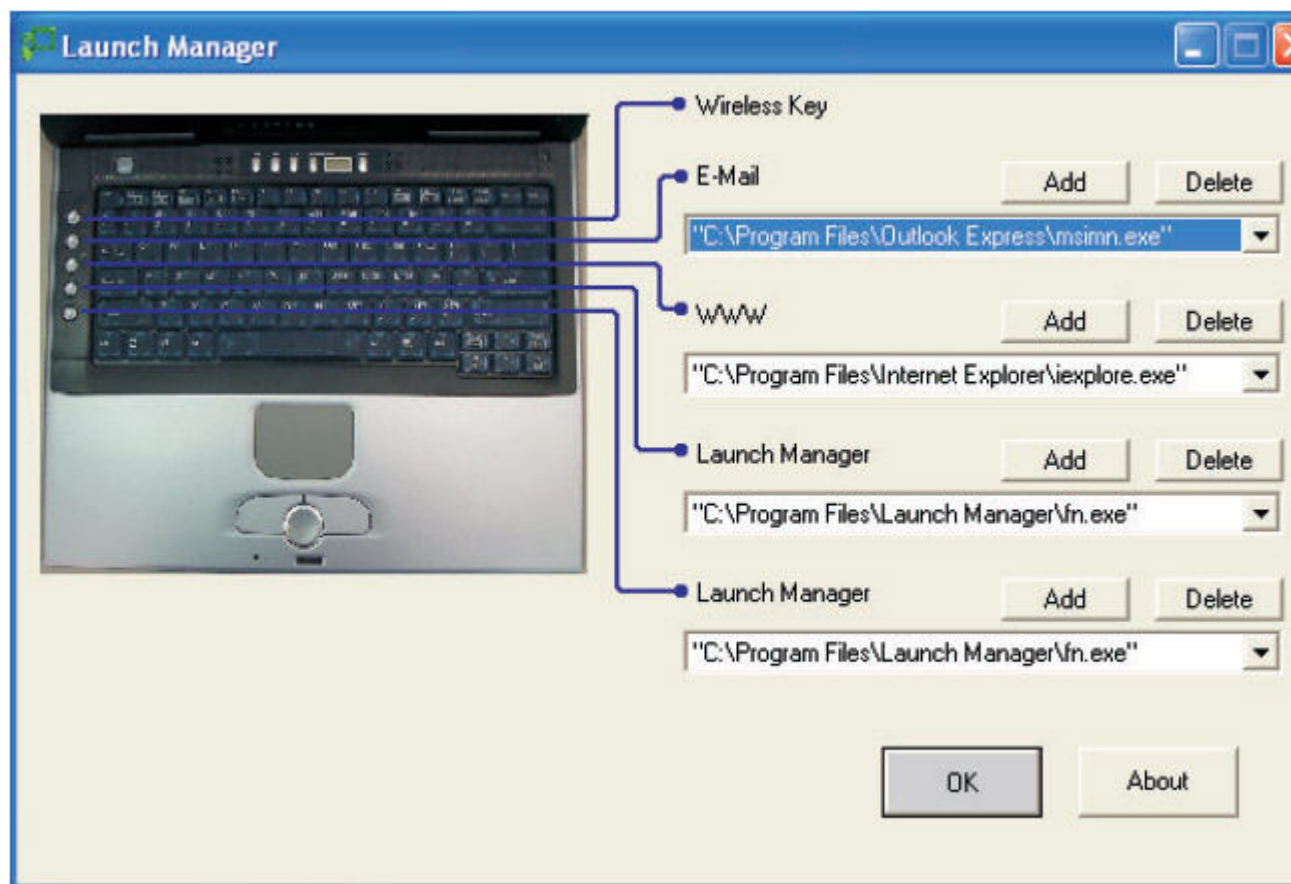

You can access the Launch Manager by selecting Start, All Programs, and then Launch Manager. Pressing an unassigned launch key also brings up the Launch Manager.

72_0128_001

16 May 2005

© 2005 Itronix Corporation. All rights reserved.

Customizing Your BIOS Settings

The BIOS Utility is a hardware configuration program built into your computer's BIOS (Basic Input/Output System).

Your computer is already properly configured and optimized, and you do not need to run this utility. However, if you encounter configuration problems, you may need to run it. Please also refer to [Troubleshooting](#) if a problem arises.

This chapter explains how to use the Setup Utility to modify the BIOS settings. The Setup Utility displays and allows modification of the GoBook PRO II components and the configuration of devices that are connected to it. This information is used to test and initialize components at start-up time and to make sure everything runs properly when the system is operating.

The GoBook PRO II is configured with a set of default values. You may be able to increase system performance by changing some of the timing values in the Setup Utility, but this can be limited by the kind of hardware you are using. In certain circumstances, the system may generate an error message that asks you to make changes to the BIOS settings using the Setup Utility. This happens when the system finds an error during the POST (Power On Self Test) that it carries out at startup.

CAUTION It is not recommended that you change any settings since this may cause the unit to not function properly.

If you are not sure how to configure the BIOS settings we suggest that you select "Auto configuration with Optimal Settings" on the Main Menu screen, then exit saving changes. This loads optimized default settings for normal use.



Using the Setup Utility

The Setup Utility allows you to configure your computer's basic settings. When you turn your computer on, the system reads this information to initialize the hardware so that it can operate correctly. You can use the Setup Utility to change your computer's start-up configuration. For example, you can change your system's security routine.

Starting the Setup Utility

You can only start the Setup Utility shortly after the computer has been turned on or rebooted. To execute a controlled reboot select Start, Shutdown, Restart. To activate the BIOS Setup Utility, press **F2** during POST.

NOTE The BIOS password settings affect this option. If a user or supervisor password has been previously entered, you will be asked for a password.

The Setup Utility has the following menu options:

Field	Description
-------	-------------

Information	displays a summary of the computer's hardware information
Main	contains basic settings about your computer such as date, time, and boot options
Advanced	allows you to view and configure your drives, and I/O (input/ output) ports
Security	lets you set passwords for protecting your computer
Boot	allows you to set the order in which the system boots up
Exit	includes options to save or discard your changes, and to exit the BIOS Utility

NOTE Certain parameters are highly technical. Do not make changes to parameters if you do not understand the function of the particular parameter.

Navigating and Entering Information in the BIOS

To enter a menu, highlight the item using the ← → keys. Use the following keys to move between fields and to enter information.

Key	Function
Del	Starts the Setup utility after turning on the computer
Esc	Exits any submenu. If you wish to exit the Setup utility without saving changes, go to the main menu, then press Esc
↑↓	Moves among selections
Up, down arrow keys / Tab cursor	Selects an item
up/down keys	
Enter	Makes a selection or go into a sub-menu
F5 or F6	Change the value of a parameter
F10	Saves changes, then exits

NOTE You can change the value of a parameter if it is enclosed in square brackets. Navigation keys for a menu are shown at the bottom of the screen. Please refer to the help information that displays on the Item Specific Help pane of the BIOS Setup Utility as you select a parameter.

For optimum settings, press **F9** to load setup defaults; then press **F10** to save the changes and exit the BIOS Setup Utility.

NOTE Don't forget your password. If you forget your password, you may have to return your notebook computer to your dealer to reset it.

Most Used Setup Options

The following are the most frequently used options in the BIOS Setup Utility.

Setting passwords

You can set, change or remove passwords in the Security menu.

To set a password:

1. Use the **↑** and **↓** keys to highlight a password parameter (Supervisor, User or Primary Hard Disk) and press the **Enter** key. The password box appears:

Set Password	
Enter New Password	[]
Confirm New Password	[]

2. Type a password in the Enter New Password field. The password may consist of up to eight alphanumeric characters (A-Z, a-z, 0-9).

NOTE Be very careful when typing your password because the characters do not appear on the screen.

3. Press **Enter**. Then re-enter the password in the **Confirm New Password** field, and press **Enter**.

Setup Notice
Changes have been saved. [Continue]

4. Press **Enter** to accept the changes and save the password.

To change or remove a password:

1. Use the **↑** and **↓** keys to highlight a password parameter and press **Enter**. The following box appears.

Set Password	
Enter Current Password	[]
Enter New Password	[]
Confirm New Password	[]

2. Enter the current password, then press **Enter**.
 - o To change the password, type in a new password in the **Enter New Password** field and press **Enter**. Then re-enter the password in the Confirm New Password field and press **Enter**.
 - o To remove the password, press **Enter** twice (once each in the **Enter New Password** and **Confirm New Password** fields) without typing anything in the fields.

Setup Notice
Changes have been saved. [Continue]

3. Press **Enter** to accept the changes.

About the boot drive sequence

In the Boot menu, use the cursor up/down keys $\uparrow\downarrow$ to select a boot device, then press **F5** or **F6** to change its order. Items with a “+” sign can be further expanded.

72_0128_001
16 May 2005
[© 2005 Itronix Corporation. All rights reserved.](#)

ITRONIX[®]

GoBook[®] PRO II Help

The Main Menu

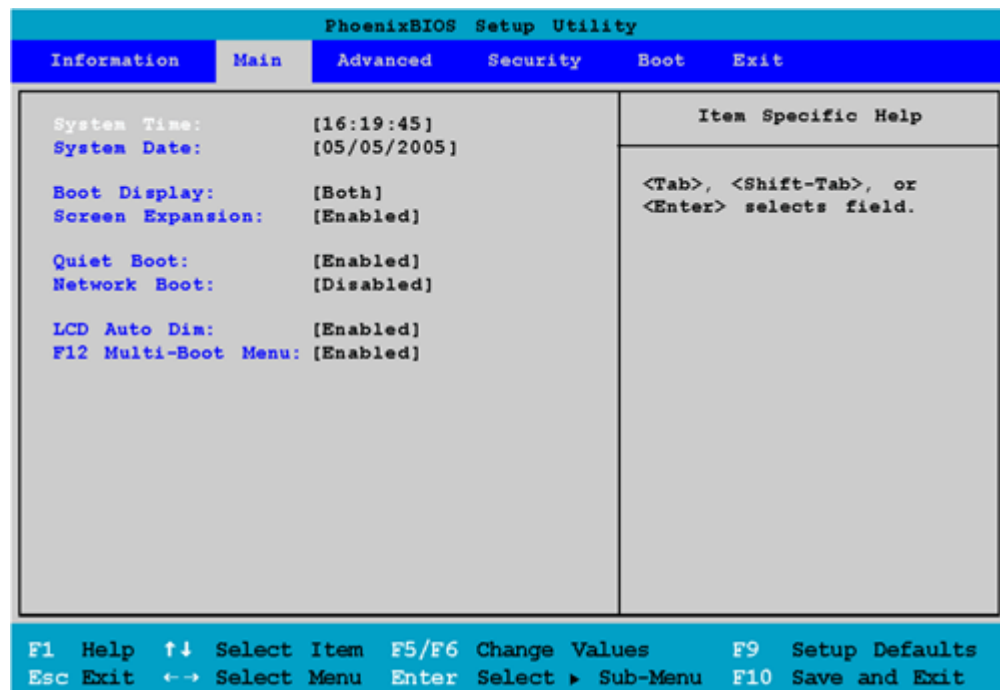

Field	Setting	Function
System Time		Sets the system time. Format: HH:MM:SS (Hour : Minute : Second)
System Date		Sets the system date. Format: MM/DD/YYYY (Month/Day/Year)
Boot Display	Auto Both	Sets the display output device on boot up. Both: the computer turns on both the LCD and external monitor if an external monitor is attached and operational. Auto: the computer automatically determines the display device. If an external display device (monitor) is connected, it becomes the boot display.
Screen Expansion	Enabled Disabled	
Quiet Boot	Enabled Disabled	When set to enabled, the system will show the graphic picture screen on boot up. When Quiet Boot option is set to [Enabled] in BIOS Setup, right after we turn on or reset the computer, system displays a graphic illustration created by the computer

		manufacturer instead of the text-based POST screen, which display a number of PC diagnostic messages.
Network Boot	Enabled Disabled	When set to enabled, system will Network Boot.
LCD Auto Dim	Enabled Disabled	The system will support Auto-Dim of the LCD backlight when the AC power source is NOT available (running on battery power).
F12 Multi-Boot Menu	Enabled Disabled	Users could choose if they want to display the "F12 to enter Multi Boot Menu" message during post.

72_0128_001

16 May 2005

© 2005 Itronix Corporation. All rights reserved.

ITRONIX

GoBook® PRO II Help

The Advanced Menu

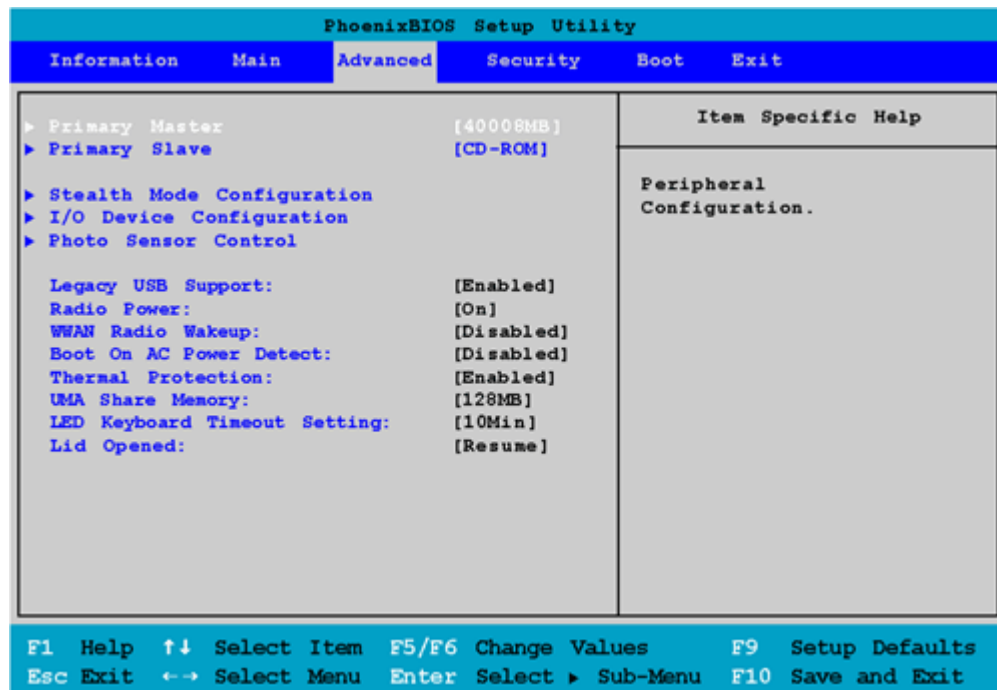

Field	Setting	Function
Primary Master	sub-	Configure Peripherals

Primary Slave	menu sub- menu	Configure Peripherals
Stealth Mode Configuration	sub- menu	Configure Stealth Mode
I/O Device Configuration	sub- menu	Configure I/O Devices
Photo Sensor Control	sub- menu	Set photo sensor settings
Legacy USB Support	Disabled Enabled	When set to enable, system can support legacy USB devices
Radio Power	Off On	When this option is set to "on", all wireless devices are powered on when the system reboots
WWAN Radio Wakeup	Disabled Enabled	This option determines the WWAN radio power when the system is suspended. When set to "Disabled" the radio power is turned off before system enters standby state (S3) When set to "Enabled" the radio power it turned on before the system enters S3
Boot On AC Power Detect	Disabled Enabled	Once the user plugs in AC Power, the system will boot up or resume automatically if this option is set to enable
Thermal Protection	Disabled Enabled	If enabled, the system can NOT boot up in temperatures between 0 and -20 C. If disabled, the system can boot up in these temperatures
UMA Share Memory	64MB 128MB	The size of the main memory that is allocated to support the Internal Graphics device in VGA
LED Keyboard Timeout Setting	5Min 10Min 15Min 20Min 30Min 40Min 50Min 60Min 80Min 100Min 120Min 240Min	Choose the interval at which the timeout counter is reset for PS2 key and/or mouse activities
Lid Opened	Nothing Resume	If set to "Nothing" there is no action taken when the Lid is opened. If set to "Resume", the system will

resume from a suspended state when the lid is opened.

Primary Master

PhoenixBIOS Setup Utility	
Advanced	
Primary Master [40008MB]	Item Specific Help
Type: [Auto] LBA Format	User = you enter parameters of hard-disk drive installed at this connection.
Total Sectors: 78140160	Auto = autotypes hard-disk drive installed here.
Maximum Capacity 40008MB	CD-ROM = a CD-ROM drive is installed here.
Multi-Sector Transfers: [16 Sectors]	ATAPI Removable = removable disk drive is installed here.
LBA Mode Control: [Enabled]	
32 Bit I/O: [Disabled]	

F1 Help ↑↓ Select Item F5/F6 Change Values F9 Setup Defaults
Esc Exit ←→ Select Menu Enter Select ► Sub-Menu F10 Save and Exit

Primary Slave

PhoenixBIOS Setup Utility		
Advanced		
Primary Slave	[CD-ROM]	Item Specific Help
Type:	[Auto]	User = you enter parameters of hard-disk drive installed at this connection. Auto = autotypes hard-disk drive installed here. CD-ROM = a CD-ROM drive is installed here. ATAPI Removable = removable disk drive is installed here.
Multi-Sector Transfers:	[Disabled]	
LBA Mode Control:	[Disabled]	
32 Bit I/O:	[Disabled]	
Transfer Mode:	[FPIO 4 / DMA 2]	
Ultra DMA Mode:	[Mode 2]	
F1 Help ↑↓ Select Item F5/F6 Change Values F9 Setup Defaults Esc Exit ←→ Select Menu Enter Select ► Sub-Menu F10 Save and Exit		

Stealth Mode Configuration

PhoenixBIOS Setup Utility		
Advanced		
Stealth Mode Configuration		Item Specific Help
Stealth Mode:	[Disabled]	If the Stealth Mode is set to "Disabled", the sub-options in Stealth mode are grayed. The LEDs, Fan, system beeps, audio and display brightness operate normally.
LED	[OFF]	
Fan	[OFF]	
System Beeps	[OFF]	
Audio	[OFF]	
Display Backlight Brightness	[OFF]	
Wireless Devices	[OFF]	
F1 Help ↑↓ Select Item F5/F6 Change Values F9 Setup Defaults Esc Exit ←→ Select Menu Enter Select ► Sub-Menu F10 Save and Exit		

Field	Setting	Function
Stealth Mode	Disabled	
	Enabled	

LED	Off
	On
Fan	Off
	On
System Beeps	Off
	On
Audio	Off
	On
Display Backlight Brightness	Off
	On
Wireless Devices	Off
	On

I/O Device Configuration

PhoenixBIOS Setup Utility	
Advanced	
I/O Device Configuration	Item Specific Help
Serial Port A: [Enabled]	User can have a configuration on this serial port when setting to enable.
Base I/O address: [3F8h]	
Fan [IRQ 4]	
Serial Port for GPS: [Enabled]	
Interrupt: [IRQ 5]	
F1 Help ↑↓ Select Item F5/F6 Change Values F9 Setup Defaults Esc Exit ←→ Select Menu Enter Select ▶ Sub-Menu F10 Save and Exit	

Field Setting Function

Photo Sensor Control

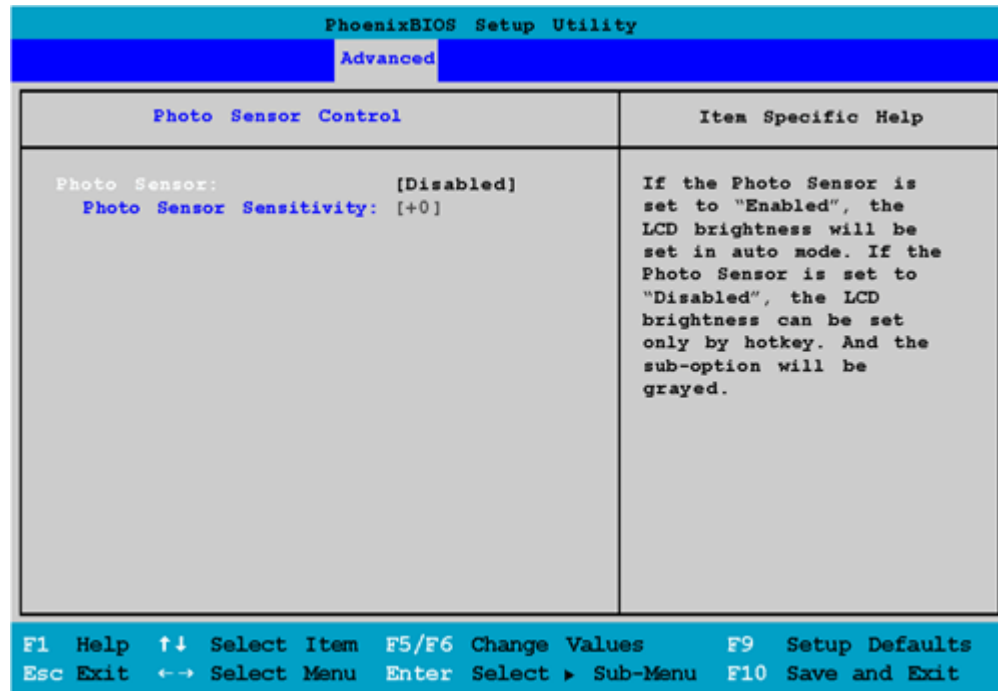

Field Setting Function

72_0128_001

16 May 2005

© 2005 Itronix Corporation. All rights reserved.

ITRONIX[®]

GoBook[®] PRO II Help

The Information Page

This page displays information about your computer from what kind of CPU and how much memory the computer has, to pertinent numbers such as the product number and serial number:

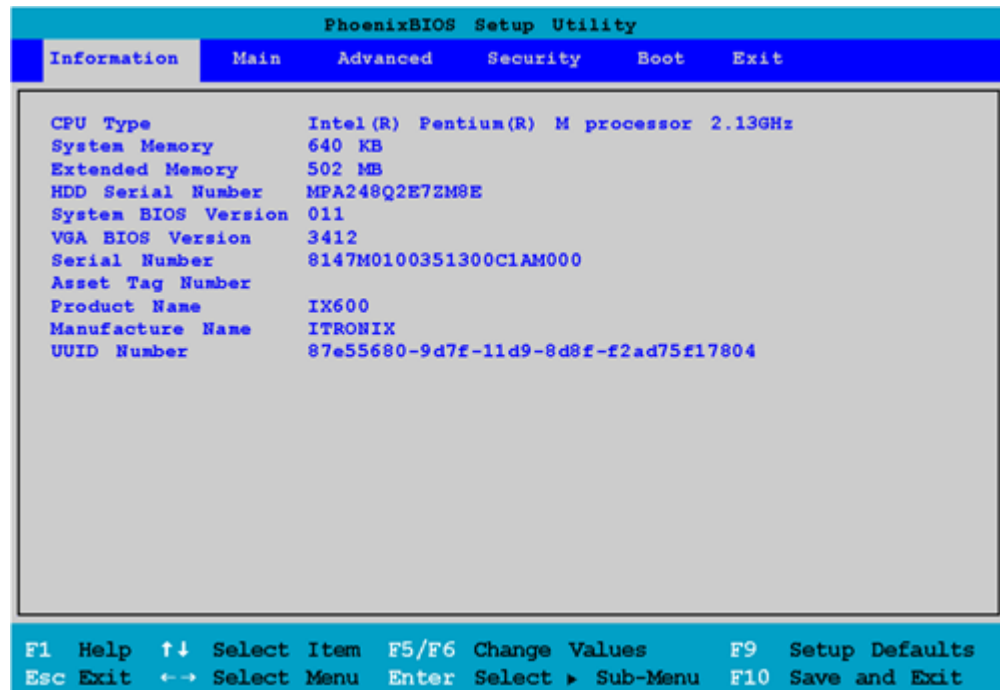

Field	Description
CPU Type	Displays the CPU information
System Memory	Displays the current system memory
Extended Memory	Displays the current extended memory
HDD Serial Number	Displays the primary master HDD serial number If there is no primary master HDD, it displays 'None'
System BIOS Version	Displays the current system BIOS version
VGA BIOS Version	Displays the current VGA BIOS version
Serial Number	Displays the System Serial Number (30 characters)
Asset Tag Number	Displays the Asset Tag Number (32 characters)

Product Name	Displays the Product Name (up to 15 characters). This is "IX625"
Manufacturer Name	Displays the Manufacturer Name (up to 15 characters). This is Itronix
UUID	Display the UUID (16 Byte Hex-Digital)

72_0128_001

16 May 2005

© 2005 Itronix Corporation. All rights reserved.

ITRONIX[®]GoBook[®] PRO II Help

The Security Menu

The

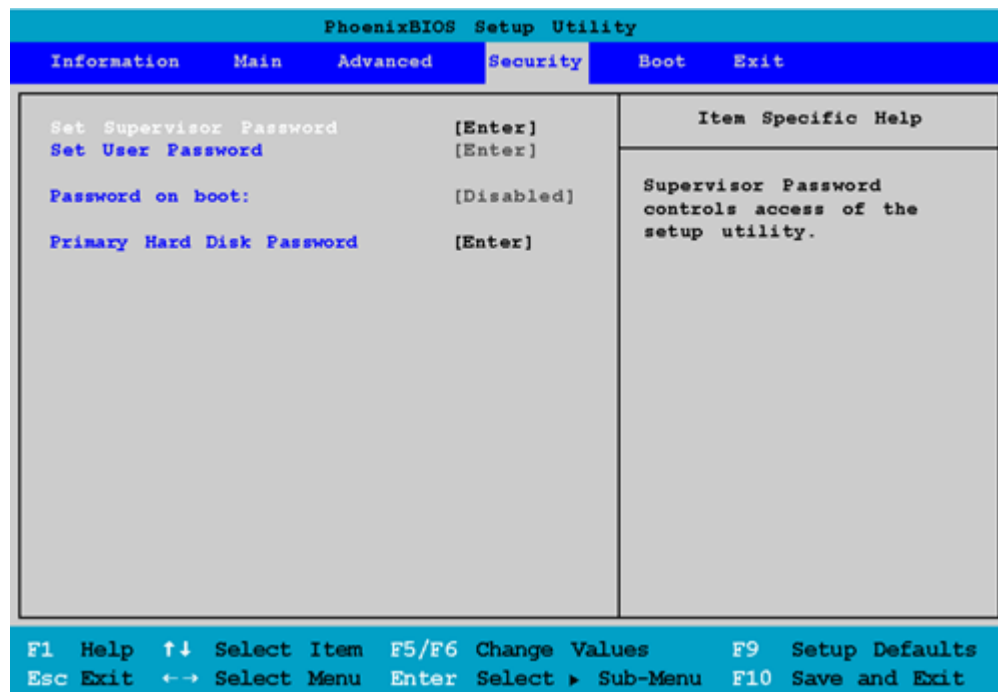

Field	Setting	Function
Set Supervisor Password		Supervisor Password controls access to the Setup Utility.
Set User Password		User Password controls access to the system

Password on boot	Enables password entry on boot.
Primary Hard Disk Password	Use the hard disk drive password to prevent unauthorized access to the hard disk.

72_0128_001

16 May 2005

© 2005 Itronix Corporation. All rights reserved.

Optional Equipment and Accessories

Your computer offers excellent expansion capabilities with its built-in ports, connectors and bays. This chapter describes how to connect peripherals and hardware options that help you use your computer with ease. When connecting peripherals, read the manual included with the peripheral for operating instructions. You can purchase most of these and other options directly from authorized dealers.

This chapter also includes information on upgrading key components to keep your computer in step with the latest technology.

The GoBook PRO II computer has several equipment and accessory options to further enhance your mobile computing experience. Go to the [accessory section](#) of the Itronix website for a list of available accessories.

CAUTION When purchasing any additional accessories, purchase only those accessories that are approved for use with your computer. Some accessories are proprietary items and can be obtained through your system vendor. If you use items that are not approved for use with this computer, you may cause your computer to malfunction, or to emit or receive electromagnetic radiation in excess of local regulations. For non-proprietary accessories such as PC Cards or printers, ensure that the accessory functions properly with your computer before making the purchase. Your system vendor may be able to recommend reliable brands and models.

ITRONIX[®]GoBook[®] PRO II Help

External monitor

You can connect an external monitor to the external monitor port on the rear panel. Read the monitor manual for additional instructions.

NOTE If an external monitor is not connected, closing the display cover puts the computer into Standby mode.

Using simultaneous display

Your computer takes advantage of Windows multi-display capability, allowing you to use your computer for presentation purposes. So whatever is displayed in your computer will likewise be

displayed on the other external display.

To use simultaneous display, connect an external display device to the external monitor port or S-video output jack. You can then toggle the display output location by pressing Fn-F3 to make the image appear on both the computer LCD and external display device.

Connecting to an External Monitor

The notebook has a VGA monitor port to connect your computer to an external monitor.

Using the VGA monitor port.

1. Locate the 15-pin VGA monitor port on the left side of your notebook and connect the video signal cable from the external monitor (or the VGA adapter) to the monitor port.
2. Connect the power cable from the external monitor to a power outlet and turn on the monitor.
3. On your notebook, click the right touchpad button on the Windows desktop to open the desktop menu. Click Properties to open the Display Properties window.
4. In the Display Properties window, click Advanced in the Settings tab. Click the Display Modes tab.
5. Under Driver mode, you can select the appropriate options to change the display to an external monitor or FN+F2.

Adjustments to screen resolution and color depth can also be made in this dialog box.

Dual Displays

With a Windows system, you may use an external monitor simultaneously with your notebook's LCD. You may also use the external monitor only and disable the LCD or only use the LCD. To do this you may first need to enable the multiple display settings in Windows.

1. Open the Control Panel and double-click Display. The Display Properties window will open
2. Click the Settings tab, then click the Advanced button
3. Select the S3 Display tab.

There are two display mode options: Single and Mirror.

Single: In Display Combination, there are two options available: VGA1 or LCD2. You can choose which device to apply as the Primary display. VGA1 is the default value for Primary if an external CRT is available. If an external CRT is not connected to the notebook, only LCD2 is available. In Single mode, the video display hot key combination is available-you can cycle the video output by pressing the FN + F2 keys.

Mirror: In Display Combination, there is no Primary display option available. Only LCD2 is available as Secondary display even when an external CRT is connected. In Mirror mode, the video display hot

key combination is available-you can cycle the video output by pressing the FN + F2 keys. If the external CRT is connected, the display on the LCD and the CRT is the same.

TIP To ensure trouble-free video output, the first time you use an external monitor, change the output in the Display Properties dialog box. After successfully switching modes, you may use the video function keys.

NOTE Light or dark dots may appear on the LCD due to technical limitations of LCD manufacturing. This will not effect normal operation of the LCD.

72_0128_001

16 May 2005

© 2005 Itronix Corporation. All rights reserved.

S-video

The S-video port allows you to output to a television or display devices that support S-video input. This is useful if you want to do some presentations or watch movies on a bigger screen.

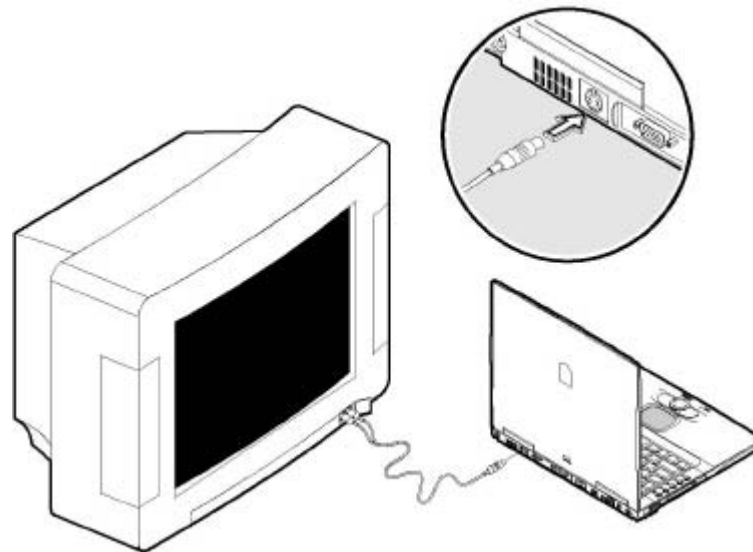

Printer

You can connect a printer to your computer's parallel port. You can also connect a USB printer to an available USB port. See your printer manual for operating instructions.

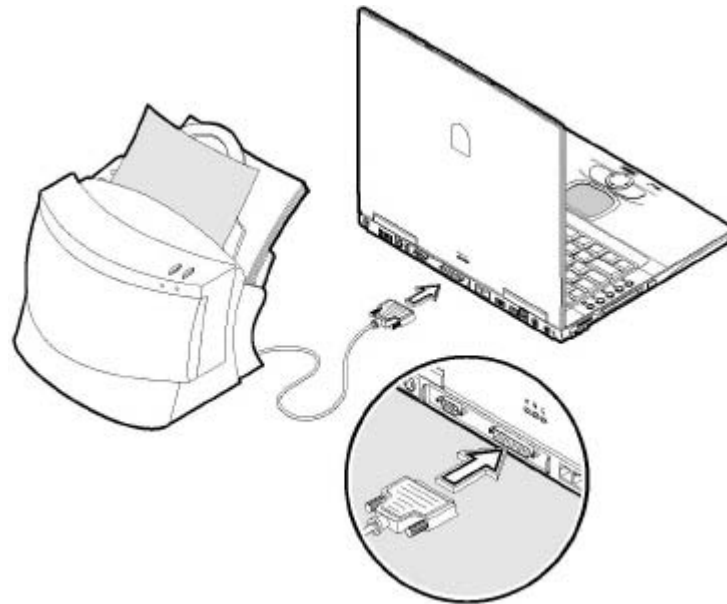
**ITRONIX®**GoBook® PRO II Help

Audio devices

Audio devices are easy to connect with the audio ports accessible from the rear of the computer. You can plug an external microphone (or an audio line-in device) into the line-in jack. Amplified speakers or headphones connect to the line-out jack. The line-out jack also supports digital audio output (S/PDIF).

72_0128_001

16 May 2005

[© 2005 Itronix Corporation. All rights reserved.](#)**ITRONIX®**GoBook® PRO II Help

USB devices

The computer has three USB (Universal Serial Bus) 2.0 ports on the rear of the computer, that allow you to connect peripherals without occupying too many resources. USB 2.0 is the second generation USB standard that allows faster transfer rates and is also backward-compatible with USB 1.1 devices. Common USB devices include a mouse, keyboard, and digital camera.

Before disconnecting a USB device from your computer, click on the Safely Remove Hardware icon on the taskbar and click on the device. When the device can be safely removed, disconnect the device from the computer. See your peripheral's documentation for details.

72_0128_001

16 May 2005

© 2005 Itronix Corporation. All rights reserved.

ITRONIX

GoBook® PRO II Help

IEEE 1394 devices

The computer's fast IEEE 1394 ports allow you to connect IEEE 1394 supported devices like a digital video camera or external storage devices.

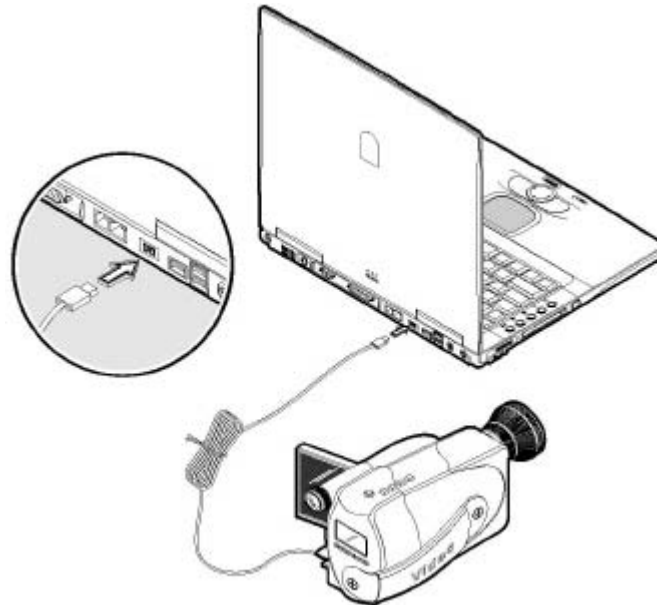

Before disconnecting an IEEE 1394 device from your computer, click on the Safely Remove Hardware icon on the taskbar and click on the device. When the device can be safely removed, disconnect the device from the computer. See your peripheral's documentation for details.

72_0128_001

16 May 2005

© 2005 Itronix Corporation. All rights reserved.

ITRONIX

GoBook® PRO II Help

Miscellaneous options

Additional power packs

You can order an AC adapter and spare batteries.

Battery pack

It is a good practice to have a spare battery around, especially when you travel. The Li-ion battery,

coupled with the power management features of your computer, supplies you with more power on-the-go.

AC adapter

The compact AC adapter charges your battery pack and supplies power to your computer. You can order a spare AC adapter so you do not need to carry it from the office to your home or destination.

72_0128_001

16 May 2005

[© 2005 Itronix Corporation. All rights reserved.](#)

ITRONIX[®]

GoBook[®] PRO II Help

Surge Protection

A large number of computer and high technology equipment damage is directly related to AC power and telephone line problems. These problems can include surges, spikes, noise, interference, and weather-related problems, which in turn can cause glitches, hang-ups, crashes, performance slow downs, and down time with computer equipment. The market is flooded with hundreds of AC power line surge suppressors advertising high performance surge protection; only a few of them actually provide adequate protection.

This section provides guidelines for selecting a quality surge suppressor to be used with your GoBook PRO II, and it helps identify a few sources for products with acceptable performance.

Selecting the Right Surge Protection

Consider the level of quality you need when selecting a surge suppressor. This depends on factors such as surge environment, the type of equipment to be protected, and the quality of the electrical wiring and service.

Surge Environment

Surge environment refers to the damage potential from electrical surges in a particular geographical area. A high quality suppressor should be used if there is frequent lightning activity in the area and the location service is fed by overhead utility poles.

Type of Equipment to be Protected

If the computer is equipped with a modem, the modem should also be surge protected. Protecting the power line without protecting the modem line provides only partial protection.

Quality of Electrical Wiring and Service

Wiring should be up to current NEC standards and have verified good AC grounds. It is important that your computer system be plugged into a grounded AC outlet when charging and that all peripherals

connected to your system reference the same AC ground.

Selecting the Right Equipment

There are a number of companies that sell quality surge suppressors. When looking for a surge suppressor, consider these things.

- Expect to pay more for a good quality surge suppressor
- The surge suppressor should be a UL 1449, 497, and 1283 listed for surge suppression, modem surge protection, and RFI/EMI noise filtering respectively
- The surge suppressor should have diagnostic LEDs that verify good AC ground, proper wiring, and proper surge operation. On/off switches that light are not recommended since they can produce electrical noise
- The Joule ratings should be a minimum of 480 Joules for the AC surge circuit
- The Joule ratings should be a minimum of 240 Joules for the modem
- The modem surge circuit should present low capacitance to the modem line or it will slow the transmission rate. Capacitance should be specified at less than 50 picofarads
- Quality surge suppressor manufacturers generally offer a lifetime warranty
- Consider obtaining a protected equipment coverage policy which insures the equipment in the event of surge damage
- The devices that will be attached to the computer also need to be surge protected

72_0128_001

16 May 2005

[© 2005 Itronix Corporation. All rights reserved.](#)

ITRONIX[®]

GoBook[®] PRO II Help

Key component upgrades

Your computer delivers superior power and performance. However, some users and the applications they use may demand more. This computer allows you to upgrade key components when you need increased performance.

NOTE Contact your authorized dealer if you decide to perform a key component upgrade.

Memory upgrade

This notebook computer comes with two PC2100/PC2700 (266MHz/333MHz DDR) soDIMM (Small

Outline Dual Inline Memory Module) sockets that accept 128/256/512 MB modules. Please consult your dealer if you need to add more memory.

To install memory, do the following:

1. Shutdown the computer, disconnect the AC adapter from the computer, and remove the battery pack.
2. Remove the two screws that secure the memory door and remove the memory door.
3. Insert a memory module at an angle firmly into a memory socket (1); then gently press down until the memory module locks and clicks into place (2).

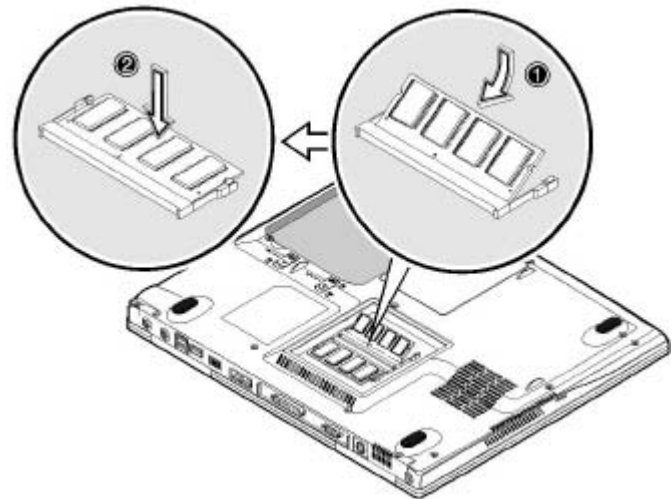
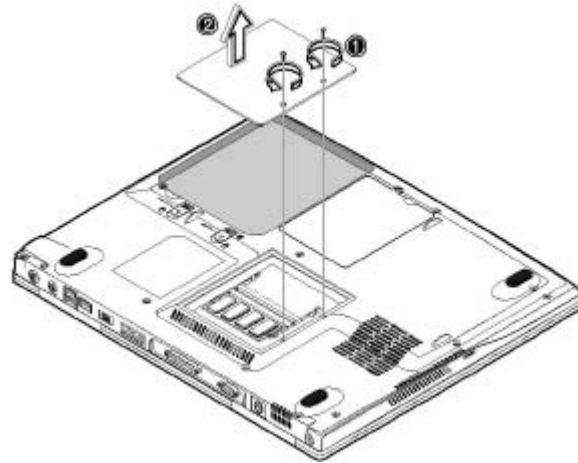

Hard disk upgrade

It is possible to upgrade your hard disk with a higher capacity drive when you need more storage space. The computer uses a 9.5mm 2.5-inch Enhanced-IDE hard disk. Please consult your dealer if you need to upgrade your hard disk.

72_0128_001

16 May 2005

[© 2005 Itronix Corporation. All rights reserved.](#)

Moving with your computer

This chapter gives you tips and hints on things to consider when moving around or traveling with your computer.

Disconnecting from the desktop

Follow these steps to disconnect your computer from external accessories:

1. Save your work in progress.
2. Shut down the operating system.
3. Turn off the computer.
4. Disconnect the cord from the AC adapter.
5. Disconnect the keyboard, pointing device, printer, external monitor, and other external devices.
6. Disconnect the Kensington lock if you are using one to secure the computer.

Moving around

When you are just moving within short distances, for example, from your office desk to a meeting room

Preparing the computer

Before moving the computer, close and latch the display cover to place it in Standby mode. You can now safely take the computer anywhere you go within the building.

To bring the computer out of Standby mode, open the display and press the power button.

What to bring to short meetings

A fully charged battery runs the computer for 4 hours under most circumstances. If your meeting is shorter than that, you probably do not need to bring anything with you other than the computer.

What to bring to long meetings

If your meeting will last longer than 4 hours or if your battery is not fully charged, you may want to bring the AC adapter with you to plug in your computer in the meeting room.

If the meeting room does not have an electrical outlet, reduce the drain on the battery by putting the computer in sleep mode. Press Fn-F2 or close the display cover whenever you are not actively using the computer. Then press the power button to resume (open the display if necessary).

Taking the computer home

When you are moving from your office to your home or vice versa

Preparing the computer

After disconnecting the computer from your desktop, follow these steps to prepare the computer for the trip home:

1. Remove all media from the drives. Failure to remove the media can damage the drive head.
2. Pack the computer in a protective case that can prevent the computer from sliding around and cushion it if it should fall.

CAUTION Avoid packing items next to the top cover of the computer. Pressure against the top cover could damage the screen.

What to bring with you

Unless you already have some items at home, bring the following items with you:

- AC adapter and power cord
- The printed user's manual

Special considerations

Follow these guidelines to protect your computer while traveling to and from work:

- Minimize the effect of temperature changes by keeping the computer with you.
- If you need to stop for an extended period of time and cannot bring the computer with you, leave the computer in the trunk of the car to avoid exposing the computer to excessive heat.
- Changes in temperature and humidity can cause condensation. Allow the computer to return to room temperature, and inspect the screen for condensation before turning on the computer. If the temperature change is greater than 18°F (10°C), allow the computer to come to room temperature slowly. If possible, leave the computer for 30 minutes in an environment with a temperature between outside and room temperature.

Setting up a home office

If you frequently work on your computer at home, it may be worthwhile to purchase a second AC adapter for use at home. With a second AC adapter, you can avoid transporting the extra weight to and from home.

If you use your computer at home for significant periods of time, you might also want to add an external keyboard, monitor, or mouse.

Traveling with the computer

When you are moving within a larger distance, for instance, from your office building to a client's office building or traveling locally

Preparing the computer

Prepare the computer as if you were taking it home. Be sure the battery in the computer is charged. Airport security may require you to turn on your computer when bringing it into the gate area.

What to bring with you

Bring the following items with you:

- AC adapter
- Spare, fully charged battery packs
- Additional printer driver files if you plan to use another printer

Special considerations

In addition to the guidelines for taking the computer home, follow these guidelines to protect your computer while traveling:

- Always take the computer as carry-on luggage.
- If possible, have the computer inspected by hand. The computer can safely pass through security X-ray machines, but never expose the computer to a metal detector.
- Avoid exposing floppy disks to hand-held metal detectors.

Traveling internationally with the computer

When you are moving from country to country

Preparing the computer

Prepare the computer as you would normally prepare it for traveling.

What to bring with you

Bring the following items with you.

- AC adapter
- Power cords that are appropriate to the country to which you are traveling
- Spare, fully charged battery packs
- Additional printer driver files if you plan to use another printer

Special considerations

Follow the same special considerations as when traveling with the computer. In addition, these tips are useful when traveling internationally.

- When traveling in another country, check that the local AC voltage and the AC adapter power cord specifications are compatible. If not, purchase a power cord that is compatible with the local AC voltage (e.g., power rating). Do not use converter kits sold for appliances to power the computer.
- If you are using the modem, check if the modem and connector is compatible with the telecommunication system of the country you are traveling in.

Error Messages

The following are possible error and warning messages you may encounter while operating the GoBook PRO II computer. The messages described in this section are listed below.

Error and warning messages are generated by several different sources including:

- Power On Self Test (POST)
- Windows
- Applications

POST Messages

When the GoBook PRO II computer restarts, it tests its [hardware](#) components. This test is called the [Power On Self Test \(POST\)](#) . If the system finds an error during this test, it displays an error message.

Some POST errors can occur before anything can be displayed on the screen. In this case, the computer issues a series of beeps, then stops working. This type of error indicates a serious hardware problem, and you should contact your supervisor or your organization's help desk.

The most common POST error messages are listed next. Select the error message to view solutions you can try.

[Failure Fixed Disk](#)

[Stuck key](#)

[Keyboard error](#)

[Keyboard Controller Failed](#)

[Monitor type does not match CMOS - Run SETUP](#)

[Shadow Ram Failed at offset: nnnn](#)

[System RAM Failed at offset: nnnn](#)

Extended RAM Failed at offset: nnnn

System battery is dead - Replace and run SETUP

System CMOS checksum bad - Default configuration used

System timer error

Real time clock error

Check date and time settings

Previous boot incomplete - Default configuration used

Memory Size found by POST differed from CMOS

Diskette drive A error

Diskette drive B error

Incorrect Drive A type - run SETUP

Incorrect Drive B type - run SETUP

System cache error - Cache disabled

CPU ID:

EISA CMOS not writeable

DMA Test Failed

Software NMI Failed

Fail-Safe Timer NMI Failed

device Address Conflict

Allocation Error for: device

CD ROM Drive

Entering SETUP ...

Failing Bits: nnnn

Fixed Disk n

Invalid System Configuration Data

[I/O device IRQ conflict](#)

[PS/2 Mouse Boot Summary Screen:](#)

[nnnn kB Extended RAM Passed](#)

[nnnn Cache SRAM Passed](#)

[nnnn kB Shadow RAM Passed](#)

[nnnn kB System RAM Passed](#)

[One or more I2O Block Storage Devices were excluded from the Setup Boot Menu](#)

[Operating system not found](#)

[PS/2 Mouse:](#)

[Run the I2O Configuration Utility](#)

[System BIOS shadowed](#)

[UMB upper limit segment address: nnnn](#)

[Video BIOS shadowed](#)

Windows Messages

Windows messages are typically self-explanatory. (See [Troubleshooting](#), for more information).

Application Messages

Windows applications may display messages if a warning or error condition occurs. Refer to the [Online Help](#) or other documentation for the [application](#) that generated the message.

Troubleshooting

This section is designed to help you determine and fix problems you might encounter while operating the GoBook PRO II computer. Try the following things in order:

- First look through the categories in this section for a solution.
- If you don't find a solution for your situation here, try one of the resources listed below.
- If you are having a problem with a computer [application](#) , use the [online Help](#) that comes with the application to find a solution.

- If you still cannot resolve your problem, contact the help desk at your organization.

WARNING Do not attempt to open and service the computer by yourself. Contact your dealer or an authorized service center for assistance.

Applications

My application locks up, acts strangely, or produces a General Protection Fault (GPF) error

- If you've tried to resolve the problem and your application still doesn't respond, you may need to restart your computer as described below.

To reboot your computer, select Start, Shut Down, Restart. If that does not work, try pressing ctrl+alt+del twice.

If the computer does not restart, the [keyboard](#) may be locked up. Hold the Power Button or use the reset on the bottom of the unit.

NOTE This will result in a loss of all unsaved data.

- The data on the [hard disk](#) could be corrupted. Run SCANDISK.
- Windows is out of memory/resources. Exit Windows and restart Windows.

Communications programs such as HyperTerminal, or Procomm Plus don't seem to work or they lock Windows

- When you first try to use HyperTerminal or similar application, the system responds with a message asking if you want to install the modem. Answer "Yes" to this question and follow the instructions on the screen to install it.
- Verify with your company that your computer has an internal modem installed.

Batteries

The battery does not charge

- To prevent possible damage to the battery, the system will not allow a charge if the battery temperature is extremely hot or cold (such as in a closed, unattended vehicle). If possible, charge the battery in a location with a moderate temperature of around 20°C (68°F).
- If possible, turn off the computer while the battery is charging.
- If the battery is new or has been stored for a week or more, follow this procedure:
 1. Make sure the computer is turned off.
 2. Remove the battery.

3. Connect the [AC adapter](#) to the computer and an AC wall outlet, and then turn on the computer by pressing the **Power Button**.
4. Reinstall the battery.
5. Allow the system to remain idle for one hour with the AC adapter connected to the computer.

The Battery Power Indicator  is solid orange while the battery charges.

6. If the battery still fails to charge after an hour, remove the battery, wait several seconds, and then install it again.

If the battery does not begin charging within several minutes, return the unit for service.

The batteries take much longer than seven hours to charge

- Under moderate temperatures, about 21°C (70°F), the computer's battery takes approximately 2 to 3 hours to completely charge if the unit is off and 6 to 13 hours if it is running. Under extremely cold or hot temperatures, however, the battery can take up to 16 hours to fully charge.

The batteries don't last very long

- As your battery ages, the maximum capacity that it can hold naturally decreases, and even the best maintained batteries eventually need to be retired. Consider replacing the battery if you are not getting the usage you need from it.

The gas gauge isn't full after charging the battery

- This may indicate that the charging process terminated prematurely.

The gas gauge reads "full," but the indicator light is still blinking

- If you charge your battery daily, rely on the gas gauge reading to determine battery capacity. The charging process may continue even if the gas gauge reads full. External power can be removed because the battery is virtually full.

My battery seems to have less and less capacity

- As your battery ages, the maximum capacity that it can hold naturally decreases, and even the best maintained batteries eventually need to be retired. Consider replacing the battery if you are not getting the usage you need from it.

Display

[The display performance is slow](#)

[I can't read the display](#)

The underlined, inverse, and hypertext characters are difficult to read on the screen

The display appears to have random pixels darkened after scrolling

I changed my display resolution, but I see no difference on the screen

Frequently Asked Questions

This is a list of possible situations that may arise during the use of your computer, and it gives easy answers and solutions to these questions.

1. My screen seems to time out too quickly. I have to constantly hit a key or move the mouse in order to bring it back. How can I adjust the screen time-out?
2. I've heard that cleaning up and rearranging files on the hard drive will improve the startup speed of my programs. How do I do this?
3. The internal fax/modem dial tone sound is too low. How can I increase the volume?
4. What kind of external microphone can I use with my notebook computer?
5. There is feedback noise coming from my speakers. What can I do?
6. Because of a software problem, I was unable to shut down power normally. I pressed the power button to force a power off, but it didn't work. How can I force a power off?
7. Why can't I charge the battery of my portable computer after it was out of use for some time?
8. My computer alerts "CMOS Battery Low", what can I do?
9. I press the power switch, but the computer does not start or boot-up.
10. Nothing appears on the screen.
11. Image is not full-screen.
12. No audio from the computer.
13. The keyboard does not respond.
14. The printer does not work.
15. I want to set up my location to use the internal modem.
16. Why can't I charge my battery to 100% charged when it is 99-95% charged?

Hard Disk

The hard disk will not spin up so the computer can't boot up

- This occurs if the unit is exposed to extreme low temperatures. This is not a hardware failure associated with the hard disk . Allow the computer to warm to room temperature.

I can't save files because the disk is full

- Report this situation to your supervisor or your organization's help desk.

Keyboard

Something unexpected happens when I press a key

- You may have pressed a key combination that performs a Windows function. Make sure you are pressing the correct keys for the [application](#) you are running.

Incorrect characters appear on the screen when I press certain keys

- You may be in NUM LOCK mode. Press FN+NUM LOCK to toggle NUM LOCK mode off.

Landline Modems

The modem doesn't work

- When you first try to use HyperTerminal or similar application , the system responds with a message asking if you want to install the modem. Answer "Yes" to this question and follow the instructions on the screen to install it.
- Make sure the communication settings are correct in your application. Refer to the [online Help](#) for your application.

The modem doesn't dial a number

Check these things:

- If you are using an external modem, make sure the cables are attached correctly.
- Make sure your communications parameters are correct in your application. Refer to the online Help for your application.

The modem dials and receives an answer but does not establish a connection

- You may have incorrect parameters selected for your application to talk with the remote modem. Refer to the online Help for your application.
- You may need to adjust your modem's baud rate or protocol selection.

Communications programs such as HyperTerminal or Procomm Plus don't seem to work or they lock Windows

- If you are using the internal modem, be sure to specify the proper communications [port](#) .
- When you first try to use HyperTerminal or similar application, the system responds with a message asking if you want to install the modem. Answer "Yes" to this question and follow the

instructions on the screen to install it.

Miscellaneous

The computer shuts off unexpectedly

- The computer has entered [suspend mode](#) . Press any key to resume from the standby state. Press the Power Button to resume from the hibernate state.
- The battery capacity may be low. Connect [external power](#) to charge the battery, or replace the battery with a fully charged one.

The [speaker](#) volume is too high or too low

- Increase the volume by using the volume control knob on the front of the unit.

The computer won't turn on

- The battery may not be installed properly, or it may not be fully charged. Make sure a fully charged battery is properly installed.
- Connect external power to charge the battery if it is not charged.
- If you are using the [AC adapter](#) , check the electrical outlet you are using to make sure it is working properly.
- If the GoBook PRO II computer does not turn on, restart the computer by holding down the Power Button for at least 4 seconds and then release it.

The computer won't turn off

- Press and release the Power Button.

The computer enters suspend mode too quickly

- When there is no activity for a period of time, the computer turns off or enters suspend mode. To extend this time, use the Power Management program (Start, Settings, Control Panel, Power Management) and increase the non-activity time to enter suspend.

The computer doesn't automatically suspend

- Check to make sure the COM ports are off. For example, exit any [application](#) that uses COM ports.
- Make sure external power is not connected. Depending on power settings, some systems will not suspend automatically when they are connected to external power.

The system date and time are incorrect

- Reset the correct date and time by choosing the Date/Time icon from Control Panel and making the appropriate changes.

I receive an “out of memory” error message

- Too many applications may be running at the same time. Close applications you don’t need.
- If you’re using [desktop](#) wallpaper, set wallpaper to None. To do this, choose Display from Control Panel and make the appropriate change.
- Make sure you have enough space on your [hard disk](#) . Contact your supervisor or your organization’s help desk for assistance.
- Set up a permanent swap file. Contact your supervisor or your organization’s help desk for assistance.

Mouse

I have difficulty double-clicking the mouse fast enough

- From the Start Menu, select Settings, Control Panel, and then choose Mouse. The Response tab contains the setting for the double-click speed.

PC Cards

I can’t remove the [PC card](#)

- Press the ejector button located inside the PC card door on the side of the computer. The button will pop out. Press the ejector button again to eject the PC card. Slide the card out.
- If the ejector button malfunctions when you press it, release the button and then press it again.

Diskette Read Error

- Any card in the PC Card socket except for a properly formatted memory card will cause this error since it is trying to read the PC Card.

The system does not recognize the PC Card CD-ROM when it is inserted into the PC Card socket

- There is a delay of 10 to 15 seconds before the CD-ROM drive is recognized.
- Drivers may not be installed. Contact your organization’s help desk for assistance.

The computer locks up when I remove the PC card

- Before you remove the card, select the PC card icon in the system “tray” area of the screen (near the clock in the lower right corner), and choose “Stop [card name] card.”

Care and Maintenance

You can use your computer under a wide range of environmental conditions. However, to ensure long use and continued high performance, consider the following factors when setting up your computer:

Taking Care of Your Computer

- Follow all warnings and instructions noted in this documentation and in the Windows Help program.
- The first time you use your computer, we recommend that you carefully read the [Making Connections](#) section and initialize the battery to ensure optimum battery performance.
- Unplug the computer from the power outlet before cleaning. Use a damp cloth for cleaning. Do not use aerosols, solvents, or strong detergents.
- Slots and openings in the system cabinet are for ventilation purposes. Do not block or cover these openings or the system could overheat. Do not use or store the computer near a source of heat or dust.
- On the base or rear panel of this notebook, there is a label with information on the power requirements of this system. These requirements must be followed. If you are unsure of your local power supply, consult your dealer or local Power Company.
- If you use the computer with an extension cord, ensure that the total ampere ratings of all the devices sharing the extension do not exceed the rating of the extension cord or the rating of the wall outlet.
- Never push foreign objects into the computer through any of the slots or openings. Dangerous voltages are present, which could cause electric shock or fire, or damage sensitive components.
- For best results, use a power strip with a built-in [surge protector](#). Do not use inferior extension cords as this may result in damage to your computer.
- Set the computer on a flat, stable surface. To prevent damage to the computer's hard disk drive, avoid using the computer where it will be exposed to strong vibration.
- Do not expose the computer to direct sunlight. Do not place it near sources of heat, such as a radiator.
- Do not expose the computer to temperatures below 0°C (32°F) or above 50°C (122°F).
- Do not subject the computer to magnetic fields.
- Do not expose the computer to rain or moisture.

- Do not spill water or any liquid on the computer.
- Do not subject the computer to heavy shock and vibration.
- Do not expose the computer to dust and dirt.
- Do not place objects on top of the computer.
- Do not place the computer on uneven surfaces.

Taking care of your AC adapter

- Do not connect the adapter to any other device.
- Do not step on the power cord or place anything on top of it. Carefully route the power cord and any cables away from all potential traffic.
- When unplugging the power cord, do not pull on the cord itself but pull on the plug.
- The total ampere ratings of the equipment plugged in should not exceed the ampere rating of the cord if you are using an extension cord. Also, the total current rating of all equipment plugged into a single wall outlet should not exceed the fuse rating.

Taking care of your battery pack

- Use only batteries of the same kind as replacements. Turn the power off before removing or replacing batteries.
- Do not tamper with batteries. Keep them away from children.
- Dispose of used batteries according to local regulations. Recycle if at all possible.

Cleaning

To clean the computer:

1. Power off the computer and remove the battery pack.
2. Disconnect the AC adapter.
3. Use a soft cloth moistened with water. Do not use liquid or aerosol cleaners.

Servicing

Contact your dealer or see your service technician if any of the following occurs:

- The computer has been dropped or the body has been damaged.
- Liquid has been spilled into the product.

- The computer does not operate normally.
-

72_0128_001

16 May 2005

© 2005 Itronix Corporation. All rights reserved.

Service and Support

Our commitment at Itronix is to provide you, our client, with both the products and support services necessary for success in your enterprise.

[Client Care Center](#)

The Itronix Client Care Center strives to consistently provide world-class service and continually make improvements thanks to valuable input and ideas from our customer base.

[Product Support - Downloads](#)

Get the software updates you need to keep your configuration current.

ITRONIX®

GoBook® PRO II Help

Client Care Center (CCC)

**THE ITRONIX “ONE CALL” CLIENT CARE CENTER
1-800-638-9270**

The convenient "One Call" Client Care Center number, **800-638-9270**, allows a single entry point of access to meet all your needs (or our web portal at www.itronix.com/CCC), including:

- Troubleshooting and/or RMA Origination
- Trial/Demo/Pilot Unit Orders and Status Updates
- Placing and Checking Status on Unit and/or Parts Orders
- RMA Status check on Service Unit and Warranty/Service Parts Orders
- New Accessory, Peripheral and Service Parts Orders
- Proof of Delivery Status Updates for Service and New Unit Orders
- International New Unit & Accessory, Peripheral and Service Parts Orders
- Centralized access for all Invoicing and Finance related issues

The Itronix "One Call" Client Care Center access number in the America's is **800-638-9270**. Please listen to the recording closely and choose from the following options:

- | | |
|---|---|
| 1 | New to Itronix and would like to purchase products for the first time or interested in becoming an Itronix Business Partner |
|---|---|
- 2 Technical Assistance Center for Troubleshooting, Unit Exchange Information, Warranty Unit and Service Parts Orders
 - 3 Speak with your assigned point of contact
 - 4 New Orders for Accessories, Peripherals and Service Parts Ordering (such as batteries or chargers)
 - 5 Finance, Invoicing or Credit Related Issues and Proof of Delivery
 - 8 Non-urgent message with reply within 48 hours

You can also e-mail us at ccc@itronix.com

NOTE For support and queries in Europe, Middle East and Africa, please [Click Here](#) or call +44 (0)24 7671 4800

Services Expertise: Itronix provides in-field support provided by a network of Field Service Managers whose expertise focuses on specific vertical applications and industries. Strategically located to provide nationwide support, they can provide both first level and escalated customer support. In addition, the Field Managers perform regular site visits to receive feedback on customer satisfaction, training or individualized support needs, product performance and future value-add post-installation support needed for anticipated changes in the customer environment and user community or profile, as well as to garner input on future product designs. For more information on our comprehensive services offering, please [Click Here](#).

72_0128_001
16 May 2005

[© 2005 Itronix Corporation. All rights reserved.](#)

ITRONIX®

GoBook® PRO II Help

Product Support - Downloads

Itronix Corporation makes it easy to get the software updates you need to keep your configuration current and get the most from your Itronix product. Simply go to the Notebooks section of the [Product Support downloads page](#) on the Itronix website. Downloads are listed by model (GoBook PRO II) and product number (IX600).

72_0128_001
16 May 2005

[© 2005 Itronix Corporation. All rights reserved.](#)

ITRONIX®

GoBook® PRO II Help

Identification

GoBook PRO II (IX600) Help
May 2005 · Revision 001

Copyright Notice

© Copyright 2005 Itronix Corporation. All rights reserved. No part of this document may be reproduced, transmitted, transcribed, stored in a retrieval system, or translated into any other language or computer language in whole or in part, in any form or by any means, whether it be electronic, mechanical, magnetic, optical, manual, or otherwise, without the prior written consent of Itronix Corporation, South 801 Stevens Street, Spokane, Washington 99204.

Disclaimer

This document is printed in the U.S.A. Itronix Corporation reserves the right to revise the manual and make periodic changes to the content without a direct or inferred obligation to Itronix to notify any person of such revision or changes. Itronix Corporation does not assume responsibility for the use of this help manual, nor for any patent infringements or other rights or third parties who may use the manual.

This document contains valuable trade secrets and proprietary information of Itronix Corporation.

This product is available for purchase under the terms of the Itronix Hardware Purchase and [Software](#) License Agreement. Itronix hardware products may be reconditioned, or be manufactured from parts and components that may be new, used, rebuilt, or recycled and in some cases, the hardware product may not be new and may have been previously installed. In any event, Itronix warranty terms apply.

Trademark and Patent Notice

Itronix is a registered trademark of Itronix Corporation.
GoBook PRO II is a registered trademark of Itronix Corporation
Microsoft, MS, Windows, and MS-DOS are registered trademarks of Microsoft Corporation.
IBM is a trademark of International Business Machines Corporation.

The following United States Patent Numbers apply to any unit which incorporates a DVD drive - 5,434,678; 5,589,945; 5,913,013; 6,151,444; and 6,208,805.

Compliance Statements

Federal Communication Commission Interference Statement

This equipment has been tested and found to comply with the limits for a Class B digital device, pursuant to Part 15 of the FCC Rules. These limits are designed to provide reasonable protection against harmful interference in a residential installation. This equipment generates, uses and can radiate radio frequency energy and, if not installed and used in accordance with the instructions, may cause harmful interference to radio communications. However, there is no guarantee that interference will not occur in a particular installation. If this equipment does cause harmful interference to radio or television reception, which can be determined by turning the equipment off and on, the user is encouraged to try to correct the interference by one of the following measures:

- Reorient or relocate the receiving antenna.
- Increase the separation between the equipment and receiver.

- Connect the equipment into an outlet on a circuit different from that to which the receiver is connected.
- Consult the dealer or an experienced radio/TV technician for help.

FCC CAUTION

To assure continued compliance, (example - use only shielded interface cables when connecting to computer or peripheral devices) any changes or modifications not expressly approved by the party responsible for compliance could void the user's authority to operate this equipment.

This device complies with Part 15 of the FCC Rules. Operation is subject to the following two conditions:

- (1) This device may not cause harmful interference, and
- (2) This device must accept any interference received, including interference that may cause undesired operation.

IMPORTANT NOTE

FCC Radiation Exposure Statement

This equipment complies with FCC radiation exposure limits set forth for an uncontrolled environment. This equipment should be installed and operated with minimum distance 20cm between the radiator and your body.

This transmitter must not be co-located or operating in conjunction with any other antenna or transmitter.

REN

The GoBook PRO II (IX600) computer complies with Part 68 of the FCC Rules. On the bottom of this equipment is a label that contains, among other information, the FCC registration number and ringer equivalence number (REN) for this equipment. If requested, this information must be provided to the telephone company.

The REN is used to determine the quantity of devices which may be connected to the telephone line. Excessive RENs on the telephone line may result in the devices not ringing in response to an incoming call. In most, but not all areas, the sum of the RENs should not exceed five (5.0). To be certain of the number of devices that may be connected to the line, as determined by the total RENs, contact the telephone company to determine the maximum REN for the calling area.

The GoBook PRO II (IX600) computer may be connected to the telephone network using the RJ-11 jack provided.

If this equipment causes harm to the telephone network, the telephone company will notify you in advance that temporary discontinuance of service may be required. If advance notice isn't practical, the telephone company will notify the customer as soon as possible. Also, you will be advised of your right to file a complaint with the FCC if you believe it is necessary.

The telephone company may make changes in its facilities, equipment, operations, or procedures that could affect the operation of the equipment. If this happens, the telephone company will provide advance notice in order for you to make the

necessary modifications in order to maintain uninterrupted service.

If trouble is experienced with this equipment, please contact the equipment manufacturer for repair and/or warranty information. Do not attempt repairs of this equipment yourself without obtaining manufacturer authorized parts and documentation. If the trouble is causing harm to the telephone network, the telephone company may request you remove the equipment from the network until the problem is resolved.

Compliance Statement for Canada

NOTICE The Industry Canada label identifies certified equipment. This certification means that the equipment meets certain telecommunications network protective, operational and safety requirements as prescribed in the appropriate Terminal Equipment Technical Requirements document(s). The Department does not guarantee the equipment will operate to the user's satisfaction.

Before installing this equipment, users should ensure that it is permissible to be connected to the facilities of the local telecommunications company. The equipment must also be installed using an acceptable method of connection. The customer should be aware that compliance with the above conditions may not prevent degradation of service in some situations.

Repairs to certified equipment should be made by a representative designated by the supplier. Any repairs or alterations made by the user to this equipment, or equipment malfunctions, may give the telecommunications company cause to request the user to disconnect the equipment.

Users should ensure for their own protection that the electrical ground connections of the power utility, telephone lines, and internal metallic water pipe system, if present, are connected together. This precaution may be particularly important in rural areas.

CAUTION! Users should not attempt to make such connections themselves, but should contact the appropriate electric inspection authority, or electrician, as appropriate.

The Ringer Equivalence Numbers (REN) are:

GoBook PRO II (IX600) non-radio: 0.5B

GoBook PRO II (IX600) Motient: 0.5B

GoBook PRO II (IX600) Cingular: 0.5B

NOTICE The Ringer Equivalence Number (REN) assigned to each terminal device provides an indication of the maximum number of terminals allowed to be connected to a telephone interface. The termination on an interface may consist of any combination of devices subject only to the requirement that the sum of the Ringer Equivalence Numbers of all the devices does not exceed 5.

The GoBook PRO II (IX600) computer may be connected to the telephone network using the RJ-11 jack provided.

Fax Branding

The Telephone Consumer Protection Act of 1991 makes it unlawful for any person to use a computer or other electronic device to send any message via a telephone fax machine unless such message clearly contains in a margin at the top or bottom of each transmitted page or on the first page of the transmission, the date and time it is sent and an identification of the business or other entity, or other individual sending the message and the telephone number of the sending machine or such business, other entity, or individual.

In order to program this information into your fax machine, you should complete the following:

This information is entered through the FAX application software you have installed. Consult your FAX software documentation for instructions about entering this information.

Warnings and Cautions

WARNING It is important that only authorized Itronix personnel attempt repairs on Itronix equipment as this might void any maintenance contract with your company. Unauthorized service personnel might be subject to shock hazard on some Itronix equipment if removal of protective covers is attempted.

The product you have purchased is powered by a rechargeable battery. The battery is recyclable and, under various state and local laws, it may be illegal to dispose of this battery into the municipal waste stream. Do not crush the battery or place it in a fire. Check with your local solid-waste officials for details on recycling options or proper disposal.

CAUTION Internal components of the GoBook PRO II (IX600) computer will be damaged if exposed to contaminants. When dust covers, the PC card door, or the bottom access panel are open on the computer, shield the unit from all contaminants such as liquids, rain, snow, and dust.

Internal radio(s) may display an individual FCC Identifier which are not applicable to this configuration. Only the FCC ID(s) shown on the label located on the bottom of the IX600 Laptop PC is/are applicable. The IX600 Laptop PC Radio(s) must not be co-located or operating in conjunction with any other antenna or transmitter than specified within the FCC ID certification.

This device may contain a WWAN radio transmitter, and/or WLAN radio transmitter and/or a PAN radio transmitter. To comply with FCC/IC RF exposure requirements when using the WWAN radio transmitter, a minimum separation distance of 20 cm must be maintained between the back of the display screen and all users/bystanders. When using the WLAN transmitter, a minimum separation distance of 20 cm must be maintained between the back of the display screen and all users/bystanders. The WWAN and WLAN radio transmitters should be turned off before carrying the Laptop PC in order to comply with FCC/IC RF exposure requirements.

"The equipment has been approved to [Commission Decision "CTR21"] for pan-European single terminal connection to the Public Switched Telephone Network (PSTN). However, due to differences between individual PSTNs provided in different countries the approval does not, of itself, give an unconditional assurance of successful operation on every PSTN network termination point.

In the event of problems, you should contact your equipment supplier in the first instance.

This product is intended to be supplied by a Listed Power Unit and output rated 20 V dc, 3.25 A.

CAUTION Always disconnect all telephone lines from the wall outlet before servicing or disassembling this equipment.

CAUTION To reduce the risk of fire use only a No. 26 AWG or larger telecommunication line cord.

Safety Information

Enclosed with each IX600 Laptop PC is the radio specific safety information. Do not proceed without reviewing the information provided in that document.

Do not proceed beyond a **WARNING** or **CAUTION** until the indicated conditions are fully understood and met.