

Exhibit 7 – Instruction Manual

Motorola Customer Premise Equipment (CPE)

FCC ID: MIJTELCPE-USB-01

Telaxis Model No. XCV-31-UB1H-R2

7.0 Instruction Manual

Installing the CPE Transceiver

1 Inspection & Unpacking

Inspect the shipment packaging and contents on receipt for any obvious damage due to shipment. If any damage has occurred, immediately file a claim with the transporter.

Tools Required:

- Wrenches:**
- Open Ratchet Box Wrench 17mm (11/16") and
 - Hollow Shaft Nut Driver 17mm (11/16") or
 - Combination Wrench 17mm (11/16")

- Voltmeter:** Required for alignment
Binoculars: May be required for visual alignment

Note: All hardware is metric size M10



Mast Mounting Bracket

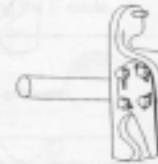

Radio Mounting Bracket, Pivot Rod
Bolts and Washers



U-bolts, Washers and Nuts

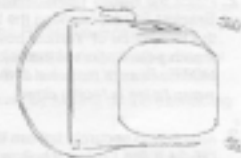

Radio Transceiver (back view),
Washers and Nuts

2 Attach Mast Mounting Bracket to Mast

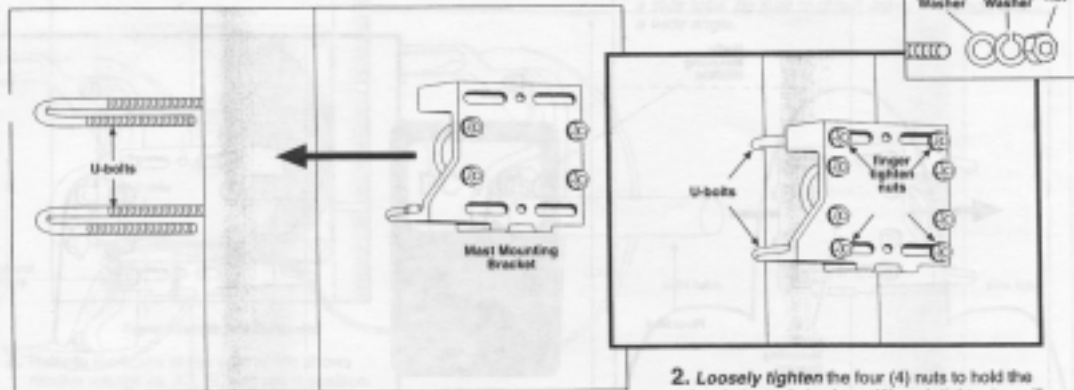

1. Fasten Mast Mounting Bracket in place with two (2) U-bolts.

2. Loosely tighten the four (4) nuts to hold the bracket snugly in place. Wrench tightening will be done after the final alignment.

3 Mount Radio Transceiver on Radio Mounting Bracket

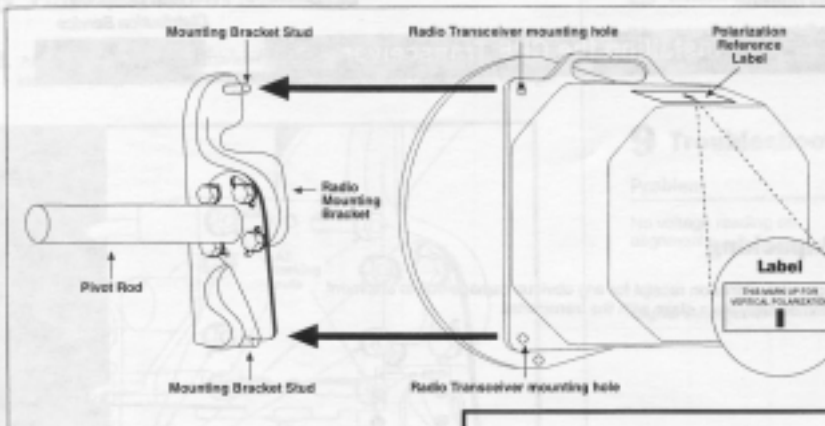

Important!

To proceed with installation, you must determine if the transceiver should be mounted in the horizontal or vertical position. See step 3-1.

The polarization of the Radio Transceiver, vertical (V) or horizontal (H), must match the polarization of the hub at the head end.

1. Locate the Polarization Reference Label on the radio transceiver.
2. Place the Radio Transceiver on the Mounting Bracket Studs, orienting the transceiver in either the Horizontal or Vertical position required to match polarization of the hub equipment.
NOTE: Ensure that one of the two (2) antenna sweep holes is facing down.
3. Attach and securely tighten the two (2) nuts (16-24 ft./lbs.) using a hollow shaft nut driver.
4. Securely tighten the four (4) bolts attaching the Pivot Rod to the Radio Mounting Bracket.

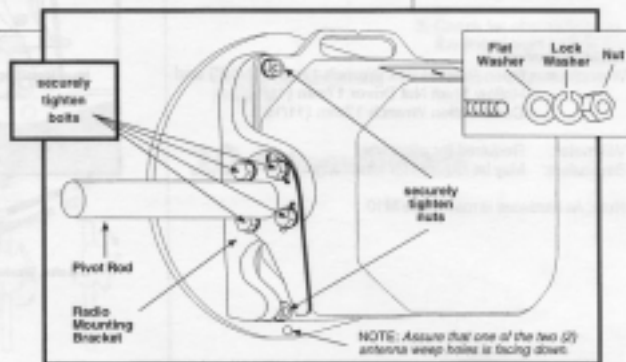

4 Attach Radio Mounting Bracket to Mast Mounting Bracket

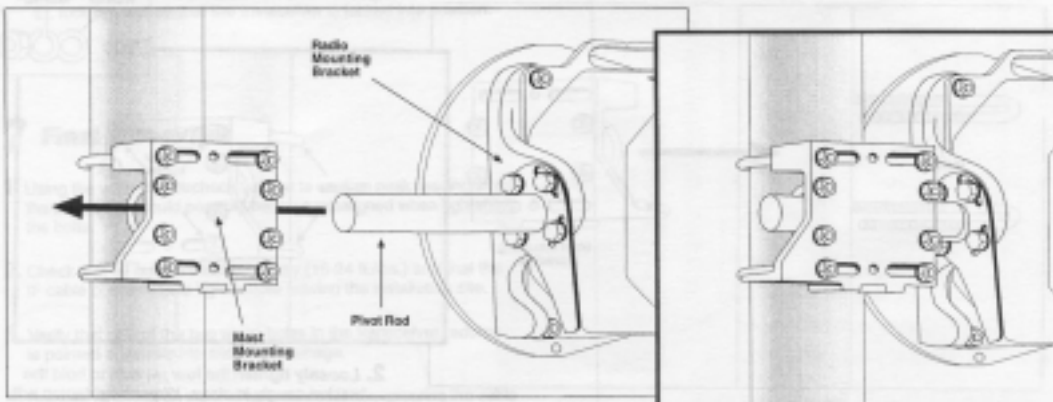

1. Insert Pivot Rod into small U-bolts between the Mast Mounting Bracket and Mast.
2. Loosely tighten the four (4) nuts on the two (2) small U-bolts to snugly hold the pivot rod in place. Do not wrench tighten until after Final Alignment (See STEP 5).

5 Alignment and Operation

The purpose of the alignment procedure is to position the transceiver so that the radio signals between the hub and transceiver are optimized.

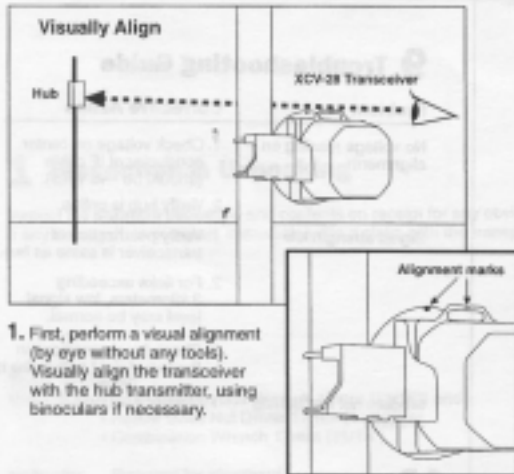

1. First, perform a visual alignment (by eye without any tools). Visually align the transceiver with the hub transmitter, using binoculars if necessary.

NOTE: Alignment marks are provided on the transceiver handle and antenna to help bore-sight the unit to the hub.

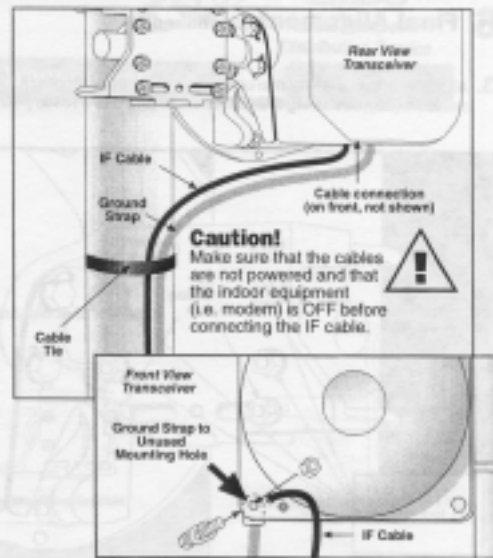

2. Connect the IF Cable to the Radio Transceiver.
3. Connect the ground strap (customer supplied) to one of the two unused mounting bolt holes on the transceiver.
4. Apply power to the transceiver by turning on the interfacing indoor unit.

6 Final Alignment

1. Connect a voltmeter to the Signal Strength Test Connector. A BNC to test lead adapter is required.

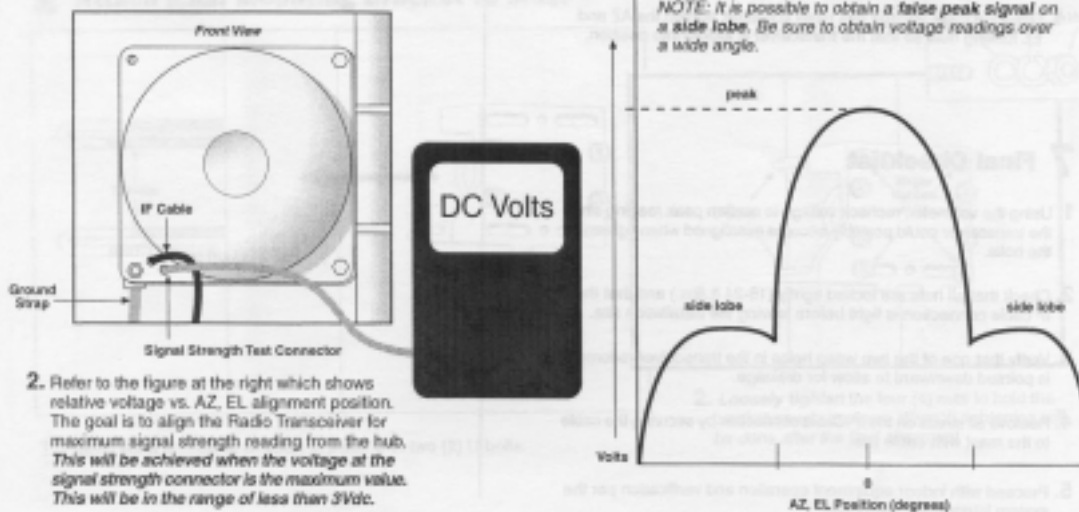

2. Refer to the figure at the right which shows relative voltage vs. AZ, EL alignment position. The goal is to align the Radio Transceiver for maximum signal strength reading from the hub. This will be achieved when the voltage at the signal strength connector is the maximum value. This will be in the range of less than 3Vdc.

6 Final Alignment (continued)

3. Align the transceiver by manually positioning the azimuth (AZ) and elevation (EL), observing the voltmeter reading until it reads peak voltage.

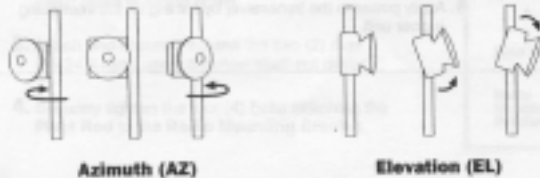
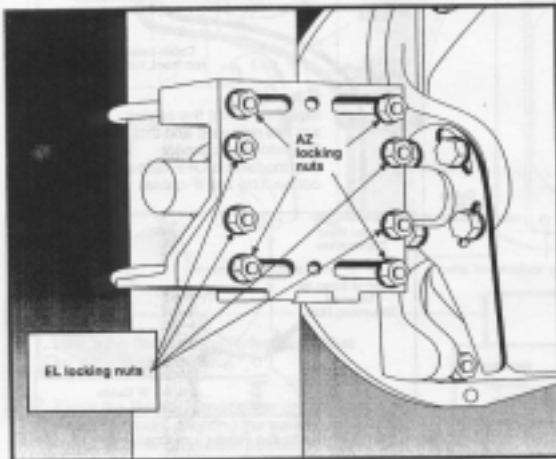

4. Once the peak voltage has been achieved, tighten the AZ and EL locking nuts so that the transceiver is locked into position.

7 Final Checklist

1. Using the voltmeter, recheck voltage to confirm peak reading since the transceiver could possibly become misaligned when tightening the bolts.
2. Check that all nuts are locked tightly (16-24 ft.lbs.) and that the IF cable connection is tight before leaving the installation site.
3. Verify that one of the two weep holes in the transceiver radome is pointed downward to allow for drainage.
4. Remove all stress on the IF Cable connection by securing the cable to the mast with cable ties.
5. Proceed with indoor equipment operation and verification per the system integrator's instruction.

8 Maintenance and Inspection

It is recommended that the radio transceiver installation be inspected by qualified personnel at least once a year to ensure safe installation and optimum performance.

9 Troubleshooting Guide

Problem	Corrective Action
No voltage reading on alignment	1. Check voltage on center conductor of IF cable (should be -48 volts). 2. Verify hub is online.
Signal strength low	1. Verify polarization of transceiver is same as hub. 2. For links exceeding 3 kilometers, low signal level may be normal. 3. Check for obstructions in the line of sight path to the hub.
Modem not functioning properly	1. Recheck alignment.

10 Returns/Repairs

Installing the CPE Power Supply & Bias-T

1 Inspection & Unpacking

Inspect the shipment packaging and contents on receipt for any obvious damage due to shipment. If any damage has occurred, immediately file a claim with the transporter.

Contents:

- Power Supply with attached DC Power Cord
- Bias-T Assembly
- AC Power Cord

2 Connect the ODU (Outdoor Unit) and Modem Cables to the Bias-T Assembly.

3 Plug DC Power Cord from Power Supply into the Bias-T Assembly.

4 Connect AC Power Cord to the Power Supply and apply power. LED Power "ON" indicator should be illuminated.

