

**GENIE**<sup>®</sup>  
*CHAIN GLIDE*<sup>®</sup>

# *Garage Door Opener*

*Series GCG, PCG, H*

*Includes INTELICODE<sup>®</sup> Remote Control  
and SERIES II Electronics*

Included Wall Control **MUST** be installed prior to operation of this Garage Door Operator

Safe-T-Beam<sup>®</sup> Safety Reverse System Must be installed to close door

**NOTE:** Your Residential Operator comes with a Rail Assembly which is standard for up to a 7 foot 6 inch high door. An extension kit for an 8 foot high door is available.

**For Answers and Assistance:**

**1.800.354.3643**

or visit [www.geniecompany.com](http://www.geniecompany.com)

*SAVE THIS MANUAL FOR FUTURE REFERENCE*

## Things to consider if you are planning to “do-it-yourself.”

In many cases you will be replacing an existing door operator with a new one, however, if this will be the first operator installed there are some pre-installation issues which need to be addressed. They are as follows:

2

The Genie Company recommends that you read and fully understand all information and instructions contained herein before choosing a “Do-it-yourself” installation. Any questions should be directed to the Genie Company or an authorized Genie Dealer.

(The issue numbers below refer to the circled numbers in the illustrations on page 3.)

- 1** Check your ceiling where the power head of your new unit will be mounted. Plan how you will be mounting the power head. It is possible that ceiling joists may not be in the position needed with respect to the garage door operator. It may be necessary to add an additional bracket and fasteners (not included with your new door operator kit).
- 2** Check the wall directly above the garage door. The door operator’s header bracket must be securely fastened to this wall. Insure that the structure will provide a strong mounting location.
- 3** Check to see if the mounting location for the Safe-T-Beam® System “STB” is clear from obstruction and has a wood surface available for attaching the “STB” brackets. The brackets may be attached to concrete if necessary but extra tools and special fasteners (not supplied) will be required.
- 4** Is your garage door made of light-weight steel, aluminum, fiberglass or glass panels? Additional support bracing must be added to these type doors. If this is the case, please contact the door distributor or manufacturer so that they can furnish you with a “bracing kit.”
- 5** You need a 110-120 Volt power supply available. The outlet should be no more than 3 feet from the power head once it is mounted. (The cord is 4 ft. in length.) SEE WARNING BELOW.
- 6** To avoid damage to your door and/or operator, make sure you disable any door locks prior to installing your operator.
- 7** Insure that your door is properly balanced and moving freely. SEE WARNING BELOW.
- 8** (NOT SHOWN) If your garage does not have a separate entry door, you should consider an emergency release kit (GER-2) for installation on your garage door. See page B at the center of this manual.

*NOTE: 1-1/2" “STB” bracket adapters are available through your local Genie Dealer.*

### **⚠ WARNING**

**DO NOT USE AN EXTENSION CORD!**  
Extension cords can cause dangerous overheating conditions.  
**DO NOT USE A PORTABLE GENERATOR!**  
This product is designed to operate on standard house current. Do not use alternate power supplies.

### **⚠ WARNING**

If your door sticks, binds, or is out of balance, have it adjusted by a professional. Door springs, cables, pulleys, brackets and associated hardware are under extreme tension and can cause serious injury or death.

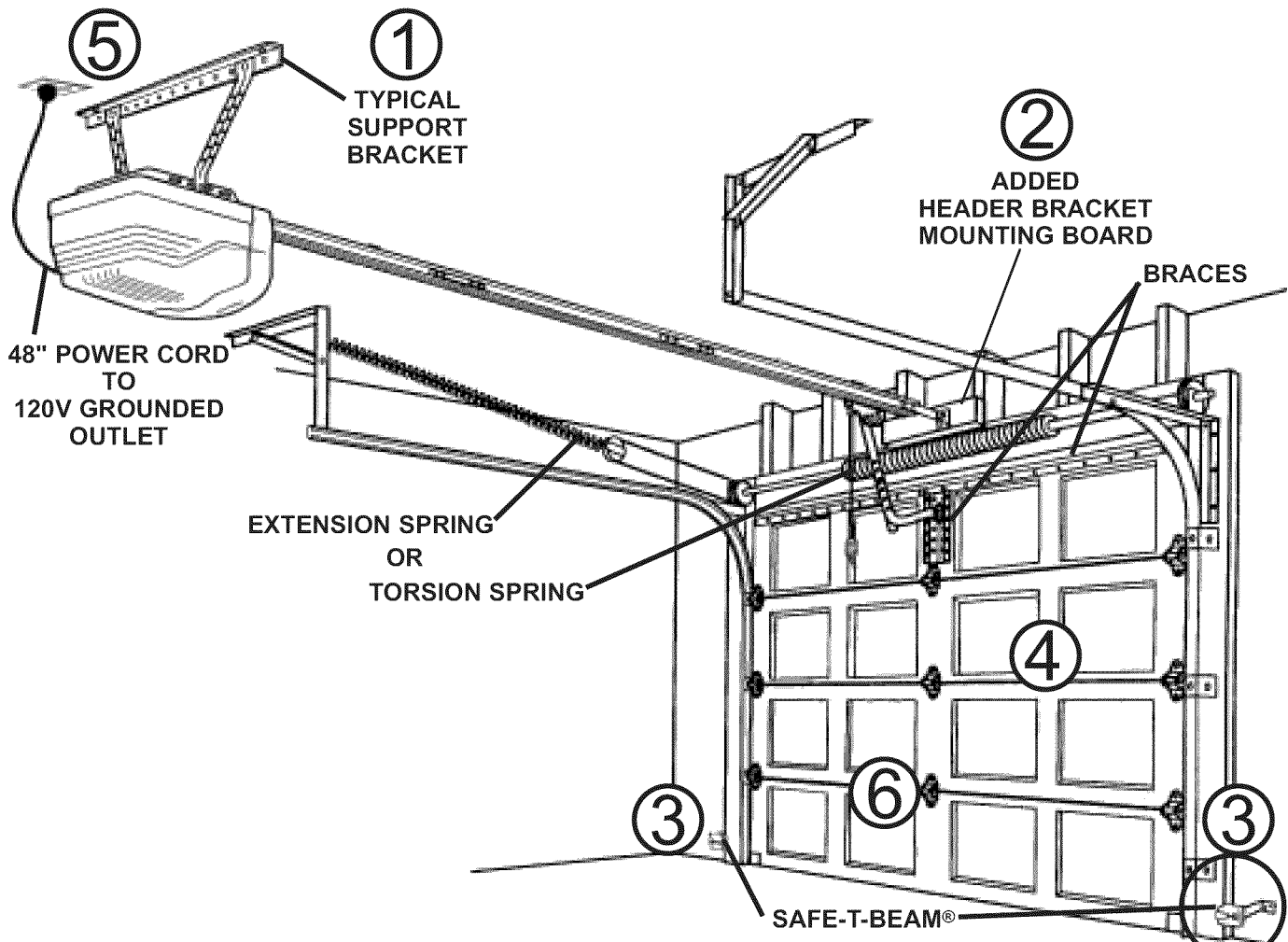

TYPICAL 1-PIECE DOOR INSTALLATION

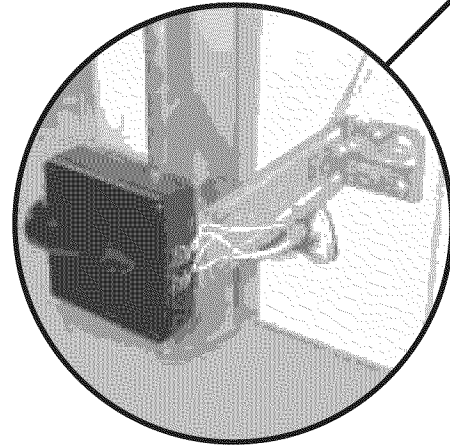
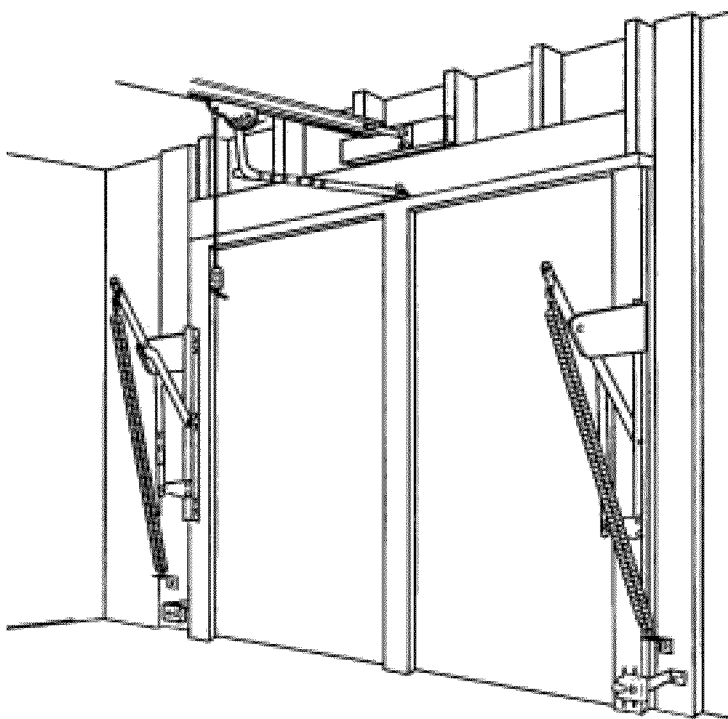

⑦

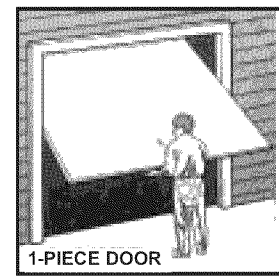
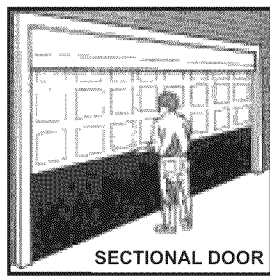

**TABLE OF CONTENTS**

SECTION .....	PAGE
PRE-INSTALLATION CHECKS .....	2-3
OPERATOR FEATURES.....	4
SAFETY FEATURES.....	4
TOOLS RECOMMENDED.....	5
PARTS IDENTIFICATION .....	5-7
SAFETY INFORMATION.....	7
OPERATOR .....	
1 ASSEMBLY.....	8-10
2 INSTALLATION.....	11-14
ELECTRICAL INSTALLATION.....	15-18
3 SAFE-T-BEAM® SYSTEM INSTALLATION .....	15-16
4 WALL CONTROL INSTALLATION.....	17
5 CONNECT OPERATOR TO POWER.....	18
ADJUSTMENTS.....	19-21
6 LIMIT SWITCHES & FORCE ADJUSTMENT.....	19.
CONTACT REVERSE.....	20
7 PROGRAMMING REMOTE CONTROLS .....	20-21
8 BATTERY/VISOR CLIP INSTALLATION.....	21
9 LIGHT BULB AND LENS INSTALLATION.....	21
SAFETY INSTRUCTIONS.....	22
MAINTENANCE & TROUBLESHOOTING .....	22-24
SAFE-T-BEAM® .....	22
OPERATOR/RADIO .....	23
WIRING DIAGRAM .....	24
ACCESSORIES.....	A-B
WARRANTY .....	C

**OPERATOR FEATURES**

**INTELLICODE® Rolling Code Security System.**

An electronic rolling code system that enhances the security of the door operator by continuously changing the access code each time the remote control is used. The door operator responds to each new code only once. An access code copied from a working system and tried again will not control the door operator.

**INTELLICODE® 1, 2 or 3-Button Remote Control (included with some models).**

Operates 1, 2 or 3 garage doors from car.

**Lighted Wall Button\*.**

Operates door operator from inside garage.

**Lighted Wall Console\* (included with some models).**

Security vacation lock switch disables all controls. LED Indicator shows whether system is locked or unlocked. Makes console easy to find in dark. Controls door operator from inside garage. Independent light control allows convenient manual control of the automatic lighting system.

**NOTE:** Your garage door operator may not come with all above items included as standard equipment.

**SAFETY FEATURES**

**Safe-T-Beam® (STB) Non-Contact Reversing System\*\*.**

Puts an invisible beam across the door opening. The door stops and reverses to the full open position if anything passes through the beam. Red and green LED indicators provide a self diagnostic code if an operational problem exists.

**Safe-T-Reverse® Contact Reversing System.**

Automatically stops and reverses a closing door within 2 seconds of contact with an object.

**Safe-T-Stop® Timed Reversed System.**

Automatically opens a closing door if it fails to close completely within 30 seconds.

**Force Guard® Control.**

Features adjustable open and close force settings. For maximum safety, these must be set to the minimum force required to fully open and close the door.

**Relay Monitoring System.**

Automatically stops and reverses a closing door if the closing relay malfunctions.

**Watch Dog® Monitoring System.**

Automatically stops and reverses a closing door if the Safe-T-Beam System\*\* has an operational problem.

**Automatic Lighting System.**

One bulb lighting supplies up to 100 Watts of light for safer evening exits and entries. Turns on when door is activated and automatically turns off 5 minutes later.

**Manual Emergency Release.**

Manually releases door from door operator. Use during a power failure or other emergency to allow manual opening and closing of door.

**\*Operator MUST be installed with the included Wall Control.**

**\*\*Safe-T-Beam® Safety Reverse System MUST Be Installed To Close door.**

**RECOMMENDED TOOLS**

FOR HELP-1.800.354.3643 OR GENIECOMPANY.COM

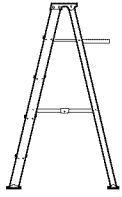

Step ladder



Drill

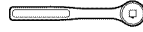

Ratchet



Pencil



Carpenter's level



Adjustable wrench



5/32" Drill Bit



7/16" and 9/16" Sockets



Tape measure



Phillips screwdriver



Wire strippers

**PARTS IDENTIFICATION - Not Shown Full Size**



[33]

#6 x 1-1/4" Pan Head Phillips Screw

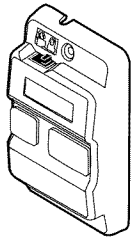

[32]

Wall console

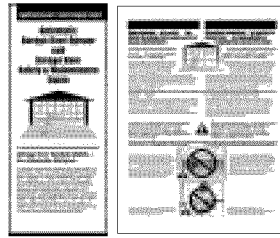

[40]

Safety Brochure

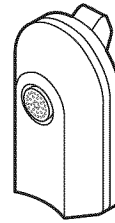

[38]

Single-button remote control

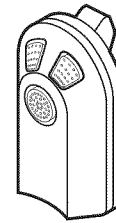

Multi-button remote control

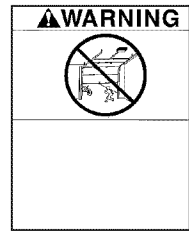

[34]

Entrapment Warning Label



[33]

#6 x 1-1/4" Pan Head Phillips Screw

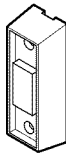

[31]

Wall button



[44]

#10-16 x 1-1/4" Machine Screw

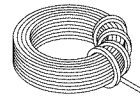

[29]

Wire

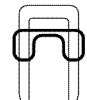

[30]

Insulated Staple

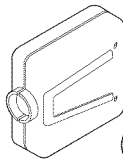

[36]

Source STB (Red LED)

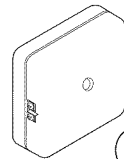

[35]

Sensor STB (Green LED)

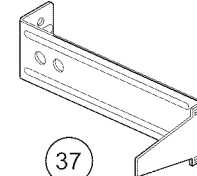

[37]

STB Bracket

**FASTENERS - Shown Full Size. See Parts List for description.**

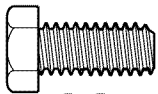

[9]

Bolt - 1/4"-20 x 5/8"

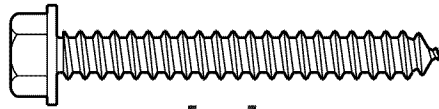

[22]

Lag screw - 1/4" x 2"

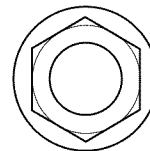

[28]

Nut - 3/8"-16

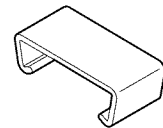

[41]

Wire clip

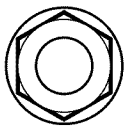

[10]

Nut - 1/4"-20



[25]

Cotter pin



[39]

Screw - #8-32 x 1"

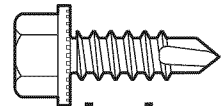

[42]

Self-drilling Screw  
1/4"-20 x 3/4"

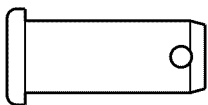

[24]

Clevis pin

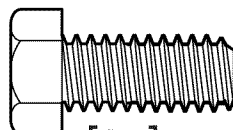

[27]

Bolt - 3/8"-16 x 7/8"

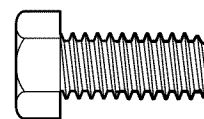

[46]

Bolt - 5/16"-18 x 3/4"

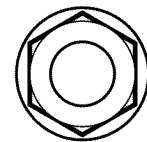

[47]

Nut - 5/16"-18

1-PIECE RAIL HARDWARE EXPLODED VIEW

FOR HELP-1.800.354.3643 OR GENIECOMPANY.COM

[2]

6

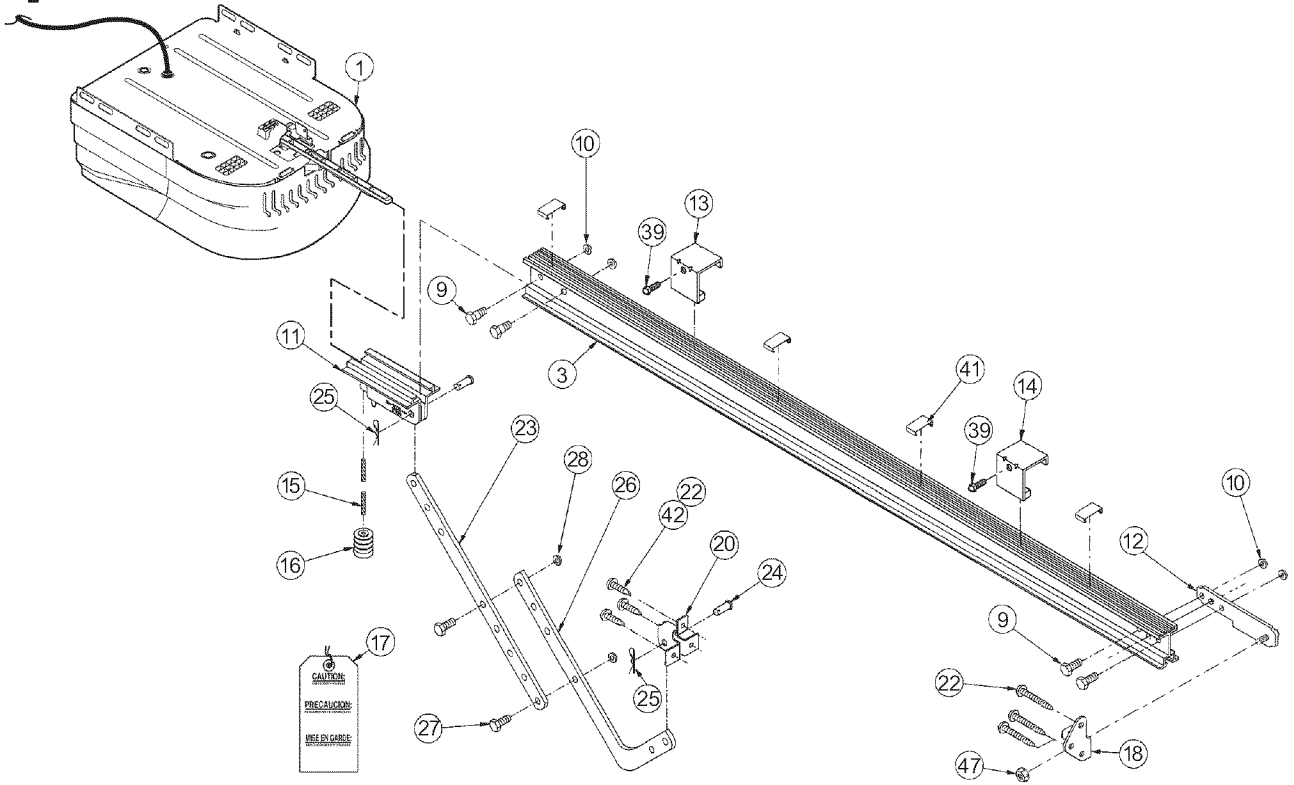

3-PIECE RAIL HARDWARE EXPLODED VIEW

[4]

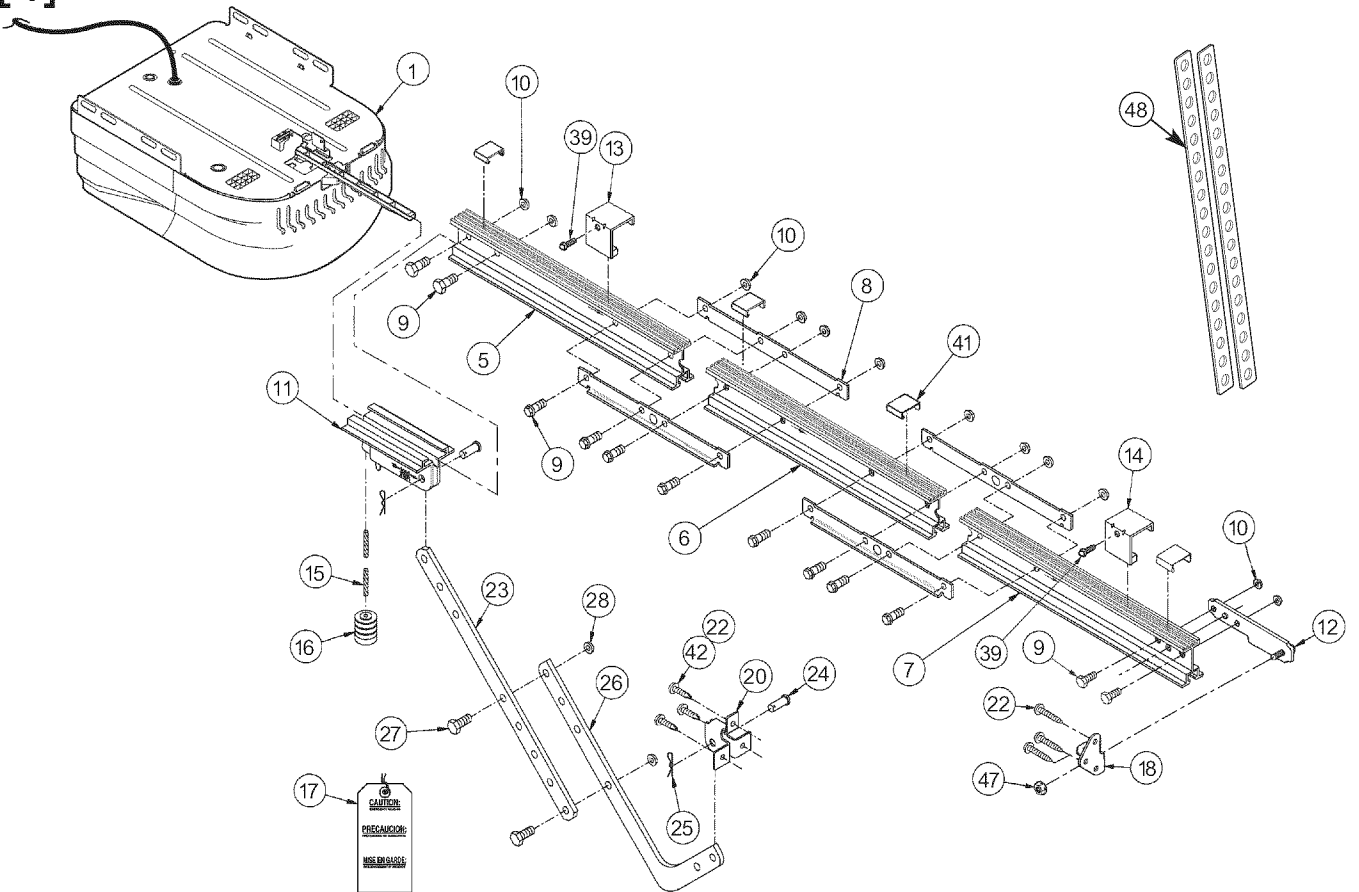

## PARTS LIST

Item	Part Name	Number Required	
		1 pc. rail	3 pc. rail
1	Power head assembly (box)	1	1
2	Rail assembly (1-piece)(box)	1	
3	Rail (1-piece)(box)	1	
4	Rail assembly (3-piece)(items 5, 6, 7)(box)		1
5	First rail section (box)		1
6	Middle rail section (box)		1
7	End rail section (box)		1
8	Rail clamp (blue bag)	4	4
9	1/4"-20 x 5/8" hex head bolt (blue bag)	4	12
10	1/4"-20 hex flange nut (blue bag)	4	12
11	Carriage assembly (box)	1	1
12	Rail strap (blue bag)	1	1
13	Limit switch OPEN (white wire)(green bag)	1	1
14	Limit switch CLOSE (brown wire)(green bag)	1	1
15	Release cord (green bag)	1	1
16	Release knob (green bag)	1	1
17	Emergency release tag (green bag)	1	1
18	Header bracket (orange bag)	1	1
20	Door bracket (orange bag)	1	1
22	1/4" x 2" lag screw (orange bag)	8	8
23	Straight door arm (box)	1	1
24	Clevis pin (yellow bag)	2	2
25	Cotter pin (yellow bag)	2	2
26	Curved door arm (box)	1	1
27	3/8"-16 x 7/8" hex head bolt (yellow bag)	2	2
28	3/8"-16 hex flange nut (yellow bag)	2	2
29	Wire (box)	1	1
30	Insulated staple (red bag)	varies/model	varies/model
31	Wall button (red bag)	varies/model	varies/model
32	Wall console (box)	varies/model	varies/model
33	No. 6 x 1-1/4" pan head phillips screw (red bag)	varies/model	varies/model
34	Entrapment WARNING label (manual)	1	1
35	Safe-T-Beam (STB) sensor (green LED)(box)	1	1
36	Safe-T-Beam (STB) source (red LED)(box)	1	1
37	Safe-T-Beam (STB) bracket (yellow bag)	2	2
38	Remote operator (box)	varies/model	varies/model
39	#8-32 x 1" machine screw (green bag)	2	2
40	Safety & maintenance guide (manual)	1	1
41	Wire clip (green bag)	varies/model	varies/model
42	1/4"-20 x 3/4" self-drilling screw (orange bag)	3	3
44	#10-16 x 1-1/4" phillips hex head screw (yellow bag)	4	4
46	5/16"-18 x 3/4" hex head bolt (orange bag)	3	3
47	5/16"-18 hex flange nut (orange bag)	4	4
48	Mounting Straps (box)		2

## POWER HEAD EXPLODED VIEW

[1] Power Head Assembly

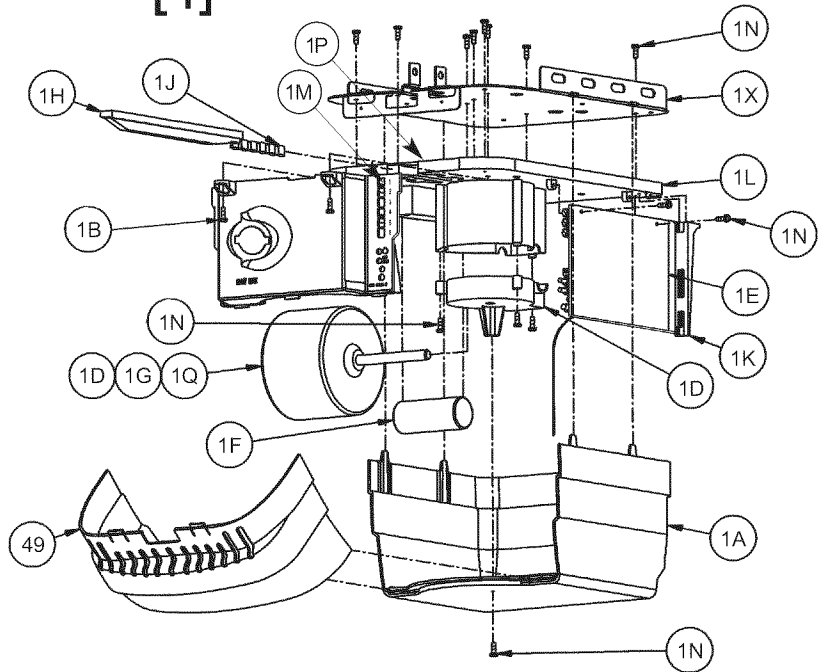

## POWER HEAD PARTS LIST (pre-assembled)

Item	Part Name	Item	Part Name
1	Power head assembly	1K	Circuit board bracket
1A	Cover (by series/model)	1L	Drive module
1B	Front panel assembly	1M	Terminal strip
1D	Motor parts	1N	No. 8 x 3/4" hex washer head screw
1E	Circuit board assembly	1P	Shock absorption stop (not shown)
1F	Capacitor (by series/model)	1Q	Motor mount bracket (not shown)
1G	Opto wheel (not shown)	1X	Chassis
1H	Carriage slide	49	Lens
1J	Chain		

## SAFETY INFORMATION

### OVERVIEW OF POTENTIAL HAZARDS

Garage doors are large, heavy objects that move with the help of springs under high tension and electric motors. Since moving objects, springs under tension, and electric motors can cause injuries, your safety and the safety of others depend on the owner or user of this system to read, understand and implement the information in this manual. If you have questions or do not understand the information presented, contact The Genie Company or an authorized Genie Dealer.

In this section and those that follow, the words **Danger**, **Warning**, and **Caution** are used to emphasize important safety information. The word:

- ⚠ DANGER** means that severe injury or death will result from failure to follow instructions.
- ⚠ WARNING** means that severe injury or death can result from failure to follow instructions.
- ⚠ CAUTION** means that property damage or injury can result from failure to follow instructions.

The word **NOTE** is used to indicate important steps to be followed or important considerations.

POTENTIAL HAZARD	EFFECT	PREVENTION
<p><b>MOVING DOOR</b></p>	<p><b>WARNING:</b> Can Cause Serious Injury or Death</p>	<p>Keep people clear of opening while door is moving.</p> <p><b>Do Not</b> allow children to play with the door operator.</p> <p><b>Do Not</b> operate a door that jams or one that has a broken spring.</p>
<p><b>ELECTRICAL SHOCK</b></p>	<p><b>WARNING:</b> Can Cause Serious Injury or Death</p>	<p>Turn off power before removing operator cover.</p> <p>When replacing cover, make sure wires are not pinched or near moving parts.</p> <p>Operator must be properly grounded.</p>
<p><b>HIGH SPRING TENSION</b></p>	<p><b>WARNING:</b> Can Cause Serious Injury or Death</p>	<p><b>Do Not</b> try to remove, repair or adjust springs or anything to which door spring parts are fastened, such as, wood blocks, steel brackets, cables or other like items.</p> <p>Repairs and adjustments must be made by a trained professional service technician using proper tools and instructions.</p>

**RAIL ASSEMBLY: Use a clean, flat surface.**

8

**⚠ CAUTION**

Drive chain can slide out of rails. **Do not run** until operator is fully assembled.

*NOTE: For 1-piece rail—skip to step 4.*

**1. Identify the rail sections (Fig. 1-1).**

- **First rail section** (attaches to power head).
  - 2 holes each end.
  - Half-circle notch 1 end.
  - Motor end has no notch.
- **Middle rail section.**
  - 2 holes & half-circle notch each end.
- **End rail section** (attaches to door).
  - Has 4 holes on door end.

*NOTE: Rail assemblies are for 7 foot 6 inch high door. An extension kit for an 8 foot high door is available.*

**2. Arrange arrows on rail sections.**

- Sections have arrows stamped into one side.
  - Aim all arrows toward door. (Fig. 1-2)

*NOTE: If installing a 3-piece rail assembly with an extension on an 8 foot high door, refer to the instruction sheet included with the optional rail extension at this point.*

**OPEN BLUE PARTS BAG**

**3. Attach rail clamps to rail (Fig. 1-3).**

- Use pair of clamps at both joints.
  - Fasten each pair with 4 bolts (9) and nuts (10).
  - Check rail sections aligned and level.
  - Securely tighten bolts and nuts.



**4. Attach rail strap (Fig. 1-4).**

- Place rail strap against rail so that projection on strap mates with second hole from end of rail.
  - Place 2 bolts (9) through rail strap and rail.
  - Ignore fourth hole. (See NOTE)
  - Securely tighten bolts and nuts (10).

*NOTE: Your rail has 4 holes in the rail strap end. The hole furthest away from the end is for an extension kit if needed.*

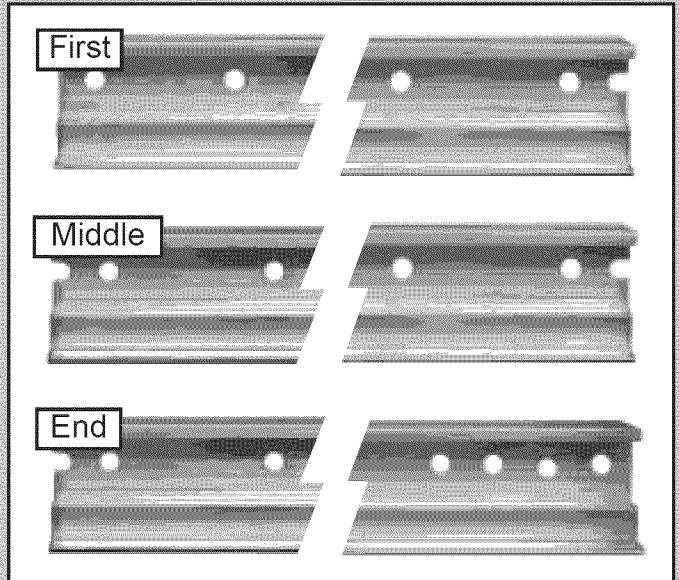

FIG. 1-1 Rail sections.

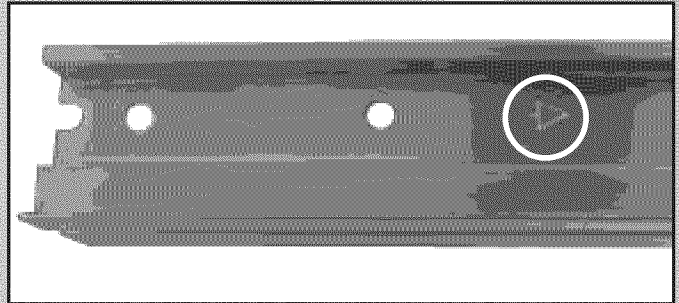

FIG. 1-2 Alignment arrows.

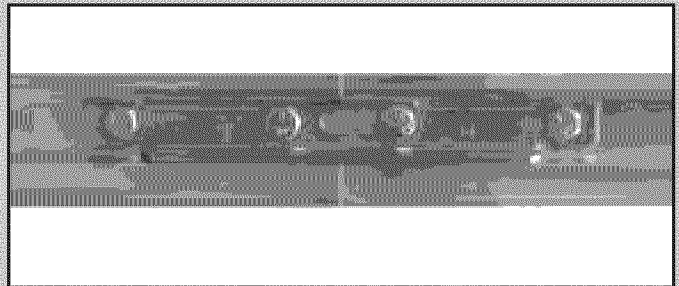

FIG. 1-3 Attach rail clamps.

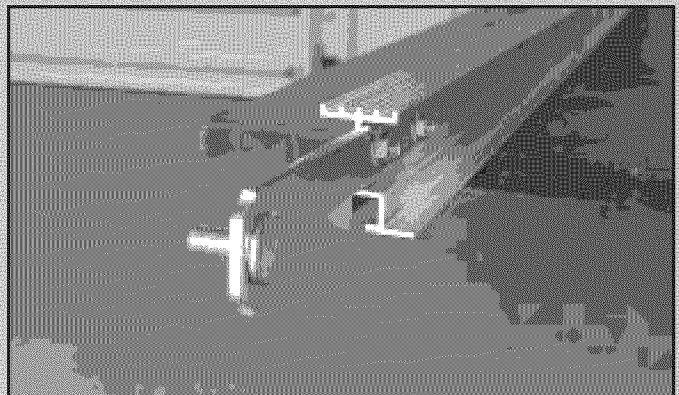

FIG. 1-4 Attach rail strap.



**CAUTION**

Make sure that the carriage magnet is in place in the top of the carriage slide.

**5. Slip carriage into carriage slot of rail.**

- Flip the rail assembly up side down.
- Place emergency release lever in “release” position
  - Check arrow on the side of carriage points toward **door end** of rail.
  - Slide carriage into rail at **power head end** (Fig. 1-5).
  - Flip rail assembly right-side up.

**6. Attach rail to power head.**

- Place rail in front of power head with rail strap at opposite end.
- Support door end of rail (rail strap) at about same height as power head.
  - Check if magnet is in place (Fig. 1-6 inset). Insert carriage slide into rail (Fig. 1-6). (*Carriage slide is long straight piece attached to chain.*)
  - Pull rail toward you as you feed chain into it. (Fig. 1-6). When the end of the rail is within about 2 chain links of the power head, you can then push it the rest of the way. (It is a snug fit.)
  - Securely fasten with 2 bolts (9) and nuts (10) (Fig. 1-7).



**OPEN GREEN PARTS BAG**

**7. Attach emergency release cord, knob and tag.**

- Tie overhand knot in 1 end of cord. Tighten knot. (Fig. 1-8 inset A).
  - Slip opposite (no knot) end through knob.
  - Slip through hole in emergency release lever (Fig. 1-8).
  - Tie overhand knot in this end also. Tighten knot.

**8. Attach emergency release tag.**

- Attach to hole in emergency release using metal twist tie on tag. (Fig. 1-8 inset B).

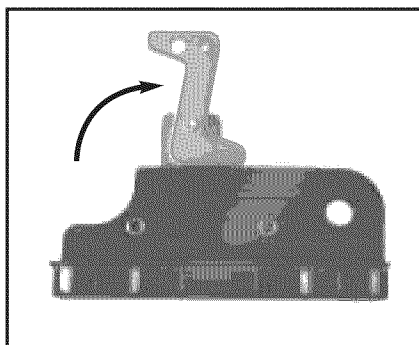

Lever in release position.

Rail is up-side down



FIG. 1-5 Align arrow.

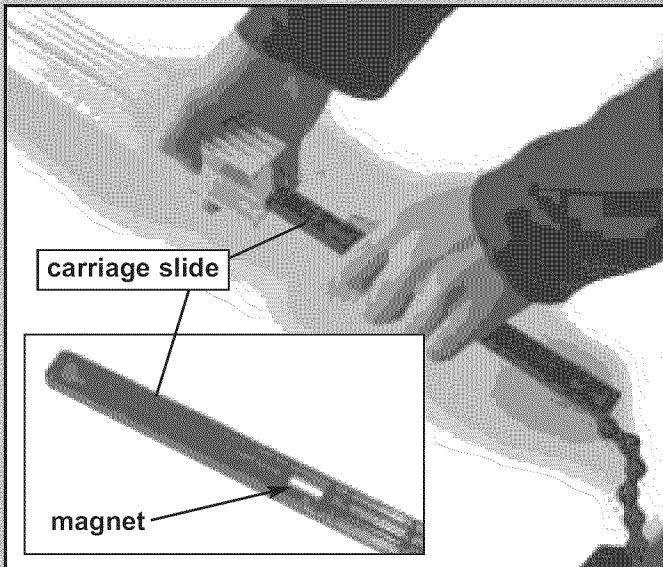

FIG. 1-6 Slip carriage slide into rail.

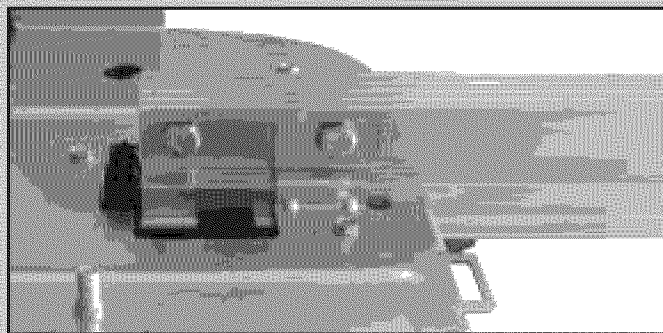

FIG. 1-7 Attach rail to power head.

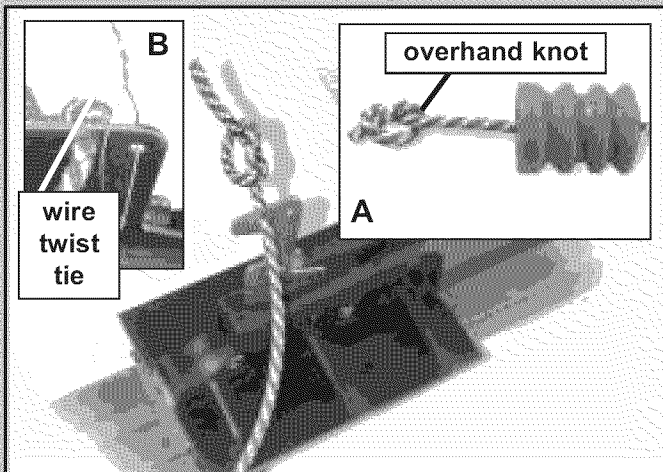

FIG. 1-8 Attach emergency release cord & tag.

### 9. Attach limit switches.

2 switches included, "CLOSE" limit switch (brown wire) and "OPEN" limit switch (white wire) (Fig. 1-10).

- Turn set screws (39) into threaded holes, just enough so screw stays in place. (Fig. 1-10).



- Point arrow on top "CLOSE" limit switch toward door end of rail.
  - Place "CLOSE" limit switch (Brown wire) on rail about 12" from rail strap (Fig. 1-11).
  - Gently tighten set screw enough to keep switch from moving.
- Point arrow on top "OPEN" limit switch toward door end of rail.
  - Place "OPEN" limit switch (white wire) on rail where chain attaches to carriage slide. (Near the power head.)
  - Gently tighten set screw enough to keep switch from moving.

### 10. Attach limit switch wires.

- Uncoil limit switch wires.
  - Place into channels located along top of rail.
  - Run wires back to power head through hole in top of power head (Fig. 1-12).
  - Use wire clips to hold wires in place (Fig. 1-13).

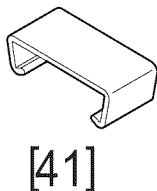

- Attach limit switch wires to terminals on power head (Fig. 1-14).
  - White wire ("OPEN") to terminals #4 and #5.
  - Brown wire ("CLOSE") to terminals #5 and #6.
- Bundle extra wire and lay it on top of power head (Fig. 1-14 inset).

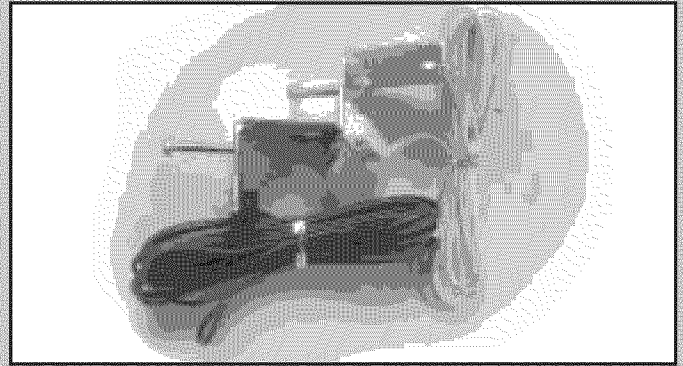

FIG. 1-10 Identify limit switches / insert set screws.

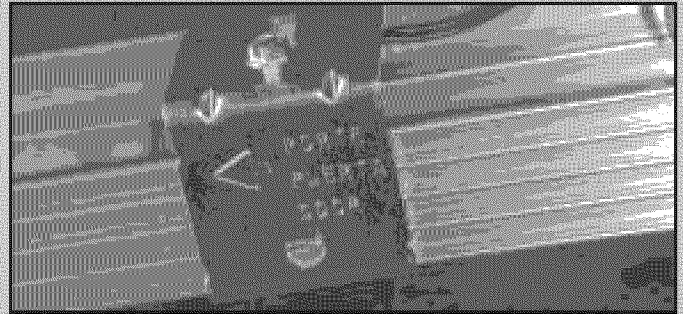

FIG. 1-11 Place limit switches.

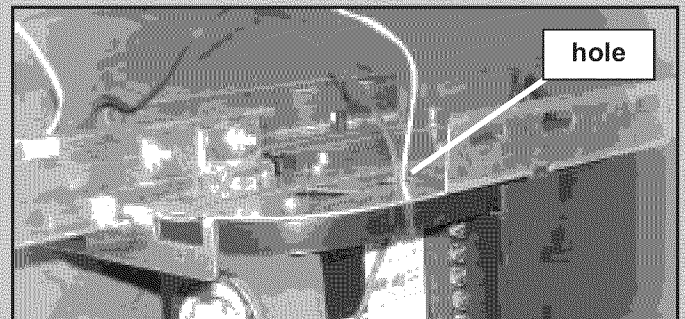

FIG. 1-12 Run wire to power head.

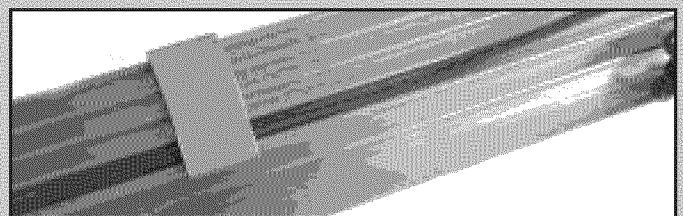

FIG. 1-13 Wire clips.

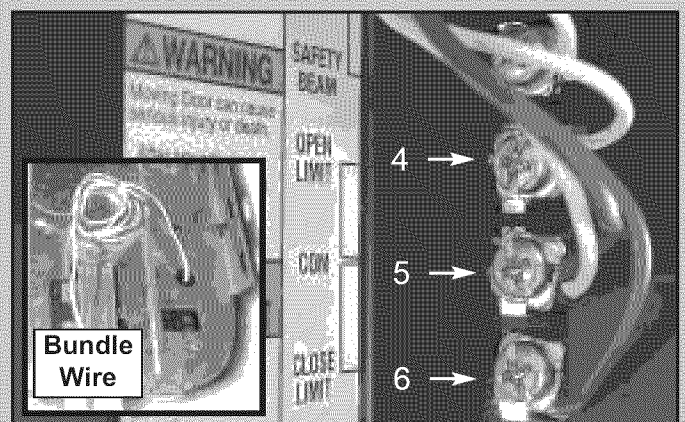

FIG. 1-14 Attach wire at power head terminals.

IMPORTANT

**⚠ WARNING :**

**To reduce the risk of severe injury or death:**

1. READ AND FOLLOW ALL SAFETY, INSTALLATION AND OPERATION INSTRUCTIONS. If you have questions or do not understand an instruction, call The Genie Company or an authorized Genie Dealer.
2. **Do Not** install operator on an improperly balanced door. An improperly balanced door could cause severe injury. Repairs and adjustments to cables, spring assembly, and other hardware must be made by a professionally trained service technician using proper tools and instructions.
3. Remove all ropes and disable all locks connected to the door before installing operator.
4. Install door operator 7 feet or more above floor. Mount emergency release knob 6 feet above floor.
5. **Do Not** connect the operator to the source of power until instructed to do so.
6. Locate the control button:
  - Within sight of door.
  - At minimum height of 5 feet above the highest floor level, so small children cannot reach it.
  - Away from all moving parts of the door.
7. Install the Entrapment WARNING Label next to the wall button or wall console. Install the emergency release tag on, or next to, the emergency release.
8. The operator must reverse when the door contacts a 1-1/2 inch high object on the floor at the center of the doorway. This is the size of a 2" x 4" board laid flat.

**HEADER AND DOOR MOUNTING BRACKETS:**

**⚠ CAUTION**

Header bracket must be fastened to garage framing. **Do Not** fasten to drywall, particle board, plaster or other such materials.

**1. Finding header bracket mounting location.**

- Close garage door.
  - Use a pencil.
    - a. Mark center of garage door (*one-half overall width*) with 6" vertical line at top edge of door.
    - b. Continue this line on wall above door for about 12" (**Fig. 2-1**).
- Raise garage door until **top edge** of door reaches its maximum height (**Fig. 2-2**).
- Place door at highest point.
  - Measure height from top edge of door to floor.
- Close door again.
- Mark height measurement on wall above door.
  - Make your mark across vertical line made earlier.

**• Marking final height.**

**THE 2 BASIC TYPES OF GARAGE DOOR MECHANISMS ARE:**

**Sectional doors**—have rollers on each side which ride in "tracks" to guide the door up and down.

**One-Piece doors**—swivel on large spring loaded hinges as the door opens and closes.

- For **sectional** – add 2-1/2" to height mark just made on wall. This is location for header bracket.

**NOTE:** *If spring or its shaft is in way, measure 2-1/2" above spring or shaft and mark this height as your location for header bracket.*

- For **one-piece** – add 6"- 12" to your height mark just made on the wall. This is location for header bracket.

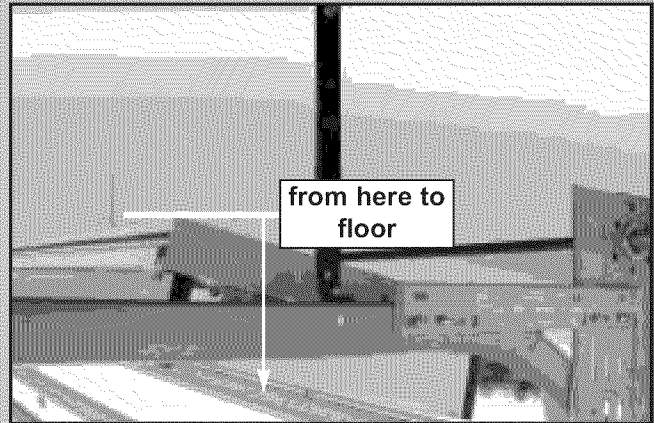

**FIG. 2-1** Finding highest point of travel (sectional).

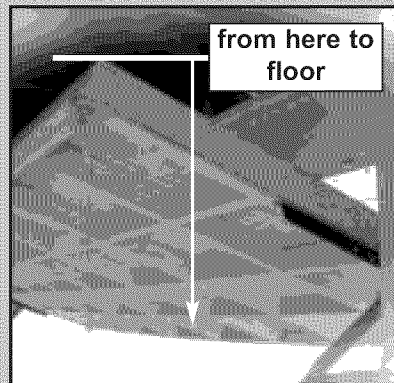

**FIG. 2-2** Finding highest point of travel (1-piece).

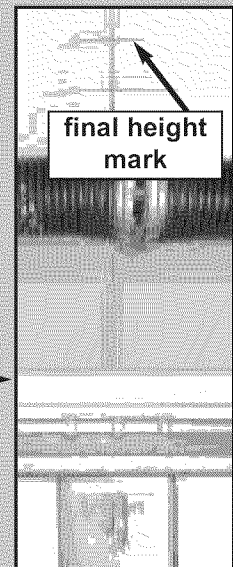

**FIG. 2-3** Final height mark.

**NOTE:** If header bracket location needs to be above header for garage door opening, you need to add a "mounting surface." A 2" x 6" board securely attached (fasteners not included) across wall studs on either side of your mark is sufficient (Fig. 2-4).

## OPEN ORANGE PARTS BAG

12

### 2. Mounting the header bracket.

**NOTE:** Although header bracket may be oriented several ways, method 1 is preferred if possible because of added strength over other methods (Fig. 2-5).

- Hold header bracket against wall (Fig. 2-5).
  - Place left edge on vertical line.
  - Bottom edge on final height line.
- Mark screw hole locations on wall.
- Drill 5/32" pilot holes at each screw hole mark.
  - Fasten header bracket with 3 lag screws (22) (Fig. 2-5).

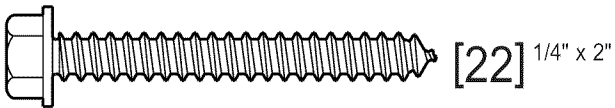

### DOOR BRACKET:

#### ⚠ CAUTION

Doors made of masonite, lightweight wood, fiberglass, and sheet metal must be properly braced before mounting door operator. Contact door manufacturer or distributor for a bracing kit. The Genie Company is not responsible for damage caused due to improperly braced door (Fig. 2-6).

### 3. Finding door bracket mounting location.

- Door bracket is mounted as high on door as possible along vertical centerline.

**NOTE:** In the case of sectional type doors, door bracket must be mounted **NO LOWER THAN** top set of rollers (Fig. 2-7).

For 1-piece doors, door bracket must be mounted at top edge of door.

### 4. Mounting the door bracket.

- Proper bracing should be verified at this point.
  - Align door bracket centered on your vertical centerline.
  - Attach using 3 **self-drilling screws** (42) for sheet metal or other **light weight material**.
  - Use **lag screws** (22) for **solid wooden doors**.

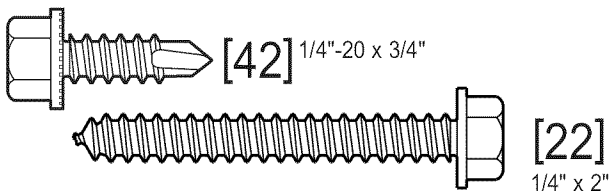

**NOTE:** For solid wood doors, carriage bolts WITHOUT SLOTTED HEADS (not included) may also be used for attaching door bracket.

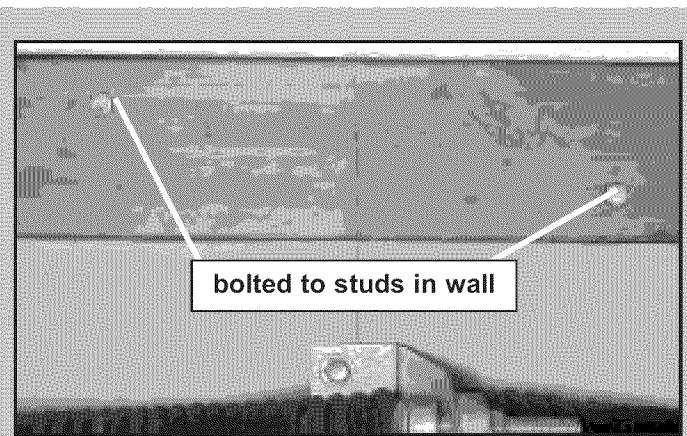

FIG. 2-4 Adding mounting surface.

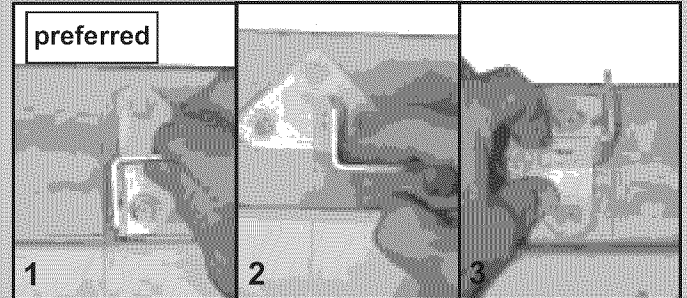

FIG. 2-5 Header bracket in place (3 methods).

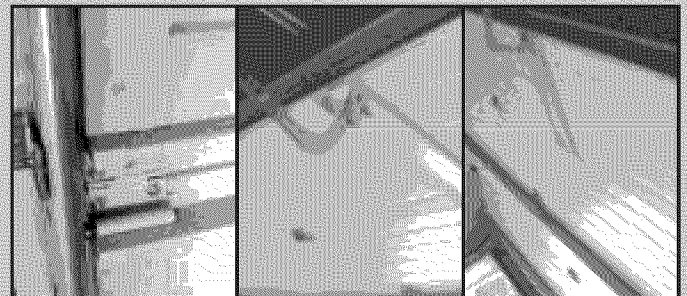

FIG. 2-6 Examples of door bracing.

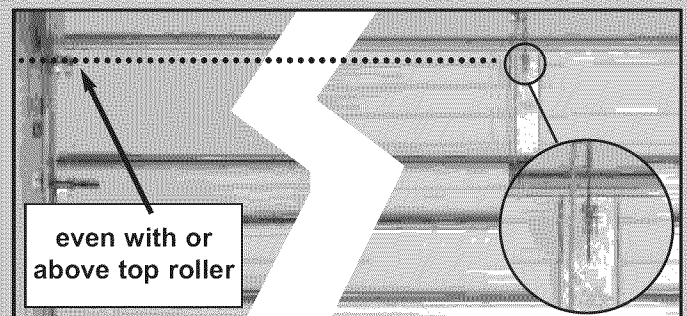

FIG. 2-7 Mounting door Bracket (sectional).

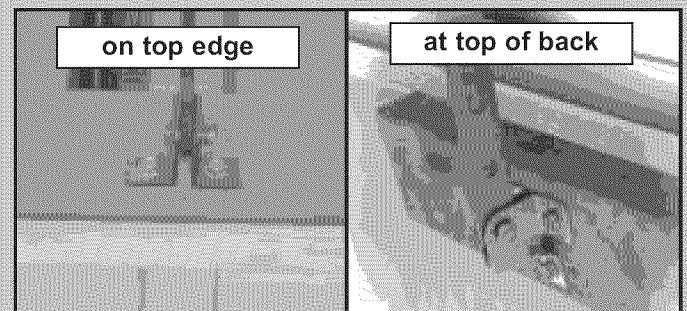

FIG. 2-7B Mounting door Bracket (one-piece).

## MOUNTING THE OPERATOR:

### 1. Getting Started.

- Position rail/power head assembly (Fig. 2-7).
  - Rail strap leaning on wall next to header bracket.
  - Place material on floor under power head to protect from scratching. (A box, stool, or similar device may be needed to clear a torsion spring, as shown.)

### 2. Mounting the assembly.

- Attach rail strap to header bracket using nut (47) (Fig. 2-7 inset). FINGER TIGHT ONLY.



- Support power head on step-ladder.

**NOTE:** Before final attachment to ceiling, insure that assembly is in proper alignment (Fig. 2-9).

- Attach mounting straps to ceiling using lag bolts (22) (Fig. 2-10).
- Set height of power head according to following:
  - **Track guided doors.**
    - a. Rail must clear door at highest point of travel
    - b. Be level or, power head slightly below level.
  - **Trackless doors.**
    - a. Rail must clear door at highest point of travel by 1" to 1-1/2".
- Securely tighten power head mounting bolts (46) and nuts (47).
- Lower door.
- Fully tighten rail strap nut.
- **DO NOT PLUG UNIT IN YET!**

### 3. Adjusting length of emergency release cord.

- Check emergency release knob height.
  - Low enough you can reach it.
  - High enough to clear your vehicle, but **NO HIGHER THAN 6 FEET ABOVE FLOOR.**
- Tie a new overhand knot where desired.
  - Cut off any extra cord.

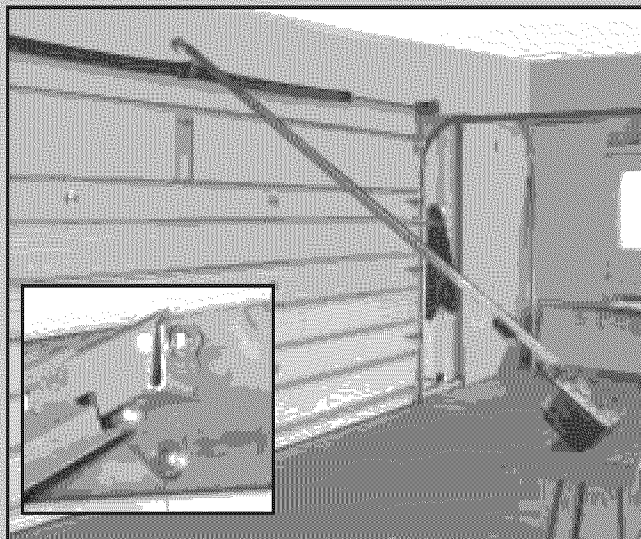
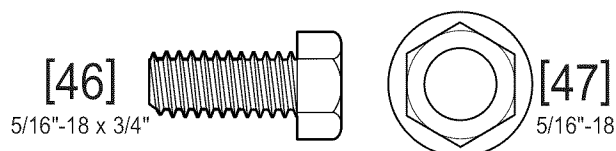
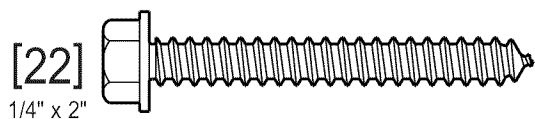

FIG. 2-7 Position assembly.

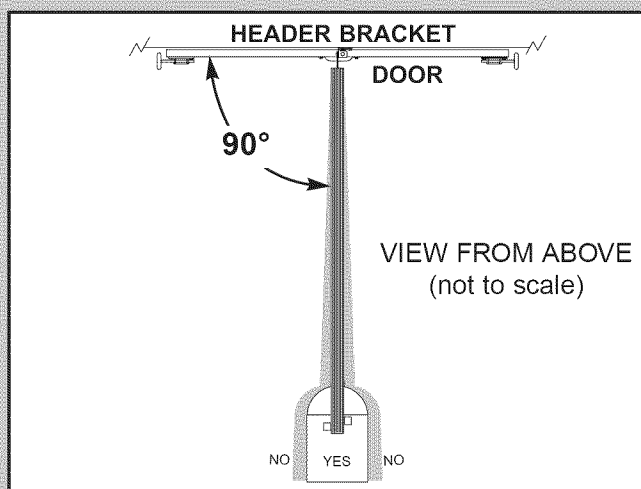

FIG. 2-9 Operator must be aligned.

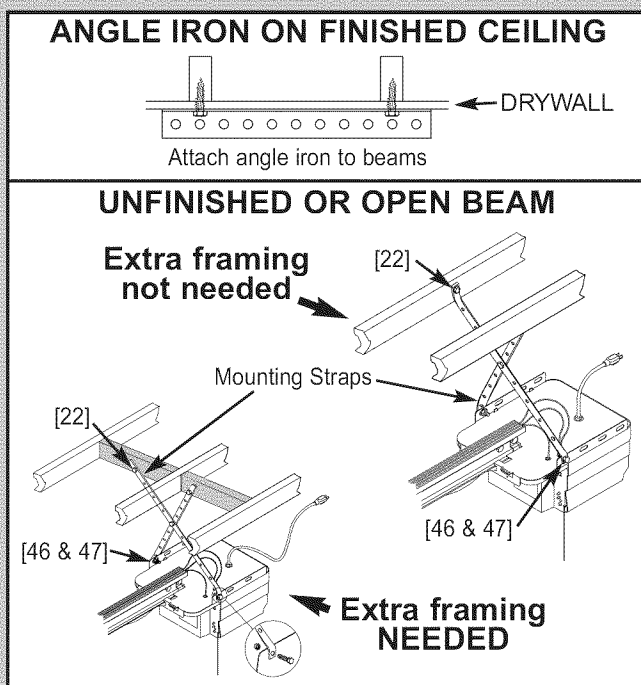

FIG. 2-10 Mounting the power head.

## INSTALL DOOR ARMS: Sectional doors

### OPEN YELLOW PARTS BAG

14

#### 1. Attach the arms.

- Fasten curved door arm to door bracket using clevis pin (24) and cotter pin (25) (**Fig. 2-10**).
- Straight arm to carriage using clevis pin (24) and cotter pin (25) (**Fig. 2-10**).



#### 2. Connecting the arms.

- Slide carriage back and forth to adjust arm length.
  - **Overlap** arms as **much** as possible.
  - Make overall **length** as **short** as possible.
- Fasten arms together using 2 bolts (27) and nuts (28) (**Fig. 2-10**). (*Place the bolts as far apart as possible.*)

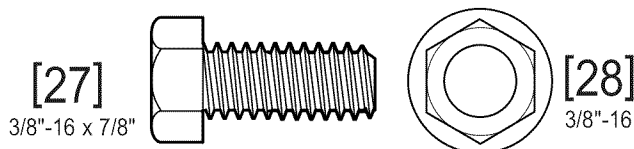

**NOTE:** Whenever possible, it is recommended that the door arms assembly be angled away from the door to prevent putting downward force on the door and door bracket. (**Fig. 2-11**).

Additionally, where possible, the straight door arm may be eliminated.

## INSTALL DOOR ARMS: 1-piece doors

### OPEN YELLOW PARTS BAG

#### 1. Attach the arms.

- Straight arm to door bracket using clevis pin (24) and cotter pin (25) (**Fig. 2-12**).
- Curved arm to carriage using clevis pin (24) and cotter pin (25) (**Fig. 2-12**).

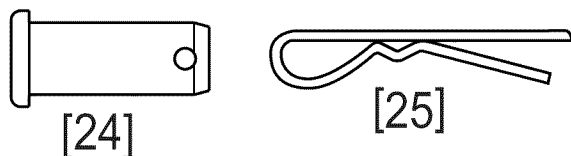

#### 2. Connecting the arms.

- Slide carriage back and forth to adjust arm length.
  - **Overlap** arms as **little** as possible.
  - Make overall **length** as **long** as possible.
- Fasten arms together using 2 bolts (27) and nuts (28) (**Fig. 2-12**).

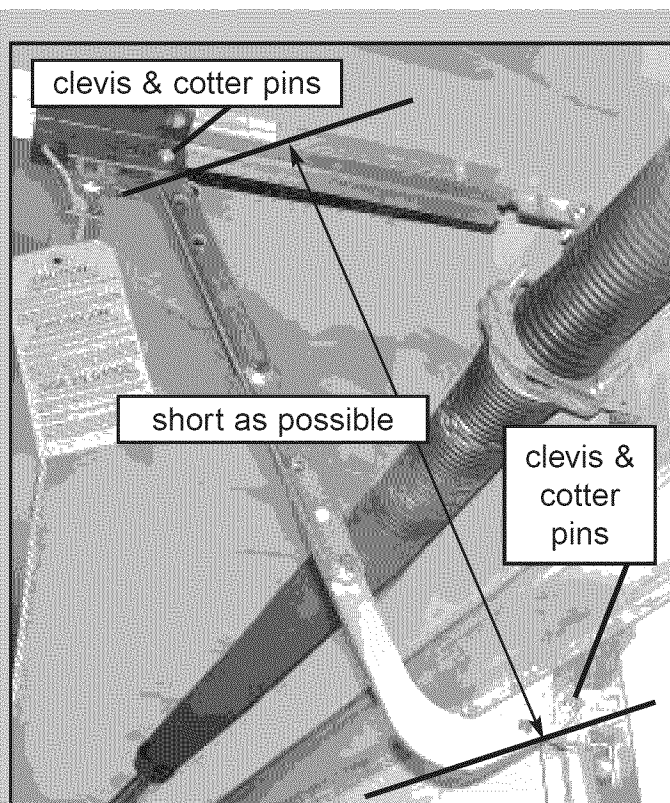
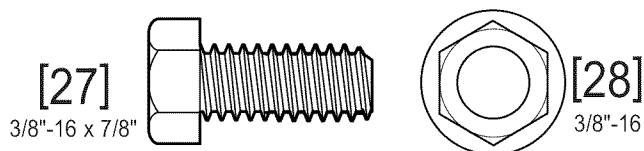

FIG. 2-10 Attaching door arms (sectional doors)

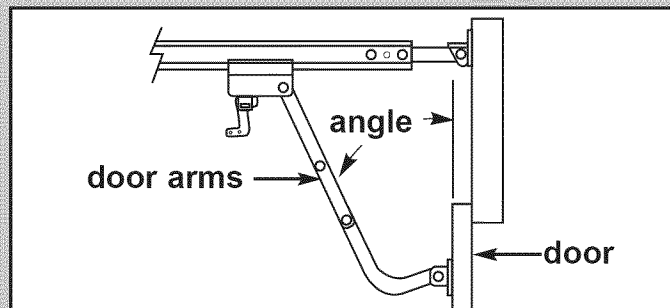

FIG. 2-11 Door arms at angle to door.

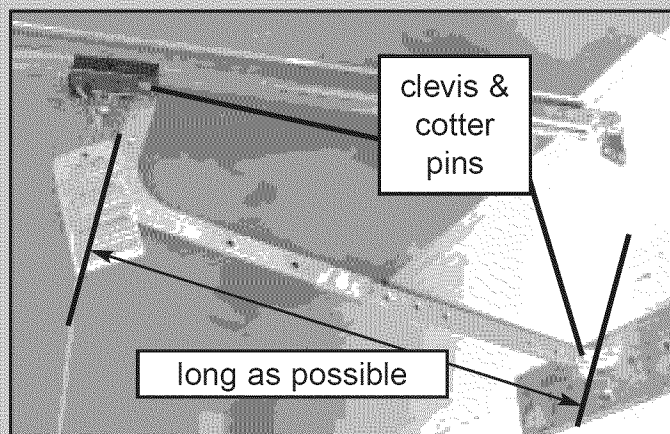

FIG. 2-12 Attaching door arms (1-piece doors)

**REMINDER:** If you have no access to your garage from the outside other than your garage door, please consider a GER-2 emergency release kit shown on page B in center of manual. Call Customer Service at 1.800.354.3643, or visit [www.geniecompany.com](http://www.geniecompany.com).

## ⚠ WARNING

There should be no electrical power to the operator while installing Safe-T-Beam System® wires. If you have plugged in the power cord—UNPLUG IT NOW.

**NOTE:** The operator will not close the door automatically unless the Safe-T-Beam® System is installed.

### 1. Mounting brackets.

- Mark both sides of garage door frame or wall 5" above floor. (Fig. 3-1).
- Hold bracket against door frame or wall.
  - Check if brackets extend out from wall far enough, so tongue of bracket is beyond door, tracks or any door hardware.
  - If not:
    - a. "STB" bracket extensions are available at local dealer.
    - b. Blocks of wood, etc. may be substituted for extensions.
- Center bracket on your mark (Fig. 3-2).
- Fasten each with 2 screws (44) (Fig. 3-2).



**NOTE:** Mounting brackets can be attached to the floor using concrete anchors (not provided).

### 2. Mounting "STB" source and sensor.

- If garage has only one garage door.
  - Determine which side of garage receives most direct sunlight (Fig. 3-4).
  - Red LED should always be on sunny side whenever possible (Fig. 3-4).
- For multiple doors.
  - Preventing crossed signals is critical.
  - Place source and sensor modules on adjacent doors facing in opposite directions (Fig. 3-4).

**NOTE:** To help prevent interference from sun, "STB" sensors (Green LED) may be placed further away from the door opening where they will spend more time in shadows.

- Slide source/sensor onto tongue of bracket until it clicks into place (Fig. 3-3).

### 3. Wiring.

- Route wire (29) using either method shown (Fig. 3-5).
- Wires along rail are held in place with wire clips.

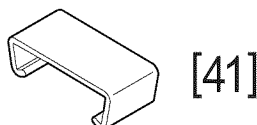

- Wires can be slipped under the wire clips already in place.

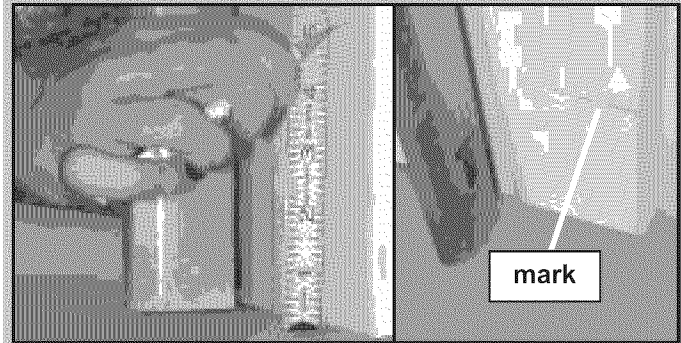

FIG. 3-1 Mark door frame.

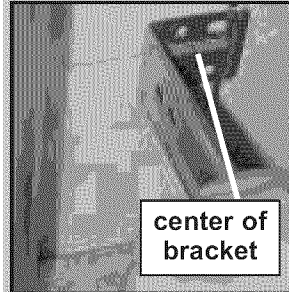

FIG. 3-2 Mount brackets.

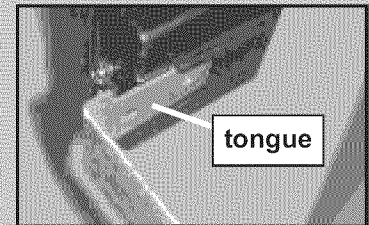

FIG. 3-3 Attaching STB's to brackets.

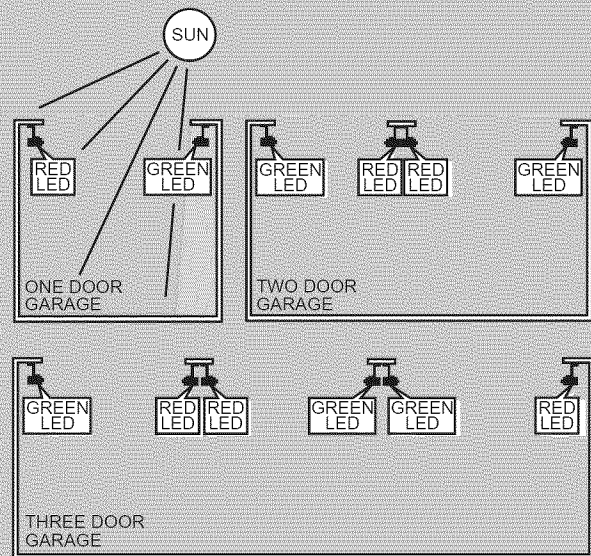

FIG. 3-4 STB locations.

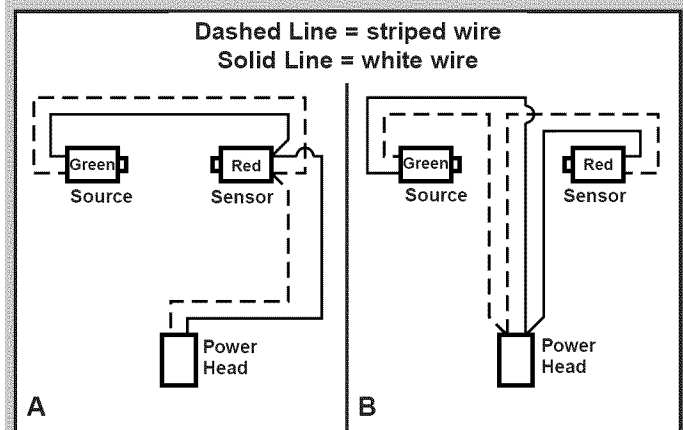

FIG. 3-5 STB wiring methods.

## OPEN RED PARTS BAG

16

### 3. Wiring (cont').

- Securely fasten wires to wall as you go.
  - Use insulated staples (included).

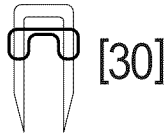

- Staples should be snug only.

#### **CAUTION**

Staples which are too tight can cut or pinch wires. Cut or pinched wires can cause the "STB" System to stop working. When using the insulated staples, make sure you fasten them only as tightly as needed to hold the wire snugly.

- Make wire attachments at "STB's."
  - Splitting and stripping wire ends to be connected as shown (Fig. 3-6).
  - Loosen terminal screws.
  - Insert wire under flat plate and tighten screw. It does not matter which wire, white or striped, goes on which terminal (Fig. 3-7).
- Make wire attachments at power head.
  - "STB's" are connected to terminals #2 and #3 on power head (Fig. 3-8).

### 4. Check the following.

- Insure that no part of door or its hardware is in path between lenses of **source** and **sensor**.
- Insure that tops of lenses are between 5"-6" above the floor (Fig. 3-9). The brackets are flexible, and can be adjusted slightly if needed.

*NOTE: Safe-T-Beam® alignment check must be performed following connection to electrical power (see page 18). DO NOT PLUG IN YET!*

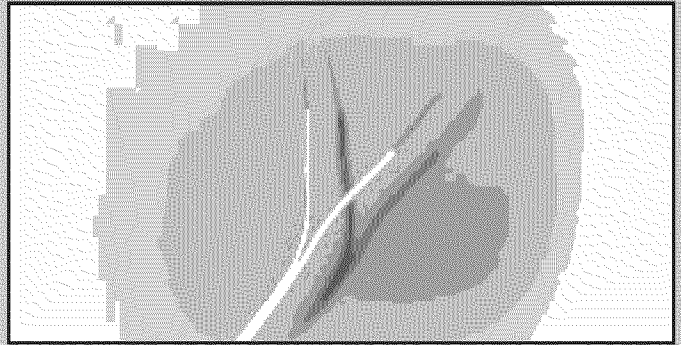

FIG. 3-6 Splitting and stripping.



FIG. 3-7 Terminal attachments at STB.

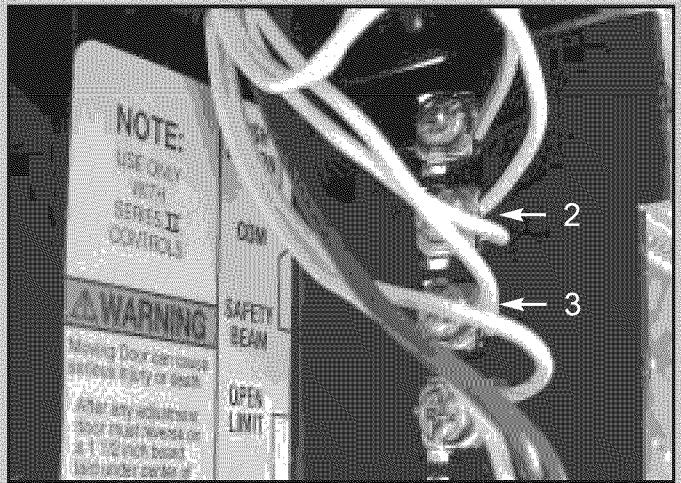

FIG. 3-8 Terminal attachments at power head.

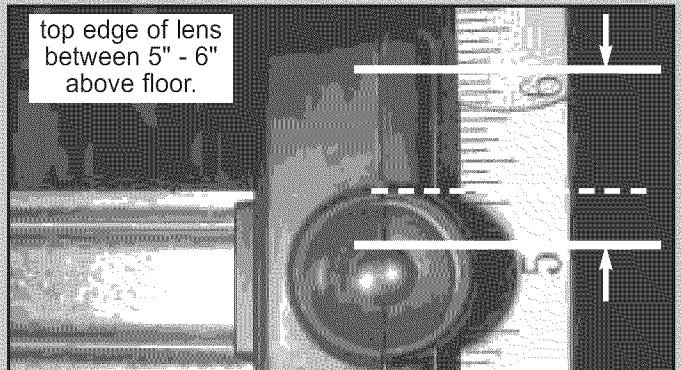

FIG. 3-9 Check lens height.



## ⚠ WARNING

Verify there is no power to the operator before installing wall control wires.

## ⚠ CAUTION

Use of any wall control other than the type supplied will prevent the light from working and could cause the door to operate on its own.

Cut or pinched wires can cause the wall control to stop working. When using the insulated staples, make sure you only pound them in as far as needed to hold the wire snugly.

### 1. Finding the mounting location.

- Pick a convenient location for mounting wall control.
  - Location you choose should be in direct sight of door.
  - It should be at least 5' above floor to prevent small children from operating door.
  - It must be away from any moving parts. (You should not be able to reach the door while standing at wall control.)

### 2. Wiring.

- Run wire from power head to wall control.
- Securely fasten to ceiling using insulated staples provided.
- Split and strip ends of wire (Fig. 4-5).
- On power head:
  - Attach the **striped wire to terminal #1** and **white wire to terminal #2** (Fig. 5-1).
- On back of wall control:
  - Attach **striped wire to terminal "B"**, and **white wire to terminal "W."** (Fig. 5-2).

### 3. Mounting.

- Fasten wall control to wall with 2 screws (33) (Fig. 5-3).



- Remove protective backing from "entrapment" warning label (Fig. 5-4).
  - Stick label on wall near wall control.

**NOTE:** Additional wall controls are available from your dealer. ONLY ONE OF YOUR WALL CONTROLS MAY BE THE LIGHTED TYPE. If you have a lighted wall control, all your additional controls must be un-lighted. More than one lighted wall control per operator will cause a malfunction.

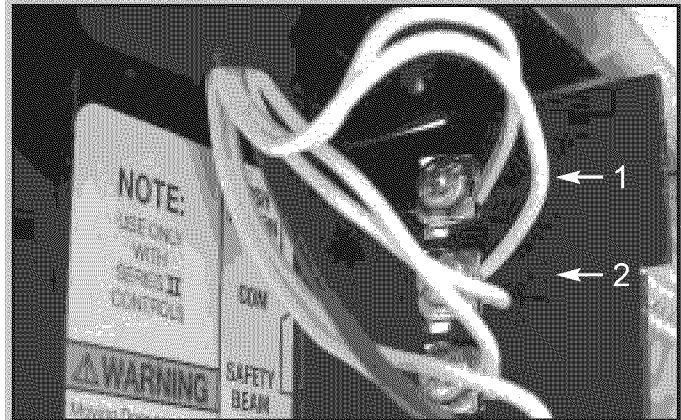

FIG. 5-1 Terminal attachments at power head.

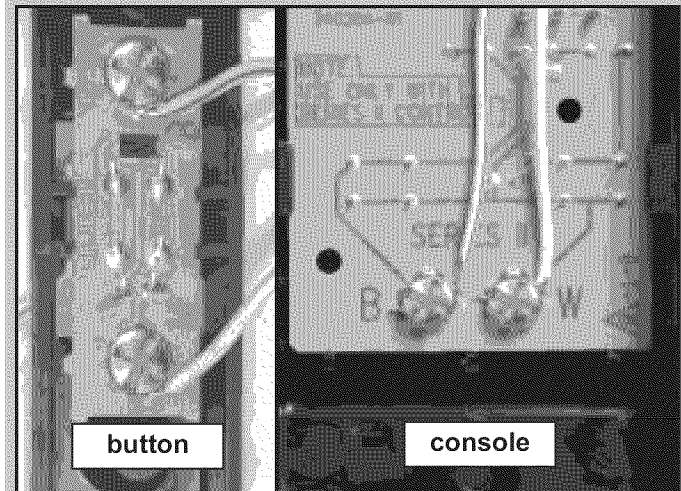

FIG. 5-2 Wall control wire attachment.

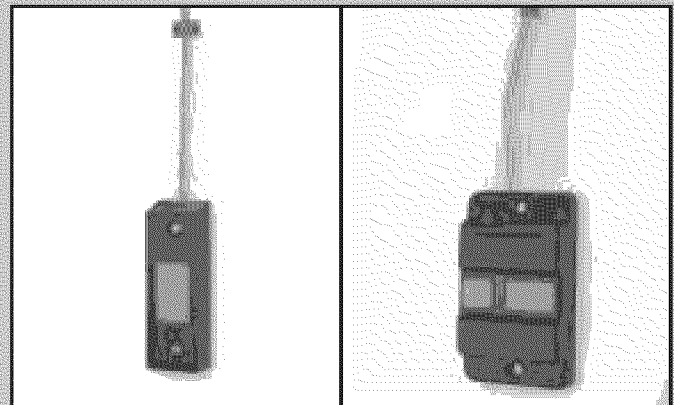

FIG. 5-3 Mounting wall control.

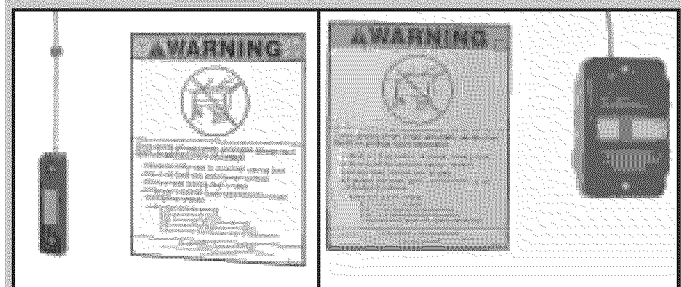

FIG. 5-4 Entrapment warning label.

## WITH GROUNDED PLUG:

### ⚠ WARNING

To reduce the risk of electrical shock, this equipment has a grounded type plug that includes a third (*grounding*) pin. This plug will only fit a grounded type outlet. If you do not have a grounded outlet, contact a qualified electrician to install one. DO NOT alter the plug in any way. The door operator must be properly grounded in order to prevent personal injury and damage to the components.

### ⚠ CAUTION

Check local building codes to make sure that you are not required to have your garage door operator permanently wired, with circuit breaker protection. If permanent wiring is required, have this installed by a qualified electrician.

1. Plug the operator into a properly grounded electrical outlet.
2. Check Safe-T-Beam® alignment (Fig. 6-3).

## WITH PERMANENT WIRING:

### ⚠ WARNING

The electrical power to the door operator MUST BE turned off when the motor cover is removed. Electrical power must remain off while making electrical connections.

1. Instructions for electrician.
  - Remove power from circuit.
  - Remove motor cover (Fig. 6-1).
    - Removing hex head screw located in center on bottom of cover.
    - Slide cover down and off.
  - Remove and throw away existing power cord.
  - Remove 7/8" knockout plug (Fig. 6-2).
    - Install a suitable entrance bushing.
  - Connect permanent wiring to power head.
    - **White to white/black to black / ground to green.**
    - Use only UL recognized wire nuts.
  - Wires inside power head must be at least 6" in length.

### ⚠ CAUTION

The circuit board is light sensitive. Make sure the motor cover has been replaced prior to re-energizing the circuit.

- Replace motor cover and re-energize the circuit.

2. Check Safe-T-Beam® alignment (Fig. 6-3).

**NOTE:** The Genie Company is not responsible for charges resulting from work performed by an independent electrician.

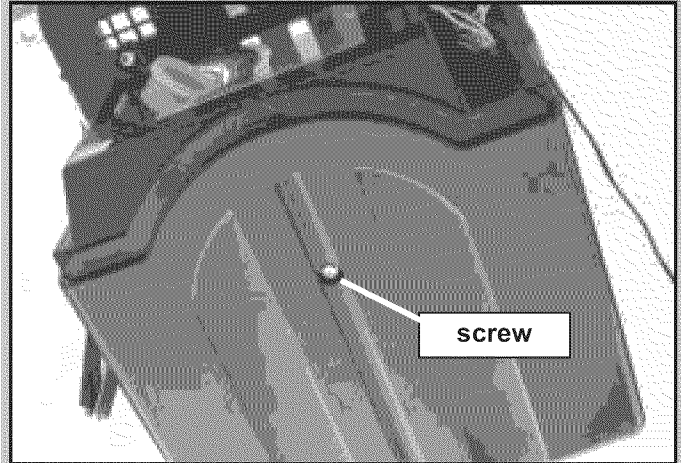

FIG. 6-1 Removing motor cover.

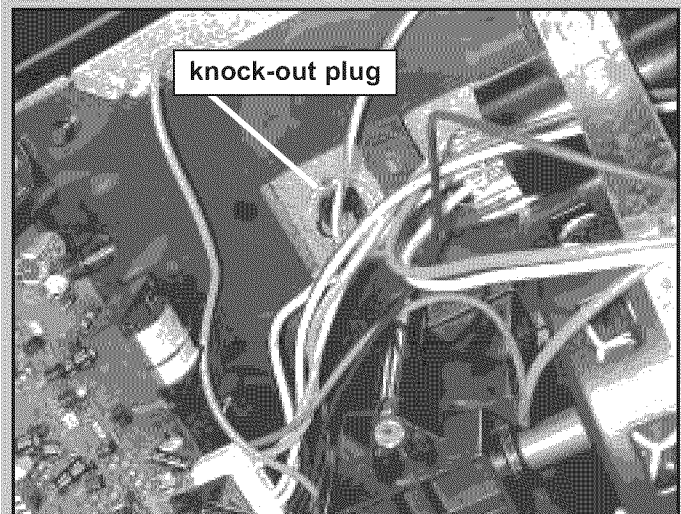

FIG. 6-2 Knock-out plug.

## Safe-T-Beam® Alignment Check

After turning the electrical power on, if the STB's are not in proper alignment, the red LED (Source) will blink continuously.

To correct the problem — the brackets are flexible and can be adjusted slightly to bring the system into alignment.

When the STB's are in alignment the red LED will stop blinking and stay on.

FIG. 6-3

**NOTE:** If a problem exists with the "STB" that is preventing the door from closing, the door can be closed by holding the wall control button in until the door is fully closed. (The remote control will not work.)

## ⚠ WARNING

DOOR OPENS RAPIDLY.

*Keep the path clear.*

Position the ladder to the side of the power head so it is clear of all moving parts of the operator and door.

Always set the door operator to the minimum force required to operate the door.

*NOTE: During operator cycling for force adjustment, the motor protector may shut off power to the operator. If this occurs, wait about 20 minutes to allow the motor protector to reset.*

### 1. Adjusting limit switches.

- Locate force control knobs on power head (Fig. 7-1).
  - Gently turn both control knobs counter-clockwise until they stop.
- Verify emergency release lever in **disengaged** position.
- Verify **"OPEN"** limit switch at point where chain attaches to carriage slide (Fig. 7-2).
- Manually close door.
- Move the **"CLOSE"** limit switch:
  - Loosen set screw.
  - Slide limit switch along rail to align front edge of switch with back edge of carriage (Fig. 7-3).
  - Gently tighten set screw.
- Press wall control button.
  - Carriage slide will move toward power head and stop at the **"OPEN"** limit switch.
- Manually open door.
- Move the **"OPEN"** limit switch:
  - Loosen set screw.
  - Slide limit switch along rail to align front edge of switch with back edge of carriage (Fig. 7-4).
  - Gently tighten set screw.
  - Manually close door.
- Place emergency release lever in **engaged** position.
- Press wall control button.
  - Carriage slide will move toward door, engage with carriage and stop at **"CLOSE"** limit switch.

### 2. Adjusting "OPEN" force.

- Press wall control button.
  - Door should open and stop at "OPEN" limit.
- Door does not fully open.
  - Press wall control button.
  - Door should close and stop at "CLOSE" limit.
  - Turn "OPEN" force control knob slightly in clockwise direction.
  - Press wall control button.
    - a. Continue step 2 until door opens completely.

### 3. Adjusting "CLOSE" force.

- Door is not fully closing.
  - Cycle door, turning "CLOSE" force knob clockwise slightly each time until door reaches fully closed.



FIG. 7-1 Force adjustment screws.

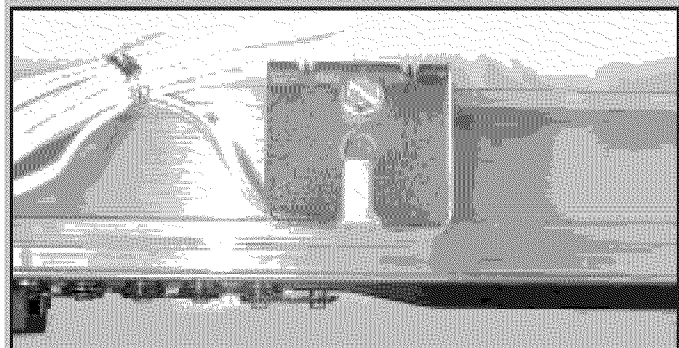

FIG. 7-2 Place "Open" limit switch.

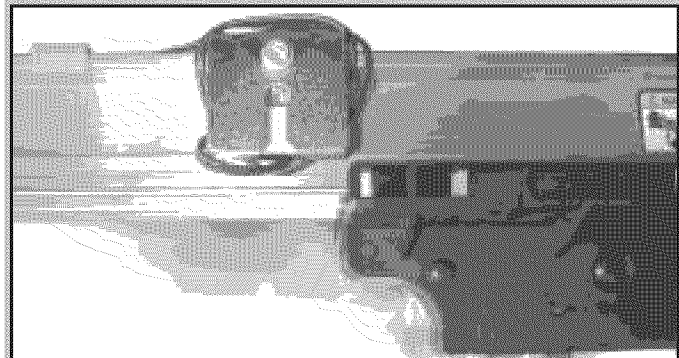

FIG. 7-3 Align "CLOSE" limit switch.



FIG. 7-4 Align "OPEN" limit switch.

## CONTACT REVERSE TEST

The force adjustments and limit switch settings **MUST BE COMPLETED** before testing contact reverse.

### 1. Testing.

- Open garage door using wall control.
  - Place a 2" x 4" board (laid flat) under center of garage door opening (**Fig. 7-5**).
  - Close door using wall control.
- When door hits board, it must stop and reverse (within 2 seconds) to open position.

### 2. Adjustment.

- Door does not properly reverse.
  - Check to see if door is at "close" limit.
  - It should not have reached limit switch before hitting board.
- Door is at close limit switch.
  - Move limit switch closer to door.
- Test again. Repeat as necessary.
- Door is not reaching "close" limit, but still does not reverse.
  - Decrease "CLOSE FORCE" setting slightly (turn it counter-clockwise).
- Test again. Repeat as necessary.

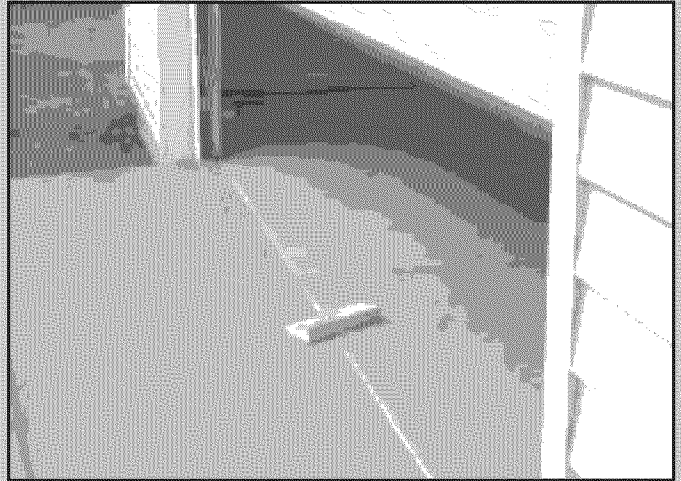

FIG. 7-5 2 x 4 under center of door opening

## FCC and IC CERTIFIED

This device complies with FCC Part 15 and RSS 210 of Industry Canada. This equipment has been tested and found to comply with the limits for a Class B digital device, pursuant to Part 15 of the FCC Rules. These limits are designed to provide reasonable protection against harmful interference in a residential installation. This equipment generates, uses and can radiate radio frequency energy and, if not installed and used in accordance with the instructions, may cause harmful interference to radio communications. However, there is no guarantee that interference will not occur in a particular installation. If this equipment does cause harmful interference to radio or television reception, which may be determined by turning the equipment off and on, the user is encouraged to try to correct the interference by one or more of the following measures:

Re-orient or relocate the receiver antenna.

Increase the separation between the operator and receiver.

Connect the operator into an outlet on a circuit different from that to which the receiver is connected.

Consult your local dealer.

## 7 PROGRAMMING REMOTE CONTROLS

### SINGLE BUTTON REMOTE

#### 1. Programming.

- Locate learn code button and indicator LED on front of power head (under force adjustment screws) (**Fig. 8-1**).
- Press and release learn code button.
  - Indicator LED will blink at a rate of twice per second.
- **Within 30 seconds**, push remote control button once.
  - Indicator LED will stop blinking and stay on.
- Press remote control button again.
  - LED will go out. Remote is now programmed.

#### 2. Operating.

- Press remote button once.
  - Door will move.
- Press button again.
  - Door will stop.
- Press button again.
  - Door will move in opposite direction.

The door will stop automatically at the fully open or fully closed position.



FIG. 8-1 Learn code button and LED

### MULTI-BUTTON REMOTE

#### 1. Programming.

*NOTE: Each button on a multi-button remote is designed for use with 1 door. You cannot program 2 buttons to operate the same door, nor can you program 1 button to operate 2 doors.*

- For each button.
  - Program each button separately.
  - Follow single button remote procedure (previous page) for each button.

#### 2. Operating.

- Same as single button remote.

### LOST OR STOLEN REMOTE

#### 1. Clear memory.

- Press and hold learn code button (on power head) for 10 seconds or until Indicator LED goes out.
- Program remaining or new remote controls as done previously. *Your door operator will no longer recognize any signal received from the missing remote control, or any other which has not been reprogrammed.*

### 8 REMOTE CONTROL BATTERY REPLACEMENT AND VISOR CLIP INSTALLATION

#### 1. Battery replacement.

- Use coin, ball-point pen or similar device.
  - Gently push straight in on battery cover lock tab as shown (Fig. 9-1).
- Flip open battery cover.
- Remove old battery.
- Make sure new battery is facing proper direction (Match battery polarity with symbols inside battery cover) (fig. 9-2).
- Recommended replacement battery is **Eveready A-23**, 12 volt.
- Slip new battery into place.
  - Snap battery cover shut.
- Operate remote to make sure it is working properly. (No re-programming is needed.)

#### 2. Visor clip.

- Slide visor clip into back of remote control.
  - It will snap into place (Fig. 9-3).

### 9 LIGHT BULB/LENS INSTALLATION

#### 1. Light bulb.

- Recommendations.
  - Do not use a short neck bulb.
  - Light bulb should be no more than 100 Watts.
  - Use a **heavy duty service** bulb for longer life.
- Screw bulb into socket.

#### 2. Lens.

- Slide hinges into slots on motor cover (Fig. 10-1).
- Swing lens up.
  - Fit tabs into slots provided on power head.

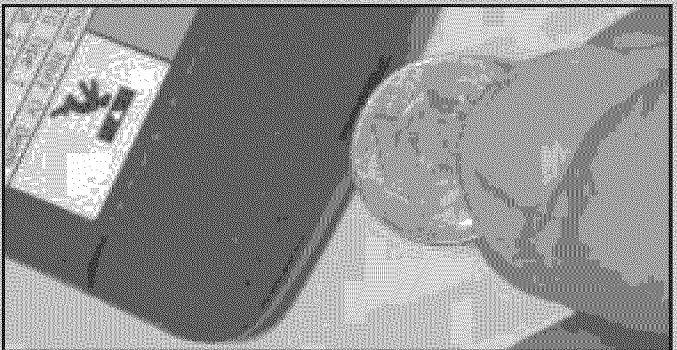

FIG. 9-1 Open battery cover.

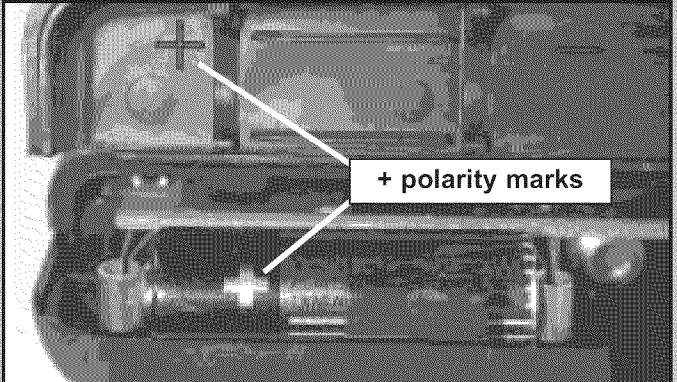

FIG. 9-2 Match battery polarity.

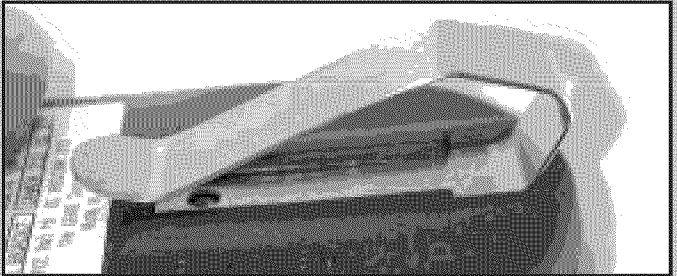

FIG. 9-3 Attach visor clip.

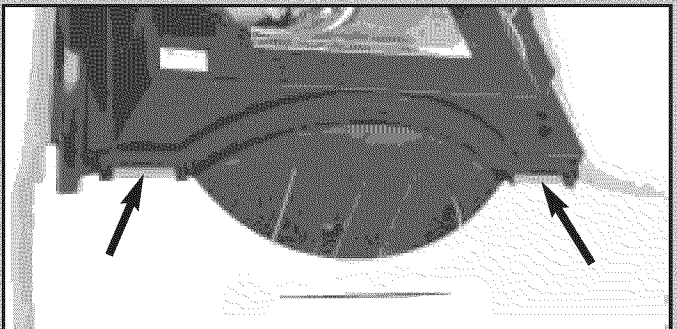

FIG. 10-1 Slide hinges into motor cover.

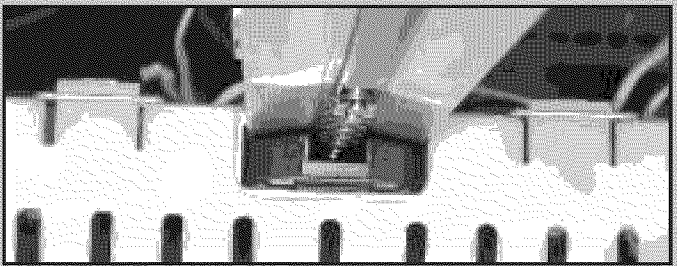

FIG. 10-2 Fasten lens.

# IMPORTANT SAFETY INSTRUCTIONS

## ⚠ WARNING!

### To reduce the risk of severe injury or death:

22

1. READ AND FOLLOW ALL INSTRUCTIONS.
2. Never let children operate or play with the door controls. Keep the remote control away from children.
3. Always keep the moving door in sight and away from people and objects until the door is completely closed. **NO ONE SHOULD CROSS THE PATH OF THE MOVING DOOR.**
4. **NEVER GO UNDER A STOPPED, PARTIALLY OPEN DOOR.**
5. Test operator monthly. The door **MUST** reverse on contact with a 1 1/2" high object (or a 2" x 4" board laid flat) at the center of the doorway on the floor. After adjusting either the force or the limit of travel, retest the door Opener. Failure to adjust the Opener properly may cause severe injury or death.
6. When possible, use the emergency release only when the door is closed. Use caution when using this release with the door open. Weak or broken springs are capable of increasing the rate of door closure and increasing the risk of severe injury or death.
7. **KEEP DOORS PROPERLY BALANCED.** See Owner's Manual. An improperly balanced door increases the risk of severe injury or death. Have a qualified service person make repairs to cables, spring assemblies, and other hardware.
8. **SAVE THESE INSTRUCTIONS.**

## 10 MAINTENANCE

### ROUTINE MONTHLY MAINTENANCE

1. **Door springs and hardware.**
  - **Do not operate** garage door automatically or manually if springs are broken.
    - **CONTACT A PROFESSIONAL FOR SERVICE.**
2. **Door balance.**
  - Close the door.
  - Pull emergency release knob down to release door from carriage assembly.
  - Raise door manually approximately 3 feet.
    - Door should stay in that position or close **very** slowly.
    - If door moves quickly, **HAVE DOOR SERVICED BY A PROFESSIONAL.**
  - Close the door.
  - Pull emergency release knob toward power head to place release lever in engaged position.
    - Operate door using remote.
    - Door will re-attach itself to carriage assembly.
3. **Contact reverse.**
  - Place a 2" x 4" board laid flat on floor.
    - In center of garage door opening.
  - Close door by using wall button or remote control.
    - Door fails to reverse on contact with board see **Section 7 "CONTACT REVERSE."**
    - Operator still fails **CONTACT A SERVICE PROFESSIONAL.**

#### 4. Safe-T-Beam® System.

- Use Self-Diagnostic STB system Troubleshooting information to maintain safe operation (Below).

### TROUBLESHOOTING GUIDE

Use This Guide To Correct Problems With Door Operator.  
If These Solutions Do Not Work,  
Call Customer Service at 1.800.35.GENIE

#### SELF-DIAGNOSTIC STB SYSTEM TROUBLESHOOTING

SOURCE RED LED	SENSOR GREEN LED	INDICATED CONDITION	REQUIRED ACTION
● ON	● ON	NORMAL OPERATION	NONE REQUIRED
○ OFF	○ OFF	1. POWER HEAD NOT POWERED 2. WIRING FROM POWER HEAD BAD	1. CHECK BREAKERS, FUSES, PLUGS 2. CHECK WIRING FOR OBVIOUS SHORTS
○ OFF	● ON	1. WIRING TO SOURCE MISSING OR BAD 2. POWER HAS BEEN INTERRUPTED	1. CHECK WIRING 2. REMOVE POWER AND REAPPLY
●●○ 2 BLINKS, PAUSE (REPEAT)	● ON	1. BEAM NOT ALIGNED 2. BEAM OBSTRUCTED 3. SENSOR DEFECTIVE	1. CHECK ALIGNMENT 2. CHECK FOR OBSTRUCTION 3. CALL CUST. SERV.
●●○ 2 BLINKS, PAUSE (REPEAT)	○ OFF	1. WIRE TO SENSOR MISSING OR BAD 2. SENSOR DEFECTIVE	1. CHECK WIRING 2. CALL CUST. SERV.
●●●○ 3 BLINKS, PAUSE (REPEAT)	● ON	1. SENSOR RECEIVING INTERFERENCE	1. ATTEMPT TO DETERMINE SOURCE OF INTERFERENCE 2. CALL CUST. SERV.
●●●○ 4 BLINKS, PAUSE (REPEAT)	● ON	1. SOURCE NOT SENDING PULSES 2. SOURCE DEFECTIVE	1. CALL CUST. SERV. 2. CALL CUST. SERV.

**NOTE:** IF OPERATING PROBLEM EXISTS, THE DOOR CAN BE CLOSED IF YOU:  
• DISCONNECT THE STB SYSTEM FROM THE OPERATOR  
• HOLD WALL CONTROL BUTTON DOWN UNTIL DOOR IS CLOSED  
(REMOTE CONTROL & WIRELESS KEYPAD WILL NOT WORK WITHOUT STB)

For Answers: CALL CUSTOMER SERVICE at 1.800.35.GENIE

**CAUTION**

Use wall control supplied with operator. Any other wall control can cause the operator to operate unexpectedly and light not to work.

**Operator does not run from wall control.**

- Check lock switch on wall console.
- Check power source.
  - Plug a lamp into outlet used for power head. If lamp works, power source is OK.
  - If not, check fuse or circuit breaker.
- Power is OK.
  - Check connections at power head terminals.
  - Check connections at wall control.
- Check wires to ensure they are not cut. Staples can cut insulation and short wires. If wire is cut, replace it.

**Door operator starts for no reason.**

- Was a remote control lost or stolen? Erase all remote control codes from receiver memory and reprogram (See section 7).
- Button stuck on wall control.
- Check CLOSE limit switch setting (See section 6).
- Wires shorted.

**Door starts down, then stops before it's closed.**

- Check CONTACT REVERSE (See section 6).

**Door starts down, then stops and goes back up.**

- Check "STB" system for beam obstruction or misalignment of lenses (See section 3).
- Check "STB" diagnostic code.
- Check "CLOSE FORCE" adjustment (See section 6).

**Door will only run closed.**

- Check OPEN limit switch for short and proper wiring.
- Check "OPEN FORCE" adjustment (See section 6).
- Check door condition and door spring.

**Door will only run open**

- Check "STB" system (See self-diagnostic "STB" Troubleshooting Chart).
- Check CLOSE limit switch for short and proper wiring.
- Check "CLOSE FORCE" adjustment (See section 6).

**Lights will not go out**

- Disconnect and reconnect wires on wall control (See section 4).
- Check wiring.
- Incompatible wall control.

**Door starts up, but stops before it's completely open.**

- Be sure door, operator, and springs are in good repair, properly lubricated and balanced (See maintenance section).
- Check "OPEN" limit switch setting (See section 6).
- Check "OPEN FORCE" adjustment (See section 6).

**Operator runs, but door does not move.**

- Make sure carriage is engaged to carriage slide.
  - Place carriage lever in lock position.
- Check force adjustment (See section 6). Door operator will **NOT** run more than 30 seconds each way if door does not move.

**Remote control has less than 25 feet operating range.**

- Relocate remote control inside car.
- Point remote control at garage door.
- Replace battery (See section 8).
- Reposition door operator antenna.
- **DO NOT** attempt to retune remote controls.

**Operator works from wall control, but not from remote control.**

- Program remote control code into receiver memory. (See section 7).
- Replace remote control battery with good one. (See section 8).

**Noisy operation.**

- Be sure all fasteners are tight.
- Be sure door and operator is in good repair, properly lubricated and balanced (See monthly maintenance section).

**Safe-T-Beam® system malfunction**

- If an operational problem exists, and operator will not run closed. The operator can be forced to close as follows (See section 5).
- Disconnect the "STB" system from the operator.
  - Hold the wall control button down until door is completely closed.

Use self-diagnostic "STB" system Troubleshooting information to maintain safe operation.

If you have any questions, please do not hesitate to contact customer service at:

**1.800.354.3643**

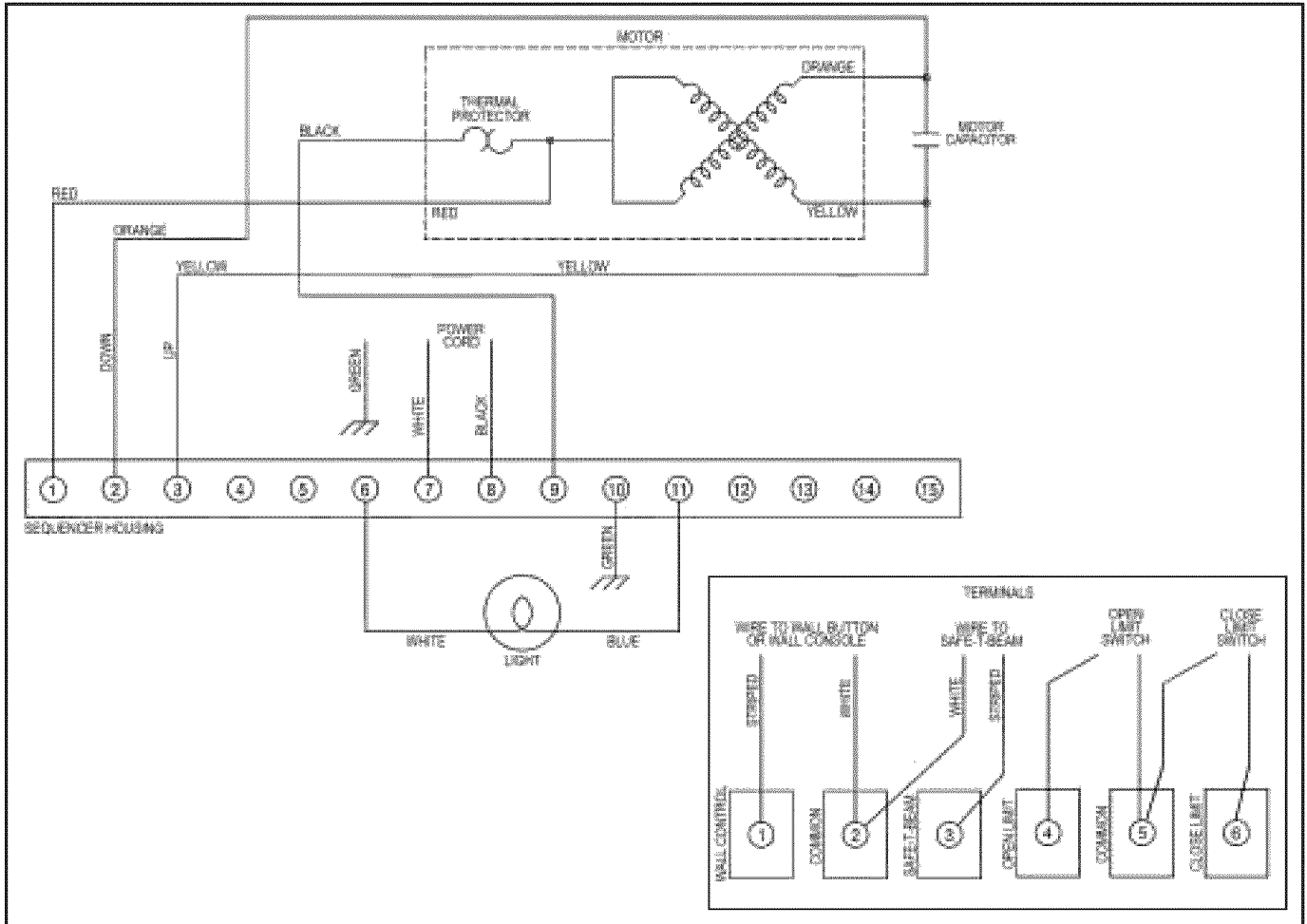

### TRANSMITTER COMPLIANCE STATEMENT

Transmitters comply with all United States and Canadian legal requirements as of the date of manufacture. No warranty is made that they comply with all legal requirements of any other jurisdiction. If transmitters are to be used in another country, the importer must determine compliance with any local laws and regulations which may differ from United States and Canadian requirements prior to use.

Los transmisores cumplen con todas las reglamentaciones legales de los Estados Unidos y del Canadá, en la fecha de fabricación. Ninguna garantía se da que cumplan con todas las reglamentaciones legales de ninguna otra jurisdicción. Si los transmisores se van a utilizar en otro país, el importador debe determinar si cumplen con las reglamentaciones y leyes locales que puedan ser diferentes a las reglamentaciones de los Estados Unidos y del Canadá, antes de usar los mismos.

Les émetteurs sont conformes à la réglementation américaine et canadienne à compter de leur date de fabrication. Aucune garantie n'est stipulée indiquant qu'ils sont conformes à toutes les prescriptions juridiques d'autres autorités. Si les émetteurs sont utilisés dans d'autres pays, il incombe à l'importateur d'en déterminer leur conformité aux lois et règles locales pouvant différer de celles des États-Unis et du Canada avant toute utilisation desdits émetteurs.

Sendegeräte entsprechen allen gesetzlichen Bestimmungen in den USA und Kanada zum Zeitpunkt der Herstellung. Wir übernehmen keine Gewährleistung für die Einhaltung aller gesetzlichen Bestimmungen in anderen Ländern. Sollen Sendegeräte in anderen Ländern eingesetzt werden, so muss der Importeur vor dem Gebrauch sicherstellen, dass die Sendegeräte auch solchen lokalen Bestimmungen entsprechen, welche von den Bestimmungen der USA und Kanadas abweichen.

截止于制造日期,传动装置符合美国和加拿大的所有法律要求。不提供传动装置符合任何其他司法地区所有法律要求之担保。如果传动装置需在任何其他国家使用,进口商必须在使用之前确定装置符合与美国和加拿大要求不同之所有地方法规条例。

トランスミッターは、製造日付けのアメリカ合衆国及びカナダの法的条件に準拠します。しかしながら、トランスミッターがアメリカ合衆国及びカナダ以外の国の法的条件に準拠するかどうかは一切保証できません。トランスミッターがアメリカ合衆国及びカナダ以外の国で使用される場合、同製品の使用に先立つ法規制がこれらの国々と異なることがあるため、輸入者は同製品が輸入国の法規制に準拠することを確認しなければなりません。

트랜스미터들은 미국과 캐나다 전역에서 제조 날짜를 명기해야 하는 요구사항에 따라야 합니다. 기타 다른 관할권의 모든 법적인 요구 사항에 따라야 하는 책임은 없습니다. 만일 트랜스미터들이 기타 다른 지역에서 사용될 경우 수입업자는 사용하기에 앞서 미국과 캐나다와의 요구사항과는 다를지도 모르는 그 지역의 법과 조례에 따라야 할지의 여부를 결정해야 합니다.





**Garage Door Operator Accessories**  
**Accesorios para abridores de garajes**  
**Accessoires pour ouvre-porte de garage**

Prices on reverse  
 Precio en dorso  
 Prix sur opposé

**AVAILABLE AT YOUR LOCAL GENIE® DISTRIBUTOR**



**(GIT-1) 1-Button Remote Control with Intellicode®** - Allows remote operation of one garage door.  
**Controlador remoto de uno botón con Intellicode®** - Proporcionar operación remoto de uno puerta del garaje.  
**Télécommande de un bouton avec Intellicode®** - Permettre opération élogin de un porte de garage.

**(GIT-2) 2-Button Remote Control with Intellicode®** - Allows remote operation two garage doors.  
**Controlador remoto de 2 botóns con Intellicode®** - Proporcionar operación remoto de dos las puerta del garaje.  
**Télécommande à 2 boutons avec Intellicode®** - Permettre opération élogin deux portes de garage.

**(GIT-3) 3-Button Remote Control with Intellicode®** - Allows remote operation of three garage doors.  
**Controlador remoto de 3 botóns con Intellicode®** - Proporcionar operación remoto de tres las puerta del garaje.  
**Télécommande à 3 boutons avec Intellicode®** - Permettre opération élogin trios portes de garage.

**(GMI-3) 3-Button Mini Remote Control with Intellicode®** - Fits easily into pocket or purse.  
**Minicontrolador remoto de 3 botóns con Intellicode®** - Cave fácilmente en el bolsillo o cartera.  
**Mini télécommande à 3 boutons avec Intellicode®** - se glisse dans la poche de veston ou le sac à main.

**(GPWC-2WLB) Function Wall Console** - Operates garage door. Independent light control. Security vacation lock.  
**Consola de pared de 3 funciones** - Acciona la puerta del garaje. Control de luz independiente. Cerradura de seguridad para vacaciones.  
**Console murale à trois fonctions** - Actionne la porte de garage. Commande d'éclairage indépendante. Interrupteur de verrouillage de sécurité.

**(GWKP) Wireless Keypad Entry System** - Operates Intellicode® garage door operators without remote control or key.  
**Sistema de entrada por teclado numérico inalámbrico** - Acciona los abridores de puertas de garaje Intellicode® sin control remoto o llave.  
**Système d'ouvre-porte de garage à clavier sans fil** - Actionne les ouvre-porte de garage avec Intellicode® sans télécommande ni clé.

**(GWB) Universal Wall Button** - Provides convenient inside operation of door.  
**Botón de pared universal** - Proporciona operación conveniente de la puerta desde el interior.  
**Bouton mural universel** - Actionne l'ouvre-porte de l'intérieur du garage.

**(GPS-5BL) Perfect Stop®** - Ensures perfect parking.  
**Stop® Perfecto** - Asegura el estacionamiento perfecto.  
**Butoir Perfect Stop®** - Permet de stationner à la perfection dans le garage.

**(LCGX-8) Chain Glide™ Extension Kit** - An 18 inch extension to increase the travel of a Chain Glide™ operator to accommodate an 8 foot door.  
**Juego de extensión deslizante** - Una extensión de 18 pulgadas para aumentar la carrera de un abridor deslizable de cadena, para acomodar una puerta de 8 pies (2,43 m).  
**Nécessaire de rallonge du Chain Glide™** - Rallonge de 30 dm (18 po) prolongeant la course de l'ouvre-porte Chain Glide pour une porte de 2,4 m (8 pi) de hauteur.

**(GIRU-1T) Universal Conversion Kit** - Converts any garage door operator to a secure radio signal system. Kit includes a remote control, receiver and transformer.  
**Juego de conversión universal** - Convierte cualquier abridor de puerta de garaje a un sistema de señal de radio seguro. El juego incluye un control remoto de abridor, receptor y transformador.  
**Nécessaire de conversion universel** - Transforme tout ouvre-porte de garage en système de sécurité à signal radio. Comprend une télécommande, un récepteur et

**60 WATT Light Bulb** - Ensures proper equipment compatability.  
**Bombilla de 60 Vatios** - Asegura componente correcto de sistema.  
**Éclairage de 60 WATT** - Garantir composant exact par système.

**(GER-2) Emergency Release Kit** - Provides access to garage from outside in the event of an electrical power failure.  
**Juego de pica-porte de pestillo** - Permitir entrada desde por fuera de garaje porque corte de eléctrico.  
**Nécessaires de Déclenchement de secours** - Le nécessaire de déclenchement de secours est conçu pour vous permettre d'accéder à votre garage depuis l'extérieur en cas de panne de courant et lorsqu'il.

**STB Bracket Extensions** - Provides additional bracket length where it may be needed for clearance.  
**Extensión de Cartelas de STB** - Adicional extensión de las cartelas de sistema de STB.  
**Extension de Support du STB** - Pourvoir étendue de plus de support du système STB.

No C.O.D. shipments. Please include check or money order, do not send cash.

Allow 3-4 weeks for delivery. We accept Visa or Mastercard phone orders.

1.800.354.3643. Please have part number and credit card ready.

Please add local sales tax if you reside in one of the states listed.

California	Indiana	New York
Connecticut	Maryland	Ohio
Florida	Massachusetts	Tennessee
Georgia	Michigan	Virginia
Illinois	New Jersey	Wisconsin

No se aceptan pedidos de pago contra entrega (COD).  
 Sírvase incluir su cheque o giro postal; no envíe dinero en efectivo.

Concedáanos 3 a 4 semanas para la entrega.  
 Aceptamos pedidos telefónicos de Visa o Mastercard.

1.800.354.3643. Sírvase tener listos los números del modelo y de la tarjeta de crédito.

Sírvase agregar el impuesto de ventas local si usted reside en uno de los siguientes estados:

California	Indiana	New York
Connecticut	Maryland	Ohio
Florida	Massachusetts	Tennessee
Georgia	Michigan	Virginia
Illinois	New Jersey	Wisconsin

Pas d'expédition contre remboursement. Veuillez inclure un chèque ou un mandat bancaire. N'envoyez pas d'argent comptant.

Accordez de 3 à 4 semaines pour la livraison. Nous acceptons les commandes par téléphone avec paiement par carte de crédit Visa ou Mastercard.

1.800.354.3643. Ayez sous la main le numéro de la pièce et celui de la carte de crédit.

Veuillez indiquer les taxes de vente locales si vous résidez dans l'un des états répertoriés ci-dessous.

California	Indiana	New York
Connecticut	Maryland	Ohio
Florida	Massachusetts	Tennessee
Georgia	Michigan	Virginia
Illinois	New Jersey	Wisconsin

TOTAL ORDER	\$
SHIPPING & HANDLING	\$ 5.00
STATE SALES TAX	\$
GRAND TOTAL	\$

TOTAL DEL PEDIDO	\$
FLETE Y MANEJO	\$ 5.00
IMPUESTO DE VENTAS ESTATAL	\$
GRAN TOTAL	\$











COMMANDE TOTALE	\$
MANUTENTION ET EXPÉDITION	\$ 5.00
TAXE DE VENTE	\$
TOTAL GLOBAL	\$

TEAR ALONG DOTTED LINE / ARRANCAR EN LA LÍNEA DE PUNTOS / ARRACHER LA LIGNE EN POINTILLE

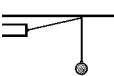

**Garage Door Operator Accessories Order Form**  
**Formulario de pedido de accesorios para abridores de puertas de garaje**  
**Formulaire de commande des accessoires pour ouvre-porte de garage**

**B**

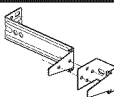
MODEL MODELO MODÈLE	DESCRIPTION DESCRIPCIÓN DESCRIPTION	PRODUCT CODE CÓDIGO CODE DU PRODUIT	PRICE (US\$)* PRECIO* PRIX (\$ US)*	QTY. CANTIDAD QTÉ	TOTAL TOTAL TOTAL
GIT-1	Deluxe Remote Control with Intellicode® Controlador remoto de lujo con Intellicode® Télécommande de luxe avec Intellicode®	 33069R	\$34.95		
GIT-2	2-Button Remote Control with Intellicode® Controlador remoto de 2 funciones con Intellicode® Télécommande à 2 fonctions avec Intellicode®	 33069S	\$44.95		
GIT-3	3-Button Remote Control with Intellicode® Controlador remoto de 3 funciones con Intellicode® Télécommande à 3 fonctions avec Intellicode®	 33069T	\$49.95		
GMI-3	3-Button Mini Remote Control with Intellicode® Minicontrolador remoto de 3 funciones con Intellicode® Mini télécommande à 3 fonctions avec Intellicode®	 34909R	\$39.95		
GPWC-2WLB	Lighted Wall Console Consola de pared encender Console murale avec éclairage	 34292R	\$34.95		
GWKP	Wireless Keypad Entry System Sistema de entrada por teclado numérico inalámbrico Système d'ouvre-porte de garage à clavier sans fil	 35282R	\$49.95		
GWB	Universal Wall Button (unlit) Botón de pared universal (unlit) Bouton mural universel (unlit)	 34960R	\$ 4.95		
GPS-5BL	Perfect Stop® Stop Perfecto® Butoir Perfect Stop®	 34964R	\$ 4.95		
LCGX-8	Chain Glide™ Extension Kit Juego de extensión de cadena deslizable Nécessaire de prolongement du coulisseau	 00001085	\$34.95		
GIRU-1T	Universal Conversion Kit Juego de conversión universal Nécessaire de conversion universel	 33154R	\$49.95		
LIGHT BULB	60 WATT Light Bulb Bombilla de 60 Vatios Éclairage de 60 WATT	 26210A.S	\$2.95		
GER-2	Emergency Release Kit Juego de pica-porte de pestillo Nécessaires de déclenchement de secours	 34963R	\$29.95		
	STB Bracket Extensions Extensión de Cartelas de STB Extension du Support de STB	 34439R.S	\$ 4.95		

\* Prices subject to change without notice  
 \* El precio está sujeto a cambios sin aviso  
 \* Les prix peuvent subir des modifications sans préavis

TEAR ALONG DOTTED LINE / ARRANCAR EN LA LÍNEA DE PUNTOS / ARRACHER LA LIGNE EN POINTILLE

<b>SHIP ORDER TO:</b> <b>ENVIAR MERCANCIA</b> <b>CON:</b> <b>EXPÉDIER MARCHANDISE</b> <b>POUR:</b>	NAME / NOMBRE / NOM
	ADDRESS / DIRECCIÓN / ADRESSE
	CITY / CIUDAD / VILLE
	STATE / ESTADO / ÉTAT
	ZIP / C6DIGO POSTAL / CODE POSTAL

MAIL ORDER  
 FORM TO:  
**The Genie Company**  
 22790 Lake Park Blvd.  
 Alliance, Ohio 44601

# The Genie Company Professional Access Systems LIMITED WARRANTY

**What is covered:** Any defect in material and product workmanship from personal, normal household use in accordance with the Owner's Manual.

**For how long:**

- H2000C-1 Series - 3 years on Motor, and 1 year on all other parts.
- 350L- 1 Series - 3 years on Motor, and 1 year on all other parts.
- 350L- 1X Series - 5 years on Motor, and 2 year on all other parts.
- 350L - 2 Series - 5 years on Motor, and 2 years on all other parts.
- 350L-2WKC Series - Lifetime\* on Motor, 2 years on all other parts.
- 350L-2C Series - 5 years on Motor, 2 years on all other parts.
- 350L-2WK Series - 5 years on Motor, 2 years on all other parts.
- 500ML Series - 5 years on Motor, and 3 years on all other parts.
- 700ML Series - Lifetime\* on Motor, 3 years on all other parts.

\*Lifetime warranty - warranted for as long as you own your home.

**Who gets the warranty:** This warranty is limited to the consumer who originally purchased the product.

**Geographic scope:** This warranty applies only to Genie products purchased in the United States and Canada.

**What we will do:** If your Genie product is defective, we will repair it or, at our option, replace it at no charge to you. If we repair your Genie product, we may use new or reconditioned replacement parts. If we choose to replace your Genie product, we may replace it with a new or reconditioned one of the same or similar design.

**Limitations:**

IMPLIED WARRANTIES, INCLUDING THOSE OF FITNESS FOR A PARTICULAR PURPOSE AND MERCHANTABILITY (AN UNWRITTEN WARRANTY THAT THE PRODUCT IS FIT FOR ORDINARY USE), ARE LIMITED TO ONE YEAR FROM THE DATE OF PURCHASE. GENIE WILL NOT PAY FOR: LOSS OF TIME; INCONVENIENCE; LOSS OF USE OF YOUR GENIE PRODUCT OR PROPERTY DAMAGE CAUSED BY YOUR GENIE PRODUCT OR ITS FAILURE TO WORK; ANY SPECIAL, INCIDENTAL OR CONSEQUENTIAL DAMAGES; OR ANY DAMAGES RESULTING FROM MISUSE OR MODIFICATION OF YOUR GENIE PRODUCT.

Some states and provinces do not allow limitations on how long an implied warranty lasts or the exclusion of incidental or consequential damages, so the above exclusions may not apply to you.

**How to get warranty service:** To obtain warranty service for your Genie product, you must provide proof of the date and place of purchase of the product.

**1. Do-It-Yourself-Service.** Call the Genie Consumer Connection toll free at 1.800.354.3643 to speak in person to a trained Genie representative for

required parts for do-it-yourself repairs. Trained service representatives are available Monday-Friday, 8:00 a.m. - 11:00 p.m., Eastern Time, and on Saturday, 11:00 p.m. to 8:00 p.m., Eastern Time (subject to holidays) You may also get the information you need at [www.geniecompany.com](http://www.geniecompany.com).

**2. Service From Authorized Dealers.**

You also may obtain warranty service from Genie authorized dealers listed in the enclosed directory. Please note that this listing is subject to change without notice; we recommend that you verify the dealer's status by calling the Genie Consumer Connection at 1.800.654.3643 or by visiting [www.geniecompany.com](http://www.geniecompany.com) before reaching any agreement on service. If warranty service is provided by an authorized dealer, Genie will provide all required parts under warranty at no charge to you, but the dealers are independent business people and may render a bench or service call charge for their services. Genie will not reimburse you or otherwise be responsible for those charges.

We suggest that you retain your original packing material in the event you need to ship your Genie product. Be sure to include your name, address, telephone number, proof of date and place of purchase and a description of the operating problem. After repairing or, at our option, replacing, your Genie product, we will ship it to your home at no cost to you for parts and labor, but you will have to pay a minimum of \$8.00 for shipping and handling charges.

Your choice of either one of the above-described service options is your exclusive remedy under this warranty.

**What this warranty does not cover:** This warranty does not cover batteries (which are considered replaceable parts), installation, commercial use, defects resulting from accidents, damage while in transit to our service location or damage resulting from alterations, misuse or abuse, lack of proper maintenance, unauthorized repair or modification of the product, affixing of any attachment not provided with the product, programming of the Remote Control Devices, Safe-T-Beam® adjustment/cleaning, staples through wiring, pinched or broken wires, Carriage disengaged, Force Control adjustments, door out of balance, broken springs or cables, power outages, use of extension cords, missing or damaged parts on discounted, clearance, final sale or taped cartons, phantom operations (labor is not covered if Opener is functioning properly while technician is in garage), fire, flood, or acts of God, or other failure to follow the Owner's Manual.

**This warranty is the only one we will give on your Genie product, and it sets forth all our responsibilities regarding your Genie product. There are no other express warranties.**

**State and province rights:** This warranty gives you specific legal rights, and you may also have other rights which vary from state to state and province to province.

**FOR ANSWERS: CALL 1.800.354.3643**

Manufactured under one or more of the following U.S. patents:  
3,898,582 4,041,259 4,048,630 4,064,487 4,103,238 5,222,403  
Other Patents applied for.

CORRESPONDENCE WITH FACTORY MUST INCLUDE DATE / MFG. NO.  
(LOCATED UNDER LENS OF POWER HEAD)

**FILL THIS IN AT TIME OF INSTALLATION FOR YOUR OWN RECORDS, SO THAT IT WILL  
BE AVAILABLE IF YOU EVER NEED TO CALL US.**

MO      D      YR                      WK      YR      PI

Date Purchased \_\_\_\_ / \_\_\_\_ / \_\_\_\_      Serial Number \_\_\_\_ / \_\_\_\_ / \_\_\_\_

Operator Model \_\_\_\_\_

Remote Control Model \_\_\_\_\_

Dealer Name \_\_\_\_\_

Dealer Address \_\_\_\_\_

City \_\_\_\_\_

State \_\_\_\_\_

Zip \_\_\_\_\_

**Visit Our Website at: [www.geniecompany.com](http://www.geniecompany.com)**

SAVE THESE INSTRUCTIONS

