

# **CA-27**

# **Operation Manual**

**Part Number:** 7990 0121 0001 R00  
(May 2004)



**TRADEMARKS**

All brand and product names are trademarks or registered trademarks of their respective companies.

**NOTE**

Information in this manual is subject to change without notice.

# ***Regulatory Information***

This appendix provides regulatory statements and safety notices on your computer.

**NOTE:** Marking labels located on the exterior of your computer indicate the regulations that your model complies with. Please check the marking labels and refer to the corresponding statements in this appendix. Some notices apply to specific models only.

# On the Use of the System

## Class B Regulations

### USA

Federal Communications Commission Radio Frequency Interference Statement

#### **NOTE:**

This equipment has been tested and found to comply with the limits for a Class B digital device pursuant to Part 15 of the FCC Rules. These limits are designed to provide reasonable protection against harmful interference in a residential installation. This equipment generates, uses, and can radiate radio frequency energy and, if not installed and used in accordance with the instructions, may cause harmful interference to radio communications. However, there is no guarantee that interference will not occur in a particular installation. If this equipment does cause harmful interference to radio or television reception, which can be determined by turning the equipment off and on, the user is encouraged to try to correct the interference by one or more of the following measures:

Reorient or relocate the receiving antenna.

Increase the separation between the equipment and receiver.

Connect the equipment into an outlet on a circuit different from that to which the receiver is connected.

Consult the dealer or an experienced radio/TV technician for help.

Any changes or modifications not expressly approved by the manufacturer could void the user's authority to operate the equipment.

#### **Please note:**

The use of a non-shielded interface cable with this equipment is prohibited.

Canada

## Canadian Department of Communications Radio Interference Regulations Class B Compliance Notice

This Class B digital apparatus meets all requirements of the Canada Interference-Causing equipment regulations.

Cet appareil numérique de Classe B respecte toutes les exigences du Règlement Canadien sur le matériel brouilleur.

This digital apparatus does not exceed the Class B limits for radio noise emissions from digital apparatus set out in the Radio Interference Regulations of the Canadian Department of Communications.

Le présent appareil numérique n'émet pas de bruits radioélectriques dépassant les limites applicables aux appareils numériques de la classe B prescrites dans le Règlement sur le brouillage radioélectrique édicté par le ministère des Communications du Canada.

## Safety Notices

### About the Battery

#### Caution Texts Concerning Lithium Batteries

##### **DANISH**

ADVARSEL! Lithiumbatteri – Eksplosionsfare ved fejlagtig håndtering. Udskiftning må kun ske med batteri af samme fabrikat og type. Levér det brugte batteri tilbage til leverandøren.

##### **NORWEGIAN**

ADVARSEL: Eksplosjonsfare ved feilaktig skifte av batteri. Benytt samme batteritype eller en tilsvarende type anbefalt av apparatfabrikanten. Brukte batterier kasseres i henhold til fabrikantens instruksjoner.

##### **SWEDISH**

WARNING: Explosionsfara vid felaktigt batteribyte. Använd samma batterityp eller en ekvivalent typ som rekommenderas av apparattillverkaren. Kassera använt batteri enligt fabrikantens instruktion.

**FINNISH**

**VAROITUS:** Paristo voi räjähtää, jos se on virheellisesti asennettu. Vaihda paristo ainoastaan valmistajan suositteluun tyypin. Hävitä käytetty paristo valmistajan ohjeiden mukaisesti.

**ENGLISH**

**CAUTION:** Danger of explosion if battery is incorrectly replaced. Replace only with the same or equivalent type recommended by the equipment manufacturer. Discard used batteries according to manufacturer's instructions.

**DEUTSCH**

**VORSICHT:** Explosionsgefahr bei unsachgemäßem Austausch der Batterie. Ersatz nur durch denselben oder einen vom Hersteller empfohlenen gleichwertigen Typ. Entsorgung gebrauchter Batterien nach Angaben des Herstellers.

**FRENCH**

**ATTENTION:** Il y a danger d'explosion s'il y a remplacement incorrect de la batterie. Remplacer uniquement avec une batterie du même type ou d'un type équivalent recommandé par le constructeur. Mettre au rebut les batteries usagées conformément aux instructions du fabricant.

## Attention (for USA Users)

The product that you have purchased contains a rechargeable battery. The battery is recyclable. At the end of its useful life, under various state and local laws, it may be illegal to dispose of this battery into the municipal waste stream. Check with your local solid waste officials for details in your area for recycling options or proper disposal.

## About the AC Adapter

Use only the AC adapter supplied with your computer. Use of another type of AC adapter will result in malfunction and/or danger.

Do not use the adapter in a high moisture environment. Never touch the adapter when your hands or feet are wet.

Allow adequate ventilation around the adapter when using it to operate the device or charge the battery. Do not cover the AC adapter with paper or other objects that will reduce cooling. Do not use the AC adapter while it is inside a carrying case.

Connect the adapter to a proper power source. The voltage requirements are found on the product case and/or packaging.

Do not use the adapter if the cord becomes damaged.

Do not attempt to service the unit. There are no serviceable parts inside. Replace the unit if it is damaged or exposed to excess moisture.



## About the Modem

### Caution

1. Never install telephone wiring during a lightning storm.
2. Never install telephone jacks in wet locations unless the jack is specifically designed for wet locations.
3. Never touch non-insulated telephone wires or terminals unless the telephone line has been disconnected at the network interface.
4. Use caution when installing or modifying telephone lines.
5. Avoid using the telephone function (other than a cordless type) during an electrical storm. There may be a remote risk of electric shock from lightning.
6. Do not use the telephone function to report a gas leak in the vicinity of the leak.
7. Do not use this product near water, for example near a bathtub, wash bowl, kitchen sink or laundry tub, in a wet basement or near a swimming pool.

### Caution (for USA Users)

To reduce the risk of fire, use only No.26 AWG or larger telecommunication line cord.

## On the Use of RF Device

**| NOTE:** The information in this section applies to models with the wireless LAN module.

### USA and Canada Safety Requirements and Notices

**IMPORTANT NOTE:**

The antenna must not be co-located or operating in conjunction with any other any atnenna or transmitter.

### Radio Frequency Interference Requirements and SAR

The FCC with its action in ET Docket 93-62 has adopted a safety standard for human exposure to Radio Frequency (RF) electromagnetic energy emitted by FCC certified equipment. The wireless LAN module meets the Human Exposure limits found in OET Bulletin 65, 2001, and ANSI/IEEE C95.1, 1992. Proper operation of this radio according to the instructions found in this manual will result in exposure substantially below the FCC' s recommended limits. The following safety precautions should be observed:

Do not touch or move antenna while the unit is transmitting or receiving.

Do not hold any component containing the radio such that the antenna is very close or touching any exposed parts of the body, especially the face or eyes, while transmitting.

Do not operate the radio or attempt to transmit data unless the antenna is connected; if not, the radio may be damaged.

### Use in specific environments:

The use of wireless devices in hazardous locations is limited by the constraints posed by the safety directors of such environments.

The use of wireless devices on airplanes is governed by the Federal Aviation Administration (FAA).

The use of wireless devices in hospitals is restricted to the limits set forth by each hospital.

### Antenna use:

High-gain, wall-mount, or mast-mount antennas are designed to be professionally installed and should be located at a minimum distance of 30 cm (12 inches) or more from the body of all persons. Please contact your professional installer, VAR, or antenna manufacturer for proper installation requirements.

### Explosive Device Proximity Warning

**WARNING:** Do not operate a portable transmitter (such as a wireless network device) near unshielded blasting caps or in an explosive environment unless the device has been modified to be qualified for such use.

### Antenna Warning

**WARNING:**

This equipment complies with FCC radiation exposure limits set forth for an uncontrolled environment.

The antenna must not be co-located or operating in conjunction with any other antenna or radio transmitter.

## Use on Aircraft Caution

**CAUTION:** Regulations of the FCC and FAA prohibit airborne operation of radio-frequency wireless devices because their signals could interfere with critical aircraft instruments.

## EMC Requirements

This device uses, generates and radiates radio frequency energy. The radio frequency energy produced by this device is well below the maximum exposure allowed by the Federal Communications Commission (FCC).

This device complies with the limits for a Class B digital device pursuant to Part 15 subpart C of the FCC Rules and Regulations. Operation is subject to the following two conditions:

- (1) This device may not cause harmful interference.
- (2) This device must accept any interference received, including interference that may cause undesired operation.

This Transmitter must not be co-located or operating in conjunction with any other antenna or transmitter.

Changes or modifications to this unit not expressly approved by the party responsible for compliance could void the user authority to operate the equipment.

The FCC limits are designed to provide reasonable protection against harmful interference when the equipment is installed and used in accordance with the instruction manual and operated in a commercial environment. However, there is no guarantee that interference will not occur in a particular commercial installation, or if operated in a residential area.

If harmful interference with radio or television reception occurs when the device is turned on, the user must correct the situation at the user's own expense. The user is encouraged to try one or more of the following corrective measures:

- Reorient or relocate the receiving antenna.
- Increase the separation between the equipment and receiver.

Connect the equipment into an outlet on a circuit different from that to which the receiver is connected.

Consult the dealer or an experienced radio/TV technician for help.

**CAUTION:** The Part 15 radio device operates on a non-interference basis with other devices operating at this frequency. Any changes or modification to said product not expressly approved by the manufacturer could void the user's authority to operate this device.

## Canada Radio Frequency Interference Requirements

To prevent radio interference to the licensed service, this device is intended to be operated indoors and away from windows to provide maximum shielding. Equipment (or its transmit antenna) that is installed outdoors is subject to licensing.

Pour empêcher que cet appareil cause du brouillage au service faisant l'objet d'une licence, il doit être utilisé à l'intérieur et devrait être placé loin des fenêtres afin de fournir un écran de blindage maximal. Si le matériel (ou son antenne d'émission) est installé à l'extérieur, il doit faire l'objet d'une licence.

## European Union CE Marking and Compliance Notices

### Statements of Compliance

#### **English**

This product follows the provisions of the European Directive 1999/5/EC.

#### **Danish**

Dette produkt er i overensstemmelse med det europæiske direktiv 1999/5/EC.

#### **Dutch**

Dit product is in navolging van de bepalingen van Europees Directief 1999/5/EC.

#### **Finnish**

Tämä tuote noudattaa EU-direktiivin 1999/5/EC määräyksiä .

#### **French**

Ce produit est conforme aux exigences de la Directive Européenne 1999/5/EC.

#### **German**

Dieses Produkt entspricht den Bestimmungen der Europäischen Richtlinie 1999/5/EC.

**Greek**

Το προϊόν είναι σε συμμόρφωση με την Οδηγία 1999/5/ΕΚ.

**Icelandic**

Þessi vara stendur í samræmi við Evrópska Efnahags Bandalagsins númer 1999/5/EC.

**Italian**

Questo prodotto è conforme alla Direttiva Europea 1999/5/EC.

**Norwegian**

Dette produktet er i henhold til bestemmelsene i det europeiske direktivet 1999/5/EC.

**Portuguese**

Este produto cumpre com as normas da Diretiva Europeia 1999/5/EC.

**Spanish**

Este producto cumple con las normas del Directivo Europeo 1999/5/EC.

**Swedish**

Denna produkt har tillverkats i enlighet med EG-direktiv 1999/5/EC.

## Local Restrictions of 802.11b Radio Usage

**CAUTION:** Due to the fact that the frequencies used by 802.11b wireless LAN devices may not yet be harmonized in all countries, 802.11b products are designed for use only in specific countries or regions, and is not allowed to be operated in countries or regions other than those of designated use. As a user of these products, you are responsible for ensuring that the products are used only in the countries or regions for which they were intended and for verifying that they are configured with the correct selection of frequency and channel for the country or region of use. Any deviation from permissible settings and restrictions in the country or region of use could be an infringement of local law and may be punished as such.

The European variant is intended for use throughout the European Economic Area. However, authorization for use is further restricted in particular countries or regions within countries, as follows:

## General

European standards dictate maximum radiated transmit power of 100 mW Effective Isotropic Radiated Power (EIRP) and the frequency range 2400 – 2483.5 MHz.

## Belgium and the Netherlands

In Belgium and the Netherlands, the product may not be used outdoors. See the instructions next under the heading “How to Turn Off the Wireless LAN.”

## France

### **Departments in Which the Wireless LAN Module Can Be Used (Indoors Only)**

The wireless LAN module can currently be used indoors only in the following 38 departments of mainland France. Please turn off your wireless LAN radio when operating the device in areas/places other than the 38 departments listed:

|    |                |    |                     |    |                       |
|----|----------------|----|---------------------|----|-----------------------|
| 01 | Ain Orientales | 36 | Indre               | 66 | Pyrénées              |
| 02 | Aisne          | 37 | Indre et Loire      | 67 | Bas Rhin              |
| 03 | Allier         | 41 | Loir et Cher        | 68 | Haut Rhin             |
| 05 | Hautes Alpes   | 42 | Loire               | 70 | Haute Saône           |
| 08 | Ardennes       | 45 | Loiret              | 71 | Saône et Loire        |
| 09 | Ariège         | 50 | Manche              | 75 | Paris                 |
| 11 | Aude           | 55 | Meuse               | 82 | Tarn et Garonne       |
| 12 | Aveyron        | 58 | Nièvre              | 84 | Vaucluse              |
| 16 | Charente       | 59 | Nord                | 88 | Vosges                |
| 24 | Dordogne       | 60 | Oise                | 89 | Yonne                 |
| 25 | Doubs          | 61 | Orne                | 90 | Territoire de Belfort |
| 26 | Drôme          | 63 | Puy du Dôme         | 94 | Val de Marne          |
| 32 | Gers           | 64 | Pyrénées Atlantique |    |                       |



**Departments in Which the Wireless LAN Module's Maximum EIRP Not Shown in the Previous Table**

| <b>Frequency Ranges (MHz)</b> | <b>Indoors</b> | <b>Outdoors</b>                                              |
|-------------------------------|----------------|--------------------------------------------------------------|
| 2400 – 2446.5                 | 10 mW          | Not permitted                                                |
| 2446.5 – 2483.5               | 100 mW         | 100 mW on private property with Ministry of Defense approval |

### Turning Off the Wireless LAN Radio

**NOTE:** Turning the wireless LAN radio off is not the same as disabling the wireless LAN card. It is not necessary to disable the card to meet the regulatory requirements.

While operating the computer in those French departments that do not allow use of the wireless LAN equipment, the user of the equipment must turn off the wireless LAN radio in order to comply with local regulations (see chapter 2 for more information).

# Table of Contents

|                                                 |            |
|-------------------------------------------------|------------|
| <b>Preface .....</b>                            | <b>XiX</b> |
| <b>Chapter 1 Getting Started .....</b>          | <b>1-1</b> |
| Getting the Computer Running .....              | 1-2        |
| Unpacking.....                                  | 1-2        |
| Before You Begin .....                          | 1-3        |
| Connecting to AC Power .....                    | 1-4        |
| Positioning the Tablet PC .....                 | 1-5        |
| Using the Wireless Keyboard (option) .....      | 1-6        |
| Turning On and Off the Computer .....           | 1-7        |
| Taking a Look at the Computer.....              | 1-9        |
| Right-side Components .....                     | 1-9        |
| Left-side Components.....                       | 1-11       |
| Rear Components.....                            | 1-12       |
| Front Components .....                          | 1-13       |
| Bottom-side Components .....                    | 1-15       |
| Where to Go from Here .....                     | 1-16       |
| <b>Chapter 2 Operating Your Tablet PC .....</b> | <b>2-1</b> |
| Starting and Stopping the Computer.....         | 2-2        |
| Starting the Computer .....                     | 2-2        |

|                                            |            |
|--------------------------------------------|------------|
| Stopping the Computer .....                | 2-2        |
| Using the Wireless Keyboard (option) ..... | 2-4        |
| Mouse-control Buttons .....                | 2-4        |
| Typewriter Keys.....                       | 2-5        |
| Cursor-control Keys.....                   | 2-5        |
| Numeric Keypad .....                       | 2-6        |
| Euro Symbol.....                           | 2-6        |
| Windows Keys .....                         | 2-7        |
| Function Keys .....                        | 2-7        |
| Using the Touchscreen.....                 | 2-8        |
| Configuring the Touchscreen.....           | 2-9        |
| Using the Floppy Disk Drive (option).....  | 2-10       |
| Connecting the Floppy Disk Drive .....     | 2-10       |
| Inserting and Ejecting Floppy Disks .....  | 2-12       |
| Using the Hard Disk Drive .....            | 2-14       |
| Using the Optical Drive (option).....      | 2-15       |
| Connecting the Optical Drive .....         | 2-16       |
| Inserting and Removing a Disc .....        | 2-16       |
| Using the Video Features .....             | 2-18       |
| Configuring the Display Modes .....        | 2-18       |
| Using the Audio Features .....             | 2-21       |
| Connecting Audio Devices .....             | 2-22       |
| Using the Communication Features .....     | 2-23       |
| Using the Modem.....                       | 2-23       |
| Using the Wireless LAN.....                | 2-24       |
| Using the Wireless Modem.....              | 2-25       |
| <b>Chapter 3 Managing Power.....</b>       | <b>3-1</b> |
| AC and Car Adapter.....                    | 3-2        |
| Battery Pack .....                         | 3-3        |
| Charging the Battery Pack .....            | 3-3        |
| Initializing the Battery Pack.....         | 3-4        |

|                                                         |            |
|---------------------------------------------------------|------------|
| Checking the Battery Level.....                         | 3-4        |
| Replacing the Main Battery Pack .....                   | 3-5        |
| Battery Low Signals and Actions .....                   | 3-6        |
| Power Management.....                                   | 3-8        |
| Hibernation .....                                       | 3-8        |
| Power-Saving Tips.....                                  | 3-10       |
| <b>Chapter 4 Expanding Your Computer .....</b>          | <b>4-1</b> |
| Connecting a Serial Device.....                         | 4-2        |
| Connecting a USB Device.....                            | 4-3        |
| Connecting an IR Device .....                           | 4-5        |
| Using PC Cards.....                                     | 4-7        |
| CardBus Support.....                                    | 4-7        |
| Inserting and Removing a PC Card.....                   | 4-7        |
| System Memory Upgrade.....                              | 4-9        |
| <b>Chapter 5 Setup Configuration Utility (SCU).....</b> | <b>5-1</b> |
| When and How to Use the SCU Program.....                | 5-2        |
| When to Use.....                                        | 5-2        |
| Starting SCU.....                                       | 5-2        |
| Moving Around and Making Selections .....               | 5-3        |
| Main Menu.....                                          | 5-4        |
| Advanced Menu .....                                     | 5-6        |
| Security Menu .....                                     | 5-11       |
| Boot Menu .....                                         | 5-13       |
| Exit Menu .....                                         | 5-14       |
| <b>Chapter 6 Installing Software Drivers.....</b>       | <b>6-1</b> |
| How to Use the CD.....                                  | 6-2        |
| Touchscreen Calibration.....                            | 6-8        |
| Intel SpeedStep Utility.....                            | 6-9        |
| Wireless LAN Utility Installation .....                 | 6-10       |

|                                                 |            |
|-------------------------------------------------|------------|
| <b>Chapter 7 Caring for the Tablet PC .....</b> | <b>7-1</b> |
| Protecting the Computer.....                    | 7-2        |
| Using the Password.....                         | 7-2        |
| Using an Anti-Virus Strategy.....               | 7-2        |
| Taking Care of the Tablet PC.....               | 7-3        |
| Location Guidelines.....                        | 7-3        |
| General Guidelines.....                         | 7-3        |
| Cleaning Guidelines.....                        | 7-4        |
| Battery Pack Guidelines.....                    | 7-4        |
| When Traveling.....                             | 7-5        |
| <br>                                            |            |
| <b>Chapter 8 Troubleshooting .....</b>          | <b>8-1</b> |
| Preliminary Checklist.....                      | 8-2        |
| Solving Common Problems.....                    | 8-3        |
| Battery Problems.....                           | 8-4        |
| Optical Drive Problems.....                     | 8-5        |
| Display Problems.....                           | 8-5        |
| Floppy Disk Drive Problems.....                 | 8-7        |
| Hardware Device Problems.....                   | 8-7        |
| Hard Disk Drive Problems.....                   | 8-8        |
| Infrared Problems.....                          | 8-8        |
| Keyboard and Mouse Problems.....                | 8-9        |
| LAN Problems.....                               | 8-9        |
| WLAN Problems.....                              | 8-10       |
| Modem Problems.....                             | 8-11       |
| PC Card Problems.....                           | 8-12       |
| Power Management Problems.....                  | 8-12       |
| Printer Problems.....                           | 8-13       |
| Software Problems.....                          | 8-14       |
| Sound Problems.....                             | 8-14       |
| Startup Problems.....                           | 8-15       |
| Other Problems.....                             | 8-16       |

|                                       |            |
|---------------------------------------|------------|
| Resetting the Computer.....           | 8-17       |
| <b>Appendix A Specifications.....</b> | <b>A-1</b> |

# Preface

This manual contains information that will help you operate the computer. It is divided into 8 chapters and 2 appendices.

- Chapter 1, **Getting Started**, takes you through the process of setting up the computer and identifying its external components.
- Chapter 2, **Operating Your Tablet PC**, tells you how to use the computer's components and features.
- Chapter 3, **Managing Power**, provides information on power.
- Chapter 4, **Expanding Your Computer**, provides information on installing and using peripheral devices.
- Chapter 5, **Setup Configuration Utility (SCU)**, describes the SCU program that configures the computer's BIOS settings.
- Chapter 6, **Installing Software Drivers**, describes how to install the drivers supplied with the computer.
- Chapter 7, **Caring for the Tablet PC**, gives you tips in care and maintenance.
- Chapter 8, **Troubleshooting**, gives solutions to common problems you may encounter when using the computer.
- Appendix A, **Specifications**, gives a brief specification of the computer.

- Appendix B, **Regulatory Information**, provides regulatory statements and safety notices on your computer.



## Notational Conventions

Throughout this manual, the following conventions are used to distinguish elements of text.

**| NOTE:** identifies additional information that requires special attention.

**| CAUTION:** identifies important information which, if not followed, may result in loss of data or damage to the computer.

Keyboard keys are shown in a bold typeset. For example:

Press **Enter** to complete.

When keys are joined by a plus sign (+), press the first key, and, while keeping the first key down, press the remaining keys, finally release all the keys. When necessary, keys are also shown in graphics.

A title, command, setup item, or button that you can see on the screen is shown in boldface. A value or an option that you can select for a setup item is shown in italic. For example:

Select **Power Management**, set it to *Enabled*, and then click the **OK** button.

# ***Getting Started***

Congratulations on purchasing this Tablet PC.

This hand-held computer, having no fan and being almost noiseless, is especially designed for the practical applications of warehouses, automobiles, vehicles, public security, repairing, assisting the handicapped, and other demanding situations where conventional notebook computers just cannot measure up.

This chapter first tells you step by step how to get the computer up and running. You will find instructions for these procedures:

- Unpacking
- Connecting to AC power
- Turning on the computer
- Turning off the computer

Then, you will find a section briefly introducing the external components of the computer. And the last section navigates you to the information you may need after the computer is ready for use.

# Getting the Computer Running

This section guides you through the procedures for getting the computer ready for operation.

## Unpacking

After unpacking the shipping carton, you should find these standard items:

- Tablet PC
- Accessories:
  - AC adapter (100~240 VAC, 50~60 Hz)
  - AC power cord (US, CE, UK, SA)
  - Private cable
  - Backup battery switch pin
  - Driver CD
  - X-Bay (optional):
    - Module-1*: USB 2.0 & RS232 I/O / RJ-45 / IEEE 1394
    - Module-2*: Internal PCMCIA
    - Module-3*: wireless modem (GSM/GPRS)
  - Expansion box (optional)
    - Port Replicator module*: includes COM1/4, PIO1, CRT, two USB 1.1 or four USB 2.0 ports (connects behind USB hub, floppy disk drive (FDD) bootable), PS/2 keyboard and mouse, MIC input, earphone out, CD drive and AC adapter input
    - CD drive module*: 24× TEAC CD-224E or better
    - USB FDD module*: 1.44 MB double-sided high density
  - Wireless keyboard (optional)
  - Car adapter/charger (12~32 VDC) – (optional)
  - Main battery (optional)
  - Battery charger for backup battery (optional)
  - Carrying bag (optional)
  - CCD camera module (optional)
  - This *Operation Manual*

Inspect all the items. If any item is damaged or missing, notify your dealer immediately.

Keep the shipping carton and packing materials in case you need to ship or store the computer in the future.

## Before You Begin

To prevent depletion of the backup battery's power during transit, a switch is provided at the bottom-side of the Tablet PC. Be sure to turn the switch to the "ON" position when using the Tablet PC for the first time by using the included backup battery switch pin to slide the switch.



*Backup Battery Switch*

**NOTE:** In case the Tablet PC will not be used for a long period of time and to prevent backup battery discharge, turn the switch to the "OFF" position.

## Connecting to AC Power

The computer operates either on the external AC power or internal battery power. It is suggested that you use AC power when you start up the computer for the first time.

**CAUTION:** Use only the AC adapter included with your computer. Using other AC adapters may damage the computer.

**NOTE:**

**Power Supply Cord:** (optional) Detachable, minimum 1.5 m long. Listed, rated minimum 125 V, 7 A, having a 2/18 AWG, type SVT flexible cord. One end terminates with a parallel blade, molded-on, attachments plug with a 7 A, 125 V (NEMA 1-15P) configuration; other end terminates with a molded-on appliance coupler.

**Alternate:** (optional) Detachable, maximum 4.5 m (14.76 ft) long. Listed, rated minimum 250 V, 6 A, having a 3/18 AWG, type SVT flexible cord. One end terminates with a Tandem blade, grounding, listed molded-on, attachments plug with a 6 A, 250 V (NEMA 6-15P) configuration; other end terminates with a molded-on appliance coupler.

1. Make sure the computer is turned off.
2. Plug the DC cord of the AC adapter to the power connector on the right-side of the computer (❶).
3. Plug the female end of the AC power cord to the AC adapter and the male end to an electrical outlet (❷).



4. When the AC adapter is connected, the indicator on the AC adapter lights up, indicating that power is being supplied from the electrical outlet to the AC adapter and onto your computer. Now, you are ready to turn on the computer.

**CAUTION:**

- When you disconnect the AC adapter, disconnect from the electrical outlet first and then from the computer. A reverse procedure may damage the AC adapter or the computer.
- When unplugging the connector, always hold the plug head. Never pull on the cord.

**NOTE:** When the AC adapter is connected, it also charges the battery pack. For information on using battery power, see Chapter 3.

## Positioning the Tablet PC

The computer can be placed upright using its stand found at the back. To place the computer in an upright position, pull open the stand located at the back as shown on the next figure.

**NOTE:** It is recommended that you operate the Tablet PC in an upright position as opposed to letting it lie flat on its back in order to provide adequate air ventilation.



The wireless keyboard operates on four “size-AA” (1.5-volt) batteries on the battery compartment located at the back. Be sure to observe the correct polarity when inserting the batteries.

**NOTE:** The condition of the batteries also affects the effectiveness of transmission. If a weakness in transmission is detected, try changing a set of new batteries.

## Using the Wireless Keyboard (option)

The wireless keyboard can either be placed flat on the table or inclined using its stand found at the back. To place the wireless keyboard in an inclined position, pull open the stand located at the back as shown on the next figure.



Place the wireless keyboard in front of the Tablet PC with no obstructions between them to allow unhampered communication between the computer and keyboard's IR port.

**NOTE:** It is recommended that the transmission distance must not exceed 3 meters and that vertical transmission angle is within  $\pm 15^\circ$  while horizontal transmission angle is within  $\pm 30^\circ$ .



## Turning On and Off the Computer

### Turning On

1. Make sure the computer is connected to AC power.
2. Press the power button .





3. Each time the computer is turned on, it performs a Power-On Self Test (POST), and the operating system such as Windows should start.

## Turning Off

To turn off the computer power, use the “Shut Down” command of your operating system.

**NOTE:** There are other ways you can stop the computer so that you will be back to where you left off when you next turn on the computer. (See “Stopping the Computer” in Chapter 2 for information.)

**CAUTION:** If you have to turn the computer on again immediately after turning it off, wait for at least five seconds. Turning the computer off and on rapidly can damage it.

# Taking a Look at the Computer

This section identifies the external components of the computer and briefly describes the function of each component.

## Right-Side Components

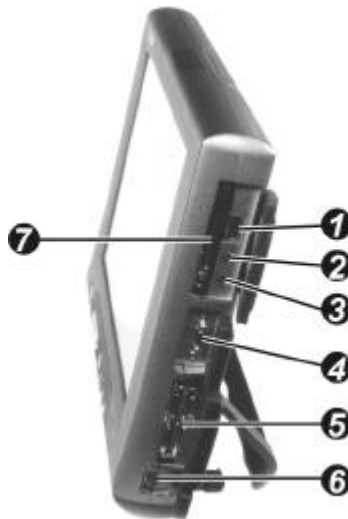

| Ref | Component                     | Description                                                                                     | See Also         |
|-----|-------------------------------|-------------------------------------------------------------------------------------------------|------------------|
| ①   | <b>USB Port</b>               | Connects a USB device, such as a USB floppy drive, printer, digital camera, joystick, and more. | P. 4-3           |
| ②   | <b>Microphone Connector</b>   | Connects an external microphone.                                                                | P. 2-22          |
| ③   | <b>Audio Output Connector</b> | Connects a set of headphones, external speakers with amplifier, or an audio recording device.   | P. 2-22          |
| ④   | <b>Private Port</b>           | Connects a private cable that contains a serial and USB ports.                                  | P. 4-2<br>P. 4-3 |

| Ref | Component              | Description                                                                          | See Also     |
|-----|------------------------|--------------------------------------------------------------------------------------|--------------|
| 5   | <b>Expansion Port</b>  | For connecting to: Port Replicator, CD/DVD-RW/Combo drive module, or USB FDD module. | P. 2-16, 4-3 |
| 6   | <b>Power Connector</b> | Connects the AC adapter.                                                             | P. 1-4       |
| 7   | <b>PC Card Slot</b>    | Accepts a PC Card for additional functions.                                          | P. 4-7       |

## Left-Side Components

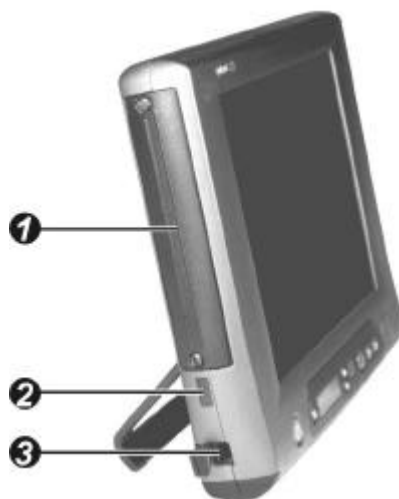

| Ref | Component              | Description                                                                                                                     | See Also    |
|-----|------------------------|---------------------------------------------------------------------------------------------------------------------------------|-------------|
| ①   | <b>X-Bay Interface</b> | Connects additional wireless LAN, wireless modem (CDPD), external monitor, or five ports (COM1/4, IEEE 1394, LAN, and USB 2.0). |             |
| ②   | <b>IR Port</b>         | Connects an IrDA-compliant device for wireless data transfer.                                                                   | P. 1-6, 4-5 |
| ③   | <b>RJ-11 Connector</b> | Connects the telephone line.                                                                                                    | P. 2-23     |







## Rear Components

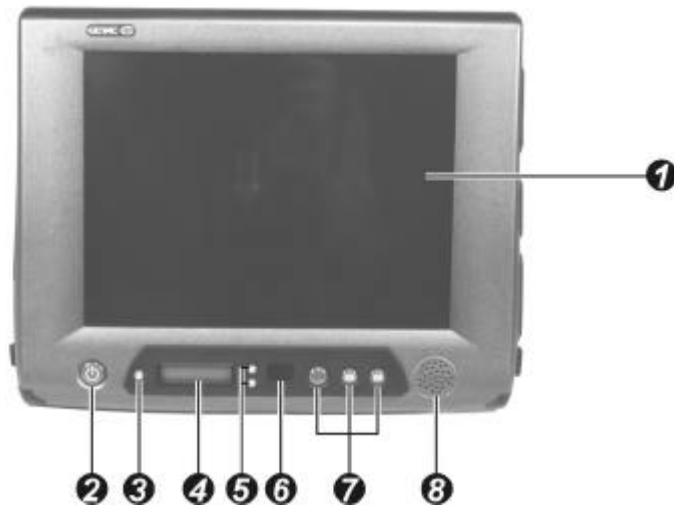

| Ref | Component         | Description                                                                                      | See Also |
|-----|-------------------|--------------------------------------------------------------------------------------------------|----------|
| ①   | Stand             | System's vertical angle of inclination after the stand is released $18 \pm 3^\circ$ .            | P. 1-5   |
| ②   | Main Battery Pack | Supplies power to your computer when external power is not connected.                            | P. 3-5   |
| ③   | Touchscreen Pen   | Provides a convenient way to use the touchscreen. Can be stretched for better grip and handling. | P. 2-8   |

## Front Components



| Ref | Component                                                                                                                                                  | Description                                                                                                                   | See Also |
|-----|------------------------------------------------------------------------------------------------------------------------------------------------------------|-------------------------------------------------------------------------------------------------------------------------------|----------|
| ①   | <b>LCD Panel and Touchscreen</b>                                                                                                                           | Displays the output of the computer. Also serves as your touchscreen.                                                         | P. 2-8   |
| ②   | <b>Power Button</b><br>                                                 | Turns the computer power ON and OFF. Also serves as the SUSPEND/RESUME switch.                                                | P. 1-7   |
| ③   | <b>Volume Control/<br/>Brightness Control/<br/>Battery Capacity</b><br> | Allows you to toggle between adjusting the sound volume of the computer or brightness of the LCD screen, or battery capacity. | P. 2-21  |
| ④   | <b>Device Indicators</b>                                                                                                                                   | Shows the current status of the computer's devices.                                                                           |          |
|     |                                                                         | Power ON indicator                                                                                                            | P. 1-7   |
|     |                                                                         | Num Lock Indicator                                                                                                            | P. 2-6   |
|     |                                                                         | Caps Lock Indicator                                                                                                           | P. 2-5   |
|     |                                                                         | Scroll Lock Indicator                                                                                                         | P. 2-5   |

| Ref      | Component                                                                            | Description                                                                                                                                              | See Also         |
|----------|--------------------------------------------------------------------------------------|----------------------------------------------------------------------------------------------------------------------------------------------------------|------------------|
|          |                                                                                      | Shows the speaker volume, or the LCD brightness level, or the main/backup battery capacity                                                               | P. 3-4           |
|          |                                                                                      | Suspend mode indicator (in reverse video)                                                                                                                | P. 3-8           |
|          |                                                                                      | Hard disk drive in-use indicator                                                                                                                         | P. 2-14          |
|          |                                                                                      | Backup battery status indicator                                                                                                                          | P. 3-4           |
|          |                                                                                      | Volume adjust indicator                                                                                                                                  | P. 2-21          |
|          |                                                                                      | LCD brightness adjust indicator                                                                                                                          | P. 2-18          |
| <b>5</b> | <b>Speaker</b><br><b>▲ Volume/LCD</b><br><b>▼ Brightness</b><br><b>Adjust Button</b> | The upper button provides you a quick way to increase while the lower button decreases the sound volume of the computer or brightness of the LCD screen. | P. 2-18,<br>2-21 |
| <b>6</b> | <b>IR Port</b>                                                                       | Connects with a wireless keyboard (option) for wireless data transfer.                                                                                   | P. 1-6,<br>4-5   |
| <b>7</b> | <b>Function Keys</b><br>1  2 ,<br>3                                                  | Each of the three buttons can be defined from F1 to F12 through the Setup utility (see chapter 5 “Advanced Menu”).                                       | P. 2-7,<br>5-17  |
| <b>8</b> | <b>Speaker</b>                                                                       | Sends out sound and voice from the computer.                                                                                                             | P. 2-21          |

## Bottom-Side Components

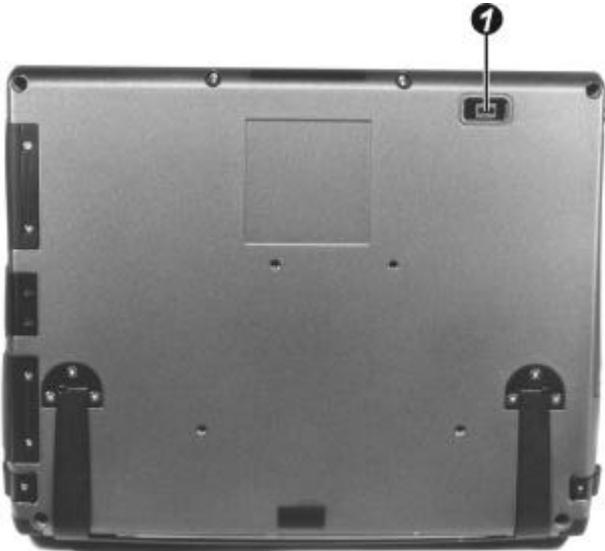

| Ref | Component    | Description                            | See Also |
|-----|--------------|----------------------------------------|----------|
| ①   | CCD USB Port | Connects a standard USB CCD PC camera. | P. 4-3   |



## Where to Go from Here

As your computer is ready for operation, you may want to do any of the following now:

| <b>For this purpose...</b>                                                | <b>Do this...</b>                             |
|---------------------------------------------------------------------------|-----------------------------------------------|
| To know more about the computer...                                        | Go on to the next chapter.                    |
| To install the operating system if your dealer has not already done so... | See the operating system manual.              |
| To know more about the operating system...                                | Read the operating system manual.             |
| To install the drivers if your dealer has not already done so...          | See Chapter 6.                                |
| To set a power-on password...                                             | See “Security Menu” in Chapter 5.             |
| To charge the battery pack for the first time...                          | See “Charging the Battery Pack” in Chapter 3. |

# *Operating Your Tablet PC*

This chapter provides information about the use of the computer.

If you are new to computers, reading this chapter will help you learn the operating basics. If you are already a computer user but are new to Tablet PCs, you may choose to read only the parts containing information unique to your computer.

Described in this chapter are the operating basics of these components:

- Wireless Keyboard
- Touchscreen
- Floppy disk drive
- Hard disk drive
- Optical drive

And these features:

- Starting and stopping the computer
- Function keys
- Video features
- Audio features
- Communication features

# Starting and Stopping the Computer

There are a number of ways to start and stop the computer.

## Starting the Computer





You always start the computer using the power button .

A computer starts up with an operating system (OS) existing on the storage device such as the hard disk; or from a floppy disk or CD if you have the respective modules installed. The computer will automatically load the OS after you turn it on. This process is called booting.

**NOTE:** An operating system is the platform for all your software application programs to run on. The most widely used operating system today is Microsoft Windows.

## Stopping the Computer

When you finish a working session, you can stop the computer by turning off the power or leaving the computer in Standby or Suspend mode:

| To stop in this mode... | Do this...                                                                                                                                                                                                                                                                                                                                          | To start up or resume again                                                                                    |
|-------------------------|-----------------------------------------------------------------------------------------------------------------------------------------------------------------------------------------------------------------------------------------------------------------------------------------------------------------------------------------------------|----------------------------------------------------------------------------------------------------------------|
| Off                     | Follow the shutdown procedure of your operating system. This can prevent loss of unsaved data or damage to your software programs.<br><br>If the system is locked up because of hardware or software problems, press the power button  to turn off the computer. | Press the power button  . |
| Standby                 | Depending on your settings in Windows, you can put the computer in Standby mode by pressing the power button  .                                                                                                                                                  | Press any key.                                                                                                 |
| Suspend                 | Depending on your settings in Windows, you can put the computer in Suspend mode by pressing the power button  .                                                                                                                                                  | Press the power button  . |

If you choose to stop in Standby or Suspend mode, you can return to where you left off the next time you start up the computer. (See “Power Management” in Chapter 3 for more information.)

## Using the Wireless Keyboard (option)

Before using the wireless keyboard, see section on “Positioning the Tablet PC and Wireless Keyboard” on chapter 1. Your wireless keyboard has all the standard functions of a full-sized computer keyboard.

The standard functions of the keyboard can be further divided into five major categories:

- Mouse-control buttons
- Typewriter keys
- Cursor-control keys
- Numeric keys
- Function keys

### Mouse-control Buttons

Mouse-control buttons found on both sides of the wireless keyboard are similar to the buttons on a mouse. The left button (❶) is similar to the left- and right-click mouse function. The right button (❷) allows you to slide the on-screen pointer horizontally, vertically, or diagonally.



## Typewriter Keys

Typewriter keys are similar to the keys on a typewriter. Several keys are added such as the Ctrl, Alt, Esc, and lock keys for special purposes. The Control key (Ctrl) is normally used in combination with other keys for program-specific functions. The Alternate key (Alt) is normally used in combination with other keys for program-specific functions. The Escape key (Esc) is usually used for stopping a process. Examples are exiting a program and canceling a command. The function depends on the program you are using. When the lock keys (Caps Lock, Num Lock, and Scroll Lock) are pressed, their corresponding indicators light up on the Tablet PC front panel's device indicators.

## Cursor-Control Keys



**NOTE:** The word “cursor” refers to the indicator on the screen that lets you know exactly where on your screen anything you type will appear. It can take the form of a vertical or horizontal line, a block, or one of many other shapes.

## Numeric Keypad

A 15-key numeric keypad is embedded in the typewriter keys as shown next:



Numeric keys facilitate entering of numbers and calculations. When Num Lock is on, the numeric keys are activated; meaning you can use these keys to enter numerals.

### NOTES:

- When the numeric keypad is activated and you need to type the English letter in the keypad area, you can turn Num Lock off.
- Some software may not be able to use the numeric keypad on the external wireless keyboard.



## Euro Symbol

If your Windows supports the Euro dollar sign €, you can press the sign on the keyboard.

- To press the Euro sign on the keyboard, hold down either of the Alt keys and type 0128 on the numeric keypad of your keyboard.
- To press the Euro sign on an UK keyboard, hold down the Alt Gr key and press 4 (which has an Euro sign on it).

## Windows Keys

The keyboard has two keys that perform Windows-specific functions:  Windows Logo key and  Application key.

The  Windows Logo key opens the Start menu and performs software-specific functions when used in combination with other keys. The  Application key usually has the same effect as a right mouse click. (See your Windows manual for more information.)

## Function Keys

On the top row of the keys are the function keys: F1 to F12. Function keys are multi-purpose keys that perform functions defined by individual programs.



## Using the Touchscreen

**NOTE:** To take advantage of the touchscreen feature, make sure that the touchscreen driver is correctly installed.

**CAUTION:** Do not use a sharp object such as a ballpoint pen or pencil on the touchscreen. Doing so may damage the touchscreen surface. Use the included touchscreen pen instead, which can be stretched for better grip and handling.

The touchscreen is a touch-sensitive device that allows you to communicate with the computer by controlling the location of the pointer on the screen and making selection with the buttons.

The touchscreen needs a special device driver support called a PenMount Monitor, which allows you to easily use the Tablet PC without any external pointing device (see chapter 6 for details).

The touchscreen pen is located at the rear of the Tablet PC (refer to “Rear Components” on chapter 1). You might need to tilt the Tablet PC after opening the touchscreen pen holder to get it. To use the touchscreen, place the touchscreen pen or your forefinger on the touchscreen. As you slide your pen or fingertip across the screen, the pointer, or cursor, on the screen moves in the same direction across the screen as your fingertip or pen moves across the screen.



*Touchscreen Pen Holder*

Here are some common terms that you should know when using the touchscreen:

| Term          | Action                                                                                                                                                                                                                                                                                                                                                                                                                                                                                                                         |
|---------------|--------------------------------------------------------------------------------------------------------------------------------------------------------------------------------------------------------------------------------------------------------------------------------------------------------------------------------------------------------------------------------------------------------------------------------------------------------------------------------------------------------------------------------|
| Point         | Move your finger or pen on the touchscreen until the cursor points to the selection on the screen.                                                                                                                                                                                                                                                                                                                                                                                                                             |
| Click         | Tap gently anywhere on the touchscreen.                                                                                                                                                                                                                                                                                                                                                                                                                                                                                        |
| Double-click  | Tap twice on the touchscreen rapidly.                                                                                                                                                                                                                                                                                                                                                                                                                                                                                          |
| Drag and drop | Press lightly on the touchscreen and move your finger or pen until you reach your destination (drag). Finally, release your finger or pen (drop) when you finish dragging your selection to the destination. The object will drop into the new location.                                                                                                                                                                                                                                                                       |
| Scroll        | <p>To scroll is to move up and down or left and right in the working area on the screen.</p> <p>To move vertically, place your finger or pen on the right edge of the touchscreen and slide your finger or pen up and down along the edge. To move horizontally, place your finger or pen on the bottom edge of the touchscreen and slide your finger or pen left and right.</p> <p>This function works only after you install the touchscreen driver supplied with the computer and it may not work for all applications.</p> |

**TABLE NOTE:** If you swap the left and right buttons, “tapping” on the touchscreen as an alternative method of pressing the left mouse button will no longer be valid.

## Configuring the Touchscreen

You may want to configure the touchscreen to suit your needs. For example, if you are a left-handed user, you can swap the two buttons function of the left mouse-control button on the wireless keyboard so that you can use the right mouse button as the left mouse button and vice versa. You can also change the size of the on-screen pointer, the speed of the pointer, and so on.

To configure the touchscreen, you can use the standard Microsoft or IBM PS/2 driver if you are using Windows. However, you can install the touchscreen driver supplied with your computer to take advantage of more powerful features. (For information on installing the driver, see Chapter 6.)

## Using the Floppy Disk Drive (option)

Your Tablet PC comes with an USB floppy disk drive as drive A through the USB port on the right side, or port replicator on an optional expansion box, or through the USB port located on the plug of an optional optical drive module, or on the included private cable.

A floppy disk drive allows you to install new programs into your computer, or to store information on a removable floppy disk so you can transfer information from one computer to another.

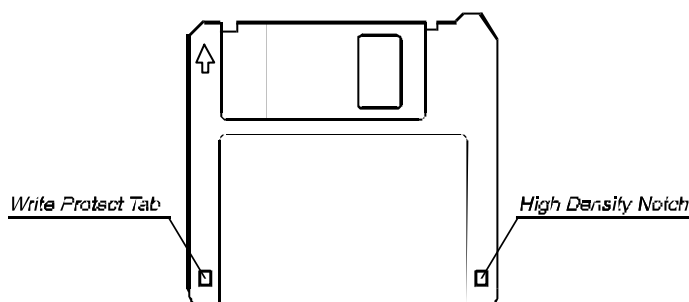

The floppy disk drive is a high-density 3.5-inch one, which can read and write to either double-density (2DD) 720-KB floppy disks or high-density (2HD) 1.44-MB floppy disks. Notice that both types of floppy disk have an arrow imprinted on the front upper left corner, and a sliding write-protect tab on the bottom left corner, as illustrated above. When opened, the write-protect tab prevents data from being written to, or erased from the floppy disk.

## Connecting the Floppy Disk Drive

Connect the floppy disk drive through any of the following methods:

- **Through the Tablet PC's USB Port** – Insert the USB plug of floppy disk drive into the USB port located on the right side of the Tablet PC.



- **Through the Expansion Port Plug of the Optical Drive Module–** Insert the USB plug of floppy disk drive into the USB port located on the expansion port plug of the optical drive module.



- **Through the Private Cable –**  
Insert the USB plug of the floppy disk drive into the USB port located on the private cable.



## Inserting and Ejecting Floppy Disks

To insert a floppy disk, hold it with the arrow facing up and towards the drive. Slide the disk into the drive until it clicks into place.

To eject a floppy disk, first ensure that the floppy disk drive in-use indicator is off, and then press the eject button on the drive. When the floppy disk pops out of the drive, remove the floppy disk and store it properly.



**CAUTION:**

- Never turn off or reset the computer while the floppy disk drive in-use indicator is on.
- Always store your floppy disks in a safe, clean container, to protect them from the environment and magnetic fields.
- A floppy disk must be formatted before you can use it. (To know how to format a floppy disk, see your operating system manual.)

## Using the Hard Disk Drive

Your computer comes with a hard disk drive as drive C.

A hard disk drive is a storage device with non-removable, rotating, magnetic storage platters inside it. It is where your operating system and application software programs are stored.

Your hard disk drive is a 2.5-inch IDE (Integrated Drive Electronics) hard disk drive. This type of drive embodies the latest in fast, reliable mass storage by integrating all the control circuitry necessary for operation directly onto the drive itself. This allows the drive manufacturer to carefully optimize drive performance.

The system comes with a built-in heater that can automatically turn on for low temperature operation. You can set whether the built-in heater will be on/off during low temperature operation by turning on the computer and running the BIOS SCU program. Enable the **HDD Heater** item, then, save and exit the SCU program. (See “Advanced Menu” in chapter 5).

**CAUTION:**

- Make regular backups of your data files from your hard disk drive to floppy disks or other storage media.
- Never try to remove or install the hard disk drive while the computer is powered on. Doing so can result in loss of data, and can damage the computer and the hard disk drive's sensitive circuitry.
- Never turn off or reset the computer while the hard disk drive in-use indicator is on.

## Using the Optical Drive (option)

Depending on the model, your computer comes with a CD/DVD-RW/Combo drive module. This drive is usually configured as drive D and is connected to the expansion port located on the right side of the Tablet PC.

The drive uses removable 5.25-inch silver discs, which look like standard music CDs. It is an ideal medium to use for distributing multimedia because of the huge amount of data that a disc can store.

- **CD drive** can read CDs, audio CDs, CD-R, and CD-RW discs.
- **DVD-RW drive** can read and write DVD (Digital Versatile Disc) discs in addition to reading the above discs.
- **Combo drive** can work both as a DVD drive and CD-RW drive.

**NOTE:** If the optical drive would be operating for more than half an hour (such as showing a CD/DVD title), use the AC or car power source instead of the battery. If not, the battery may run out of power before the operation is complete.

**CAUTION:**

1. When inserting a disc, do not use force.
2. Make sure the disc is correctly inserted into the tray, and then close the tray.
3. Do not leave the CD tray open. Also, avoid touching the lens in the tray with your hand. If the lens becomes dirty, the optical drive may malfunction.
4. Do not wipe the lens using materials with rough surface (such as paper towel). Instead, use a cotton swab to gently wipe the lens.

FDA regulations require the following statement for all laser-based devices:  
"Caution, Use of controls or adjustments or performance of procedures other than those specified herein may result in hazardous radiation exposure."

**NOTE:** The optical drive is classified as a Class 1 laser product. This label is located on the optical drive.





**NOTE:** For DVD-RW/Combo drive only.

This product incorporates copyright protection technology that is protected by method claims of certain U.S. patents and other intellectual property rights owned by Macrovision Corporation and other rights owners. Use of this copyright protection technology must be authorized by Macrovision Corporation, and is intended for home and other limited viewing uses only unless otherwise authorized by Macrovision Corporation. Reverse engineering or disassembly is prohibited.

## Connecting the Optical Drive

Insert the expansion plug of optical drive into the expansion port located on the right side of the Tablet PC.



## Inserting and Removing a Disc

Follow this procedure to insert or remove a disc.

1. Turn on the computer.

2. Press the eject button and the CD tray will slide out partially. Gently pull on it until it is fully extended.
3. To insert a disc, place down the disc in the tray with its label facing up. Slightly press the center of the tray until it clicks into place.



To remove a disc, hold the disc by its outer edge and lift it up from the tray.

4. Gently push the tray back into the drive.

**NOTE:** In the unlikely event that you are unable to release the CD tray by pressing the eject button, you can manually release the tray. (See “Optical Drive Problems” in Chapter 8.)

## Using the Video Features

The video subsystem of your computer features:

- 10.4-inch TFT (Thin-Film Transistor) 18-bit color LCD display with 1024×768 XGA (Extended Graphics Array) resolution.
- Simultaneous display on LCD and external monitor, which is useful when you have a presentation as you can control the screen from your computer and face the audience at the same time.
- Dual view capability, which allows you to expand your desktop on the screen to another display device so that you have more desktop space to work on.
- Power Management.
- Touchscreen function.
- Sunlight readable transfective LCD display (option).

## Configuring the Display Modes

**NOTE:** Before using the dual view capability and to take advantage of the enhanced video capabilities, the video driver supplied with your computer must be installed.

Your computer has been set to a default resolution and number of colors before shipment. You can view and change display settings through your operating system. See your operating system documentation or online help for specific information.

For displaying in higher resolutions, you can connect an external CRT monitor that supports higher resolutions through an optional Port Replicator Module.

The following table lists the display modes supported by your computer.

| Display Mode |        | LCD Only | CRT Only | Simultaneous Display |
|--------------|--------|----------|----------|----------------------|
| Resolution   | Colors |          |          |                      |
| 640×480      | 8-bit  | √        | √        | √                    |
|              | 16-bit | √        | √        | √                    |
|              | 24-bit | √        | √        | √                    |
|              | 32-bit | √        | √        | √                    |
| 720×480      | 8-bit  | √        | √        | √                    |
|              | 16-bit | √        | √        | √                    |
|              | 24-bit | √        | √        | √                    |
|              | 32-bit | √        | √        | √                    |
| 800×600      | 8-bit  | √        | √        | √                    |
|              | 16-bit | √        | √        | √                    |
|              | 24-bit | √        | √        | √                    |
|              | 32-bit | √        | √        | √                    |
| 848×480      | 8-bit  | √        | √        | √                    |
|              | 16-bit | √        | √        | √                    |
|              | 24-bit | √        | √        | √                    |
|              | 32-bit | √        | √        | √                    |
| 1024×768     | 8-bit  | √        | √        | √                    |
|              | 16-bit | √        | √        | √                    |
|              | 24-bit | √        | √        | √                    |
|              | 32-bit | √        | √        | √                    |
| 1152×864     | 8-bit  |          | √        |                      |
|              | 16-bit |          | √        |                      |
|              | 24-bit |          | √        |                      |
|              | 32-bit |          | √        |                      |

| Display Mode |        | LCD Only | CRT Only | Simultaneous Display |
|--------------|--------|----------|----------|----------------------|
| 1280×1024    | 8-bit  |          | √        |                      |
|              | 16-bit |          | √        |                      |
|              | 24-bit |          | √        |                      |
| 1600×1200    | 8-bit  |          | √        |                      |
|              | 16-bit |          | √        |                      |

**TABLE NOTE:** 8-bit = 256 colors; 16-bit = High Color or 65,536 (64 K) colors; 24 and 32-bit = True Color 16,770,000 (16 M) colors.

## Using the Audio Features

### NOTES:

- To take advantage of the enhanced audio capabilities, the audio and volume control drivers supplied with your computer must be installed (see Chapter 6 for details).
- If you experience interference while recording, try lowering the microphone recording volume.

The audio subsystem of your computer features:



- Digital audio and analog mixing functions required for recording and playing sound on your computer
- SoundBlaster Pro, Adlib, and Microsoft Windows Sound System support
- Volume control select (❶)
- Volume adjust (increase or decrease) (❷)
- Speaker (❸)
- External audio connectors (❹)



Ways of playing and recording sound vary with the operating system used. See your operating system documentation or online help for specific information.

## Connecting Audio Devices

For higher audio quality, you can send or receive sound through external audio devices.

- **Microphone Connector** (  ) can be connected to an external microphone for recording voice or sound.
- **Audio Output Connector** (  ) can be connected to the line-in connector of powered speakers with built-in amplifiers, headphones, or earphone set.

# Using the Communication Features

## Using the Modem

**NOTE:** To take advantage of the modem feature, the device driver supplied with your computer must be installed.

The internal 56 K fax/data modem allows you to use the telephone line to communicate with others by fax, email, or connect to an online service or bulletin board.

To connect the telephone line to the modem, connect the end nearest the core on the modem cable to the computer's RJ-11 connector and the other end to the telephone line.



**NOTES:**

- When using communication software, you may have to disable power management.
- Set the COM port of the modem to COM2.
- Set parameters such as modem speed (baud rate) and line type (pulse dialing or tone dialing).
- Do not enter Standby mode when using communication software.



## Using the Wireless LAN

Depending on your model, an internal Mini PCI Wireless LAN (WLAN) card may have been pre-installed by your computer manufacturer at the factory. This card allows you to access corporate networks or the Internet in a wireless environment.

The WLAN features include:

- 2.4 GHz DSSS (Direct Sequence Spread Spectrum) technology
- Peer-to-Peer (Ad-Hoc) and Access Point (Infrastructure) modes support
- WEP (Wired Equivalent Privacy) 64/128-bit data encryption
- Transmission rate at 11 Mbps, 5.5 Mbps, 2 Mbps, and 1 Mbps with automatic data rating

To take advantage of the WLAN feature, make sure that the WLAN driver is installed correctly (see Chapter 6 for details). If your WLAN card was provided by your dealer instead of the computer manufacturer, contact your dealer for the correct driver to use.

### Configuring the WLAN

After driver installation, you can use the WLAN utility to configure and monitor your WLAN connection. If you are using Windows XP, you can also use its built-in WLAN utility. Follow this procedure to launch the WLAN utility in Windows XP:

1. Select **Control Panel** from the **Start** menu.
2. Click **Network and Internet Connections**.
3. Click **Network Connections**, then double-click the **Wireless Network Connection** icon .
4. Click **Properties** in the **Wireless Network Connection Status** dialog box.
5. You can configure your WLAN settings in the **Wireless Network Connection Properties** dialog box.

## Turning Off/On the WLAN Radio

**NOTE:** The FAA (Federal Aviation Agency) has deemed it unsafe to operate wireless devices in aircraft as this may interfere with flight safety. Remember to turn off wireless LAN when using your computer in the airplane.

The Windows XP WLAN utility must be on for the WLAN function to work.

To turn off the WLAN function, turn off the WLAN utility.

It takes approximately 30 seconds for your computer to make a successful WLAN connection and approximately 10 seconds to disconnect.

## Using the Wireless Modem

Depending on your model, your computer includes an integrated GSM (Global System for Mobile Communications) / GPRS (General Packet Radio Service) / GPS (Global Positioning System) feature.

After you establish a subscription with a GSM/GPRS/GPS service provider, you can use the wireless data features of your computer. Check with your service provider for a list of available wireless data services. Your service provider may charge additional fees for use of data services.

There are two methods for wirelessly connecting to an ISP or network:

- **GSM data transmission (circuit-switched data)**  
GSM data services enable you to use the GSM component of your computer as a built-in modem. You can use the service to connect to the Internet through an ISP or dial in to a corporate network to browse the Web or send and receive e-mail messages.
- **GPRS data transmission**  
GPRS is a high-speed data-on service that enables you to transmit data over a mobile network. Subscribing to a GPRS service allows you to transfer files, browse the Web and receive streaming audio and video on your computer.

## Connecting Using the GSM Modem

**NOTE:** To take advantage of the wireless modem feature, the device driver supplied with your computer must be installed (see chapter 6).

Your computer can send and receive data via a mobile network using the GSM protocol.

To send or receive data over a GSM network, you must have an account with a service provider that supports GSM data services, and the service provider must enable the data features on your account.

### **Configuring a GSM Modem Connection**

Before you can use the GSM modem connection, make sure that you have a subscription to the Circuit-Switched Data (CSD) network with your service provider and you have an account with your service provider or corporate network you are connecting to.

To connect to an ISP or dial in to a specific computer, you must configure a connection for that service on your computer.

## Connecting Using GPRS

Your computer can receive General Packet Radio Services (GPRS), a high-speed data-only service that transmits data over a mobile telephone network. In addition, GPRS provides permanent on-line connection.

To use GPRS, you must have a subscription to the function with a service provider that supports GPRS.

### **Configuring a GPRS Connection**

To connect to a GPRS network, you must configure a connection for that service on your computer.

## Using the GPS

**NOTE:** To take advantage of the GPS feature, the device driver supplied with your computer must be installed (see chapter 6).

Navigation and positioning are crucial to so many activities and yet the process has always been quite cumbersome. To try to figure out where you are and where you are going, you need GPS technology.

The Global Positioning System (GPS) is a worldwide radio-navigation system formed from a constellation of 24 satellites and their ground stations. GPS uses these "man-made stars" as reference points to calculate positions accurate to a matter of meters. In fact, with advanced forms of GPS you can make measurements to better than a centimeter! In a sense it is like giving every square meter on the planet a unique address.

Here's how GPS works in five logical steps:

- The basis of GPS is "triangulation" from satellites.
- To "triangulate," a GPS receiver measures distance using the travel time of radio signals.
- To measure travel time, GPS needs very accurate timing that it achieves with some tricks.
- Along with distance, you need to know exactly where the satellites are in space. High orbits and careful monitoring are the secret.
- Finally you must correct for any delays the signal experiences as it travels through the atmosphere.

Five broad categories of GPS application:

- Location – determining a basic position
- Navigation – getting from one location to another
- Tracking – monitoring the movement of people and things
- Mapping – creating maps of the world
- Timing – bringing precise timing to the world



# *Managing Power*

Your computer operates either on external AC power, car adapter, or internal battery power.

This chapter tells you how you can effectively manage power. To maintain optimal battery performance, it is important that you use the battery in the proper way.

The topics in this chapter include:

- What is an AC or car adapter
- How to charge the battery pack
- When and how to initialize the battery pack
- How to check the battery level
- How to replace the battery pack
- What happens when the battery is low and what actions to take
- What is Power Management
- How to save power

## AC and Car Adapter

### CAUTION:

- The AC and car adapter is designed for use with your computer only. Connecting the AC adapter to another device can damage the adapter.
- The AC power cord supplied with your computer is for use in the country where you purchased your computer. If you plan to go overseas with the computer, consult your dealer for the appropriate power cord.
- When you disconnect the AC adapter, disconnect from the electrical outlet first and then from the computer. A reverse procedure may damage the AC adapter or computer.
- When unplugging the connector, always hold the plug head. Never pull on the cord.

The AC adapter serves as a converter from AC (Alternating Current) to DC (Direct Current) power because your computer runs on DC power, but an electrical outlet usually provides AC power. It also charges the battery pack when connected to AC power. The AC adapter operates on any voltage in the range of 100 ~ 240 V AC.

The car adapter serves as a converter from car battery to DC power. The cigarette lighter port of the car usually provides DC power. It also charges the battery pack when connected. The car adapter operates on any voltage in the range of 12 ~ 32 V DC.

**NOTE:** The battery pack cannot be charged when the input power of car adapter falls below 11.5 V DC.

## Battery Pack

The battery pack is the internal power source for the computer. It is rechargeable using the AC or car adapter.

The operating time of a fully charged battery pack depends on how you are using the computer. When your applications often access peripherals, you will experience a shorter operating time.

**NOTE:** Located inside the main battery compartment of the Tablet PC is the switch for turning off power coming from the internal backup battery (see chapter 1 for details).

**CAUTION:** Care and maintenance information for the battery is provided in Chapter 8. In addition to this chapter, be sure to read the "Battery Pack Guidelines" section in Chapter 8 as well.

## Charging the Battery Pack

### NOTES:

- Charging will not start if the battery's temperature is below 0 °C (32 °F) or above 45 °C (113 °F).
- The charging process will stop when the battery's temperature gets above 60 °C (140 °F). If this happens, the battery pack may be damaged, please contact your dealer.
- During charging, do not disconnect the AC adapter before the battery has been fully charged; otherwise you will get a prematurely charged battery.

To charge the battery pack, connect the AC adapter to the computer and an electrical outlet. The Battery Charge Indicator (  ) on the Tablet PC's Device Indicators appears to indicate that charging is in progress. You are advised to keep the computer power off while the battery is being charged. When the battery is fully charged, the Battery Charge Indicator disappears.

It takes approximately 90 minutes to charge the battery pack to 80% capacity and two or three more hours to fully charge the battery pack.

**CAUTION:** After the computer has been fully recharged, do not immediately disconnect and reconnect the AC adapter to charge it again. Doing so may damage the battery.



## Initializing the Battery Pack

You need to initialize a new battery pack before using it for the first time or when the actual operating time of a battery pack is much less than expected.

Initializing is the process of fully charging, discharging, and then charging. It can take several hours.



1. Make sure the computer power is turned off. Connect the AC adapter to fully charge the battery pack.
2. After the battery pack is fully charged, turn on the computer.
3. Disconnect the AC adapter and leave the computer on until the battery is fully discharged. The computer will shut down automatically.
4. Connect the AC adapter to fully charge the battery pack.

## Checking the Battery Level

When two batteries exist on the system, the battery's discharge sequence is from the main battery to the backup battery. When the battery charge on the main battery falls below 5%, then power usage will switch to the backup battery. Backup battery will only provide power source 10 minutes for user hot swap main battery, if over 10 minutes and main battery didn't plugged in, then system will shutdown.

**NOTE:** Any battery level indication is an estimated result. The actual operating time can be different from the estimated time, depending on how you are using the computer.

### By Operating System

You can check the approximate battery level using the battery meter function of the operating system. To read the battery level in Windows, click the icon  on the taskbar. (Click the  icon if the computer is using AC power.)

## By Gas Gauge

The internal backup battery pack does not support the gas gauge display on the battery itself, but on the exterior side of the main battery pack (option) is a gas gauge for displaying the estimated battery charge. When the main battery pack is not installed in the Tablet PC and you want to know the battery charge, you can press the on/off switch with a pointed device to see the corresponding value of indicator segment that light green. The value of the corresponding green segment indicates the relative percentage of the battery charge. The battery pack is fully discharged when you see no segment glowing green.

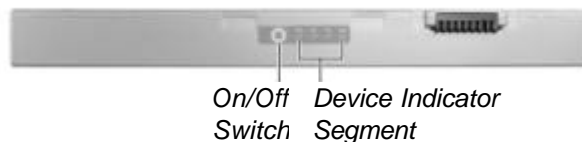

## Replacing the Main Battery Pack

### CAUTION:

- There is danger of explosion if the battery is incorrectly replaced. Replace the battery only with the computer manufacturer's optional battery packs. Discard used batteries according to the dealer's instructions.
- Do not attempt to disassemble the battery pack.

If you often rely on battery power for a long period of time while traveling, you may consider the purchase of an additional main battery pack from your dealer and keep it with you in a fully charged state as a backup.

To replace the battery pack, follow these steps:

1. Make sure the computer is not turned on or connected to AC power. However, the Tablet PC supports the battery hot-swap function, providing you the ability to replace the battery even during system on.
2. Carefully place the computer upside down.
3. Open the stand fully (❶).

- Slide the release lever (❷) to the right and pull the battery pack out of its compartment (❸) by using your thumb and index finger.



- Insert the new battery pack into the compartment and slide the release lever first to the right to accommodate it, then releasing it to the lock position.

## Battery Low Signals and Actions

Battery Low occurs when the battery has approximately 10% of its charge remaining. The computer gives warning beeps and the Battery Charge Indicator (  ) blinks to alert you to take actions.

**NOTE:** You can set up your threshold and signals of Battery Low under Windows.

Immediately save your data upon Battery Low. The remaining operating time depends on how you are using the computer. If you are using the audio subsystem, PC card, hard or floppy disk drives, the battery might run out of charge very quickly.

Always respond to Battery Low by placing your computer on hibernation, turning off the computer, or connecting the AC or car adapter.

If you do not take any action and after two minutes' of warning beeps, the computer will automatically hibernate and turn off.

**CAUTION:**

- If you are using a flash PC card, do not access the card during battery low periods. This is because the access may take longer than the time it takes the battery to run out of charge, thus making your access to the card unsuccessful.
- If you fail to save your data when the battery completely runs out of charge, then you lose your data.

## Power Management

Your computer supports ACPI (Advanced Configuration and Power Interface) for power management. The power management feature allows you to reduce the power consumption for energy saving.

With an ACPI-compliant operating system such as Windows 2000 and Windows XP, power supply to different computer components is controlled on an as-needed basis. This allows maximum power conservation and performance at the same time.

In general, Windows' power management works in this way:

| What...                                                                                                               | When...                                                                                                                  |
|-----------------------------------------------------------------------------------------------------------------------|--------------------------------------------------------------------------------------------------------------------------|
| Power to the hard disk is turned off                                                                                  | When the hard disk has been idle for a set period.                                                                       |
| Power to the display is turned off                                                                                    | When the display has been idle for a set period.                                                                         |
| The computer enters Standby mode. The hard disk and display are turned off and the entire system consumes less power. | When the entire system has been idle for a set period.                                                                   |
| The computer enters Suspend mode. (See the next subsection for more information.)                                     | When you press the power button  .* |

\* depends on your settings in Windows.

For detailed information on power management, see Windows' Help.

## Hibernation

**NOTE:** Make sure that the hibernation feature is enabled in the **Hibernate** tab of the **Power Options** Properties from the Control Panel in Windows XP.

Hibernation is a very useful feature. People frequently open many applications when they use computers. It takes some time to get all these applications open and running, and normally they all have to be closed before the system can be turned off.

When you use the hibernation feature, you do not have to close the applications. The computer stores the state of your computer to a file on the hard disk and then shut down. The next time you turn on your computer, you return to exactly where you left off.

## Manual Power Management

You can manually initiate hibernation at any time by pressing the power button  and releasing it in less than 4 seconds with the system on. Repeat the action to wake up the system under hibernation.

## Power-Saving Tips

In addition to your computer's automatic power management, you can do your part to maximize the battery's operating time by following these suggestions.

- Do not disable Power Management.
- Decrease the LCD brightness to the lowest comfortable level.
- Disable the parallel and serial ports if no devices are connected to these ports. (See "Advanced Menu" in Chapter 5.)
- If you work with an application that uses the serial port or a PC card, exit the application when you finish using it.
- If you have a PC card installed, remove it when not in use. Some PC cards drain power even while they are inactive.
- Turn off the computer when you are not using it.

# *Expanding Your Computer*

You can expand the capabilities of your computer by connecting other peripheral devices. When using a device, be sure to read the instructions accompanying the device together with the relevant section in this chapter.

This chapter gives guidelines on installing and using these devices:

- Serial device
- IR device
- USB device
- PC card



## Connecting a Serial Device

Your computer has a private port for connecting a serial device such as a serial mouse or modem through the private cable.

Follow this procedure to connect a serial device:

1. Make sure the **COM Ports** item is set properly in the SCU program. (See “Advanced Menu” in Chapter 5 for information.)
2. Make sure the computer is not turned on.
3. Plug the included private cable to the private port.

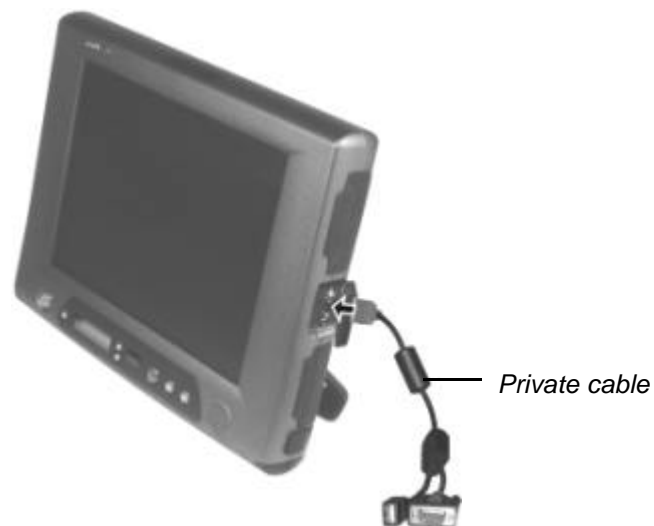

4. Plug the device cable to the serial port on the private cable.
5. Turn on the computer.

**NOTE:** Portable modems that derive power through the serial port cannot be used with the Tablet PC. Instead, use a modem that is powered by its own internal battery or external AC power.

## Connecting a USB Device

Your computer has one USB port on the right side for connecting USB devices such as digital camera, scanner, printer, modem, or mouse; and one CCD USB port at the bottom-side for connecting an optional CCD camera.

**NOTE:** You can also use the USB port located on the Expansion Port plug of the optional optical drive module or the included private cable.

USB is specified to be an industry standard extension to the PC architecture. It supports “Plug-and-Play” technology so you can install and remove USB devices without turning off the computer. With its multiple connection capability, up to 127 devices can be connected in a daisy-chain configuration. In addition, you can use a USB hub that converts a single USB connector into multiple ports where USB devices can be connected.

To connect a standard USB device, simply plug the device cable to the USB port on the right side of the Tablet PC, or through the optional optical drive module’s Expansion Port plug.

To connect an optional CCD camera, simply place the camera on top of the Tablet PC nearest the CCD USB port. Align and plug in the golden finger connector to the CCD USB port at the bottom-side of the Tablet PC and secure it in place with the built-in screw. Adjust the angle of the CCD camera according to your need.



## Connecting an IR Device

Your computer has an IR (InfraRed) port for connecting an infrared-equipped device wirelessly such as a wireless keyboard/mouse, another computer, printer, or PDA (Personal Digital Assistant).

The infrared feature supports these standards:

For the front panel's IR port

- IR keyboard/mouse that supports Forward FK34PUS002 (US language) specification

For the left side's IR port

- IrDA 1.1 (FIR – Fast Infrared) with 9.6 Kbps to 4.0 Mbps transfer rate
- HPSIR – Serial Infrared mode

Follow this procedure to connect an IR device:

1. Under Windows, make sure that the IrDA Fast Infrared Port is set to HP HSDL-2300/3600. (See “How to Use the CD” in Chapter 6 for information.)
2. Make sure that the **COM Ports** and its **Mode Setting for COM2** items are set properly in the SCU program. (See “Advanced Menu” in Chapter 5 for information.)
3. When using the front panel's IR port:  
Place the wireless keyboard where its IR port faces the IR port of your computer within the effective range – within  $\pm 15$ -degrees vertical angle and within  $\pm 30$ -degrees horizontal angle at no greater than 3 meter distance.

When using the left side's IR port:

Place the transmitting device where its IR port faces the IR port of your computer within the effective range – within  $\pm 15$ -degrees vertical angle and within  $\pm 15$ -degrees horizontal angle at no greater than 0.8~1.0 meter distance.

Place the receiving device where the IR port of the Tablet PC faces its IR port within the effective range – within  $\pm 15$ -degrees vertical angle and within  $\pm 15$ -degrees horizontal angle at no greater than 0.8~1.0 meter distance.

4. To take advantage of the IR communications, you need a third party software.

**NOTES:** During infrared communication, take note of the following:

- Do not move the computer and IR device.
- Do not enter Standby mode.
- Do not use a cell phone or another IR device near the computer.
- Avoid strong light such as sunlight or fluorescent light.
- Disable the screen saver.

## Using PC Cards

Your computer has one PC card slot to accommodate one type II card.

### CardBus Support

Your computer's PC card slot supports the CardBus specifications. CardBus is the 32-bit version of PC card technology. It allows speeds of up to 133 Mbps at 33 MHz. Typical applications are SCSI host bus, graphic video, and high-speed network cards.

### Inserting and Removing a PC Card

**NOTES:**

- Some PC cards require additional system resources. Before using such PC card, you may have to free other system resources for the PC card.
- Although some PC cards can be inserted and removed without turning off the computer, you cannot remove or install PC cards during Standby mode.

To insert a PC card:

1. Locate the PC card slot on the right side of the computer.
2. Slide the PC card, with its label facing up, into the slot until the eject button pops out.



3. When a new card is seated, the computer will detect it and try to install the appropriate driver. Follow the on-screen instruction to complete the process.

To remove a PC card:

1. Double-click on the **Safely Remove Hardware**  icon found on the Windows XP taskbar and the **Safely Remove Hardware** window appears on screen.
2. Select (highlight) the PC card you want to disable from the list and click on the **Stop** button to disable the card.
3. Push the eject button and the card will slide out slightly.
4. Pull the card out of the slot.

## System Memory Upgrade

You can upgrade your computer by changing system memory to a maximum of 1 GB on the SO-DIMM slot. However, to avoid damage during the installation procedure, please ask your dealer for help.





## ***Setup Configuration Utility (SCU)***

SCU is a program for configuring the BIOS (Basic Input/Output System) settings of the computer.

BIOS is a layer of software, called firmware, that translates instructions from other layers of software into instructions that the computer hardware can understand. The BIOS settings are needed by your computer to identify the types of installed devices and establish special features.

This chapter tells you how to use the SCU program.

# When and How to Use the SCU Program

## When to Use

You need to run the SCU program when:

- You see an error message on the screen requesting you to run Setup.
- You want to restore the factory default settings.
- You want to modify some specific settings according to the hardware.
- You want to modify some specific settings to optimize system performance.

## Starting SCU

### NOTES:

- The Setup screens shown in this chapter are for your reference only. The actual items or settings on your computer may differ.
- The Setup program may have been updated after the publication of this manual.
- The settings you select in your operating system might override similar settings in Setup.

To run SCU, press F2 when the prompt appears in the lower left corner of the screen during system startup. The prompt shows up on the screen for only a few seconds. You must press F2 quickly. The SCU menu appears as shown next.



## Moving Around and Making Selections

A brief description of keyboard (if installed) usage is listed next:

| Key             | Function                                                                                                                                                      |
|-----------------|---------------------------------------------------------------------------------------------------------------------------------------------------------------|
| ←, →            | Selects a menu title.                                                                                                                                         |
| ↑, ↓            | Selects an item or option.                                                                                                                                    |
| Enter           | 1) Brings up the sub-menu when an item with the arrow sign is selected.<br>2) Opens or closes the options window when an item is selected.                    |
| Space bar,<br>- | Cycles through the pre-defined value for the selected item.<br>Pressing the space bar brings up the next value; pressing the minus (-) key does the contrary. |
| Esc             | 1) Exits the SCU program.<br>2) Returns to the previous menu if in a sub-menu.<br>3) Closes the options window if one is open.                                |

**NOTE:** You are advised to use the mouse (if installed) as it is more straightforward than using the keyboard.

## Main Menu

The Main menu contains the basic configuration settings of the system.



## Date and Time

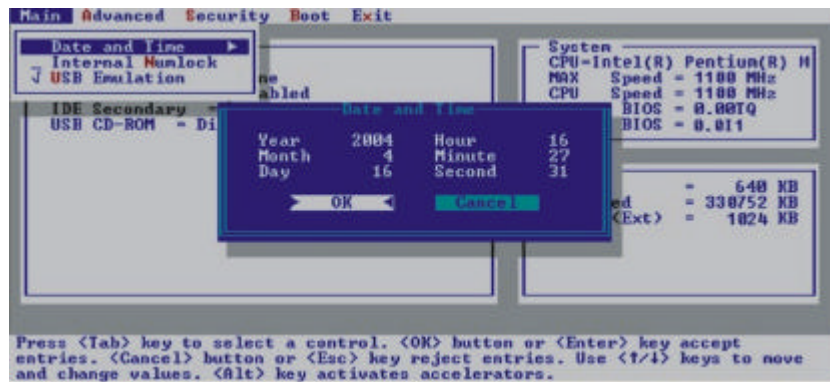

Sets the system time (Hour, Minute, Second) and date (Year, Month, Day).

## Internal Numlock

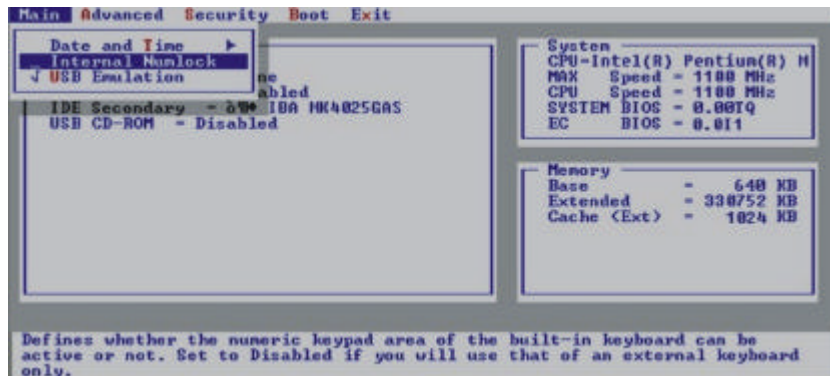

Sets if the numeric keypad will function. A check mark (✓) indicates enabled, while underline (⎵) indicates disabled.

## USB Emulation

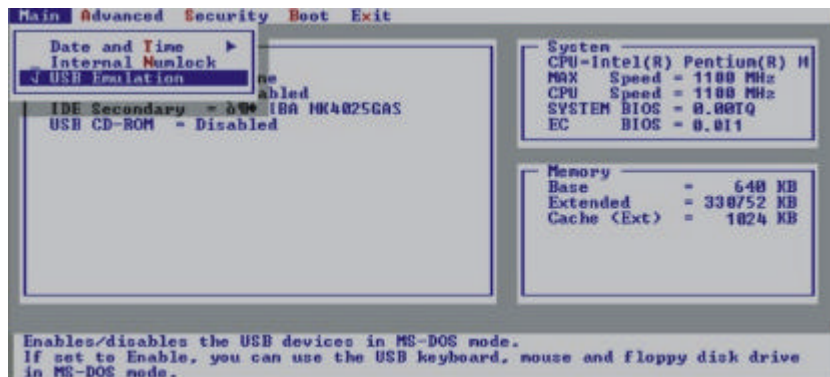

Sets if the system supports the USB port in DOS mode. A check mark (✓) indicates enabled, while underline (⎵) indicates disabled.

## Advanced Menu

The Advanced menu contains the Input/Output (I/O) configuration settings of the system.

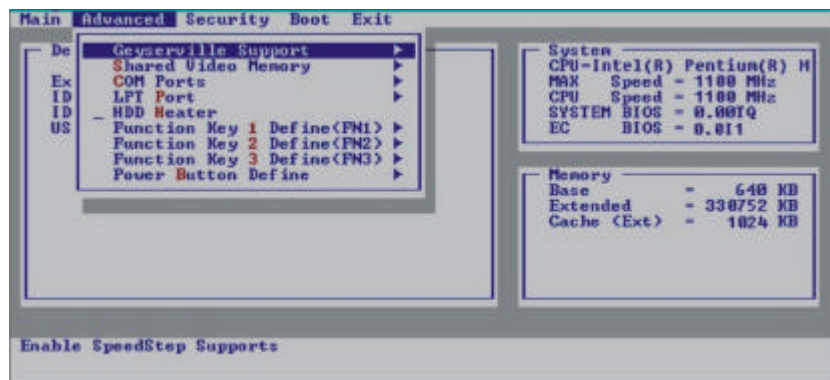

## Geyserville Support

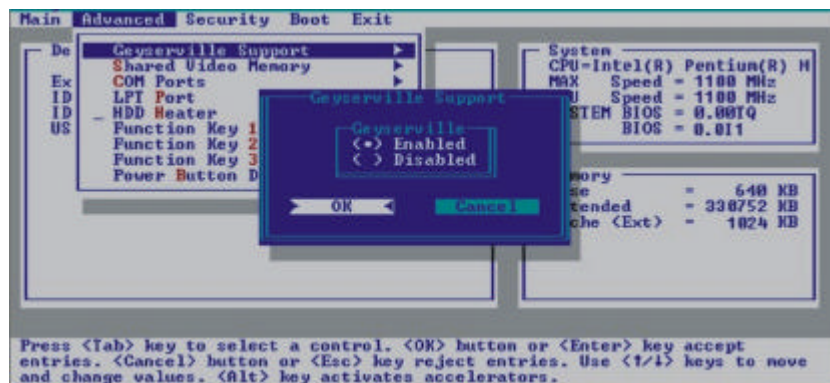

This item is only available if the CPU you are using supports the Intel® SpeedStep™ function. It allows maximum CPU performance when using AC/car power but minimum CPU performance when using battery power. The available options are *Enabled* and *Disabled*.

**NOTE:** For Windows 2000, you need to install the SpeedStep driver to use this function (see Chapter 6 for details).

## Shared Video Memory



Sets the shared memory size of the video controller. The available options are *4M*, *8M*, *16M*, and *32M*.

**NOTE:** The shared video memory size of the video controller will depend on your system memory. If your system memory is greater than 256 (512) MB, system will automatically set the above item to *64MB*.

## COM Ports

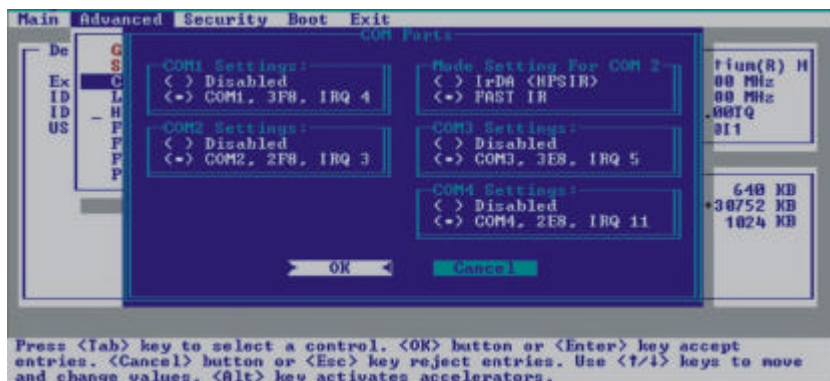



Allows you to assign COM1/COM2/COM3/COM4 to specific functions that you wish to use. In general, COM1/COM4 can be assigned to *RS-232C* (serial port), COM2 can be assigned to *IR* (InfraRed), while COM3 can be assigned to *touchscreen*. Select *Disabled* if you need the resources (3F8/IRQ4 of COM1, 2F8/IRQ3 of COM2, 3E8/IRQ5 of COM3, 2E8/IRQ11 of COM4) for other devices. Sets the communication compatibility mode for the IR port.

The item **Mode Setting For COM2** sets the communication compatibility mode according to the type of the IR device to be connected. The options are *IrDA (HPSIR)* and *Fast IR*. This item is not valid for setting if the previous item **COM2 Settings** is set at *Disabled*.

## LPT Port

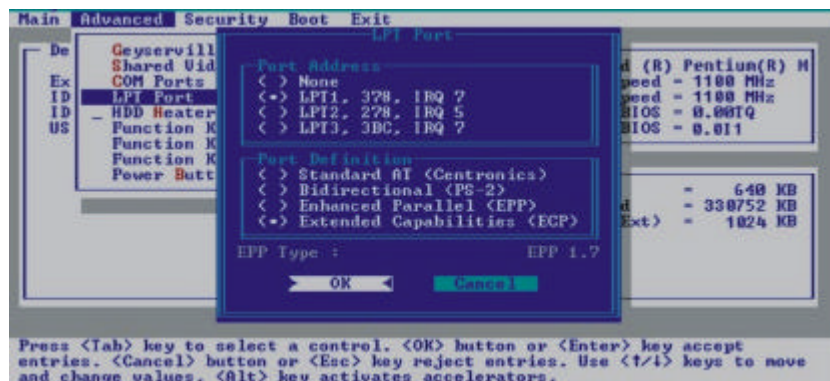

The item **Port Address** sets the address for the LPT port (parallel port). The options are *378/IRQ7* of *LPT1*, *278/IRQ5* of *LPT2*, *3BC/IRQ7* of *LPT3*.

The item **Port Definition** sets the LPT port (parallel port) mode supported by the parallel device you are using. Your system supports *Standard AT (Centronics)*, *Bi-directional (PS-2)*, *EPP (Enhanced Parallel Port)* and *ECP (Extended Capabilities Port)* standards that turn the standard parallel port into a high-speed bi-directional peripheral port.

## HDD Heater

Sets if the system automatically turns on the built-in hard disk drive heater for low temperature operation. A check mark (✓) indicates enabled, while underline ( ) indicates disabled.

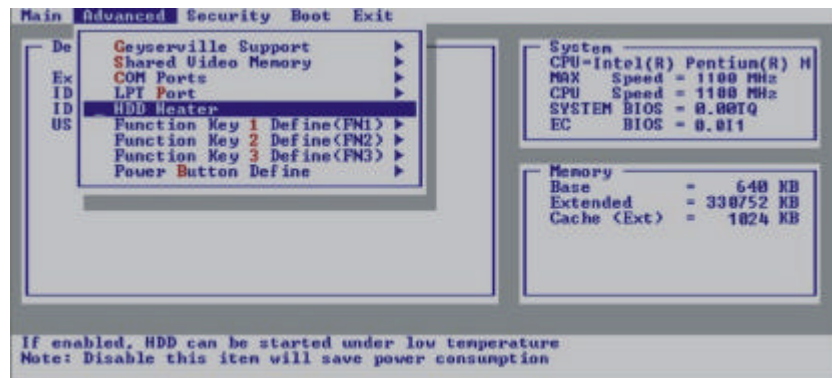

## Function Key 1/2/3 Define (FN1/FN2/FN3)



These three items allow user to define the corresponding function key associated with the three function buttons (FN1, FN2, FN3) found on the front panel

**NOTE:** The backlight switch function is supported only if your LCD is the transfective type (option).

## Power Button Define

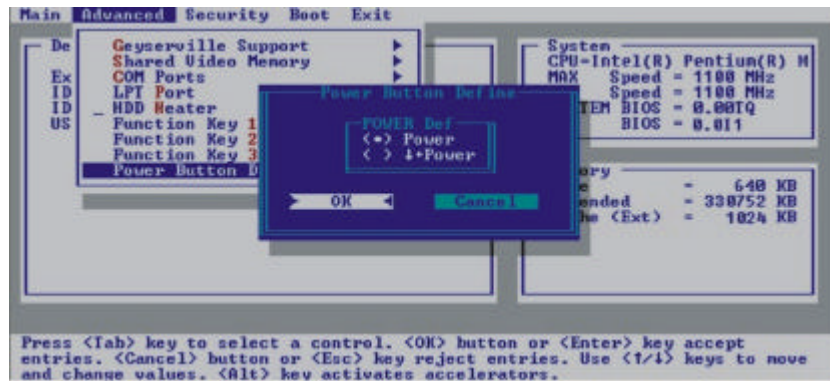

Allows you to set whether system power on/off would occur by just pressing the power button (when set at *Power*) or whether a combination of the speaker volume / LCD brightness down arrow key located on the front panel plus the power button (when set at *↓+Power*) is needed to turn on/off system power. The latter option prevents an accidental system turning on/off during transit.

## Security Menu

The Security menu contains the security setting that safeguards your system against unauthorized use.

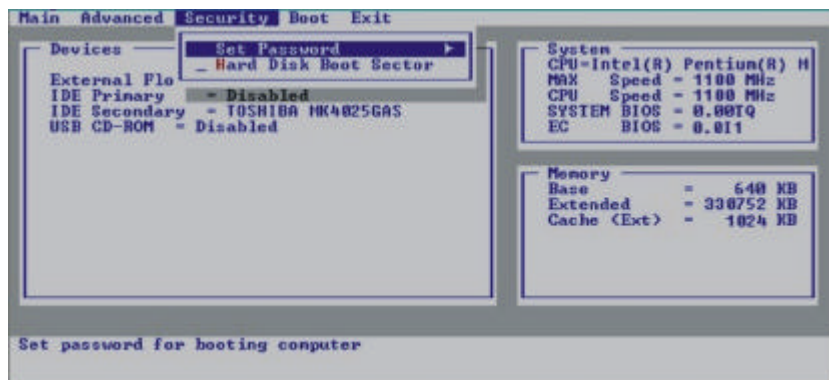

## Set Password

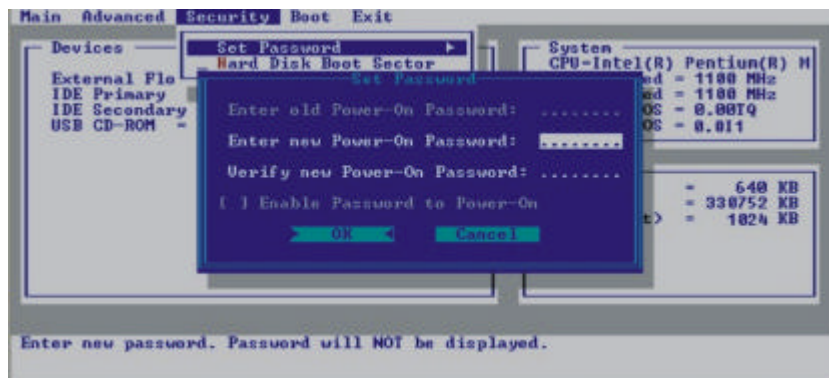

Allows you to set the password for your system. When typing the password, first make sure that Num Lock is off, and then type the password in the entry fields and press Enter. Confirm your password by typing it again and pressing Enter. If the **Enable Password to Power-on** sub-item is enabled, the set password is always required to boot the computer.

## Hard Disk Boot Sector

Helps prevent infection of computer viruses by protecting the hard disk boot sector (partition table) from changes. A check mark (✓) indicates enabled, while underline ( ) indicates disabled.

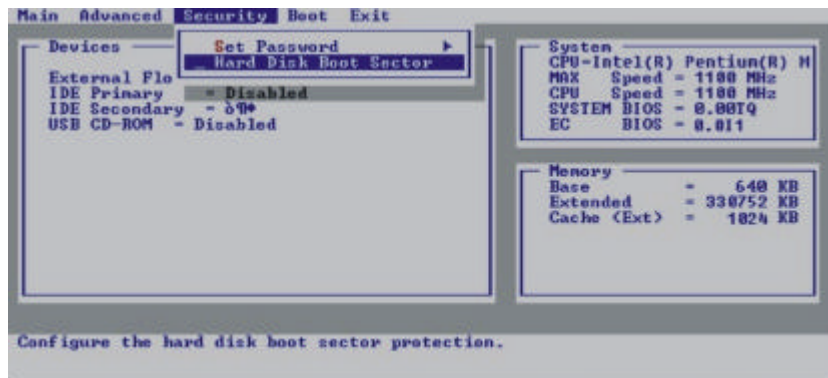

**CAUTION:** Disable this item before installing an operating system, running Fdisk or Format program. Otherwise, the intended action will fail.

## Boot Menu

The Boot menu sets the sequence of the devices to be searched for the operating system.

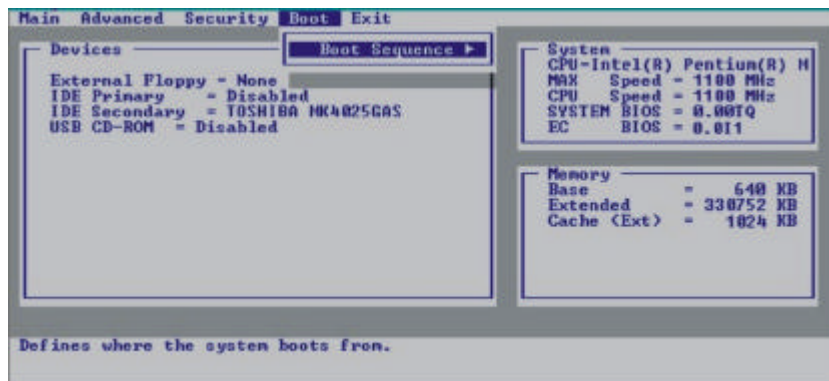

## Boot Sequence

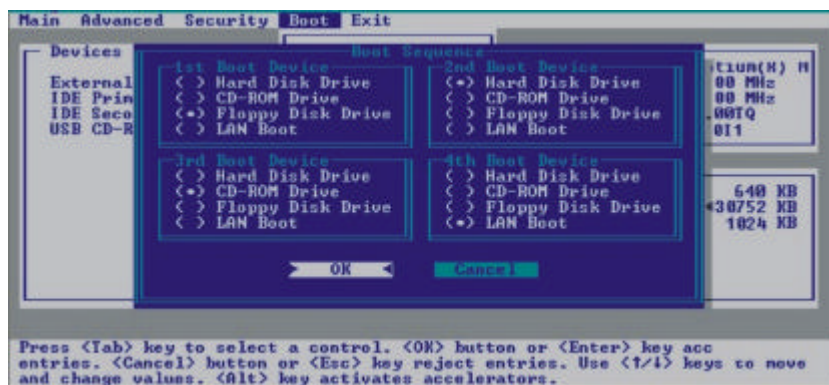

Sets the first, second, third, and fourth boot device. The system will try to boot from the first device but if it is not available, will try the next boot device. If you set the first boot device to *LAN Boot*, the system will boot from the LAN server first. The options are *Hard Disk Drive*, *CD-ROM Drive*, *Floppy Disk Drive*, and *LAN Boot*.

**NOTE:** If you set all booting options to the same device, then the computer will try to boot from that device only.

## Exit Menu

The Exit menu allows you to leave the SCU program. After finishing with your settings, you must save and exit so that the new settings can take effect.

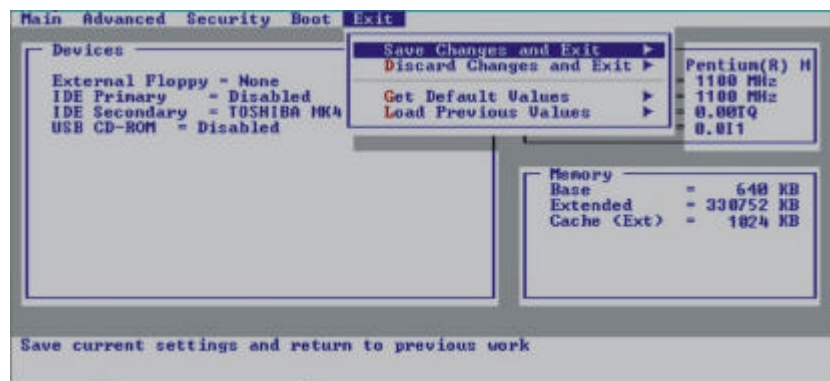

**Save Changes and Exit** saves the changes you have made and exits the SCU program.

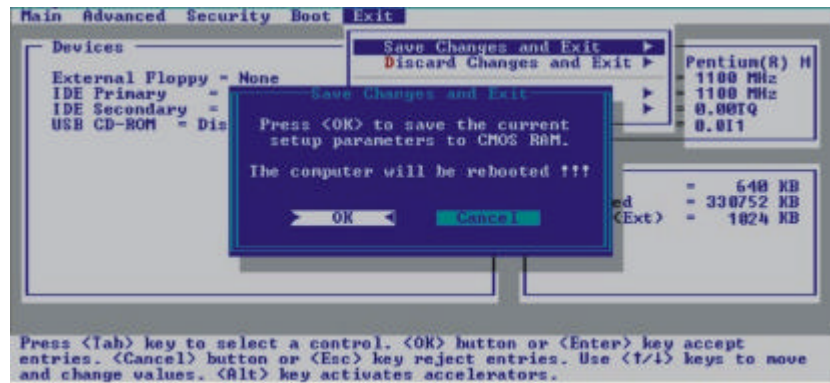



**Discard Changes and Exit** exits the SCU program without saving the changes you have made.

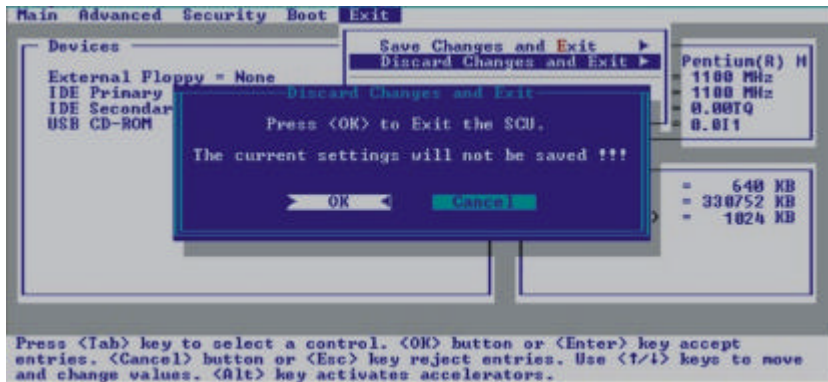

**Get Default Values** loads factory default values for all the items.

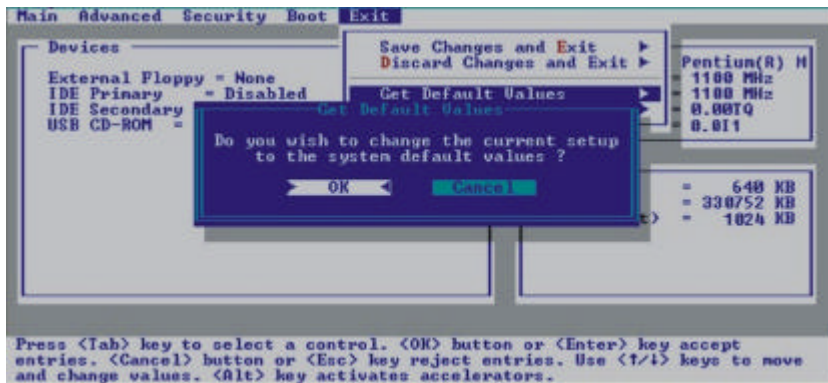



**Load Previous Values** restores previous values for all the items.

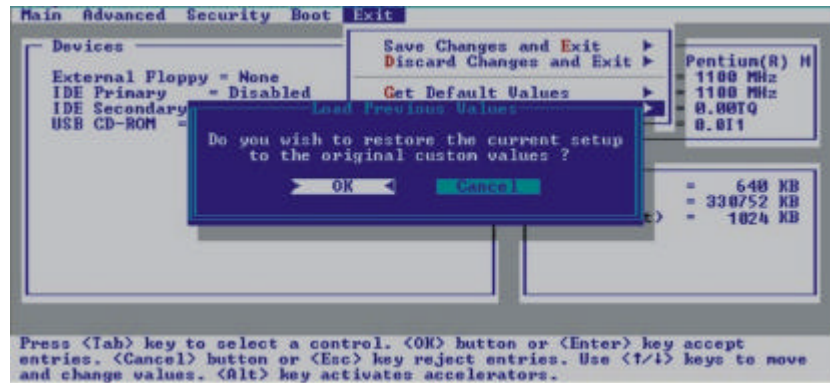

## ***Installing Software Drivers***

To take full advantage of the unique features of your Tablet PC, some operating systems require custom software, known as drivers, to be installed.

If you purchased the Tablet PC with Windows pre-installed, your dealer may have already installed the drivers. If not, you need to install the drivers using the CD supplied with your Tablet PC.

This chapter describes how to install the drivers.

## How to Use the CD

### NOTES:

- The drivers may have been updated after this manual was published. For drivers upgrade, please contact your dealer.
- You can always find the README or document files on the CD. These files contain the latest information from the software supplier. Please read the files together with this chapter.
- This CD supports Windows 2000, Windows XP, and Windows XP Tablet PC edition. Other systems are not supported.
- The available items may differ according to your computer model and operating system.
- You are recommended to install Windows 2000 Service Pack 4 or above if you are using Windows 2000, and Windows XP Service Pack 1 or above if you are using Windows XP.
- Please do not remove the driver CD when installing the driver.

A Setup program is provided on the driver CD. To run the program, simply insert the CD and the following screen will appear. In case the autorun function of your CD drive is not enabled, then click on “Start”, then “Run.” Specify the CD drive and choose **autorun.exe**.



Just click the **Device Driver** link on the main screen.

After installing the device drivers, proceed to the following:

- Touchscreen* The touchscreen driver allows you to use your fingers as well as the touchscreen pen as a pointing device.
- Volume Control* The volume control driver allows you to use the volume control buttons located on the front panel.
- SpeedStep* The SpeedStep driver allows the Intel SpeedStep functionality to optimize the power consumption of the CPU by allowing it to run in full speed when AC/car adapter is plugged-in and run in low speed when computer is using battery power.  
**NOTE:** For Windows 2000 only.
- PROSet* The PROSet driver allows you to use the Intel PRO wireless LAN utility.  
**NOTE:** Proceed immediately to the section “Wireless LAN Utility Installation” for more details.
- Browse CD* Browses the contents of this CD.
- README* Selects the manual to view.

**NOTE:** You are recommended to reboot your system after driver installation for the drivers to take effect.

You can also manually install the drivers. The drivers are described next:

| Name           | Directory                                    | Description                                                                                                         |
|----------------|----------------------------------------------|---------------------------------------------------------------------------------------------------------------------|
| Chipset driver | \Intel\chipset\<br>infinst_enu.exe           | Ensures the full function of the following drivers. Install this driver before installing the other device drivers. |
| DirectX driver | \Utility\DirectX\<br>dx81nteng.exe           | Allows you to take full advantage of the multimedia applications.<br><b>NOTE:</b> For Windows 2000 only.            |
| Video driver   | \WinXP\VGA\ or<br>\Win2000\VGA\<br>setup.exe | Installs the video driver that allows you to select high-resolution displays with richer colors.                    |

| Name                      | Directory                                        | Description                                                                                                                                                                                                                                                                                                                                    |
|---------------------------|--------------------------------------------------|------------------------------------------------------------------------------------------------------------------------------------------------------------------------------------------------------------------------------------------------------------------------------------------------------------------------------------------------|
| Audio driver              | \WinXP\audio\ or<br>\Win2000\audio\<br>setup.exe | Installs the audio driver that allows you to take full advantage of the audio subsystem.<br><b>NOTE:</b> The Windows Plug-and-Play capability may automatically detect the new device (Realtek AC'97 codec) and display the wizard requesting for drivers. Click <b>Cancel</b> to bypass the wizard screen(s).                                 |
| Modem driver              | \WinXP\modem\<br>\Win2000\modem\<br>ptuninst.exe | Installs the modem driver that allows you to use the modem function of the computer.                                                                                                                                                                                                                                                           |
| LAN driver                | \WinXP\LAN\<br>\Win2000\LAN\<br>prounstl.exe     | Installs the LAN driver that allows you to use the network function of the computer.                                                                                                                                                                                                                                                           |
| WLAN driver<br>(optional) | \WinXP\WLAN\ or<br>\Win2000\WLAN\                | Installs the WLAN driver that allows you to use the computer's internal Mini PCI Type-III B WLAN card's network function.<br><b>NOTE:</b> The Windows Plug-and-Play capability may automatically detect the new device (Mini PCI WLAN card) and display the wizard requesting for drivers. Click <b>Cancel</b> to bypass the wizard screen(s). |

# Dos Mode Setting

When connect CRT display, the CRT full screen disappear under the DOS mode, you can follow step as below:

1. Select right side corner (  ) icon then will appear next figure.



2. Select “Graphics Options” then click on the “Graphics Properties”.



3. Select “Device”, “Intel® Dual Display Clone” and check mark indicates enabled “Same display configuration driven on both displays”.

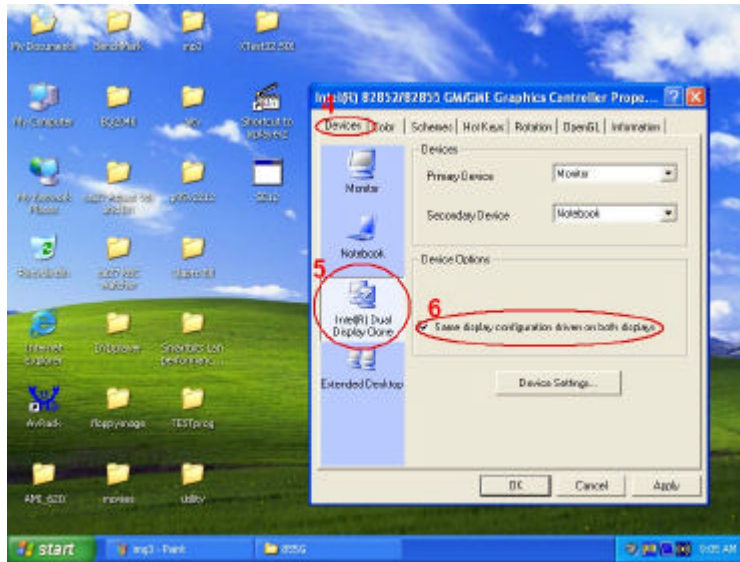

## Touchscreen Driver



To install the touch screen driver; perform the following:

1. Insert the driver CD into the drive.
2. Click on "TOUCH SCREEN" and follow the onscreen instructions to continue.
3. When finished installing, select "Yes" to reboot your system. The driver should now be loaded.



## Touch screen Calibration:

1. After the system has finished rebooting, click on the “Penmount monitor” icon located on the taskbar to bring up the “Penmount Control Panel”.
2. Select the “Standard Calibration” folder and click on “OK”.
3. If you need 4,9,16,25 dot of the calibrate, we suggest select “Advanced Calibration” button to calibrate.
4. Click on the four sides (points) and the plus-sign “+” on the screen to calibrate your touch screen pen for use on the computer.

Note:

1. You may encounter this problem from some touch screens with cursors shift issue when you work high temperature or high humidity environment.
2. The touch screen under calibration doesn't support by VGA extension mode.

## Intel SpeedStep Utility

After installing the SpeedStep driver, you can now optimize the power consumption of the CPU. Click on “Start,” then “Programs,” then “Intel SpeedStep Utility.” The following screen appears as shown next:



Make the necessary settings according to your system requirements.

## Wireless LAN Utility Installation

Upon clicking on the **PROSet** link on the main screen, the Installation Wizard appears on screen. Upon clicking on “Next,” the following screen appears as shown next.



After making your selection, follow the onscreen instructions to complete the wireless LAN utility installation.

## ***Caring for the Tablet PC***

Taking good care of your computer will ensure a trouble-free operation and reduce the risk of damage to your computer.

This chapter gives you guidelines covering these areas of maintenance:

- How to protect the computer
- What to note when using and storing the computer
- How to clean the computer
- What to note when using the battery pack
- What to note when traveling with the computer

## Protecting the Computer

To safeguard the integrity of your computer data as well as the computer itself, you can protect the computer in several ways as described in this section.

### Using the Password

The power-on password protects your computer against unauthorized use. If the password is set, the prompt requesting for the password appears on the screen whenever the computer is turned on.

The password is set via the SCU program. See “Security Menu” in Chapter 5 for instructions.

### Using an Anti-Virus Strategy

New viruses are always being developed nowadays and they are attacking computers even more easily with emails so commonly used worldwide.

The Security feature of the SCU program protects the boot sector of the hard disk. To enable the function, see “Security Menu” in Chapter 5 for instructions.

You can also install a virus-detecting program to monitor potential viruses that could damage your files.

# Taking Care of the Tablet PC

## Location Guidelines

- Use the computer where the temperature is between 10 °C (50 °F) and 35 °C (95 °F).
- Avoid placing the computer in a location subject to high humidity, extreme temperatures, mechanical vibration, direct sunlight, or heavy dust.
- Do not cover or block any ventilation openings on the computer. For example, do not place the computer on a bed, sofa, rug, or other similar surface. Otherwise, overheating may occur that results in damage to the computer.
- Keep the computer at least 13 cm (5 inches) away from electrical appliances that can generate a strong magnetic field such as a TV, refrigerator, motor, or a large audio speaker.
- Do not move the computer abruptly from a cold to a warm place. A temperature difference of more than 10 °C (18 °F) will cause condensation inside the unit, which may damage the storage media.
- Do not place the computer on an unsteady surface.

## General Guidelines

- Do not place heavy objects on top of the Tablet PC as this may damage the display.
- The screen surface is easily scratched. Do not use paper towels to clean the display. Avoid touching it with a ballpoint pen or pencil.
- To maximize the life of the backlight in the display, allow the backlight to automatically turn off as a result of power management. Avoid using a screen saver or other software that prevents the power management from working.

## Cleaning Guidelines

- Never clean the computer with its power on.
- Use a soft cloth moistened with water or a non-alkaline detergent to wipe the exterior of the computer.
- Gently wipe the display with a soft, lint-free cloth. Do not use alcohol or detergent on the display.
- Dust on the IR port can interfere with data transfer. Wipe the port with a soft, dry cloth.
- Dust or grease on the touchscreen can affect its sensitivity. Clean the touchscreen by using adhesive tape to remove the dust and grease on its surface.

## Battery Pack Guidelines

- Recharge the battery pack when it is nearly discharged. When recharging, make sure the battery pack is fully charged. Doing so may avoid harm to the battery pack.
- Operate the computer with the battery pack installed even when using external power. This ensures that the battery is fully charged.
- If you will not be using the computer for a long period of time (more than two weeks), remove the battery pack from the computer.
- If you remove the battery pack, make sure the battery terminals do not contact any conductors such as metal objects or water. Otherwise, the battery may become unusable as a result of a short circuit.
- If you need to store the battery pack, store it in a cool, dry place. Never allow the temperature to exceed 60 °C (140 °F).
- Do not leave the battery pack in storage for more than 3 months without recharging it.

## When Traveling

- Before traveling with your computer, make a backup of your hard disk data into floppy disks or other storage devices. As an added precaution, bring along an extra copy of your important data.
- Make sure the battery pack is fully charged.
- Make sure the computer is turned off.
- Do not leave objects that will press onto the display.
- Disconnect the AC adapter from the computer and take it with you. Use the AC adapter as the power source and as a battery-charger.
- Hand-carry the computer. Do not check it in as luggage.
- Allow extra time for airport security. Many airports inspect electronic devices carefully.
- If you need to leave the computer in the car, put it in the trunk of the car to avoid exposing the computer to excessive heat.
- When going through airport security, it is recommended that you send the computer and floppy disks through the X-ray machine (the device you set your bags on). Avoid the magnetic detector (the device you walk through) or the magnetic wand (the hand-held device used by security personnel).
- If you plan to travel abroad with your computer, consult your dealer for the appropriate AC power cord for use in your country of destination.





# *Troubleshooting*

Hardware, software, or a combination of both can cause computer problems. When you encounter any problem, it might be a typical problem that can easily be solved.

This chapter tells you what actions to take when solving common computer problems. It is divided into three sections:

- Preliminary checklist
- Solving common problems
- Resetting the computer

## Preliminary Checklist

Here are helpful hints to follow before you take further actions when you encounter any problem:

- Try to isolate which part of the computer is causing the problem.
- Make sure that you turn on all peripheral devices before turning on the computer.
- If an external device has a problem, make sure that the cable connections are correct and secure.
- Make sure that the configuration information is properly set in the SCU program.
- Make sure that all the device drivers are correctly installed.
- Make notes of your observations. Are there any messages on the screen? Do any indicators light? Do you hear any beeps? Detailed descriptions are useful to the service personnel when you need to consult one for assistance.

If any problem persists after you follow the instructions in this chapter, contact an authorized dealer for help.

## Solving Common Problems

For easy reference, the problems are divided into these categories.

| <b>Problem Type</b>         | <b>Go to</b> |
|-----------------------------|--------------|
| Battery problems            | P. 8-4       |
| Optical drive problems      | P. 8-5       |
| Display problems            | P. 8-5       |
| Floppy disk drive problems  | P. 8-7       |
| Hardware device problems    | P. 8-7       |
| Hard disk drive problems    | P. 8-8       |
| Infrared problems           | P. 8-8       |
| Keyboard and mouse problems | P. 8-9       |
| LAN problems                | P. 8-10      |
| WLAN problems               | P. 8-10      |
| Modem problems              | P. 8-12      |
| PC card problems            | P. 8-12      |
| Power Management problems   | P. 8-13      |
| Printer problems            | P. 8-14      |
| Software problems           | P. 8-14      |
| Sound problems              | P. 8-15      |
| Startup problems            | P. 8-16      |
| Other problems              | P. 8-17      |

## Battery Problems

### **The battery does not charge (Battery Charge indicator does not appear).**

- Make sure that the AC adapter is properly connected.
- Make sure that the battery is not too hot – gets above 45°C (113 °F) or too cold – below 0 °C (32 °F). Allow time for the battery pack to return to room temperature.
- Make sure that the battery pack is installed correctly.
- Make sure that the battery terminals are clean.

### **The operating time of a fully charged battery becomes shorter.**

- If you often partially recharge and discharge, the battery might not be charged to its full potential. Initialize the battery to solve the problem. (See “Initializing the Battery Pack” in Chapter 3 for instructions.)
- Make sure that power to the Tablet PC is off. If you use the Tablet PC during recharging for more than 4 hours, the recharging will stop no matter whether the battery has been fully charged or not. If this happens, you can disconnect and then reconnect the AC adapter to start the recharging again.

### **The battery operating time indicated by the battery meter does not match the actual operating time.**

- The actual operating time can be different from the estimated time, depending on how you are using the computer. If the actual operating time is much less than the estimated time, initialize the battery. (See “Initializing the Battery Pack” in Chapter 3 for instructions.)

## Optical Drive Problems

### **The optical drive cannot read a disc.**

- Make sure that the disc is correctly seated in the tray, with the label facing up.
- Make sure that the disc is not dirty. Clean the disc with a disc cleaning kit, available in most computer stores.
- Make sure that the optical drive driver is installed correctly.
- Make sure that the computer supports the disc or the file format contained.

### **You cannot eject a disc.**

- The disc is not properly seated in the drive. Manually release the disc following the method described next:
  - Turn off the system.
  - Insert a small rod, such as a straightened paper clip, into the drive's manual eject hole and push firmly to release the tray.
  - Pull the tray out until fully extended, and then remove the disc.

## Display Problems

### **Nothing appears on the screen.**

- If the power-on indicator is not on, check the electrical outlet, the plugs and power cords.
- If the power button  does not respond to a light touch, press the button firmly.
- If you are using battery power, make sure that it has a charge remaining and that it is installed correctly.
- During operation, the screen may automatically turn off as a result of power management. Press any key to see if the screen comes back.

- The brightness level might be too low. Increase brightness by pressing on the brightness/volume control button on the front panel of the Tablet PC.
- The display output might be set to an external monitor.
- Reset the Tablet PC by pressing Ctrl+Alt+Del keys if you are using an external keyboard.
- Try turning the computer off, wait a few seconds, then turn it back on.

**The characters on the screen are dim.**

- Adjust the brightness.

**Bad dots appear on the display at all times.**

- A small number of missing, discolored, or bright dots on the screen are an intrinsic characteristic of TFT LCD technology. It is not regarded as a LCD defect. The Inspection Standard generally agreed in the LCD industry allows a maximum of 8 pixels on a unit.

**Term definition:**

*Bright dots* When the LCD screen is lighted, dots appear bright at a dark area. Red/green/blue bright dots also count.

*Dark dots* When the LCD screen is lighted, dots appear black at bright areas.

*Distance between defective dots* The minimum distance between two defective dots.

*Adjacent defective dots* Defective dots within a radius of 10 mm.

**Resolution cannot be adjusted to desired setting.**

- Make sure that the video driver is installed correctly.

**The external monitor displays nothing.**

- Make sure that the monitor is turned on.
- Make sure that the monitor's signal cable is properly connected.

**Simultaneous display does not work.**

- Make sure that you turn on the external monitor before turning on the computer.

## Floppy Disk Drive Problems

**The Floppy Disk Drive In-use Indicator stays on.**

- Make sure that the floppy disk is not physically damaged.
- Make sure that the floppy disk is inserted correctly.

**The disk drive cannot write to a floppy disk.**

- Make sure that the floppy disk is formatted.
- Make sure that the floppy disk is not write-protected.
- Make sure that you are writing to the correct drive.
- Make sure that there is enough space left on the floppy disk.
- Make sure that the floppy disk is not physically damaged.

**The disk drive cannot read a floppy disk.**

- Make sure that the floppy disk is formatted.
- Make sure that you are reading the correct drive.

## Hardware Device Problems

**The computer does not recognize a newly installed device.**

- The device may not be correctly configured in the SCU program. Run the SCU program to identify the new type.
- Make sure if any device driver needs to be installed. (Refer to the documentation that came with the device.)
- Make sure if the device needs any jumper or switch settings. (Refer to the documentation that came with the device.)
- Check the cables or power cords for correct connections.



- For an external device that has its own power switch, make sure that the power is turned on.

## Hard Disk Drive Problems

### **The hard disk drive error message appears on the screen.**

- Insert a bootable diskette and check the integrity of your hard drive.
- The hard disk drive has defects. Ask your dealer for help.

### **The hard disk drive operations seem slow.**

- The data files stored on the hard disk drive may be fragmented. Use a tool such as Window's **Disk Defragmenter** to defragment the files.

### **The hard disk drive in-use indicator glows without blinking.**

- The data files stored on the hard disk drive may be fragmented. Use a tool such as Window's **Disk Defragmenter** to defragment the files.

## Infrared Problems

### **The IR port does not work.**

- Make sure that the IR ports of the two device face each other within a  $\pm 15$ -degrees angle and 1 meter (3 feet) distance and there are no obstructions in between.
- Make sure that the device connected is using an equivalent speed.
- Make sure that the IrDA Fast Infrared Port is set to HP HSDL-2300/3600.
- Make sure that the IR port is set correctly in the SCU program.
- If you are printing to an infrared printer, make sure that the appropriate driver is installed.
- If you are using any file transfer functions, make sure that both the computer and the IR device have the appropriate software running.

- Make sure that there is no device radiating infrared rays, such as remote-controlled devices or wireless headphones, near the computer or device.
- Make sure that no direct sunlight or fluorescent lamps are near the computer or device.
- Make sure that the IR ports are clean.
- Make sure that the IR device's internal power (batteries) is adequate or connected to AC power.

## Keyboard and Mouse Problems

### **The external keyboard does not respond.**

- Try connecting another external keyboard. If it works, replace the former keyboard as it may be defective.
- Make sure that the keyboard cable is properly connected.
- Make sure that the wireless keyboard's internal batteries have adequate power.

### **The numeric keypad is disabled.**

- Make sure that the Num Lock is switched on. (Check if the Num Lock Indicator  appears or not.)

### **The PS/2 mouse does not work.**

- Make sure that the mouse cable is properly connected.

### **The serial mouse does not work.**

- Make sure that the mouse cable is properly connected.
- Make sure that you connect the mouse before booting the computer.

## LAN Problems

### **I cannot access the network.**

- Make sure that the LAN driver is correctly installed.

- Make sure that the LAN cable is properly connected to the RJ-45 connector and the network hub.
- Make sure that the network configuration is appropriate.
- Make sure that the user name or password is correct.

## WLAN Problems

### **I cannot use the WLAN feature.**

- Make sure that the Mini PCI WLAN card is correctly installed.
- Make sure that the necessary driver(s) is correctly installed.
- Make sure that the WLAN feature is turned on.

### **Transmission quality is poor.**

- Your computer may be in an out-of-range situation. Move your computer closer to the Access Point or another WLAN device it is associated with.
- Check if there is high interference around the environment and solve the problem as described next.

### **Radio interference exists.**

- Move your computer away from the device causing the radio interference such as microwave oven and large metal objects.
- Plug your computer into an outlet on a different branch circuit from that used by the affecting device.
- Consult your dealer or an experienced radio technician for help.

### **I cannot connect to another WLAN device.**

- Make sure that the WLAN feature is turned on.
- Make sure that the SSID setting is the same for every WLAN device in the network.
- Your computer is not recognizing changes. Restart the computer.
- Make sure that the IP address or subnet mask setting is correct.

**I cannot communicate with the computer in the network when Infrastructure mode is configured.**

- Make sure that the Access Point your computer is associated with is powered on and all the LEDs are working properly.
- If the operating radio channel is in poor quality, change the Access Point and all the wireless station(s) within the BSSID to another radio channel.
- Your computer may be in an out-of-range situation. Move your computer closer to the Access Point it is associated with.
- Make sure that your computer is configured with the same security option (encryption) to the Access Point.
- Use the Web Manager/Telnet of the Access Point to check whether it is connected to the network.
- Reconfigure and reset the Access Point.

**I cannot access the network.**

- Make sure that the necessary driver(s) is correctly installed.
- Make sure that the network configuration is appropriate.
- Make sure that the user name or password is correct.
- You have moved out of range of the network.
- Turn off power management.

## Modem Problems

**The modem does not work.**

- Make sure that the modem driver is correctly installed.
- Make sure that the telephone line is properly connected.
- Make sure that the COM port in the communication software is correctly set.
- Turn off power management.

## PC Card Problems

### The PC card does not work.

- Make sure that the PC card is correctly seated.
- If the card requires an IRQ (Interrupt ReQuest), make sure that there is one available.
- The PC card may be attempting to use a COM port in a manner that conflicts with the COM port being used by another device. Try running the SCU program to change the COM port setting. If your PC card uses COM1, set COM1 as *Disabled*. If your PC card uses COM2, set COM2 as *Disabled*. If your PC card uses COM4, set COM4 as *Disabled*.

**WARNING:** COM3 is reserved for use by the touchscreen, do not disable it. If COM1/2 is disabled and COM3/4 is enabled on the SCU Setup (refer to chapter 5), upon booting system would recognize the enabled COM3/4 and designate it as COM1/2.

The following table is the default settings:

| COM Port                             | I/O (Input/Output) Port | IRQ (Interrupt ReQuest) |
|--------------------------------------|-------------------------|-------------------------|
| COM1 (available)                     | 3F8                     | IRQ4                    |
| COM2 (available)                     | 2F8                     | IRQ3                    |
| COM3 (reserved for touchscreen only) | 3E8                     | IRQ5                    |
| COM4 (available)                     | 2E8                     | IRQ11                   |

### The PC card stops communicating properly.

- The application may have been reset when the computer is turned off or in Standby mode. Exit and restart the application.

## Power Management Problems

### The computer does not enter Standby or Suspend mode automatically.

- If you have a connection to another computer, the computer does not enter Standby or Suspend mode if the connection is actively in use.
- Make sure that the Standby or Suspend time-out is enabled.

**The computer does not enter Standby or Suspend mode immediately.**

- If the computer is performing an operation, it normally waits for the operation to finish.

**The computer does not resume from Standby or Suspend mode.**

- The computer automatically enters Standby or Suspend mode when the battery pack is empty. Do any one of the following:
  - Connect the AC or car adapter to the computer.
  - Replace the empty battery pack with a fully charged one.

**The computer does not enter Suspend mode.**

- You might be using a PC card that prevents the computer from entering Suspend mode. To enter the mode, stop the communication program and then remove the card or stop the card.

## Printer Problems

**The printer does not work.**

- Make sure that the printer is turned on (if it comes with an independent power source) and is online (ready to use).
- Make sure that the printer's signal cable is properly connected.
- Make sure that the printer driver is correctly installed.
- Make sure that you have assigned the printer port correctly in your operating system or application program.
- Make sure that the printer port is enabled in the SCU program.

**The printer prints garbled information.**

- Make sure that the printer driver is correctly installed.
- Make sure that the printer cable is properly connected.

## Software Problems

### **An application program does not work correctly.**

- Make sure that the software is correctly installed.
- If an error message appears on the screen, consult the software program's documentation for further information.
- If you are sure the operation has stopped, reset the computer. (See "Resetting the Computer" in this chapter.)

## Sound Problems

### **No sound is produced.**

- Make sure that the volume control is not set too low.
- Make sure that the audio and volume control drivers are correctly installed.
- Make sure that the computer is not in Standby mode.
- If using an external speaker, make sure that the speaker is properly connected.

### **Distorted sound is produced.**

- Make sure that the volume control is not set too high or too low. In most cases, a high setting can cause the audio electronics to distort the sound.

### **The sound system does not record.**

- Adjust the playback or recording sound levels.

### **The external microphone or audio device does not work.**

- Make sure that the microphone is connected to the proper connector on the computer.
- Make sure that your computer is equipped with the driver needed.
- Click the speaker symbol on the taskbar and check the Windows volume control.

- Check the volume control of your computer.

## Startup Problems

### **When you turn on the computer, it does not respond and the Power Indicator does not appear.**

- If you are using an external AC power, make sure that the AC adapter is correctly and securely connected. If so, make sure that the electrical outlet works properly.
- If you are using the battery power, make sure that the battery is not discharged.
- Check your settings for the item **Power Button Define** on the SCU Setup's "Advanced menu." It might be set at  $\downarrow$  *Power* necessitating a combination of pressing the speaker volume / LCD brightness down arrow key located on the front panel plus the power button to be able to turn on/off system power

### **When you turn on the computer, it stops after POST.**

- Restart your computer.

### **The message "Operating system not found" appears on the screen after you turn on the computer.**

- Make sure that there is no floppy disk in the floppy disk drive. If there is, remove it and restart the system.
- If this message appears when you are booting from the hard disk, insert a bootable disk in the floppy disk drive and check the condition of the hard disk.

### **The message "Invalid system disk" or "Disk error" appears on the screen after you turn on the computer.**

- If you are deliberately trying to boot from a floppy disk, replace the disk with a bootable one and press any key to continue booting.
- If you are booting from the hard disk, make sure that there is no floppy disk in the floppy disk drive. If there is, remove it and restart the system.



- If this message appears when you are booting from the hard disk, insert a bootable disk in the floppy disk drive and check the condition of the hard disk.

## Other Problems

### **The date/time is incorrect.**

- Correct the date and time via the operating system or SCU program.
- After you have performed everything as described above and still have the incorrect date and time every time you turn on the computer, the RTC (Real-Time Clock) battery is at the end of its life. Call an authorized dealer to replace the RTC battery.

## Resetting the Computer

You may have to reset (reboot) your computer on some occasions when an error occurs and the program you are using hangs up.

If the system operation seems to hang up, first wait. It is possible that the system is processing data. Periodically check the hard disk drive in-use indicator, if it flashes irregularly, the program may be accessing data and preventing you from using the keyboard. If you are sure the operation has stopped and you cannot use the “restart” function of the operating system, reset the computer.

Reset the computer by any one of these method:

- Press **Ctrl+Alt+Del** if you have an external keyboard connected.
- If the above action does not work, turn off the system. Wait for at least five seconds and turn it on again.

**CAUTION:** Resetting will cause any unsaved data to be lost.

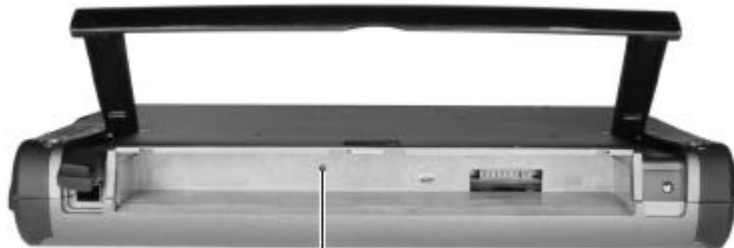

*Reset Button Switch*



# Specifications

**NOTE:** Specifications are subject to change without any prior notices.

| Parts                        |                   | Specifications                                                                                                                                                                                         |
|------------------------------|-------------------|--------------------------------------------------------------------------------------------------------------------------------------------------------------------------------------------------------|
| CPU                          |                   | Intel Pentium M processor LV, 1.1 GHz in $\mu$ -FCBGA package<br>FSB (Front Side Bus) 400 MHz, thermal ceiling 12 W                                                                                    |
| L2 Cache Memory              |                   | 1 MB on-die                                                                                                                                                                                            |
| ROM BIOS                     |                   | 512 KB Flash EEPROM (system and VGA BIOS), Plug-and-Play capability, ACPI 2.0 capability, boot from IDE devices / LAN / USB optical drive, Suspend-to DRAM/HDD support, PC2001-compliant               |
| RAM                          | System            | One 200-pin PC2100 DDR SO-DIMM socket (200/266 MHz),<br>256 MB SDRAM (standard), up to 1 GB                                                                                                            |
|                              | Shared video      | Up to 64 MB                                                                                                                                                                                            |
| Display                      | Panel             | 10.4-inch TFT XGA LCD (touchscreen), resolution up to 1024×768,<br>sunlight readable (transflective) – option                                                                                          |
|                              | Video controller  | Integrated into Intel 855GM, integrated 32-bit 3D/2D gfx core with<br>Dynamic Video Memory technology, supports DirectX®8.1 and AGP<br>4×, dual view function, LCD/CRT simultaneous display capability |
|                              | Video port        | VGA port via optional Port Replicator or Vehicle Docking Station<br>modules                                                                                                                            |
| Keyboard (external/wireless) |                   | Waterproof membrane (rubber) keyboard or<br>IP54 ruggedized keyboard with backlight function – option,<br>standard keys, numeric keypad, 12 function keys, and Windows keys                            |
| Pointing device              |                   | Touch-sensitive LCD panel with Microsoft WinMouse function<br>coexisting / digitizer panel LCD                                                                                                         |
| Storage device               | Floppy disk drive | 3.5-inch, 1.44 MB (via optional USB FDD module on Expansion port)                                                                                                                                      |
|                              | Hard disk drive   | Integrated 2.5-inch, 9.5 mm height, IDE, Ultra DMA-33/66/100<br>support with damper protect                                                                                                            |
|                              | Optical drive     | CD/Combo/DVD-RW (via optional module on Expansion port)                                                                                                                                                |
| Audio                        | Audio controller  | Realtek ALC202 codec, AC97 support, MS-Sound compatibility,<br>built-in mono speaker                                                                                                                   |
|                              | Audio port        | Two audio ports for Mic-in / Line-out                                                                                                                                                                  |

| Parts             |                                   | Specifications                                                                                                                       |
|-------------------|-----------------------------------|--------------------------------------------------------------------------------------------------------------------------------------|
| PC card           |                                   | Type II × 1, CardBus support                                                                                                         |
| I/O ports         | On main system                    | Serial port, USB port, docking port, IR port for wireless keyboard/mouse, RJ-11 fax/modem port                                       |
|                   | On Port Replicator module         | Serial port × 2, ECP/EPP parallel port × 1, USB 1.1 port × 2, VGA port × 1, PS/2 port (mouse and keyboard), Mic in, Line out         |
|                   | On Office Docking module          | Serial port × 2, ECP/EPP parallel port × 1, USB 2.0 port × 4, VGA port × 1                                                           |
|                   | On Vehicle Docking Station module | Serial port × 1, ECP/EPP parallel port × 1, USB 1.1 ports × 2, VGA port × 1, PS/2 port (mouse and keyboard), Mic-in, Line-out        |
|                   | On underside                      | CCD port (USB-type)                                                                                                                  |
| Modem             |                                   | 56 Kbps V.90 internal fax modem                                                                                                      |
| Wireless modem    |                                   | GPRS/GSM/GPS – option                                                                                                                |
| LAN               |                                   | Fast Ethernet, 10/100Base-T                                                                                                          |
| Wireless LAN      |                                   | 802.11b, supports Intel PRO / Wireless 2100 LAN mini-PCI type 3B adapter and Intel PROset software                                   |
| Power             | AC adapter                        | 100–240 V AC, 50/60 Hz                                                                                                               |
|                   | Battery pack                      | Li-ion battery, 6 cells                                                                                                              |
|                   | Car adapter                       | 12~32 V DC                                                                                                                           |
| Dimension (W×D×H) |                                   | 11.7×9.4×1.7 inch (297×238×44 mm)                                                                                                    |
| Weight            |                                   | 5.3 lb (2.4 kg) – with backup and main battery packs                                                                                 |
| Environment       | Temperature                       | Operating: 0 °C (32 °F) to 50 °C (122 °F)<br>–20 °C (–4 °F) to 50 °C (122 °F) – option<br>Storage: –40 °C (–40 °F) to 70 °C (158 °F) |
|                   | Humidity                          | Operating: 5% to 95% RH, non-condensing                                                                                              |

## ***Regulatory Information***

This appendix provides regulatory statements and safety notices on your computer.

**NOTE:** Marking labels located on the exterior of your computer indicate the regulations that your model complies with. Please check the marking labels and refer to the corresponding statements in this appendix. Some notices apply to specific models only.

# On the Use of the System

## Class B Regulations

### USA

#### Federal Communications Commission Radio Frequency Interference Statement

#### **NOTE:**

This equipment has been tested and found to comply with the limits for a Class B digital device pursuant to Part 15 of the FCC Rules. These limits are designed to provide reasonable protection against harmful interference in a residential installation. This equipment generates, uses, and can radiate radio frequency energy and, if not installed and used in accordance with the instructions, may cause harmful interference to radio communications. However, there is no guarantee that interference will not occur in a particular installation. If this equipment does cause harmful interference to radio or television reception, which can be determined by turning the equipment off and on, the user is encouraged to try to correct the interference by one or more of the following measures:

- Reorient or relocate the receiving antenna.
- Increase the separation between the equipment and receiver.
- Connect the equipment into an outlet on a circuit different from that to which the receiver is connected.
- Consult the dealer or an experienced radio/TV technician for help.

Any changes or modifications not expressly approved by the manufacturer could void the user's authority to operate the equipment.

#### **Please note:**

The use of a non-shielded interface cable with this equipment is prohibited.

## Canada

Canadian Department of Communications  
Radio Interference Regulations Class B Compliance Notice

This Class B digital apparatus meets all requirements of the Canada Interference-Causing equipment regulations.

Cet appareil numérique de Classe B respecte toutes les exigences du Règlement Canadien sur le matériel brouilleur.

This digital apparatus does not exceed the Class B limits for radio noise emissions from digital apparatus set out in the Radio Interference Regulations of the Canadian Department of Communications.

Le présent appareil numérique n' émet pas de bruits radioélectriques dépassant les limites applicables aux appareils numériques de la classe B prescrites dans le Règlement sur le brouillage radioélectrique édicté par le ministère des Communications du Canada.

## Safety Notices

### About the Battery

#### Caution Texts Concerning Lithium Batteries

##### **DANISH**

ADVARSEL! Lithiumbatteri – Eksplosionsfare ved fejlagtig håndtering. Udskiftning må kun ske med batteri af samme fabrikat og type. Levér det brugte batteri tilbage til leverandøren.

##### **NORWEGIAN**

ADVARSEL: Eksplosjonsfare ved feilaktig skifte av batteri. Benytt samme batteritype eller en tilsvarende type anbefalt av apparatfabrikanten. Brukte batterier kasseres i henhold til fabrikantens instruksjoner.

##### **SWEDISH**

VARNING: Explosionsfara vid felaktigt batteribyte. Använd samma batterityp eller en ekvivalent typ som rekommenderas av apparattillverkaren. Kassera använt batteri enligt fabrikantens instruktion.

##### **FINNISH**

VAROITUS: Paristo voi räjähtää, jos se on virheellisesti asennettu. Vaihda paristo ainoastaan valmistajan suosittelemaan tyyppiin. Hävitä käytetty paristo valmistajan ohjeiden mukaisesti.



**ENGLISH**

**CAUTION:** Danger of explosion if battery is incorrectly replaced. Replace only with the same or equivalent type recommended by the equipment manufacturer. Discard used batteries according to manufacturer's instructions.

**DEUTSCH**

**VORSICHT:** Explosionsgefahr bei unsachgemäßem Austausch der Batterie. Ersatz nur durch denselben oder einen vom Hersteller empfohlenen gleich-wertigen Typ. Entsorgung gebrauchter Batterien nach Angaben des Herstellers.

**FRENCH**

**ATTENTION:** Il y a danger d'explosion s'il y a remplacement incorrect de la batterie. Remplacer uniquement avec une batterie du même type ou d'un type équivalent recommandé par le constructeur. Mettre au rebut les batteries usagées conformément aux instructions du fabricant.

### Attention (for USA Users)

The product that you have purchased contains a rechargeable battery. The battery is recyclable. At the end of its useful life, under various state and local laws, it may be illegal to dispose of this battery into the municipal waste stream. Check with your local solid waste officials for details in your area for recycling options or proper disposal.

### About the AC Adapter

- Use only the AC adapter supplied with your computer. Use of another type of AC adapter will result in malfunction and/or danger.
- Do not use the adapter in a high moisture environment. Never touch the adapter when your hands or feet are wet.
- Allow adequate ventilation around the adapter when using it to operate the device or charge the battery. Do not cover the AC adapter with paper or other objects that will reduce cooling. Do not use the AC adapter while it is inside a carrying case.
- Connect the adapter to a proper power source. The voltage requirements are found on the product case and/or packaging.
- Do not use the adapter if the cord becomes damaged.
- Do not attempt to service the unit. There are no serviceable parts inside. Replace the unit if it is damaged or exposed to excess moisture.

## About the Modem

### Caution

- Never install telephone wiring during a lightning storm.
- Never install telephone jacks in wet locations unless the jack is specifically designed for wet locations.
- Never touch non-insulated telephone wires or terminals unless the telephone line has been disconnected at the network interface.
- Use caution when installing or modifying telephone lines.
- Avoid using the telephone function (other than a cordless type) during an electrical storm. There may be a remote risk of electric shock from lightning.
- Do not use the telephone function to report a gas leak in the vicinity of the leak.
- Do not use this product near water, for example near a bathtub, wash bowl, kitchen sink or laundry tub, in a wet basement or near a swimming pool.

### Caution (for USA Users)

To reduce the risk of fire, use only No.26 AWG or larger telecommunication line cord.

## On the Use of RF Device

**NOTE:** The information in this section applies to models with the wireless LAN module.

### USA and Canada Safety Requirements and Notices

**IMPORTANT NOTE:**

The antenna must not be co-located or operating in conjunction with any other any antenna or transmitter.

### Radio Frequency Interference Requirements and SAR

The FCC with its action in ET Docket 93-62 has adopted a safety standard for human exposure to Radio Frequency (RF) electromagnetic energy emitted by FCC certified equipment. The wireless LAN module meets the Human Exposure limits found in OET Bulletin 65, 2001, and ANSI/IEEE C95.1, 1992. Proper operation of this radio according to the instructions found in this manual will result in exposure substantially below the FCC's recommended limits. The following safety precautions should be observed:

- Do not touch or move antenna while the unit is transmitting or receiving.
- Do not hold any component containing the radio such that the antenna is very close or touching any exposed parts of the body, especially the face or eyes, while transmitting.
- Do not operate the radio or attempt to transmit data unless the antenna is connected; if not, the radio may be damaged.

Use in specific environments:

- The use of wireless devices in hazardous locations is limited by the constraints posed by the safety directors of such environments.
- The use of wireless devices on airplanes is governed by the Federal Aviation Administration (FAA).

- The use of wireless devices in hospitals is restricted to the limits set forth by each hospital.

#### Antenna use:

- The antenna must not be co-located or operating in conjunction with any other any antenna or transmitter.
- High-gain, wall-mount, or mast-mount antennas are designed to be professionally installed and should be located at a minimum distance of 30 cm (12 inches) or more from the body of all persons. Please contact your professional installer, VAR, or antenna manufacturer for proper installation requirements.

#### Explosive Device Proximity Warning

**WARNING:** Do not operate a portable transmitter (such as a wireless network device) near unshielded blasting caps or in an explosive environment unless the device has been modified to be qualified for such use.

#### Antenna Warning

**WARNING:** To comply with the FCC and ANSI C95.1 RF exposure limits, it is recommended that the antenna for this device be installed so as to provide a separation distance of at least 20 cm (8 inches) from all persons and that the antenna must not be co-located or operating in conjunction with any other antenna or radio transmitter. It is recommended that the user limit exposure time if the antenna is positioned closer than 20 cm (8 inches).

#### Use on Aircraft Caution

**CAUTION:** Regulations of the FCC and FAA prohibit airborne operation of radio-frequency wireless devices because their signals could interfere with critical aircraft instruments.

## EMC Requirements

This device uses, generates and radiates radio frequency energy. The radio frequency energy produced by this device is well below the maximum exposure allowed by the Federal Communications Commission (FCC).

This device complies with the limits for a Class B digital device pursuant to Part 15 subpart C of the FCC Rules and Regulations. Operation is subject to the following two conditions:

- (1) This device may not cause harmful interference.
- (2) This device must accept any interference received, including interference that may cause undesired operation.

The FCC limits are designed to provide reasonable protection against harmful interference when the equipment is installed and used in accordance with the instruction manual and operated in a commercial environment. However, there is no guarantee that interference will not occur in a particular commercial installation, or if operated in a residential area.

If harmful interference with radio or television reception occurs when the device is turned on, the user must correct the situation at the user's own expense. The user is encouraged to try one or more of the following corrective measures:

- Reorient or relocate the receiving antenna.
- Increase the separation between the equipment and receiver.
- Connect the equipment into an outlet on a circuit different from that to which the receiver is connected.
- Consult the dealer or an experienced radio/TV technician for help.

**CAUTION:** The Part 15 radio device operates on a non-interference basis with other devices operating at this frequency. Any changes or modification to said product not expressly approved by the manufacturer could void the user's authority to operate this device.

## Canada Radio Frequency Interference Requirements

To prevent radio interference to the licensed service, this device is intended to be operated indoors and away from windows to provide maximum shielding. Equipment (or its transmit antenna) that is installed outdoors is subject to licensing.

Pour empêcher que cet appareil cause du brouillage au service faisant l'objet d'une licence, il doit être utilisé à l'intérieur et devrait être placé loin des fenêtres afin de fournir un écran de blindage maximal. Si le matériel (ou son antenne d'émission) est installé à l'extérieur, il doit faire l'objet d'une licence.

## European Union CE Marking and Compliance Notices

### Statements of Compliance

#### **English**

This product follows the provisions of the European Directive 1999/5/EC.

#### **Danish**

Dette produkt er i overensstemmelse med det europæiske direktiv 1999/5/EC.

#### **Dutch**

Dit product is in navolging van de bepalingen van Europees Directief 1999/5/EC.

#### **Finnish**

Tämä tuote noudattaa EU-direktiivin 1999/5/EC määräyksiä.

#### **French**

Ce produit est conforme aux exigences de la Directive Européenne 1999/5/EC.

#### **German**

Dieses Produkt entspricht den Bestimmungen der Europäischen Richtlinie 1999/5/EC.

**Greek**

Το προϊόν είναι σύμφωνο με την οδηγία 1999/5/ΕΚ.

**Icelandic**

Þessi vara stendur í samræmi við Eyrópska Efnahags Bandalagsins númer 1999/5/EC.

**Italian**

Questo prodotto è conforme alla Direttiva Europea 1999/5/EC.

**Norwegian**

Dette produktet er i henhold til bestemmelsene i det europeiske direktivet 1999/5/EC.

**Portuguese**

Este produto cumpre com as normas da Diretiva Europeia 1999/5/EC.

**Spanish**

Este producto cumple con las normas del Directivo Europeo 1999/5/EC.

**Swedish**

Denna produkt har tillverkats i enlighet med EG-direktiv 1999/5/EC.

## Local Restrictions of 802.11b Radio Usage

**CAUTION:** Due to the fact that the frequencies used by 802.11b wireless LAN devices may not yet be harmonized in all countries, 802.11b products are designed for use only in specific countries or regions, and is not allowed to be operated in countries or regions other than those of designated use. As a user of these products, you are responsible for ensuring that the products are used only in the countries or regions for which they were intended and for verifying that they are configured with the correct selection of frequency and channel for the country or region of use. Any deviation from permissible settings and restrictions in the country or region of use could be an infringement of local law and may be punished as such.

The European variant is intended for use throughout the European Economic Area. However, authorization for use is further restricted in particular countries or regions within countries, as follows:

## General

European standards dictate maximum radiated transmit power of 100 mW Effective Isotropic Radiated Power (EIRP) and the frequency range 2400 – 2483.5 MHz.

## Belgium and the Netherlands

In Belgium and the Netherlands, the product may not be used outdoors. See the instructions next under the heading “How to Turn Off the Wireless LAN.”

## France

### **Departments in Which the Wireless LAN Module Can Be Used (Indoors Only)**

The wireless LAN module can currently be used indoors only in the following 38 departments of mainland France. Please turn off your wireless LAN radio when operating the device in areas/places other than the 38 departments listed:

|    |                |    |                     |    |                       |
|----|----------------|----|---------------------|----|-----------------------|
| 01 | Ain Orientales | 36 | Indre               | 66 | Pyrénées              |
| 02 | Aisne          | 37 | Indre et Loire      | 67 | Bas Rhin              |
| 03 | Allier         | 41 | Loir et Cher        | 68 | Haut Rhin             |
| 05 | Hautes Alpes   | 42 | Loire               | 70 | Haute Saône           |
| 08 | Ardennes       | 45 | Loiret              | 71 | Saône et Loire        |
| 09 | Ariège         | 50 | Manche              | 75 | Paris                 |
| 11 | Aude           | 55 | Meuse               | 82 | Tarn et Garonne       |
| 12 | Aveyron        | 58 | Nièvre              | 84 | Vaucluse              |
| 16 | Charente       | 59 | Nord                | 88 | Vosges                |
| 24 | Dordogne       | 60 | Oise                | 89 | Yonne                 |
| 25 | Doubs          | 61 | Orne                | 90 | Territoire de Belfort |
| 26 | Drôme          | 63 | Puy du Dôme         | 94 | Val de Marne          |
| 32 | Gers           | 64 | Pyrénées Atlantique |    |                       |



**Departments in Which the Wireless LAN Module's Maximum EIRP Not Shown in the Previous Table**

| <b>Frequency Ranges (MHz)</b> | <b>Indoors</b> | <b>Outdoors</b>                                              |
|-------------------------------|----------------|--------------------------------------------------------------|
| 2400 – 2446.5                 | 10 mW          | Not permitted                                                |
| 2446.5 – 2483.5               | 100 mW         | 100 mW on private property with Ministry of Defense approval |

### Turning Off the Wireless LAN Radio

**NOTE:** Turning the wireless LAN radio off is not the same as disabling the wireless LAN card. It is not necessary to disable the card to meet the regulatory requirements.

While operating the computer in those French departments that do not allow use of the wireless LAN equipment, the user of the equipment must turn off the wireless LAN radio in order to comply with local regulations (see chapter 2 for more information).