

A790
Operation Manual

Part Number:
(July 2006)

R00



TRADEMARKS

All brand and product names are trademarks or registered trademarks of their respective companies.

NOTE

Information in this manual is subject to change without notice.



Table of Contents

Preface	vii
Chapter 1 Getting Started.....	1-1
Getting the Computer Running.....	1-2
Unpacking	1-2
Connecting to AC Power	1-2
Opening the Cover	1-4
Turning On and Off the Computer	1-5
Taking a Look at the Computer.....	1-6
Right-Side Components.....	1-6
Left-Side Components	1-7
Rear Components	1-8
Front Components.....	1-10
Top-open Components.....	1-11
Where to Go from Here.....	1-13
Chapter 2 Operating Your Computer.....	2-1
Starting and Stopping the Computer	2-2
Starting the Computer.....	2-2
Stopping the Computer.....	2-2
Using the Keyboard.....	2-4
Typewriter Keys	2-4
Cursor-Control Keys	2-5
Numeric Keypad.....	2-5

Euro Symbol	2-6
Windows Keys	2-6
Function Keys	2-6
Fn Key.....	2-7
Hot Keys.....	2-7
Using the Touchpad	2-9
Configuring the Touchpad.....	2-11
Using the Touchscreen (Optional).....	2-12
Using the Hard Disk Drive	2-14
Replacing the Hard Disk Drive.....	2-14
Using the Video Features	2-17
Configuring the Display Modes	2-17
Using the Audio Features	2-19
Connecting Audio Devices	2-20
Using the Communication Features.....	2-21
Using the LAN.....	2-21
Using the Wireless LAN (Optional).....	2-22
Using the Modem.....	2-25
Using the Wireless Modem (Optional)	2-26
Using the GPS (Optional)	2-27
Using the Bluetooth Feature (Optional).....	2-28
Chapter 3 Managing Power	3-1
AC Adapter.....	3-2
Battery Pack	3-3
Charging the Battery Pack.....	3-3
Initializing the Battery Pack.....	3-4
Checking the Battery Level	3-5
Replacing the Primary Battery Pack	3-5
Battery Low Signals and Actions	3-7
Power Management.....	3-8
Hibernation.....	3-9
Power-Saving Tips	3-10

Chapter 4 Expanding Your Computer	4-1
Connecting an External Monitor.....	4-2
Connecting a Parallel Device.....	4-3
Connecting a Serial Device	4-4
Connecting an IR Device	4-5
Connecting a USB Device	4-7
Connecting an IEEE 1394b Device.....	4-8
Using PC Cards.....	4-9
PC Card Type.....	4-9
CardBus Support.....	4-9
Inserting and Removing a PC Card.....	4-9
System Memory Upgrade.....	4-11
Chapter 5 Setup Configuration Utility (SCU).....	5-1
When and How to Use the SCU Program	5-2
When to Use	5-2
Starting SCU.....	5-2
Moving Around and Making Selections.....	5-4
Main Menu.....	5-5
Advanced Menu.....	5-6
Intel Menu	5-7
Security Menu.....	5-8
Boot Menu	5-9
Exit Menu	5-10
Chapter 6 Installing Software Drivers	6-1
How to Use the Driver CD	6-2
Touchscreen Driver	6-6
Chapter 7 Caring for the Computer	7-1
Protecting the Computer	7-2
Using the Cable Lock.....	7-2
Using an Anti-Virus Strategy	7-2
Taking Care of the Computer.....	7-3

Location Guidelines	7-3
General Guidelines	7-3
Cleaning Guidelines.....	7-4
Battery Pack Guidelines	7-4
When Traveling	7-5
Chapter 8 Troubleshooting	8-1
Preliminary Checklist.....	8-2
Solving Common Problems	8-3
Battery Problems	8-4
Bluetooth Problems	8-4
Display Problems.....	8-5
Hardware Device Problems.....	8-6
Hard Disk Drive Problems.....	8-6
Infrared Problems.....	8-7
Keyboard, Mouse and Touchpad Problems	8-7
LAN Problems.....	8-8
WLAN Problems	8-8
Modem Problems	8-10
PC Card Problems	8-10
Power Management Problems.....	8-11
Printer Problems.....	8-11
Software Problems	8-12
Sound Problems	8-12
Startup Problems	8-13
Other Problems	8-13
Resetting the Computer	8-14
Appendix A Specifications.....	A-1
Appendix B Regulatory Information.....	B-1
On the Use of the System.....	B-2
Class B Regulations	B-2
Safety Notices.....	B-3
On the Use of RF Device	B-6

USA and Canada Safety Requirements and Notices B-6
European Union CE Marking and Compliance Notices ... B-9

Preface

This manual contains information that will help you operate the computer. It is divided into 8 chapters and 2 appendices.

- Chapter 1, **Getting Started**, takes you through the process of setting up the computer and identifying its external components.
- Chapter 2, **Operating Your Computer**, tells you how to use the computer's components and features.
- Chapter 3, **Managing Power**, provides information on power.
- Chapter 4, **Expanding Your Computer**, provides information on installing and using peripheral devices.
- Chapter 5, **SCU (Setup Configuration Utility)**, describes the SCU program that configures the computer's BIOS settings.
- Chapter 6, **Installing Software Drivers**, describes how to install the drivers and utilities supplied with the computer.
- Chapter 7, **Caring for the Computer**, gives you tips in care and maintenance.
- Chapter 8, **Troubleshooting**, gives solutions to common problems you may encounter when using the computer.
- Appendix A, **Specifications**, gives a brief specification of the computer.

- Appendix B, **Regulatory Information**, provides regulatory statements and safety notices on your computer.

Notational Conventions

Throughout this manual, the following conventions are used to distinguish elements of text.

| **NOTE:** identifies additional information that requires special attention.

| **CAUTION:** identifies important information which, if not followed, may result in loss of data or damage to the computer.

Keyboard keys are shown in a bold typeset. For example:

Press **Enter** to complete.

When keys are joined by a plus sign (+), press the first key, and, while keeping the first key down, press the remaining keys, finally release all the keys. When necessary, keys are also shown in graphics.

A title, command, setup item, or button that you can see on the screen is shown in boldface. A value or an option that you can select for a setup item is shown in italic. For example:

Select **Power Management**, set it to *Enabled*, and then click the **OK** button.

Getting Started

Congratulations on purchasing this computer.

This high performance notebook computer is especially designed for the practical applications of warehouses, automobiles, vehicles, public security, repairing, assisting the handicapped, and other demanding situations where conventional notebook computers just cannot measure up.

This chapter first tells you step by step how to get the computer up and running. You will find instructions for these procedures:

- Unpacking
- Connecting to AC power
- Opening the cover
- Turning on the computer
- Turning off the computer

Then, you will find a section briefly introducing the external components of the computer. And the last section navigates you to the information you may need after the computer is ready for use.

Getting the Computer Running

This section guides you through the procedures for getting the computer ready for operation.

Unpacking

After unpacking the shipping carton, you should find these standard items:

- Notebook computer
- Accessories:
 - AC adapter (100~240 VAC, 50/60 Hz)
 - AC power cord (US/CE/UK/SA)
 - Driver CD
 - This *Operation Manual*

Inspect all the items. If any item is damaged or missing, notify your dealer immediately.

Keep the shipping carton and packing materials in case you need to ship or store the computer in the future.

Connecting to AC Power

The computer operates either on the external AC power or internal battery power. It is suggested that you use AC power when you start up the computer for the first time.

CAUTION: Use only the AC adapter included with your computer. Using other AC adapters may damage the computer.

NOTE:

Power Supply Cord: (optional) Detachable, minimum 1.5 m long. Listed, rated minimum 125 V, 7 A, having a 2/18 AWG, type SVT flexible cord. One end terminates with a parallel blade, molded-on, attachments plug with a 7 A, 125 V (NEMA 1-15P) configuration; other end terminates with a molded-on appliance coupler.

Alternative: (optional) Detachable, maximum 4.5 m (14.76 ft) long. Listed, rated minimum 250 V, 6 A, having a 3/18 AWG, type SVT flexible cord. One end terminates with a Tandem blade, grounding, listed molded-on, attachments plug with a 6 A, 250 V (NEMA 6-15P) configuration; other end terminates with a molded-on appliance coupler.

1. Make sure the computer is turned off.
2. Plug the DC cord of the AC adapter to the power connector on the rear side of the computer (❶) .
3. Plug the female end of the AC power cord to the AC adapter and the male end to an electrical outlet (❷) .



4. When the AC adapter is connected, the indicator on the AC adapter lights up, indicating that power is being supplied from the electrical outlet to the AC adapter and onto your computer. Now, you are ready to turn on the computer.

CAUTION:

- When you disconnect the AC adapter, disconnect from the electrical outlet first and then from the computer. A reverse procedure may damage the AC adapter or the computer.
- When unplugging the connector, always hold the plug head. Never pull on the cord.

NOTE: When the AC adapter is connected, it also charges the battery pack. For information on using battery power, see Chapter 3.

Opening the Cover

CAUTION: Be gentle when opening and closing the cover. Opening it vigorously or slamming it shut could damage the computer.

1. Open the top cover by pulling on the cover latch.
2. Lift up the cover. You can tilt the cover forward or backward for optimal viewing clarity.



Turning On and Off the Computer

Turning On

1. Make sure the computer is connected to AC power.
2. Press the power button.



3. Each time the computer is turned on, it performs a Power-On Self Test (POST), and the operating system such as Windows should start.

Turning Off

To turn off the computer power, use the “Shut Down” command of your operating system.

NOTE: There are other ways you can stop the computer so that you will be back to where you left off when you next turn on the computer. (See “Stopping the Computer” in Chapter 2 for information.)

CAUTION: If you have to turn the computer on again immediately after turning it off, wait for at least five seconds. Turning the computer off and on rapidly can damage it.



Taking a Look at the Computer

This section identifies the external components of the computer and briefly describes the function of each component.

NOTE: Depending on the model you purchased, the appearance of your computer may not exactly be the same as those shown in this manual.

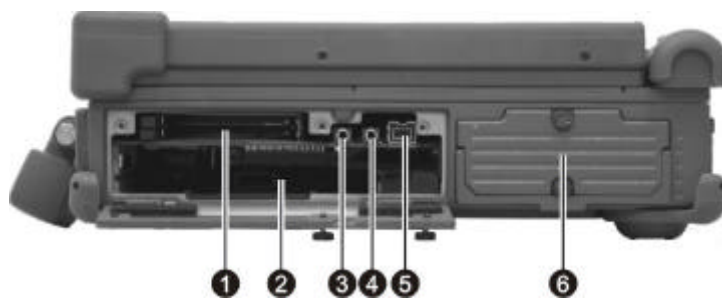
Right-Side Components



Ref	Component	Description	See Also
①	PC Card Slot	Accepts a PC card for additional functions.	P. 4-9
②	???	???	
③	Audio Output Connector 	Connects a set of headphones, external speakers with amplifier, or an audio recording device.	P. 2-20
④	Microphone Connector 	Connects an external microphone.	P. 2-20
⑤	IEEE 1394B Port	Connects a 1394B device such as a mass storage device, digital video (DV) camcorder, or a digital audio device.	P. 4-8
⑥	Hard Disk Drive Compartment	Contains the hard disk drive of your computer.	P. 2-14

Left-Side Components



Ref	Component	Description	See Also
①	Bay2 Slot	May contain an extra battery pack or wireless modem (GPRS/GSM, CDMA) module.	
②	Battery Pack	Supplies power to your computer when external power is not connected.	P. 3-3

Rear Components

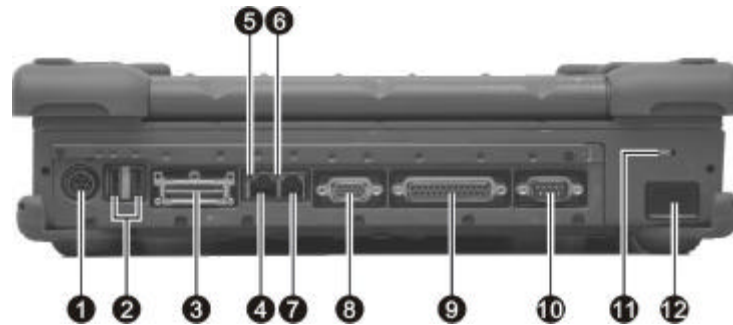

Ref	Component	Description	See Also
①	Power Connector	Connects the AC adapter.	P. 1-3
②	USB Ports	Each of the two ports connects a USB device, such as a USB floppy drive, USB flash disk, printer, digital camera, joystick, and more.	P. 4-7
③	Docking Port	For connecting to a Port Replicator / car mount (both are available as an option).	
④	RJ-45 Connector	Connects the LAN cable. Includes a Link Indicator and an Active Indicator.	P. 2-21
⑤	Active Indicator	Blinks green when the system is accessing the LAN.	P. 2-21
⑥	Link Indicator	Glow green when the system has an available connection to LAN.	P. 2-21
⑦	RJ-11 Connector	Connects the telephone line.	P. 2-25
⑧	VGA Port	Connects an external CRT monitor.	P. 4-2
⑨	Parallel Port	Connects a parallel device, such as a printer.	P. 4-3

Ref	Component	Description	See Also
⑩	Serial Port	Connects a serial device, such as an external modem.	P. 4-4
⑪	Kensington Lock	Locks the computer to a stationary object for security.	P. 7-2
⑫	IR Port	Connects an IrDA-compliant device for wireless data transfer.	P. 4-5

Front Components









Ref	Component	Description	See Also
①	Top Cover Latch	Locks the top cover.	P. 1-4
②	Stereo Speaker Set	Sends out sound and voice from the computer.	P. 2-19
③	Handle	Allows you to carry your computer for an easy grip.	

Top-open Components



Ref	Component	Description	See Also
1	LCD Screen	Displays the output of the computer. Can also have the optional touchscreen function.	P. 2-17 P. 2-12

Ref	Component	Description	See Also
2	Device Indicators	Show the current status of the computer's devices.	
		Scroll Lock indicator	P. 2-4
		Caps Lock indicator	P. 2-4
		Num Lock indicator	P. 2-6
		Hard disk drive in-use indicator	P. 2-14
		Battery charge indicator – Glow green when the battery is fully charged and connected to AC power. Glow amber (orange) when the battery is being charged.	P. 3-3
		Battery power indicator – Glow green when the computer is using battery power. Glow amber (orange) when the optional Bay1/Bay2 battery pack's capacity is under 5 %. Blink amber (orange) when the primary battery packs capacity is under 5 % even when the other battery pack is fully charged.	P. 3-3
		Power on / Standby mode indicator – Glow green when the computer is turned ON. Glow orange when the computer is in Standby mode.	P. 1-5
3	Power Button	Turns the computer power ON and OFF.	P. 1-5
4	Keyboard	Serves as the data input device of the computer.	P. 2-4
5	Touchpad	Serves as the pointing device of the computer.	P. 2-9

Where to Go from Here

As your computer is ready for operation, you may want to do any of the following now:

For this purpose...	Do this...
To know more about the computer...	Go on to the next chapter.
To install the operating system if your dealer has not already done so...	See the operating system manual.
To know more about the operating system...	Read the operating system manual.
To install the drivers if your dealer has not already done so...	See Chapter 6.
To charge the battery pack for the first time...	See “Charging the Battery Pack” in Chapter 3.



Operating Your Computer

This chapter provides information about the use of the computer.

If you are new to computers, reading this chapter will help you learn the operating basics. If you are already a computer user but are new to notebook computers, you may choose to read only the parts containing information unique to your computer.

Described in this chapter are the operating basics of these components:

- Keyboard
- Touchpad
- Touchscreen
- Hard disk drive

And these features:

- Starting and stopping the computer
- Video features
- Audio features
- Communication features

Starting and Stopping the Computer

There are a number of ways to start and stop the computer.

Starting the Computer

You always start the computer using the power button.

A computer starts up with an operating system (OS) existing on the storage device such as the hard disk; or from a CD disc if you have the respective modules installed. The computer will automatically load the OS after you turn it on. This process is called booting.

NOTE: An operating system is the platform for all your software application programs to run on. The most widely used operating system today is Microsoft Windows.

Stopping the Computer

When you finish a working session, you can stop the computer by turning off the power or leaving the computer in Standby or Hibernation mode:

To stop in this mode...	Do this...	To start up or resume again
Off	Follow the shutdown procedure of your operating system. This can prevent loss of unsaved data or damage to your software programs. If the system is locked up because of hardware or software problems, press the power button to turn off the computer.	Press the power button.
Standby	Depending on your settings in Windows, you can place the computer in Standby mode by: <ul style="list-style-type: none">• Closing the display cover• Pressing Fn+F12• Pressing the power button	Press any key.

To stop in this mode...	Do this...	To start up or resume again
Hibernation	Depending on your settings in Windows, you can place the computer in Hibernation mode by: <ul style="list-style-type: none">• Closing the display cover.• Pressing Fn+F12• Pressing the power button	Press the power button.

If you choose to stop in Standby or Hibernation mode, you can return to where you left off the next time you start up the computer. (See “Power Management” in Chapter 3 for more information.)

Using the Keyboard

NOTE: Your computer features backlight for your keyboard to help you see the keyboard keys during poor lighting conditions. Press **Fn+F8** to turn it on/off (see Hot Keys later in this chapter).

Your special shower-proof and dust-proof rubber keyboard has all the standard functions of a full-sized computer keyboard plus an **Fn** key added for specific functions.

The standard functions of the keyboard can be further divided into four major categories:

- Typewriter keys
- Cursor-control keys
- Numeric keys
- Function keys

Typewriter Keys

Typewriter keys are similar to the keys on a typewriter. Several keys are added such as the **Ctrl**, **Alt**, **Esc**, and lock keys for special purposes. When the lock keys (**Caps Lock**, **Num Lock**, and **Scroll Lock**) are pressed, their corresponding indicators light up.

The Control key is normally used in combination with other keys for program-specific functions. The Alternate key is normally used in combination with other keys for program-specific functions. The Escape key is usually used for stopping a process. Examples are exiting a program and canceling a command. The function depends on the program you are using.

Cursor-Control Keys



NOTE: The word “cursor” refers to the indicator on the screen that lets you know exactly where on your screen anything you type will appear. It can take the form of a vertical or horizontal line, a block, or one of many other shapes.

Numeric Keypad

A 15-key numeric keypad is embedded in the typewriter keys as shown next:



Numeric keys facilitate entering of numbers and calculations. When Num Lock is on, the numeric keys are activated; meaning you can use these keys to enter numerals.

NOTE:



- When the numeric keypad is activated and you need to type the English letter in the keypad area, you can turn Num Lock off or you can press **Fn** and then the letter without turning Num Lock off.
- Some software may not be able to use the numeric keypad on the computer. If so, use the numeric keypad on an external keyboard instead.



Euro Symbol

You can press the Euro dollar sign € on the keyboard.

- To press the Euro sign on the keyboard, hold down either of the **Alt** keys and type **0128** on the numeric keypad of your keyboard.
- To press the Euro sign on an UK keyboard, hold down the **Alt Gr** key and press **4** (which has an Euro sign on it).

Windows Keys

The keyboard has two keys that perform Windows-specific functions:  Windows Logo key and  Application key.

The  Windows Logo key opens the Start menu and performs software-specific functions when used in combination with other keys. The  Application key usually has the same effect as a right mouse click. (See your Windows manual for more information.)

Function Keys

On the top row of the keys are the function keys: **F1** to **F12**. Function keys are multi-purpose keys that perform functions defined by individual programs.













Fn Key





The Fn key, at the lower left corner of the keyboard, is used with another key to perform the alternative function of a key. The letter “Fn” and the alternative functions are identified by the color of blue on the keytop. To perform a desired function, first press and hold Fn, then press the other key.

Hot Keys

Hot keys refer to a combination of keys that can be pressed any time to activate special functions of the computer. Most hot keys operate in a cyclic way. Each time a hot key combination is pressed, it shifts the corresponding function to the other or next choice.

You can easily identify the hot keys with the icons imprinted on the keytop. The hot keys are described next.

Key	Description
 	Decreases the sound volume.
 	Increases the sound volume.
 	Decreases the LCD brightness.
 	Increases the LCD brightness.
 	Switches the GPS function on and off. NOTE: This function works only if an optional Bay2 module with GPS function is installed.
 	Switches the optional keyboard backlight function on/off with 10 levels of brightness in-between.

Key	Description
	<p>Switches the display output to one of the following when an external device is connected.</p> <p>Upon booting the system with CRT:</p> <pre> graph LR LCD --> LCD_CRT[LCD & CRT] LCD_CRT --> CRT CRT --> LCD </pre> <p>Upon booting the system with DVI:</p> <pre> graph LR LCD --> LCD_DVI[LCD & DVI] LCD_DVI --> DVI DVI --> LCD </pre> <p>NOTE:</p> <ul style="list-style-type: none"> • When in full screen DOS mode, or when playing DVD or MPEG file, display switching is not allowed. • If the display mode is set to 256 colors or lower, or in DOS mode, there will be only two modes for selecting: CRT only and LCD & CRT. • This function only applies to Plug & Play CRT monitors.
	<p>Switches the display off and on.</p>
	<p>Switches the LCD backlight on and off.</p>
	<p>Serves as the sleep button that you can define with Windows' Power Management. (See the "Power Management" in Chapter 3.)</p>

Using the Touchpad

CAUTION: Do not use a sharp object such as a pen on the touchpad. Doing so may damage the touchpad surface.

NOTE: For optimal performance of the touchpad, keep your fingers and the pads clean and dry. When tapping on the pad, tap lightly. Do not use excessive force.

The touchpad is a pointing device that allows you to communicate with the computer by controlling the location of the pointer on the screen and making selection with the buttons.



The touchpad consists of a rectangular pad and two buttons. To use the touchpad, place your forefinger or thumb on the pad. The rectangular pad acts like a miniature duplicate of your display. As you slide your fingertip across the pad, the pointer (also called cursor) on the screen moves accordingly. When your finger reaches the edge of the pad, simply relocate yourself by lifting the finger and placing it on the other side of the pad.

Here are some common terms that you should know when using the touchpad:

Term	Action
Point	Move your finger on the pad until the cursor points to the selection on the screen.
Click	Press and release the left button. –or– Tap gently anywhere on the pad.
Double-click	Press and release the left button twice in quick succession. –or– Tap twice on the pad rapidly.
Drag and drop	Press and hold the left button, then move your finger until you reach your destination (drag). Finally, release the button (drop) when you finish dragging your selection to the destination. The object will drop into the new location. –or– Gently tap twice on the pad and on the second tap, keep your finger in contact with the pad. Then, move your finger across the pad to drag the selected object to your destination. When you lift your finger from the pad, the selected object will drop into place.
Scroll	To scroll is to move up and down or left and right in the working area on the screen. The scroll button located between the two buttons under the touchpad can be used to move vertically in a convenient way. Press the upper part of the scroll button to move up and the lower part of the scroll button to move down. –or– To move vertically, place your finger on the right edge of the pad and slide your finger up and down along the edge. To move horizontally, place your finger on the bottom edge of the pad and slide your finger left and right.

TABLE NOTE: If you swap the left and right buttons, “tapping” on the touchpad as an alternative method of pressing the left button will no longer be valid.

Configuring the Touchpad

You may want to configure the touchpad to suit your needs. For example, if you are a left-handed user, you can swap the two buttons so that you can use the right button as the left button and vice versa. You can also change the size of the on-screen pointer, the speed of the pointer, and so on.

To configure the touchpad, you can use the standard Microsoft or IBM PS/2 driver if you are using Windows to take advantage of more powerful features.

Using the Touchscreen (Optional)

CAUTION: Do not use a sharp object such as a ballpoint pen or pencil on the touchscreen. Doing so may damage the touchscreen surface.

The touchscreen is a touch-sensitive device that allows you to communicate with the computer by controlling the location of the pointer on the screen and making selection with the buttons.



The touchscreen needs a special device driver support that allows you to easily use the computer without a mouse or touchpad (see chapter 6 for details).

Here are some common terms that you should know when using the touchscreen:

Term	Action
Click/Point	Tap gently on the touchscreen.
Double-click	Tap twice on the touchscreen rapidly.

Term	Action
Drag and drop	Press lightly on the touchscreen and move your finger until you reach your destination (drag). Finally, release your finger (drop) when you finish dragging your selection to the destination. The object will drop into the new location.
Scroll	<p>To scroll is to move up and down or left and right in the working area on the screen.</p> <p>To move vertically, place your finger on the right edge of the touchscreen and slide your finger up and down along the edge. To move horizontally, place your finger on the bottom edge of the touchscreen and slide your finger left and right.</p> <p>This function works only after you install the touchscreen driver supplied with the computer and it may not work for all applications.</p>

Using the Hard Disk Drive

Your computer comes with a hard disk drive as drive C. A hard disk drive is a storage device with non-removable, rotating, magnetic storage platters inside it. It is where your operating system and application software programs are stored.

Your hard disk drive is a 2.5-inch IDE (Integrated Drive Electronics) hard disk drive that features a built-in G-sensor to prevent damage during an accidental drop. This type of drive embodies the latest in fast, reliable mass storage by integrating all the control circuitry necessary for operation directly onto the drive itself. This allows the drive manufacturer to carefully optimize drive performance.

The system may come with an optional built-in heater that automatically turns on for low temperature operation.

CAUTION:

- Make regular backups of your data files from your hard disk drive to CD discs or other storage media.
- Never try to remove or install the hard disk drive while the computer is powered on. Doing so can result in loss of data, and can damage the computer and the hard disk drive's sensitive circuitry.
- Never turn off or reset the computer while the hard disk drive in-use indicator is on.

Replacing the Hard Disk Drive

To replace the hard disk drive:

1. Make sure that system power is off.
2. Remove the battery pack (see chapter 3 for details).
3. Locate the hard disk drive slot on the right side of the system.

4. Remove the two screws securing the hard disk drive compartment.



5. Lift up the handle and pull on it to remove the hard disk drive compartment.



6. Remove the two screws securing the hard disk drive to the compartment and remove the steel plate cover.



7. Lift up the hard disk drive from the compartment and replace it with a new one.



8. Replace the steel plate cover and replace the two screws to secure the hard disk drive to the compartment.



9. Replace the hard disk drive compartment to the computer and secure with two screws.
10. Replace the battery pack.

Using the Video Features

The video subsystem of your computer features:

- 12.1/14.1-inch TFT (Thin-Film Transistor) color LCD display with 1024×768 XGA (eXtended Graphics Array) resolution, or optional 14.1-inch TFT (Thin-Film Transistor) color LCD display with 1400×1050 SXGA+ / SXGA (Super eXtended Graphics Array) resolution
- 64 MB video memory shared with system memory
- LCD backlight to help you see the display during poor lighting conditions. Press **Fn+F11** to turn it on/off (see Hot Keys in this chapter).
- Simultaneous display on LCD and external monitor, which is useful when you have a presentation as you can control the screen from your computer and face the audience at the same time.
- Dual view capability, which allows you to expand your desktop on the screen to another display device so that you have more desktop space to work on.
- Power Management.
- Sunlight-readable LCD display (option).

NOTE:

- To take advantage of the enhanced video capabilities and before using the dual view capability, the device driver supplied with your computer must be installed (see chapter 6 for details).
- System enters Standby/Hibernation mode when the LCD is closed. If you want to use the computer with the LCD closed, set *Do Nothing* to the “When I close the lid of my portable computer” option in the **Power Options** Properties. Thus the computer does not enter Standby or Hibernation mode when the LCD is closed.

Configuring the Display Modes

Your computer has been set to a default resolution and number of colors before shipment. You can view and change display settings through your operating system. See your operating system documentation or online help for specific information.

For displaying in higher resolutions, you can connect an external CRT monitor that supports higher resolutions. (See “Connecting an External Monitor” in Chapter 4 for more information.)

The following table lists the display modes supported by your computer.

Display Mode		LCD Only	CRT Only	Simultaneous Display
Resolution	Colors			
800×600	16-bit	√	√	√
	32-bit	√	√	√
1024×768	16-bit	√	√	√
	32-bit	√	√	√

TABLE NOTE:

- 16-bit = High Color or 65,536 (64 K) colors; 32-bit = True Color 16,770,000 (16 M) colors.
- When using CRT only, the resolution would depend on the supported resolution by the CRT.

Using the Audio Features

NOTE:

- To take advantage of the enhanced audio capabilities, the device driver supplied with your computer must be installed (see chapter 6 for details).
- If you experience interference while recording, try lowering the microphone recording volume.

The audio subsystem of your computer features:

- External audio connectors (❶) and
- A set of speakers (❷)



Ways of playing and recording sound vary with the operating system used. See your operating system documentation or online help for specific information.

Connecting Audio Devices



For higher audio quality, you can send or receive sound through external audio devices.

- **Audio Output Connector** (🔊) can be connected to the line-in connector of powered speakers with built-in amplifiers, headphones, or earphone set.
- **Microphone Connector** (🎤) can be connected to an external microphone for recording voice or sound.

NOTE: When using external speakers/headphones or microphone, you cannot use the internal one.

Using the Communication Features

Using the LAN

NOTE: To take advantage of the LAN feature, the device driver supplied with your computer must be installed (see chapter 6 for details).

The internal 10/100/1000Base-T Ethernet LAN (Local Area Network) module allows you to connect your computer to a network. It supports data transfer rate up to 1000 Mbps.

To connect the network cable to the LAN module, connect one end of the LAN cable to the RJ-45 connector on the computer and the other end to the network hub.



- | | |
|------------------|--|
| Active Indicator | Blinks green when the system is accessing the LAN. |
| Link Indicator | Glowes green when the system has an available connection to LAN. |



Using the Wireless LAN (Optional)

Depending on your model, an internal Mini PCI wireless LAN (WLAN) card may have been pre-installed by your computer manufacturer at the factory. This card allows you to access corporate networks or the Internet in a wireless environment.

The WLAN features include:

- Peer-to-Peer (Ad-Hoc) and Access Point (Infrastructure) modes support
- WEP (Wired Equivalent Privacy) 64/128-bit data encryption
- IEEE 802.11 a/b/g standard compliance

Technology	802.11a	802.11b	802.11g
Stated Maximum Throughput (Mbps)	54	11	54
Data Rates (Mbps)	54, 48, 36, 24, 18, 12, 9, 6	11, 5.5, 2, 1	54, 36, 18, 9
Band (GHz)	5.15 ~ 5.35	2.412 ~ 2.462	2.4
Modulation Technology	OFDM (Orthogonal Frequency Division Multiplexing)	DSSS (Direct Sequence Spread Spectrum)	OFDM (Orthogonal Frequency Division Multiplexing)

| NOTE: 802.11g mode is backward compatible with 802.11b mode.

To take advantage of the WLAN feature, make sure that the WLAN driver is installed correctly (see chapter 6 for details). If your WLAN card was provided by your dealer instead of the computer manufacturer, contact your dealer for the correct driver to use.

Configuring the WLAN

After driver installation, you can use the WLAN utility to configure and monitor your WLAN connection. If you are using Windows XP, you can also use its built-in WLAN utility. Follow this procedure to launch the WLAN utility in Windows XP:

1. Select **Control Panel** from the **Start** menu.
2. Click **Network and Internet Connections**.
3. Click **Network Connections**, then double-click the **Wireless Network Connection** icon .
4. Click **Properties** in the **Wireless Network Connection Status** dialog box.
5. You can configure your WLAN settings in the **Wireless Network Connection Properties** dialog box.

Connecting to a Wireless Network

To connect to a wireless network:

1. Make sure that the WLAN radio is on.
2. Click **Start** and then **All Programs**.
3. Click **Intel PROSet Wireless** and then **Intel PROSet Wireless**.

4. If any wireless network is detected, the following window appears on screen.



5. Click to select a wireless network to connect to, and then click **Connect**.
6. Depending on the settings, you may be asked to enter a wireless security password (encryption key).

For more information on the Intel PROSet Wireless utility, click **Help?** in the **Intel(R) PROSet/Wireless** window.

It takes approximately 30 seconds for your computer to make a successful WLAN connection and approximately 10 seconds to disconnect.

Using the Modem

NOTE: To take advantage of the modem feature, the device driver supplied with your computer must be installed (see chapter 6 for details).

The internal 56 K fax/data modem allows you to use the telephone line to communicate with others by fax, email, or connect to an online service or bulletin board.

To connect the telephone line to the modem, connect one end of the modem cable to the RJ-11 connector on the computer and the other end to the phone line.



NOTE:

- When using communication software, you may have to disable power management.
- Set the COM port of the modem to COM3.
- Set parameters such as modem speed (baud rate) and line type (pulse dialing or tone dialing).
- Do not enter Standby mode when using communication software.

Using the Wireless Modem (Optional)

NOTE: To take advantage of the wireless modem feature, the USB-to-COM driver supplied with your computer must be installed (see chapter 6 for details).

Depending on your model, your computer includes an integrated GSM (Global System for Mobile Communications) / GPRS (General Packet Radio Service) feature.

After you establish a subscription with a GSM/GPRS service provider, you can use the wireless data features of your computer. Check with your service provider for a list of available wireless data services. Your service provider may charge additional fees for use of data services.

There are two methods for wirelessly connecting to an ISP or network:

- **GSM data transmission (circuit-switched data)**
GSM data services enable you to use the GSM component of your computer as a built-in modem. You can use the service to connect to the Internet through an ISP or dial in to a corporate network to browse the Web or send and receive e-mail messages.
- **GPRS data transmission**
GPRS is a high-speed data-on service that enables you to transmit data over a mobile network. Subscribing to a GPRS service allows you to transfer files, browse the Web and receive streaming audio and video on your computer.

Connecting Using the GSM Modem

Your computer can send and receive data via a mobile network using the GSM protocol.

To send or receive data over a GSM network, you must have an account with a service provider that supports GSM data services, and the service provider must enable the data features on your account.

To connect to an ISP or dial in to a specific computer, you must configure a connection for that service on your computer.

Connecting Using GPRS

Your computer can receive General Packet Radio Services (GPRS), a high-speed data-only service that transmits data over a mobile telephone network. In addition, GPRS provides permanent on-line connection.

To use GPRS, you must have a subscription to the function with a service provider that supports GPRS.

To connect to a GPRS network, you must configure a connection for that service on your computer.

Using the GPS (Optional)

NOTE: To take advantage of the GPS feature, the USB-to-COM driver supplied with your computer must be installed (see chapter 6 for details).

Navigation and positioning are crucial to so many activities. To try to figure out where you are and where you are going, you need GPS technology. The Global Positioning System (GPS) is a worldwide radio-navigation system.

Turning On/Off the GPS

Your computer has a built-in **Fn+F7** GPS hot key to switch the GPS on/off (see “Hot Keys” in this chapter).



Using the Bluetooth Feature (Optional)

NOTE: To take advantage of the Bluetooth feature, the Bluetooth driver supplied with your computer must be installed (see chapter 6 for details).

Depending on your model, your computer may incorporate the Bluetooth capability for short-range (about 10 meters) wireless communications between devices without requiring a cable connection.

With Bluetooth, data can be transmitted through walls, pockets and briefcases as long as two devices are within range. By default, your computer's Bluetooth feature is active (always ON) upon booting your computer and is in the general discoverable and pairable mode.



The status of the Bluetooth connection is indicated by the Bluetooth icon located in the system tray in the lower-right part of the screen.

Status	Icon
On	 (blue with white logo).
Connected	 (blue with green logo)

You can use the Bluetooth Utility to configure Bluetooth connection settings and transfer files.

Connecting to Another Bluetooth Device

1. Make sure that the target Bluetooth device is turned on, discoverable and within close range. (See the documentation that came with the Bluetooth device.)

2. Double-click the  icon, then click on **New Connection** or click on **Bluetooth**, then **Add New Connection . . .**
Or right-click the , and then click on **Add New Connection**.

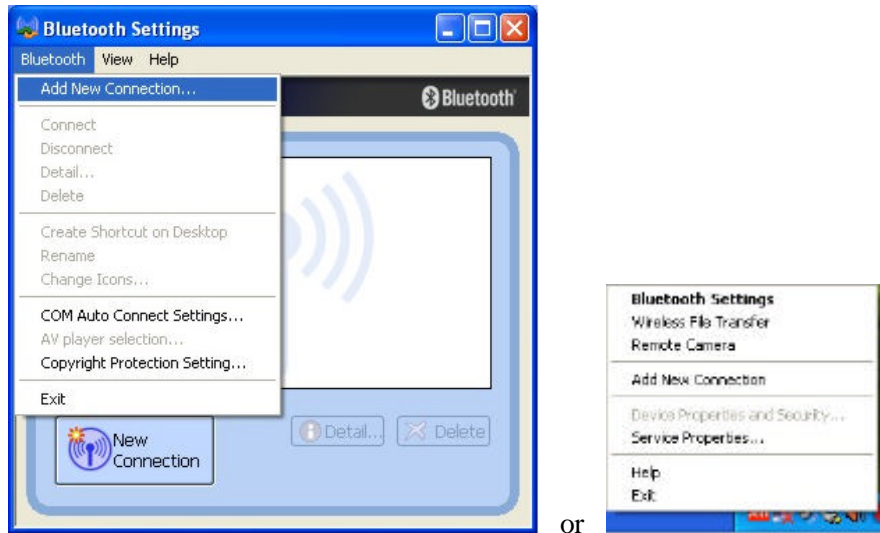

3. The **Add New Connection Wizard** window appears. Select **Express Mode (Recommended)**, then click on **Next**.



4. Select the device to connect to and click on **Next**.

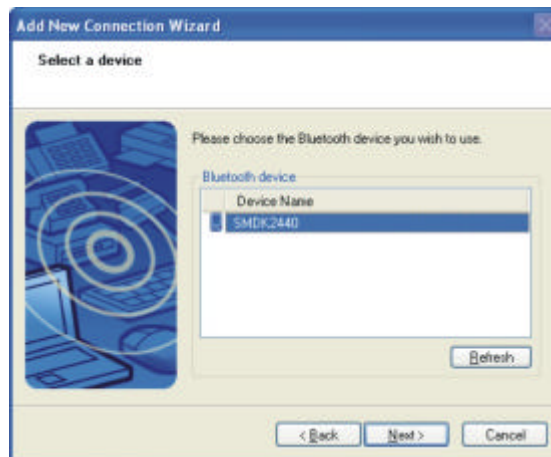

5. Depending on the type of Bluetooth device that you want to connect to, you will need to enter the pertinent information.

Sending a File

1. Right-click the  icon, and then click **Wireless File Transfer**. The following screen appears.

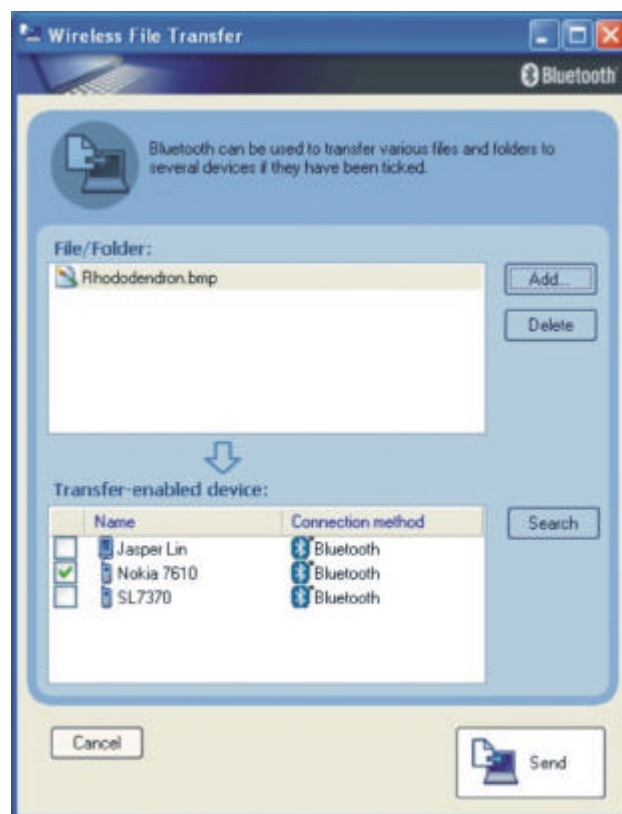

2. In the **Wireless File Transfer** window, click **Add** to browse for the file to send. The file(s) will show on the **File/Folder** window.
3. Click the target device from the **Transfer-enabled device** window, and then click **Send** to start the transfer procedure.

For detailed information on using the Bluetooth Utility, see the Bluetooth Utility Help on your computer by clicking on **Help**, then **Help . . .**



Managing Power

Your computer operates either on external AC power or internal battery power.

This chapter tells you how you can effectively manage power. To maintain optimal battery performance, it is important that you use the battery in the proper way.

The topics in this chapter include:

- What is an AC adapter
- How to charge the battery pack
- When and how to initialize the battery pack
- How to check the battery level
- How to replace the battery pack
- What happens when the battery is low and what actions to take
- What is Power Management
- How to save power

AC Adapter

CAUTION:

- The AC adapter is designed for use with your computer only. Connecting the AC adapter to another device can damage the adapter.
- The AC power cord supplied with your computer is for use in the country where you purchased your computer. If you plan to go overseas with the computer, consult your dealer for the appropriate power cord.
- When you disconnect the AC adapter, disconnect from the electrical outlet first and then from the computer. A reverse procedure may damage the AC adapter or computer.
- When unplugging the connector, always hold the plug head. Never pull on the cord.

The AC adapter serves as a converter from AC (Alternating Current) to DC (Direct Current) power because your computer runs on DC power, but an electrical outlet usually provides AC power. It also charges the battery pack when connected to AC power.

The AC adapter operates on any voltage in the range of 100 ~ 240 V AC.

Battery Pack

The Li-ion battery pack is the internal power source for the computer when the AC power is “Off” or not connected. It is rechargeable using the AC adapter. The removable battery pack, with on-line charge capacity, comes standard with your computer. It has 107 watt operating capacity.

The computer supports up to three Li-ion battery packs: Primary, Bay1, and Bay2 (Bay1 and Bay2 are optional).

The operating time of a fully charged battery pack depends on how you are using the computer. When your applications often access peripherals, you will experience a shorter operating time.

NOTE: Care and maintenance information for the battery is provided in the “Battery Pack Guidelines” section in Chapter 7.

Charging the Battery Pack

NOTE:

- Charging will not start if the battery's temperature is below 0 °C (32 °F) or above 50 °C (122 °F).
- The charging process will stop when the battery's temperature gets above 60 °C (140 °F). If this happens, the battery pack may be damaged. Please contact your dealer.
- During charging, do not disconnect the AC adapter before the battery has been fully charged; otherwise you will get a prematurely charged battery.

To charge the battery pack, connect the AC adapter to the computer and an electrical outlet. The Battery Charge Indicator () on the computer glows amber to indicate that charging is in progress. You are advised to keep the computer power off while the battery is being charged. When the battery is fully charged, the Battery Charge Indicator glows green.

The sequence of charging is Primary, then Bay1 and Bay2 battery packs.

The charging times are as follows:

Battery Type (2400 mah or more per cell)	Charging Time	
	Computer is Off	Computer is On and in Idle State
Primary (107 watt)	3.5 hours	4.7 hours
Bay1 (71 watt)	2.5 hours	3.5 hours
Bay2 (71 watt)	2.5 hours	3.5 hours

CAUTION: After the computer has been fully recharged, do not immediately disconnect and reconnect the AC adapter to charge it again. Doing so may damage the battery.

NOTE: The battery level may automatically lessen due to the self-discharge process (0.21 % per day), even when the battery pack is fully charged (100%). This happens no matter if the battery pack is installed in the computer.

Initializing the Battery Pack



You need to initialize a new battery pack before using it for the first time or when the actual operating time of a battery pack is much less than expected.

Initializing is the process of fully charging, discharging, and then charging. It can take several hours.

1. Make sure the computer power is turned off. Connect the AC adapter to fully charge the battery pack.
2. After the battery pack is fully charged, turn on the computer.
3. Disconnect the AC adapter and leave the computer on until the battery is fully discharged. The computer will shut down automatically.
4. Connect the AC adapter to fully charge the battery pack.

Checking the Battery Level

NOTE: Any battery level indication is an estimated result. The actual operating time can be different from the estimated time, depending on how you are using the computer.

You can check the approximate battery level using the battery meter function of the operating system. To read the battery level in Windows, click the  icon on the taskbar. (Click the  icon if the computer is using AC power.)

Replacing the Primary Battery Pack

CAUTION:

- There is danger of explosion if the battery is incorrectly replaced. Replace the battery only with the computer manufacturer's optional battery packs. Discard used batteries according to the dealer's instructions.
- Do not attempt to disassemble the battery pack.

If you often rely on battery power for a long period of time while traveling, you may consider the purchase of an additional battery pack from your dealer and keep it with you in a fully charged state as a backup.

To replace the primary battery pack, follow these steps:

1. Make sure the computer is not turned on or connected to AC power.
2. Locate the battery slot on the left side of the system.
3. Remove the two screws securing the battery pack to the computer.



4. Lift up the handle and pull on it to slide the battery pack off the computer.



5. Slide the front panel off the battery pack and replace it on a new battery pack.



6. Slide the new battery pack into the computer.
7. Replace the two screws to secure the battery pack on the computer.

Battery Low Signals and Actions

Battery Low occurs when the battery has approximately 10 % (Windows default setting) of its charge remaining. The computer gives warning beeps or messages and the Battery Power Indicator () blinks amber (orange) to alert you to take actions.

| NOTE: You can set up your threshold and signals of Battery Low under Windows.

Immediately save your data upon Battery Low. The remaining operating time depends on how you are using the computer. If you are using the audio subsystem, hard disk drive, or PC card the battery might run out of charge very quickly.

Always respond to Battery Low by placing your computer on Standby or Hibernation mode, turning off the computer, or connecting the AC adapter.

If you do not take any action, the computer will automatically hibernate and turn off.

| CAUTION: If you fail to save your data when the battery completely runs out of charge, then you lose your data.

Power Management

Your computer supports ACPI (Advanced Configuration and Power Interface) for power management. The power management feature allows you to reduce the power consumption for energy saving.

With an ACPI-compliant operating system such as Windows 2000 and Windows XP, power supply to different computer components is controlled on an as-needed basis. This allows maximum power conservation and performance at the same time.

In general, Windows' power management works in this way:

What...	When...
Power to the hard disk is turned off	When the hard disk has been idle for a set period.
Power to the display is turned off	When the display has been idle for a set period.
The computer enters Standby mode. The hard disk and display are turned off and the entire system consumes less power.	When the entire system has been idle for a set period.
	When you press Fn+F12 . *
	When you close the cover. *
The computer enters Hibernation mode. (See the next subsection for more information.)	When you press the power button. *
	When you press Fn+F12 . *
	When you close the cover. *

* depends on your settings in Windows.

For detailed information on power management, see Windows' Help.

Hibernation

Hibernation is a very useful feature. People frequently open many applications when they use computers. It takes some time to get all these applications open and running, and normally they all have to be closed before the system can be turned off.

When you use the hibernation feature, you do not have to close the applications. The computer stores the state of your computer to a file on the hard disk and then shut down. The next time you turn on your computer, you return to exactly where you left off.

Power-Saving Tips

In addition to your computer's automatic power management, you can do your part to maximize the battery's operating time by following these suggestions.

- Do not disable Power Management.
- Decrease the LCD brightness to the lowest comfortable level.
- If you work with an application that uses a PC card, exit the application when you finish using it.
- If you have a PC card installed, remove it when not in use. Some PC cards drain power even while they are inactive.
- Deactivate the application that uses the serial port or features wireless connectivity (LAN/WLAN/modem/GPS/Bluetooth) if you are not using it.
- Turn off the computer when you are not using it.

Expanding Your Computer

You can expand the capabilities of your computer by connecting other peripheral devices. When using a device, be sure to read the instructions accompanying the device together with the relevant section in this chapter.

This chapter gives guidelines on installing and using these devices:

- External monitor
- Parallel device
- Serial device
- IR device
- USB device
- IEEE 1394B device
- PC card

Connecting an External Monitor

If you want the benefits of a larger display screen with higher resolution, you can connect an external CRT monitor to your computer.

Follow this procedure to connect an external monitor:

1. Make sure that the computer is not turned on.
2. Plug the monitor's D-type signal connector to the computer's VGA port.



3. Plug one end of the monitor's power cord into the power socket on the monitor and the other end to an electrical outlet.
4. To use the monitor, turn on the monitor before turning on the computer.
5. The monitor should respond by default. If not, you can switch the display to the monitor or to both (simultaneous display), or to multi-display by pressing **Fn+F9**. In Windows, you can also change the display through the settings in **Display Properties**.
6. You can change display settings through your operating system. See your operating system documentation or online help for specific information.

CAUTION: Do not disconnect the external monitor while the computer is in Standby mode or Hibernation mode. If no external monitor is connected when the computer resumes, the LCD remains blank and the output is not displayed.

NOTE: Make sure that the device driver is installed correctly (see chapter 6 for details).

Connecting a Parallel Device

Your computer has a parallel port for connecting a parallel device such as printer. The port supports ECP (Extended Capabilities Port) and EPP (Enhanced Parallel Port) modes that turn the standard parallel port into a high-speed bi-directional peripheral port.

Follow this procedure to connect a parallel device:

1. Make sure the computer is not turned on.
2. Plug the parallel device's cable to the parallel port on the rear of the computer.



3. If the parallel device has independent power, plug its power cord into an electrical outlet.
4. If the parallel device has its own power switch, turn on the device before turning on the computer.

Connecting a Serial Device

Your computer has a serial port for connecting a serial device such as a serial mouse or modem.

Follow this procedure to connect a serial device:

1. Make sure the computer is not turned on.
2. Plug the device cable to the serial port on the rear of the computer.



3. Turn on the computer.

NOTE: Portable modems that derive power through the serial port cannot be used with the computer. Instead, use a modem that is powered by its own internal battery or external AC power.

Connecting an IR Device

Your computer has an IR (infrared) port for connecting an infrared-equipped device wirelessly such as another computer, printer, or PDA (Personal Digital Assistant).

When using the IR port of your computer to receive data:

Place the transmitting device where its IR port faces the IR port of your computer within the effective range – within ± 20 -degrees vertical angle and within ± 20 -degrees horizontal angle at no greater than 0.8~1.0 meter distance.

When using the IR port of your computer to transmit data:

Place the receiving device where the IR port of your computer faces its IR port within the effective range – within ± 15 -degrees vertical angle and within ± 15 -degrees horizontal angle at no greater than 0.8~1.0 meter distance.



To take advantage of the IR communications, you need third party software.

NOTE: During infrared communication, note the following:

- Do not move the computer and IR device.
- Do not enter Standby mode.
- Do not use a cell phone or another IR device near the computer.
- Avoid strong light such as sunlight or fluorescent light.
- Disable the screen saver.

Connecting a USB Device

Your computer has two USB ports that supports transfer rates up to 12 MB/s for USB 1.1 devices and 480 MB/s for USB 2.0 devices, such as digital camera, scanner, printer, modem, and mouse.

USB is specified to be an industry standard extension to the PC architecture. It supports “Plug-and-Play” technology so you can install and remove USB devices without turning off the computer. With its multiple connection capability, up to 127 devices can be connected in a daisy-chain configuration. In addition, you can use a USB hub that converts a single USB connector into multiple ports where USB devices can be connected.

To connect a USB device, simply plug the device cable to one of the USB ports.



Connecting an IEEE 1394B Device

NOTE:

- Your IEEE 1394B port will only function under Windows XP SP2. It is also Windows Vista ready.
- Make sure that the 1394B driver is installed correctly (see chapter 6 for details).
- To connect an IEEE 1394A (also known as FireWire 400) device to the computer's IEEE 1394B (also known as FireWire 800) port, you need an optional FireWire 800/FireWire 400 bilingual cable.

Your computer has an IEEE 1394B port for connecting IEEE 1394B devices.

IEEE 1394B is the next-generation serial bus standard, featuring high-speed data transfer that doubles the throughput of the original IEEE 1394A interface (from 400 Mbit/sec to 800 Mbit/sec) and dramatically increases the maximum distance of connections (up to 15 feet away, while a FireWire 800 optical repeater will connect devices up to 1000 meters (3300 feet) away). It allows connection of up to 63 devices. The applications include mass storage device, digital video (DV) camcorder, or a digital audio device.

To connect an IEEE 1394B device, prepare an IEEE 1394B cable. Plug the appropriate end of the cable to the computer's IEEE 1394B connector and the other end to the device's corresponding connector.



Using PC Cards

Your computer has a PC card slot.

PC cards are credit card-sized peripheral products based on the standards developed by PCMCIA (Personal Computer Memory Card International Association). PCMCIA is a non-profit association for promoting the interchangeability among mobile computers where ruggedness, low power, and small size are critical. Ever since its foundation, the association has been continuing their efforts to add new specifications to the PC card standard as new needs arise in the market.

PC Card Type

Your computer's PC card slot can accommodate two type II cards or a type III card. Type II cards are typically used for I/O devices such as data/fax modems, LANs, and mass storage devices. Type III cards are used for devices whose components are thicker, such as rotating mass storage devices. Extended cards allow the addition of components that must remain outside the system for proper operation, such as antennas for wireless applications.

CardBus Support

Your computer's PC card slot supports CardBus specifications. CardBus is the 32-bit version of PC card technology. It allows speeds of up to 133 Mbps at 33 MHz. Typical applications are SCSI host bus and high-speed network cards.

Inserting and Removing a PC Card

NOTE:

- Some PC cards require additional system resources. Before using such PC card, you may have to free other system resources for the PC card.
- Although some PC cards can be inserted and removed without turning off the computer, you cannot remove or install PC cards in the Standby mode.

To insert a PC card:

1. Locate the PC card slot on the right side of the computer.
2. Slide the PC card, with its label facing up, into the slot until the eject button pops out.



3. When a new card is seated, the computer will detect it and try to install the appropriate driver. Follow the on-screen instructions to complete the process.

To remove a PC card:

1. Double-click the **Safely Remove Hardware**  icon on the taskbar and the **Safely Remove Hardware** window appears on screen.
2. Select the PC card you want to disable from the list and click the **Stop** button.
3. Push the eject button and the card will slide out slightly.
4. Pull the card out of the slot.

System Memory Upgrade

You can upgrade your computer by changing system memory to a maximum of 2 GB on the two 200-pin DDR2 SO-DIMM slots. However, to avoid damage during the installation procedure, please ask your dealer for help.



Setup Configuration Utility (SCU)

SCU is a program for configuring the BIOS (Basic Input/Output System) settings of the computer.

BIOS is a layer of software, called firmware, that translates instructions from other layers of software into instructions that the computer hardware can understand. The BIOS settings are needed by your computer to identify the types of installed devices and establish special features.

This chapter tells you how to use the SCU program.

When and How to Use the SCU Program

When to Use

You need to run the SCU program when:

- You see an error message on the screen requesting you to run Setup.
- You want to restore the factory default settings.
- You want to modify some specific settings according to the hardware.
- You want to modify some specific settings to optimize system performance.

Starting SCU

NOTE:

- The Setup screens shown in this chapter are for your reference only. The actual items or settings on your computer may differ.
- The Setup program may have been updated after the publication of this manual.
- The settings you select in your operating system might override similar settings in Setup.

To run SCU, press **F2** when the prompt appears in the lower left corner of the screen during system startup. The prompt shows up on the screen for only a few seconds. You must press **F2** quickly. The SCU menu appears as shown next.

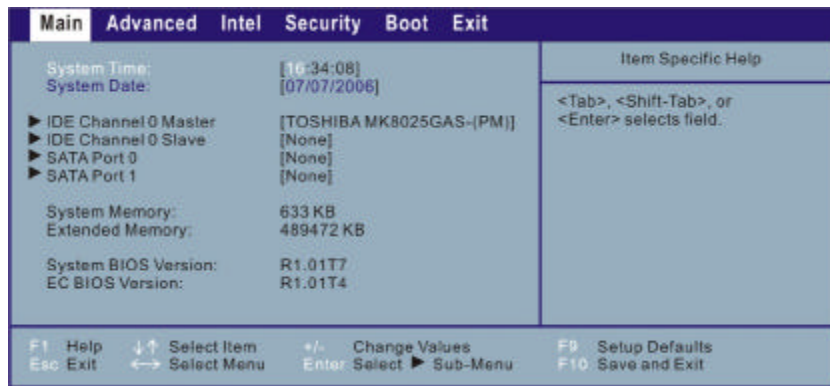

The SCU menu can be divided into four areas:

- On the top is the menu bar containing the titles of the available menus. Each menu title brings a specific menu.
- The center column of the menu displays the current configuration information of the system, devices, and memory items.
- The right column of the menu provides more detailed information when a menu item is highlighted.
- On the bottom keyboard keys are displayed for navigating the screen.

Moving Around and Making Selections

In most cases, you must go through two levels to complete the setting for an item: menu title and submenu.

Use the keyboard to move around and make selections. A brief description of keyboard usage is listed next:

Key	Function
← , →	Selects a menu title.
↑ , ↓	Selects an item or option.
+ , -	Changes the value.
Enter	1) Brings up the sub-menu when available. 2) Opens or closes the option window when an item is selected.
Esc	1) Displays the Exit menu. 2) Closes the option window if one is open.
F1	Displays help information.
F9	Changes the values to the setup defaults.
F10	Saves and exit the SCU program.

Main Menu

The Main menu contains the system date and time as well as the IDE/SATA interface setting of the system.

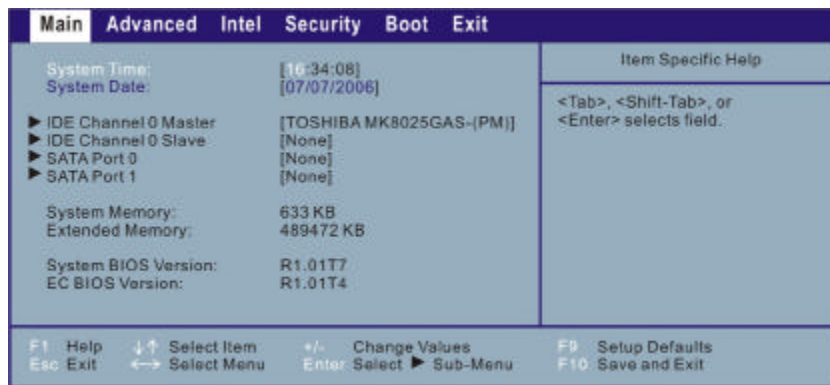

System Time sets the system time.

System Date sets the system date.

IDE Channel 0 Master/Slave / SATA Port 0/1 sets the type of storage device installed. The options are *User*, *Auto*, *CD-ROM*, *ATAPI Removable*, *None*, *IDE Removable*, and *Other ATAPI*.

Advanced Menu

The Advanced menu contains the hard disk drive heater as well as the screen display setting during system boot-up.

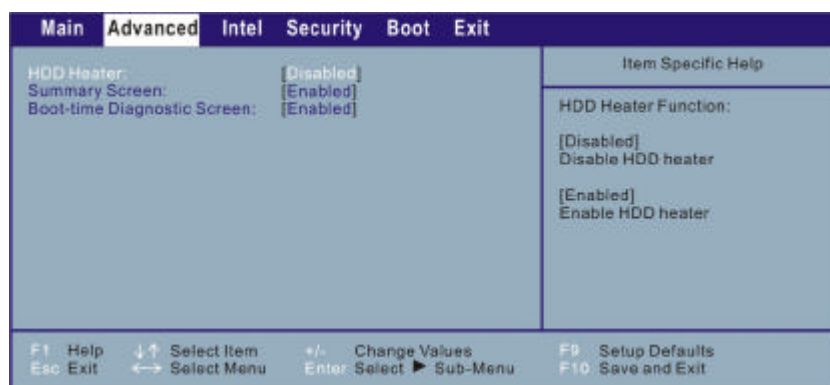

HDD Heater sets if the system automatically turns on the built-in hard disk drive heater for low temperature operation. The options are *Enabled* and *Disabled*.

| **NOTE:** Disable this item to conserve energy when using battery power.

Summary Screen sets if the system configuration would be displayed onscreen during system boot-up. The options are *Enabled* and *Disabled*.

Boot-time Diagnostic Screen sets if the system diagnostic screen would be displayed during system boot-up. The options are *Enabled* and *Disabled*.

Intel Menu

The Intel menu contains the LPC I/O devices and CPU thermal setting of the system.

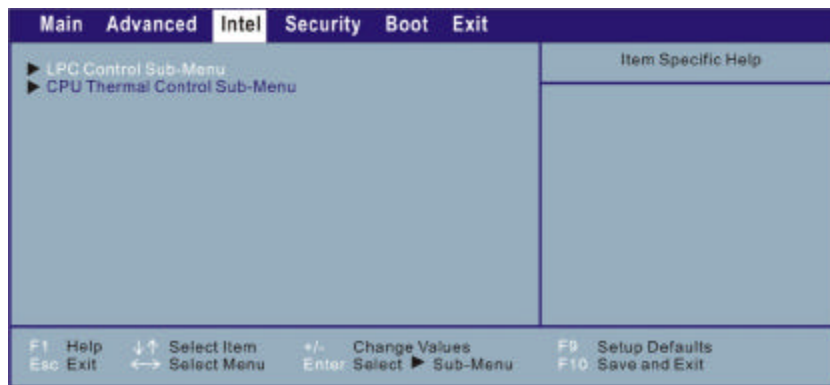

LPC Control Sub-Menu sets the items that control the configuration of various LPC input/output devices that exists on the CRB as well as the National 393 serial input/output devices.

CPU Thermal Control Sub-Menu sets the items that control various CPU thermal parameters.

Security Menu

The Security menu contains the security setting, which safeguard your system against unauthorized use.

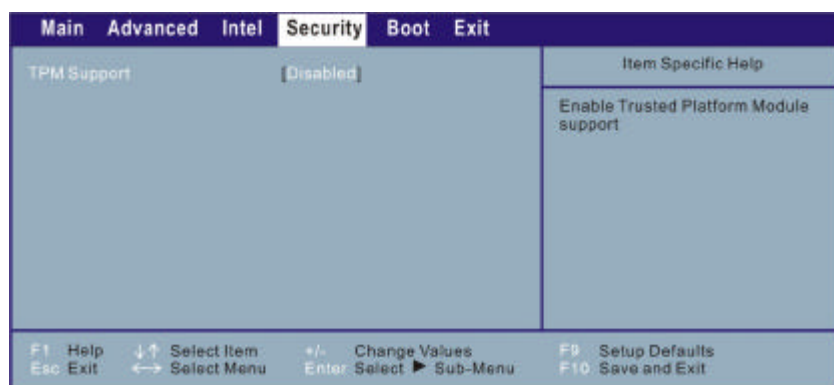

TPM Support enables or disables TPM (Trusted Platform Module) support. The options are *Enabled* and *Disabled*.

NOTE: To use the TPM feature, the TPM driver supplied with your computer must be installed (see chapter 6 for details).

Boot Menu

The Boot menu sets the sequence of the devices to be searched for the operating system.

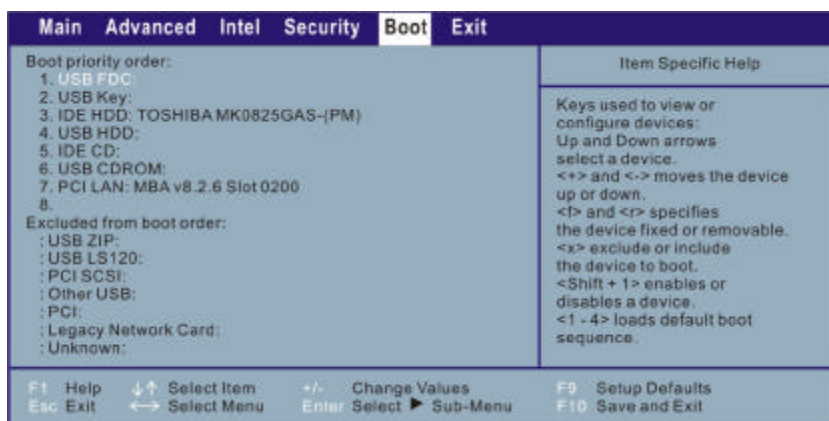

The bootable devices will be automatically detected during POST and shown here, allowing you to set the sequence that the BIOS uses to look for a boot device from which to load the operating system.

A brief description of keyboard usage is listed next:

Key	Function
↑, ↓	Selects (highlight) a boot device.
+, -	Changes the boot sequence.
1 to 4	Loads the default boot sequence.
f or r	Specifies if the device is fixed (f) or removable (r).
X	Moves the highlighted boot device from the “Boot priority order” list to the “Excluded from boot order” list, and vice versa.
Shift + 1	Deactivates/activates the highlighted boot device on the “Boot priority order” list. When a device has been deactivated, an “!” (exclamation) symbol appears beside the item and system will bypass it when detecting boot device during POST.

Exit Menu

The Exit menu displays ways of exiting the SCU program. After finishing with your settings, you must save and exit so that the changes can take effect.

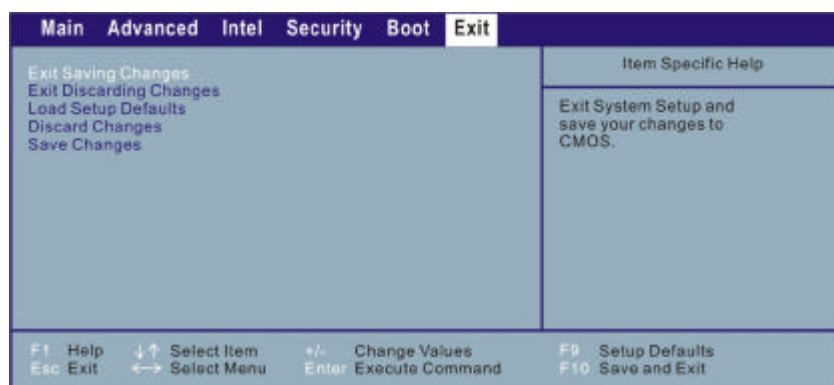

Exit Saving Changes saves the changes you have made and exits BIOS Setup Utility.

Exit Discarding Changes exits BIOS Setup Utility without saving the changes you have made.

Load Setup Defaults loads the factory default values for all the items.

Discard Changes restores the previous values for all the items.

Save Changes saves the changes you have made.

Installing Software Drivers

To take full advantage of the unique features of your computer, some operating systems require custom software, known as drivers, to be installed.

If you purchased the computer with Windows pre-installed, your dealer may have already installed the drivers. If not, you need to install the drivers using the driver disc supplied with your computer.

This chapter describes how to install the drivers.

How to Use the Driver CD

NOTE:

- The drivers may have been updated after this manual was published. For driver upgrade, please contact your dealer.
- You can always find **README** or document files on the driver CD. These files contain the latest information from the software supplier. Please read the files together with this chapter.
- This driver CD supports Windows 98, Windows NT, Windows 2000, Windows XP, and Linux operating systems only. You are recommended to install Windows 2000 Service Pack 4 when using Windows 2000 and Windows XP Service Pack 2 when using Windows XP.
- The available items may differ according to your computer model and operation system.
- Do not remove the driver CD when installing the driver.

An autorun program is provided on the driver CD to help you easily install the drivers. As you insert the driver CD, the autorun program automatically starts. If you need to start the program manually, run the **Autorun.exe** program from the **Setup** directory of the driver CD.

The main screen appears as shown next:



To install the necessary driver, just click on the particular option and follow the onscreen instructions to continue and complete installation.

- Device Driver* Ensures the full function of the following drivers. Install this main driver before installing the other drivers. Upon clicking this button, the chipset, VGA, audio, modem, and LAN drivers would be installed one after the other.
- TPM* Allows you to use the TPM (Trusted Platform Module) support for security.
- OSD* Installs the OSD (on screen display) utility that provides a graphic display to indicate the current status of certain operations.

NOTE: The OSD utility is an option for you. You can decide whether you would like to have this utility installed. (See the next section for details.)

Option Device Upon clicking on this, the following screen appears.



WLAN Installs the WLAN driver that allows your system to connect wirelessly to the Internet.

Bluetooth
(option) Allows your computer to connect to Bluetooth-compliant devices. Refer to chapter 2 for detailed instructions on using the Bluetooth feature of your computer.

TouchScreen
(option) Allows you to use your fingers as a pointing device on the LCD screen (refer to the next section for further instructions).

Vehicle Dock Upon clicking this button on the first page, the following screen appears.



Video Capture (option) Allows you to connect a video capture device through the AV input port.

USB-to-COM (option) Allows you to use the wireless modem and GPS features to transmit information wirelessly.

Others Upon clicking on this on the first page, the following screen appears.

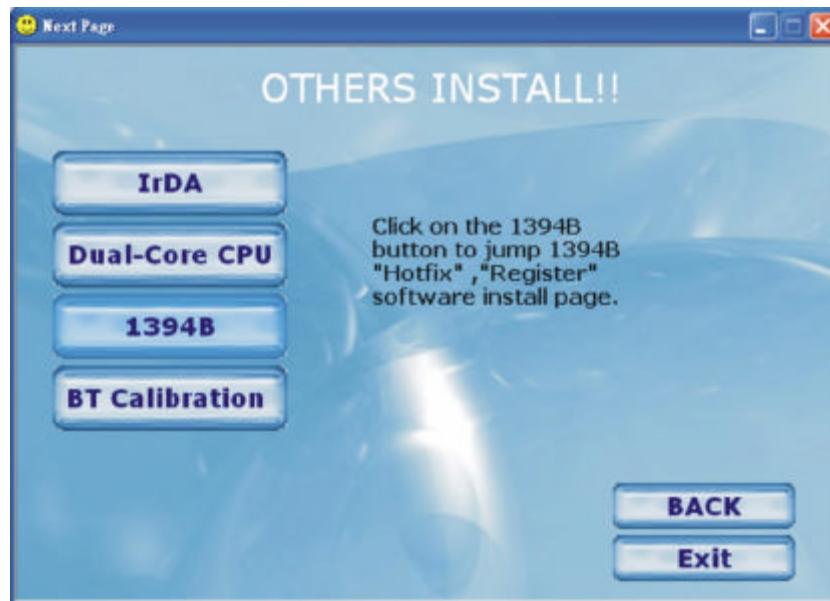

IrDA Installs the Microsoft Hotfix driver for the optional ATi M54-CSP VGA controller.

NOTE: You need to install the IrDA driver if your system comes with the ATi M54-CSP VGA controller and if you are using Windows XP Service Pack 2 only.

Dual Core Installs the dual core hotfix for Windows XP only.

1394B Allows your computer to connect to IEEE 1394B device.

BT Calibration Installs the battery pack automatic calibration utility.

User Guide Upon clicking on this on the first page, allows you to view the Operation Manual on screen.

NOTE: You need Adobe Acrobat Reader to open the manual file supplied on this driver disc. Install the Adobe Acrobat Reader program if you do not have it on your computer by clicking on **Get Adobe Reader**.

- Browse CD* Upon clicking on this on the first page, browses the contents of the driver disc.
- Exit* Exits the driver installation.

Touchscreen Driver

To install the touch screen driver, perform the following:

1. Insert the driver disc into the optical drive.
2. Click on **TouchScreen** and follow the onscreen instructions to continue.
3. When finished installing, select **Yes** to reboot your system. The driver should now be loaded.
4. After the system has finished rebooting, click on the **PenMount Monitor** icon  located on the taskbar to bring up the **PenMount Control Panel**.

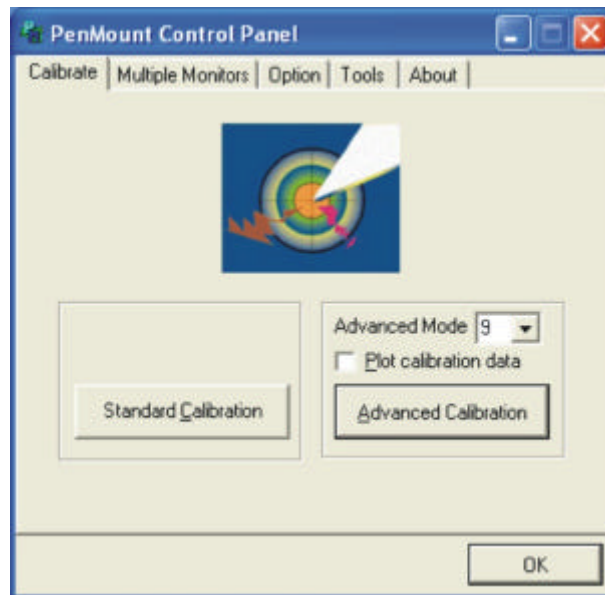









5. Click on **Standard Calibration**.
6. Click on the four sides (points) and the plus-sign “+” on the screen to calibrate your touchscreen for use on the computer.









Using the OSD

NOTE: The OSD utility is an option for you. You can decide whether you would like to have this utility installed.

With the OSD utility installed, the utility will be activated and an icon will appear on the system tray every time Windows starts up.

A graphic display will appear on the screen to indicate the current status of certain operations (as listed next).

Icon		OSD Description
Hot Key/Button Operation		
		Icon appears on the screen whenever you adjust Windows or any of its application program's volume control (e.g., Windows Media Player, etc.) to indicate the volume level. The OSD disappears after a few seconds.
Fn+F3	Fn+F4	
	Mute	
		Icon appears on the screen to indicate the brightness level. The OSD disappears after a few seconds.
Fn+F5	Fn+F6	
		Icon appears on the screen to indicate that GPS is on or off. The OSD disappears after a few seconds.
Fn+F7 On	Fn+F7 Off	
		Icon appears on the screen to indicate the current display output. The OSD disappears after a few seconds.
Fn+F9 LCD	Fn+F9 Both	
Fn+F9 LCD	Fn+F9 Both	
	Fn+F9 DVI	

Icon Hot Key/Button Operation		OSD Description
 Fn+F10/F11 On	 Fn+F10/F11 Off	Icon appears on the screen to indicate that LCD display (F10) or backlight (F11) is on or off. The OSD disappears after a few seconds.
 On	 Off	Icon appears on the screen to indicate that wireless LAN is on or off. The OSD disappears after a few seconds.
 AC In	 AC out	Icon appears on the screen to indicate that AC power cord has been connected or unplugged. The OSD disappears after a few seconds.
 Speaker On	 Speaker Off	Icon appears on the screen to indicate that speaker is on or off. The OSD disappears after a few seconds.

Exiting and Reactivating the OSD Utility

To exit the OSD utility, right-click on the OSD utility icon on Windows system tray and click on "Exit."

To reactivate the OSD utility:

Double-click on the file **OSD.EXE** located on
c:/Program Files/OSD/ or

Restart the system.

Caring for the Computer

Taking good care of your computer will ensure a trouble-free operation and reduce the risk of damage to your computer.

This chapter gives you guidelines covering these areas of maintenance:

- How to protect the computer
- What to note when using and storing the computer
- How to clean the computer
- What to note when using the battery pack
- What to note when traveling with the computer

Protecting the Computer

To safeguard the integrity of your computer data as well as the computer itself, you can protect the computer in several ways as described in this section.

Using the Cable Lock

You can use a Kensington-type cable lock to protect your computer against theft. The cable lock is available in most computer stores.

To use the lock, loop the lock cable around a stationary object such as a table. Insert the lock to the Kensington lock hole and turn the key to secure the lock. Store the key in a safe place.



Using an Anti-Virus Strategy

New viruses are always being developed nowadays and they are attacking computers even more easily with emails so commonly used worldwide.

You can install a virus-detecting program to monitor potential viruses that could damage your files.

Taking Care of the Computer

Location Guidelines

- Use the computer where the temperature is between 0 °C (32 °F) and 60 °C (140 °F).
- Avoid placing the computer in a location subject to high humidity, extreme temperatures, mechanical vibration, direct sunlight, or heavy dust.
- Keep the computer at least 13 cm (5 inches) away from electrical appliances that can generate a strong magnetic field such as a TV, refrigerator, motor, or a large audio speaker.
- Do not move the computer abruptly from a cold to a warm place. A temperature difference of more than 10 °C (18 °F) will cause condensation inside the unit, which may damage the storage media.
- Do not place the computer on an unsteady surface.

General Guidelines

- Do not place heavy objects on top of the computer as this may damage the display.
- The screen surface is easily scratched. Do not use paper towels to clean the display. Avoid touching it with a ballpoint pen or pencil.
- To maximize the life of the backlight in the display, allow the backlight to automatically turn off as a result of power management. Avoid using a screen saver or other software that prevents the power management from working.

Cleaning Guidelines

- Never clean the computer with its power on.
- Use a soft cloth moistened with water or a non-alkaline detergent to wipe the exterior of the computer.
- Gently wipe the display with a soft, lint-free cloth. Do not use alcohol or detergent on the display.
- Dust on the IR port can interfere with data transfer. Wipe the port with a soft, dry cloth.
- Dust or grease on the touchscreen can affect its sensitivity. Clean the touchscreen by using adhesive tape to remove the dust and grease on its surface.

Battery Pack Guidelines

- Recharge the battery pack when it is nearly discharged. When recharging, make sure the battery pack is fully charged. Doing so may avoid harm to the battery pack.
- Operate the computer with the battery pack installed even when using external power. This ensures that the battery is fully charged.
- If you will not be using the computer for a long period of time (more than two weeks), remove the battery pack from the computer.
- If you remove the battery pack, make sure the battery terminals do not contact any conductors such as metal objects or water. Otherwise, the battery may become unusable as a result of a short circuit.
- If you need to store the battery pack, store it in a cool, dry place. Never allow the temperature to exceed 70 °C (158 °F).
- Do not leave the battery pack in storage for more than 3 months without recharging it.

When Traveling

- Before traveling with your computer, make a backup of your hard disk data into optical discs or other storage devices. As an added precaution, bring along an extra copy of your important data.
- Make sure the battery pack is fully charged.
- Make sure the computer is turned off.
- Do not leave objects that will press onto the display.
- Disconnect the AC adapter from the computer and take it with you. Use the AC adapter as the power source and as a battery-charger.
- Hand-carry the computer. Do not check it in as luggage.
- Allow extra time for airport security. Many airports inspect electronic devices carefully.
- If you need to leave the computer in the car, put it in the trunk of the car to avoid exposing the computer to excessive heat.
- When going through airport security, it is recommended that you send the computer and USB disks through the X-ray machine (the device you set your bags on). Avoid the magnetic detector (the device you walk through) or the magnetic wand (the hand-held device used by security personnel).
- If you plan to travel abroad with your computer, consult your dealer for the appropriate AC power cord for use in your country of destination.



Troubleshooting

Hardware, software, or a combination of both can cause computer problems. When you encounter any problem, it might be a typical problem that can easily be solved.

This chapter tells you what actions to take when solving common computer problems. It is divided into three sections:

- Preliminary checklist
- Solving common problems
- Resetting the computer

Preliminary Checklist

Here are helpful hints to follow before you take further actions when you encounter any problem:

- Try to isolate which part of the computer is causing the problem.
- Make sure that you turn on all peripheral devices before turning on the computer.
- If an external device has a problem, make sure that the cable connections are correct and secure.
- Make sure that the configuration information is properly set in the SCU program.
- Make sure that all the device drivers are correctly installed.
- Make notes of your observations. Are there any messages on the screen? Do any indicators light? Do you hear any beeps? Detailed descriptions are useful to the service personnel when you need to consult one for assistance.

If any problem persists after you follow the instructions in this chapter, contact an authorized dealer for help.

Solving Common Problems

For easy reference, the problems are divided into these categories.

Problem Type	Go to
Battery Problems	P. 8-4
Bluetooth Problems	P. 8-4
Display Problems	P. 8-5
Hardware Device Problems	P. 8-6
Hard Disk Drive Problems	P. 8-6
Infrared Problems	P. 8-7
Keyboard, Mouse and Touchpad Problems	P. 8-7
LAN Problems	P. 8-8
WLAN Problems	P. 8-8
Modem Problems	P. 8-8
PC Card Problems	P. 8-10
Power Management Problems	P. 8-10
Printer Problems	P. 8-11

Printer Problems

The printer does not work.

- Make sure that the printer is turned on (if it comes with an independent power source) and is online (ready to use).
- Make sure that the printer's signal cable is properly connected.
- Make sure that the printer driver is correctly installed.
- Make sure that you have assigned the printer port correctly in your operating system or application program.

The printer prints garbled information.

- Make sure that the printer driver is correctly installed.
- Make sure that the printer cable is properly connected.

Software Problems

Sound Problems	P. 8-12
Startup Problems	P. 8-13
Other Problems	P. 8-13

Battery Problems

The battery does not charge (Battery Charge indicator does not light amber).

- Make sure that the AC adapter is properly connected.
- Make sure that the battery is not too hot or cold. Allow time for the battery pack to return to room temperature.
- Make sure that the battery pack is installed correctly.
- Make sure that the battery terminals are clean.

The operating time of a fully charged battery becomes shorter.

- If you often partially recharge and discharge, the battery might not be charged to its full potential. Initialize the battery to solve the problem. (See “Initializing the Battery Pack” in Chapter 3 for instructions.)

The battery operating time indicated by the battery meter does not match the actual operating time.

- The actual operating time can be different from the estimated time, depending on how you are using the computer. If the actual operating time is much less than the estimated time, initialize the battery. (See “Initializing the Battery Pack” in Chapter 3 for instructions.)

Bluetooth Problems

I cannot connect to another Bluetooth-enabled device.

- Make sure that the Bluetooth driver is installed correctly.
- Make sure that both devices have activated Bluetooth.
- Make sure that the distance between the two devices are not over 10 meters or that there are no walls or other obstructions between the devices.
- Make sure that the other device is not in “Hidden” mode.
- Make sure that both devices are compatible.

I cannot end a Bluetooth connection.

- If another device is connected to your computer, you can either end the connection using the other device or by deactivating Bluetooth.

Display Problems

Nothing appears on the screen.

- If the power-on indicator is not on, check the electrical outlet, the plugs and power cords.
- If the power button does not respond to a light touch, press the button firmly.
- If you are using battery power, make sure that it has a charge remaining and that it is installed correctly.
- During operation, the screen may automatically turn off as a result of power management. Press any key to see if the screen comes back.
- The brightness level might be too low. Increase brightness by pressing **Fn+F6**.
- The display output might be set to an external device. To switch the display back to the LCD, press **Fn+F9**, or change the display through the settings in **Display Properties**.
- Try turning the computer off, wait for a few seconds, then turn it back on.

The characters on the screen are dim.

- Adjust the brightness and/or contrast.

Bad dots appear on the display at all times.

- A small number of missing, discolored, or bright dots on the screen are an intrinsic characteristic of TFT LCD technology. It is not regarded as a LCD defect. The Inspection Standard generally agreed in the LCD industry allows a maximum of 8 bad dots on a unit.

Resolution cannot be adjusted to desired setting.

- Make sure that the device driver is installed correctly.

The external monitor displays nothing.

- Make sure that the monitor is turned on.
- Make sure that the monitor's signal cable is properly connected.
- Switch the display to the monitor by pressing **Fn+F9**, or change the display through the settings in **Display Properties**.

Simultaneous display/multi-display does not work.

- Make sure that you turn on the external monitor before turning on the computer.
- Press **Fn+F9** to toggle through the display options or change the settings in **Display Properties** in Windows.

Hardware Device Problems

The computer does not recognize a newly installed device.

- The device may not be correctly configured in the SCU program. Run the SCU program to identify the new type.
- Make sure if any device driver needs to be installed. (Refer to the documentation that came with the device.)
- Make sure if the device needs any jumper or switch settings. (Refer to the documentation that came with the device.)
- Check the cables or power cords for correct connections.
- For an external device that has its own power switch, make sure that the power is turned on.

Hard Disk Drive Problems

The hard disk drive error message appears on the screen.

- Insert a bootable diskette and check the integrity of your hard drive.
- The hard disk drive has defects. Ask your dealer for help.

The hard disk drive operations seem slow.

- The data files stored on the hard disk drive may be fragmented. Use a tool such as Window's **Disk Defragmenter** to defragment the files.

The hard disk drive in-use indicator glows without blinking.

- The data files stored on the hard disk drive may be fragmented. Use a tool such as Window's **Disk Defragmenter** to defragment the files.

Infrared Problems

The IR port does not work.

- Make sure that the IR ports of the two device face each other within a ± 15 -degrees angle and 1 meter (3 feet) distance and there are no obstructions in between.
- Make sure that the device connected is using an equivalent speed.
- If you are printing to an infrared printer, make sure that the appropriate driver is installed.
- If you are using any file transfer functions, make sure that both the computer and the IR device have the appropriate software running.
- Make sure that there is no device radiating infrared rays, such as remote-controlled devices or wireless headphones, near the computer or device.
- Make sure that no direct sunlight or fluorescent lamps are near the computer or device.
- Make sure that the IR ports are clean.

Keyboard, Mouse and Touchpad Problems

The keyboard does not respond.

- Try connecting an external keyboard. If it works, contact an authorized dealer, as the internal keyboard cable might be loose.

The numeric keypad is disabled.

- Make sure that the Num Lock is switched on. (Check if the Num Lock Indicator  glows or not.)

The external keyboard does not work.

- Make sure that the keyboard cable is properly connected.

The USB mouse does not work.

- Make sure that the mouse cable is properly connected.

The touchpad does not work, or the pointer is difficult to control with the touchpad.

- Make sure that the touchpad is clean.

LAN Problems

I cannot access the network.

- Make sure that the device driver is correctly installed.
- Make sure that the LAN cable is properly connected to the RJ-45 connector and the network hub.
- Make sure that the network configuration is appropriate.
- Make sure that the user name or password is correct.

WLAN Problems

I cannot use the WLAN feature.

- Make sure that the Mini PCI WLAN card is correctly installed.
- Make sure that the necessary driver(s) is correctly installed.
- Make sure that the WLAN feature is turned on.

Transmission quality is poor.

- Your computer may be in an out-of-range situation. Move your computer closer to the Access Point or another WLAN device it is associated with.
- Check if there is high interference around the environment and solve the problem as described next.

Radio interference exists.

- Move your computer away from the device causing the radio interference such as microwave oven and large metal objects.
- Plug your computer into an outlet on a different branch circuit from that used by the affecting device.
- Consult your dealer or an experienced radio technician for help.

I cannot connect to another WLAN device.

- Make sure that the WLAN feature is turned on.
- Make sure that the SSID setting is the same for every WLAN device in the network.
- Your computer is not recognizing changes. Restart the computer.
- Make sure that the IP address or subnet mask setting is correct.

I cannot communicate with the computer in the network when Infrastructure mode is configured.

- Make sure that the Access Point your computer is associated with is powered on and all the LEDs are working properly.
- If the operating radio channel is in poor quality, change the Access Point and all the wireless station(s) within the BSSID to another radio channel.
- Your computer may be in an out-of-range situation. Move your computer closer to the Access Point it is associated with.
- Make sure that your computer is configured with the same security option (encryption) to the Access Point.

- Use the Web Manager/Telnet of the Access Point to check whether it is connected to the network.
- Reconfigure and reset the Access Point.

I cannot access the network.

- Make sure that the necessary driver(s) is correctly installed.
- Make sure that the network configuration is appropriate.
- Make sure that the user name or password is correct.
- You have moved out of range of the network.
- Turn off power management.

Modem Problems

The modem does not work.

- Make sure that the device driver is correctly installed.
- Make sure that the COM port in the communication software is correctly set.
- Turn off power management.

PC Card Problems

The PC card does not work.

- Make sure that the PC card is correctly seated.
- If the card requires an IRQ (Interrupt ReQuest), make sure that there is one available.

The PC card stops communicating properly.

- The application may have been reset when the computer is turned off or in Standby mode. Exit and restart the application.

Power Management Problems

The computer does not enter Standby or Hibernation mode automatically.

- If you have a connection to another computer, the computer does not enter Standby or Hibernation mode if the connection is actively in use.
- Make sure that the Standby or Hibernation time-out is enabled.

The computer does not enter Standby or Hibernation mode immediately.

- If the computer is performing an operation, it normally waits for the operation to finish.

The computer does not resume from Standby or Hibernation mode.

- The computer automatically enters Standby or Hibernation mode when the battery pack is empty. Do any one of the following:
 - Connect the AC adapter to the computer.
 - Replace the empty battery pack with a fully charged one.

The computer does not enter Hibernation mode with the Fn+F10 hot keys.

- Make sure that the Hibernation function is specified for the sleep button.

Printer Problems

The printer does not work.

- Make sure that the printer is turned on (if it comes with an independent power source) and is online (ready to use).
- Make sure that the printer's signal cable is properly connected.
- Make sure that the printer driver is correctly installed.
- Make sure that you have assigned the printer port correctly in your operating system or application program.

The printer prints garbled information.

- Make sure that the printer driver is correctly installed.
- Make sure that the printer cable is properly connected.

Software Problems

An application program does not work correctly.

- Make sure that the software is correctly installed.
- If an error message appears on the screen, consult the software program's documentation for further information.
- If you are sure the operation has stop, reset the computer. (See "Resetting the Computer" later in this chapter.)

Sound Problems

No sound is produced.

- Make sure that the volume control is not set too low.
- Make sure that the device driver is correctly installed.
- Make sure that the computer is not in Standby mode.
- If using an external speaker, make sure that the speaker is properly connected.

Distorted sound is produced.

- Make sure that the volume control is not set too high or too low. In most cases, a high setting can cause the audio electronics to distort the sound.

The sound system does not record.

- Adjust the playback or recording sound levels.

The external microphone or audio device does not work.

- Make sure that the microphone is connected to the proper connector on the computer.

- Make sure that your computer is equipped with the driver needed.
- Click the speaker symbol on the taskbar and check the Windows volume control.
- Check the volume control of your computer.

Startup Problems

When you turn on the computer, it does not respond and the Power Indicator does not light green.

- If you are using an external AC power, make sure that the AC adapter is correctly and securely connected. If so, make sure that the electrical outlet works properly.
- If you are using the battery power, make sure that the battery is not discharged.

When you turn on the computer, it stops after POST.

- Restart your computer.

Other Problems

The date/time is incorrect.

- Correct the date and time via the operating system or SCU program.
- After you have performed everything as described above and still have the incorrect date and time every time you turn on the computer, the RTC (Real-Time Clock) battery is at the end of its life. Call an authorized dealer to replace the RTC battery.

Resetting the Computer

You may have to reset (reboot) your computer on some occasions when an error occurs and the program you are using hangs up.

If the system operation seems to hang up, first wait. It is possible that the system is processing data. Periodically check the hard disk drive in-use indicator, if it flashes irregularly, the program may be accessing data and preventing you from using the keyboard. If you are sure the operation has stopped and you cannot use the “restart” function of the operating system, reset the computer.

Reset the computer by any one of these methods:

- Press **Ctrl+Alt+Del**.
- If the above action does not work, turn off the system. Wait for at least five seconds and turn it on again.

| CAUTION: Resetting will cause any unsaved data to be lost.

Specifications

NOTE: Specifications are subject to change without any prior notices.

Parts		Specifications
CPU		Intel Yonah processor (processor no. X48), μ FC-BGA package, dual core low voltage, 1.66 GHz; Front Side Bus (FSB) 667 MHz, 15 W thermal ceiling
Core logic		Intel 945GM (Calistoga) chipset + ICM7-M
Cache memory		L2 2 MB on-die
ROM BIOS		1 MB Flash EEPROM, system and VGA BIOS, ACPI 2.0, PC2001-compliant, Plug-and-Play, Suspend-to-DRAM/HDD boot from IDE/USB/PCMCIA devices, G-sensor support
RAM	System	Two 200-pin 400/533 MHz DDR2 SO-DIMM sockets, maximum 2 GB
	Video	64 MB (shared system memory)
Display	Panel	12.1/14.1-inch TFT (Thin-Film Transistor) color LCD display with 1024 \times 768 XGA (eXtended Graphics Array) resolution, or 14.1-inch TFT color LCD display with 1400 \times 1050 SXGA+ / SXGA (Super eXtended Graphics Array) resolution, or 17.1-inch wide TFT color LCD display sunlight readable and touchscreen (option)
	Video controller	Integrated in 945GM chipset, Intel GMA 950 graphics controller, integrated 32-bit 3D/2D gfx core with Dynamic Video Memory technology, supports DirectX [®] 9.0 and PCI Express x16 graphics, dual view function, LCD/CRT simultaneous display capability, or ATi M54-CSP VGA controller with 128 MB memory (option)
	Video port	VGA port
Audio	Controller	Azalia 32-bit, 192 KHz, two 2-watt stereo speakers built-in
	Ports	Two audio ports for Mic-in / Line-out
Keyboard		Shower-proof and dust-proof rubber keyboard, LED backlight rubber keyboard (option)
Pointing device		Two buttons touchpad, glove-use touchpad support (option)
Hard disk drive (removable)		2.5-inch, 9.5 mm height, Ultra DMA 100 / SATA 160 (option) support, built-in G-sensor and heater for low temperature -20 °C (option)

Parts		Specifications
I/O ports		Serial port, parallel port, IEEE 1394B port, two USB ports, IR port, port replicator, RJ-45 port, RJ-11 port, fingerprint sensor (option)
Communications	Modem	56 K V.92
	LAN	10/100/1000 Base-T Ethernet (reserved for TPM security function)
	Others (option)	Wireless LAN 802.11a/b/g (Intel 3945ABG) Bluetooth Class 1 V1.2 Wireless modem in Bay2 module (GPRS/GSM, CDMA)
Power	AC adapter	Input: 100~240 V AC, 50~60 Hz universal adapter
	Battery	Smart Li-ion battery 11.1 V / 9600 mah, KBC BIOS controllable
Dimension (W×D×H)		12.1" version 11.8×9.5×2.3 inch (315×255×70 mm) 14.1" version 11.8×10.4×2.3 inch (315×265×70 mm) 17" version 16.1×11.7×2.3 inch (410×296×70 mm)
Weight		12.1" version 12.9 lb (5.9 kg) 14.1" version 13.2 lb (6 kg) 17" version 18.7 lb (8.5 kg)
Environment	Temperature	Operating: 0 °C (32 °F) to 60 °C (140 °F) With HDD heater: -20 °C (-4 °F) to 60 °C (140 °F) option Storage: -40 °C (-40 °F) to 70 °C (158 °F)
	Humidity	Operating: 5 % to 95 % RH, non-condensing
	Altitude	Operating: 15,000 ft Storage: 40,000 ft (2,000 ft/min change rate)
	Shock	Operating: 15 g, 11 ms, half sine wave Storage: 50 g, 11 ms, half sine wave
	Vibration	Operating: 10~500 Hz 0.075 mm / 1 g (highway truck vibration exposure) Storage: 10~500 Hz 0.15 / 2 g (general minimum integrity exposure]
	Drop	Survives 3 ft drop on wood 26 times (only for 12.1" and 14.1" version)
	ESD (electrostatic discharge)	Air discharge: 0~8 KV (included) no error 8~15 KV allow soft error Contact discharge: 0~4 KV (included) no error 4~8 KV allow soft error

Regulatory Information

This appendix provides regulatory statements and safety notices on your computer.

NOTE: Marking labels located on the exterior of your computer indicate the regulations that your model complies with. Please check the marking labels and refer to the corresponding statements in this appendix. Some notices apply to specific models only.

On the Use of the System

Class B Regulations

USA

Federal Communications Commission Radio Frequency Interference Statement

NOTE:

This equipment has been tested and found to comply with the limits for a Class B digital device pursuant to Part 15 of the FCC Rules. These limits are designed to provide reasonable protection against harmful interference in a residential installation. This equipment generates, uses, and can radiate radio frequency energy and, if not installed and used in accordance with the instructions, may cause harmful interference to radio communications.

However, there is no guarantee that interference will not occur in a particular installation. If this equipment does cause harmful interference to radio or television reception, which can be determined by turning the equipment off and on, the user is encouraged to try to correct the interference by one or more of the following measures:

- Reorient or relocate the receiving antenna.
- Increase the separation between the equipment and receiver.
- Connect the equipment into an outlet on a circuit different from that to which the receiver is connected.
- Consult the dealer or an experienced radio/TV technician for help.

Any changes or modifications not expressly approved by the manufacturer could void the user's authority to operate the equipment.

Please note:

The use of a non-shielded interface cable with this equipment is prohibited.

Canada

Canadian Department of Communications Radio Interference Regulations Class B Compliance Notice

This Class B digital apparatus meets all requirements of the Canada Interference-Causing equipment regulations.

Cet appareil numérique de Classe B respecte toutes les exigences du Règlement Canadien sur le matériel brouilleur.

This digital apparatus does not exceed the Class B limits for radio noise emissions from digital apparatus set out in the Radio Interference Regulations of the Canadian Department of Communications.

Le présent appareil numérique n'émet pas de bruits radioélectriques dépassant les limites applicables aux appareils numériques de la classe B prescrites dans le Règlement sur le brouillage radioélectrique édicté par le ministère des Communications du Canada.

Safety Notices

About the Battery

Caution Texts Concerning Lithium Batteries

DANISH

ADVARSEL! Lithiumbatteri – Eksplosionsfare ved fejlagtig håndtering. Udskiftning må kun ske med batteri af samme fabrikat og type. Levér det brugte batteri tilbage til leverandøren.

NORWEGIAN

ADVARSEL: Eksplosjonsfare ved feilaktig skifte av batteri. Benytt samme batteritype eller en tilsvarende type anbefalt av apparatfabrikanten. Brukte batterier kasseres i henhold til fabrikantens instruksjoner.

SWEDISH

VARNING: Explosionsfara vid felaktigt batteribyte. Använd samma batterityp eller en ekvivalent typ som rekommenderas av apparattillverkaren. Kassera använt batteri enligt fabrikantens instruktion.

FINNISH

VAROITUS: Paristo voi räjähtää, jos se on virheellisesti asennettu. Vaihda paristo ainoastaan valmistajan suosittelemaan tyyppiin. Hävitä käytetty paristo valmistajan ohjeiden mukaisesti.

ENGLISH

CAUTION: Danger of explosion if battery is incorrectly replaced. Replace only with the same or equivalent type recommended by the equipment manufacturer. Discard used batteries according to manufacturer's instructions.

DEUTSCH

VORSICHT: Explosionsgefahr bei unsachgemäßem Austausch der Batterie. Ersatz nur durch denselben oder einen vom Hersteller empfohlenen gleichwertigen Typ. Entsorgung gebrauchter Batterien nach Angaben des Herstellers.

FRENCH

ATTENTION: Il y a danger d'explosion s'il y a un remplacement incorrect de la batterie. Remplacer uniquement avec une batterie du même type ou d'un type équivalent recommandé par le constructeur. Mettre au rebut les batteries usagées conformément aux instructions du fabricant.

Attention (for USA Users)

The product that you have purchased contains a rechargeable battery. The battery is recyclable. At the end of its useful life, under various state and local laws, it may be illegal to dispose of this battery into the municipal waste stream. Check with your local solid waste officials for details in your area for recycling options or proper disposal.

About the AC Adapter

- Use only the AC adapter supplied with your computer. Use of another type of AC adapter will result in malfunction and/or danger.
- Do not use the adapter in a high moisture environment. Never touch the adapter when your hands or feet are wet.
- Allow adequate ventilation around the adapter when using it to operate the device or charge the battery. Do not cover the AC adapter with paper or other objects that will reduce cooling. Do not use the AC adapter while it is inside a carrying case.
- Connect the adapter to a proper power source. The voltage requirements are found on the product case and/or packaging.
- Do not use the adapter if the cord becomes damaged.
- Do not attempt to service the unit. There are no serviceable parts inside. Replace the unit if it is damaged or exposed to excess moisture.

About the Modem

Caution

- Never install telephone wiring during a lightning storm.
- Never install telephone jacks in wet locations unless the jack is specifically designed for wet locations.
- Never touch non-insulated telephone wires or terminals unless the telephone line has been disconnected at the network interface.
- Use caution when installing or modifying telephone lines.
- Avoid using the telephone function (other than a cordless type) during an electrical storm. There may be a remote risk of electric shock from lightning.
- Do not use the telephone function to report a gas leak in the vicinity of the leak.
- Do not use this product near water, for example near a bathtub, wash bowl, kitchen sink or laundry tub, in a wet basement or near a swimming pool.

Caution (for USA Users)

To reduce the risk of fire, use only No.26 AWG or larger telecommunication line cord.

On the Use of RF Device

NOTE: The information in this section applies to models with the wireless LAN module.

USA and Canada Safety Requirements and Notices

IMPORTANT NOTE: To comply with FCC RF exposure compliance requirements, the antenna must not be co-located or operating in conjunction with any other antenna or transmitter.

Radio Frequency Interference Requirements and SAR

The FCC with its action in ET Docket 93-62 has adopted a safety standard for human exposure to Radio Frequency (RF) electromagnetic energy emitted by FCC certified equipment. The A790 laptop with wireless LAN module meets the Human Exposure limits found in OET Bulletin 65, 2001, and ANSI/IEEE C95.1, 1992. Proper operation of this radio according to the instructions found in this manual will result in exposure substantially below the FCC's recommended limits. The following safety precautions should be observed:

- Do not touch or move antenna while the unit is transmitting or receiving.
- Do not hold any component containing the radio such that the antenna is very close or touching any exposed parts of the body, especially the face or eyes, while transmitting.
- Do not operate the radio or attempt to transmit data unless the antenna is connected; if not, the radio may be damaged.

Use in specific environments:

- The use of wireless devices in hazardous locations is limited by the constraints posed by the safety directors of such environments.
- The use of wireless devices on airplanes is governed by the Federal Aviation Administration (FAA).
- The use of wireless devices in hospitals is restricted to the limits set forth by each hospital.

Antenna use:

To comply with FCC RF exposure compliance requirements, the antenna must not be co-located or operating in conjunction with any other antenna or transmitter.

Explosive Device Proximity Warning

WARNING: Do not operate a portable transmitter (such as a wireless network device) near unshielded blasting caps or in an explosive environment unless the device has been modified to be qualified for such use.

Use on Aircraft Caution

CAUTION: Regulations of the FCC and FAA prohibit airborne operation of radio-frequency wireless devices because their signals could interfere with critical aircraft instruments.

EMC Requirements

This device uses, generates and radiates radio frequency energy. The radio frequency energy produced by this device is well below the maximum exposure allowed by the Federal Communications Commission (FCC).

This device complies with the limits for a Class B digital device pursuant to Part 15 subpart C of the FCC Rules and Regulations. Operation is subject to the following two conditions:

- (1) This device may not cause harmful interference.
- (2) This device must accept any interference received, including interference that may cause undesired operation.

The FCC limits are designed to provide reasonable protection against harmful interference when the equipment is installed and used in accordance with the instruction manual and operated in a commercial environment. However, there is no guarantee that interference will not occur in a particular commercial installation, or if operated in a residential area.

If harmful interference with radio or television reception occurs when the device is turned on, the user must correct the situation at the user's own expense. The user is encouraged to try one or more of the following corrective measures:

- Reorient or relocate the receiving antenna.
- Increase the separation between the equipment and receiver.
- Connect the equipment into an outlet on a circuit different from that to which the receiver is connected.
- Consult the dealer or an experienced radio/TV technician for help.

CAUTION: The Part 15 radio device operates on a non-interference basis with other devices operating at this frequency. Any changes or modification to said product not expressly approved by the manufacturer could void the user's authority to operate this device.

Information to User: To assure continued compliance, any changes or modifications not expressly approved by the party responsible for compliance could void the user's authority to operate this equipment.

IMPORTANT NOTE:

This equipment complies with FCC radiation exposure limits set forth for an uncontrolled environment.

End users must follow the specific operation instruction for satisfying RF exposure compliance.

This transmitter must not be co-located or operating in conjunction with any other antenna or transmitter.

The maximum reported Body SAR value is:

CDMA2000 (835MHz): **0.762** W/g

CDMA2000 (1900MHz): **1.036** W/g

Canada Radio Frequency Interference Requirements

To prevent radio interference to the licensed service, this device is intended to be operated indoors and away from windows to provide maximum shielding. Equipment (or its transmit antenna) that is installed outdoors is subject to licensing.

Pour empêcher que cet appareil cause du brouillage au service faisant l'objet d'une licence, il doit être utilisé à l'intérieur et devrait être placé loin des fenêtres afin de fournir un écran de blindage maximal. Si le matériel (ou son antenne d'émission) est installé à l'extérieur, il doit faire l'objet d'une licence.

European Union CE Marking and Compliance Notices

Statements of Compliance

English

This product follows the provisions of the European Directive 1999/5/EC.

Danish

Dette produkt er i overensstemmelse med det europæiske direktiv 1999/5/EC.

Dutch

Dit product is in navolging van de bepalingen van Europees Directief 1999/5/EC.

Finnish

Tämä tuote noudattaa EU-direktiivin 1999/5/EC määräyksiä.

French

Ce produit est conforme aux exigences de la Directive Européenne 1999/5/EC.

German

Dieses Produkt entspricht den Bestimmungen der Europäischen Richtlinie 1999/5/EC.

Greek

To p???? a?t? p????t? p??B???e?t?? ???pa??? ? d??a?
1999/5/EC.

Icelandic

Pessi vara stenst reglugerð Evrópska Efnahags Bandalagsins númer
1999/5/EC.

Italian

Questo prodotto è conforme alla Direttiva Europea 1999/5/EC.

Norwegian

Dette produktet er i henhold til bestemmelsene i det europeiske direktivet
1999/5/EC.

Portuguese

Este produto cumpre com as normas da Diretiva Européia 1999/5/EC.

Spanish

Este producto cumple con las normas del Directivo Europeo 1999/5/EC.

Swedish

Denna produkt har tillverkats i enlighet med EG-direktiv 1999/5/EC.

Local Restrictions of 802.11 a/b/g Radio Usage

CAUTION: Due to the fact that the frequencies used by 802.11a/b/g wireless LAN devices may not yet be harmonized in all countries, 802.11a/b/g products are designed for use only in specific countries or regions, and is not allowed to be operated in countries or regions other than those of designated use. As a user of these products, you are responsible for ensuring that the products are used only in the countries or regions for which they were intended and for verifying that they are configured with the correct selection of frequency and channel for the country or region of use. Any deviation from permissible settings and restrictions in the country or region of use could be an infringement of local law and may be punished as such.

The European variant is intended for use throughout the European Economic Area. However, authorization for use is further restricted in particular countries or regions within countries, as follows:

General

European standards dictate maximum radiated transmit power of 100 mW Effective Isotropic Radiated Power (EIRP) and the frequency range 2400 – 2483.5 MHz.

Belgium and the Netherlands

In Belgium and the Netherlands, the product may not be used outdoors. See the instructions next under the heading “How to Turn Off the Wireless LAN.”

France

Departments in Which the Wireless LAN Module Can Be Used (Indoors Only)

The wireless LAN module can currently be used indoors only in the following 38 departments of mainland France. Please turn off your wireless LAN radio when operating the device in areas/places other than the 38 departments listed:

01	Ain Orientales	36	Indre	66	Pyrénées
02	Aisne	37	Indre et Loire	67	Bas Rhin
03	Allier	41	Loir et Cher	68	Haut Rhin
05	Hautes Alpes	42	Loire	70	Haute Saône
08	Ardennes	45	Loiret	71	Saône et Loire
09	Ariège	50	Manche	75	Paris
11	Aude	55	Meuse	82	Tarn et Garonne
12	Aveyron	58	Nièvre	84	Vaucluse
16	Charente	59	Nord	88	Vosges
24	Dordogne	60	Oise	89	Yonne
25	Doubs	61	Orne	90	Territoire de Belfort
26	Drôme	63	Puy du Dôme	94	Val de Marne
32	Gers	64	Pyrénées Atlantique		

Departments in Which the Wireless LAN Module's Maximum EIRP Not Shown in the Previous Table

Frequency Ranges (MHz)	Indoors	Outdoors
2400 – 2446.5	10 mW	Not permitted
2446.5 – 2483.5	100 mW	100 mW on private property with Ministry of Defense approval

Turning Off the Wireless LAN Radio

NOTE: Turning the wireless LAN radio off is not the same as disabling the wireless LAN card. It is not necessary to disable the card to meet the regulatory requirements.

While operating the computer in those French departments that do not allow use of the wireless LAN equipment, the user of the equipment must turn off the wireless LAN radio in order to comply with local regulations (see chapter 2 for more information).