

V100 User's Manual

IMPORTANT : This User's Manual is for Safety Approval purpose only.
This is not intended as final release for mass production.

(February 2007)

TRADEMARKS

All brand and product names are trademarks or registered trademarks of their respective companies.

NOTE

The information in this manual is subject to change without notice.

Table of Contents

Preface	v
Notational Conventions	vi
Chapter 1 Getting Started	1-1
Getting the Computer Running.....	1-2
Unpacking.....	1-2
Connecting to AC Power.....	1-2
Opening and Closing the Cover.....	1-3
Turning On and Off the Computer	1-3
Taking a Look at the Computer	1-5
Right-Side Components.....	1-5
Left-Side Components	1-6
Rear Components.....	1-7
Front Components.....	1-8
Bottom Components.....	1-9
Top-open Components.....	1-10
Where to Go from Here.....	1-12
Chapter 2 Operating Your Computer	2-1
Starting and Stopping the Computer	2-2
Starting the Computer	2-2
Stopping the Computer.....	2-2
Using the Keyboard.....	2-4
Typewriter Keys.....	2-4
Cursor-Control Keys.....	2-4
Numeric Keypad	2-5
Function Keys.....	2-5
Fn Key	2-6

Hot Keys	2-6
Using the Touchpad.....	2-8
Configuring the Touchpad	2-9
Using the Touchscreen.....	2-10
Using the Active Digitizer Feature	2-11
Using the Hard Disk Drive	2-12
Replacing the Hard Disk Drive.....	2-12
Using the Video Features.....	2-14
Configuring the Display Modes	2-14
Using the Audio Features	2-16
Connecting Audio Devices.....	2-16
Using the Communication Features	2-17
Using the Modem	2-17
Using the LAN	2-17
Using the GPS (Optional)	2-18

Chapter 3 Managing Power.....3-1

AC Adapter.....	3-2
Battery Pack.....	3-3
Charging the Battery Pack.....	3-3
Initializing the Battery Pack	3-4
Battery Automatic Calibration Utility	3-5
Checking the Battery Level.....	3-7
Replacing the Battery Pack.....	3-7
Battery Low Signals and Actions.....	3-8
Power Management.....	3-9
Hibernation	3-10
Power-Saving Tips	3-11

Chapter 4 Expanding Your Computer.....4-1

Connecting an External Monitor (Optional)	4-2
Connecting a Serial Device.....	4-3
Connecting a USB Device.....	4-4
Using PC Cards.....	4-5
PC Card Type.....	4-5

	CardBus Support.....	4-5
	Inserting and Removing a PC Card.....	4-5
	Using the Card Reader.....	4-7
	System Memory Upgrade.....	4-8
Chapter 5	Using BIOS Setup.....	5-1
	When and How to Use BIOS Setup.....	5-2
	When to Use.....	5-2
	Starting BIOS Setup.....	5-2
	Moving Around and Making Selections.....	5-4
	Main Menu.....	5-5
	Advanced Menu.....	5-6
	Security Menu.....	5-9
	Boot Menu.....	5-10
	Exit Menu.....	5-11
Chapter 6	Installing Software Drivers.....	6-1
	How to Use the Driver Disc.....	6-2
	GPS Driver.....	6-8
Chapter 7	Caring for the Computer.....	7-1
	Protecting the Computer.....	7-2
	Using the Cable Lock.....	7-2
	Using an Anti-Virus Strategy.....	7-2
	Taking Care of the Computer.....	7-3
	Location Guidelines.....	7-3
	General Guidelines.....	7-3
	Cleaning Guidelines.....	7-4
	Battery Pack Guidelines.....	7-4
	When Traveling.....	7-5
Chapter 8	Troubleshooting.....	8-1
	Preliminary Checklist.....	8-2
	Solving Common Problems.....	8-3
	Battery Problems.....	8-5
	Display Problems.....	8-5

Hardware Device Problems	8-6
Hard Disk Drive Problems.....	8-7
Keyboard, Mouse, and Touchpad Problems.....	8-7
LAN Problems	8-8
Modem Problems	8-8
PC Card Problems.....	8-8
Power Management Problems	8-9
Software Problems	8-9
Sound Problems	8-10
Startup Problems	8-11
Other Problems	8-11
Resetting the Computer.....	8-12

Appendix A Specifications..... A-1

Appendix B Regulatory Information..... B-1

On the Use of the System	B-2
Class B Regulations	B-2
Safety Notices.....	B-3
On the Use of the RF Device.....	B-6
USA and Canada Safety Requirements and Notices.....	B-6

Preface

This manual contains information that will help you operate the computer. It is divided into 8 chapters, 2 appendices, and an index.

- Chapter 1, **Getting Started**, takes you through the process of setting up the computer and identifying its external components.
- Chapter 2, **Operating Your Computer**, tells you how to use the computer's components and features.
- Chapter 3, **Managing Power**, provides information on power.
- Chapter 4, **Expanding Your Computer**, provides information on installing and using peripheral devices.
- Chapter 5, **Using BIOS Setup**, describes the BIOS Setup program that configures the computer's BIOS settings.
- Chapter 6, **Installing Software Drivers**, describes how to install the drivers and utilities supplied with the computer.
- Chapter 7, **Caring for the Computer**, gives you tips in care and maintenance.
- Chapter 8, **Troubleshooting**, gives solutions to common problems you may encounter when using the computer.
- Appendix A, **Specifications**, gives a brief specification of the computer.
- Appendix B, **Regulatory Information**, provides regulatory statements and safety notices on your computer.

Notational Conventions

Throughout this manual, the following conventions are used to distinguish elements of text.

| **NOTE:** identifies additional information that requires special attention.

| **CAUTION:** identifies important information that, if not followed, may result in loss of data or damage to the computer.

Keyboard keys are shown in a bold typeset. For example:

Press the **Enter** key to complete.

When keys are joined by a plus sign (+), press the first key, and, while keeping the first key down, press the remaining keys, finally release all the keys. When necessary, keys are also shown in graphics.

A title, command, setup item, or button that you can see on the screen is shown in boldface. A value or an option that you can select for a setup item is shown in italic. For example:

Select **Power Schemes**, set it to *Portable/Laptop*, and then click the **OK** button.

Getting Started

Congratulations on purchasing this ruggedized computer.

Your computer incorporates desktop computer capabilities into a compact notebook-sized package. It can greatly enhance your productivity either in the office or at home. And, of course, wherever you need it, the computer is ready and easy “to go.”

This chapter first tells you step by step how to get the computer up and running. You will find instructions for these procedures:

- Unpacking
- Connecting to AC power
- Opening and closing the cover
- Turning on the computer
- Turning off the computer
- Attaching the grid-type hand strap

Then, you will find a section briefly introducing the external components of the computer. And the last section navigates you to the information you may need after the computer is ready for use.

Getting the Computer Running

This section guides you through the procedures for getting the computer ready for operation.

Unpacking

After unpacking the shipping carton, you should find these standard items:

- Notebook computer
- Accessories:
 - AC adapter
 - AC power cord
 - Grid-type hand strap
 - Driver disc

Inspect all the items. If any item is damaged or missing, notify your dealer immediately.

Keep the shipping carton and packing materials in case you need to ship or store the computer in the future.

Connecting to AC Power

The computer operates either on the external AC power or internal battery power. It is suggested that you use AC power when you start up the computer for the very first time.

CAUTION: Use only the AC adapter included with your computer. Using other AC adapters may damage the computer.

1. Make sure that the computer is turned off.
2. Plug the DC cord of the AC adapter to the power connector of the computer (❶).

3. Plug the female end of the AC power cord to the AC adapter and the male end to an electrical outlet (❷).
4. When the AC adapter is connected, power is being supplied from the electrical outlet to the AC adapter and onto your computer. Now, you are ready to turn on the computer.

CAUTION:

- When you disconnect the AC adapter, disconnect from the electrical outlet first and then from the computer. A reverse procedure may damage the AC adapter or the computer.
- When unplugging the connector, always hold the plug head. Never pull on the cord.

NOTE: When the AC adapter is connected, it also charges the battery pack. For information on using battery power, see Chapter 3.

Opening and Closing the Cover

CAUTION: Be gentle when opening and closing the cover. Opening it vigorously or slamming it shut could damage the computer.

Open the top cover by pulling up on latch A and releasing latch B (❶) and lifting up the cover (❷). You can tilt the cover forward or backward for optimal viewing clarity.

Close the top cover by closing the display (❶) and pulling up on latch A (❷). Then position latch B on the display side and bring latch A down (❸) to fix the display in place.

Turning On and Off the Computer

Turning On

1. Make sure that the computer is connected to AC power.

2. Press the power button.
3. Each time the computer is turned on, it performs a Power-On Self Test (POST), and the operating system such as Windows should start.

Turning Off

To turn off the computer power, use the “Shut Down” command of your operating system.

NOTE: There are other ways you can stop the computer so that you will be back to where you left off when you next turn on the computer. (See “Stopping the Computer” in Chapter 2 for information.)

CAUTION: If you have to turn the computer on again immediately after turning it off, wait for at least five seconds. Turning the computer off and on rapidly can damage it.



Taking a Look at the Computer

This section identifies the external components of the computer and briefly describes the function of each component.

NOTE: Depending on the model you purchased, the appearance of your computer may not be exactly the same as those shown in this manual.

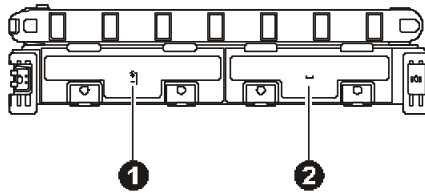



Right-Side Components

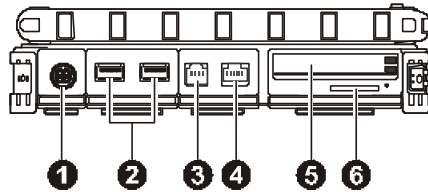

Ref	Component	Description
①	Battery Pack Compartment 	Inside is the battery pack that supplies power to your computer when external power is not connected.
②	Hard Disk Drive Compartment 	Inside is the hard disk drive.



Left-Side Components

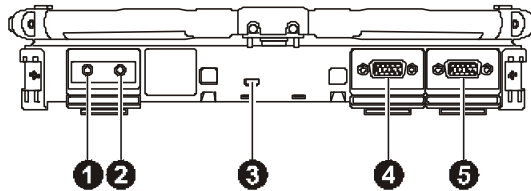

Ref	Component	Description
①	Power Connector 	Connects the AC adapter.
②	USB Ports 	Each of the two ports connects a USB device, such as a flash disk, printer, digital camera, joystick, and more.
③	RJ-11 Connector 	Connects the telephone line.
④	RJ-45 Connector 	Connects the LAN cable.
⑤	PCMCIA Slot 	Each of the two slots accepts a PC card for additional functions.
⑥	Card Reader	Accepts a SD (Secure Digital) card for removable storage media.

Rear Components



Ref	Component	Description
1	Audio Output Connector 	Connects a set of headphones, external speakers with amplifier, or an audio recording device.
2	Microphone Connector 	Connects an external microphone.
3	Kensington Lock	Locks the computer to a stationary object for security.
4	VGA Connector	Connects an external display monitor. NOTE: Depending on your model, this port could be a serial connector.
5	Serial Connector  10101 RS232	Connects a serial mouse or serial communication device.

Front Components

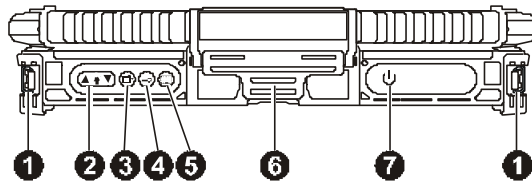

Ref	Component	Description
①	Hand Strap Holder	The hand strap can be attached to the two holders for convenient handling of your computer.
②	LCD Brightness Buttons ▲-☼-▼	Adjust the LCD brightness level.
③	LCD Rotate Button ◻↻	Rotates the LCD display orientation from default landscape to portrait and vice versa.
④	Security Button 🔑	Serves as the Ctrl+Alt+Del keyboard buttons.
⑤	Software Keyboard Button ⌨	Shows or hides the software keyboard on your LCD display.
⑥	Top Cover Latch	Locks the top cover.
⑦	Power Button ⏻	Turns the computer power ON and OFF.

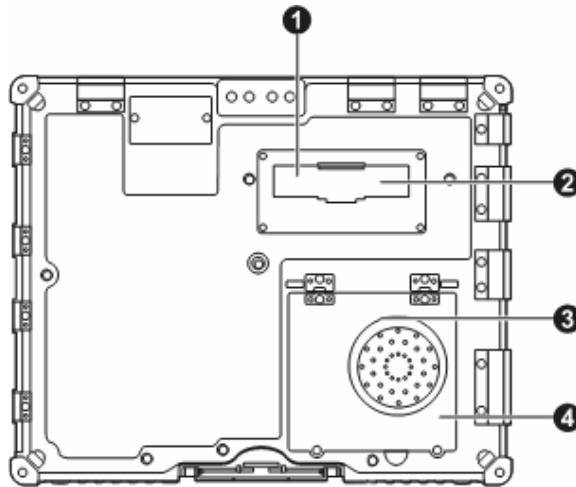

Bottom Components





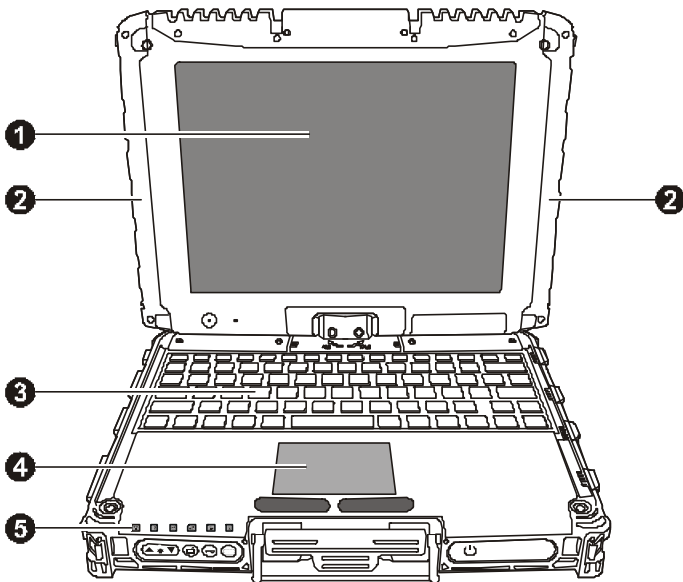

Ref	Component	Description
1	Antenna Connector	Connects an external antenna.
2	Expansion Bus Connector	Also known as Port Replicator.
3	Memory Slot	Inside is the memory slot for expanding the memory size of your computer.
4	Speaker	Sends out sound and voice from your computer.

Top-open Components



Ref	Component	Description
①	LCD Screen	Displays the output of the computer.
②	WWAN Antenna	Serves as the antenna for WWAN transmission.
③	Keyboard	Serves as the data input device of the computer.
④	Touchpad	Serves as the pointing device of the computer.
⑤	Indicators	Show the current status of the computer's devices.
		AC Power indicator Lights green when the computer is turned on and using AC power.
		Battery Charge indicator Lights green when the battery is fully charged.

Ref	Component	Description
		Lights orange when the battery is being charged.
		Blinks orange when the battery's capacity is below 10 %.
		Blinks green when battery's temperature is too high (over 60 °C).
		Hard disk drive in-use indicator
		Scroll Lock indicator
		Num Lock indicator
		Caps Lock indicator

Where to Go from Here

As your computer is ready for operation, you may want to do any of the following now:

For this purpose...	Do this...
To know more about the computer...	Go on to the next chapter.
To install the operating system if your dealer has not already done so...	See the operating system manual.
To know more about the operating system...	Read the operating system manual.
To install the drivers if your dealer has not already done so...	See Chapter 6.
To charge the battery pack for the first time...	See “Charging the Battery Pack” in Chapter 3.

Operating Your Computer

This chapter provides information about the use of the computer.

If you are new to computers, reading this chapter will help you learn the operating basics. If you are already a computer user but are new to notebook computers, you may choose to read only the parts containing information unique to your computer.

Described in this chapter are the operating basics of these components:

- Keyboard
- Touchpad
- DVD drive

And these features:

- Starting and stopping the computer
- Video features
- Audio features
- Communication features

Starting and Stopping the Computer

There are a number of ways to start and stop the computer.

Starting the Computer

You always start the computer using the power button.

A computer starts up with an operating system (OS) existing on the storage device such as the hard disk. The computer will automatically load the OS after you turn it on. This process is called booting.

NOTE: An operating system is the platform for all your software application programs to run on. The most widely used operating system today is Microsoft Windows XP.

Stopping the Computer

When you finish a working session, you can stop the computer by turning off the power or leaving the computer in Standby or Hibernation mode:

To stop in this mode...	Do this...	To start up or resume again
Off	<p>Follow the shutdown procedure of your operating system. This can prevent loss of unsaved data or damage to your software programs.</p> <p>If the system is locked up because of hardware or software problems, press the power button to turn off the computer.</p>	Press the power button.
Standby	<p>Depending on your settings in Windows, you can place the computer in Standby mode by:</p> <ul style="list-style-type: none">• Closing the display cover• Pressing the Fn+F10 hot key• Pressing the power button	Press any key.

To stop in this mode...	Do this...	To start up or resume again
Hibernation	Depending on your settings in Windows, you can place the computer in Hibernation mode by: <ul style="list-style-type: none">• Closing the display cover• Pressing the Fn+F10 hot key• Pressing the power button	Press the power button.

If you choose to stop in Standby or Hibernation mode, you can return to where you left off the next time you start up the computer. (See “Power Management” in Chapter 3 for more information.)

Using the Keyboard

Your keyboard has all the standard functions of a full-sized computer keyboard plus a **Fn** key added for specific functions.

The standard functions of the keyboard can be further divided into four major categories:

- Typewriter keys
- Cursor-control keys
- Numeric keys
- Function keys

Typewriter Keys

Typewriter keys are similar to the keys on a typewriter. Several keys are added such as the **Ctrl**, **Alt**, **Esc**, and lock keys for special purposes. When the lock keys (**Caps Lock**, **Num Lk**, and **Scroll Lk**) are pressed, their corresponding indicators light up.

The Control (**Ctrl**) / Alternate (**Alt**) key is normally used in combination with other keys for program-specific functions. The Escape (**Esc**) key is usually used for stopping a process. Examples are exiting a program and canceling a command. The function depends on the program you are using.

Cursor-Control Keys

NOTE: The word “cursor” refers to the indicator on the screen that lets you know exactly where on your screen anything you type will appear. It can take the form of a vertical or horizontal line, a block, or one of many other shapes.

The cursor-control keys include the Delete (**Del**), Insert (**Ins**), Home (**Home**), End (**End**), Page-up (**PgUp**), Page-down (**PgDn**), and up (↑) / down (↓) / left (←) / right (→) arrow keys.

Numeric Keypad

A 15-key numeric keypad is embedded in the typewriter keys as shown next:



Numeric keys facilitate entering of numbers and calculations. When Num Lock is on, the numeric keys are activated; meaning you can use these keys to enter numerals.

NOTE:

- When the numeric keypad is activated and you need to type the English letter in the keypad area, you can turn Num Lock off or you can press **Fn** and then the letter without turning Num Lock off.
- Some software may not be able to use the numeric keypad on the computer. If so, use the numeric keypad on an external keyboard instead.

Function Keys

On the top row of the keys are the function keys: **F1** to **F12**. Function keys are multi-purpose keys that perform functions defined by individual programs.

Fn Key

The **Fn** key, at the lower left corner of the keyboard, is used with another key to perform the alternative function of a key. The letter “Fn” and the alternative functions are identified by the color of blue on the keypad. To perform a desired function, first press and hold **Fn**, then press the other key.

Hot Keys

Hot keys refer to a combination of keys that can be pressed any time to activate special functions of the computer. Most hot keys operate in a cyclic way. Each time a hot key combination is pressed, it shifts the corresponding function to the other or next choice.

You can easily identify the hot keys with the icons imprinted on the keypad. The hot keys are described next.

Key	Description
Fn + F2	Switches the wireless LAN radio on and off. NOTE: This function works only if an optional mini PCI-E wireless LAN card is installed.
Fn + F3	Decreases the sound volume.
Fn + F4	Increases the sound volume.
Fn + F5	Decreases the LCD backlight. NOTE: 20 backlight levels are provided from 0 to 20. The LCD backlight off is level 0 and the maximum LCD backlight is level 20. According to the ambient light, the light sensor can automatically adjust the original LCD backlight value from 70 % to 150 %. But LCD backlight level 0 and level 1 cannot be adjusted by the light sensor.
Fn + F6	Increases the LCD backlight (see also “NOTE” on Fn + F5).
Fn + F7	Switches the system sound output off (mute) and on.
Fn + F8	Switches LCD on and off.

Key	Description
Fn + F9	Switches the display output when external devices are connected. NOTE: This function only applies to Plug & Play display devices.
Fn + F10	Serves as the sleep button that you can define with Windows' Power Options . (See the "Power Management" in Chapter 3.)

Euro Symbol

You can press the euro dollar sign € on various keyboards.

- To press the euro sign on a United States-International keyboard, hold down the **Alt Gr** key and press **5** (which has an euro sign on it).
- To press the euro sign on a standard United States keyboard, hold down either of the **Alt** keys and type **0128** on the numeric keypad part of your keyboard.
- To press the euro sign on an UK keyboard, hold down the **Alt Gr** key and press **4** (which has an euro sign on it).

Windows Keys

The keyboard has two keys that perform Windows-specific functions.

The  Windows Logo key opens the **Start** menu and performs software-specific functions when used in combination with other keys.

The  Application key usually has the same effect as a right mouse click. (See your Windows manual for more information.)

Using the Touchpad

CAUTION: Do not use a sharp object such as a pen on the touchpad. Doing so may damage the touchpad surface.

NOTE: For optimal performance of the touchpad, keep your fingers and the pads clean and dry. When tapping on the pad, tap lightly. Do not use excessive force.

The touchpad is a pointing device that allows you to communicate with the computer by controlling the location of the pointer on the screen and making selection with the buttons.

The touchpad consists of a rectangular pad and a left and right buttons. To use the touchpad, place your forefinger or thumb on the pad. The rectangular pad acts like a miniature duplicate of your display. As you slide your fingertip across the pad, the pointer (also called cursor) on the screen moves accordingly. When your finger reaches the edge of the pad, simply relocate yourself by lifting the finger and placing it on the other side of the pad.

Here are some common terms that you should know when using the touchpad:

Term	Action
Point	Move your finger on the pad until the cursor points to the selection on the screen.
Click	Press and release the left button. –or– Tap gently anywhere on the pad.
Double-click	Press and release the left button twice in quick succession. –or– Tap twice on the pad rapidly.

Term	Action
Drag and drop	<p>Press and hold the left button, then move your finger until you reach your destination (drag). Finally, release the button (drop) when you finish dragging your selection to the destination. The object will drop into the new location.</p> <p>–or–</p> <p>Gently tap twice on the pad and on the second tap, keep your finger in contact with the pad. Then, move your finger across the pad to drag the selected object to your destination. When you lift your finger from the pad, the selected object will drop into place.</p>
Scroll	<p>To scroll is to move up and down or left and right in the working area on the screen.</p> <p>To move vertically, place your finger on the right or left edge of the pad and slide your finger up and down along the edge. To move horizontally, place your finger on the top or bottom edge of the pad and slide your finger left and right.</p> <p>This function works only after you install the touchpad driver supplied with the computer and it may not work for all applications.</p>

TABLE NOTE: If you swap the left and right buttons, “tapping” on the touchpad as an alternative method of pressing the left button will no longer be valid.

Configuring the Touchpad

You may want to configure the touchpad to suit your needs. For example, if you are a left-handed user, you can swap the two buttons so that you can use the right button as the left button and vice versa. You can also change the size of the on-screen pointer, the speed of the pointer, and so on.

To configure the touchpad, you can use the standard Microsoft or IBM PS/2 driver if you are using Windows.

Using the Touchscreen

NOTE:

- This function is not available if your computer comes with the Active Digitizer feature.
- Make sure the touchscreen driver has been installed properly (see chapter 6 for details).

CAUTION: Do not use a sharp object such as a ballpoint pen or pencil on the touchscreen. Doing so may damage the touchscreen surface. Use your finger or the included touchscreen pen (option).

The touchscreen is a touch-sensitive device that allows you to easily use the computer without a mouse or touchpad to communicate with the computer by controlling the location of the pointer on the screen and making selection with the buttons.

Here are some common terms that you should know when using the touchscreen:

Term	Action
Click/Point	Tap gently on the touchscreen.
Double-click	Tap twice on the touchscreen rapidly.
Drag and drop	Press lightly on the touchscreen and move your finger until you reach your destination (drag). Finally, release your finger (drop) when you finish dragging your selection to the destination. The object will drop into the new location.

Using the Active Digitizer Feature

NOTE:

- This function is not available if your computer comes with the touchscreen function.
- Make sure the digitizer driver has been installed properly (see chapter 6 for details).

CAUTION: Do not use a sharp object such as a ballpoint pen or pencil on the LCD display. Doing so may damage the display surface. Use your finger or the included digitizer pen (option).

The active digitizer feature allows you to easily use the computer without a mouse, keyboard, or touchpad to communicate with the computer by controlling the location of the pointer on the screen and making selection with the buttons.

When using the digitizer pen, be sure to install the included size “AAAA” battery and press on the button on the side.

Here are some common terms that you should know when using the active digitizer feature:

Term	Action
Click/Point	Tap gently on the display.
Double-click	Tap twice on the display rapidly.
Drag and drop	Press lightly on the display and move your finger until you reach your destination (drag). Finally, release your finger (drop) when you finish dragging your selection to the destination. The object will drop into the new location.

Using the Hard Disk Drive

Your computer comes with a removable hard disk drive as drive C. A hard disk drive is a storage device with non-removable, rotating, magnetic storage platters inside it. It is where your operating system and application software programs are stored.

Your hard disk drive is a 2.5-inch SATA (serial ATA) hard disk drive. This type of drive embodies the latest in fast, reliable mass storage by integrating all the control circuitry necessary for operation directly onto the drive itself.

The system may come with an optional heater that automatically turns on for low temperature operation.

NOTE:

- To use the HDD heater feature, the MTCCTRL driver supplied with your computer must be installed (see chapter 6 for details).
- Make sure the “HDD Heater” item is set properly in the BIOS Setup program. (See “Advanced Menu” in chapter 5 for information.)

CAUTION:

- Make regular backups of your data files from your hard disk drive to USB flash disks or other storage media.
- Never try to remove or install the hard disk drive while the computer is powered on. Doing so can result in loss of data, and can damage the computer and the hard disk drive’s sensitive circuitry.
- Never turn off or reset the computer while the hard disk drive in-use indicator is on.

Replacing the Hard Disk Drive

To replace the hard disk drive:

1. Make sure that system power is off.
2. Remove the battery pack (see chapter 3 for details).
3. Locate the hard disk drive slot on the right side of the system.

4. Open the hard disk drive slot cover by pressing on both sides of the release latch using your thumb and index fingers.
5. Pull on the ribbon film to remove the hard disk drive bracket.
6. Remove the three front and two rear screws securing the hard disk drive to the bracket and remove the bracket cover.
7. Place the new hard disk drive into the bracket and tighten the three front and two rear screws.
8. Slide the HDD bracket into the slot until it reaches the end.
9. Close the hard disk drive slot cover to secure the HDD bracket.

Using the Video Features

The video subsystem of your computer features:

- 10.4-inch wide TFT (Thin-Film Transistor) color LCD display with 1024×768 XGA resolution or 12.1-inch wide TFT (Thin-Film Transistor) color LCD display with 1280×800 WXGA resolution
- Simultaneous display on LCD and external monitor, which is useful when you have a presentation as you can control the screen from your computer and face the audience at the same time (option)
- Multi-display capability, which allows you to expand your desktop on the screen to another display device so that you have more desktop space to work on
- Power Management
- Sunlight-readable LCD display (option)

NOTE:

- Before using the multi-display capability or taking advantage of the enhanced video capabilities, the device driver supplied with your computer must be installed. (See chapter 6 for details.)
- The computer enters the Standby or Hibernation mode when the LCD is closed. If you want to use the computer with the LCD closed, set *Do Nothing* to the “When I close the lid of my portable computer” option in the **Power Options** Properties. Thus the computer does not enter the Standby or Hibernation mode when the LCD is closed.

Configuring the Display Modes

NOTE: When using an external CRT monitor, the resolution depends on the CRT monitor’s supported resolution.

Your computer has been set to a default resolution and number of colors before shipment. You can view and change display settings through your operating system. See your operating system documentation or online help for specific information.

For displaying in higher resolutions, you can connect an external monitor that supports higher resolutions. (See “Connecting an External Monitor” in Chapter 4 for more information.)

Using the Audio Features

NOTE:

- To take advantage of the enhanced audio capabilities, the device driver supplied with your computer must be installed. (See chapter 6 for details.)
- If you experience interference while recording, try lowering the microphone recording volume.

The audio subsystem of your computer features:



- Built-in sound system for recording and playing sound on your computer
- Azalia interface (high density audio codec)
- Speaker (❶) (located on bottom side) and
- External audio connectors (❷)

Ways of playing and recording sound vary with the operating system used. See your operating system documentation or online help for specific information.

Connecting Audio Devices

For higher audio quality, you can send or receive sound through external audio devices.

NOTE: After connecting an external audio device, make sure that you specify the use of the correct audio device in Windows.

- **Audio Output Connector** () can be connected to speakers, headphones, or earphone set.
- **Microphone Connector** () can be connected to an external microphone for recording voice or sound.

NOTE: When using the external speakers/headphones or microphone, you cannot use the internal one.

Using the Communication Features

Using the Modem

NOTE: To take advantage of the modem feature, the device driver supplied with your computer must be installed. (See chapter 6 for details.)

The internal 56 K fax/data modem allows you to use the telephone line to communicate with others by fax, email, or connect to an online service or bulletin board.

To connect the telephone line to the modem, connect one end of the modem cable to the RJ-11 connector on the computer and the other end to the phone line.

NOTE:

- When using the communication software, you may have to disable power management.
- Set the COM port of the modem to COM3.
- Set parameters such as modem speed (baud rate) and line type (pulse dialing or tone dialing).
- Do not enter the Standby mode when using the communication software.

Using the LAN

NOTE: To take advantage of the LAN feature, the device driver supplied with your computer must be installed. (See chapter 6 for details.)

The internal 10/100/1000Base-T LAN (Local Area Network) module allows you to connect your computer to a network. It supports data transfer rate up to 1000 Mbps.

To connect the network cable to the LAN module, connect one end of the LAN cable to the RJ-45 connector on the computer and the other end to the network hub.

Using the GPS (Optional)

NOTE: To take advantage of the GPS feature, the GPS driver supplied with your computer must be installed (see chapter 6 for details).

Navigation and positioning are crucial to so many activities. To try to figure out where you are and where you are going, you need GPS technology. The Global Positioning System (GPS) is a worldwide radio-navigation system.

Turning On/Off the GPS

1. Click **Start** and then **Programs**.
2. Click **Holux** and then **GPS Viewer**. The following screen appears.

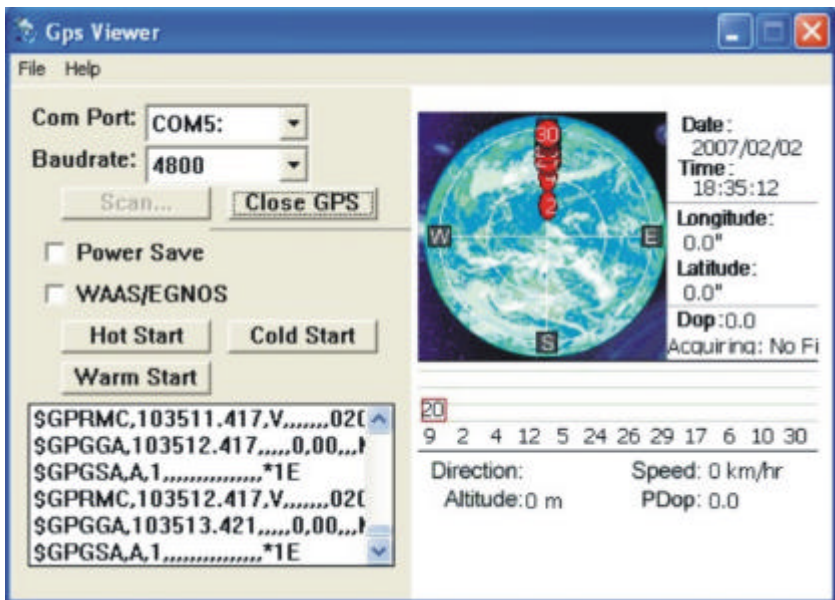

3. Click **Scan** to get started.
4. To close GPS, click **Close GPS**.

For detailed information on using the GPS Utility, see the GPS Utility Help on your computer by clicking on **Help**.

Managing Power

Your computer operates either on external AC power or on internal battery power.

This chapter tells you how you can effectively manage power. To maintain optimal battery performance, it is important that you use the battery in the proper way.

The topics in this chapter include:

- What is an AC adapter
- How to charge the battery pack
- When and how to initialize the battery pack
- How to use the Battery Automatic Calibration Utility
- How to check the battery level
- How to replace the battery pack
- What happens when the battery is low and what actions to take
- What is Power Management
- How to save power

AC Adapter

CAUTION:

- The AC adapter is designed for use with your computer only. Connecting the AC adapter to another device can damage the adapter.
- The AC power cord supplied with your computer is for use in the country where you purchased your computer. If you plan to go overseas with the computer, consult your dealer for the appropriate power cord.
- When you disconnect the AC adapter, disconnect from the electrical outlet first and then from the computer. A reverse procedure may damage the AC adapter or computer.
- When unplugging the connector, always hold the plug head. Never pull on the cord.

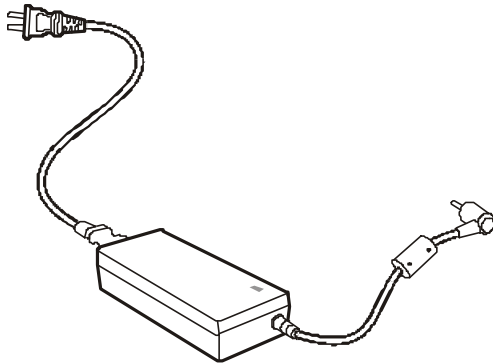

The AC adapter serves as a converter from AC (Alternating Current) to DC (Direct Current) power because your computer runs on DC power, but an electrical outlet usually provides AC power. It also charges the battery pack when connected to AC power.

The adapter operates on any voltage in the range of 100~240 V AC.

Battery Pack

The battery pack is the internal power source for the computer. It is rechargeable using the AC adapter.

The operating time of a fully charged battery pack depends on how you are using the computer. When your applications often access peripherals, you will experience a shorter operating time.

NOTE: Care and maintenance information for the battery is provided in the “Battery Pack Guidelines” section in Chapter 7.

Charging the Battery Pack

NOTE:

- Charging will not start if the battery’s temperature is below 0 °C (32 °F) or above 60 °C (140 °F).
- The charging process will stop and the Battery Charge Indicator flashes green when the battery’s temperature gets above 60 °C (140 °F). If this happens, the battery pack may be damaged. Please contact your dealer.
- During charging, do not disconnect the AC adapter before the battery has been fully charged; otherwise you will get a prematurely charged battery.

To charge the battery pack, connect the AC adapter to the computer and an electrical outlet. The Battery Charge Indicator () on the computer glows orange to indicate that charging is in progress. You are advised to keep the computer power off while the battery is being charged. When the battery is fully charged, the Battery Charge Indicator is off.

The charging times are as follows:

Battery Type	Charging Time	
	Computer is Off	Computer is On and in Idle State
5200 mAH	Less than 180 minutes (3 hours)	Less than 360 minutes (6 hours)

CAUTION: After the computer has been fully recharged, do not immediately disconnect and reconnect the AC adapter to charge it again. Doing so may damage the battery.

NOTE: The battery level may automatically lessen due to the self-discharge process (0.21 % per day), even when the battery pack is fully charged (100 %). This happens no matter if the battery pack is installed in the computer.

Initializing the Battery Pack

You need to initialize a new battery pack before using it for the first time or when the actual operating time of a battery pack is much less than expected.

Initializing is the process of fully charging, discharging, and then charging. It can take several hours.

1. Make sure that the computer power is turned off. Connect the AC adapter to fully charge the battery pack.
2. After the battery pack is fully charged, turn on the computer. Press the **Enter** key or click the left touchpad button when the prompt appears on the screen during system startup. The prompt shows up on the screen for only a few seconds. You must press the **Enter** key or click the left touchpad button quickly.
3. A small window appears, select **Launch System Setup** to invoke the program.
4. Disconnect the AC adapter and leave the computer on until the battery is fully discharged. The computer will shut down automatically.
5. Connect the AC adapter to fully charge the battery pack.

Battery Automatic Calibration Utility

NOTE: To use the Battery Automatic Calibration Utility, the BT Calibration driver supplied with your computer must be installed (see chapter 6 for details).

After installing the Battery Pack Automatic Calibration Utility, the **Battery Monitor** will call up the **Battery Learning** program every month. Every once-a-month the **Battery Monitor** will check if the battery temperature is between 10 °C and 39 °C. When it is between 10 °C and 39 °C, the following screen appears.

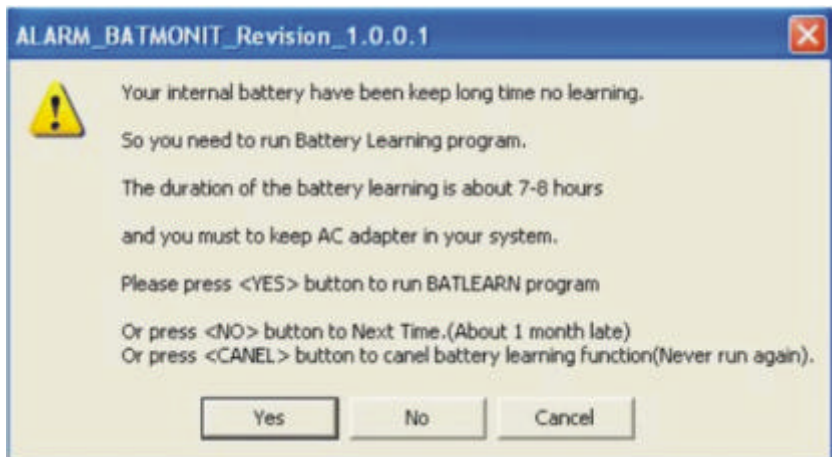

Click **Yes** to run the **Battery Learning** program's recalibration function to fully charge the battery pack, discharge it completely, then fully charge it again.

Click **No** if you do not wish to run the **Battery Learning** program's recalibration function now.

Click **Cancel** if you do not wish the **Battery Monitor** to call up the **Battery Learning** program every month to run the **Battery Learning** program's recalibration function.

Error Messages

The battery's performance would degrade as part of its normal wear-and-tear after using it for a considerable length of time. The **Battery Monitor** program would check the battery's condition and may display the following error messages. You are recommended to replace the battery.

Error Message	What it means ...
The Battery is BAD !! Battery Discharge FAIL, Discharge Timer <= Minimum Discharge Time	Battery's performance has gradually deteriorated. The discharge time is quite short.
The Battery is BAD !! Battery Charge FAIL, Charge Timer over time	Battery's performance has deteriorated. It cannot be charged.
The Battery is BAD !! Battery Charge FAIL, Charge Timer <= Minimum Charge time	Battery's performance has gradually deteriorated. Battery capacity is too little.
The Battery is BAD !! Battery Discharge FAIL, Discharge Timer >= Maximum Discharge Time	Battery's discharge circuit is bad. It cannot discharge.



NOTE: Running the Battery Learning program does not increase the battery's capacity.

CAUTION: Performing Battery Learning at frequent intervals will degrade the battery pack.

Checking the Battery Level

NOTE: Any battery level indication is an estimated result. The actual operating time can be different from the estimated time, depending on how you are using the computer.

By Operating System

You can check the approximate battery level using the battery meter function of the operating system. To read the battery level in Windows, click the  icon on the taskbar. (Click the  icon if the computer is using AC power.)

By Gas Gauge

On the exterior side of the battery pack is a gas gauge for displaying the estimated battery charge. When the battery pack is not installed in the computer and you want to know the battery charge, you can press the on/off switch with a pointed device to see the corresponding value of indicator segment that light green. The value of the corresponding green segment indicates the relative percentage of the battery charge. The battery pack is fully discharged when you see no segment glowing green.

Replacing the Battery Pack

CAUTION:

- There is danger of explosion if the battery is incorrectly replaced. Replace the battery only with the computer manufacturer's optional battery packs. Discard used batteries according to the dealer's instructions.
- Do not attempt to disassemble the battery pack.

If you often rely on battery power for a long period of time while traveling, you may consider the purchase of an additional battery pack from your dealer and keep it with you in a fully charged state as a backup.

To replace the battery pack, follow these steps:

1. Make sure that the computer is not turned on or connected to AC power.

2. Locate the battery compartment on the right side of the computer.
3. Open the compartment cover by pressing on both sides of the release latch using your thumb and index fingers.
4. Pull on the ribbon strip to remove the battery pack and replace it with a new one.
5. Slide the new battery pack all the way into the slot. Make sure to observe the correct orientation (the ribbon strip must face outward for future battery back removal).
6. Close the compartment cover to secure the battery pack.

Battery Low Signals and Actions

Battery Low occurs when the battery has approximately 10 % (Windows default setting) of its charge remaining. The computer gives warning beeps or messages and the Battery Charge Indicator () blinks orange to alert you to take actions.

NOTE: You can set up your threshold and signals of Battery Low under Windows.

Immediately save your data upon Battery Low. The remaining operating time depends on how you are using the computer. If you are using the audio subsystem, PC card, hard or USB flash disk, the battery might run out of charge very quickly.

Always respond to Battery Low by placing your computer on the Standby or Hibernation mode, turning off the computer, or connecting the AC adapter.

If you do not take any action, the computer will automatically hibernate and turn off.

CAUTION:

- If you are using a PC card, do not access the card during battery low periods. This is because the access may take longer than the time it takes the battery to run out of charge, thus making your access to the card unsuccessful.
- If you fail to save your data when the battery completely runs out of charge, then you lose your data.

Power Management

Your computer supports ACPI (Advanced Configuration and Power Interface) for power management. The power management feature allows you to reduce the power consumption for energy saving.

With an ACPI-compliant operating system such as Windows XP, power supply to different computer components is controlled on an as-needed basis. This allows maximum power conservation and performance at the same time.

In general, Windows' power management works in this way:

What...	When...
Power to the hard disk is turned off	When the hard disk has been idle for a set period.
Power to the display is turned off	When the display has been idle for a set period.
The computer enters the Standby mode. The hard disk and display are turned off and the entire system consumes less power.	When the entire system has been idle for a set period.
	When you press the Fn+F10 hot key. *
	When you close the cover. *
The computer enters the Hibernation mode. (See the next subsection for more information.)	When you press the Fn+F10 hot key. *
	When you close the cover. *
	When you press the power button. *

* Depends on your settings in Windows.

For detailed information on power management, see Windows' Help.

Hibernation

NOTE: Make sure that the hibernation feature is enabled in the **Hibernate** tab of the **Power Options** Properties from the Control Panel in Windows XP.

Hibernation is a very useful feature. People frequently open many applications when they use computers. It takes some time to get all these applications open and running, and normally they all have to be closed before the computer can be turned off.

When you use the hibernation feature, you do not have to close the applications. The computer stores the state of your computer to a file on the hard disk and then shuts down. The next time you turn on your computer, you return to exactly where you left off.

Power-Saving Tips

Aside from enabling your computer's power saving mode (see previous section), you can do your part to maximize the battery's operating time by following these suggestions.

- Do not disable Power Management.
- Decrease the LCD brightness to the lowest comfortable level.
- If you work with an application that uses a PC card, exit the application when you finish using it.
- If you have a PC card installed, remove it when not in use. Some PC cards drain power even while they are inactive.
- Turn off the computer when you are not using it.

Expanding Your Computer

You can expand the capabilities of your computer by connecting other peripheral devices. When using a device, be sure to read the instructions accompanying the device together with the relevant section in this chapter.

This chapter gives guidelines on installing and using these devices:

- External monitor (option)
- Serial device
- USB device
- PC card
- Card Reader

Connecting an External Monitor (option)

If you want the benefits of a larger display screen with higher resolution, you can connect an external display monitor to your computer. Follow this procedure to connect an external monitor:

1. Make sure that the computer is not turned on.
2. Plug the monitor's D-type signal connector to the computer's VGA connector.
3. Plug one end of the monitor's power cord into the power socket on the monitor and the other end to an electrical outlet.
4. To use the monitor, turn on the monitor before turning on the computer.
5. The monitor should respond by default. If not, you can switch the display to the monitor or to both (simultaneous display), or to multi-display by pressing the **Fn+F9** hot key. In Windows, you can also change the display through the settings in **Display** Properties.
6. You can change display settings through your operating system. See your operating system documentation or online help for specific information.

CAUTION: Do not disconnect the external monitor while the computer is in the Standby mode or Hibernation mode. If no external monitor is connected when the computer resumes, the LCD might not display properly.

Connecting a Serial Device

Your computer has one or two serial port (depending on model) for connecting a serial device such as a serial mouse or serial communication device (modem).

Follow this procedure to connect a serial device:

1. Make sure the “Serial Port COM1/COM2” item is set properly in the BIOS Setup program. (See “Advanced Menu” in Chapter 5 for information.)
2. Make sure the computer is not turned on.
3. Plug the device cable to the serial port on the rear of the computer.
4. Turn on the computer.

NOTE: Portable modems that derive power through the serial port cannot be used with the computer. Instead, use a modem that is powered by its own internal battery or external AC power.

Connecting a USB Device

Your computer has two USB ports for connecting USB devices, such as a digital camera, scanner, printer, modem, and mouse.

USB (Universal Serial Bus) is specified to be an industry standard extension to the PC architecture. It supports “Plug-and-Play” technology so you can install and remove USB devices without turning off the computer. With its multiple connection capability, up to 127 devices can be connected in a daisy-chain configuration. In addition, you can use a USB hub that converts a single USB connector into multiple ports where USB devices can be connected.

The USB ports support transfer rates up to 12 MB/s for USB 1.1 devices and 480 MB/s for USB 2.0 devices.

To connect a USB device, simply plug the device cable to one of the USB ports.

Using PC Cards

Your computer has two PC card slot.

PC cards are credit card-sized peripheral products based on the standards developed by PCMCIA (Personal Computer Memory Card International Association). PCMCIA is a non-profit association for promoting the interchangeability among mobile computers where ruggedness, low power, and small size are critical.

PC Card Type

Your computer's PC card slots can accommodate a type II card. Typical type II cards are flash memory, SRAM, modem, LAN, and SCSI cards.

CardBus Support

Your computer's PC card slot supports CardBus specifications. CardBus is the 32-bit version of PC card technology. It allows speeds of up to 133 Mbps at 33 MHz. Typical applications are SCSI host bus and high-speed network cards.

Inserting and Removing a PC Card

NOTE:

- Some PC cards require additional system resources. Before using such PC card, you may have to free other system resources for the PC card.
- Although some PC cards can be inserted and removed without turning off the computer, you cannot remove or install PC cards during Standby mode.

To insert a PC card:

1. Locate the PC card slot on the left side of the computer.
2. Slide the PC card, with its label facing up, into the slot until the eject button pops out.

3. When a new card is seated, the computer will detect it and try to install the appropriate driver. Follow the on-screen instructions to complete the process.

To remove a PC card:

1. Double-click on the **Safely Remove Hardware**  icon found on the Windows XP taskbar and the **Safely Remove Hardware** window appears on screen.
2. Select (highlight) the PC card from the list to disable the card.
3. Push the eject button and the card will slide out slightly.
4. Pull the card out of the slot.

Using the Card Reader

NOTE:

- If your hard disk is divided into several drives, make sure that all drives have been formatted before using the Card Reader. Otherwise, you may encounter problems when using the Card Reader.
- You can use only storage cards. Your Card Reader does not support cards with I/O (input/output) functions such as a wireless network card or Bluetooth card.

Your computer has a Card Reader. The Card Reader is a small drive for reading from and writing to removable storage cards (or called memory cards). The Card Reader supports Secure Digital (SD) cards.

Shown next is the appearance and size of Secure Digital (SD) card type for your reference.



24×32×2.1 (mm)

To insert a storage card:

1. Locate the Card Reader slot on the left side of the computer.
2. Align the card with its connector pointing to the slot and its label facing up. Slide the card into the slot until it reaches the end.
3. Windows will detect the card and assign it a drive name (typically E).

To remove a storage card:

1. Double-click **My Computer**.
2. Right-click the drive with the card and select **Eject**.
3. Pull the card out of the slot.

System Memory Upgrade

You can upgrade your computer by changing system memory to a maximum of 1 GB on the 533 MHz DDR2 SO-DIMM slot.

To install the SO-DIMM:

1. Carefully place the notebook computer upside down.
2. Remove the two screws to open the SO-DIMM compartment cover.
3. To install the SO-DIMM, match the SO-DIMM's notched part with the socket's projected part and firmly insert the SO-DIMM into the socket at a 20-degree angle. Then push down until the retaining clips lock the SO-DIMM into position.
4. Close the SO-DIMM compartment cover and secure with two screws.

Using BIOS Setup

BIOS Setup Utility is a program for configuring the BIOS (Basic Input/Output System) settings of the computer.

BIOS is a layer of software, called firmware, that translates instructions from other layers of software into instructions that the computer hardware can understand. The BIOS settings are needed by your computer to identify the types of installed devices and establish special features.

This chapter tells you how to use the BIOS Setup program.

When and How to Use BIOS Setup

When to Use

You need to run BIOS Setup Utility when:

- You see an error message on the screen requesting you to run BIOS Setup Utility.
- You want to restore the factory default settings.
- You want to modify some specific settings according to the hardware.
- You want to modify some specific settings to optimize the system performance.

Starting BIOS Setup

NOTE:

- The BIOS Setup Utility screens shown in this chapter are for your reference only. The actual items or settings on your computer may differ.
- The BIOS Setup Utility program may have been updated after the publication of this manual.
- The settings you select in your operating system might override similar settings in BIOS Setup Utility.

To run BIOS Setup Utility, press the **Enter** key or click the left touchpad button when the prompt appears on the screen during system startup. The prompt shows up on the screen for only a few seconds. You must press the **Enter** key or click the left touchpad button quickly. A small window appears, select **Launch System Setup**. The BIOS Setup Utility main screen appears as shown next.



The BIOS Setup Utility screen can be divided into four areas:

- On the top is the menu bar containing the titles of the available menus. Each menu title brings a specific menu.
- The left column of the menu displays the menu items.
- The right column of the menu provides more detailed information when a menu item is highlighted.
- The bottom of the menu provides keyboard instructions for moving around and making selections.

Moving Around and Making Selections

You must go through two or three levels to complete the setting for an item. In most cases, there are two levels: menu title and submenu.

Use the keyboard to move around and make selections. Keyboard information can be found at the bottom of the screen. A brief description of keyboard usage is listed next:

Key	Function
← , →	Selects a menu title.
↑ , ↓	Selects an item or option.
+ / -	Changes the value.
Enter	1) Brings up the sub-menu when available. 2) Opens or closes the option window when an item is selected.
Esc	1) Exits BIOS Setup Utility. 2) Closes the option window if one is open.
F1	Provides help information.
F9	Loads setup defaults.
F10	Saves and exit the BIOS Setup Utility.

Main Menu

The Main menu contains the system date and time settings as well as shows the basic configuration of the system.

Main		Advanced	Security	Boot	Exit	Item Specific Help
Model:	V100					
SATA Hard Disk 0	TOSHIBA MK8032GSX-(S1)					<Tab>, <Shift-Tab>, or
SATA Hard Disk 1	None					<Enter> selects field.
System Time:	[10:34:08]					
System Date:	[01/18/2007]					
CPU Type	Genuine Intel(R) CPU					
CPU Speed	1200 MHz					
Extended Memory	514048 KB					
System BIOS Version:	R0.00TT					
KBC/EC BIOS Version:	R0.00Y					
F1: Help	↓↑ Select Item	+/- Change Values	F9: Setup Defaults			
Esc: Exit	←→ Select Menu	Enter: Select ► Sub-Menu	F10: Save and Exit			

System Time sets the system time.

System Date sets the system date.

Advanced Menu

The Advanced menu contains the advanced settings as below.

Main	Advanced	Security	Boot	Exit	Item Specific Help
▶ ACPI Control Sub-menu					Item Specific Help These items will control: 1) Which ACPI Tables will be included in the RSDS Entry Table Field. 2) The values stored in specific ACPI Table Fields. 3) The enabling of Specific ACPI features.
SATA AHCI Configuration:		[Disabled]			
HDD Heater:		[Enabled]			
HDD Protection:		[Enabled]			
Falling Time to Park HDD:		[50]			
Digitizer Type:		[AIP1040]			
Serial Port COM1:		[Enabled]			
Serial Port COM2:		[Enabled]			
Serial Port COM4:		[Enabled]			
Boot-time Diagnostic Screen:		[Disabled]			
F1: Help ↓↑ Select Item +/- Change Values F9: Setup Defaults Esc: Exit ← Select Menu Enter Select ▶ Sub-Menu F10: Save and Exit					

ACPI Control Sub-menu

Move the cursor to this item and press the **Enter** key to go into the submenu.

Advanced				Item Specific Help
ACPI Control Sub-menu				Item Specific Help This value controls the temperature of the ACPI Active Trip Point – the point in which the OS will turn the CPU fan on. NOTE: If the DTS is enabled, only values below 97 C are valid.
Active Trip Point:		[55 C]		
Passive Cooling Trip Point:		[93 C]		
Passive TC1 Value:		[0]		
Passive TC2 Value:		[10]		
Passive TSP Value:		[15]		
Critical Trip Point:		[POR]		
FACP – RTC S4 Flag Value:		[Disabled]		
FACP – PM Timer Flag Value:		[Enabled]		
HPET Support:		[Enabled]		
HPET Base Address:		[0xFED00000]		
ALS Support:		[Cannot_Find_String]		
EMA Support:		[Disabled]		
MEF Support:		[Disabled]		
F1: Help ↓↑ Select Item +/- Change Values F9: Setup Defaults Esc: Exit ← Select Menu Enter Select ▶ Sub-Menu F10: Save and Exit				

Active Trip Point controls the temperature of ACPI Active Trip Point – the point in which OS will turn the CPU fan on.

Passive Cooling Trip Point controls the temperature of ACPI Passive Trip Point – the point in which OS will begin throttling the CPU.

NOTE: If the DTS is enabled, only values below 97 °C are valid.

Passive TC1/TC2 Value sets the TC1/TC2 values for the ACPI Passive Cooling formula.

Passive TSP Value sets the TSP values for the ACPI Passive Cooling formula. It represents in tenths of a second how often OS will read the temperature when Passive Cooling is enabled.

Critical Trip Point controls the temperature of ACPI Critical Trip Point – the point in which OS will shut the system off.

NOTE:

- 100 °C is POR for all Intel CPUs.
- If value is greater than 100 °C and DTS is enabled, the Out-of-Spec Bit will be used.
- The EC value will be set to 127 °C after ACPI initialization.

FACP – RTC S4 Flag Value is valid only for ACPI. Controls the value for the RTC S4 Flag in the FACP Table.

FACP – PM Timer Flag Value is valid only for ACPI. Controls the timer used by the OS through the FACP Table Flags. This is now possible with Windows XP Service Pack 2 and beyond.

HPET Support is valid only in Windows XP. Controls the High Performance Event Timer (HPET). When enabled, the HPET Table will then be pointed to by the RSDT and the proper enable bits will be set.

HPET Base Address selects the Base Address for the HPET.

ALS Support sets the automatic display brightness. When enabled, LCD backlight will automatically change according to ambient light luminance for saving power.

EMA/MEF Support is valid only for ACPI. Controls the EMA/MEF device in an ACPI environment.

SATA AHCI Configuration sets the enhanced AHCI. Windows XP Service Pack 1 + IAA driver supports AHCI mode.

HDD Heater sets if the system automatically turns on the built-in hard disk drive heater for low temperature operation.

NOTE:

- To use the HDD heater feature, the MTCCTRL driver supplied with your computer must be installed (see chapter 6 for details).
- Disable this item to conserve energy when using battery power.

HDD Protection enables automatic protection when computer with HDD is dropped.

Falling Time to Park HDD sets the time for EC to issue SMI to park HDD. The maximum is 127 in 5 milliseconds per unit. Set to 0 to disable it.

Digitizer Type sets the digitizer type that comes with your computer (*AIP1040* WALTOP, *WACF004* WACOM, or *FPI2004* FPI).

Serial Port COM1/COM2/COM4 allows you to unconditionally disable it when set at *Disabled*.

Boot-time Diagnostic Screen allows you to display the diagnostic screen during system boot-up.

Security Menu

The Security menu contains the TPM (Trusted Platform Module) setting. The TPM is a component on your computer's mainboard that is specifically designed to enhance platform security above-and-beyond the capabilities of today's software by providing a protected space for key operations and other security critical tasks. Using both hardware and software, TPM protects encryption and signature keys at their most vulnerable stages – operations when the keys are being used unencrypted in plain-text form. TPM is specifically designed to shield unencrypted keys and platform authentication information from software-based attacks.

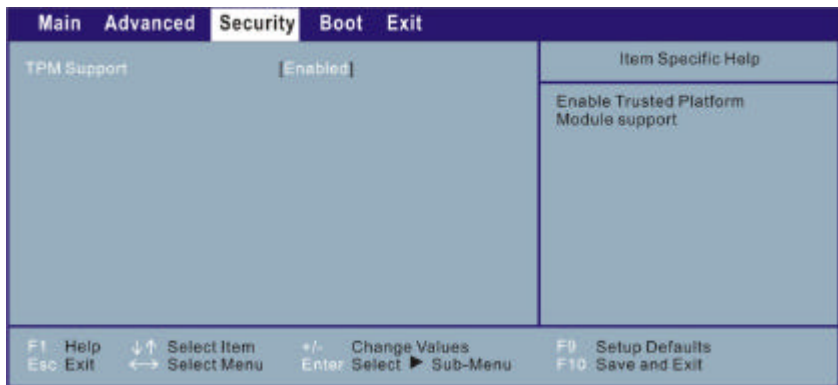

TPM Support enables or disables TPM support.

NOTE: To use the TPM feature, the TPM driver supplied with your computer must be installed (see chapter 6 for details).

Boot Menu

The Boot menu sets the sequence of the devices to be searched for the operating system.

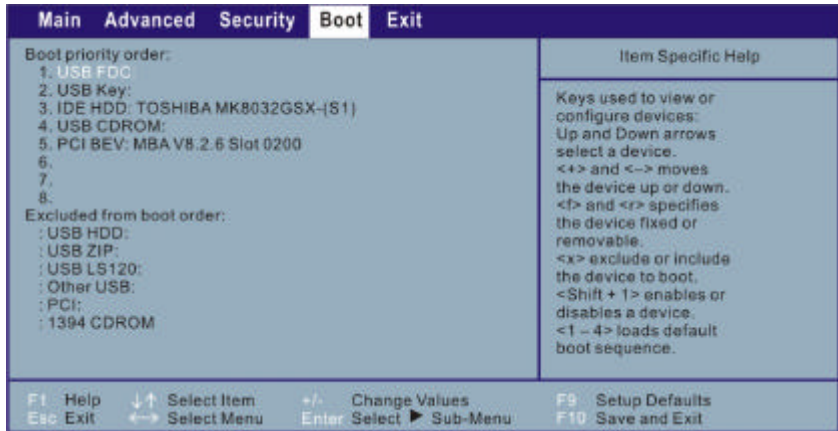

The bootable devices will be automatically detected during POST and shown here, allowing you to set the sequence that the BIOS uses to look for a boot device from which to load the operating system. A brief description of keyboard usage is listed next:

Key	Function
↑, ↓	Selects (highlight) a boot device.
+, -	Changes the boot sequence.
1 to 4	Loads the default boot sequence.
f or r	Specifies if the device is fixed (f) or removable (r).
X	Moves the highlighted boot device from the “Boot priority order” list to the “Excluded from boot order” list, and vice versa.
Shift + 1	Deactivates/activates the highlighted boot device on the “Boot priority order” list. When a device has been deactivated, an “!” (exclamation) symbol appears beside the item and system will bypass it when detecting boot device during POST.

Exit Menu

The Exit menu displays ways of exiting BIOS Setup Utility. After finishing with your settings, you must save and exit so that the changes can take effect.

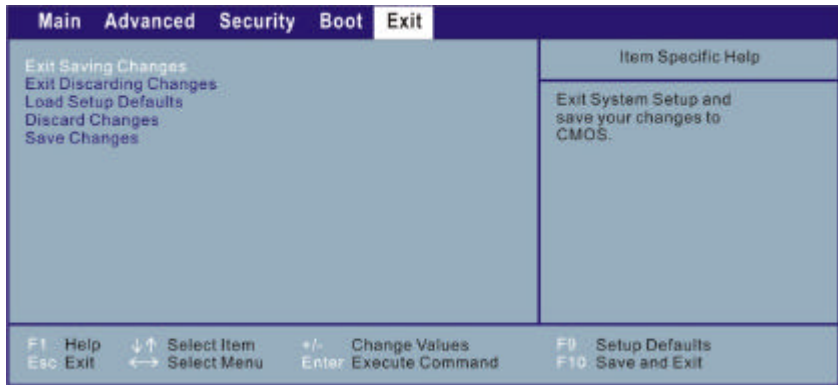

Exit Saving Changes saves the changes you have made and exits BIOS Setup Utility.

Exit Discarding Changes exits BIOS Setup Utility without saving the changes you have made.

Load Setup Defaults loads the factory default values for all the items.

Discard Changes restores the previous values for all the items.

Saves Changes saves the changes you have made.

Installing Software Drivers

To take full advantage of the unique features of your computer, some operating systems require custom software, known as drivers, to be installed.

If you purchased the computer with Windows pre-installed, your dealer may have already installed the drivers. If not, you need to install the drivers using the disc supplied with your computer.

This chapter describes how to install the drivers.

How to Use the Driver Disc

NOTE:

- The drivers may have been updated after this manual was published. For driver upgrade, please contact your dealer.
- This disc supports Windows XP only. You are recommended to install Windows XP Service Pack 2.
- The available items may differ according to your computer model.
- Do not remove the driver disc when installing the driver.

An autorun program is provided on the driver disc to help you easily install the drivers. As you insert the disc, the autorun program automatically starts. If you need to start the program manually, run the **Autorun.exe** program from the driver disc.

The main screen appears as shown next:



To install the necessary driver, just click on the particular option and follow the onscreen instructions to continue and complete installation.

Drivers on the First Page

- Device Driver* Ensures the full function of the following drivers. Install this main driver before installing the other drivers. Upon clicking this button, the chipset, VGA, audio, modem, and LAN drivers would be installed one after the other.
- TouchScreen* Allows you to use your fingers (or optional touchscreen pen) as a pointing device on the LCD screen.
- Digitizer* Allows you to use your digitizer pen (option) as a pointing device on the digitizer screen.
- TPM* Upon clicking on this, the following screen appears.



- Driver* Allows you to install the driver for using the TPM (Trusted Platform Module) support for security.
- Application* Allows you to install the TPM application.

GPS Upon clicking on this, the instructions for installing the GPS driver appears (refer to the next section for further instructions).

User Guide Allows you to view the Operation Manual on screen.

NOTE: You need Adobe Acrobat Reader to open the manual file supplied on this driver disc. Install the Adobe Acrobat Reader program if you do not have it on your computer by clicking on **Adobe Reader**.

Browse CD Browses the contents of the driver disc.

Exit Exits the driver installation.

Drivers on the Second Page

Upon clicking on *Next Page*, the following screen appears.

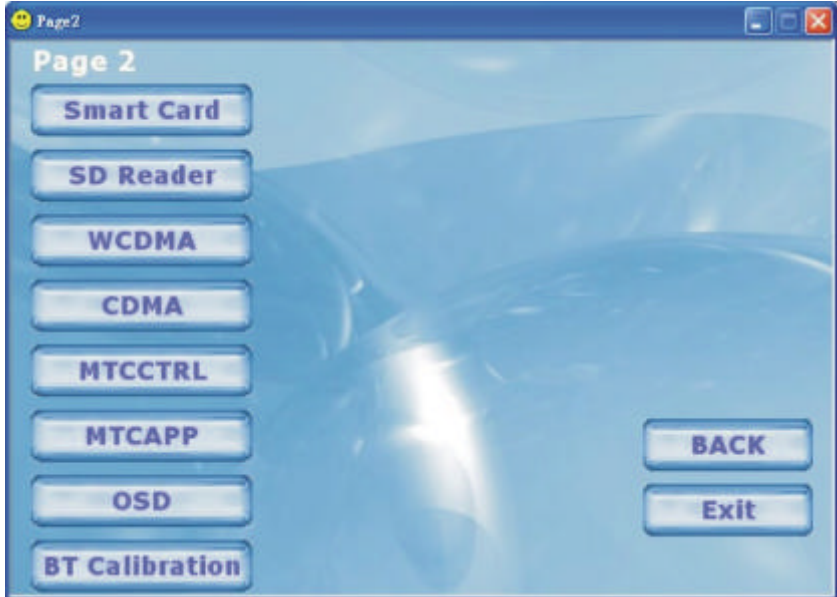

Smart Card Allows you to use the Smart Card Reader feature.

SD Reader Allows you to use the SD Reader feature.

WCDMA

Upon clicking on this, the following screen appears.

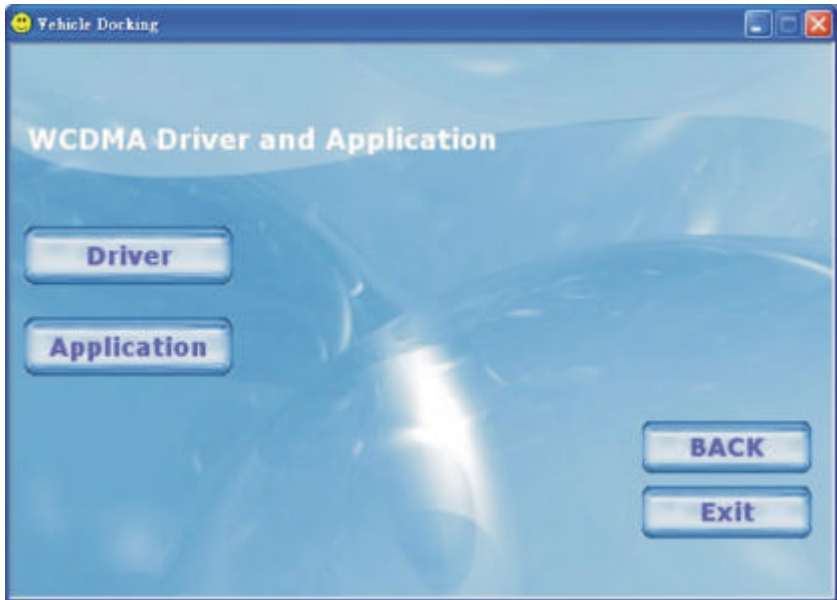

Driver Allows you to install the driver for using the WCDMA feature.

Application Allows you to install the WCDMA application.

CDMA Allows you to install the driver for using the CDMA feature.

MTCCTRL Allows you to use the built-in heater feature that automatically turns on for low temperature hard disk drive operation.

MTCAPP Allows you to use the MTCAPP feature.

OSD Installs the OSD (on screen display) utility that provides a graphic display to indicate the current status of certain operations.

NOTE: The OSD utility is an option for you. You can decide whether you would like to have this utility installed.

BT Calibration Upon clicking on this, the following screen appears.

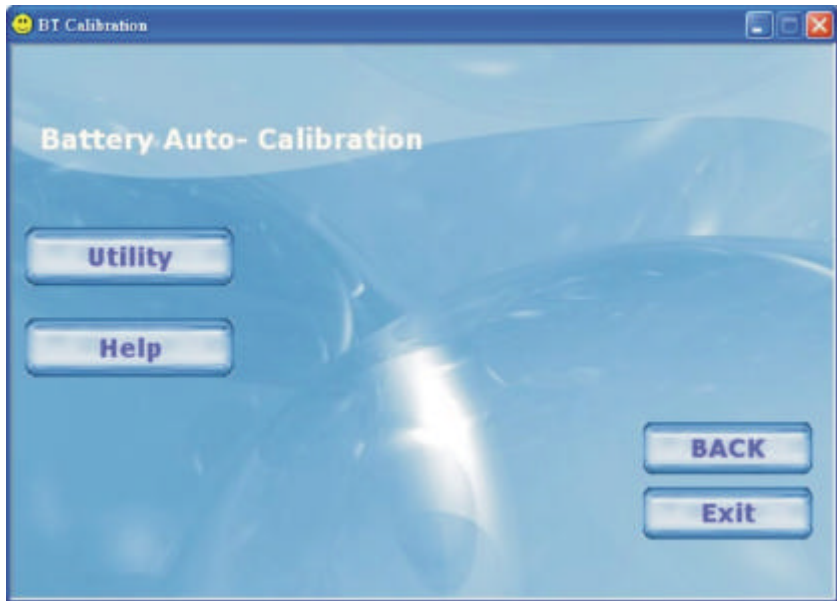

Utility Installs the battery pack automatic calibration utility that includes the Battery Monitor and Battery Learning programs.

Help Upon clicking on this, the instructions for using the battery pack automatic calibration utility appears (refer to the next section for further instructions).

NOTE: You need Adobe Acrobat Reader to open the User Guide. Install the Adobe Acrobat Reader program if you do not have it on your computer by clicking on **Adobe Reader**.

GPS Driver

To install the GPS driver, perform the following:

1. Insert the driver disc into the optical drive.
2. Click **Start** → **Run**.

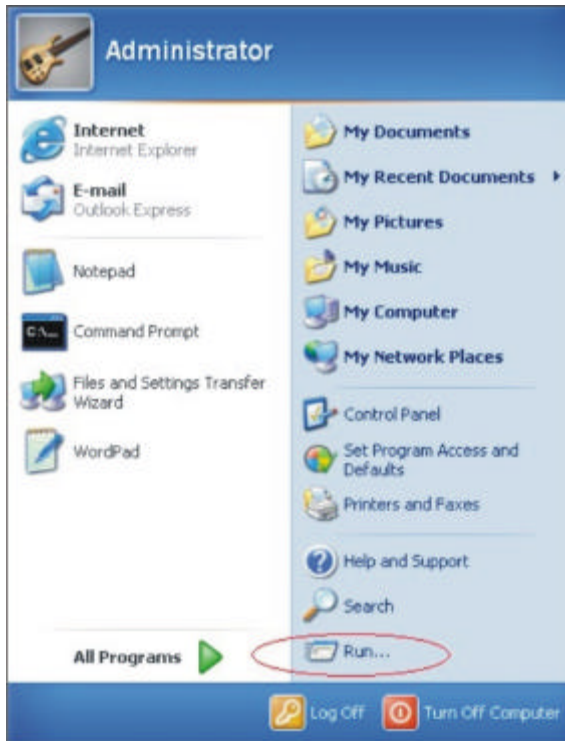

3. Enter the driver path and file name (e.g., **g:\GPS\PL-2303 Driver Installer_GPS.exe**), then click **OK**.

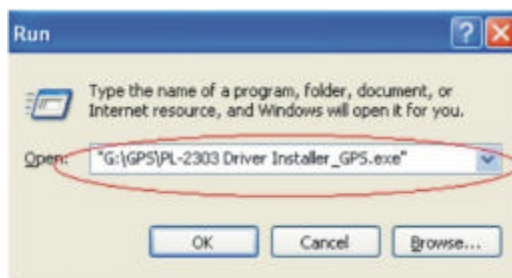

4. When the **InstallShield Wizard** screen appears, click **Next** to continue.
5. When the **Windows XP Logo Compatibility Test** screen appears, click **Continue Anyway**.
6. When the next screen appears, click **Finish** to exit the first part of the driver installation.
7. Re-boot your system for the changes to take effect.
8. After the system has finished rebooting, the **Found New Hardware Wizard** screen would appear. Select **Install the software automatically (Recommended)**, then click **Next**.
9. When the **Windows XP Logo Compatibility Test** screen appears, click **Continue Anyway**.
10. When the next screen appears, click **Finish** to complete driver installation.

Caring for the Computer

Taking good care of your computer will ensure a trouble-free operation and reduce the risk of damage to your computer.

This chapter gives you guidelines covering these areas of maintenance:

- How to protect the computer
- What to note when using and storing the computer
- How to clean the computer
- What to note when using the battery pack
- What to note when traveling with the computer

Protecting the Computer

To safeguard the integrity of your computer data as well as the computer itself, you can protect the computer in several ways as described in this section.

Using the Cable Lock

You can use a Kensington-type cable lock to protect your computer against theft. The cable lock is available in most computer stores.

To use the lock, loop the lock cable around a stationary object such as a table. Insert the lock to the Kensington lock hole and turn the key to secure the lock. Store the key in a safe place.

Using an Anti-Virus Strategy

New viruses are always being developed nowadays and they are attacking computers even more easily with emails so commonly used worldwide. You can install a virus-detecting program to monitor potential viruses that could damage your files.

Taking Care of the Computer

Location Guidelines

- Use the computer where the temperature is between 10 °C (50 °F) and 35 °C (95 °F).
- Avoid placing the computer in a location subject to high humidity, extreme temperatures, mechanical vibration, direct sunlight, or heavy dust.
- Do not cover or block any ventilation openings on the computer. For example, do not place the computer on a bed, sofa, rug, or other similar surface. Otherwise, overheating may occur that results in damage to the computer.
- Keep the computer at least 13 cm (5 inches) away from electrical appliances that can generate a strong magnetic field such as a TV, refrigerator, motor, or a large audio speaker.
- Do not move the computer abruptly from a cold to a warm place. A temperature difference of more than 10 °C (18 °F) will cause condensation inside the unit, which may damage the storage media.
- Do not place the computer on an unsteady surface.

General Guidelines

- Do not place heavy objects on top of the computer when it is closed as this may damage the display.
- The screen surface is easily scratched. Do not use paper towels to clean the display. Avoid touching it with your fingers, pen, or pencil.
- To maximize the life of the backlight in the display, allow the backlight to automatically turn off as a result of power management. Avoid using a screen saver or other software that prevents the power management from working.

Cleaning Guidelines

- Never clean the computer with its power on.
- Use a soft cloth moistened with water or a non-alkaline detergent to wipe the exterior of the computer.
- Gently wipe the display with a soft, lint-free cloth. Do not use alcohol or detergent on the display.
- Dust or grease on the touchpad can affect its sensitivity. Clean the pad by using adhesive tape to remove the dust and grease on its surface.

Battery Pack Guidelines

- Recharge the battery pack when it is nearly discharged. When recharging, make sure that the battery pack is fully charged. Doing so may avoid harm to the battery pack.
- Operate the computer with the battery pack installed even when using external power. This ensures that the battery is fully charged.
- If you will not be using the computer for a long period of time (more than two weeks), remove the battery pack from the computer.
- If you remove the battery pack, make sure that the battery terminals do not contact any conductors such as metal objects or water. Otherwise, the battery may become unusable as a result of a short circuit.
- If you need to store the battery pack, store it in a cool, dry place. Never allow the temperature to exceed 60 °C (140 °F).
- Do not leave the battery pack in storage for more than 6 months without recharging it.

When Traveling

- Before traveling with your computer, make a backup of your hard disk data into flash disks or other storage devices. As an added precaution, bring along an extra copy of your important data.
- Make sure that the battery pack is fully charged.
- Make sure that the computer is turned off and the top cover is securely closed.
- Do not leave objects in between the keyboard and closed display.
- Disconnect the AC adapter from the computer and take it with you. Use the AC adapter as the power source and as a battery-charger.
- Hand-carry the computer. Do not check it in as luggage.
- If you need to leave the computer in the car, put it in the trunk of the car to avoid exposing the computer to excessive heat.
- When going through airport security, it is recommended that you send the computer and flash disks through the X-ray machine (the device you set your bags on). Avoid the magnetic detector (the device you walk through) or the magnetic wand (the handheld device used by security personnel).
- If you plan to travel abroad with your computer, consult your dealer for the appropriate AC power cord for use in your country of destination.

Troubleshooting

Computer problems can be caused by hardware, software, or both. When you encounter any problem, it might be a typical problem that can easily be solved.

This chapter tells you what actions to take when solving common computer problems. It is divided into three sections:

- Preliminary checklist
- Solving common problems
- Resetting the computer

Preliminary Checklist

Here are helpful hints to follow before you take further actions when you encounter any problem:

- Try to isolate which part of the computer is causing the problem.
- Make sure that you turn on all peripheral devices before turning on the computer.
- If an external device has a problem, make sure that the cable connections are correct and secure.
- Make sure that the configuration information is properly set in the BIOS Setup program.
- Make sure that all the device drivers are correctly installed.
- Make notes of your observations. Are there any messages on the screen? Do any indicators light? Do you hear any beeps? Detailed descriptions are useful to the service personnel when you need to consult one for assistance.

If any problem persists after you follow the instructions in this chapter, contact an authorized dealer for help.

Solving Common Problems

For easy reference, the problems are divided into these categories.

Problem Type	Go to
Battery Problems	P. 8-5
Display Problems	P. 8-5
Hardware Device Problems	P. 8-6
Hard Disk Drive Problems	P. 8-7
Keyboard, Mouse, and Touchpad Problems	P. 8-7
LAN Problems	P. 8-8
Modem Problems	P. 8-8
PC card Problems	P. 8-8

PC Card Problems

The PC card does not work.

- Make sure that the PC card is correctly seated.
- If the card requires an IRQ (Interrupt ReQuest), make sure that there is one available.

The PC card stops communicating properly.

- The application may have been reset when the computer is turned off or in Standby mode. Exit and restart the application.

Power Management Problems

Software Problems	P. 8-9
Sound Problems	P. 8-10
Startup Problems	P. 8-11

Battery Problems

The battery does not charge (Battery Charge indicator does not light orange).

- Make sure that the AC adapter is properly connected.
- Make sure that the battery is not too hot or cold. Allow time for the battery pack to return to room temperature.
- Make sure that the battery pack is installed correctly.
- Make sure that the battery terminals are clean.

The operating time of a fully charged battery becomes shorter.

- If you often partially recharge and discharge, the battery might not be charged to its full potential. Initialize the battery to solve the problem. (See “Initializing the Battery Pack” in Chapter 3 for instructions.)

The battery operating time indicated by the battery meter does not match the actual operating time.

- The actual operating time can be different from the estimated time, depending on how you are using the computer. If the actual operating time is much less than the estimated time, initialize the battery. (See “Initializing the Battery Pack” in Chapter 3 for instructions.)

Display Problems

Nothing appears on the screen.

- During operation, the screen may automatically turn off as a result of power management. Press any key to see if the screen comes back.
- The brightness level might be too low. Increase brightness by pressing the **Fn+F6** hot key.
- The display output might be set to an external device. To switch the display back to the LCD, press the **Fn+F9** hot key or change the display through the settings in **Display Properties**.

The characters on the screen are dim.

- Adjust the brightness and/or contrast.

Bad dots appear on the display at all times.

- A small number of missing, discolored, or bright dots on the screen are an intrinsic characteristic of TFT LCD technology. It is not regarded as a LCD defect.

Resolution cannot be adjusted to desired setting.

- Make sure that the device driver is installed correctly.

The external monitor displays nothing.

- Make sure that the monitor is turned on.
- Make sure that the monitor's signal cable is properly connected.
- Switch the display to the monitor by pressing the **Fn+F9** hot key or change the display through the settings in **Display Properties**.

Simultaneous display/multi-display does not work.

- Make sure that you turn on the external monitor before turning on the computer.
- Press the **Fn+F9** hot key to toggle through the display options or change the settings in **Display Properties** in Windows.

Hardware Device Problems

The computer does not recognize a newly installed device.

- The device may not be correctly configured in the BIOS Setup program. Run the BIOS Setup program to identify the new type.
- Make sure if any device driver needs to be installed. (Refer to the documentation that came with the device.)
- Make sure if the device needs any jumper or switch settings. (Refer to the documentation that came with the device.)
- Check the cables or power cords for correct connections.

- For an external device that has its own power switch, make sure that the power is turned on.

Hard Disk Drive Problems

The hard disk drive error message appears on the screen.

- The hard disk drive has defects. Ask your dealer for help.

The hard disk drive operations seem slow.

- The data files stored on the hard disk drive may be fragmented. Use a tool such as Window's **Disk Defragmenter** to defragment the files.

The hard disk drive in-use indicator glows without blinking.

- The data files stored on the hard disk drive may be fragmented. Use a tool such as Window's **Disk Defragmenter** to defragment the files.

Keyboard, Mouse, and Touchpad Problems

The keyboard does not respond.

- Try connecting an external keyboard. If it works, contact an authorized dealer, as the internal keyboard cable might be loose.

The numeric keypad is disabled.

- Make sure that the **Num Lock** is switched on. (Check if the Num Lock Indicator  glows or not.)

The external keyboard does not work.

- Make sure that the keyboard cable is properly connected.

The USB mouse does not work.

- Make sure that the mouse cable is properly connected.

The touchpad does not work, or the pointer is difficult to control with the touchpad.

- Make sure that the touchpad driver is correctly installed.

- Make sure that the touchpad is clean.

LAN Problems

I cannot access the network.

- Make sure that the LAN driver is correctly installed.
- Make sure that the LAN cable is properly connected to the RJ-45 connector and the network hub.
- Make sure that the network configuration is appropriate.
- Make sure that the user name or password is correct.

Modem Problems

The modem does not work.

- Make sure that the modem driver is correctly installed.
- Make sure that the telephone line is properly connected.
- Make sure that the COM port in the communication software is correctly set.
- Turn off power management.

PC Card Problems

The PC card does not work.

- Make sure that the PC card is correctly seated.
- If the card requires an IRQ (Interrupt ReQuest), make sure that there is one available.

The PC card stops communicating properly.

- The application may have been reset when the computer is turned off or in Standby mode. Exit and restart the application.

Power Management Problems

The computer does not enter Standby or Hibernation mode automatically.

- If you have a connection to another computer, the computer does not enter Standby or Hibernation mode if the connection is actively in use.
- Make sure that the Standby or Hibernation time-out is enabled.

The computer does not enter Standby or Hibernation mode immediately.

- If the computer is performing an operation, it normally waits for the operation to finish.

The computer does not resume from Standby or Hibernation mode.

- The computer automatically enters Standby or Hibernation mode when the battery pack is empty. Do any one of the following:
 - Connect the AC adapter to the computer.
 - Replace the empty battery pack with a fully charged one.

The computer does not enter Hibernation mode with the Fn+F10 hot keys.

- Make sure that the Hibernation function is specified for the sleep button.
- You might be using an PC card that prevents the computer from entering Hibernation mode. To enter the mode, stop the communication program and then remove the card or stop the card.

Software Problems

An application program does not work correctly.

- Make sure that the software is correctly installed.
- If an error message appears on the screen, consult the software program's documentation for further information.
- If you are sure the operation has stop, reset the computer. (See "Resetting the Computer" later in this chapter.)

Sound Problems

No sound is produced.

- Make sure that the volume control is not set too low.
- Make sure that the device driver is correctly installed.
- Make sure that the computer is not in Standby mode.
- If using an external speaker, make sure that the speaker is properly connected.

Distorted sound is produced.

- Make sure that the volume control is not set too high or too low. In most cases, a high setting can cause the audio electronics to distort the sound.

The sound system does not record.

- Adjust the playback or recording sound levels.

The external microphone or audio device does not work.

- Make sure that the microphone is connected to the proper connector on the computer.
- Make sure that your computer is equipped with the driver needed.
- Click the speaker symbol on the taskbar and check the Windows volume control.
- Check the volume control of your computer.

Startup Problems

When you turn on the computer, it does not respond and the Power Indicator does not light blue.

- If you are using an external AC power, make sure that the AC adapter is correctly and securely connected. If so, make sure that the electrical outlet works properly.
- If you are using the battery power, make sure that the battery is not discharged.

When you turn on the computer, it stops after POST.

- Restart your computer.

Other Problems

The date/time is incorrect.

- Correct the date and time via the operating system or BIOS Setup program.
- After you have performed everything as described above and still have the incorrect date and time every time you turn on the computer, the RTC (Real-Time Clock) battery is at the end of its life. Call an authorized dealer to replace the RTC battery.

Resetting the Computer

You may have to reset (reboot) your computer on some occasions when an error occurs and the program you are using hangs up.

If the computer operation seems to hang up, first wait. It is possible that the computer is processing data. Periodically check the hard disk drive in-use indicator, if it flashes irregularly, the program may be accessing data and preventing you from using the keyboard. If you are sure the operation has stopped and you cannot use the “restart” function of the operating system, reset the computer.

Reset the computer by any one of these methods:

- Press **Ctrl+Alt+Del**.
- If the above action does not work, turn off the computer. Wait for at least five seconds and turn it on again.

| CAUTION: Resetting will cause any unsaved data to be lost.

Specifications

NOTE: Specifications are subject to change without any prior notice.

Parts		Specifications
CPU		Intel® Core™ Duo ULV 1.2 GHz processor 533 MHz FSB (Front Side Bus)
Cache Memory		2 MB L2 cache
Chipset	NorthBridge	Intel® 945GMS
	SouthBridge	ICH7-M
RAM (system)		512 MB DDR2 533 MHz (1 GB option)
Display	Panel	10.4-inch wide TFT LCD, resolution up to 1024×768 XGA 12.1-inch wide TFT LCD, resolution up to 1280×800 WXGA (option) Touchscreen function or Active Digitizer feature (option) NOTE: Both Touchscreen and Active Digitizer feature cannot exist at the same time. Sunlight-readable (option)
	Video controller	Intel® GMA 950
	Video port	VGA Replaced with serial port (RS-232) – option Replaced with serial port (RS-422) – option
Audio	Features	Azalia interface 32-bits audio digital controller
	Speaker	3 watt × 1
	Ports	Two audio ports for Line-out / Mic-in (Line-in)
Keyboard		Standard keys with numeric pad keys, 12 function keys, special Fn (Function) key and Windows keys Water-proof membrane, water-proof rubber + backlitged (option)
Pointing device		PS/2-compatible touchpad with 2 buttons, capacitance-type
Hard disk drive		SATA interface, 1.5 GHz, 5400 rpm support HDD heater for low temperature –20 °C solution (option)

Parts		Specifications
PCMCIA		Type II × 2 Type II × 1 and Smart Card Reader (option)
Card Reader (option)		Secure Digital (SD)
I/O ports		Two USB ports (USB 2.0 support), serial ports × 2 (RS-232), RJ-45 port, RJ-11 port
Modem		56 Kbps, ITU V.92 MDC internal fax modem
LAN		10/100/1000Base-T Ethernet
Camera (option)		Integrated 1.3 M pixel NOTE: Both camera and GPS feature cannot exist at the same time.
GPS (option)		Integrated NOTE: Both GPS and camera feature cannot exist at the same time.
3G		CDMA 2000 1× EVDO (Sierra MC5725V)
Security		Kensington lock TPM 1.2 (availability may vary) – option Smart Card Reader (integrated) will occupy one Type II PCMCIA slot – option
Strap		Grid-type
Accessories (option)		Carrying bag, battery pack, cross-type strap, external battery charger, vehicle mount (no docking connector needed), vehicle docking (need to combine with docking connector), car adapter
Operating System		Microsoft® Windows® XP Professional (with Touchscreen display) Microsoft® Windows® XP Tablet PC Edition 2005 (with Active Digitizer display panel)
Power	AC adapter	Universal AC adapter 90 W; input: 100–240 V, 50/60 Hz
	Battery	Li-ion smart battery 5200 mAh / 11.1 V Li-ion smart battery 7800 mAh / 11.1 V (option)
Dimension (W×D×H)		285×222×49 mm (11.2×8.7×1.9 inch) for 10.4-inch wide TFT LCD 311×222×49 mm (12.2×8.7×1.9 inch) for 12.1-inch wide TFT LCD
Weight		2.2 kg (4.9 lb)
Environment	Temperature	Operating: 0 °C (32 °F) to 55 °C (131 °F) –20 °C (4 °F) to 55 °C (131 °F) – low temperature option Storage: –40 °C (–40 °F) to 70 °C (158 °F)
	Humidity	According to IEC 68-2-30 / MIL-STD-810F, Method 507.4 45 % to 95 % relative, non-condensing
	Altitude	According to IEC 68-2-13 / MIL-STD-810F, Method 500.4 Operating: 15,000 ft Non-operating: 40,000 ft Attitude change rate: 2,000 ft/min
Regulation		FCC, UL, CUL, TUV, CE, CB, CCC, PSE, WHQL, BSMI, RoHS, E-Mark

Regulatory Information

This appendix provides regulatory statements and safety notices on your computer.

NOTE: Marking labels located on the exterior of your computer indicate the regulations that your model complies with. Please check the marking labels and refer to the corresponding statements in this appendix. Some notices apply to specific models only.

On the Use of the System

Class B Regulations

USA

Federal Communications Commission Radio Frequency Interference Statement

NOTE:

This equipment has been tested and found to comply with the limits for a Class B digital device pursuant to Part 15 of the FCC Rules. These limits are designed to provide reasonable protection against harmful interference in a residential installation. This equipment generates, uses, and can radiate radio frequency energy and, if not installed and used in accordance with the instructions, may cause harmful interference to radio communications. However, there is no guarantee that interference will not occur in a particular installation. If this equipment does cause harmful interference to radio or television reception, which can be determined by turning the equipment off and on, the user is encouraged to try to correct the interference by one or more of the following measures:

- Reorient or relocate the receiving antenna.
- Increase the separation between the equipment and receiver.
- Connect the equipment into an outlet on a circuit different from that to which the receiver is connected.
- Consult the dealer or an experienced radio/TV technician for help.

Any changes or modifications not expressly approved by the manufacturer could void the user's authority to operate the equipment.

Please note:

The use of a non-shielded interface cable with this equipment is prohibited.

Canada

Canadian Department of Communications Radio Interference Regulations Class B Compliance Notice

This Class B digital apparatus meets all requirements of the Canada Interference-Causing equipment regulations.

Cet appareil numérique de Classe B respecte toutes les exigences du Règlement Canadien sur le matériel brouilleur.

This digital apparatus does not exceed the Class B limits for radio noise emissions from digital apparatus set out in the Radio Interference Regulations of the Canadian Department of Communications.

Le présent appareil numérique n'émet pas de bruits radioélectriques dépassant les limites applicables aux appareils numériques de la classe B prescrites dans le Règlement sur le brouillage radioélectrique édicté par le ministère des Communications du Canada.

Safety Notices

About the Battery

Caution Texts Concerning Lithium Batteries

DANISH

ADVARSEL! Lithiumbatteri – Eksplosionsfare ved fejlagtig håndtering. Udskiftning må kun ske med batteri af samme fabrikat og type. Levér det brugte batteri tilbage til leverandøren.

NORWEGIAN

ADVARSEL: Eksplosjonsfare ved feilaktig skifte av batteri. Benytt samme batteritype eller en tilsvarende type anbefalt av apparatfabrikanten. Brukte batterier kasseres i henhold til fabrikantens instruksjoner.

SWEDISH

WARNING: Explosionsfara vid felaktigt batteribyte. Använd samma batterityp eller en ekvivalent typ som rekommenderas av apparattillverkaren. Kassera använt batteri enligt fabrikantens instruktion.

FINNISH

VAROITUS: Paristo voi räjähtää, jos se on virheellisesti asennettu. Vaihda paristo ainoastaan valmistajan suosittelemaan tyyppiin. Hävitä käytetty paristo valmistajan ohjeiden mukaisesti.

ENGLISH

CAUTION: Danger of explosion if battery is incorrectly replaced. Replace only with the same or equivalent type recommended by the equipment manufacturer. Discard used batteries according to manufacturer's instructions.

DEUTSCH

VORSICHT: Explosionsgefahr bei unsachgemäßem Austausch der Batterie. Ersatz nur durch denselben oder einen vom Hersteller empfohlenen gleich-wertigen Typ. Entsorgung gebrauchter Batterien nach Angaben des Herstellers.

FRENCH

ATTENTION: Il y a danger d'explosion s'il y a un remplacement incorrect de la batterie. Remplacer uniquement avec une batterie du même type ou d'un type équivalent recommandé par le constructeur. Mettre au rebut les batteries usagées conformément aux instructions du fabricant.

Attention (for USA Users)

The product that you have purchased contains a rechargeable battery. The battery is recyclable. At the end of its useful life, under various state and local laws, it may be illegal to dispose of this battery into the municipal waste stream. Check with your local solid waste officials for details in your area for recycling options or proper disposal.

About the AC Adapter

- Use only the AC adapter supplied with your computer. Use of another type of AC adapter will result in malfunction and/or danger.
- Do not use the adapter in a high moisture environment. Never touch the adapter when your hands or feet are wet.
- Allow adequate ventilation around the adapter when using it to operate the device or charge the battery. Do not cover the AC adapter with paper or other objects that will reduce cooling. Do not use the AC adapter while it is inside a carrying case.
- Connect the adapter to a proper power source. The voltage requirements are found on the product case and/or packaging.
- Do not use the adapter if the cord becomes damaged.
- Do not attempt to service the unit. There are no serviceable parts inside. Replace the unit if it is damaged or exposed to excess moisture.

About the Modem

Caution

- Never install telephone wiring during a lightning storm.
- Never install telephone jacks in wet locations unless the jack is specifically designed for wet locations.
- Never touch non-insulated telephone wires or terminals unless the telephone line has been disconnected at the network interface.
- Use caution when installing or modifying telephone lines.
- Avoid using the telephone function (other than a cordless type) during an electrical storm. There may be a remote risk of electric shock from lightning.
- Do not use the telephone function to report a gas leak in the vicinity of the leak.
- Do not use this product near water, for example near a bathtub, wash bowl, kitchen sink or laundry tub, in a wet basement or near a swimming pool.

Caution (for USA Users)

To reduce the risk of fire, use only No.26 AWG or larger telecommunication line cord.

On the Use of the RF Device

NOTE: The information in this section applies to models with the wireless LAN module.

USA and Canada Safety Requirements and Notices

IMPORTANT NOTE: To comply with FCC RF exposure compliance requirements, the antenna must not be co-located or operating in conjunction with any other antenna or transmitter.

Radio Frequency Interference Requirements and SAR

The FCC with its action in ET Docket 93-62 has adopted a safety standard for human exposure to Radio Frequency (RF) electromagnetic energy emitted by FCC certified equipment. The wireless LAN module meets the Human Exposure limits found in OET Bulletin 65, 2001, and ANSI/IEEE C95.1, 1992. Proper operation of this radio according to the instructions found in this manual will result in exposure substantially below the FCC's recommended limits. The following safety precautions should be observed:

- Do not touch or move antenna while the unit is transmitting or receiving.
- Do not hold any component containing the radio such that the antenna is very close or touching any exposed parts of the body, especially the face or eyes, while transmitting.
- Do not operate the radio or attempt to transmit data unless the antenna is connected; if not, the radio may be damaged.

Use in specific environments:

- The use of wireless devices in hazardous locations is limited by the constraints posed by the safety directors of such environments.
- The use of wireless devices on airplanes is governed by the Federal Aviation Administration (FAA).
- The use of wireless devices in hospitals is restricted to the limits set forth by each hospital.

Antenna use:

- High-gain, wall-mount, or mast-mount antennas are designed to be professionally installed and should be located at a minimum distance of 30 cm (12 inches) or more from the body of all persons. Please contact your professional installer, VAR, or antenna manufacturer for proper installation requirements.

Explosive Device Proximity Warning

WARNING: Do not operate a portable transmitter (such as a wireless network device) near unshielded blasting caps or in an explosive environment unless the device has been modified to be qualified for such use.

Use on Aircraft Caution

CAUTION: Regulations of the FCC and FAA prohibit airborne operation of radio-frequency wireless devices because their signals could interfere with critical aircraft instruments.

FCC Requirements

This equipment has been tested and found to comply with the limits for a Class B digital device, pursuant to Part 15 of the FCC Rules. These limits are designed to provide reasonable protection against harmful interference in a residential installation. This equipment generates, uses and can radiate radio frequency energy and, if not installed and used in accordance with the instructions, may cause harmful interference to radio communications. However, there is no guarantee that interference will not occur in a particular installation. If this equipment does cause harmful interference to radio or television reception, which can be determined by turning the equipment off and on, the user is encouraged to try to correct the interference by one of the following measures:

- Reorient or relocate the receiving antenna.
- Increase the separation between the equipment and receiver.
- Connect the equipment into an outlet on a circuit different from that to which the receiver is connected.
- Consult the dealer or an experienced radio/TV technician for help.

This device complies with Part 15 of the FCC Rules. Operation is subject to the following three conditions:

- (1) This device may not cause harmful interference, and
- (2) This device must accept any interference received, including interference that may cause undesired operation.
- (3) This device shall automatically discontinue transmission in case of either absence of information to transmit or operation failure.

Information to User

To assure continued compliance, any changes or modifications not expressly approved by the party responsible for compliance could void the user's authority to operate this equipment.

IMPORTANT NOTE:

This equipment complies with FCC radiation exposure limits set forth for an uncontrolled environment.

End users must follow the specific operation instruction for satisfying RF exposure compliance.

This transmitter must not be co-located or operating in conjunction with any other antenna or transmitter.

The maximum reported Body Maximum SAR Measurement (1g) value is:

EVDO835MHz: 0.210 W/g

EVDO1900MHz: 0.661 W/g

Canada Radio Frequency Interference Requirements

To prevent radio interference to the licensed service, this device is intended to be operated indoors and away from windows to provide maximum shielding. Equipment (or its transmit antenna) that is installed outdoors is subject to licensing.