

P470 User's Manual

(March 2007)

TRADEMARKS

All brand and product names are trademarks or registered trademarks of their respective companies.

NOTE

The information in this manual is subject to change without notice.

Table of Contents

Preface	i
Notational Conventions.....	i
Chapter 1 Getting Started	1-1
Getting the Computer Running	1-1
Unpacking	1-1
Connecting to AC Power	1-1
Opening the Cover	1-1
Turning On and Off the Computer.....	1-1
Taking a Look at the Computer.....	1-1
Right-Side Components	1-1
Left-Side Components	1-1
Rear Components.....	1-1
Front Components.....	1-1
Bottom Components.....	1-1
Top-open Components.....	1-1
Where to Go from Here.....	1-1
Chapter 2 Operating Your Computer	2-1
Starting and Stopping the Computer	2-1
Starting the Computer	2-1
Stopping the Computer	2-1
Using the Power Saving Quick Buttons.....	2-1
Using the Internal Keyboard	2-1
Typewriter Keys.....	2-1
Cursor-Control Keys	2-1
Numeric Keypad	2-1
Function Keys	2-1

	Fn Key	2-1
	Hot Keys	2-1
	Using the Touchpad	2-1
	Configuring the Touchpad	2-1
	Using the Touchscreen (Optional)	2-1
	Using the Hard Disk Drive	2-1
	Using the Video Features	2-1
	Configuring the Display Modes	2-1
	Using the Audio Features	2-1
	Connecting Audio Devices	2-1
	Using the Communication Features	2-1
	Using the Modem	2-1
	Using the LAN	2-1
	Using the Wireless LAN	2-1
	Using the Bluetooth Feature (Optional)	2-1
	Using the GPS (Optional)	2-1
Chapter 3	Managing Power	3-1
	AC Adapter	3-1
	Battery Pack	3-1
	Charging the Battery Pack	3-1
	Checking the Battery Level	3-1
	Replacing the Battery Pack	3-1
	Power Management	3-1
	Hibernation	3-1
	Power-Saving Tips	3-1
Chapter 4	Expanding Your Computer	4-1
	Connecting an External Monitor (Optional)	4-1
Chapter 5	Using BIOS Setup	5-1
	When and How to Use BIOS Setup	5-1
	When to Use	5-1
	Starting BIOS Setup	5-1

Chapter 6	Installing Software Drivers.....	6-1
	How to Use the Driver Disc	6-1
Chapter 7	Caring for the Computer	7-1
	Protecting the Computer.....	7-1
	Using the Cable Lock.....	7-1
	Using an Anti-Virus Strategy.....	7-1
	Taking Care of the Computer.....	7-1
	Location Guidelines	7-1
	General Guidelines.....	7-1
	Cleaning Guidelines.....	7-1
	Battery Pack Guidelines.....	7-1
	When Traveling.....	7-1
Chapter 8	Troubleshooting.....	8-1
	Preliminary Checklist.....	8-1
	Solving Common Problems.....	8-1
	Battery Problems.....	8-1
	Bluetooth Problems.....	8-1
	Display Problems	8-1
	Hardware Device Problems.....	8-1
	Hard Disk Drive Problems.....	8-1
	Keyboard, Mouse, and Touchpad Problems	8-1
	LAN Problems	8-1
	WLAN Problems.....	8-1
	Modem Problems	8-1
	PC Card Problems.....	8-1
	Power Management Problems.....	8-1
	Software Problems	8-1
	Sound Problems	8-1
	Startup Problems	8-1
	Other Problems.....	8-1
	Resetting the Computer.....	8-1

Appendix A Specifications A-1

Appendix B Regulatory Information B-1

 On the Use of the System.....B-1

 Class B RegulationsB-1

 Safety NoticesB-1

 On the Use of the RF Device.....B-1

 USA and Canada Safety Requirements and Notices.....B-1

 European Union CE Marking and Compliance Notices ..B-1

 电子信息产品有毒有害物质或元素名称及含量标示.....B-1

Preface

This manual contains information that will help you operate the computer. It is divided into 8 chapters and 2 appendices.

- Chapter 1, **Getting Started**, takes you through the process of setting up the computer and identifying its external components.
- Chapter 2, **Operating Your Computer**, tells you how to use the computer's components and features.
- Chapter 3, **Managing Power**, provides information on power.
- Chapter 4, **Expanding Your Computer**, provides information on installing and using peripheral devices.
- Chapter 5, **Using BIOS Setup**, describes the BIOS Setup program that configures the computer's BIOS settings.
- Chapter 6, **Installing Software Drivers**, describes how to install the drivers and utilities supplied with the computer.
- Chapter 7, **Caring for the Computer**, gives you tips in care and maintenance.
- Chapter 8, **Troubleshooting**, gives solutions to common problems you may encounter when using the computer.
- Appendix A, **Specifications**, gives a brief specification of the computer.
- Appendix B, **Regulatory Information**, provides regulatory statements and safety notices on your computer.

Notational Conventions

Throughout this manual, the following conventions are used to distinguish elements of text.

NOTE: identifies additional information that requires special attention.

CAUTION: identifies important information that, if not followed, may result in loss of data or damage to the computer.

Keyboard keys are shown in a bold typeset. For example:

Press the **Enter** key to complete.

When keys are joined by a plus sign (+), press the first key, and, while keeping the first key down, press the remaining keys, finally release all the keys. When necessary, keys are also shown in graphics.

A title, command, setup item, or button that you can see on the screen is shown in boldface. A value or an option that you can select for a setup item is shown in italic. For example:

Select **When I press the power button**, set it to *Shut down*, and then click the **Save changes** button.

Getting Started

Congratulations on purchasing this semi-ruggedized computer.

Your computer incorporates desktop computer capabilities into a notebook computer. It can greatly enhance your productivity either in the office or at home. And, of course, wherever you need it, the computer is ready and easy “to go.”

This chapter first tells you step by step how to get the computer up and running. You will find instructions for these procedures:

- Unpacking
- Connecting to AC power
- Opening and closing the cover
- Turning on the computer
- Turning off the computer

Then, you will find a section briefly introducing the external components of the computer. And the last section navigates you to the information you may need after the computer is ready for use.

Getting the Computer Running

This section guides you through the procedures for getting the computer ready for operation.

Unpacking

After unpacking the shipping carton, you should find these standard items:

- Notebook computer
- Accessories:
 - AC adapter
 - AC power cord
 - Driver disc
 - Touchscreen pen (option)

Inspect all the items. If any item is damaged or missing, notify your dealer immediately.

Keep the shipping carton and packing materials in case you need to ship or store the computer in the future.

Connecting to AC Power

The computer operates either on the external AC power or internal battery power. It is suggested that you use AC power when you start up the computer for the very first time.

CAUTION: Use only the AC adapter included with your computer. Using other AC adapters may damage the computer.

1. Make sure that the computer is turned off.
2. Plug the DC cord of the AC adapter to the power connector of the computer (●).

3. Plug the female end of the AC power cord to the AC adapter and the male end to an electrical outlet (❷).
4. When the AC adapter is connected, power is being supplied from the electrical outlet to the AC adapter and onto your computer. Now, you are ready to turn on the computer.

CAUTION:

- When you disconnect the AC adapter, disconnect from the electrical outlet first and then from the computer. A reverse procedure may damage the AC adapter or the computer.
- When unplugging the connector, always hold the plug head. Never pull on the cord.

NOTE: When the AC adapter is connected, it also charges the battery pack. For information on using battery power, see Chapter 3.

Opening the Cover

CAUTION: Be gentle when opening and closing the cover. Opening it vigorously or slamming it shut could damage the computer.

Open the top cover by pulling on the cover latch (❶) and lifting up the cover (❷). You can tilt the cover forward or backward for optimal viewing clarity.

Turning On and Off the Computer

Turning On

1. Make sure that the computer is connected to AC power.
2. Press the power button (⏻).
3. Each time the computer is turned on, it performs a Power-On Self Test (POST), and the operating system such as Windows should start.

Turning Off

To turn off the computer power, use the “Shut Down” command of your operating system.

NOTE: There are other ways you can stop the computer so that you will be back to where you left off when you next turn on the computer. (See “Stopping the Computer” in Chapter 2 for information.)

CAUTION: If you have to turn the computer on again immediately after turning it off, wait for at least five seconds. Turning the computer off and on rapidly can damage it.

Taking a Look at the Computer

This section identifies the external components of the computer and briefly describes the function of each component.

NOTE: Depending on the model you purchased, the appearance of your computer may not be exactly the same as those shown in this manual.





Right-Side Components



Ref	Component	Description
①	Hard Disk Drive Compartment	Inside is the hard disk drive.
②	Combo Drive/ DVD Dual Drive/ Super Multi Drive	Accepts a compact disc for installing or loading software, accessing data, and playing music/video.
③	USB Ports 	Each of the two ports connects a USB device, such as a USB flash disk, printer, digital camera, joystick, and more.

Left-Side Components





Ref	Component	Description
①	Microphone Connector 	Connects an external microphone.
②	Audio Output Connector 	Connects a set of headphones, external speakers with amplifier, or an audio recording device.
③	WLAN On/Off Switch	Turns the wireless LAN radio on/off.
④	USB Port 	Connects a USB device, such as a USB flash disk, printer, digital camera, joystick, and more.
⑤	Mini IEEE 1394a Port 1394	Connects an IEEE 1394 device such as a scanner, printer, DVCAM, VCR, and more.
⑥	PCMCIA Slot	Accepts a PC card for additional functions.
⑦	Touchscreen Pen	Provides a convenient way to use the touchscreen. Can be stretched for better grip and handling.
⑧	Power Connector 	Connects the AC adapter.
⑨	RJ-11 Connector 	Connects the telephone line.

Ref	Component	Description
⑩	RJ-45 Connector	Connects the LAN cable.
⑪	Card Reader	Accepts a MultiMediaCard (MMC), Secure Digital (SD), Memory Stick (MS) or Memory Stick PRO (MS PRO) card for removable storage media.
⑫	ExpressCard/54 Slot	Accepts an ExpressCard/34 or ExpressCard/54 for additional functions.

Rear Components



Ref	Component	Description
①	Serial Connector	Connects a serial mouse or serial communication device.
②	Battery Pack	Supplies power to your computer when external power is not connected.
③	VGA Connector 	Connects an external display monitor.
④	Kensington Lock 	Locks the computer to a stationary object for security.

Front Components



Ref	Component	Description
①	Top Cover Latch	Locks the top cover.
②	Handle	Provides a convenient way to carry the computer anywhere.

Bottom Components

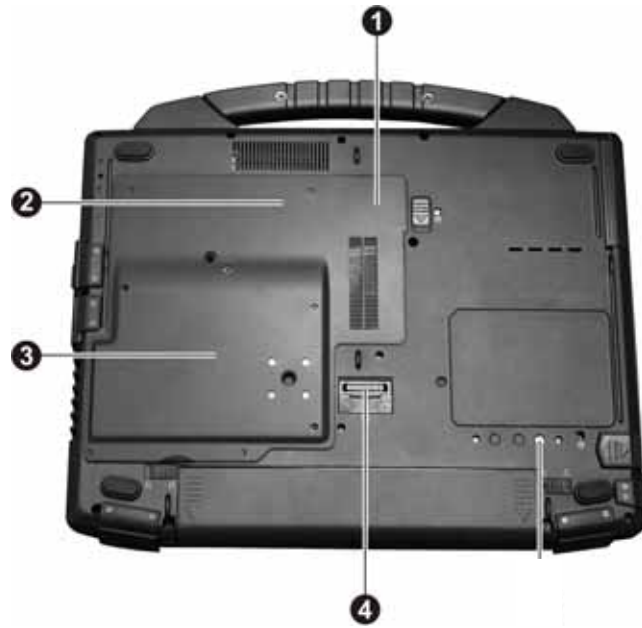





Ref	Component	Description
①	Memory Slots	Inside are the memory slots for expanding the memory size of your computer.
②	Wireless LAN (WLAN) Card Slot	Inside is the mini PCI-E slot for using a mini PCI-E WLAN card.
③	CPU Socket	Inside is the CPU.
④	Expansion Bus Connector	Connects to a Port Replicator.

Top-open Components



Ref	Component	Description
①	Microphone 	Receives sound and voice for the computer.
②	CMOS Camera	Allows you to use your computer's camera function.
③	LCD Screen	Displays the output of the computer.

Ref	Component	Description
④	Quick Buttons	Enables/disables sunlight readable display.
		Enables/disables power saving mode when using battery power.
		P1 P1 (Program 1 – user customized) quick launch key.
		P2 P2 (Program 2 – user customized) quick launch key.
		Turns off/on power to the optical drive for power saving.
⑤	Stereo Speaker	Sends out sound and voice from the computer.
⑥	Power Button 	Turns the computer power ON and OFF.
⑦	Keyboard	Serves as the data input device of the computer.
⑧	Touchpad	Serves as the pointing device of the computer.
⑨	Indicators	Show the current status of the computer's devices.
		 AC Power indicator
		Lights green when computer is on and using AC power.
		Battery Charge indicator
		Lights green when the battery is fully charged.
		Lights amber when the battery is being charged.
		Blinks red when the battery's capacity is below 10 %.
		 Hard disk drive in-use indicator
		Optical drive in-use indicator
		 Num Lock indicator
		 Caps Lock indicator
		ECO Power saving mode indicator
		WLAN indicator
Bluetooth feature indicator		
3G indicator		

Where to Go from Here

As your computer is ready for operation, you may want to do any of the following now:

For this purpose...	Do this...
To know more about the computer...	Go on to the next chapter.
To install the operating system if your dealer has not already done so...	See the operating system manual.
To know more about the operating system...	Read the operating system manual.
To install the drivers if your dealer has not already done so...	See Chapter 6.
To set a power-on password...	Read the operating system manual.
To charge the battery pack for the first time...	See “Charging the Battery Pack” in Chapter 3.

Operating Your Computer

This chapter provides information about the use of the computer.

If you are new to computers, reading this chapter will help you learn the operating basics. If you are already a computer user but are new to notebook computers, you may choose to read only the parts containing information unique to your computer.

Described in this chapter are the operating basics of these components:

- Keyboard
- Touchpad
- Touchscreen (option)

And these features:

- Starting and stopping the computer
- Power saving features
- Video features
- Audio features
- Communication features

Starting and Stopping the Computer

There are a number of ways to start and stop the computer.

Starting the Computer

You always start the computer using the power button.

A computer starts up with an operating system (OS) existing on the storage device such as the hard disk. The computer will automatically load the OS after you turn it on. This process is called booting.

NOTE: An operating system is the platform for all your software application programs to run on. Your computer uses the Microsoft Windows Vista operating system.

Stopping the Computer

When you finish a working session, you can stop the computer by turning off the power or leaving the computer in Sleep or Hibernation mode:

To stop in this mode...	Do this...	To start up or resume again
Off	Follow the shutdown procedure of your operating system. This can prevent loss of unsaved data or damage to your software programs. If the system is locked up because of hardware or software problems, press the power button to turn off the computer.	Press the power button.
Sleep	Depending on your settings in Windows, you can place the computer in Sleep mode by: <ul style="list-style-type: none">• Closing the display cover• Pressing the Fn+F12 hot key	Press any key.

-
- Pressing the power button
-

To stop in this mode...	Do this...	To start up or resume again
Hibernation	Depending on your settings in Windows, you can place the computer in Hibernation mode by: <ul style="list-style-type: none">• Closing the display cover• Pressing the power button	Press the power button.

If you choose to stop in Sleep or Hibernation mode, you can return to where you left off the next time you start up the computer. (See “Power Management” in Chapter 3 for more information.)

Using the Power Saving Quick Buttons

Your computer features two power saving quick buttons:

- System power save quick button
- Optical drive power on/off quick button

Enabling/Disabling System Power Saving Mode

1. Press the power saving quick button (??) to enter into power saving mode when using battery power.

While entering into power saving mode, the system will turn down the panel backlight and sacrifices processing speed to gain more battery life.

2. Press the button once more to go back to normal mode (disable power saving mode).

NOTE: The power saving quick button works only when using battery power.

Turning On/Off Optical Drive Power

1. Press the optical drive power quick button (??).

The system will turn off power to the optical drive to gain more battery life.

2. Press the button once more to restore power to the optical drive.

Using the Internal Keyboard

Your keyboard has all the standard functions of a full-sized computer keyboard plus a **Fn** key added for specific functions.

The standard functions of the keyboard can be further divided into four major categories:

- Typewriter keys
- Cursor-control keys
- Numeric keys
- Function keys

Typewriter Keys

Typewriter keys are similar to the keys on a typewriter. Several keys are added such as the **Ctrl**, **Alt**, **Esc**, and lock keys for special purposes. When the lock keys (**Caps Lock**, **NumLk**, and **ScrLk**) are pressed, their corresponding indicators light up.

The Control (**Ctrl**) / Alternate (**Alt**) key is normally used in combination with other keys for program-specific functions. The Escape (**Esc**) key is usually used for stopping a process. Examples are exiting a program and canceling a command. The function depends on the program you are using.

Cursor-Control Keys

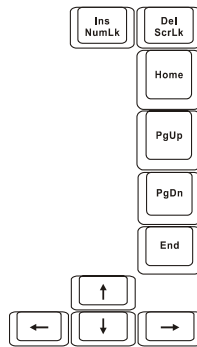

NOTE: The word "cursor" refers to the indicator on the screen that lets you know exactly where on your screen anything you type will appear. It can take the form of a vertical or horizontal line, a block, or one of many other shapes.

Numeric Keypad

A 15-key numeric keypad is embedded in the typewriter keys as shown next:

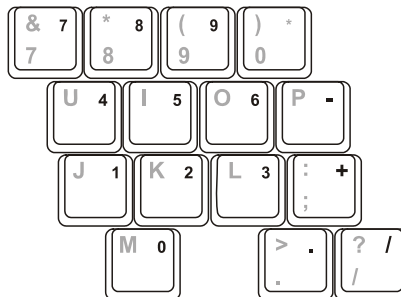

Numeric keys facilitate entering of numbers and calculations. When Num Lock is on, the numeric keys are activated; meaning you can use these keys to enter numerals.

NOTE:

- When the numeric keypad is activated and you need to type the English letter in the keypad area, you can turn Num Lock off or you can press **Fn** and then the letter without turning Num Lock off.
- Some software may not be able to use the numeric keypad on the computer. If so, use the numeric keypad on an external keyboard instead.

Function Keys

On the top row of the keys are the function keys: **F1** to **F12**. Function keys are multi-purpose keys that perform functions defined by individual programs.

Fn Key

The **Fn** key, at the lower left corner of the keyboard, is used with another key to perform the alternative function of a key. The letter “Fn” and the alternative functions are identified by the color of blue on the keytop. To perform a desired function, first press and hold **Fn**, then press the other key.

Hot Keys

Hot keys refer to a combination of keys that can be pressed any time to activate special functions of the computer. Most hot keys operate in a cyclic way. Each time a hot key combination is pressed, it shifts the corresponding function to the other or next choice.

You can easily identify the hot keys with the icons imprinted on the keytop. The hot keys are described next.

Key	Description
Fn + F1	Switches the wireless LAN radio on and off. NOTE: This function works only if an optional mini PCI-E wireless LAN card is installed.
Fn + F3	Decreases the sound volume.
Fn + F4	Increases the sound volume.
Fn + F5	Switches the display output to one of the following when external devices are connected. Upon booting the system with CRT:  <pre> graph LR LCD --> CRT CRT --> LCD_CRT[LCD & CRT] LCD_CRT --> LCD </pre>
Fn + F6	Decreases the LCD brightness.
Fn + F7	Increases the LCD brightness.
Fn + F8	Switches the touchscreen on and off (option).
Fn + F9	Switches the touchpad off and on.
Fn + F10	Switches the system sound output off (mute) and on.
Fn + F11	Switches LCD on and off.
Fn + F12	Serves as the sleep button that you can define with Windows' Power Options . (See the "Power Management" in Chapter 3.)



Euro Symbol

You can press the euro dollar sign € on various keyboards.

- To press the euro sign on a United States-International keyboard, hold down the **Alt Gr** key and press 5 (which has an euro sign on it).
- To press the euro sign on a standard United States keyboard, hold down either of the **Alt** keys and type **0128** on the numeric keypad part of your keyboard.
- To press the euro sign on an UK keyboard, hold down the **Alt Gr** key and press 4 (which has an euro sign on it).

Windows Keys

The keyboard has two keys that perform Windows-specific functions.

The  Windows Logo key opens the **Start** menu and performs software-specific functions when used in combination with other keys. The  Application key usually has the same effect as a right mouse click. (See your Windows manual for more information.)

Using the Touchpad

CAUTION: Do not use a sharp object such as a pen on the touchpad. Doing so may damage the touchpad surface.

NOTE:

- Press **Fn+F9** to toggle the touchpad on or off.
- For optimal performance of the touchpad, keep your fingers and the pads clean and dry. When tapping on the pad, tap lightly. Do not use excessive force.

The touchpad is a pointing device that allows you to communicate with the computer by controlling the location of the pointer on the screen and making selection with the buttons.

The touchpad consists of a rectangular pad (work surface) and a left and right buttons. To use the touchpad, place your forefinger or thumb on the pad. The rectangular pad acts like a miniature duplicate of your display. As you slide your fingertip across the pad, the pointer (also called cursor) on the screen moves accordingly. When your finger reaches the edge of the pad, simply relocate yourself by lifting the finger and placing it on the other side of the pad.

Here are some common terms that you should know when using the touchpad:

Term	Action
Point	Move your finger on the pad until the cursor points to the selection on the screen.
Click	Press and release the left button. —or— Tap gently anywhere on the pad.

Term	Action
Double-click	Press and release the left button twice in quick succession. –or– Tap twice on the pad rapidly.
Drag and drop	Press and hold the left button, then move your finger until you reach your destination (drag). Finally, release the button (drop) when you finish dragging your selection to the destination. The object will drop into the new location. –or– Gently tap twice on the pad and on the second tap, keep your finger in contact with the pad. Then, move your finger across the pad to drag the selected object to your destination. When you lift your finger from the pad, the selected object will drop into place.
Scroll	To scroll is to move up and down or left and right in the working area on the screen. To move vertically, place your finger on the right or left edge of the pad and slide your finger up and down along the edge. To move horizontally, place your finger on the top or bottom edge of the pad and slide your finger left and right. This function works only after you install the touchpad driver supplied with the computer and it may not work for all applications.

TABLE NOTE: If you swap the left and right buttons, “tapping” on the touchpad as an alternative method of pressing the left button will no longer be valid.

Configuring the Touchpad

You may want to configure the touchpad to suit your needs. For example, if you are a left-handed user, you can swap the two buttons so that you can use the right button as the left button and vice versa. You can also change the size of the on-screen pointer, the speed of the pointer, and so on.

To configure the touchpad, go to **Control Panel → Hardware and Sounds → Mouse Properties**. However, you can install the touchpad driver supplied with your computer to take advantage of more powerful features. (For information on installing the driver, see “How to Use the Driver Disc” in Chapter 6.)

Using the Touchscreen (Optional)

NOTE:

- Make sure the touchscreen driver has been installed properly (see chapter 6 for details).
- Press **Fn+F8** to toggle the touchscreen on or off.

CAUTION: Do not use a sharp object such as a ballpoint pen or pencil on the touchscreen. Doing so may damage the touchscreen surface. Use your finger or the included touchscreen pen (option).

The touchscreen is a touch-sensitive device that allows you to easily use the computer without a mouse or touchpad to communicate with the computer by controlling the location of the pointer on the screen and making selection with the buttons.

Here are some common terms that you should know when using the touchscreen:

Term	Action
Click/Point	Tap gently on the touchscreen.
Double-click	Tap twice on the touchscreen rapidly.
Drag and drop	Press lightly on the touchscreen and move your finger until you reach your destination (drag). Finally, release your finger (drop) when you finish dragging your selection to the destination. The object will drop into the new location.

Using the Hard Disk Drive

Your computer comes with a removable hard disk drive as drive C. A hard disk drive is a storage device with non-removable, rotating, magnetic storage platters inside it. It is where your operating system and application software programs are stored.

Your hard disk drive is a 2.5-inch SATA (serial ATA) hard disk drive. This type of drive embodies the latest in fast, reliable mass storage by integrating all the control circuitry necessary for operation directly onto the drive itself.

CAUTION:

- Make regular backups of your data files from your hard disk drive to USB flash disks or other storage media.
- Never try to remove or install the hard disk drive while the computer is powered on. Doing so can result in loss of data, and can damage the computer and the hard disk drive's sensitive circuitry.
- Never turn off or reset the computer while the hard disk drive in-use indicator is on.

Using the Video Features

The video subsystem of your computer features:

- 14.1-inch wide TFT (Thin-Film Transistor) color LCD display with 1280×800 WXGA resolution or 1440×900 WXGA+ resolution
- Multi-display capability, which allows you to expand your desktop on the screen to another display device so that you have more desktop space to work on
- Power Management
- Sunlight-readable LCD display by pressing sunlight readable quick button

NOTE:

- Before using the multi-display capability or taking advantage of the enhanced video capabilities, the device driver supplied with your computer must be installed. (See chapter 6 for details.)
- The computer enters the Sleep or Hibernation mode when the LCD is closed. If you want to use the computer with the LCD closed, set *Do Nothing* to the “When I Close the lid” option in the **Power Options** → **System Settings** Properties. Thus the computer does not enter the Sleep or Hibernation mode when the LCD is closed.

Configuring the Display Modes

NOTE: When using an external CRT monitor, the resolution depends on the CRT monitor’s supported resolution.

Your computer has been set to a default resolution and number of colors before shipment. You can view and change display settings through your operating system. See your operating system documentation or online help for specific information.

For displaying in higher resolutions, you can connect an external monitor that supports higher resolutions. (See “Connecting an External Monitor” in Chapter 4 for more information.)

Using the Audio Features

NOTE:

- To take advantage of the enhanced audio capabilities, the device driver supplied with your computer must be installed. (See chapter 6 for details.)
- If you experience interference while recording, try lowering the microphone recording volume.

The audio subsystem of your computer features:



- Built-in sound system for recording and playing sound on your computer
- Azalia interface (high density audio codec)
- Set of speakers (❶)
- Built-in microphone (❷) and
- External audio connectors (❸)

Ways of playing and recording sound vary with the operating system used. See your operating system documentation or online help for specific information.

Connecting Audio Devices

For higher audio quality, you can send or receive sound through external audio devices.

NOTE: After connecting an external audio device, make sure that you specify the use of the correct audio device in Windows.

- **Audio Output Connector** () can be connected to speakers, headphones, or earphone set.
- **Microphone Connector** () can be connected to an external microphone for recording voice or sound.

NOTE: When using the external speakers/headphones or microphone, you cannot use the internal one.

Using the Communication Features

Using the Modem

NOTE: To take advantage of the modem feature, the device driver supplied with your computer must be installed. (See chapter 6 for details.)

The internal 56 K fax/data modem allows you to use the telephone line to communicate with others by fax, email, or connect to an online service or bulletin board.

To connect the telephone line to the modem, connect one end of the modem cable to the RJ-11 connector on the computer and the other end to the phone line.

NOTE:

- When using the communication software, you may have to disable power management.
- Set the COM port of the modem to COM3.
- Set parameters such as modem speed (baud rate) and line type (pulse dialing or tone dialing).
- Do not enter the Sleep mode when using the communication software.

Using the LAN

NOTE: To take advantage of the LAN feature, the device driver supplied with your computer must be installed. (See chapter 6 for details.)

The internal 10/100/1000Base-T LAN (Local Area Network) module allows you to connect your computer to a network. It supports data transfer rate up to 1000 Mbps.

To connect the network cable to the LAN module, connect one end of the LAN cable to the RJ-45 connector on the computer and the other end to the network hub.

Using the Wireless LAN

Depending on your model, an internal mini PCI-E wireless LAN (WLAN) card may have been pre-installed by your computer manufacturer at the factory. This card allows you to access corporate networks or the Internet in a wireless environment.

The WLAN features include:

- Peer-to-Peer (Ad-Hoc) and Access Point (Infrastructure) modes support
- WEP (Wired Equivalent Privacy) 64/128-bit data encryption
- IEEE 802.11a/b/g standard compliance

Technology	802.11a	802.11b	802.11g
Stated Maximum Throughput (Mbps)	54	11	54
Data Rates (Mbps)	54, 48, 36, 24, 18, 12, 9, 6	11, 5.5, 2, 1	54, 36, 18, 9
Band (GHz)	5.15 ~ 5.35	2.412 ~ 2.462	2.4
Modulation Technology	OFDM (Orthogonal Frequency Division Multiplexing)	DSSS (Direct Sequence Spread Spectrum)	OFDM (Orthogonal Frequency Division Multiplexing)

NOTE: 802.11g mode is backward compatible with 802.11b mode.

To take advantage of the WLAN feature, make sure that the WLAN driver is installed correctly. (See chapter 6 for details.) If your WLAN

card was provided by your dealer instead of the computer manufacturer, contact your dealer for the correct driver to use.

Turning Off/On the WLAN Radio

NOTE: The FAA (Federal Aviation Agency) has deemed it unsafe to operate wireless devices in aircraft as this may interfere with flight safety. Remember to turn off wireless LAN when using your computer in the airplane.

Your computer has a built-in **Fn+F1** WLAN hot key to switch the WLAN on/off (see “Hot Keys” in Chapter 2).

If you need to temporarily turn off the radio, press **Fn+F1**. To resume network connection, press **Fn+F1** again.

It takes approximately 30 seconds for your computer to make a successful WLAN connection and approximately 10 seconds to disconnect.

Connecting to a Wireless Network

To connect to a wireless network:

1. Make sure that the WLAN radio is on (controlled by **Fn+F1**).
2. Right-click the **Wireless Network Connection** icon  located on the Windows system tray and select **Connect to a network**.

3. If any wireless network is detected, the following window appears on screen. Click the **Show** drop down menu and select **Wireless**.

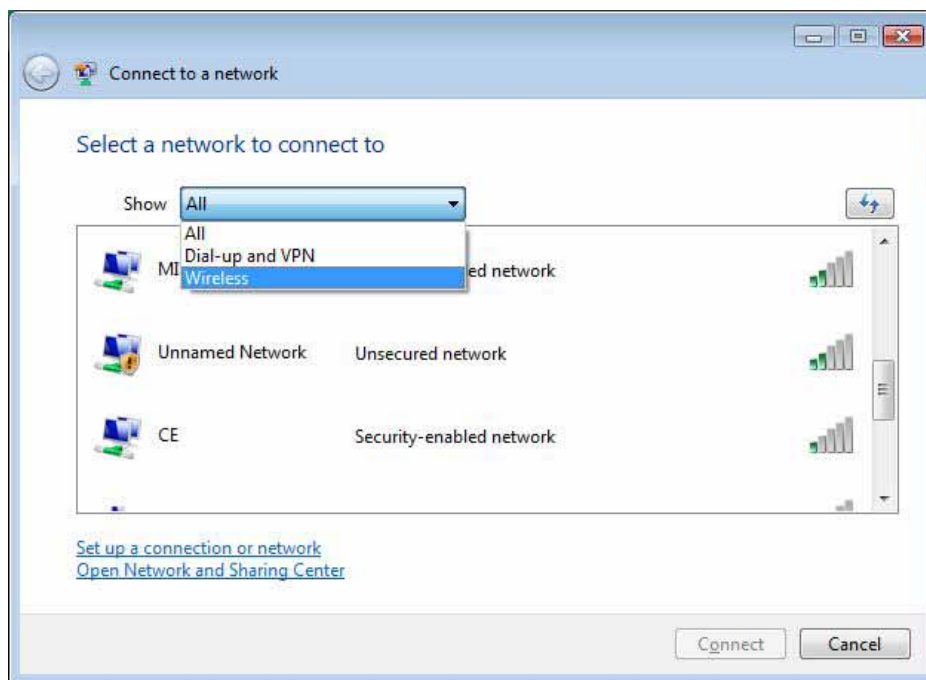

4. Select a wireless network to connect to by clicking a selection, then click **Connect**.
5. Depending on the settings, you may be asked to enter a WEP key (refer to your Windows online help for more information on setting a wireless network connection).



Using the Bluetooth Feature (Optional)

NOTE: To take advantage of the Bluetooth feature, the Bluetooth driver supplied with your computer must be installed. (See chapter 6 for details.)

Depending on your model, your computer may incorporate the Bluetooth capability for short-range (about 10 meters) wireless communications between devices without requiring a cable connection.

With Bluetooth, data can be transmitted through walls, pockets and briefcases as long as two devices are within range. By default, your computer's Bluetooth feature is active (always ON) upon booting your computer and is in the general discoverable and pairable mode.

The status of the Bluetooth connection is indicated by the Bluetooth icon located in the system tray in the lower-right part of the screen.

Status	Icon
Off	 (blue with red logo)
On	 (blue with white logo).
Connected	 (blue with green logo)

You can use the Bluetooth Utility to configure Bluetooth connection settings and transfer files.

To make sure of smooth operations of the Bluetooth feature, you are recommended to change the Service Properties:

1. Right-click the  icon and then click **Options**.

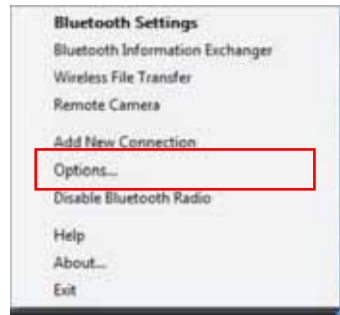

2. Select to enable all items and then click **OK** to save the change.

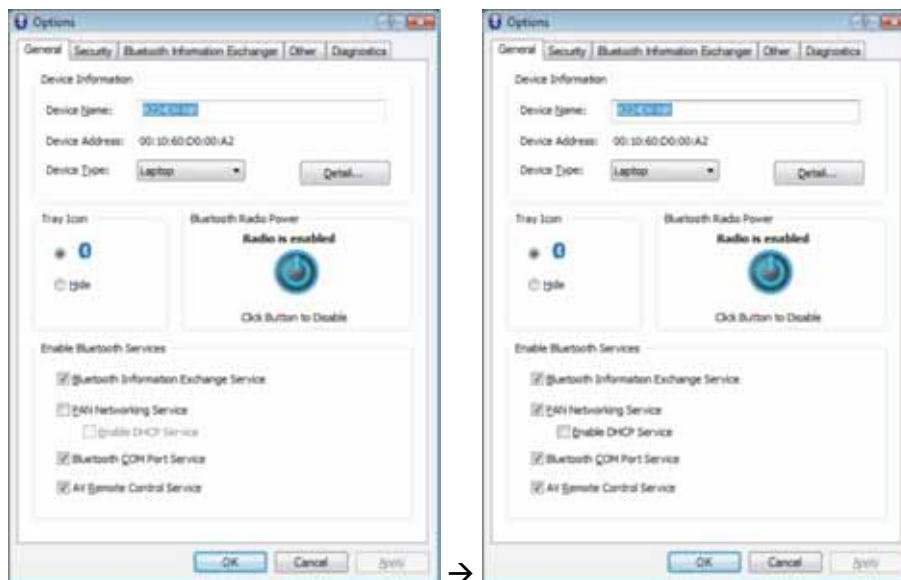

Connecting to Another Bluetooth Device

1. Make sure that the target Bluetooth device is turned on, discoverable and within close range. (See the documentation that came with the Bluetooth device.)
2. Right-click the  icon, and then click **Add New Connection**.

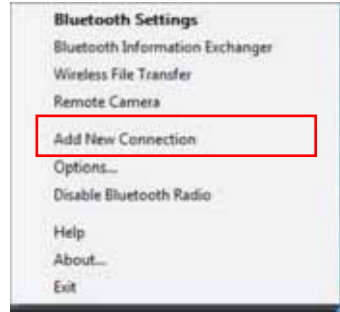

3. The **Add New Connection Wizard** window appears. Select **Express Mode (Recommended)**, and then click **Next**.

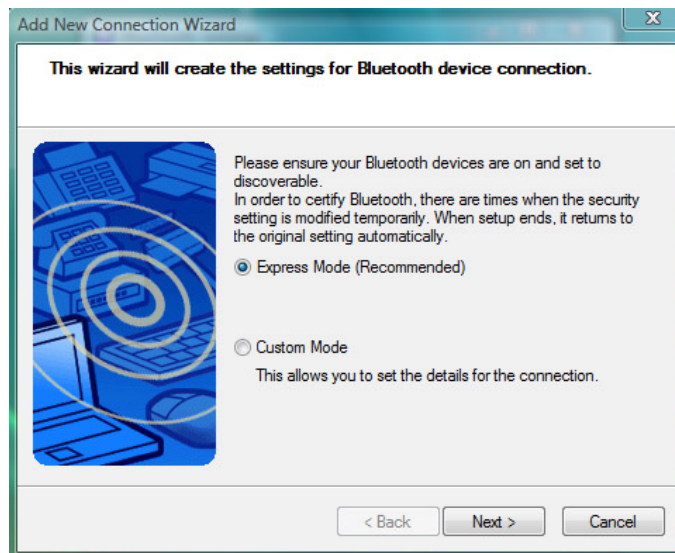

4. Select the device to connect to and click **Next**.



5. Depending on the type of Bluetooth device that you want to connect to, you will need to enter the pertinent information.

Sending a File

1. Make sure that the target Bluetooth device is turned on, discoverable and within close range. (See the documentation that came with the Bluetooth device.)
2. Right-click the  icon, and then click **Wireless File Transfer**.

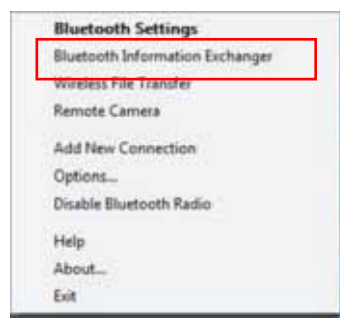

3. In the **Wireless File Transfer** window, click **Add** to browse for the file to send.
4. Click the target device from the list, and then click **Send** to start the transfer procedure.



Using the GPS (Optional)

NOTE: To take advantage of the GPS feature, the GPS driver supplied with your computer must be installed (see chapter 6 for details).

Navigation and positioning are crucial to so many activities. To try to figure out where you are and where you are going, you need GPS technology. The Global Positioning System (GPS) is a worldwide radio-navigation system.

Managing Power

Your computer operates either on external AC power or on internal battery power.

This chapter tells you how you can effectively manage power. To maintain optimal battery performance, it is important that you use the battery in the proper way.

The topics in this chapter include:

- What is an AC adapter
- How to charge the battery pack
- When and how to initialize the battery pack
- How to use the Battery Automatic Calibration Utility
- How to check the battery level
- How to replace the battery pack
- What happens when the battery is low and what actions to take
- What is Power Management
- How to save power

AC Adapter

CAUTION:

- The AC adapter is designed for use with your computer only. Connecting the AC adapter to another device can damage the adapter.
- The AC power cord supplied with your computer is for use in the country where you purchased your computer. If you plan to go overseas with the computer, consult your dealer for the appropriate power cord.
- When you disconnect the AC adapter, disconnect from the electrical outlet first and then from the computer. A reverse procedure may damage the AC adapter or computer.
- When unplugging the connector, always hold the plug head. Never pull on the cord.

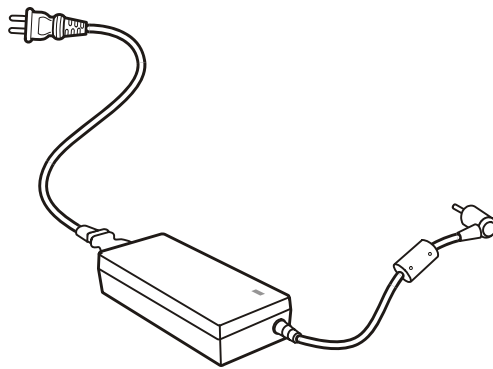

The AC adapter serves as a converter from AC (Alternating Current) to DC (Direct Current) power because your computer runs on DC power, but an electrical outlet usually provides AC power. It also charges the battery pack when connected to AC power.

The adapter operates on any voltage in the range of 100~240 V AC.

Battery Pack

The battery pack is the internal power source for the computer. It is rechargeable using the AC adapter.

The operating time of a fully charged battery pack depends on how you are using the computer. When your applications often access peripherals, you will experience a shorter operating time.

NOTE: Care and maintenance information for the battery is provided in the "Battery Pack Guidelines" section in Chapter 7.

Charging the Battery Pack

NOTE:

- Charging will not start if the battery's temperature is below 0 °C (32 °F) or above 60 °C (140 °F).
- The charging process will stop and the Battery Charge Indicator flashes green when the battery's temperature gets above 60 °C (140 °F). If this happens, the battery pack may be damaged. Please contact your dealer.
- During charging, do not disconnect the AC adapter before the battery has been fully charged; otherwise you will get a prematurely charged battery.

CAUTION: After the computer has been fully recharged, do not immediately disconnect and reconnect the AC adapter to charge it again. Doing so may damage the battery.

NOTE: The battery level may automatically lessen due to the self-discharge process (0.21 % per day), even when the battery pack is fully charged (100 %). This happens no matter if the battery pack is installed in the computer.

Checking the Battery Level

NOTE: Any battery level indication is an estimated result. The actual operating time can be different from the estimated time, depending on how you are using the computer.

Replacing the Battery Pack

CAUTION:

- There is danger of explosion if the battery is incorrectly replaced. Replace the battery only with the computer manufacturer's optional battery packs. Discard used batteries according to the dealer's instructions.
- Do not attempt to disassemble the battery pack.

If you often rely on battery power for a long period of time while traveling, you may consider the purchase of an additional battery pack from your dealer and keep it with you in a fully charged state as a backup.

Power Management

Your computer supports ACPI (Advanced Configuration and Power Interface) for power management. The power management feature allows you to reduce the power consumption for energy saving.

With an ACPI-compliant operating system such as Windows Vista, power supply to different computer components is controlled on an as-needed basis. This allows maximum power conservation and performance at the same time.

For detailed information on power management, see Windows' Help.

Hibernation

Hibernation is a very useful feature. People frequently open many applications when they use computers. It takes some time to get all these applications open and running, and normally they all have to be closed before the computer can be turned off.

When you use the hibernation feature, you do not have to close the applications. The computer stores the state of your computer to a file on the hard disk and then shuts down. The next time you turn on your computer, you return to exactly where you left off.

Power-Saving Tips

Aside from enabling your computer's power saving mode (see previous section), you can do your part to maximize the battery's operating time by following these suggestions.

- Do not disable Power Management.
- Decrease the LCD brightness to the lowest comfortable level.
- If you work with an application that uses a PC card, exit the application when you finish using it.
- If you have a PC card installed, remove it when not in use. Some PC cards drain power even while they are inactive.
- Deactivate the WLAN function if you are not using it (see Chapter 2).
- Turn off the computer when you are not using it.

Expanding Your Computer

You can expand the capabilities of your computer by connecting other peripheral devices. When using a device, be sure to read the instructions accompanying the device together with the relevant section in this chapter.

This chapter gives guidelines on installing and using these devices:

- External monitor (option)
- Serial device
- USB device
- PC card
- Card Reader
- Port Replicator

Connecting an External Monitor (Optional)

Using BIOS Setup

BIOS Setup Utility is a program for configuring the BIOS (Basic Input/Output System) settings of the computer.

BIOS is a layer of software, called firmware, that translates instructions from other layers of software into instructions that the computer hardware can understand. The BIOS settings are needed by your computer to identify the types of installed devices and establish special features.

This chapter tells you how to use the BIOS Setup program.

When and How to Use BIOS Setup

When to Use

You need to run BIOS Setup Utility when:

- You see an error message on the screen requesting you to run BIOS Setup Utility.
- You want to restore the factory default settings.
- You want to modify some specific settings according to the hardware.
- You want to modify some specific settings to optimize the system performance.

Starting BIOS Setup

NOTE:

- The BIOS Setup Utility screens shown in this chapter are for your reference only. The actual items or settings on your computer may differ.
- The BIOS Setup Utility program may have been updated after the publication of this manual.
- The settings you select in your operating system might override similar settings in BIOS Setup Utility.

Installing Software Drivers

To take full advantage of the unique features of your computer, some operating systems require custom software, known as drivers, to be installed.

If you purchased the computer with Windows pre-installed, your dealer may have already installed the drivers. If not, you need to install the drivers using the disc supplied with your computer.

This chapter describes how to install the drivers.

How to Use the Driver Disc

NOTE: The drivers may have been updated after this manual was published. For driver upgrade, please contact your dealer.

Caring for the Computer

Taking good care of your computer will ensure a trouble-free operation and reduce the risk of damage to your computer.

This chapter gives you guidelines covering these areas of maintenance:

- How to protect the computer
- What to note when using and storing the computer
- How to clean the computer
- What to note when using the battery pack
- What to note when traveling with the computer

Protecting the Computer

To safeguard the integrity of your computer data as well as the computer itself, you can protect the computer in several ways as described in this section.

Using the Cable Lock

You can use a Kensington-type cable lock to protect your computer against theft. The cable lock is available in most computer stores.

To use the lock, loop the lock cable around a stationary object such as a table. Insert the lock to the Kensington lock hole and turn the key to secure the lock. Store the key in a safe place.

Using an Anti-Virus Strategy

New viruses are always being developed nowadays and they are attacking computers even more easily with emails so commonly used worldwide. You can install a virus-detecting program to monitor potential viruses that could damage your files.

Taking Care of the Computer

Location Guidelines

- Use the computer where the temperature is between 10 °C (50 °F) and 35 °C (95 °F).
- Avoid placing the computer in a location subject to high humidity, extreme temperatures, mechanical vibration, direct sunlight, or heavy dust.
- Do not cover or block any ventilation openings on the computer. For example, do not place the computer on a bed, sofa, rug, or other similar surface. Otherwise, overheating may occur that results in damage to the computer.
- Keep the computer at least 13 cm (5 inches) away from electrical appliances that can generate a strong magnetic field such as a TV, refrigerator, motor, or a large audio speaker.
- Do not move the computer abruptly from a cold to a warm place. A temperature difference of more than 10 °C (18 °F) will cause condensation inside the unit, which may damage the storage media.
- Do not place the computer on an unsteady surface.

General Guidelines

- Do not place heavy objects on top of the computer when it is closed as this may damage the display.
- The screen surface is easily scratched. Do not use paper towels to clean the display. Avoid touching it with your fingers, pen, or pencil.
- To maximize the life of the backlight in the display, allow the backlight to automatically turn off as a result of power management. Avoid using a screen saver or other software that prevents the power management from working.

Cleaning Guidelines

- Never clean the computer with its power on.
- Use a soft cloth moistened with water or a non-alkaline detergent to wipe the exterior of the computer.
- Gently wipe the display with a soft, lint-free cloth. Do not use alcohol or detergent on the display.
- Dust or grease on the touchpad can affect its sensitivity. Clean the pad by using adhesive tape to remove the dust and grease on its surface.

Battery Pack Guidelines

- Recharge the battery pack when it is nearly discharged. When recharging, make sure that the battery pack is fully charged. Doing so may avoid harm to the battery pack.
- Operate the computer with the battery pack installed even when using external power. This ensures that the battery is fully charged.
- If you will not be using the computer for a long period of time (more than two weeks), remove the battery pack from the computer.
- If you remove the battery pack, make sure that the battery terminals do not contact any conductors such as metal objects or water. Otherwise, the battery may become unusable as a result of a short circuit.
- If you need to store the battery pack, store it in a cool, dry place. Never allow the temperature to exceed 60 °C (140 °F).
- Do not leave the battery pack in storage for more than 6 months without recharging it.

When Traveling

- Before traveling with your computer, make a backup of your hard disk data into flash disks or other storage devices. As an added precaution, bring along an extra copy of your important data.
- Make sure that the battery pack is fully charged.
- Make sure that the computer is turned off and the top cover is securely closed.
- Do not leave objects in between the keyboard and closed display.
- Disconnect the AC adapter from the computer and take it with you. Use the AC adapter as the power source and as a battery-charger.
- Hand-carry the computer. Do not check it in as luggage.
- If you need to leave the computer in the car, put it in the trunk of the car to avoid exposing the computer to excessive heat.
- When going through airport security, it is recommended that you send the computer and flash disks through the X-ray machine (the device you set your bags on). Avoid the magnetic detector (the device you walk through) or the magnetic wand (the handheld device used by security personnel).
- If you plan to travel abroad with your computer, consult your dealer for the appropriate AC power cord for use in your country of destination.

Troubleshooting

Computer problems can be caused by hardware, software, or both. When you encounter any problem, it might be a typical problem that can easily be solved.

This chapter tells you what actions to take when solving common computer problems. It is divided into three sections:

- Preliminary checklist
- Solving common problems
- Resetting the computer

Preliminary Checklist

Here are helpful hints to follow before you take further actions when you encounter any problem:

- Try to isolate which part of the computer is causing the problem.
- Make sure that you turn on all peripheral devices before turning on the computer.
- If an external device has a problem, make sure that the cable connections are correct and secure.
- Make sure that the configuration information is properly set in the BIOS Setup program.
- Make sure that all the device drivers are correctly installed.
- Make notes of your observations. Are there any messages on the screen? Do any indicators light? Do you hear any beeps? Detailed descriptions are useful to the service personnel when you need to consult one for assistance.

If any problem persists after you follow the instructions in this chapter, contact an authorized dealer for help.

Solving Common Problems

For easy reference, the problems are divided into these categories.

Problem Type	Go to
Battery Problems	P. 8-1
Bluetooth Problems	P. 8-1
Display Problems	P. 8-1
Hardware Device Problems	P. 8-1
Hard Disk Drive Problems	P. 8-1
Keyboard, Mouse, and Touchpad Problems	P. 8-1
LAN Problems	P. 8-1
WLAN Problems	P. 8-1
Modem Problems	P. 8-1
PC Card Problems	P. 8-1
Power Management Problems	P. 8-1
Software Problems	P. 8-1
Sound Problems	P. 8-1
Startup Problems	P. 8-1
Other Problems	P. 8-1

Battery Problems

The battery does not charge (Battery Charge indicator does not light amber).

- Make sure that the AC adapter is properly connected.
- Make sure that the battery is not too hot or cold. Allow time for the battery pack to return to room temperature.
- Make sure that the battery pack is installed correctly.
- Make sure that the battery terminals are clean.

The operating time of a fully charged battery becomes shorter.

- If you often partially recharge and discharge, the battery might not be charged to its full potential. Initialize the battery to solve the problem. (See “Initializing the Battery Pack” in Chapter 3 for instructions.)

The battery operating time indicated by the battery meter does not match the actual operating time.

- The actual operating time can be different from the estimated time, depending on how you are using the computer. If the actual operating time is much less than the estimated time, initialize the battery. (See “Initializing the Battery Pack” in Chapter 3 for instructions.)

Bluetooth Problems

I cannot connect to another Bluetooth-enabled device.

- Make sure that the Bluetooth card is correctly installed.
- Make sure that the Bluetooth driver is correctly installed.
- Make sure that both devices have activated Bluetooth.
- Make sure that the distance between the two devices are not over 10 meters or that there are no walls or other obstructions between the devices.
- Make sure that the other device is not in “Hidden” mode.

- Make sure that both devices are compatible.

Display Problems

Nothing appears on the screen.

- During operation, the screen may automatically turn off as a result of power management. Press any key to see if the screen comes back.

The characters on the screen are dim.

- Adjust the brightness and/or contrast.

Bad dots appear on the display at all times.

- A small number of missing, discolored, or bright dots on the screen are an intrinsic characteristic of TFT LCD technology. It is not regarded as a LCD defect.

Resolution cannot be adjusted to desired setting.

- Make sure that the device driver is installed correctly.

The external monitor displays nothing.

- Make sure that the monitor is turned on.
- Make sure that the monitor's signal cable is properly connected.

Simultaneous display/multi-display does not work.

- Make sure that you turn on the external monitor before turning on the computer.

Hardware Device Problems

The computer does not recognize a newly installed device.

- The device may not be correctly configured in the BIOS Setup program. Run the BIOS Setup program to identify the new type.
- Make sure if any device driver needs to be installed. (Refer to the documentation that came with the device.)

- Make sure if the device needs any jumper or switch settings. (Refer to the documentation that came with the device.)
- Check the cables or power cords for correct connections.
- For an external device that has its own power switch, make sure that the power is turned on.

Hard Disk Drive Problems

The hard disk drive error message appears on the screen.

- The hard disk drive has defects. Ask your dealer for help.

The hard disk drive operations seem slow.

- The data files stored on the hard disk drive may be fragmented. Use a tool such as Window's **Disk Defragmenter** to defragment the files.

The hard disk drive in-use indicator glows without blinking.

- The data files stored on the hard disk drive may be fragmented. Use a tool such as Window's **Disk Defragmenter** to defragment the files.

Keyboard, Mouse, and Touchpad Problems

The keyboard does not respond.

- Try connecting an external keyboard. If it works, contact an authorized dealer, as the internal keyboard cable might be loose.

The numeric keypad is disabled.

- Make sure that the **Num Lock** is switched on. (Check if the Num Lock Indicator glows or not.)

The external keyboard does not work.

- Make sure that the keyboard cable is properly connected.

The USB mouse does not work.

- Make sure that the mouse cable is properly connected.

The touchpad does not work, or the pointer is difficult to control with the touchpad.

- Make sure that the touchpad driver is correctly installed.
- Make sure that the touchpad is clean.

LAN Problems

I cannot access the network.

- Make sure that the LAN driver is correctly installed.
- Make sure that the LAN cable is properly connected to the RJ-45 connector and the network hub.
- Make sure that the network configuration is appropriate.
- Make sure that the user name or password is correct.

WLAN Problems

I cannot use the WLAN feature.

- Make sure that the mini PCI-E WLAN card is correctly installed.
- Make sure that the necessary driver(s) is correctly installed.
- Make sure that the WLAN feature is turned on.

Transmission quality is poor.

- Your computer may be in an out-of-range situation. Move your computer closer to the Access Point or another WLAN device it is associated with.
- Check if there is high interference around the environment and solve the problem as described next.

Radio interference exists.

- Move your computer away from the device causing the radio interference such as microwave oven and large metal objects.
- Plug your computer into an outlet on a different branch circuit from that used by the affecting device.
- Consult your dealer or an experienced radio technician for help.

I cannot connect to another WLAN device.

- Make sure that the WLAN feature is turned on.
- Make sure that the SSID setting is the same for every WLAN device in the network.
- Your computer is not recognizing changes. Restart the computer.
- Make sure that the IP address or subnet mask setting is correct.

I cannot communicate with the computer in the network when Infrastructure mode is configured.

- Make sure that the Access Point your computer is associated with is powered on and all the LEDs are working properly.
- If the operating radio channel is in poor quality, change the Access Point and all the wireless station(s) within the BSSID to another radio channel.
- Your computer may be in an out-of-range situation. Move your computer closer to the Access Point it is associated with.
- Make sure that your computer is configured with the same security option (encryption) to the Access Point.
- Use the Web Manager/Telnet of the Access Point to check whether it is connected to the network.
- Reconfigure and reset the Access Point.

I cannot access the network.

- Make sure that the necessary driver(s) is correctly installed.
- Make sure that the network configuration is appropriate.

- Make sure that the user name or password is correct.
- You have moved out of range of the network.
- Turn off power management.

Modem Problems

The modem does not work.

- Make sure that the modem driver is correctly installed.
- Make sure that the telephone line is properly connected.
- Make sure that the COM port in the communication software is correctly set.
- Turn off power management.

PC Card Problems

The PC card does not work.

- Make sure that the PC card is correctly seated.
- If the card requires an IRQ (Interrupt ReQuest), make sure that there is one available.

The PC card stops communicating properly.

- The application may have been reset when the computer is turned off or in Standby mode. Exit and restart the application.

Power Management Problems

The computer does not enter Hibernation mode with the Fn+F10 hot keys.

- Make sure that the Hibernation function is specified for the sleep button.

- You might be using a PC card that prevents the computer from entering Hibernation mode. To enter the mode, stop the communication program and then remove the card or stop the card.

Software Problems

An application program does not work correctly.

- Make sure that the software is correctly installed.
- If an error message appears on the screen, consult the software program's documentation for further information.
- If you are sure the operation has stop, reset the computer. (See "Resetting the Computer" later in this chapter.)

Sound Problems

No sound is produced.

- Make sure that the volume control is not set too low.
- Make sure that the device driver is correctly installed.
- Make sure that the computer is not in Standby mode.
- If using an external speaker, make sure that the speaker is properly connected.

Distorted sound is produced.

- Make sure that the volume control is not set too high or too low. In most cases, a high setting can cause the audio electronics to distort the sound.

The sound system does not record.

- Adjust the playback or recording sound levels.

The external microphone or audio device does not work.

- Make sure that the microphone is connected to the proper connector on the computer.

- Make sure that your computer is equipped with the driver needed.
- Click the speaker symbol on the taskbar and check the Windows volume control.
- Check the volume control of your computer.

Startup Problems

When you turn on the computer, it does not respond and the Power Indicator does not light green.

- If you are using an external AC power, make sure that the AC adapter is correctly and securely connected. If so, make sure that the electrical outlet works properly.
- If you are using the battery power, make sure that the battery is not discharged.

When you turn on the computer, it stops after POST.

- Restart your computer.

Other Problems

The date/time is incorrect.

- Correct the date and time via the operating system or BIOS Setup program.
- After you have performed everything as described above and still have the incorrect date and time every time you turn on the computer, the RTC (Real-Time Clock) battery is at the end of its life. Call an authorized dealer to replace the RTC battery.

Resetting the Computer

You may have to reset (reboot) your computer on some occasions when an error occurs and the program you are using hangs up.

If the computer operation seems to hang up, first wait. It is possible that the computer is processing data. Periodically check the hard disk drive in-use indicator, if it flashes irregularly, the program may be accessing data and preventing you from using the keyboard. If you are sure the operation has stopped and you cannot use the “restart” function of the operating system, reset the computer.

Reset the computer by any one of these methods:

- Press **Ctrl+Alt+Del** on your built-in keyboard.
- If the above action does not work, turn off the computer. Wait for at least five seconds and turn it on again.

| CAUTION: Resetting will cause any unsaved data to be lost.

Specifications

NOTE: Specifications are subject to change without any prior notice.

Parts		Specifications
CPU		Intel® Pentium® M processor (Yonah) single/dual core / Celeron reserved for Merom (NAPA refresh) 400/533/667 MHz FSB (Front Side Bus), 1.66/1.83/2.0/2.16 GHz thermal specifications 35 W
Chipset	NorthBridge	Intel® 945GM
	SouthBridge	Intel® ICH7-M
BIOS		1 MB EEPROM
RAM (system)		Up to 2 GB DDRII 533/667 MHz, 2 × 200-pin SO-DIMM sockets 1.25-inch height
Display	Panel	14.1-inch wide TFT LCD, resolution up to 1280×800 WXGA / 1440×900 WXGA+, dual LVDS, sunlight-readable (option), touchscreen (option)
	Video controller	UMA / Discrete
	VRAM	GDDR II, 64/128/256 MB
	Video port	VGA
Audio	Features	Azalia interface, 2 channel analog output
	Speaker	1.5 watt (8 ohm) × 2
	Ports	Two audio ports for Line-out / Mic-in
Keyboard		Standard keys with numeric pad keys, 12 function keys, special Fn (Function) key and Windows keys Water-proof membrane
Pointing device		Glide touchpad with 2 buttons, scroll bar, under platic, resistive-type
Hard disk drive		SATA interface, 2.5-inch diameter (9.5 mm height), 5400 rpm support G-sensor, shock-mounted

Parts		Specifications
Card slots		PCMCIA CardBus Type II ExpressCard/34 / ExpressCard/54 support Card Reader4-in-1 (MMC/SD/MS/MS PRO card) module
I/O ports		USB ports × 3 (USB 2.0 support), serial port (RS-232), RJ-45 port, RJ-11 port, mini IEEE 1394a port
Modem		Azalia interface, 56 Kbps, ITU V.90 MDC 1.5 internal fax modem
LAN		10/100/1000 Mbps
Wireless LAN		One mini PCI-E slot for wireless LAN card, compliant with IEEE 802.11a/b/g, on/off slide switch
Bluetooth (option)		Specification 2.0 module
Camera (option)		Integrated 1.3 M pixel fixed-type
GPS (option)		GPS module
3G (option)		CDMA 2000 EVDO, GPRS/EVGS
Security		Kensington lock TPM 1.2 (availability may vary) – option Smart Card Reader (integrated) will occupy Type II PCMCIA slot – option
Power	AC adapter	Universal AC adapter 90 W; input: 100~240 V, output: 19 V
	Battery	Li-ion smart battery 6-cell (9-cell option) 4800 mAH / 11.1 V
Dimension (W×D)		333×295 mm (13.1×11.6 inch) with handle
Weight		2.8 kg (6.17 lb)
Regulation		FCC, CE, CB, RoHS

Regulatory Information

This appendix provides regulatory statements and safety notices on your computer.

NOTE: Marking labels located on the exterior of your computer indicate the regulations that your model complies with. Please check the marking labels and refer to the corresponding statements in this appendix. Some notices apply to specific models only.

On the Use of the System

Class B Regulations

USA

Federal Communications Commission Radio Frequency Interference Statement

NOTE:

This equipment has been tested and found to comply with the limits for a Class B digital device pursuant to Part 15 of the FCC Rules. These limits are designed to provide reasonable protection against harmful interference in a residential installation. This equipment generates, uses, and can radiate radio frequency energy and, if not installed and used in accordance with the instructions, may cause harmful interference to radio communications. However, there is no guarantee that interference will not occur in a particular installation. If this equipment does cause harmful interference to radio or television reception, which can be determined by turning the equipment off and on, the user is encouraged to try to correct the interference by one or more of the following measures:

- Reorient or relocate the receiving antenna.
- Increase the separation between the equipment and receiver.
- Connect the equipment into an outlet on a circuit different from that to which the receiver is connected.
- Consult the dealer or an experienced radio/TV technician for help.

Any changes or modifications not expressly approved by the manufacturer could void the user's authority to operate the equipment.

Please note:

The use of a non-shielded interface cable with this equipment is prohibited.

Canada

Canadian Department of Communications Radio Interference Regulations Class B Compliance Notice

This Class B digital apparatus meets all requirements of the Canada Interference-Causing equipment regulations.

Cet appareil numérique de Classe B respecte toutes les exigences du Règlement Canadien sur le matériel brouilleur.

This digital apparatus does not exceed the Class B limits for radio noise emissions from digital apparatus set out in the Radio Interference Regulations of the Canadian Department of Communications.

Le présent appareil numérique n'émet pas de bruits radioélectriques dépassant les limites applicables aux appareils numériques de la classe B prescrites dans le Règlement sur le brouillage radioélectrique édicté par le ministère des Communications du Canada.

Safety Notices

About the Battery

Caution Texts Concerning Lithium Batteries

DANISH

ADVARSEL! Lithiumbatteri – Eksplosionsfare ved fejlagtig håndtering. Udskiftning må kun ske med batteri af samme fabrikat og type. Levér det brugte batteri tilbage til leverandøren.

NORWEGIAN

ADVARSEL: Eksplosjonsfare ved feilaktig skifte av batteri. Benytt samme batteritype eller en tilsvarende type anbefalt av apparatfabrikanten. Brukte batterier kasseres i henhold til fabrikantens instruksjoner.

SWEDISH

VARNING: Explosionsfara vid felaktigt batteribyte. Använd samma batterityp eller en ekvivalent typ som rekommenderas av apparattillverkaren. Kassera använt batteri enligt fabrikantens instruktion.

FINNISH

VAROITUS: Paristo voi räjähtää, jos se on virheellisesti asennettu. Vaihda paristo ainoastaan valmistajan suosittelemaan tyyppiin. Hävitä käytetty paristo valmistajan ohjeiden mukaisesti.

ENGLISH

CAUTION: Danger of explosion if battery is incorrectly replaced. Replace only with the same or equivalent type recommended by the equipment manufacturer. Discard used batteries according to manufacturer's instructions.

DEUTSCH

VORSICHT: Explosionsgefahr bei unsachgemäßem Austausch der Batterie. Ersatz nur durch denselben oder einen vom Hersteller empfohlenen gleich-wertigen Typ. Entsorgung gebrauchter Batterien nach Angaben des Herstellers.

FRENCH

ATTENTION: Il y a danger d'explosion s'il y a remplacement incorrect de la batterie. Remplacer uniquement avec une batterie du même type ou d'un type équivalent recommandé par le constructeur. Mettre au rebut les batteries usagées conformément aux instructions du fabricant.

Attention (for USA Users)

The product that you have purchased contains a rechargeable battery. The battery is recyclable. At the end of its useful life, under various state and local laws, it may be illegal to dispose of this battery into the municipal waste stream. Check with your local solid waste officials for details in your area for recycling options or proper disposal.

About the AC Adapter

- Use only the AC adapter supplied with your computer. Use of another type of AC adapter will result in malfunction and/or danger.
- Do not use the adapter in a high moisture environment. Never touch the adapter when your hands or feet are wet.
- Allow adequate ventilation around the adapter when using it to operate the device or charge the battery. Do not cover the AC adapter with paper or other objects that will reduce cooling. Do not use the AC adapter while it is inside a carrying case.
- Connect the adapter to a proper power source. The voltage requirements are found on the product case and/or packaging.
- Do not use the adapter if the cord becomes damaged.
- Do not attempt to service the unit. There are no serviceable parts inside. Replace the unit if it is damaged or exposed to excess moisture.

About the Modem

Caution

- Never install telephone wiring during a lightning storm.
- Never install telephone jacks in wet locations unless the jack is specifically designed for wet locations.
- Never touch non-insulated telephone wires or terminals unless the telephone line has been disconnected at the network interface.
- Use caution when installing or modifying telephone lines.
- Avoid using the telephone function (other than a cordless type) during an electrical storm. There may be a remote risk of electric shock from lightning.
- Do not use the telephone function to report a gas leak in the vicinity of the leak.
- Do not use this product near water, for example near a bathtub, wash bowl, kitchen sink or laundry tub, in a wet basement or near a swimming pool.

Caution (for USA Users)

To reduce the risk of fire, use only No.26 AWG or larger telecommunication line cord.

On the Use of the RF Device

NOTE: The information in this section applies to models with the wireless LAN module.

USA and Canada Safety Requirements and Notices

IMPORTANT NOTE: To comply with FCC RF exposure compliance requirements, the antenna used for this transmitter must be installed to provide a separation distance of at least 20 cm from all persons and must not be co-located or operating in conjunction with any other antenna or transmitter.

Radio Frequency Interference Requirements and SAR

The FCC with its action in ET Docket 93-62 has adopted a safety standard for human exposure to Radio Frequency (RF) electromagnetic energy emitted by FCC certified equipment. The wireless LAN module meets the Human Exposure limits found in OET Bulletin 65, 2001, and ANSI/IEEE C95.1, 1992. Proper operation of this radio according to the instructions found in this manual will result in exposure substantially below the FCC's recommended limits. The following safety precautions should be observed:

- Do not touch or move antenna while the unit is transmitting or receiving.
- Do not hold any component containing the radio such that the antenna is very close or touching any exposed parts of the body, especially the face or eyes, while transmitting.
- Do not operate the radio or attempt to transmit data unless the antenna is connected; if not, the radio may be damaged.

Use in specific environments:

- The use of wireless devices in hazardous locations is limited by the constraints posed by the safety directors of such environments.
- The use of wireless devices on airplanes is governed by the Federal Aviation Administration (FAA).
- The use of wireless devices in hospitals is restricted to the limits set forth by each hospital.

Antenna use:

- In order to comply with FCC RF exposure limits, low gain integrated antennas should be located at a minimum distance of 20 cm (8 inches) or more from the body of all persons.

Explosive Device Proximity Warning

WARNING: Do not operate a portable transmitter (such as a wireless network device) near unshielded blasting caps or in an explosive environment unless the device has been modified to be qualified for such use.

Antenna Warning

WARNING: To comply with the FCC and ANSI C95.1 RF exposure limits, it is recommended that the antenna for this device be installed so as to provide a separation distance of at least 20 cm (8 inches) from all persons and that the antenna must not be co-located or operating in conjunction with any other antenna or radio transmitter. It is recommended that the user limit exposure time if the antenna is positioned closer than 20 cm (8 inches).

Use on Aircraft Caution

CAUTION: Regulations of the FCC and FAA prohibit airborne operation of radio-frequency wireless devices because their signals could interfere with critical aircraft instruments.

For IEEE 802.11a Wireless LAN:

For operation within 5.15 ~ 5.25 GHz frequency range, it is restricted to indoor usage environments, and the antenna of this device must be integral.

EMC Requirements

This device uses, generates and radiates radio frequency energy. The radio frequency energy produced by this device is well below the maximum exposure allowed by the Federal Communications Commission (FCC).

This device complies with the limits for a Class B digital device pursuant to Part 15 subpart C of the FCC Rules and Regulations. Operation is subject to the following two conditions:

- (1) This device may not cause harmful interference.
- (2) This device must accept any interference received, including interference that may cause undesired operation.

The FCC limits are designed to provide reasonable protection against harmful interference when the equipment is installed and used in accordance with the instruction manual and operated in a commercial environment. However, there is no guarantee that interference will not occur in a particular commercial installation, or if operated in a residential area.

If harmful interference with radio or television reception occurs when the device is turned on, the user must correct the situation at the user's own expense. The user is encouraged to try one or more of the following corrective measures:

- Reorient or relocate the receiving antenna.
- Increase the separation between the equipment and receiver.
- Connect the equipment into an outlet on a circuit different from that to which the receiver is connected.
- Consult the dealer or an experienced radio/TV technician for help.

CAUTION: The Part 15 radio device operates on a non-interference basis with other devices operating at this frequency. Any changes or modification to said product not expressly approved by the manufacturer could void the user's authority to operate this device.

Canada Radio Frequency Interference Requirements

To prevent radio interference to the licensed service, this device is intended to be operated indoors and away from windows to provide maximum shielding. Equipment (or its transmit antenna) that is installed outdoors is subject to licensing.

Pour empêcher que cet appareil cause du brouillage au service faisant l'objet d'une licence, il doit être utilisé à l'intérieur et devrait être placé loin des fenêtres afin de fournir un écran de blindage maximal. Si le matériel (ou son antenne d'émission) est installé à l'extérieur, il doit faire l'objet d'une licence.

European Union CE Marking and Compliance Notices

Statements of Compliance

English

This product follows the provisions of the European Directive 1999/5/EC.

Danish

Dette produkt er i overensstemmelse med det europæiske direktiv 1999/5/EC.

Dutch

Dit product is in navolging van de bepalingen van Europees Directief 1999/5/EC.

Finnish

Tämä tuote noudattaa EU-direktiivin 1999/5/EC määräyksiä.

French

Ce produit est conforme aux exigences de la Directive Européenne 1999/5/EC.

German

Dieses Produkt entspricht den Bestimmungen der Europäischen Richtlinie 1999/5/EC.

Greek

Το προϊόν αυτό πληροί τις προβλέψεις της Ευρωπαϊκής Οδηγίας 1999/5/EC.

Icelandic

Þessi vara stenst reglugerð Evrópska Efnahags Bandalagsins númer 1999/5/EC.

Italian

Questo prodotto è conforme alla Direttiva Europea 1999/5/EC.

Norwegian

Dette produktet er i henhold til bestemmelsene i det europeiske direktivet 1999/5/EC.

Portuguese

Este produto cumpre com as normas da Diretiva Europeia 1999/5/EC.

Spanish

Este producto cumple con las normas del Directivo Europeo 1999/5/EC.

Swedish

Denna produkt har tillverkats i enlighet med EG-direktiv 1999/5/EC.

Local Restrictions of 802.11a/b/g Radio Usage

CAUTION: Due to the fact that the frequencies used by 802.11a/b/g wireless LAN devices may not yet be harmonized in all countries, 802.11a/b/g products are designed for use only in specific countries or regions, and is not allowed to be operated in countries or regions other than those of designated use. As a user of these products, you are responsible for ensuring that the products are used only in the countries or regions for which they were intended and for verifying that they are configured with the correct selection of frequency and channel for the country or region of use. Any deviation from permissible settings and restrictions in the country or region of use could be an infringement of local law and may be punished as such.

The European variant is intended for use throughout the European Economic Area. However, authorization for use is further restricted in particular countries or regions within countries, as follows:

General

European standards dictate maximum radiated transmit power of 100 mW Effective Isotropic Radiated Power (EIRP) and the frequency range 2400 – 2483.5 MHz.

Belgium and the Netherlands

In Belgium and the Netherlands, the product may not be used outdoors. See the instructions next under the heading “Turning Off the Wireless LAN Radio.”

France

Departments in Which the Wireless LAN Module Can Be Used (Indoors Only)

The wireless LAN module can currently be used indoors only in the following 38 departments of mainland France. Please turn off your wireless LAN radio when operating the device in areas/places other than the 38 departments listed:

01	Ain Orientales	36	Indre	66	Pyrénées
02	Aisne	37	Indre et Loire	67	Bas Rhin
03	Allier	41	Loir et Cher	68	Haut Rhin
05	Hautes Alpes	42	Loire	70	Haute Saône
08	Ardennes	45	Loiret	71	Saône et Loire
09	Ariège	50	Manche	75	Paris
11	Aude	55	Meuse	82	Tarn et Garonne
12	Aveyron	58	Nièvre	84	Vaucluse
16	Charente	59	Nord	88	Vosges
24	Dordogne	60	Oise	89	Yonne
25	Doubs	61	Orne	90	Territoire de Belfort
26	Drôme	63	Puy du Dôme	94	Val de Marne
32	Gers	64	Pyrénées Atlantique		

Departments in Which the Wireless LAN Module's Maximum EIRP Not Shown in the Previous Table

Frequency Ranges (MHz)	Indoors	Outdoors
2400 – 2446.5	10 mW	Not permitted
2446.5 – 2483.5	100 mW	100 mW on private property with Ministry of Defense approval

Turning Off the Wireless LAN Radio

NOTE: Turning the wireless LAN radio off is not the same as disabling the wireless LAN card. It is not necessary to disable the card to meet the regulatory requirements.

While operating the computer in those French departments that do not allow use of the wireless LAN equipment, the user of the equipment must turn off the wireless LAN radio in order to comply with local regulations (see Chapter 2 for more information).

电子信息产品有毒有害物质或元素名称及含量标示

项目	部件名称	有毒有害物质或元素					
		铅 (Pb)	镉 (Cd)	汞 (Hg)	六价铬 (Cr+6)	多溴联苯 (PBB)	多溴二苯醚 (PBDE)
1	金属机构件	X	O	O	O	O	O
2	塑料机构件	O	O	O	O	O	O
3	电路板组件	X	X	O	O	O	O
4	液晶面板	X	X	X	O	O	O
5	硬盘	X	O	O	O	O	O
6	光驱	X	O	O	O	O	O
7	键盘	X	O	O	O	O	O
8	充电电池组件	X	X	O	O	O	O
9	适配器	X	X	X	O	O	O
10	电源线	X	O	O	O	O	O
11	外部信号连接线	O	O	O	O	O	O
12	钮扣电池	O	O	X	O	O	O
13	风扇	X	O	O	O	O	O
14	散热模块 (金属部分)	X	O	O	O	O	O
15	喇叭	X	O	O	O	O	O

O：表示该有害物质在该部件所有均质材料中的含量均在 SJ/T 11363-2006 规定的限量要求以下。

X：表示该有害物质至少在该部件的某一均质材料中的含量超出 SJ/T 11363-2006 规定的限量要求。

(本产品使用技术无法突破之 EU RoHS 除外项目，并于下方使用项目说明)。

使用除外项目如下：

1. 铅使用于部件、装置的内部连接用高融点锡焊上（铅为 85wt% 以上的有铅锡焊）。
2. 电子陶瓷部件（压电组件·陶瓷介质材料等）内的含铅量。
3. 电子部件的玻璃内的含铅量。
4. 两种以上元素组成之焊料，用于连接微处理器封装与针头且铅含量超过 80wt% 并少于 85wt%。
5. 铅于覆晶集成电路封装内用于铸模与基板之电子接点之焊锡。
6. 于钢材、铝材、铜材中的含铅量。
7. 通孔盘状及平面数组陶瓷多层电容器焊料所含的铅。
8. 电子接点的电镀，其要求高可靠性，且没有替代性材料之镉。
9. 电池内的含铅量。
10. 电池内的含镉量。
11. 使用于钮扣电池之含汞量。