

User's Manual

(November 2007)

WARNING

Do not attempt to disassemble your notebook computer. Doing so may void your warranty. There are no serviceable parts inside. Please refer all servicing to a qualified personnel.

TRADEMARKS

The *Bluetooth* word mark and logos are owned by the Bluetooth SIG, Inc. All brand and product names are trademarks or registered trademarks of their respective companies.

NOTE

The information in this manual is subject to change without notice.

Table of Contents

Preface	v
Notational Conventions.....	vi
Chapter 1 Getting Started	1-1
Getting the Computer Running	1-2
Unpacking	1-2
Connecting to AC Power	1-2
Opening the Cover	1-4
Turning On and Off the Computer.....	1-4
Taking a Look at the Computer.....	1-6
Right-Side Components	1-6
Left-Side Components	1-7
Rear Components	1-8
Bottom Components.....	1-9
Top-open Components	1-10
Where to Go from Here.....	1-13
Chapter 2 Operating Your Computer	2-1
Starting and Stopping the Computer	2-2
Starting the Computer	2-2
Stopping the Computer	2-2
Using the Quick Buttons	2-4
Using the Keyboard.....	2-5
Typewriter Keys.....	2-5
Cursor-Control Keys	2-6
Numeric Keypad	2-6
Function Keys	2-7
Fn Key.....	2-7

Hot Keys	2-7
Using the Touchpad	2-10
Configuring the Touchpad	2-12
Using the DVD Drive (Optional)	2-12
Inserting and Removing a Disc	2-14
Using the Video Features	2-16
Configuring the Display Modes	2-16
Using the Audio Features	2-18
Connecting Audio Devices	2-19
Using the Communication Features	2-27
Using the Modem	2-27
Using the LAN	2-28
Using the Wireless LAN	2-29
Using the <i>Bluetooth</i> [®] Wireless Feature	2-30
Using the 3G Feature (Optional)	2-37
Using the Fingerprint Sensor	2-41
Enrolling Fingerprints	2-42
Changing the Settings	2-44
Chapter 3 Managing Power	3-1
AC Adapter	3-2
Battery Pack	3-3
Charging the Battery Pack	3-3
Initializing the Battery Pack	3-4
Checking the Battery Level	3-4
Replacing the Battery Pack	3-5
Battery Low Signals and Actions	3-7
Power Management	3-8
Hibernation	3-9
Power-Saving Tips	3-10
Chapter 4 Expanding Your Computer	4-1
Connecting an External Monitor	4-2
Connecting a USB Device	4-3
Using Smart Cards	4-4

	Inserting and Removing a Smart Card	4-4
	Using PC Cards	4-6
	Inserting and Removing a PC Card.....	4-6
	Using the Card Reader	4-8
	Internal Components Upgrade.....	4-10
Chapter 5	Using BIOS Setup	5-1
	When and How to Use BIOS Setup	5-2
	When to Use.....	5-2
	Starting BIOS Setup.....	5-2
	Moving Around and Making Selections	5-4
	Main Menu	5-5
	Advanced Menu	5-6
	Security Menu	5-7
	Boot Menu.....	5-8
	Exit Menu.....	5-9
Chapter 6	Installing Software Drivers and Using the P1 Utility	6-1
	How to Use the Driver Disc	6-2
	Installing Drivers.....	6-4
	P1 Quick Launch Key Utility.....	6-6
Chapter 7	Caring for the Computer	7-1
	Protecting the Computer.....	7-2
	Using the Windows Security Center	7-2
	Using the Password	7-3
	Using the Cable Lock.....	7-4
	Taking Care of the Computer.....	7-5
	Location Guidelines	7-5
	General Guidelines.....	7-5
	Cleaning Guidelines	7-6
	Battery Pack Guidelines	7-6
	When Traveling.....	7-7

Chapter 8	Troubleshooting.....	8-1
	Preliminary Checklist.....	8-2
	Solving Common Problems.....	8-3
	Battery Problems.....	8-4
	DVD Drive Problems.....	8-4
	Display Problems.....	8-5
	Hardware Device Problems.....	8-6
	Hard Disk Drive Problems.....	8-7
	Keyboard, Mouse, and Touchpad Problems.....	8-7
	LAN Problems.....	8-8
	WLAN Problems.....	8-8
	Modem Problems.....	8-9
	Power Management Problems.....	8-10
	Software Problems.....	8-11
	Sound Problems.....	8-11
	Startup Problems.....	8-12
	Other Problems.....	8-12
	Resetting the Computer.....	8-14
Appendix A	Specifications	A-1
Appendix B	Regulatory Information	B-1
	On the Use of the System.....	B-2
	Class B Regulations.....	B-2
	Safety Notices.....	B-3
	On the Use of the RF Device.....	B-6
	USA and Canada Safety Requirements and Notices.....	B-6
	European Union CE Marking and Compliance Notices ..	B-9
	电子信息产品有毒有害物质或元素名称及含量标示....	B-13
Index	I-1

Preface

This manual contains information that will help you operate the computer. It is divided into 8 chapters, 2 appendices, and an index.

- Chapter 1, **Getting Started**, takes you through the process of setting up the computer and identifying its external components.
- Chapter 2, **Operating Your Computer**, tells you how to use the computer's components and features.
- Chapter 3, **Managing Power**, provides information on power.
- Chapter 4, **Expanding Your Computer**, provides information on installing and using peripheral devices.
- Chapter 5, **Using BIOS Setup**, describes the BIOS Setup program that configures the computer's BIOS settings.
- Chapter 6, **Installing Software Drivers and Using the TPM / P1 Utilities**, describes how to install the drivers and utilities supplied with the computer, as well as how to use TPM (Trusted Platform Module) and P1 quick launch key utilities.
- Chapter 7, **Caring for the Computer**, gives you tips in care and maintenance.
- Chapter 8, **Troubleshooting**, gives solutions to common problems you may encounter when using the computer.
- Appendix A, **Specifications**, gives a brief specification of the computer.
- Appendix B, **Regulatory Information**, provides regulatory statements and safety notices on your computer.

Notational Conventions

Throughout this manual, the following conventions are used to distinguish elements of text.

■ **NOTE:** identifies additional information that requires special attention.

■ **CAUTION:** identifies important information that, if not followed, may result in loss of data or damage to the computer.

Keyboard keys are shown in a bold typeset. For example:

Press the **Enter** key to complete.

When keys are joined by a plus sign (+), press the first key, and, while keeping the first key down, press the remaining keys, finally release all the keys. When necessary, keys are also shown in graphics.

A title, command, setup item, or button that you can see on the screen is shown in boldface. A value or an option that you can select for a setup item is shown in italic. For example:

Select **When I press the power button**, set it to *Shut down*, and then click the **Save changes** button.



Getting Started

Congratulations on purchasing this computer.

Your computer incorporates desktop computer capabilities into a compact notebook-sized package. It can greatly enhance your productivity either in the office or at home. And, of course, wherever you need it, the computer is ready and easy “to go.”

This chapter first tells you step by step how to get the computer up and running. You will find instructions for these procedures:

- Unpacking
- Connecting to AC power
- Opening the cover
- Turning on the computer
- Turning off the computer

Then, you will find a section briefly introducing the external components of the computer. And the last section navigates you to the information you may need after the computer is ready for use.

Getting the Computer Running

This section guides you through the procedures for getting the computer ready for operation.

Unpacking

After unpacking the shipping carton, you should find these standard items:

- Notebook computer
- Accessories:
 - AC adapter
 - AC power cord
 - Driver disc

Inspect all the items. If any item is damaged or missing, notify your dealer immediately.

Keep the shipping carton and packing materials in case you need to ship or store the computer in the future.

Connecting to AC Power

The computer operates either on the external AC power or internal battery power. It is suggested that you use AC power when you start up the computer for the very first time.

CAUTION: Use only the AC adapter included with your computer. Using other AC adapters may damage the computer.

1. Make sure that the computer is turned off.
2. Plug the DC cord of the AC adapter to the power connector of the computer (❶).

3. Plug the female end of the AC power cord to the AC adapter and the male end to an electrical outlet (2).



4. When the AC adapter is connected, power is being supplied from the electrical outlet to the AC adapter and onto your computer. Now, you are ready to turn on the computer.
5. When the AC adapter is connected, it also charges the battery pack. The Battery Charge Indicator on the computer glows red to indicate that charging is in progress. When the battery is fully charged, the Battery Charge Indicator is off. (For information on using battery power, see Chapter 3.)

CAUTION:

- When you disconnect the AC adapter, disconnect from the electrical outlet first and then from the computer. A reverse procedure may damage the AC adapter or the computer.
- When unplugging the connector, always hold the plug head. Never pull on the cord.

Opening the Cover

CAUTION: Be gentle when opening and closing the cover. Opening it vigorously or slamming it shut could damage the computer.

Open the top cover by lifting up the cover. You can tilt the cover forward or backward for optimal viewing clarity.



Turning On and Off the Computer

Turning On

1. Make sure that the computer is connected to AC power or the battery is fully charged.

2. Press the power button.



3. Each time the computer is turned on, it performs a Power-On Self Test (POST), and the Windows operating system should start.

Turning Off

To turn off the computer power, use the “Shut Down” command of your operating system.

NOTE: There are other ways you can stop the computer so that you will be back to where you left off when you next turn on the computer. (See “Stopping the Computer” in Chapter 2 for information.)

CAUTION: If you have to turn the computer on again immediately after turning it off, wait for at least five seconds. Turning the computer off and on rapidly can damage it.



Taking a Look at the Computer

This section identifies the external components of the computer and briefly describes the function of each component.

NOTE: Depending on the model you purchased, the appearance of your computer may not be exactly the same as those shown in this manual.

Right-Side Components



1	Audio Output Connector 	Connects a set of headphones, external speakers with amplifier, or an audio recording device.	P. 2-19
2	Microphone Connector 	Connects an external microphone.	P. 2-19
3	USB Ports 	Each of the two ports connects a USB device, such as a flash disk, printer, digital camera, joystick, and more.	P. 4-3
4	PCMCIA Slot	Accepts a PC card for additional functions.	P. 4-6
5	RJ-45 Connector	Connects the LAN cable.	P. 2-28
6	RJ-11 Connector	Connects the telephone line.	P. 2-27



Left-Side Components



1	VGA Connector	Connects an external display.	P. 4-2
2	RF (radio frequency) On/Off Switch	Serves as the master switch that allows you to turn the wireless LAN radio, <i>Bluetooth</i> radio, and WWAN on/off.	P. 2-29, 2-33,
3	USB Port 	Connects a USB device, such as a flash disk, printer, digital camera, joystick, and more.	P. 4-3
4	Card Reader	Accepts a MultiMediaCard (MMC), Secure Digital (SD), Memory Stick (MS) or Memory Stick PRO (MS PRO) card for removable storage media.	P. 4-8

Rear Components



1	Kensington Lock 	Locks the computer to a stationery object for security.	P. 7-4
2	Power Connector 	Connects the AC adapter.	P. 1-2

Bottom Components

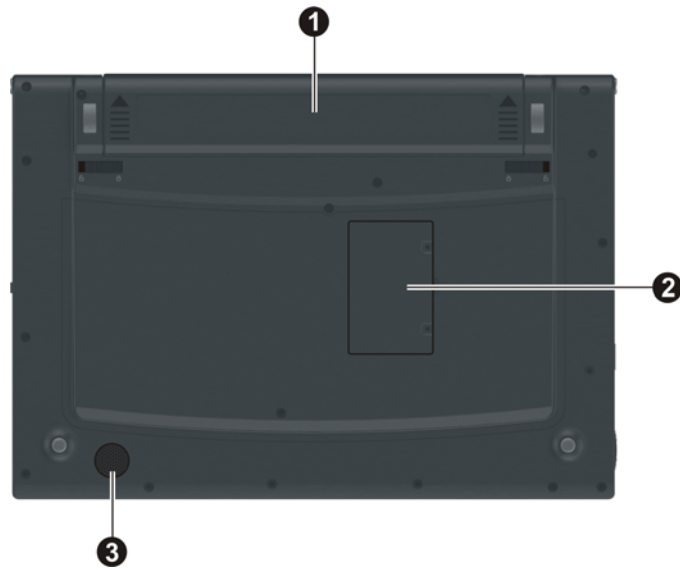





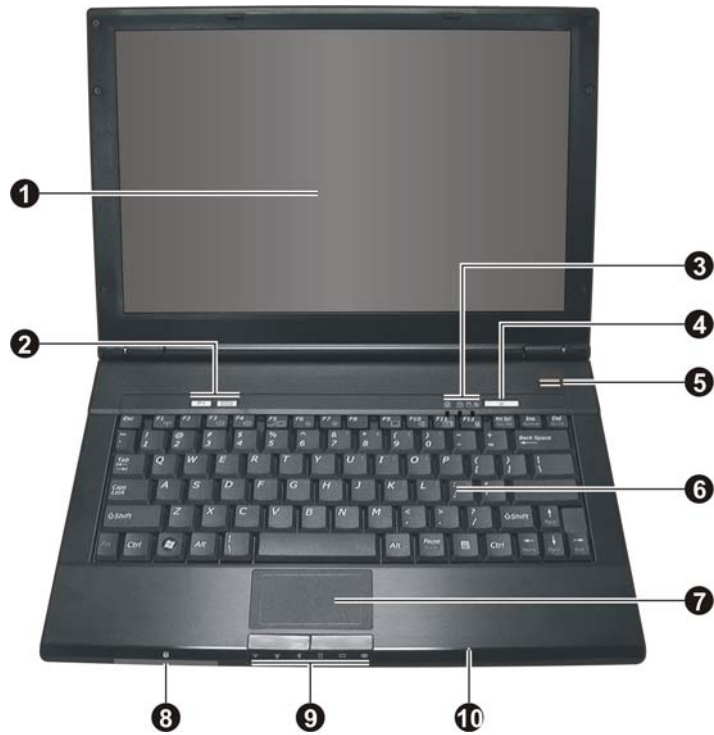







1 Battery Compartment	Battery pack supplies power to your computer when external power is not connected. Also contains the optional 3G SIM card slot.	P. 3-3 P. 2-37
2 Wireless LAN (WLAN) Card Slot	Inside is the mini PCI-E slot for using a mini PCI-E WLAN card.	P. 2-29
3 Speaker	Sends out sound and voice from the computer.	P. 2-18

Top-open Components



1	LCD Screen	Displays the output of the computer.	P. 4-2
2	Quick Buttons		
	P1	P1 (Program 1 – user customized) quick launch key. Default is Microsoft® Internet Explorer.	P. 6-6
		Enables/disables power saving when using battery power.	P. 2-4

3	Indicators	Show the current status of the computer's devices.	
		Caps Lock indicator	P. 2-5
		Num Lock indicator	P. 2-5
		Hard disk drive / optical drive in-use indicator	P. 2-12
4	Power Button 	Turns the computer power ON and OFF.	P. 1-4
5	Fingerprint Sensor	Serves as the fingerprint verification, preventing unauthorized access to your computer.	P. 2-41
6	Keyboard	Serves as the data input device of the computer.	P. 2-5
7	Touchpad	Serves as the pointing device of the computer.	P. 2-10
8	Smart Card Reader 	Accepts a smart card for additional security feature.	P. 4-4
9	Indicators	Show the current status of the computer's devices.	
	WLAN indicator 	Lights blue when WLAN is on.	P. 2-29
	3G indicator 	Lights blue when optional 3G is on.	P. 2-37
	Bluetooth® feature indicator 	Lights blue when <i>Bluetooth</i> ® feature is on.	P. 2-30
	Card Reader indicator 	Blinks blue when Card Reader is performing a read/write function.	P. 4-8
	Power indicator 	Lights blue when computer is on. Blinks blue when computer is in Sleep mode.	P. 1-4

	Battery charge indicator 	<p>Lights blue when the battery is being charged with 90 % battery capacity remaining.</p> <hr/> <p>Lights red when the battery is being charged with less than 90 % battery capacity remaining.</p> <hr/> <p>Blinks red when the battery's capacity is below 10 %.</p>	P. 3-3
	⑩ Microphone 	Receives sound and voice for the computer.	P. 2-18

Where to Go from Here

As your computer is ready for operation, you may want to do any of the following now:

To know more about the computer...	Go on to the next chapter.
To install the operating system if your dealer has not already done so...	See the operating system manual.
To know more about the operating system...	Read the operating system manual.
To install the drivers if your dealer has not already done so...	See Chapter 6.
To set a power-on password...	See “Security Menu” in Chapter 5.
To charge the battery pack for the first time...	See “Charging the Battery Pack” in Chapter 3.



Operating Your Computer

This chapter provides information about the use of the computer.

If you are new to computers, reading this chapter will help you learn the operating basics. If you are already a computer user but are new to notebook computers, you may choose to read only the parts containing information unique to your computer.

Described in this chapter are the operating basics of these components:

- Starting and stopping the computer
- Quick buttons
- Keyboard
- Touchpad
- DVD drive
- Video features
- Audio features
- Communication features
- Fingerprint sensor

Starting and Stopping the Computer

There are a number of ways to start and stop the computer.

Starting the Computer

You always start the computer using the power button.

A computer starts up with an operating system (OS) existing on the storage device such as the hard disk and optical disc. The computer will automatically load the OS after you turn it on. This process is called booting.

NOTE: An operating system is the platform for all your software application programs to run on. Your computer may use the Microsoft Windows Vista or XP operating system.

Stopping the Computer

When you finish a working session, you can stop the computer by turning off the power or leaving the computer in Sleep/Standby or Hibernation mode:

Off	Click Start → Shut Down This can prevent loss of unsaved data or damage to your software programs. If the system is locked up because of hardware or software problems, press the power button to turn off the computer.	Press the power button.
Sleep/ Standby	Depending on your settings in Windows, you can place the computer in Sleep/Standby mode by: <ul style="list-style-type: none">• Closing the display cover• Pressing the Fn+F12 hot key• Pressing the power button	Press any key.

Hibernation	Depending on your settings in Windows, you can place the computer in Hibernation mode by:	Press the power button.
	<ul style="list-style-type: none">• Closing the display cover• Pressing the power button	

If you choose to stop in Sleep/Standby or Hibernation mode, you can return to where you left off the next time you start up the computer. (See “Power Management” in Chapter 3 for more information.)

Using the Quick Buttons

Located on top of the keyboard are two quick buttons:



- P1 (Program 1 – user customized) quick launch button (P1). Default is Microsoft® Internet Explorer. See chapter 6 for more details.
- ECO button (**ECO**) to enter into power saving mode when using battery power. The system will turn down the panel backlight and sacrifice processing speed to gain more battery life.

| NOTE: The ECO button works only when using battery power.

Using the Keyboard

Your keyboard has all the standard functions of a full-sized computer keyboard plus a Fn key added for specific functions.

The standard functions of the keyboard can be further divided into four major categories:

- Typewriter keys
- Cursor-control keys
- Numeric keys
- Function keys

Typewriter Keys

Typewriter keys are similar to the keys on a typewriter. Several keys are added such as the Ctrl, Alt, Esc, and lock keys for special purposes. When the lock keys (Caps Lock, NumLk, and ScrLk) are pressed, their corresponding indicators light up.

The Control (Ctrl) / Alternate (Alt) key is normally used in combination with other keys for program-specific functions. The Escape (Esc) key is usually used for stopping a process. Examples are exiting a program and canceling a command. The function depends on the program you are using.

Cursor-Control Keys

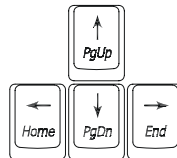

NOTE: The word "cursor" refers to the indicator on the screen that lets you know exactly where on your screen anything you type will appear. It can take the form of a vertical or horizontal line, a block, or one of many other shapes.

Numeric Keypad

A 15-key numeric keypad is embedded in the typewriter keys as shown next:

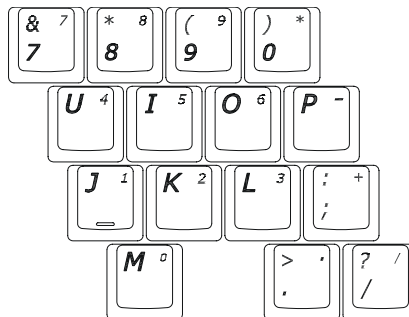

Numeric keys facilitate entering of numbers and calculations. When Num Lock is on, the numeric keys are activated; meaning you can use these keys to enter numerals.

NOTE:

- When the numeric keypad is activated and you need to type the English letter in the keypad area, you can turn Num Lock off or you can press **Fn** and then the letter without turning Num Lock off.
- Some software may not be able to use the numeric keypad on the computer. If so, use the numeric keypad on an external keyboard instead.

Function Keys

On the top row of the keys are the function keys: F1 to F12. Function keys are multi-purpose keys that perform functions defined by individual programs.





















Fn Key

The **Fn** key, at the lower left corner of the keyboard, is used with another key to perform the alternative function of a key. The letter “**Fn**” and the alternative functions are identified by the color of blue on the keytop. To perform a desired function, first press and hold **Fn**, then press the other key.

Hot Keys

Hot keys refer to a combination of keys that can be pressed any time to activate special functions of the computer. Most hot keys operate in a cyclic way. Each time a hot key combination is pressed, it shifts the corresponding function to the other or next choice.

You can easily identify the hot keys with the icons imprinted on the keytop. The hot keys are described next.

		Switches the wireless LAN radio on and off.
		Decreases the sound volume.
		Increases the sound volume.
		Switches the display output to one of the following when external devices are connected. Upon booting the system with CRT: <pre> graph LR LCD --> LCD_CRT[LCD+CRT] LCD_CRT --> CRT CRT --> LCD </pre>
		Decreases the LCD brightness.
		Increases the LCD brightness.
		Switches the touchpad off and on (depending on your model).
		Switches the system sound output off (mute) and on.
		Switches LCD display on and off.
		Serves as the sleep button that you can define with Windows' Power Options . (See the "Power Management" in Chapter 3.)



Euro Symbol



You can press the euro dollar sign € on various keyboards.

- To press the euro sign on a United States-International keyboard, hold down the Alt Gr key and press 5 (which has an euro sign on it).
- To press the euro sign on a standard United States keyboard, hold down either of the Alt keys and type 0128 on the numeric keypad part of your keyboard.
- To press the euro sign on an UK keyboard, hold down the Alt Gr key and press 4 (which has an euro sign on it).

Windows Keys

The keyboard has two keys that perform Windows-specific functions:

 Windows Logo key and  Application key.

The  Windows Logo key opens the **Start** menu and performs software-specific functions when used in combination with other keys. The  Application key usually has the same effect as a right mouse click. (See your Windows manual for more information.)

Using the Touchpad

CAUTION: Do not use a sharp object such as a pen on the touchpad. Doing so may damage the touchpad surface.

NOTE: For optimal performance of the touchpad, keep your fingers and the pads clean and dry. When tapping on the pad, tap lightly. Do not use excessive force.

The touchpad is a pointing device that allows you to communicate with the computer by controlling the location of the pointer on the screen and making selection with the buttons.



The touchpad consists of a rectangular pad and a left and right buttons. To use the touchpad, place your forefinger or thumb on the pad. The rectangular pad acts like a miniature duplicate of your display. As you slide your fingertip across the pad, the pointer (also called cursor) on the screen moves accordingly. When your finger reaches the edge of the pad, simply relocate yourself by lifting the finger and placing it on the other side of the pad.

Here are some common terms that you should know when using the touchpad:

Point	Move your finger on the pad until the cursor points to the selection on the screen.
Click	Press and release the left button. –or– Tap gently anywhere on the pad.
Double-click	Press and release the left button twice in quick succession. –or– Tap twice on the pad rapidly.
Drag and drop	Press and hold the left button, then move your finger until you reach your destination (drag). Finally, release the button (drop) when you finish dragging your selection to the destination. The object will drop into the new location. –or– Gently tap twice on the pad and on the second tap, keep your finger in contact with the pad. Then, move your finger across the pad to drag the selected object to your destination. When you lift your finger from the pad, the selected object will drop into place.
Scroll	To scroll is to move up and down or left and right in the working area on the screen. To move vertically, place your finger on the right or left edge of the pad and slide your finger up and down along the edge. To move horizontally, place your finger on the top or bottom edge of the pad and slide your finger left and right. This function works only after you install the touchpad driver supplied with the computer and it may not work for all applications.

TABLE NOTE: If you swap the left and right buttons, “tapping” on the touchpad as an alternative method of pressing the left button will no longer be valid.

Configuring the Touchpad

You may want to configure the touchpad to suit your needs. For example, if you are a left-handed user, you can swap the two buttons so that you can use the right button as the left button and vice versa. You can also change the size of the on-screen pointer, the speed of the pointer, and so on.

To configure the touchpad if you are using Windows Vista, go to **Control Panel → Hardware and Sounds → Mouse Properties**. If you are using Windows XP, you can use the standard Microsoft or IBM PS/2 driver. However, you can install the touchpad driver supplied with your computer to take advantage of more powerful features. (For information on installing the driver, see “How to Use the Driver Disc” in Chapter 6.)

Using the DVD Drive (Optional)

You can connect an external DVD drive, usually configured as drive D to your computer.

Depending on the model, your drive is one of the following:

- **DVD Dual drive** can work both as a DVD-ROM drive for reading DVD (Digital Versatile Disc) discs in addition to CDs, audio CDs and CD-R/-RW discs, and CD-RW drive. Can also write to DVD+R/DVD+RW/-R/-RW discs.
- **Super Multi drive** besides the DVD Dual drive function, can write to DVD-RAM discs.

CAUTION:

- When inserting a disc, do not use force.
- Make sure that the disc is correctly inserted into the tray, and then close the tray.
- Do not leave the DVD tray open. Also, avoid touching the lens in the tray with your hand. If the lens becomes dirty, the DVD drive may malfunction.
- Do not wipe the lens using materials with rough surface (such as paper towel). Instead, use a cotton swab to gently wipe the lens.

FDA regulations require the following statement for all laser-based devices:
"Caution, Use of controls or adjustments or performance of procedures other than those specified herein may result in hazardous radiation exposure."

NOTE: The DVD drive is classified as a Class 1 laser product. This label is located on the DVD drive.

**CLASS 1 LASER PRODUCT
LASER KLASSE 1**

NOTE: For DVD and Combo drives only.

This product incorporates copyright protection technology that is protected by method claims of certain U.S. patents and other intellectual property rights owned by Macrovision Corporation and other rights owners. Use of this copyright protection technology must be authorized by Macrovision Corporation, and is intended for home and other limited viewing uses only unless otherwise authorized by Macrovision Corporation. Reverse engineering or disassembly is prohibited.

Inserting and Removing a Disc

Follow this procedure to insert or remove a disc:

1. Turn on the computer.
2. Plug the DC cord of the AC adapter to the power connector of the DVD drive (❶) and the male end to an electrical outlet (❷). Connect the mini-USB end of the USB Y-cable to the mini-USB port (❸) of the DVD drive and the other end to your computer (❹).

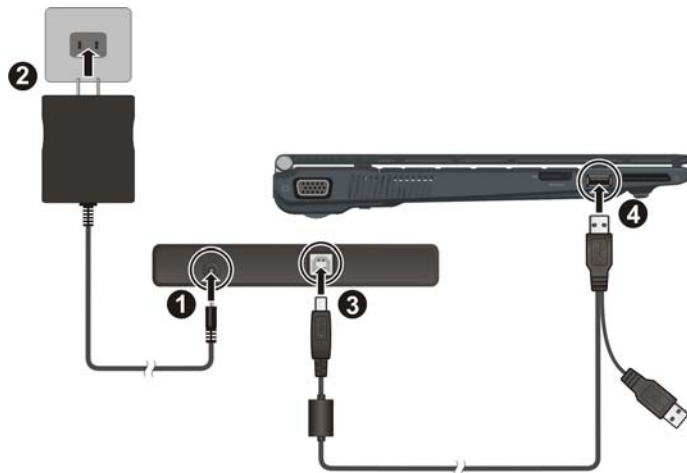

3. Press the eject button and the DVD tray will slide out partially. Gently pull on it until it is fully extended.

4. To insert a disc, place down the disc in the tray with its label facing up. Slightly press the center of the disc until it clicks into place.

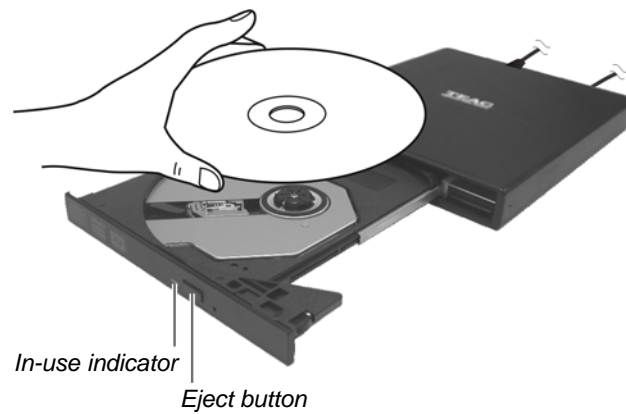

To remove a disc, hold the disc by its outer edge and lift it up from the tray.

5. Gently push the tray back into the drive.

NOTE: In the unlikely event that you are unable to release the DVD tray by pressing the eject button, you can manually release the disc. (See "DVD Drive Problems" in Chapter 8.)

Using the Video Features

The video subsystem of your computer features:

- 12.1-inch TFT (Thin-Film Transistor) color LCD display with 1280×800 WXGA resolution
- Simultaneous display on LCD and external display, which is useful when you have a presentation as you can control the screen from your computer and face the audience at the same time.
- Multi-display capability, which allows you to expand your desktop on the screen to another display device so that you have more desktop space to work on.
- Power Management

NOTE:

- Before using the multi-display capability or taking advantage of the enhanced video capabilities, the video driver supplied with your computer must be installed. (See chapter 6 for details.)
- The computer enters the Sleep/Standby or Hibernation mode when the LCD is closed.
If you want to use the computer in Windows Vista with the LCD closed, set *Do Nothing* to the "When I Close the lid" option in the **Power Options** → **System Settings** Properties.
If you want to use the computer in Windows XP with the LCD closed, set *Do Nothing* to the "When I close the lid of my portable computer" option in the **Power Options** Properties.
Thus the computer does not enter the Sleep/Standby or Hibernation mode when the LCD is closed.

Configuring the Display Modes

NOTE: When using an external CRT monitor, the resolution depends on the CRT monitor's supported resolution.

Your computer has been set to a default resolution and number of colors before shipment. You can view and change display settings through your operating system. See your operating system documentation or online help for specific information.

For displaying in higher resolutions, you can connect an external monitor that supports higher resolutions. (See “Connecting an External Monitor” in Chapter 4 for more information.)

Using the Audio Features

NOTE:

- To take advantage of the enhanced audio capabilities, the audio driver supplied with your computer must be installed. (See chapter 6 for details.)
- If you experience interference while recording, try lowering the microphone recording volume.

The audio subsystem of your computer features:

- Built-in sound system for recording and playing sound on your computer
- Azalia interface (high density audio codec)
- Built-in microphone (❶)
- Speaker (❷) on the bottom side, and
- External audio connectors (❸)





Ways of playing and recording sound vary with the operating system used. See your operating system documentation or online help for specific information.

Connecting Audio Devices

For higher audio quality, you can send or receive sound through external audio devices.

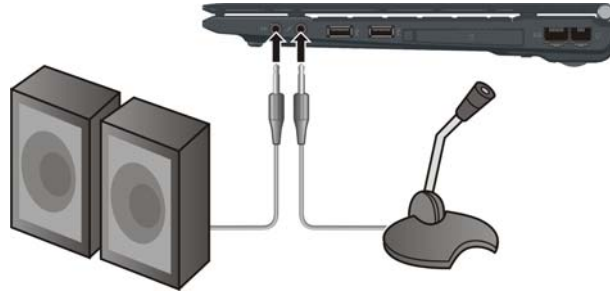
NOTE: After connecting an external audio device, make sure that you specify the use of the correct audio device in Windows.



- **Audio Output Connector** () can be connected to speakers, headphones, or earphone set.
- **Microphone Connector** () can be connected to an external microphone for recording voice or sound.

NOTE: When using the external speakers/headphones or microphone, you cannot use the internal one.

Adjusting the Recording Volume

When the recorded volume via the built-in microphone is too low, you can adjust it by performing the following:

Using Windows Vista

When adjusting via the Volume icon on the system tray.

1. Right-click the Volume icon on your Windows system tray and select **Recording Devices**.



2. Double-click the Microphone option and the **Microphone Properties** screen appears. Click the **Levels** folder and manually use the slider to increase the level of **Microphone Boost**.

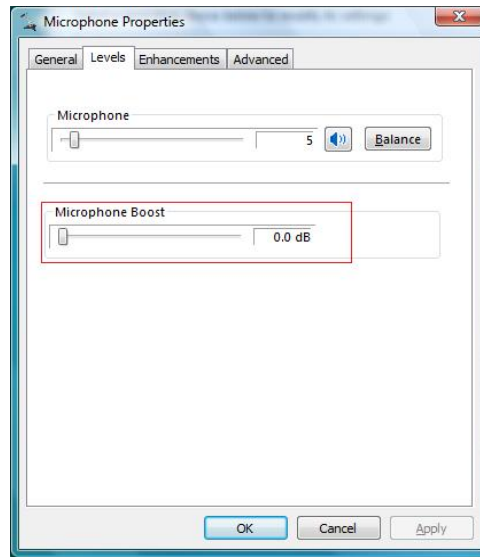

3. Click **OK** to exit.

When adjusting via the Realtek HD Audio Manager icon on the system tray.

1. Right-click the Realtek HD Audio Manager icon on your Windows system tray and select **Realtek HD Audio Manager**.

2. The Realtek HD Audio Manager screen appears, click the Microphone folder.

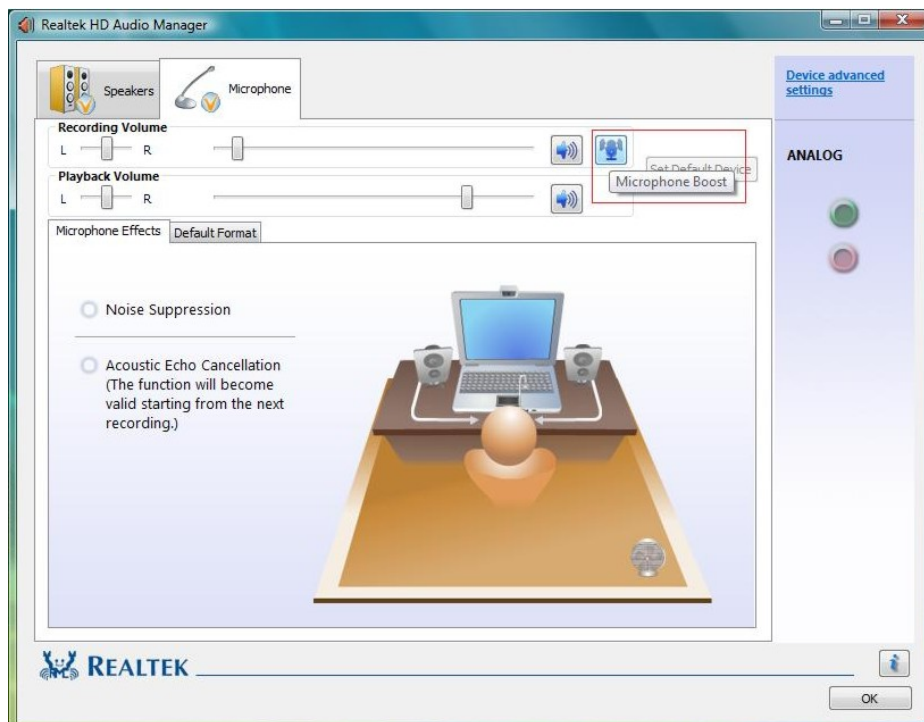

3. Click the Microphone Boost icon.

4. Manually use the slider to increase the level of Microphone Boost.

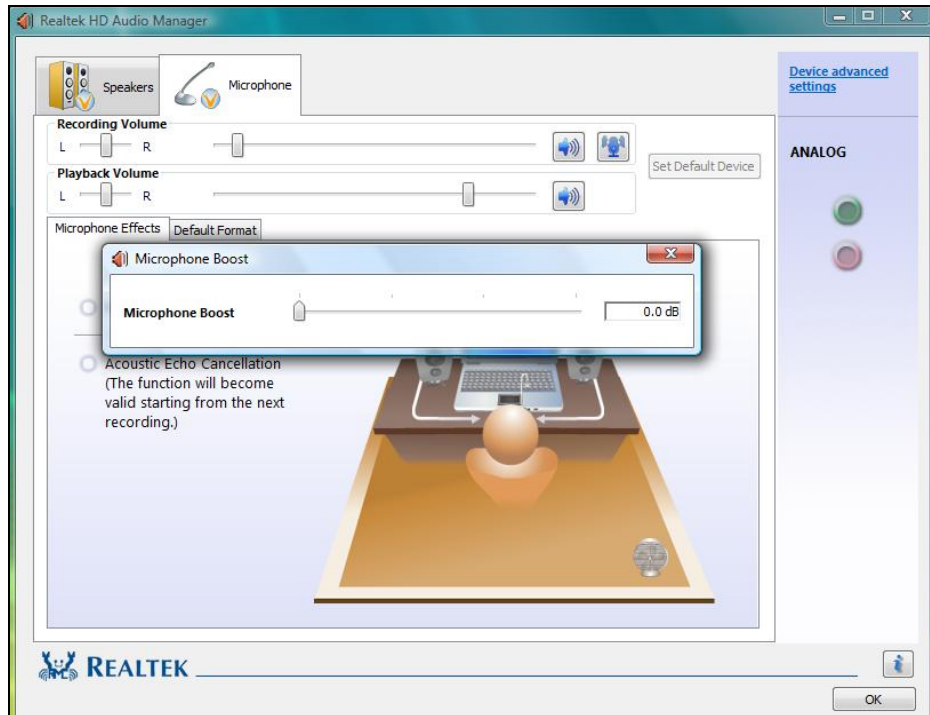

5. Click OK to exit.

Using Windows XP

When adjusting via the Volume icon on the system tray.

1. Double-click the Volume icon on your Windows system tray and the Master Volume window appears. Click Options → Properties.

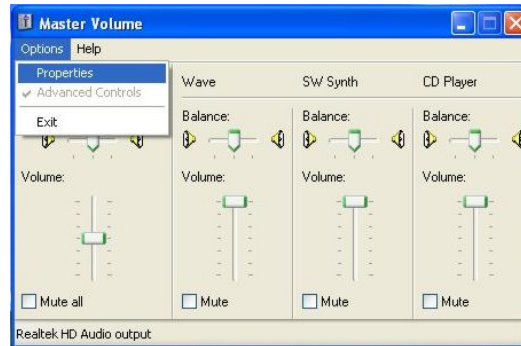

2. The Properties window appears. Click to enable the Mic Volume item (a checkmark appears). Then click OK.

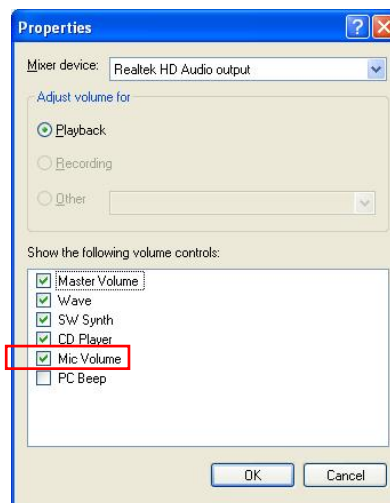

3. Click **Options** → **Advanced Controls**. The last column **Mic Volume** would show on screen.

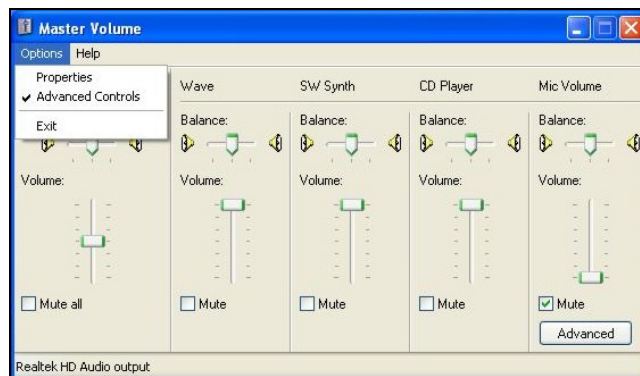

4. Click the **Advanced** button and the **Advanced Controls for Mic Volume** window appears.

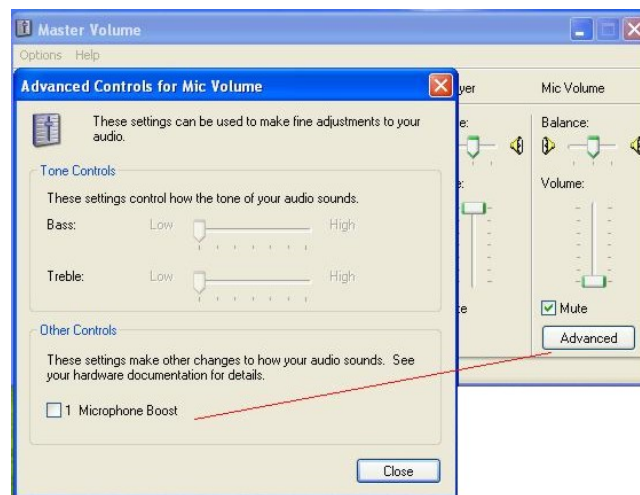

5. Click to enable the item **Microphone Boost**. Click **Close** to exit.

When adjusting via the Realtek HD Audio Manager icon on the system tray.

1. Right-click the Realtek HD Audio Manager icon on your Windows system tray and select **Realtek HD Audio Manager**.
2. The **Realtek HD Audio Manager** screen appears, click the **Mixer** folder.



3. Click the **Advanced setting** button on the **Mic Volume** column and the **Advanced setting** window appears.
4. Click to enable the item **Microphone Boost**. Then click **OK** to exit.

Using the Communication Features

Using the Modem

NOTE: To take advantage of the modem feature, the modem driver supplied with your computer must be installed. (See chapter 6 for details.)

The internal 56 K fax/data modem allows you to use the telephone line to communicate with others by fax, email, or connect to an online service or bulletin board.

To connect the telephone line to the modem, connect one end of the modem cable to the RJ-11 connector on the computer and the other end to the phone line.



NOTE:

- When using the communication software, you may have to disable power management.
- Set the COM port of the modem to COM3.
- Set parameters such as modem speed (baud rate) and line type (pulse dialing or tone dialing).
- Do not enter the Sleep/Standby mode when using the communication software.

Using the LAN

NOTE: To take advantage of the LAN feature, the LAN driver supplied with your computer must be installed. (See chapter 6 for details.)

The internal 10/100/1000Base-T LAN (Local Area Network) module allows you to connect your computer to a network. It supports data transfer rate up to 1000 Mbps.

To connect the network cable to the LAN module, connect one end of the LAN cable to the RJ-45 connector on the computer and the other end to the network hub.



Using the Wireless LAN

Depending on your model, an internal mini PCI-E wireless LAN (WLAN) card may have been pre-installed by your computer manufacturer at the factory. This card allows you to access corporate networks or the Internet in a wireless environment.

The WLAN features include:

- Peer-to-Peer (Ad-Hoc) and Access Point (Infrastructure) modes support
- WEP (Wired Equivalent Privacy) 64/128-bit data encryption
- IEEE 802.11a/b/g/n standard compliance

802.11a	54	54, 48, 36, 24, 18, 12, 9, 6	5.15 ~ 5.35	OFDM (Orthogonal Frequency Division Multiplexing)
802.11b	11	11, 5.5, 2, 1	2.412 ~ 2.462	DSSS (Direct Sequence Spread Spectrum)
802.11g	54	54, 36, 18, 9	2.4	OFDM (Orthogonal Frequency Division Multiplexing)
802.11n	100 Mbps or more	100 ~ 210	2.4 / 5	Spatial multiplexing, uses MIMO (multiple-input multiple-output)

To take advantage of the WLAN feature, make sure that the WLAN driver is installed correctly. (See chapter 6 for details.) If your WLAN card was provided by your dealer instead of the computer manufacturer, contact your dealer for the correct driver to use.

Turning Off/On the WLAN Radio

NOTE: The FAA (Federal Aviation Agency) has deemed it unsafe to operate wireless devices in aircraft as this may interfere with flight safety. Remember to turn off wireless LAN when using your computer in the airplane.

To turn on the WLAN radio:

1. Make sure that the RF switch is at the ON position.



2. Press Fn+F1 to turn on the WLAN radio (see “Hot Keys” in Chapter 2), indicated by the WLAN indicator () glowing in blue when on.

If you need to temporarily turn off the radio, press Fn+F1. To resume network connection, press Fn+F1 again.

It takes approximately 30 seconds for your computer to make a successful WLAN connection and approximately 10 seconds to disconnect.

Connecting to a Wireless Network (Windows Vista)

To connect to a wireless network:

1. Make sure that the WLAN radio is on (see the previous section).
2. Right-click the **Wireless Network Connection** icon  located on the Windows system tray and select **Connect to a network**.

3. If any wireless network is detected, the following window appears on screen. Click the **Show** drop down menu and select **Wireless**.

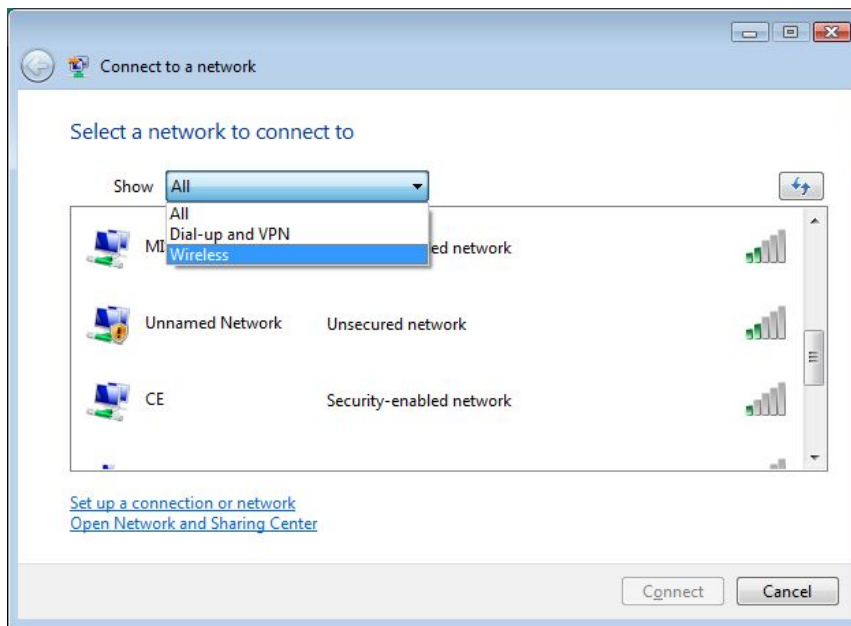

4. Select a wireless network to connect to by clicking a selection, then click **Connect**.
5. Depending on the settings, you may be asked to enter a WEP key (refer to your Windows online help for more information on setting a wireless network connection).

Connecting to a Wireless Network (Windows XP)

To connect to a wireless network:

1. Make sure that the WLAN radio is on (see the previous section).

2. Double-click the Wireless Network Connection icon  located on your Windows system tray. If any wireless network is detected, the following window appears on screen.

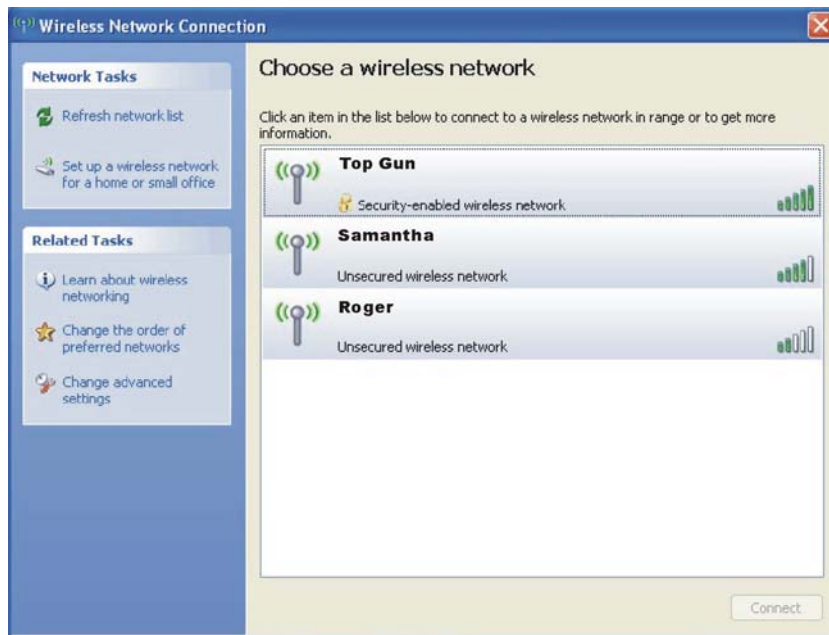

3. Select a wireless network to connect to by clicking a selection, then click **Connect**.
4. Depending on the settings, you may be asked to enter a WEP key (refer to your Windows online help for more information on setting a wireless network connection).

Using the *Bluetooth*[®] Wireless Feature

NOTE: To take advantage of the Bluetooth feature, the Bluetooth driver supplied with your computer must be installed. (See chapter 6 for details.)

Depending on your model, your computer may incorporate the Bluetooth capability for short-range (about 10 meters) wireless communications between devices without requiring a cable connection.

With Bluetooth, data can be transmitted through walls, pockets and briefcases as long as two devices are within range.

Turning On and Off the Bluetooth Feature

NOTE: You can still use the WLAN feature when the Bluetooth feature is turned on.

1. Make sure that the RF switch is at the ON position.



2. Right-click the System Utility icon () located on Windows system tray and select **Quick Bar**.



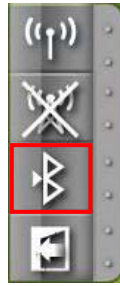

3. The following appears onscreen. To turn on the Bluetooth feature, click the Bluetooth quick button.



The Bluetooth indicator () will glow in blue. By default, your computer is in the general discoverable and pairable mode after the Bluetooth feature is turned on.

4. To turn off the Bluetooth feature, click the Bluetooth quick button again.

The status of the Bluetooth connection is indicated by the Bluetooth icon located in the system tray in the lower-right part of the screen.

Off	 (blue with red logo)
On	 (blue with white logo).
Connected	 (blue with green logo)

You can use the Bluetooth Utility to configure Bluetooth connection settings and transfer files.

Connecting to Another Bluetooth Device

1. Make sure that the target Bluetooth device is turned on, discoverable and within close range. (See the documentation that came with the Bluetooth device.)
2. Click **Start** and then **Programs**.

3. Click IVT BlueSoleil and then BlueSoleil. The following screen appears.

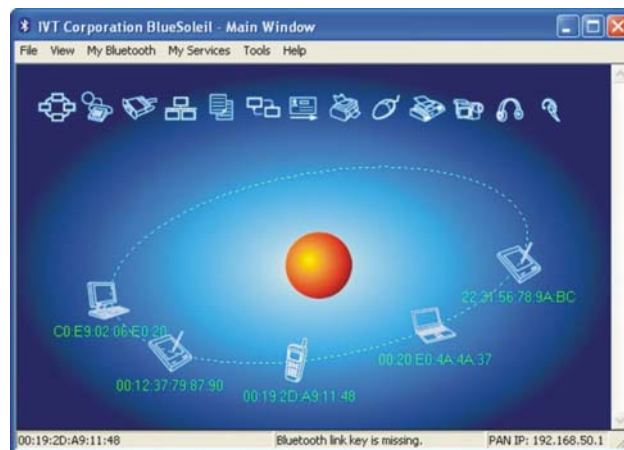

4. Click View, then Refresh Devices to check if any Bluetooth device is detected.

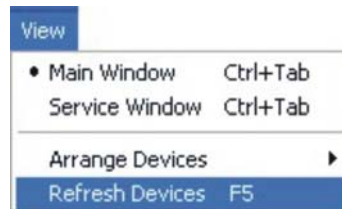

5. To connect to a new device, click **Tools** then click **Add New Device**.

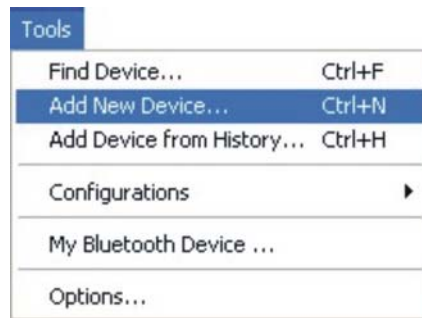

6. Depending on the type of Bluetooth device that you want to connect to, you will need to enter the pertinent information.

For detailed information on using the Bluetooth Utility, see the Bluetooth Utility Help on your computer by clicking on **Help**, then **Contents and Index**.



Using the 3G Feature (Optional)



NOTE: To take advantage of the 3G feature, the 3G driver (includes the software application) supplied with your computer must be installed. (See chapter 6 for details.)

3G is the third generation of mobile phone standards and technology, after 2G. It is based on the International Telecommunication Union (ITU) family of standards under the International Mobile Telecommunications programme, “IMT-2000”. Services include wide-area wireless voice telephony and broadband wireless data, all in a mobile environment.

Unlike IEEE 802.11 networks, 3G networks are *wide area cellular telephone networks* which evolved to incorporate high-speed internet access and video telephony. IEEE 802.11 networks are short range, high-bandwidth networks primarily developed for data

To use the 3G feature on your computer, you need to subscribe to 3G service and install the 3G SIM card from your service provider, network operator, or other vendor.

To install the SIM card, follow these steps:

1. Make sure that the computer is not turned on or connected to AC power.
2. Place the computer upside down.
3. Slide the battery security lock outward to the unlock () position ().

- Slide the battery release lever outward to the unlock (🔓) position (❶) and, while holding it in the unlock position, remove the battery pack off the computer (❷).

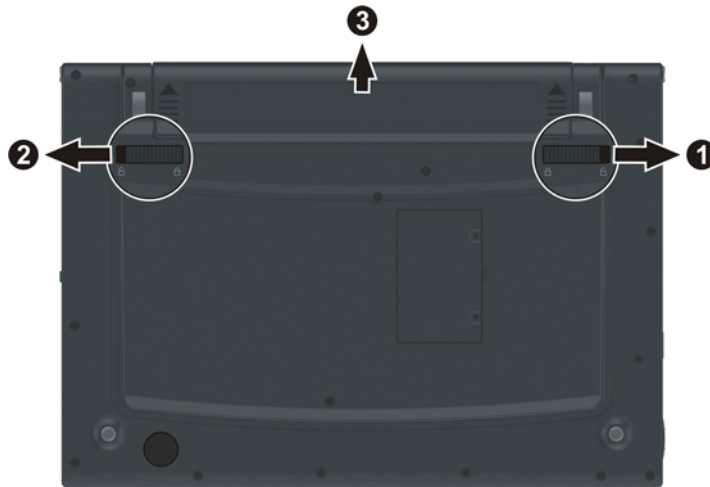

- Locate the SIM card slot and insert the SIM card into the holder. Make sure the beveled corner on the SIM card is facing towards the computer and that the golden contact area on the card is facing downwards.



6. Fit another battery pack into place and slide the battery security lock to the lock (🔒) position.

WARNING: Keep all SIM cards out of the reach of small children. For availability and information on using SIM card services, contact your SIM card vendor. This may be the service provider, network operator, or other vendor.

NOTE: To remove the SIM card, push inward to release and slide the SIM card out of the slot.

Turning On and Off the 3G Feature

1. Make sure that the RF switch is at the ON position.



2. Right-click the System Utility icon (🌐) located on Windows system tray and select **Quick Bar**.

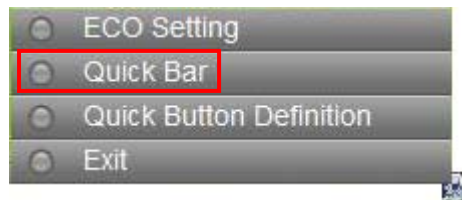

3. The following appears onscreen. To turn on the 3G feature, click the 3G quick button.



The 3G indicator () will glow in blue.

4. To turn off the 3G feature, click the 3G quick button again.

You can use the 3G software application to configure 3G connection settings.

Using the Fingerprint Sensor

To start using the fingerprint sensor:

1. Locate the fingerprint sensor.
2. Go to Start menu → Programs → Protector Suite QL → Control Center. The following screen appears.



The computer features the Fingerprint Control Center utility for enrolling your fingers for added security. It contains the following:

- Fingerprints – for enrolling or editing fingerprint templates
- Settings – for configuring the fingerprint software
- Help – for browsing the Fingerprint Control Center online Help

NOTE: For an online Help information on using the Embassy Security Center, you can also go to Start menu → Programs → Protector Suite QL → Help.

Enrolling Fingerprints

To start enrolling your fingerprint(s):

1. Click **Fingerprints** on the main menu.
2. Then click **Initialize**.



3. The following screen appears. Read carefully the contents of the **Welcome** screen and then click **Next** to continue.

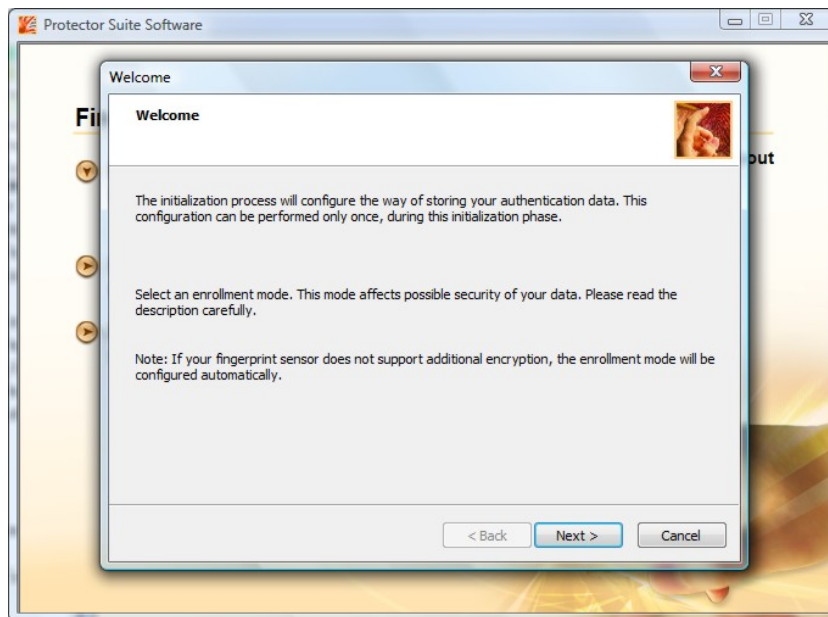

4. Follow the onscreen instructions to complete enrolling your fingerprint(s).

Changing the Settings

To change the settings of your fingerprint software:

1. Click **Settings** on the main screen.
2. Then click **System Settings**.



3. The following screen appears. Proceed to make the necessary settings to your fingerprint software.

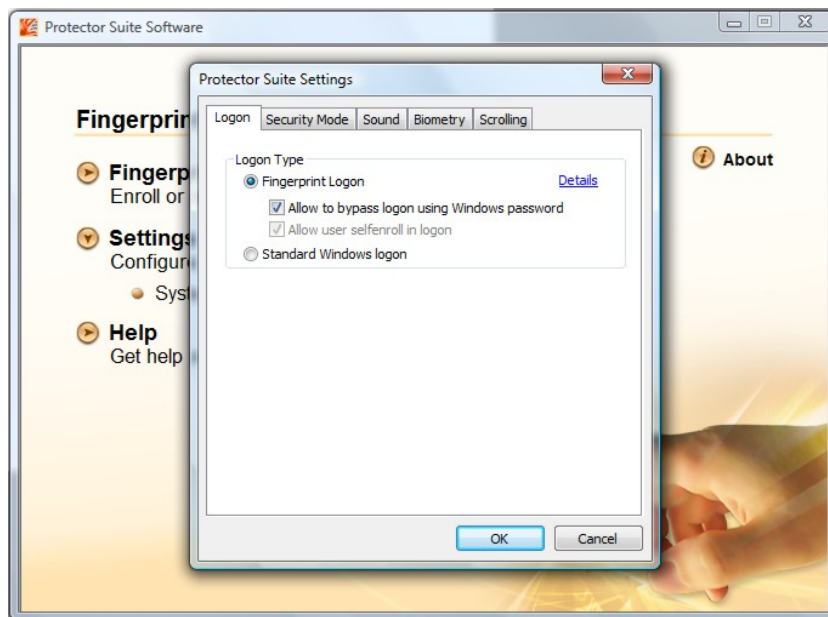

4. Click OK after you have finished with your settings.



Managing Power

Your computer operates either on external AC power or on internal battery power.

This chapter tells you how you can effectively manage power. To maintain optimal battery performance, it is important that you use the battery in the proper way.

The topics in this chapter include:

- What is an AC adapter
- How to charge the battery pack
- When and how to initialize the battery pack
- How to check the battery level
- How to replace the battery pack
- What happens when the battery is low and what actions to take
- What is Power Management
- How to save power

AC Adapter

CAUTION:

- The AC adapter is designed for use with your computer only. Connecting the AC adapter to another device can damage the adapter.
- The AC power cord supplied with your computer is for use in the country where you purchased your computer. If you plan to go overseas with the computer, consult your dealer for the appropriate power cord.
- When you disconnect the AC adapter, disconnect from the electrical outlet first and then from the computer. A reverse procedure may damage the AC adapter or computer.
- When unplugging the connector, always hold the plug head. Never pull on the cord.

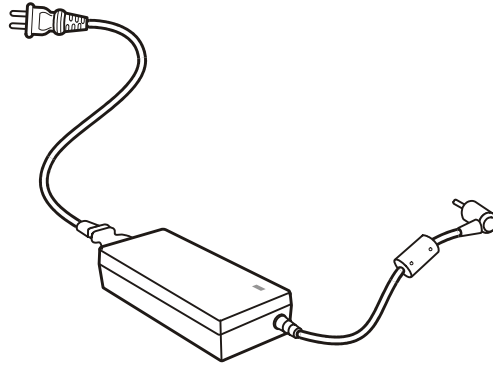

The AC adapter serves as a converter from AC (Alternating Current) to DC (Direct Current) power because your computer runs on DC power, but an electrical outlet usually provides AC power. It also charges the battery pack when connected to AC power.

The adapter operates on any voltage in the range of 100~240 V AC.

Battery Pack

The battery pack is the internal power source for the computer. It is rechargeable using the AC adapter.

The operating time of a fully charged battery pack depends on how you are using the computer. When your applications often access peripherals, you will experience a shorter operating time.

NOTE: Care and maintenance information for the battery is provided in the "Battery Pack Guidelines" section in Chapter 7.

Charging the Battery Pack

NOTE:

- Charging will not start if the battery's temperature is below 0 °C (32 °F) or above 45 °C (113 °F).
- The charging process will stop and the Battery Charge Indicator flashes red when the battery's temperature gets above 60 °C (140 °F). If this happens, the battery pack may be damaged. Please contact your dealer.
- During charging, do not disconnect the AC adapter before the battery has been fully charged; otherwise you will get a prematurely charged battery.

To charge the battery pack, connect the AC adapter to the computer and an electrical outlet. The Battery Charge Indicator () on the computer glows red to indicate that charging is in progress. You are advised to keep the computer power off while the battery is being charged. When the battery is fully charged, the Battery Charge Indicator is off.

The charging times are as follows:

3-cell (2600 mAH)	3 hours	3.3 hours
6-cell (5200 mAH)	4 hours	4.6 hours

CAUTION: After the computer has been fully recharged, do not immediately disconnect and reconnect the AC adapter to charge it again. Doing so may damage the battery.

NOTE: The battery level may automatically lessen due to the self-discharge process (0.21 % per day), even when the battery pack is fully charged (100 %). This happens no matter if the battery pack is installed in the computer.

Initializing the Battery Pack

You need to initialize a new battery pack before using it for the first time or when the actual operating time of a battery pack is much less than expected.



Initializing is the process of fully charging, discharging, and then charging. It can take several hours.

1. Make sure that the computer power is turned off. Connect the AC adapter to fully charge the battery pack.
2. After the battery pack is fully charged, turn on the computer. When the message “**Click mouse or press Enter for Menu**” appears, click the touchpad’s left button or press the Enter key to invoke the program.
3. A small window appears, select “**Launch System Setup.**”
4. Disconnect the AC adapter and leave the computer on until the battery is fully discharged. The computer will shut down automatically.
5. Connect the AC adapter to fully charge the battery pack.

Checking the Battery Level

NOTE: Any battery level indication is an estimated result. The actual operating time can be different from the estimated time, depending on how you are using the computer.

By Operating System

You can check the approximate battery level using the battery meter function of the operating system. To read the battery level in Windows Vista, click the  icon on the system tray. To read the battery level in Windows XP, click the  icon on the taskbar. (Click the  icon if the computer is using AC power.)

By Gas Gauge

On the exterior side of the battery pack is a gas gauge for displaying the estimated battery charge. When the battery pack is not installed in the computer and you want to know the battery charge, you can press the switch with a pointed device to see the corresponding value of indicator segment that light green. The value of the corresponding green segment indicates the relative percentage of the battery charge. The battery pack is fully discharged when you see no segment glowing green.

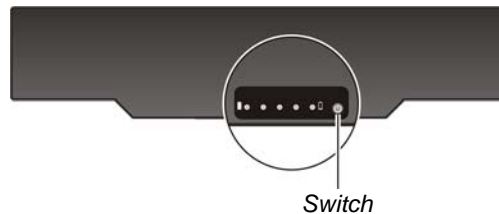

Replacing the Battery Pack

CAUTION:

- There is danger of explosion if the battery is incorrectly replaced. Replace the battery only with the computer manufacturer's optional battery packs. Discard used batteries according to the dealer's instructions.
- Do not attempt to disassemble the battery pack.

If you often rely on battery power for a long period of time while traveling, you may consider the purchase of an additional battery pack from your dealer and keep it with you in a fully charged state as a backup.

To replace the battery pack, follow these steps:

1. Make sure that the computer is not turned on or connected to AC power.
2. Place the computer upside down.
3. Slide the battery security lock outward to the unlock (🔓) position (❶).
4. Slide the battery release lever outward to the unlock (🔓) position (❷) and, while holding it in the unlock position, remove the battery pack off the computer (❸).

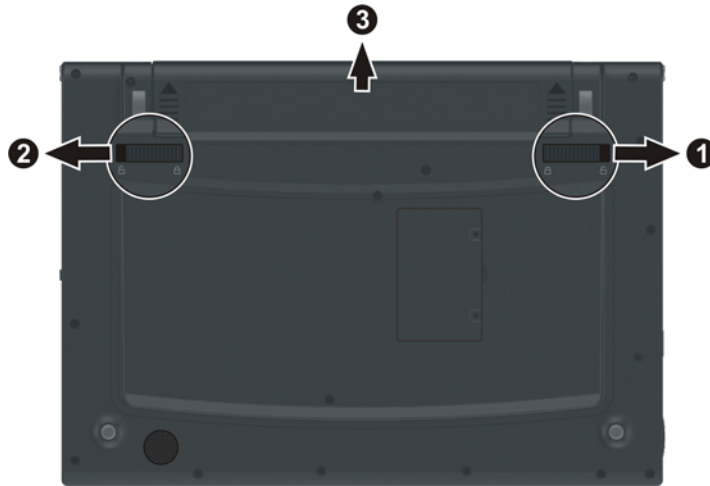

5. Fit another battery pack into place and slide the battery security lock to the lock (🔒) position.



Battery Low Signals and Actions

For Windows XP

Battery Low occurs when the battery has approximately 10 % (Windows default setting) of its charge remaining. The computer gives warning beeps or messages.

|| **NOTE:** You can set up your threshold and signals of Battery Low under Windows XP.

For Windows Vista

The battery icon  changes appearance to display the current state of the battery so that you can see how much charge remains (Windows default setting). When the battery charge is above 25 % the battery icon is green. When the battery charge reaches 25 % a yellow triangle with an exclamation point (!) appears above the green battery icon. When the charge reaches the low battery level a red circle with a white “X” appears above the green icon. The computer’s Battery Charge Indicator () blinks amber to alert you to take actions.

Immediately save your data upon Battery Low. The remaining operating time depends on how you are using the computer. If you are using the audio subsystem, PC card, hard or USB flash disk, the battery might run out of charge very quickly.

Always respond to Battery Low by placing your computer on Hibernation mode, turning off the computer, or connecting the AC adapter.

|| **CAUTION:**

- If you are using a PC card, do not access the card during battery low periods. This is because the access may take longer than the time it takes the battery to run out of charge, thus making your access to the card unsuccessful.
- If you fail to save your data when the battery completely runs out of charge, then you lose your data.

Power Management

Your computer supports ACPI (Advanced Configuration and Power Interface) for power management. The power management feature allows you to reduce the power consumption for energy saving.

With an ACPI-compliant operating system such as Windows Vista/XP, power supply to different computer components is controlled on an as-needed basis. This allows maximum power conservation and performance at the same time.

In general, Windows' power management works in this way:

Power to the hard disk is turned off	When the hard disk has been idle for a set period.
Power to the display is turned off	When the display has been idle for a set period.
The computer enters the Sleep/Standby mode. The hard disk and display are turned off and the entire system consumes less power.	When the entire system has been idle for a set period.
	When you press the Fn+F12 hot key. *
	When you close the cover. *
The computer enters the Hibernation mode. (See the next subsection for more information.)	When you press the power button. *
	When the entire system has been idle for a set period.
	When you press the Fn+F12 hot key. *
	When you close the cover. *
	When you press the power button. *

* Depends on your settings in Windows.

For detailed information on power management, see Windows' Help.

Hibernation

NOTE:

- When using Windows Vista, make sure that the hibernation feature is enabled in the “When I press the power button,” “When I press the sleep button,” and “When I close the lid” of the **Power Options → System Settings** Properties from the **Control Panel → Mobile PC**.
- When using Windows XP, make sure that the hibernation feature is enabled in the **Hibernate** tab of the **Power Options** Properties from the Control Panel.

Hibernation is a very useful feature. People frequently open many applications when they use computers. It takes some time to get all these applications open and running, and normally they all have to be closed before the computer can be turned off.

When you use the hibernation feature, you do not have to close the applications. The computer stores the state of your computer to a file on the hard disk and then shuts down. The next time you turn on your computer, you return to exactly where you left off.

Power-Saving Tips

Aside from enabling your computer's power saving mode (see previous section), you can do your part to maximize the battery's operating time by following these suggestions.

- Do not disable Power Management. Choose a power plan that saves power when using Windows Vista. A power plan is a collection of hardware and system settings that control how your computer manages power.
- Decrease the LCD brightness to the lowest comfortable level.
- Shorten the length of time before Windows turn off the display.
- Many USB devices use power just by being connected. If you use a USB mouse, you can save power by disconnecting the mouse and using the touchpad. If you use a USB flash drive, unplug it when you are not using it.
- If you work with an application that uses a PC card, exit the application when you finish using it.
- If you have a PC card installed, remove it when not in use. Some PC cards drain power even while they are inactive.
- Deactivate the WLAN function if you are not using it. (See Chapter 2.)
- Deactivate the Bluetooth wireless function if you are not using it. (See Chapter 2.)
- Turn off the computer when you are not using it.



Expanding Your Computer

You can expand the capabilities of your computer by connecting other peripheral devices. When using a device, be sure to read the instructions accompanying the device together with the relevant section in this chapter.

This chapter gives guidelines on installing and using these devices:

- External monitor
- USB device
- Smart Card
- PC card
- Card Reader

Connecting an External Monitor

If you want the benefits of a larger display screen with higher resolution, you can connect an external CRT monitor or LCD monitor to your computer. Follow this procedure to connect an external monitor:

1. Make sure that the computer is not turned on.
2. Plug the monitor's signal connector to the computer's VGA connector.



3. Plug one end of the monitor's power cord into the power socket on the monitor and the other end to an electrical outlet.
4. To use the monitor, turn on the monitor before turning on the computer.
5. The monitor should respond by default. If not, you can switch the display to the monitor or to both (simultaneous display), or to multi-display by pressing the Fn+F5 hot key. In Windows Vista, you can also change the display through the **Display Settings Properties**. In Windows XP, you can also change the display through the settings in **Display Properties**.
6. You can change display settings through your operating system. See your operating system documentation or online help for specific information.

CAUTION: Do not disconnect the external monitor while the computer is in the Sleep/Standby mode or Hibernation mode. If no external monitor is connected when the computer resumes, the LCD might not display properly.

Connecting a USB Device

Your computer has three USB ports for connecting USB devices, such as a digital camera, scanner, printer, modem, and mouse.

The USB ports support transfer rates up to 12 MB/s for USB 1.1 devices and 480 MB/s for USB 2.0 devices.

To connect a USB device, simply plug the device cable to one of the USB ports.

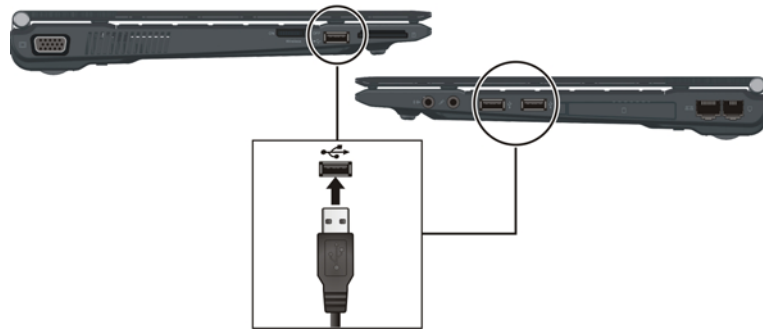

Using Smart Cards

Your computer has a smart card slot for additional security feature, providing tamper-proof storage of user and account identity. A smart card is a type of plastic card embedded with a computer chip that stores and transacts data between you (user) and the computer.

You need to install third-party smart card software to take advantage of the smart card feature.

Inserting and Removing a Smart Card

To insert a smart card:

1. Locate the smart card slot.
2. Slide the smart card, with its label and embedded computer chip facing up into the slot.



3. When a new card is seated, use the third-party smart card software to allow your computer to read it.

To remove a smart card:

1. Make sure that the third-party smart card software is not accessing the smart card.
2. Pull the card out of the slot.

Using PC Cards

Your computer has a PC card slot which supports type II card and CardBus specifications.

Inserting and Removing a PC Card

NOTE:

- Some PC cards require additional system resources. Before using such PC card, you may have to free other system resources for the PC card.
- Although some PC cards can be inserted and removed without turning off the computer, you cannot remove or install PC cards during Sleep mode.

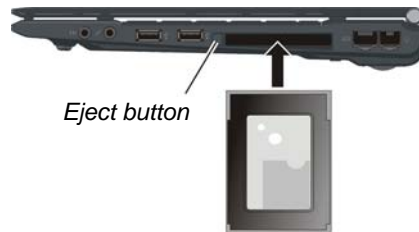

To insert a PC card:

1. Locate the PC card slot on the right side of the computer.
2. Slide the PC card, with its label facing up, into the slot until the eject button pops out.



3. When a new card is seated, the computer will detect it and try to install the appropriate driver. Follow the on-screen instructions to complete the process.

To remove a PC card:

1. Double-click on the **Safely Remove Hardware**  icon found on the Windows Vista taskbar ( icon found on the Windows XP taskbar) and the **Safely Remove Hardware** window appears on screen.
2. Select (highlight) the PC card from the list to disable the card.
3. Push the eject button and the card will slide out slightly.
4. Pull the card out of the slot.

Using the Card Reader

NOTE:

- To take advantage of the Card Reader, the Card Reader driver supplied with your computer must be installed. (See chapter 6 for details.)
- If your hard disk is divided into several drives, make sure that all drives have been formatted before using the Card Reader. Otherwise, you may encounter problems when using the Card Reader.
- You can use only storage cards. Your Card Reader does not support cards with I/O (input/output) functions such as a wireless network card or Bluetooth card.

Your computer has a Card Reader. The Card Reader is a small drive for reading from and writing to removable storage cards (or called memory cards). The Card Reader supports the MultiMediaCard (MMC), Secure Digital (SD), Memory Stick (MS) and Memory Stick PRO (MS PRO) cards.

Shown next are the appearance and size of each card type for your reference.

Appearance			
Size	24×32×1.4 (mm)	24×32×2.1 (mm)	21.5×50×2.8 (mm)

To insert a storage card:

1. Locate the Card Reader slot on the left side of the computer.
2. Align the card with its connector pointing to the slot and its label facing up. Slide the card into the slot until it reaches the end.



3. Windows will detect the card and assign it a drive name (typically E).

To remove a storage card:

1. Click Start, then Computer.
2. Right-click the drive with the card and select **Safely Remove**.
3. Pull the card out of the slot.

Internal Components Upgrade

You can upgrade your computer by changing the CPU and hard disk or adding memory. However, to avoid damage during the installation procedure, please ask your dealer for help. Do not install an internal component by yourself.



Using BIOS Setup

BIOS Setup Utility is a program for configuring the BIOS (Basic Input/Output System) settings of the computer.

BIOS is a layer of software, called firmware, that translates instructions from other layers of software into instructions that the computer hardware can understand. The BIOS settings are needed by your computer to identify the types of installed devices and establish special features.

This chapter tells you how to use the BIOS Setup program.

When and How to Use BIOS Setup

When to Use

You need to run BIOS Setup Utility when:

- You see an error message on the screen requesting you to run BIOS Setup Utility.
- You want to restore the factory default settings.
- You want to modify some specific settings according to the hardware.
- You want to modify some specific settings to optimize the system performance.

Starting BIOS Setup

NOTE:

- The BIOS Setup Utility screens shown in this chapter are for your reference only. The actual items or settings on your computer may differ.
- The BIOS Setup Utility program may have been updated after the publication of this manual.
- The settings you select in your operating system might override similar settings in BIOS Setup Utility.

To run BIOS Setup Utility, press the Enter key or click the left touchpad button when the prompt appears on the screen during system startup. The prompt shows up on the screen for only a few seconds. You must press the Enter key or click the left touchpad button quickly. A small window appears, select **Launch System Setup**. The BIOS Setup Utility main screen appears as shown next.

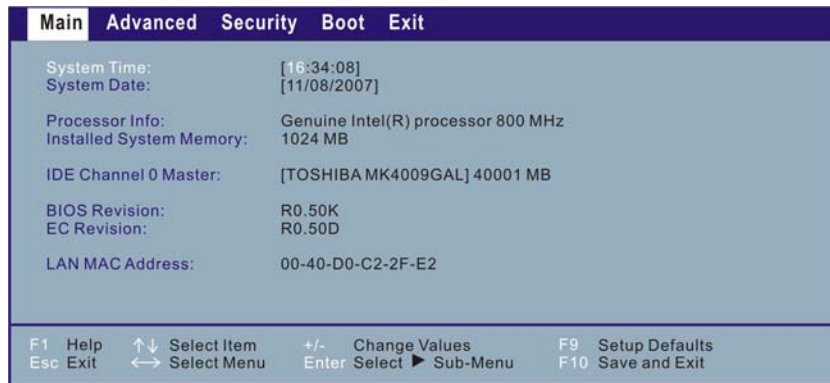

The BIOS Setup Utility screen can be divided into three areas:

- On the top is the menu bar containing the titles of the available menus. Each menu title brings a specific menu.
- The left column of the menu displays the menu items.
- The top-right of the menu provides more detailed information when a menu item is highlighted.
- The bottom of the menu provides keyboard instructions for moving around and making selections.

Moving Around and Making Selections

You must go through two or three levels to complete the setting for an item. In most cases, there are three levels: menu title, pull-down menu, and submenu.

Use the keyboard to move around and make selections. Keyboard information can be found at the bottom of the screen. A brief description of keyboard usage is listed next:

← , →	Selects a menu title.
↑ , ↓	Selects an item or option.
Enter	1) Brings up the sub-menu when available. 2) Opens or closes the option window when an item is selected.
Esc	1) Exits BIOS Setup Utility. 2) Closes the option window if one is open.
F9	Loads setup defaults.
F10	Saves and exit the BIOS Setup Utility.

Main Menu

The Main menu contains the system date and time settings as well as shows the basic configuration of the system.

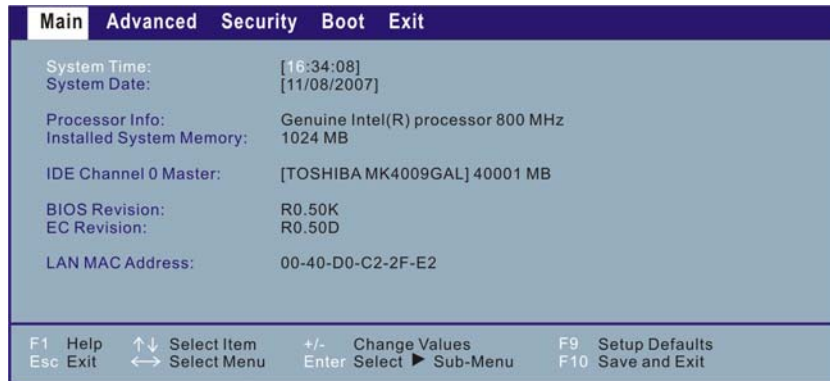

System Time sets the system time.

System Date sets the system date.

Advanced Menu

The Advanced menu contains various system settings.

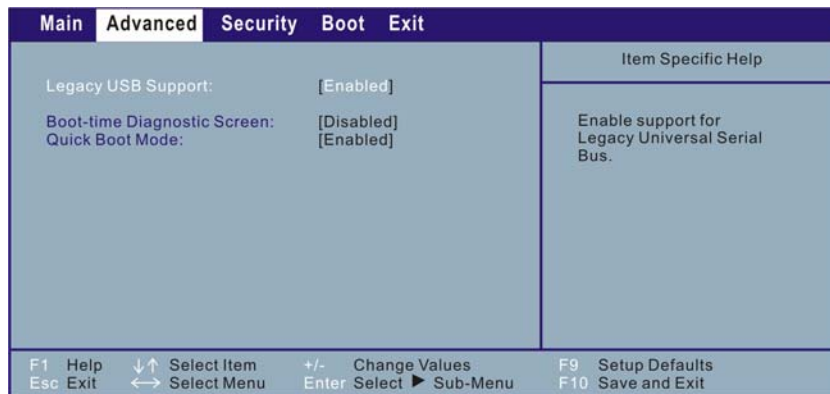

Legacy USB Support allows you to enable support for Legacy USB device in DOS mode.

Boot-time Diagnostic Screen allows you to display the diagnostic screen during system boot.

Quick Boot Mode allows the system to skip certain tests while booting. This will decrease the time needed to boot the system.

Security Menu

TPM is a component on your computer's mainboard that is specifically designed to enhance platform security above-and-beyond the capabilities of today's software by providing a protected space for key operations and other security critical tasks. Using both hardware and software, TPM protects encryption and signature keys at their most vulnerable stages – operations when the keys are being used unencrypted in plain-text form. TPM is specifically designed to shield unencrypted keys and platform authentication information from software-based attacks.

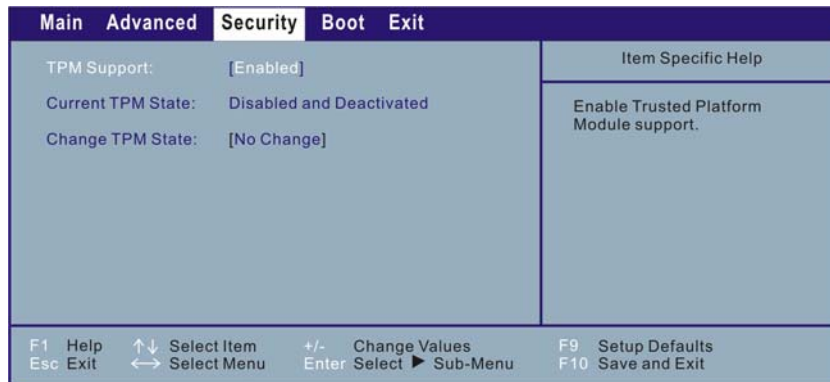

TPM Support allows you to enable or disable TPM support.

Current TPM State shows the current TPM state.

Change TPM State allows you to select between *No Change*, *Clear, Deactivate & Disable*, and *Enable & Activate*.

Boot Menu

The Boot menu sets the sequence of the devices to be searched for the operating system.

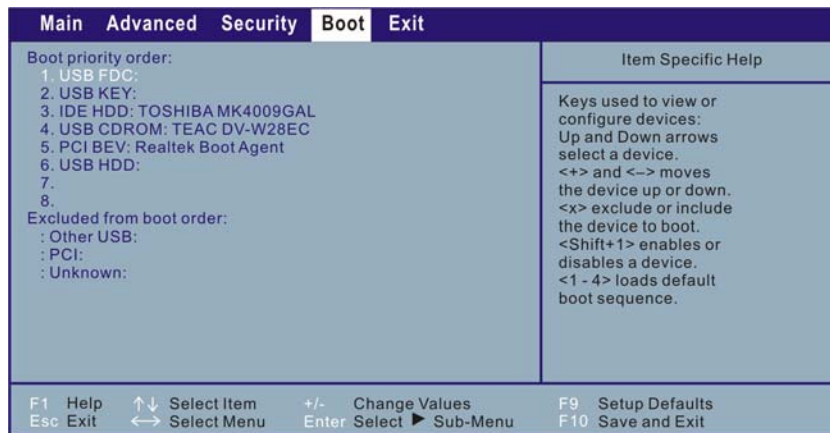

The bootable devices will be automatically detected during POST and shown here, allowing you to set the sequence that the BIOS use to look for a boot device from which to load the operating system.

A brief description of keyboard usage is listed next:

↑, ↓	Selects (highlight) a boot device.
+, -	Changes the boot sequence.
1 to 4	Loads the four default boot sequence.
Shift + 1	Enables or disables a device.
X	Moves the highlighted boot device from the “Boot priority order” list to the “Excluded from boot order” list, and vice versa.

Exit Menu

The Exit menu displays ways of exiting BIOS Setup Utility. After finishing with your settings, you must save and exit so that the changes can take effect.

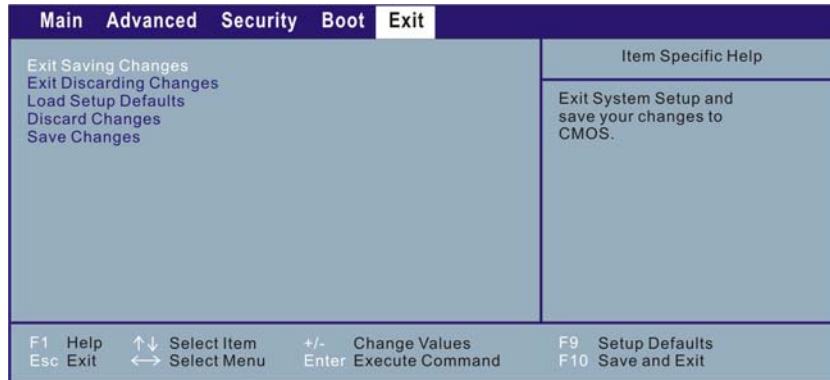

Exit Saving Changes saves the changes you have made and exits BIOS Setup Utility.

Exit Discarding Changes exits BIOS Setup Utility without saving the changes you have made.

Load Setup Defaults loads the factory default values for all the items.

Discard Changes restores the previous values for all the items.

Save Changes saves the changes you have made.



Installing Software Drivers and Using the P1 Utility

To take full advantage of the unique features of your computer, some operating systems require custom software, known as drivers, to be installed.

If you purchased the computer with Windows pre-installed, your dealer may have already installed the drivers. If not, you need to install the drivers using the disc supplied with your computer.

Also, located on top of your keyboard is the P1 quick launch key. The quick launch key utility allows you to re-define (customize) the P1 quick launch key according to your needs.

This chapter describes how to install the drivers as well as use the P1 utility.

How to Use the Driver Disc

NOTE:

- The drivers may have been updated after this manual was published. For driver upgrade, please contact your dealer.
- This disc supports Windows Vista only.
- The available items may differ according to your computer model.
- Do not remove the driver disc when installing the driver.

An autorun program is provided on the driver disc to help you easily install the drivers. As you insert the disc, the autorun program automatically starts. If you need to start the program manually, run the **Setup.exe** program from the **Wsetup** directory of the disc.

The main screen appears as shown next:



Click **NEXT** located on the right lower part of main screen to view the next screen as shown next.

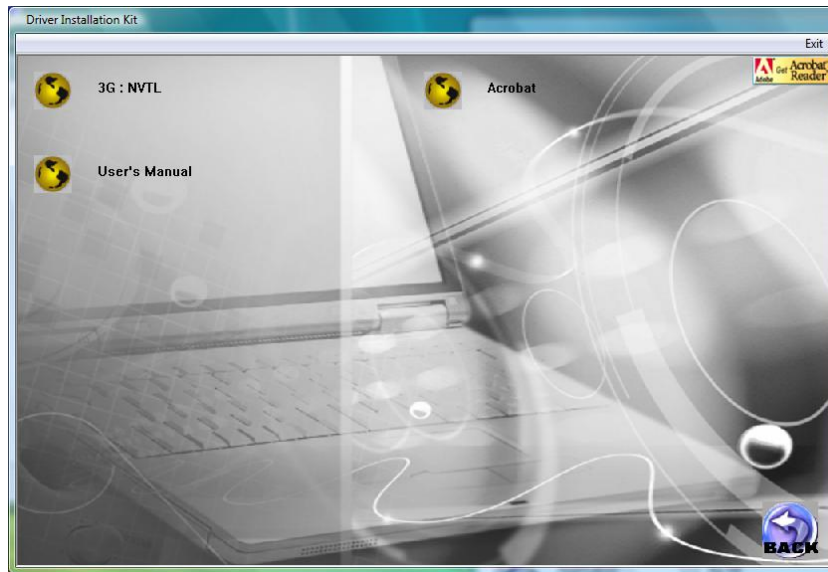

Click **BACK** to return to the main screen.

Installing Drivers

To install the intended driver, click on the particular item and installation will start. The drivers are described next:

Chipset	Ensures the full function of the following drivers. Install this driver before installing the other device drivers.
VGA	Installs the video driver that allows you to select high-resolution displays with richer colors.
Audio	Installs the audio driver that allows you to take full advantage of the audio subsystem.
Card Reader	Installs the driver that allows the Card Reader to access MultiMediaCard (MMC), Secure Digital (SD), Memory Stick (MS) or Memory Stick PRO (MS PRO) card for removable storage media.
LAN	Installs the LAN driver that allows you to use the network function of the computer.
Modem	Installs the modem driver that allows you to use the modem function of the computer.
Touchpad	Installs the touchpad driver that allows you to take full advantage of the touchpad features.
Bluetooth	Installs the Bluetooth driver and application program that allows you to use the Bluetooth feature.
WLAN	Installs the WLAN driver and application program that allows you to use the computer's internal mini PCI-E WLAN card's network function. NOTE: The Windows Plug-and-Play capability may automatically detect the new device (mini PCI-E WLAN card) and display the wizard requesting for drivers. Click Cancel to bypass the wizard screen(s).
Fingerprint driver	Installs the driver that allows you to use the fingerprint module security verification system.
TPM driver	Installs the TPM driver, a hardware-based security feature that allows you to create and manage computer-generated digital certificates.
OSD	Install the driver that allows you to use the hot keys with OSD

	(on-screen display) on the computer.
3G (optional)	Installs the 3G driver that allows you to use the 3G feature.
Acrobat	Installs the Adobe Acrobat Reader program if you do not have it on your computer. You need Adobe Acrobat Reader to open the manual file supplied on this driver disc.
User's Manual	Allows you to view the User's Manual.
Exit	Allows you to exit driver installation (located on the right upper portion).

P1 Quick Launch Key Utility

By default, P1 is assigned as Microsoft® Internet Explorer quick launch key. The quick launch key utility that allows you to re-define the P1 quick launch key.

To start the utility, right-click the System utility icon () and select **Quick Button Definition** on the Windows system tray.



The **Quick Button Definition** window appears as shown next.

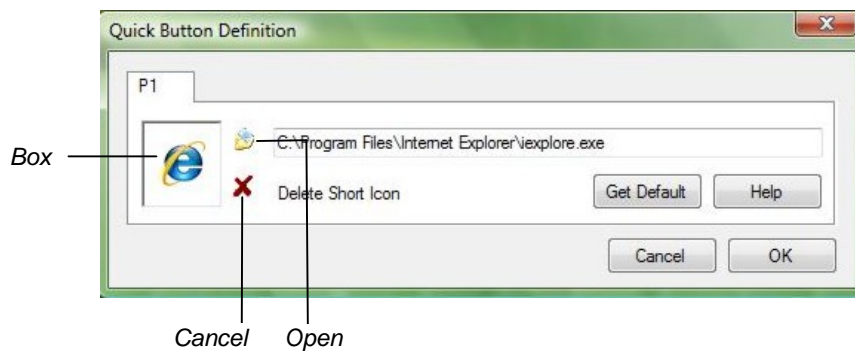

Defining the buttons:

The box in the window represents the user-definable button.

To assign a program to a button, click the Open  icon to pop up the Select a File to Open dialog box as shown next and select the desired program. Then, click Open to complete the process.

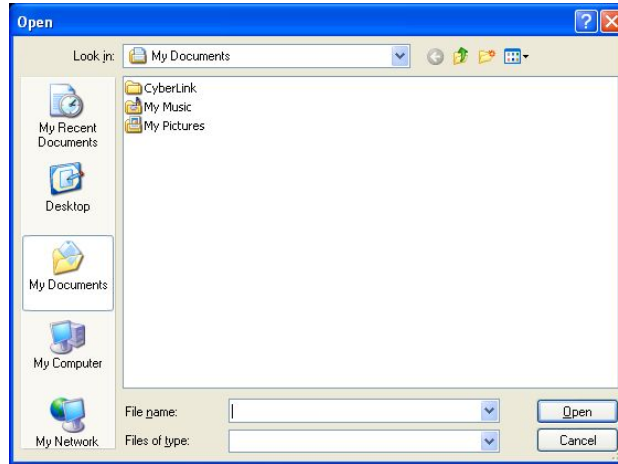

The appropriate icon will then appear in the box. To launch the program, press the P1 quick launch key, or, if the Quick Button Definition window is open, click the box containing the icon.



Caring for the Computer

Taking good care of your computer will ensure a trouble-free operation and reduce the risk of damage to your computer.

This chapter gives you guidelines covering these areas of maintenance:

- How to protect the computer
- What to note when using and storing the computer
- How to clean the computer
- What to note when using the battery pack
- What to note when traveling with the computer

Protecting the Computer

To safeguard the integrity of your computer data as well as the computer itself, you can protect the computer in several ways as described in this section.

Using the Windows Vista Security Center

Windows Security Center protects your computer against intrusion.

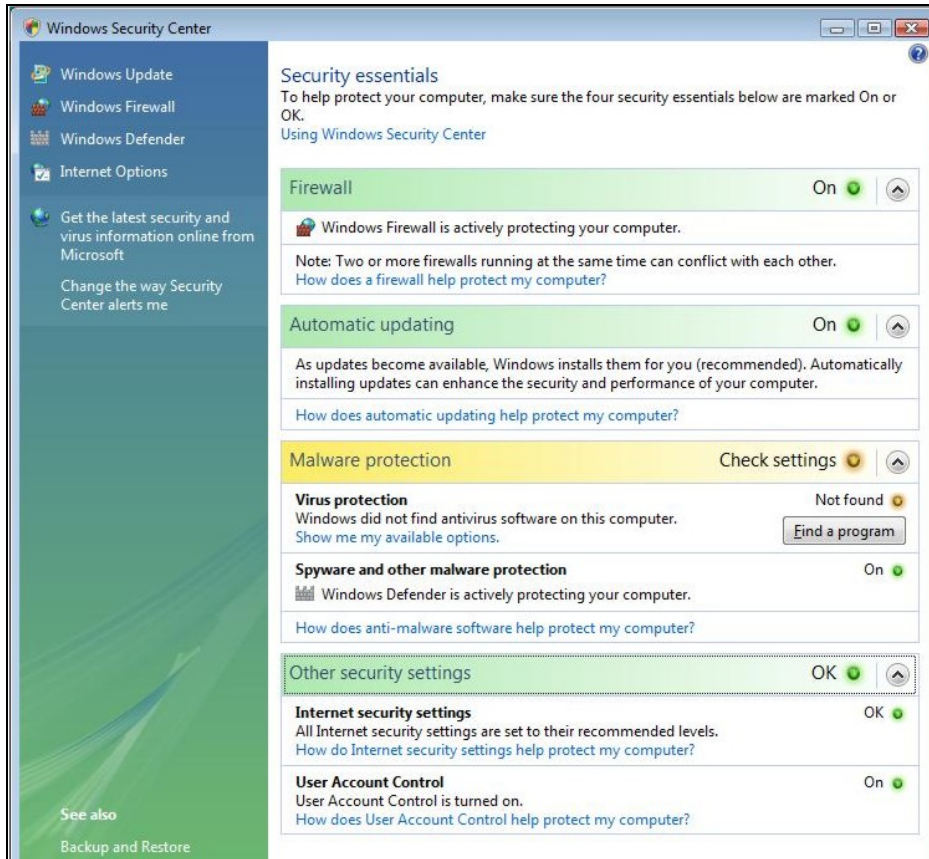

Windows Security Center alerts you to take action on the following security essentials:

- Windows Firewall
- Windows Update
- Malware Protection (anti-virus, anti-spyware)
- Others (Internet security, user account control)

For detailed information on Windows Security Center, see Windows' Vista Help.

Using the Password

The power-on password protects your computer against unauthorized use. If the password is set, the prompt requesting for the password appears on the screen whenever the computer is turned on.

The password is set via the BIOS Setup program. See "Security Menu" in Chapter 5 for instructions.

Using the Cable Lock

You can use a Kensington-type cable lock to protect your computer against theft. The cable lock is available in most computer stores.

To use the lock, loop the lock cable around a stationary object such as a table. Insert the lock to the Kensington lock hole and turn the key to secure the lock. Store the key in a safe place.



Taking Care of the Computer

Location Guidelines

- Use the computer where the temperature is between 10 °C (50 °F) and 35 °C (95 °F).
- Avoid placing the computer in a location subject to high humidity, extreme temperatures, mechanical vibration, direct sunlight, or heavy dust.
- Do not cover or block any ventilation openings on the computer. For example, do not place the computer on a bed, sofa, rug, or other similar surface. Otherwise, overheating may occur that results in damage to the computer.
- Keep the computer at least 13 cm (5 inches) away from electrical appliances that can generate a strong magnetic field such as a TV, refrigerator, motor, or a large audio speaker.
- Do not move the computer abruptly from a cold to a warm place. A temperature difference of more than 10 °C (18 °F) will cause condensation inside the unit, which may damage the storage media.
- Do not place the computer on an unsteady surface.

General Guidelines

- Do not place heavy objects on top of the computer when it is closed as this may damage the display.
- The screen surface is easily scratched. Do not use paper towels to clean the display. Avoid touching it with your fingers, pen, or pencil.
- To maximize the life of the backlight in the display, allow the backlight to automatically turn off as a result of power management. Avoid using a screen saver or other software that prevents the power management from working.

Cleaning Guidelines

- Never clean the computer with its power on.
- Use a soft cloth moistened with water or a non-alkaline detergent to wipe the exterior of the computer.
- Gently wipe the display with a soft, lint-free cloth. Do not use alcohol or detergent on the display.
- Dust or grease on the touchpad can affect its sensitivity. Clean the pad by using adhesive tape to remove the dust and grease on its surface.

Battery Pack Guidelines

- Recharge the battery pack when it is nearly discharged. When recharging, make sure that the battery pack is fully charged. Doing so may avoid harm to the battery pack.
- Operate the computer with the battery pack installed even when using external power. This ensures that the battery is fully charged.
- If you will not be using the computer for a long period of time (more than two weeks), remove the battery pack from the computer.
- If you remove the battery pack, make sure that the battery terminals do not contact any conductors such as metal objects or water. Otherwise, the battery may become unusable as a result of a short circuit.
- If you need to store the battery pack, store it in a cool, dry place. Never allow the temperature to exceed 60 °C (140 °F).
- Do not leave the battery pack in storage for more than 6 months without recharging it.

When Traveling

- Before traveling with your computer, make a backup of your hard disk data into flash disks or other storage devices. As an added precaution, bring along an extra copy of your important data.
- Make sure that the battery pack is fully charged.
- Make sure that the computer is turned off and the top cover is securely closed.
- Do not leave objects in between the keyboard and closed display.
- Disconnect the AC adapter from the computer and take it with you. Use the AC adapter as the power source and as a battery-charger.
- Hand-carry the computer. Do not check it in as luggage.
- If you need to leave the computer in the car, put it in the trunk of the car to avoid exposing the computer to excessive heat.
- When going through airport security, it is recommended that you send the computer and flash disks through the X-ray machine (the device you set your bags on). Avoid the magnetic detector (the device you walk through) or the magnetic wand (the handheld device used by security personnel).
- If you plan to travel abroad with your computer, consult your dealer for the appropriate AC power cord for use in your country of destination.



Troubleshooting

Computer problems can be caused by hardware, software, or both. When you encounter any problem, it might be a typical problem that can easily be solved.

This chapter tells you what actions to take when solving common computer problems. It is divided into three sections:

- Preliminary checklist
- Solving common problems
- Resetting the computer

Preliminary Checklist

Here are helpful hints to follow before you take further actions when you encounter any problem:

- Try to isolate which part of the computer is causing the problem.
- Make sure that you turn on all peripheral devices before turning on the computer.
- If an external device has a problem, make sure that the cable connections are correct and secure.
- Make sure that the configuration information is properly set in the BIOS Setup program.
- Make sure that all the device drivers are correctly installed.
- Make notes of your observations. Are there any messages on the screen? Do any indicators light? Do you hear any beeps? Detailed descriptions are useful to the service personnel when you need to consult one for assistance.

If any problem persists after you follow the instructions in this chapter, contact an authorized dealer for help.

Solving Common Problems

For easy reference, the problems are divided into these categories.

Battery Problems	P. 8-4
DVD Drive Problems	P. 8-4
Display Problems	P. 8-5
Hardware Device Problems	P. 8-6
Hard Disk Drive Problems	P. 8-7
Keyboard, Mouse, and Touchpad Problems	P. 8-7
LAN Problems	P. 8-8
WLAN Problems	P. 8-8
Modem Problems	P. 8-8
Power Management Problems	P. 8-10
Software Problems	P. 8-11
Sound Problems	P. 8-11
Startup Problems	P. 8-12
Other Problems	P. 8-12

Battery Problems

The battery does not charge (Battery Charge indicator does not light red).

- Make sure that the AC adapter is properly connected.
- Make sure that the battery is not too hot or cold. Allow time for the battery pack to return to room temperature.
- Make sure that the battery pack is installed correctly.
- Make sure that the battery terminals are clean.

The operating time of a fully charged battery becomes shorter.

- If you often partially recharge and discharge, the battery might not be charged to its full potential. Initialize the battery to solve the problem. (See “Initializing the Battery Pack” in Chapter 3 for instructions.)

The battery operating time indicated by the battery meter does not match the actual operating time.

- The actual operating time can be different from the estimated time, depending on how you are using the computer. If the actual operating time is much less than the estimated time, initialize the battery. (See “Initializing the Battery Pack” in Chapter 3 for instructions.)

DVD Drive Problems

The DVD drive cannot read a disc.

- Make sure that the disc is correctly seated in the tray, with the label facing up.
- Make sure that the disc is not dirty. Clean the disc with a disc cleaning kit, available in most computer stores.
- Make sure that the DVD drive driver is installed correctly.
- Make sure that the computer supports the disc or the files contained.

You cannot eject a disc.

- The disc is not properly seated in the drive. Manually release the disc following the method described next:
 1. Disconnect the drive from the computer.
 2. Insert a small rod, such as a straightened paperclip, into the drive's manual eject hole and push firmly to release the tray.
 3. Pull the tray out until fully extended, and then remove the disc.

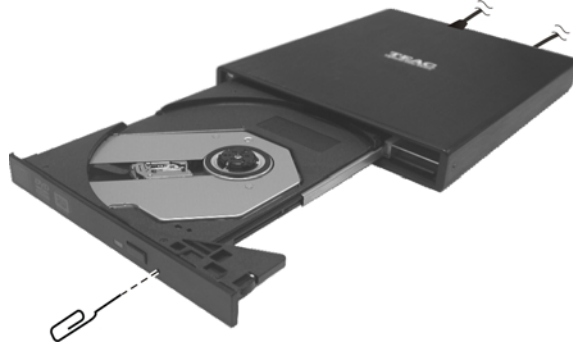

Display Problems

Nothing appears on the screen.

- During operation, the screen may automatically turn off as a result of power management. Press any key to see if the screen comes back.
- The brightness level might be too low. Increase brightness by pressing the Fn+F7 hot key.
- The display output might be set to an external device. To switch the display back to the LCD, press the Fn+F5 hot key or change the display through the Display Settings Properties.

The characters on the screen are dim.

- Adjust the brightness and/or contrast.

Bad dots appear on the display at all times.

- A small number of missing, discolored, or bright dots on the screen are an intrinsic characteristic of TFT LCD technology. It is not regarded as a LCD defect.

The external monitor displays nothing.

- Make sure that the monitor is turned on.
- Make sure that the monitor's signal cable is properly connected.
- Switch the display to the monitor by pressing the Fn+F5 hot key or change the display through the **Display Settings Properties** of Windows Vista (via settings in **Display Properties** of Windows XP).

Simultaneous display/multi-display does not work.

- Make sure that you turn on the external monitor before turning on the computer.
- Press the Fn+F5 hot key to toggle through the display options or change the **Display Settings Properties** of Windows Vista (via settings in **Display Properties** of Windows XP).

Hardware Device Problems

The computer does not recognize a newly installed device.

- The device may not be correctly configured in the BIOS Setup program. Run the BIOS Setup program to identify the new type.
- Make sure if any device driver needs to be installed. (Refer to the documentation that came with the device.)
- Make sure if the device needs any jumper or switch settings. (Refer to the documentation that came with the device.)
- Check the cables or power cords for correct connections.
- For an external device that has its own power switch, make sure that the power is turned on.

Hard Disk Drive Problems

The hard disk drive error message appears on the screen.

- The hard disk drive has defects. Ask your dealer for help.

The hard disk drive operations seem slow.

- The data files stored on the hard disk drive may be fragmented. Use a tool such as Window's **Disk Defragmenter** to defragment the files.

The hard disk drive in-use indicator glows without blinking.

- The data files stored on the hard disk drive may be fragmented. Use a tool such as Window's **Disk Defragmenter** to defragment the files.

Keyboard, Mouse, and Touchpad Problems

The keyboard does not respond.

- Try connecting an external keyboard. If it works, contact an authorized dealer, as the internal keyboard cable might be loose.

The numeric keypad is disabled.

- Make sure that the Num Lock is switched on. (Check if the Num Lock Indicator  glows or not.)

The external keyboard does not work.

- Make sure that the keyboard cable is properly connected.

The USB mouse does not work.

- Make sure that the mouse cable is properly connected.

The touchpad does not work, or the pointer is difficult to control with the touchpad.

- Make sure that the touchpad driver is correctly installed.
- Make sure that the touchpad is clean.

LAN Problems

I cannot access the network.

- Make sure that the LAN driver is correctly installed.
- Make sure that the LAN cable is properly connected to the RJ-45 connector and the network hub.
- Make sure that the network configuration is appropriate.
- Make sure that the user name or password is correct.

WLAN Problems

I cannot use the WLAN feature.

- Make sure that the mini PCI-E WLAN card is correctly installed.
- Make sure that the necessary driver(s) is correctly installed.
- Make sure that the WLAN feature is turned on.

Transmission quality is poor.

- Your computer may be in an out-of-range situation. Move your computer closer to the Access Point or another WLAN device it is associated with.
- Check if there is high interference around the environment and solve the problem as described next.

Radio interference exists.

- Move your computer away from the device causing the radio interference such as microwave oven and large metal objects.
- Plug your computer into an outlet on a different branch circuit from that used by the affecting device.
- Consult your dealer or an experienced radio technician for help.

I cannot connect to another WLAN device.

- Make sure that the WLAN feature is turned on.

- Make sure that the SSID setting is the same for every WLAN device in the network.
- Your computer is not recognizing changes. Restart the computer.
- Make sure that the IP address or subnet mask setting is correct.

I cannot communicate with the computer in the network when Infrastructure mode is configured.

- Make sure that the Access Point your computer is associated with is powered on and all the LEDs are working properly.
- If the operating radio channel is in poor quality, change the Access Point and all the wireless station(s) within the BSSID to another radio channel.
- Your computer may be in an out-of-range situation. Move your computer closer to the Access Point it is associated with.
- Make sure that your computer is configured with the same security option (encryption) to the Access Point.
- Use the Web Manager/Telnet of the Access Point to check whether it is connected to the network.
- Reconfigure and reset the Access Point.

I cannot access the network.

- Make sure that the necessary driver(s) is correctly installed.
- Make sure that the network configuration is appropriate.
- Make sure that the user name or password is correct.
- You have moved out of range of the network.
- Turn off power management.

Modem Problems

The modem does not work.

- Make sure that the modem driver is correctly installed.

- Make sure that the telephone line is properly connected.
- Make sure that the COM port in the communication software is correctly set.
- Turn off power management.

Power Management Problems

The computer does not enter Sleep/Standby or Hibernation mode automatically.

- If you have a connection to another computer, the computer does not enter Sleep/Standby or Hibernation mode if the connection is actively in use.
- Make sure that the Sleep/Standby or Hibernation time-out is enabled.

The computer does not enter Sleep/Standby or Hibernation mode immediately.

- If the computer is performing an operation, it normally waits for the operation to finish.

The computer does not resume from Sleep/Standby or Hibernation mode.

- The computer automatically enters Sleep/Standby or Hibernation mode when the battery pack is empty. Do any one of the following:
 - Connect the AC adapter to the computer.
 - Replace the empty battery pack with a fully charged one.

The computer does not enter Hibernation mode with the Fn+F12 hot keys.

- Make sure that the Hibernation function is specified for the sleep button.
- You might be using a PC card that prevents the computer from entering Hibernation mode. To enter the mode, stop the communication program and then remove the card or stop the card.

Software Problems

An application program does not work correctly.

- Make sure that the software is correctly installed.
- If an error message appears on the screen, consult the software program's documentation for further information.
- If you are sure the operation has stop, reset the computer. (See "Resetting the Computer" later in this chapter.)

Sound Problems

No sound is produced.

- Make sure that the volume control is not set too low.
- Make sure that the audio driver is correctly installed.
- Make sure that the computer is not in Sleep/Standby mode.
- If using an external speaker, make sure that the speaker is properly connected.

Distorted sound is produced.

- Make sure that the volume control is not set too high or too low. In most cases, a high setting can cause the audio electronics to distort the sound.

The sound system does not record.

- Adjust the playback or recording sound levels.

The external microphone or audio device does not work.

- Make sure that the microphone is connected to the proper connector on the computer.
- Make sure that your computer is equipped with the driver needed.
- Click the speaker symbol on the taskbar and check the Windows volume control.

- Check the volume control of your computer.

Startup Problems

When you turn on the computer, it does not respond and the Power Indicator does not light blue.

- If you are using an external AC power, make sure that the AC adapter is correctly and securely connected. If so, make sure that the electrical outlet works properly.
- If you are using the battery power, make sure that the battery is not discharged.

When you turn on the computer, it stops after POST.

- Restart your computer.

The message “Operating system not found” appears on the screen after you turn on the computer.

- If this message appears when you are booting from the hard disk, insert a bootable disc in the DVD drive and check the condition of the hard disk.

The message “Invalid system disk” or “Disk error” appears on the screen after you turn on the computer.

- If you are deliberately trying to boot from a disc, replace the disc with a bootable one and press any key to continue booting.
- If this message appears when you are booting from the hard disk, insert a bootable disc in the DVD drive and check the condition of the hard disk.

Other Problems

The date/time is incorrect.

- Correct the date and time via the operating system or BIOS Setup program.

- After you have performed everything as described above and still have the incorrect date and time every time you turn on the computer, the RTC (Real-Time Clock) battery is at the end of its life. Call an authorized dealer to replace the RTC battery.

Resetting the Computer

You may have to reset (reboot) your computer on some occasions when an error occurs and the program you are using hangs up.

If the computer operation seems to hang up, first wait. It is possible that the computer is processing data. Periodically check the hard disk drive in-use indicator, if it flashes irregularly, the program may be accessing data and preventing you from using the keyboard. If you are sure the operation has stopped and you cannot use the “restart” function of the operating system, reset the computer.

Reset the computer by any one of these methods:

- Press Ctrl+Alt+Del.
- If the above action does not work, turn off the computer. Wait for at least five seconds and turn it on again.

| CAUTION: Resetting will cause any unsaved data to be lost.

Specifications

NOTE: Specifications are subject to change without any prior notice.

CPU		Intel® McCaslin Stealy processor 800 MHz 400 MHz FSB (Front Side Bus), Thermal specifications 3 W
L2 Cache		512 KB
ROM BIOS		1 MB EEPROM, ACPI, Fingerprint and TPM security
RAM	System	Up to 1 GB, DDRII 533/667 MHz SO-DIMM
Display	Panel	12.1-inch TFT, resolution up to 1280×800 WXGA
	Video controller	UMA
	Video ports	VGA port
Audio	Subsystem	Azalia interface, internal microphone
	Ports	Two audio ports for Line-out / Mic-in
	Speakers	1 × 1 Watt
Keyboard		Standard keys, numeric keypad, 12 function keys, a special Fn (Function) key and Windows keys
Quick keys		ECO (power saving) and P1 user-defined hot keys
Pointing device		PS/2-compatible glide touchpad with scroll bar and 2 buttons, water resistant
Storage device	Hard disk drive	1.8-inch diameter, PATA interface, 4200 rpm support, rubber protection at 4 corners, security key reserved, G-Sensor function issues parking or stopping instruction while HDD free-falls over 30 cm
	Optical drive	External connection via mini-USB port
Card slots		PCMCIA, Smart Card, Card Reader (SD / MS / MS Pro / MMC) support
I/O ports		Three USB ports (USB 2.0 support), RJ-11 port, RJ-45 port
Modem		56 Kbps V.9.2 MDC 1.5 internal fax modem, Azalia interface
LAN		10/100/1000 based-T

Wireless LAN		One mini PCI-E slot for wireless LAN card, compliant with IEEE 802.11a/b/g/n
Bluetooth		Specification 2.0 module
3G (optional)		Externally accessible SIM card slot
Security		Fingerprint sensor slide-type, TPM 1.2
Power	AC adapter	Universal AC adapter 45 Watt; input: 100~240 Volt, output: 15 Volt
	Battery	3/6-cell Li-ion battery 2600/5200 mAh
Dimension (W×D×H)		296×209×12.5~30.8 mm (11.7×8.2×0.5~1.2 inch)
Weight		1.15 kg (2.5 lb)
Environment	Temperature	Operating: 0 °C (32 °F) to 35 °C (95 °F) Storage: -20 °C (-4 °F) to 60 °C (140 °F)
	Humidity	Operating: 10 % to 90 % non-condensing Storage: 5 % to 95 % non-condensing
Regulation	EMC	CE, VCCI, FCC
	Safety	CB
Green Product Coverage		RoHS-compliant



Regulatory Information

This appendix provides regulatory statements and safety notices on your computer.

NOTE: Marking labels located on the exterior of your computer indicate the regulations that your model complies with. Please check the marking labels and refer to the corresponding statements in this appendix. Some notices apply to specific models only.

On the Use of the System

Class B Regulations

USA

Federal Communications Commission Radio Frequency Interference Statement

NOTE:

This equipment has been tested and found to comply with the limits for a Class B digital device pursuant to Part 15 of the FCC Rules. These limits are designed to provide reasonable protection against harmful interference in a residential installation. This equipment generates, uses, and can radiate radio frequency energy and, if not installed and used in accordance with the instructions, may cause harmful interference to radio communications. However, there is no guarantee that interference will not occur in a particular installation. If this equipment does cause harmful interference to radio or television reception, which can be determined by turning the equipment off and on, the user is encouraged to try to correct the interference by one or more of the following measures:

- Reorient or relocate the receiving antenna.
- Increase the separation between the equipment and receiver.
- Connect the equipment into an outlet on a circuit different from that to which the receiver is connected.
- Consult the dealer or an experienced radio/TV technician for help.

Any changes or modifications not expressly approved by the manufacturer could void the user's authority to operate the equipment.

Please note:

The use of a non-shielded interface cable with this equipment is prohibited.

Canada

Canadian Department of Communications Radio Interference Regulations Class B Compliance Notice

This Class B digital apparatus meets all requirements of the Canada Interference-Causing equipment regulations.

Cet appareil numérique de Classe B respecte toutes les exigences du Règlement Canadien sur le matériel brouilleur.

This digital apparatus does not exceed the Class B limits for radio noise emissions from digital apparatus set out in the Radio Interference Regulations of the Canadian Department of Communications.

Le présent appareil numérique n'émet pas de bruits radioélectriques dépassant les limites applicables aux appareils numériques de la classe B prescrites dans le Règlement sur le brouillage radioélectrique édicté par le ministère des Communications du Canada.

Safety Notices

About the Battery

Caution Texts Concerning Lithium Batteries

DANISH

ADVARSEL! Lithiumbatteri – Eksplosionsfare ved fejlagtig håndtering. Udskiftning må kun ske med batteri af samme fabrikat og type. Levér det brugte batteri tilbage til leverandøren.

NORWEGIAN

ADVARSEL: Eksplosjonsfare ved feilaktig skifte av batteri. Benytt samme batteritype eller en tilsvarende type anbefalt av apparatfabrikanten. Brukte batterier kasseres i henhold til fabrikantens instruksjoner.

SWEDISH

WARNING: Explosionsfara vid felaktigt batteribyte. Använd samma batterityp eller en ekvivalent typ som rekommenderas av apparattillverkaren. Kassera använt batteri enligt fabrikantens instruktion.

FINNISH

VAROITUS: Paristo voi räjähtää, jos se on virheellisesti asennettu. Vaihda paristo ainoastaan valmistajan suosittelemaan tyyppiin. Hävitä käytetty paristo valmistajan ohjeiden mukaisesti.

ENGLISH

CAUTION: Danger of explosion if battery is incorrectly replaced. Replace only with the same or equivalent type recommended by the equipment manufacturer. Discard used batteries according to manufacturer's instructions.

DEUTSCH

VORSICHT: Explosionsgefahr bei unsachgemäßem Austausch der Batterie. Ersatz nur durch denselben oder einen vom Hersteller empfohlenen gleich-wertigen Typ. Entsorgung gebrauchter Batterien nach Angaben des Herstellers.

FRENCH

ATTENTION: Il y a danger d'explosion s'il y a remplacement incorrect de la batterie. Remplacer uniquement avec une batterie du même type ou d'un type équivalent recommandé par le constructeur. Mettre au rebut les batteries usagées conformément aux instructions du fabricant.

Attention (for USA Users)

The product that you have purchased contains a rechargeable battery. The battery is recyclable. At the end of its useful life, under various state and local laws, it may be illegal to dispose of this battery into the municipal waste stream. Check with your local solid waste officials for details in your area for recycling options or proper disposal.

About the AC Adapter

- Use only the AC adapter supplied with your computer. Use of another type of AC adapter will result in malfunction and/or danger.
- Do not use the adapter in a high moisture environment. Never touch the adapter when your hands or feet are wet.
- Allow adequate ventilation around the adapter when using it to operate the device or charge the battery. Do not cover the AC adapter with paper or other objects that will reduce cooling. Do not use the AC adapter while it is inside a carrying case.
- Connect the adapter to a proper power source. The voltage requirements are found on the product case and/or packaging.
- Do not use the adapter if the cord becomes damaged.
- Do not attempt to service the unit. There are no serviceable parts inside. Replace the unit if it is damaged or exposed to excess moisture.

About the Modem

Caution

- Never install telephone wiring during a lightning storm.
- Never install telephone jacks in wet locations unless the jack is specifically designed for wet locations.
- Never touch non-insulated telephone wires or terminals unless the telephone line has been disconnected at the network interface.
- Use caution when installing or modifying telephone lines.
- Avoid using the telephone function (other than a cordless type) during an electrical storm. There may be a remote risk of electric shock from lightning.
- Do not use the telephone function to report a gas leak in the vicinity of the leak.
- Do not use this product near water, for example near a bathtub, wash bowl, kitchen sink or laundry tub, in a wet basement or near a swimming pool.

Caution (for USA Users)

To reduce the risk of fire, use only No.26 AWG or larger telecommunication line cord.

On the Use of the RF Device

The WLAN Card installed in this device and marketed in the USA and Canada does not support nor function in the extended channels (12ch, 13ch).

HSDPA employed in this device is 3GPP Release 5.

USA and Canada Safety Requirements and Notices

RF Exposure Warning:

This equipment complies with FCC radiation exposure limits set forth for an uncontrolled environment.

End users must follow the specific operation instruction for satisfying RF exposure compliance.

This transmitter must not be co-located or operating in conjunction with any other antenna or transmitter except those that are described within this filing.

The measured SAR levels evaluated are in compliance with the FCC RF exposure guidelines.

The maximum reported Body Maximum SAR Measurement (1g) value is: 0.096 W/Kg.

Radio Frequency Interference Requirements and SAR

The FCC with its action in ET Docket 93-62 has adopted a safety standard for human exposure to Radio Frequency (RF) electromagnetic energy emitted by FCC certified equipment. The wireless LAN module meets the Human Exposure limits found in OET Bulletin 65, 2001, and ANSI/IEEE C95.1, 1992. Proper operation of this radio according to the instructions found in this manual will result in exposure substantially below the FCC's recommended limits. The following safety precautions should be observed:

- Do not touch or move antenna while the unit is transmitting or receiving.
- Do not hold any component containing the radio such that the antenna is very close or touching any exposed parts of the body, especially the face or eyes, while transmitting.

- Do not operate the radio or attempt to transmit data unless the antenna is connected; if not, the radio may be damaged.

Use in specific environments:

- The use of wireless devices in hazardous locations is limited by the constraints posed by the safety directors of such environments.
- The use of wireless devices on airplanes is governed by the Federal Aviation Administration (FAA).
- The use of wireless devices in hospitals is restricted to the limits set forth by each hospital.

Antenna use:

- High-gain, wall-mount, or mast-mount antennas are designed to be professionally installed and should be located at a minimum distance of 30 cm (12 inches) or more from the body of all persons. Please contact your professional installer, VAR, or antenna manufacturer for proper installation requirements.

Explosive Device Proximity Warning

WARNING: Do not operate a portable transmitter near unshielded blasting caps or in an explosive environment unless the device has been modified to be qualified for such use.

Use on Aircraft Caution

CAUTION: Regulations of the FCC and FAA prohibit airborne operation of radio-frequency wireless devices because their signals could interfere with critical aircraft instruments.

EMC Requirements

This device uses, generates and radiates radio frequency energy. The radio frequency energy produced by this device is well below the maximum exposure allowed by the Federal Communications Commission (FCC).

This device complies with the limits for a Class B digital device pursuant to Part 15 subpart C of the FCC Rules and Regulations. Operation is subject to the following two conditions:

- (1) This device may not cause harmful interference.
- (2) This device must accept any interference received, including interference that may cause undesired operation.

The FCC limits are designed to provide reasonable protection against harmful interference when the equipment is installed and used in accordance with the instruction manual and operated in a commercial environment. However, there is no guarantee that interference will not occur in a particular commercial installation, or if operated in a residential area.

If harmful interference with radio or television reception occurs when the device is turned on, the user must correct the situation at the user's own expense. The user is encouraged to try one or more of the following corrective measures:

- Reorient or relocate the receiving antenna.
- Increase the separation between the equipment and receiver.
- Connect the equipment into an outlet on a circuit different from that to which the receiver is connected.
- Consult the dealer or an experienced radio/TV technician for help.

CAUTION: The Part 15 radio device operates on a non-interference basis with other devices operating at this frequency. Any changes or modification to said product not expressly approved by the manufacturer could void the user's authority to operate this device.

Canada Radio Frequency Interference Requirements

To prevent radio interference to the licensed service, this device is intended to be operated indoors and away from windows to provide maximum shielding. Equipment (or its transmit antenna) that is installed outdoors is subject to licensing.

Pour empêcher que cet appareil cause du brouillage au service faisant l'objet d'une licence, il doit être utilisé à l'intérieur et devrait être placé loin des fenêtres afin de fournir un écran de blindage maximal. Si le matériel (ou son antenne d'émission) est installé à l'extérieur, il doit faire l'objet d'une licence.

European Union CE Marking and Compliance Notices

Statements of Compliance

English

This product follows the provisions of the European Directive 1999/5/EC.

Danish

Dette produkt er i overensstemmelse med det europæiske direktiv 1999/5/EC.

Dutch

Dit product is in navolging van de bepalingen van Europees Directief 1999/5/EC.

Finnish

Tämä tuote noudattaa EU-direktiivin 1999/5/EC määräyksiä.

French

Ce produit est conforme aux exigences de la Directive Européenne 1999/5/EC.

German

Dieses Produkt entspricht den Bestimmungen der Europäischen Richtlinie 1999/5/EC.

Greek

Το προϊόν αυτό πληροί τις προβλέψεις της Ευρωπαϊκής Οδηγίας 1999/5/EC.

Icelandic

Þessi vara stendst reglugerð Evrópska Efnahags Bandalagsins númer 1999/5/EC.

Italian

Questo prodotto è conforme alla Direttiva Europea 1999/5/EC.

Norwegian

Dette produktet er i henhold til bestemmelsene i det europeiske direktivet 1999/5/EC.

Portuguese

Este produto cumpre com as normas da Diretiva Européia 1999/5/EC.

Spanish

Este producto cumple con las normas del Directivo Europeo 1999/5/EC.

Swedish

Denna produkt har tillverkats i enlighet med EG-direktiv 1999/5/EC.

Local Restrictions of 802.11a/b/g/n Radio Usage

802.11a wireless LAN devices: For operation within 5.15 ~ 5.25 GHz frequency range, it is restricted to indoor usage environments, and the antenna of this device must be integral.

CAUTION: Due to the fact that the frequencies used by 802.11a/b/g/n wireless LAN devices may not yet be harmonized in all countries, 802.11a/b/g/n products are designed for use only in specific countries or regions, and is not allowed to be operated in countries or regions other than those of designated use. As a user of these products, you are responsible for ensuring that the products are used only in the countries or regions for which they were intended and for verifying that they are configured with the correct selection of frequency and channel for the country or region of use. Any deviation from permissible settings and restrictions in the country or region of use could be an infringement of local law and may be punished as such.

The European variant is intended for use throughout the European Economic Area. However, authorization for use is further restricted in particular countries or regions within countries, as follows:

General

European standards dictate maximum radiated transmit power of 100 mW Effective Isotropic Radiated Power (EIRP) and the frequency range 2400 – 2483.5 MHz.

Belgium and the Netherlands

In Belgium and the Netherlands, the product may not be used outdoors. See the instructions next under the heading “Turning Off the Wireless LAN Radio.”

France

Departments in Which the Wireless LAN Module Can Be Used (Indoors Only)

The wireless LAN module can currently be used indoors only in the following 38 departments of mainland France. Please turn off your wireless LAN radio when operating the device in areas/places other than the 38 departments listed:

01	Ain Orientales	36	Indre	66	Pyrénées
02	Aisne	37	Indre et Loire	67	Bas Rhin
03	Allier	41	Loir et Cher	68	Haut Rhin
05	Hautes Alpes	42	Loire	70	Haute Saône
08	Ardennes	45	Loiret	71	Saône et Loire
09	Ariège	50	Manche	75	Paris
11	Aude	55	Meuse	82	Tarn et Garonne
12	Aveyron	58	Nièvre	84	Vaucluse
16	Charente	59	Nord	88	Vosges
24	Dordogne	60	Oise	89	Yonne
25	Doubs	61	Orne	90	Territoire de Belfort
26	Drôme	63	Puy du Dôme	94	Val de Marne
32	Gers	64	Pyrénées Atlantique		

Departments in Which the Wireless LAN Module's Maximum EIRP Not Shown in the Previous Table

Frequency Ranges (MHz)	Indoors	Outdoors
2400 – 2446.5	10 mW	Not permitted
2446.5 – 2483.5	100 mW	100 mW on private property with Ministry of Defense approval

Turning Off the Wireless LAN Radio

NOTE: Turning the wireless LAN radio off is not the same as disabling the wireless LAN card. It is not necessary to disable the card to meet the regulatory requirements.

While operating the computer in those French departments that do not allow use of the wireless LAN equipment, the user of the equipment must turn off the wireless LAN radio in order to comply with local regulations (see Chapter 2 for more information).

电子信息产品有毒有害物质或元素名称及含量标示

1	金属机构件	X	O	O	O	O	O
2	塑料机构件	O	O	O	O	O	O
3	电路板组件	X	X	O	O	O	O
4	液晶面板	X	X	X	O	O	O
5	硬盘	X	O	O	O	O	O
6	光驱	X	O	O	O	O	O
7	键盘	X	O	O	O	O	O
8	充电电池组件	X	X	O	O	O	O
9	适配器	X	X	X	O	O	O
10	电源线	X	O	O	O	O	O
11	外部信号连接线	O	O	O	O	O	O
12	钮扣电池	O	O	X	O	O	O
13	风扇	X	O	O	O	O	O
14	散热模块 (金属部分)	X	O	O	O	O	O
15	喇叭	X	O	O	O	O	O

O：表示该有害物质在该部件所有均质材料中的含量均在 SJ/T 11363-2006 规定的限量要求以下。

X：表示该有害物质至少在该部件的某一均质材料中的含量超出 SJ/T 11363-2006 规定的限量要求。
(本产品使用技术无法突破之 EU RoHS 除外项目，并于下方使用项目说明)。

使用除外项目如下：

1. 铅使用于部件、装置的内部连接用高融点锡焊上（铅为 85wt% 以上的有铅锡焊）。
2. 电子陶瓷部件（压电组件·陶瓷介质材料等）内的含铅量。
3. 电子部件的玻璃内的含铅量。
4. 两种以上元素组成之焊料，用于连接微处理器封装与针头且铅含量超过 80wt% 并少于 85wt%。
5. 铅于覆晶集成电路封装内用于铸模与基板之电子接点之焊锡。
6. 于钢材、铝材、铜材中的含铅量。
7. 通孔盘状及平面数组陶瓷多层电容器焊料所含的铅。
8. 电子接点的电镀，其要求高可靠性，且没有替代性材料之镉。
9. 电池内的含铅量。
10. 电池内的含镉量。
11. 使用于钮扣电池之含汞量。

Index

—A—

- AC adapter, 3-2, A-2
 - Connecting, 1-2
- AC power
 - Connecting, 1-2
 - Indicator, 1-13
- ACPI, 3-7
- Adobe Acrobat Reader, 6-4
- Antenna warning, B-7
- Audio connector, 2-14
- Audio driver, 6-3
- Audio output connector, 1-9, 2-16
- Audio subsystem
 - Connecting external audio device, 2-15
 - Driver installation, 6-3
 - Feature, 2-14
 - Specifications, A-1
 - Troubleshooting, 8-11

—B—

- Battery charge
 - Indicator, 1-13, 3-3
- Battery low, 3-6
- Battery pack, 1-11, A-2
 - Battery low, 3-6
 - Charging, 3-3
 - Checking battery level, 3-4
 - Initializing, 3-4
 - Replacing, 3-5
 - Safety notices, B-3

- Taking care, 3-3, 7-6
- Troubleshooting, 8-4
- Battery power
 - Indicator, 1-13
- BIOS Setup, 5-1
 - Exiting, 5-10
 - Legacy USB, 5-6
 - Password, 5-8
 - Starting, 5-2
- Bluetooth wireless feature
 - Connecting to Bluetooth device, 2-23
 - Driver installation, 6-4
 - Sending file, 2-26
 - Using, 2-23
- Boot sequence, 5-9
- Booting, 2-2
- Brightness, 2-6

—C—

- Canada
 - Class B compliance notice, B-3
 - RF interference requirements, B-9
- Caps Lock
 - Indicator, 1-13
- Card Reader, 1-9, 4-7
 - Driver installation, 6-4
 - Inserting a card, 4-8
 - Removing a card, 4-8
- CD. *See* DVD drive
- Charging, 3-3
- Chipset driver, 6-3
- Class 1 laser product, 2-11
- Cleaning the computer, 7-6

- Click, 2-9
- Combo drive. *See* DVD drive
- Connecting external device
 - Monitor, 4-2
 - USB device, 4-4
- Connector
 - Audio output, 1-9, 2-16
 - Microphone, 1-9, 2-16
 - RJ-11, 1-7
 - RJ-45, 1-7
- Copyright protection
 - Macrovision Corp., 2-11
- Cover
 - Opening, 1-4
- CPU, A-1
 - Compartment, 1-10
- Cursor control keys, 2-5

—D—

- Date, 5-5, 8-13
- DC, 3-2
- Dimension of the computer, A-2
- Display
 - Troubleshooting, 8-5
- Display mode, 2-13
- Display output, 2-6
- Double-click, 2-9
- Drag and drop, 2-9
- Drive D, 2-11
- Drive E, 4-8
- Driver installation, 6-1
- Driver OS support, 6-2
- DVD drive, 1-6, 2-11
 - Inserting a disc, 2-12
 - Troubleshooting, 8-4
- DVD Dual drive. *See* DVD drive

—E—

- EEPROM, A-1
- EMC requirements, B-8
- Environmental specifications, A-2

- European Union
 - CE marking and compliance notices, B-9
- Euro symbol, 2-7
- External monitor
 - Connecting, 4-2

—F—

- FCC
 - Class B regulations, B-2
- FDA regulations, 2-11
- Fn key, 2-5
- Function keys, 2-5

—H—

- Hard disk drive
 - Troubleshooting, 8-7
- Hibernation, 2-3, 3-7, 3-8
 - Troubleshooting, 8-10
- Hot keys
 - Brightness, 2-6
 - Display output, 2-6
 - LCD, 2-7
 - Mute, 2-7
 - Power saving, 2-7
 - Volume, 2-6
 - WLAN radio, 2-6
- Humidity, A-2

—|—

- Indicator
 - Battery charge, 3-3
 - Caps Lock, 1-13
 - DVD drive, 1-13
 - Hard disk drive, 1-13
 - Num Lock, 1-13
 - Power, 1-13
 - WLAN, 1-13

—K—

Kensington lock, 1-8, 7-4
Keyboard, 1-12, 2-5
 Troubleshooting, 8-7

—L—

LAN, 2-19
 Connector, 1-7
 Driver installation, 6-4
 Troubleshooting, 8-8
LCD, 1-12, 2-13, A-1
 Switching on and off with hot key, 2-7
Location of the computer, 7-5
Low battery. *See* Battery low

—M—

Memory card. *See* Storage card
Memory module, 1-10
Memory Stick. *See* Storage card
Memory Stick PRO. *See* Storage card
Microphone, 1-12, 2-14
Microphone connector, 1-9, 2-16
Modem, 2-18
 Driver installation, 6-3
 Troubleshooting, 8-10
Mouse
 Troubleshooting, 8-7
MultiMediaCard. *See* Storage card
Mute, 2-7

—N—

Network. *See* LAN
Num lock, 2-6
 Indicator, 1-13
Numeric keys, 2-6

—O—

Operating system, 1-5, 2-2

—P—

Password, 5-8
PC card, 4-5
 Inserting, 4-6
 Removing, 4-6
 Slot, 1-7
 Troubleshooting, 8-6
Point, 2-9
POST, 1-5
Power, A-2
Power button, 1-13, 2-2
Power connector, 1-8
Power Management, 3-7
 Troubleshooting, 8-10
Power saving
 Enable/disable, 2-4
Power saving button, 1-13, 2-4
Power-On Self Test. *See* POST

—R—

RAM, A-1
Rebooting, 8-14
Resetting, 8-14
Restarting, 8-14
RF device
 Safety Requirements and Notices, B-6
RJ-11, 1-7, 2-18
RJ-45, 1-7, 2-19
ROM BIOS, A-1

—S—

Saving power, 3-9
Screen. *See* LCD
Scroll, 2-9
Secure Digital. *See* Storage card

- Security
 - Protecting the computer with lock, 7-4
 - Protecting the computer with password, 7-3
- Shutting down, 1-5, 2-2
- Simultaneous display, 2-13
- Sleep, 2-2, 3-7
 - Troubleshooting, 8-10
- Sleep button, 2-7
- Software
 - Troubleshooting, 8-11
- Software driver, 6-1
- Speaker, 1-12, 2-14
 - Connecting external speakers, 2-16
- Specifications, A-1
- Startup, 2-2
 - Troubleshooting, 8-12
- Storage card, 4-7
 - Inserting, 4-8
 - Removing, 4-8
- Super Multi drive. *See* DVD drive

—T—

- Telephone line
 - Connecting, 2-18
 - Connector, 1-7
- Temperature, A-2
- TFT, 2-13
- Time, 5-5, 8-13
- Touchpad, 1-12, 2-8
 - Configuring, 2-10
 - Driver installation, 6-4
 - Troubleshooting, 8-7
- Traveling with the computer, 7-7
- Troubleshooting, 8-1
 - Battery problem, 8-4
 - Display problem, 8-5
 - DVD drive problem, 8-4
 - Hard disk drive problem, 8-7
 - Hardware problem, 8-7
 - Keyboard problem, 8-7
 - LAN problem, 8-8
 - Modem problem, 8-10
 - Mouse problem, 8-7
 - Other problem, 8-13

- Power Management problem, 8-10
- Software problem, 8-11
- Sound problem, 8-11
- Startup problem, 8-12
- Touchpad problem, 8-7
 - WLAN problem, 8-8
- Turning off, 1-5, 2-2
- Turning on, 1-4
- Typewriter keys. *See* Keyboard

—U—

- Upgrading the computer, 4-9
- USB device
 - Connecting, 4-4
- USB port, 1-6, 1-8, 4-4

—V—

- Video driver, 6-3
- Video subsystem
 - Configuring, 2-13
 - Driver installation, 6-3
 - Feature, 2-13
 - Video controller, A-1
- Volume, 2-6

—W—

- Weight of the computer, A-2
- Windows, 1-5
- Windows key, 2-7
- Windows Security Center, 7-2
- WLAN
 - Driver installation, 6-4
 - France restrictions, B-11
 - Indicator, 1-13
 - Local restrictions, B-10
 - Troubleshooting, 8-8
 - Turning off, 2-20
 - Turning on, 2-20
 - Using, 2-20
- WLAN card, 1-10

