

Getac

B300

USER MANUAL

Rugged Mobile Computing Solution

May 2018

TRADEMARKS

The Bluetooth® word mark and logos are registered trademarks owned by Bluetooth SIG, Inc.

All brand and product names are trademarks or registered trademarks of their respective companies.

NOTE

The information in this manual is subject to change without notice. For the latest version of the manual, please visit the Getac website at www.getac.com.

Table of Contents

Chapter 1	Getting Started	1
	Getting the Computer Running.....	2
	Unpacking	2
	Using the Tether (Optional).....	3
	Connecting to AC Power.....	4
	Turning On and Off the Computer	5
	Taking a Look at the Computer.....	7
	Front Components.....	7
	Rear Components.....	8
	Right-Side Components	10
	Left-Side Components	11
	Top-open Components.....	12
	Bottom Components	14
Chapter 2	Operating Your Computer	15
	Using the Keyboard	16
	Typewriter Keys	16
	Cursor-Control Keys	16
	Numeric Keypad	17
	Function Keys.....	18
	Fn Key.....	18
	Hot Keys	18
	Windows Keys	19
	Using the Touchpad	21
	Configuring the Touchpad.....	22
	Using the Touchscreen (Optional)	24
	Using the DVD Drive	25
	Inserting and Removing a Disc.....	26
	Using Network and Wireless Connections.....	27
	Using the LAN	27

	Using the WLAN.....	27
	Using the Bluetooth Feature.....	28
	Using the WWAN Feature (Optional).....	29
	Using the Fingerprint Scanner (Optional).....	32
Chapter 3	Managing Power.....	34
	AC Adapter.....	35
	Battery Pack.....	36
	Charging the Battery Pack.....	36
	Initializing the Battery Pack.....	37
	Checking the Battery Level.....	37
	Battery Low Signals and Actions.....	38
	Replacing the Battery Pack.....	38
	Power-Saving Tips.....	40
Chapter 4	Expanding Your Computer.....	41
	Connecting Peripheral Devices.....	42
	Connecting a Display Monitor.....	42
	Connecting a Serial Device.....	43
	Connecting a USB Device.....	43
	Connecting Audio Devices.....	44
	Using Various Card Readers.....	46
	Using Smart Cards.....	46
	Using PC Cards.....	46
	Using ExpressCards.....	48
	Using Storage Cards.....	49
	Changing or Replacing.....	50
	System Memory Upgrade.....	50
	Replacing the Hard Disk Drive.....	52
	Installing a Secondary Battery Pack or Hard Disk Drive.....	52
Chapter 5	Using BIOS Setup.....	54
	When and How to Use.....	55
	Menu Descriptions.....	56
	Information Menu.....	56
	Main Menu.....	56
	Advanced Menu.....	57
	Security Menu.....	59
	Boot Menu.....	60
	Exit Menu.....	60

	Quick BIOS Settings	61
Chapter 6	Using Getac Software	62
	G-Manager	63
Chapter 7	Caring for the Computer	64
	Protecting the Computer	65
	Using an Anti-Virus Strategy	65
	Using the Cable Lock	65
	Taking Care of the Computer	66
	Location Guidelines	66
	General Guidelines	66
	Cleaning Guidelines	67
	Battery Pack Guidelines	67
	Touchscreen Guidelines	69
	When Traveling	70
Chapter 8	Troubleshooting	71
	Preliminary Checklist	72
	Solving Common Problems	73
	Battery Problems	73
	Bluetooth Problems	73
	Display Problems	74
	DVD Drive Problems	74
	Hardware Device Problems	75
	Hard Disk Drive Problems	75
	Keyboard and Touchpad Problems	76
	LAN Problems	76
	Power Management Problems	76
	Software Problems	77
	Sound Problems	77
	Startup Problems	78
	WLAN Problems	78
	Other Problems	80
	Resetting the Computer	81
	System Recovery	82
	Using Windows RE	82
	Using Recovery Partition	83
	Using the Driver Disc (Optional)	85

Appendix A Specifications	86
Appendix B Regulatory Information.....	88
On the Use of the System	89
Class B Regulations	89
ANSI Warning.....	90
Safety Notices	91
On the Use of the RF Device	94
USA and Canada Safety Requirements and Notices	94
European Union CE Marking and Compliance Notices.....	95
User Notification of Take-back Service	98
ENERGY STAR 7.0.....	99
Battery Recycling.....	101

Chapter 1







Getting Started

This chapter first tells you step by step how to get the computer up and running. Then, you will find a section briefly introducing the external components of the computer.

Getting the Computer Running

Unpacking

After unpacking the shipping carton, you should find these standard items:

● B300 notebook computer	
● AC adapter 	● Screen cleaning cloth 
● AC power cord 	● Stylus* 
● Battery pack 	● Tether* 
	● Driver disc*
	● Document(s)

* Optional

Inspect all the items. If any item is damaged or missing, notify your dealer immediately.

Using the Tether (Optional)

A tether is provided for attaching the stylus to your computer.

1. Insert one of the tether's loop ends through the hole of the stylus (as indicated by **1** below). Then, insert the other end through the first loop (as indicated by **2** below) and pull it tight.



2. Insert the other loop end to the hook on the computer (as indicated by **1** below). Then, insert the stylus end through the loop (as indicated by **2** below) and pull it tight.



Connecting to AC Power

CAUTION: Use only the AC adapter included with your computer. Using other AC adapters may damage the computer.

NOTE:

- The battery pack is shipped to you in power saving mode that protects it from charging/discharging. It will get out of the mode to be ready for use when you install the battery pack and connect AC power to the computer for the very first time.
- When the AC adapter is connected, it also charges the battery pack. For information on using battery power, see Chapter 3.

You must use AC power when starting up the computer for the very first time.

1. Plug the DC cord of the AC adapter to the power connector of the computer (❶).
2. Plug the female end of the AC power cord to the AC adapter and the male end to an electrical outlet (❷).



3. Power is being supplied from the electrical outlet to the AC adapter and onto your computer. Now, you are ready to turn on the computer.

Turning On and Off the Computer

Turning On

1. Open the top cover by pushing on the cover latch (❶) and lifting up the cover (❷). You can tilt the cover forward or backward for optimal viewing clarity.







2. Press the power button (⏻). The Windows operating system should start.



Turning Off

When you finish a working session, you can stop the system by turning off the power or leaving it in Sleep or Hibernation mode:

To_	Do this_
Power off (Shutdown)	Click  →  Power → Shut down.
Sleep	Use one of these methods: <ul style="list-style-type: none">● Press the power button.*● Close the top cover.*● Press Fn + F12.*● Click  →  Power → Sleep.
Hibernate	By default, this option is not shown in the Start menu. If you want to use the feature, set up accordingly in Windows settings.

* "Sleep" is the default result of the action. You can change what the action does through Windows settings.

Taking a Look at the Computer

NOTE: Depending on the model you purchased, the appearance of your computer may not be exactly the same as those shown in this manual.

CAUTION: You need to open the protective covers to access the connectors. When not using a connector, make sure to close the cover completely for water-, dust-, and fire-proof integrity. (Engage the locking mechanism if existing.)

Front Components

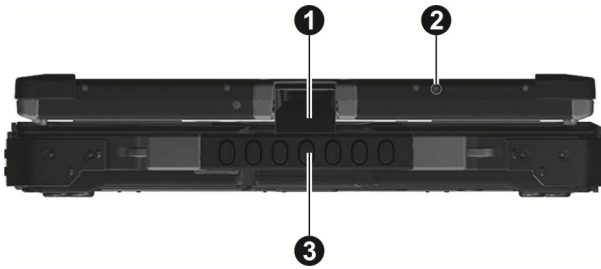

Ref	Component	Description
①	Top Cover Latch	Locks the top cover.
②	WWAN Antenna	Should be pulled out for reception of mobile telecommunications signals.
③	Handle	Provides a convenient way to carry the computer.

Rear Components

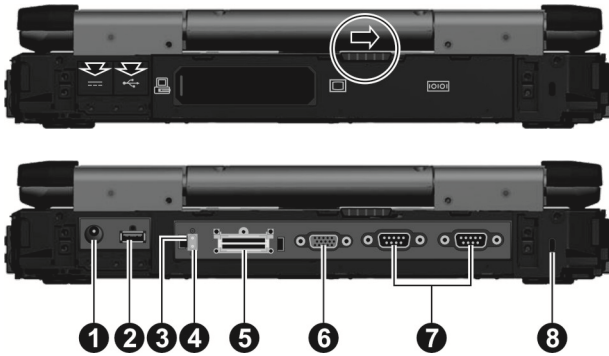

Ref	Component	Description
①	Power Connector	Connects the AC adapter.
②	USB Port	Connects a USB device, such as a USB flash disk, printer, digital camera, joystick, and more.
③	WWAN Pass-through Connector (option)	Connects the external antenna for WWAN connectivity. NOTE: Must be connected via a docking station.
④	GPS Pass-through Connector (option)	Connects the external antenna for GPS signal reception. NOTE: Must be connected via a docking station.
⑤	Docking Connector	Connects to a docking station. Listed below are the model names of docking stations for your computer. – B300 OD – Getac B300 Docking Station – Getac B300 Cradle
⑥	VGA Connector	Connects an external display monitor.
⑦	Serial Connector	Connects a serial mouse or serial communication device.

Ref	Component	Description
③	Kensington Lock	Locks the computer to a stationary object for security.

CAUTION: Closing the cover in an incorrect manner will result in poor sealing. As shown below, when closing the cover, you must firmly press the two sides (1) of the release latch to make sure the latch (2) clicks into the locked position.



Right-Side Components

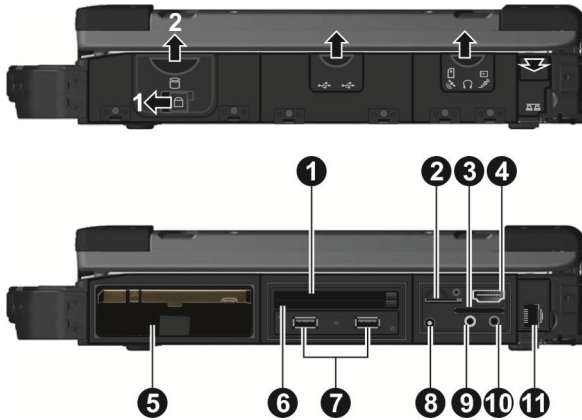

Ref	Component	Description
①	ExpressCard Slot	Accepts an ExpressCard for additional functions.
②	SIM Card Slot (option)	Accepts a SIM card for models having the WWAN module. NOTE: The slot still exists but cannot be used for models without the WWAN module.
③	SD Card Reader	Accepts a Secure Digital (SD) card for removable storage media.
④	HDMI Connector	Connects a HDMI monitor or TV set.
⑤	Hard Disk Drive	Inside is the hard disk drive.
⑥	PC Card Slot	Accepts a PC card for additional functions.
⑦	USB Port	Connects a USB device, such as a USB flash disk, printer, digital camera, joystick, and more.
⑧	GPS Antenna Connector	Connects the external antenna for GPS signal reception.
⑨	Audio Output Connector	Connects a set of headphones or external speakers with amplifier.

Ref	Component	Description
⑩	Microphone Connector	Connects an external microphone.
⑪	RJ-45 Connector	Connects the LAN cable.

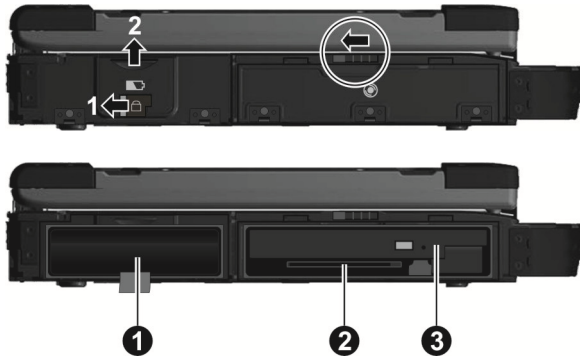

Left-Side Components





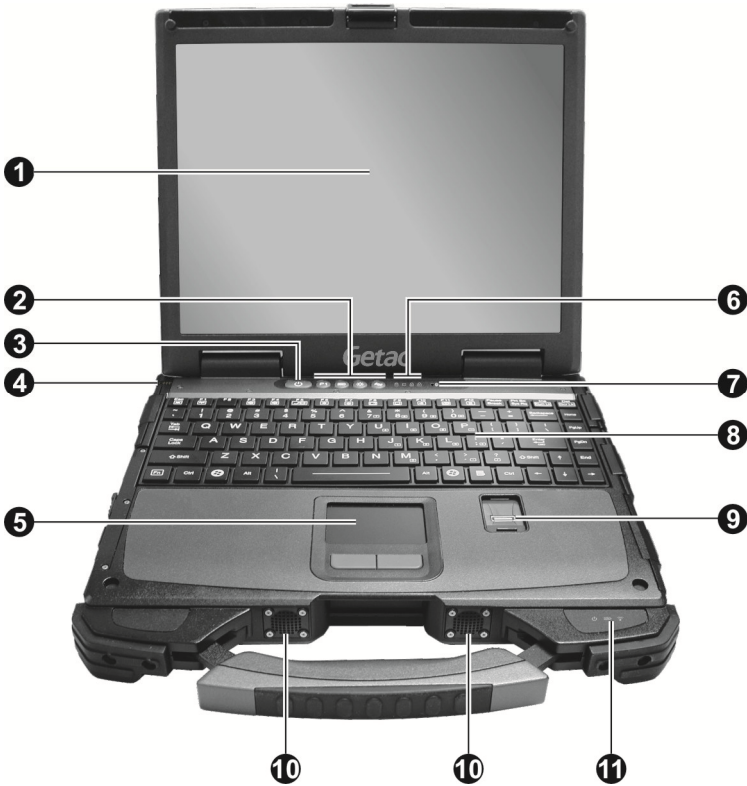







Ref	Component	Description
①	Battery Pack	Supplies power to your computer when external power is not connected.
②	Smart Card Reader	Accepts a smart card for additional security feature. NOTE: On your computer, the Smart Card reader is a part of the super multi drive module. If the super multi drive module is replaced by a secondary battery pack or hard disk drive, you cannot use the Smart Card reader.
③	Super Multi Drive	Accepts a compact disc for installing or loading software, accessing data, and playing music/video. Can be replaced by a secondary hard disk drive or battery pack (purchased separately).

Top-open Components



Ref	Component	Description
①	LCD Screen	Displays the output of the computer. May include the optional touchscreen feature.
②	Quick Buttons	
	P1	Toggles the “Blackout” mode on or off.
		Brings up the ECO menu for selecting a power profile when using battery power.
		Toggles the sunlight-readable mode on or off.

Ref	Component	Description
		Enables or disables light sensor.
③	Power Button 	Turns the power on or off. (The default “off” state is “Sleep mode.”)
④	Stylus (option)	Serves as the input device by tapping on the screen to make selections and enter information.
⑤	Touchpad	Serves as the pointing device of the computer.
⑥	Indicators	Show the current status of the computer’s devices.
	 Hard Disk Drive / DVD Drive	Blinks green when computer is accessing the hard disk or DVD drive.
	 Card Reader	Blinks green when computer is accessing the storage card.
	 Caps Lock	Lights green when Caps Lock is on.
	 Num Lock	Lights green when Num Lock is on. Lights amber when the optional hard disk heater is on.
⑦	Microphone 	Receives sound and voice for the computer.
⑧	Keyboard	Serves as the data input device of the computer.
⑨	Fingerprint Scanner (option)	Serves as the fingerprint verification, preventing unauthorized access to your computer.
⑩	Stereo Speaker	Sends out sound and voice from the computer.
⑪	Indicators	Show the current status of the computer’s devices.
	 Power	Lights green when computer is on. Blinks green when computer is on Sleep mode.
	 Battery Charge	Lights green when the battery is fully charged. Lights amber when the battery is being charged. Blinks red when the battery’s capacity is below 10%. Blinks amber when the battery is in an abnormal condition.

Ref	Component	Description
	 RF (Radio Frequency)	Lights green when the RF radio of any RF feature (WLAN/Bluetooth/WWAN) is on.

NOTE: The hardware buttons (except the power button) can be re-defined using G-Manager.

Bottom Components



Ref	Component	Description
1	Memory Slots	Inside are the memory slots for expanding the memory size of your computer.

Chapter 2

Operating Your Computer

This chapter provides information about the use of the computer.

If you are new to computers, reading this chapter will help you learn the operating basics. If you are already a computer user, you may choose to read only the parts containing information unique to your computer.

CAUTION:

- Do not expose your skin to the computer when operating it in a very hot or cold environment.
- The computer can get uncomfortably warm when you use it in high temperatures. As a safety precaution in such a circumstance, do not place the computer on your lap or touch it with your bare hands for extended periods of time. Prolonged body contact can cause discomfort and potentially a burn.

Using the Keyboard

Your keyboard has all the standard functions of a full-sized computer keyboard plus an **Fn** key added for specific functions.

The standard functions of the keyboard can be further divided into four major categories:

- Typewriter keys
- Cursor-control keys
- Numeric keys
- Function keys

Typewriter Keys

Typewriter keys are similar to the keys on a typewriter. Several keys are added such as the **Ctrl**, **Alt**, **Esc**, and lock keys for special purposes.

The Control (**Ctrl**) / Alternate (**Alt**) key is normally used in combination with other keys for program-specific functions. The Escape (**Esc**) key is usually used for stopping a process. Examples are exiting a program and canceling a command. The function depends on the program you are using.

Cursor-Control Keys

Cursor-control keys are generally used for moving and editing purposes.

NOTE: The word “cursor” refers to the indicator on the screen that lets you know exactly where on your screen anything you type will appear. It can take the form of a vertical or horizontal line, a block, or one of many other shapes.

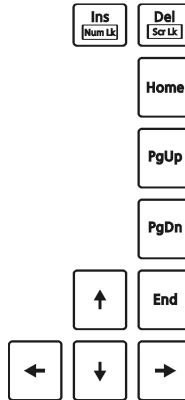

Numeric Keypad

A 15-key numeric keypad is embedded in the typewriter keys as shown next:

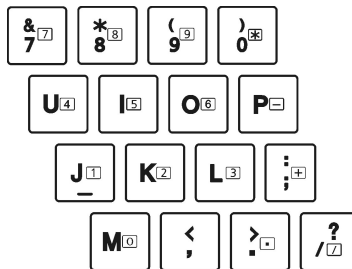

Numeric keys facilitate entering of numbers and calculations. When Num Lock is on, the numeric keys are activated; meaning you can use these keys to enter numerals.

NOTE :

- When the numeric keypad is activated and you need to type the English letter in the keypad area, you can turn Num Lock off or you can press **Fn** and then the letter without turning Num Lock off.
- Some software may not be able to use the numeric keypad on the computer. If so, use the numeric keypad on an external keyboard instead.

Function Keys

On the top row of the keys are the function keys: **F1** to **F12**. Function keys are multi-purpose keys that perform functions defined by individual programs.











Fn Key

















The **Fn** key, at the lower left corner of the keyboard, is used with another key to perform the alternative function of a key. To perform a desired function, first press and hold **Fn**, then press the other key.

Hot Keys



Hot keys refer to a combination of keys that can be pressed any time to activate special functions of the computer. Most hot keys operate in a cyclic way. Each time a hot key combination is pressed, it shifts the corresponding function to the other or next choice.



You can easily identify the hot keys with the icons imprinted on the keytop. The hot keys are described next.

Key	Description
 	Switches the keyboard backlight on and off (option).
 	Switches the RF (radio frequency) radio on and off. When off, all wireless modules (such as WLAN, Bluetooth, and WWAN) cannot be used. When on, individual settings of the module work.
 	Switches the night vision feature on or off. The feature is for viewing the display when using night vision goggles (optional).
 	Decreases the sound volume.
 	Increases the sound volume.

Key	Description
 	<p>Switches the display output to the next choice if an external display (either VGA or HDMI) is connected.</p> <p>The hot keys are equivalent to  Windows logo key + P.</p> <p>Choices are:</p> <pre> graph TD A[LCD only] --> B[LCD + External display Duplicate] B --> C[LCD + External display Extend] C --> D[External display only] </pre>
 	<p>Decreases the LCD brightness.</p> <p>The LCD still has 2 nits brightness when you reach the lowest level.</p>
 	<p>Increases the LCD brightness.</p>
 	<p>Switches the touchscreen on or off (option).</p>
 	<p>Switches the touchpad off or on.</p>
 	<p>Switches the system sound output off (mute) or on.</p>
 	<p>Switches the display on or off.</p>
 	<p>Serves as the sleep button that you can define with Windows' Power Options.</p>

Windows Keys

The keyboard has two keys that perform Windows-specific functions:  Windows Logo key and  Application key.

The  Windows Logo key opens the **Start** menu and performs software-specific functions when used in combination with other keys. The  Application key usually has the same effect as a right mouse click.

Using the Touchpad

CAUTION: Do not use a sharp object such as a pen on the touchpad. Doing so may damage the touchpad surface.

NOTE:

- You can press **Fn+F9** to toggle the touchpad function on or off.
- For optimal performance of the touchpad, keep your fingers and the pads clean and dry. When tapping on the pad, tap lightly. Do not use excessive force.

The touchpad is a pointing device that allows you to communicate with the computer by controlling the location of the pointer on the screen and making selection with the buttons.



The touchpad consists of a rectangular pad (work surface) and a left and right buttons. To use the touchpad, place your forefinger or thumb on the pad. The rectangular pad acts like a miniature duplicate of your display. As you slide your fingertip across the pad, the pointer (also called cursor) on the screen moves accordingly. When your finger reaches the edge of the pad, simply relocate yourself by lifting the finger and placing it on the other side of the pad.

Here are some common terms that you should know when using the touchpad:

Term	Action
Point	Move your finger on the pad until the cursor points to the selection on the screen.
Click	Press and release the left button. –or– Tap gently anywhere on the pad.
Double-click	Press and release the left button twice in quick succession. –or– Tap twice on the pad rapidly.
Drag and drop	Press and hold the left button, then move your finger until you reach your destination (drag). Finally, release the button (drop) when you finish dragging your selection to the destination. The object will drop into the new location. –or– Gently tap twice on the pad and on the second tap, keep your finger in contact with the pad. Then, move your finger across the pad to drag the selected object to your destination. When you lift your finger from the pad, the selected object will drop into place.
Scroll	To scroll is to move up and down or left and right in the working area on the screen. To move vertically, place your finger on the right or left edge of the pad and slide your finger up and down along the edge. To move horizontally, place your finger on the top or bottom edge of the pad and slide your finger left and right. This function may not work for all applications.

TABLE NOTE: If you swap the left and right buttons, “tapping” on the touchpad as an alternative method of pressing the left button will no longer be valid.

Configuring the Touchpad

You may want to configure the touchpad to suit your needs. For example, if you are a left-handed user, you can swap the two buttons so that you can use the right button as the left button and vice versa. You can also change the size of the on-screen pointer, the speed of the pointer, and so on.

To configure the touchpad, go to **Settings → Devices → Mouse & touchpad**.

Using the Touchscreen (Optional)

NOTE: You can press **Fn+F8** to toggle the touchscreen function on or off.

CAUTION: Do not use a sharp object such as a ballpoint pen or pencil on the touchscreen. Doing so may damage the touchscreen surface. Use your finger or the included stylus.

The touchscreen is a touch-sensitive device that allows you to navigate on the screen without using a keyboard, touchpad, or mouse.

Use the included stylus to select objects on the screen. The stylus can be stretched for better grip and handling.

The following table shows how you use the touchscreen to obtain equivalent mouse functions.

Term/Action	Equivalent Mouse Function
Tap: Touch the screen once.	Click/Point
Double-tap: Touch the screen twice rapidly.	Double-click
Tap and hold: Tap and hold until a popup menu appears.	Right-click
Drag: Hold the stylus (or finger) on the screen and drag across the screen until reaching your destination.	Drag

Using the DVD Drive

Your computer may come with a Super Multi drive. The drive can read from and write to CD, DVD+, DVD-, and DVD-RAM media.

CAUTION:

- When inserting a disc, do not use force.
- Make sure that the disc is correctly inserted into the tray, and then close the tray.
- Do not leave the drive tray open. Also, avoid touching the lens in the tray with your hand. If the lens becomes dirty, the drive may malfunction.
- Do not wipe the lens using materials with rough surface (such as paper towel). Instead, use a cotton swab to gently wipe the lens.

FDA regulations require the following statement for all laser-based devices:

“Caution, Use of controls or adjustments or performance of procedures other than those specified herein may result in hazardous radiation exposure.”

NOTE: The DVD drive is classified as a Class 1 laser product. This label is located on the DVD drive.



**CLASS 1 LASER PRODUCT
LASER KLASSE 1**

NOTE: For DVD and Combo drives only.

This product incorporates copyright protection technology that is protected by method claims of certain U.S. patents and other intellectual property rights owned by Macrovision Corporation and other rights owners. Use of this copyright protection technology must be authorized by Macrovision Corporation, and is intended for home and other limited viewing uses only unless otherwise authorized by Macrovision Corporation. Reverse engineering or disassembly is prohibited.

Inserting and Removing a Disc

1. Turn on the computer.
2. Open the multi-purpose bay cover by sliding the release latch towards the left.



3. Press the eject button and the DVD tray will slide out partially. Gently pull on it until it is fully extended.
4. To insert a disc, place down the disc in the tray with its label facing up. Slightly press the center of the disc until it clicks into place.

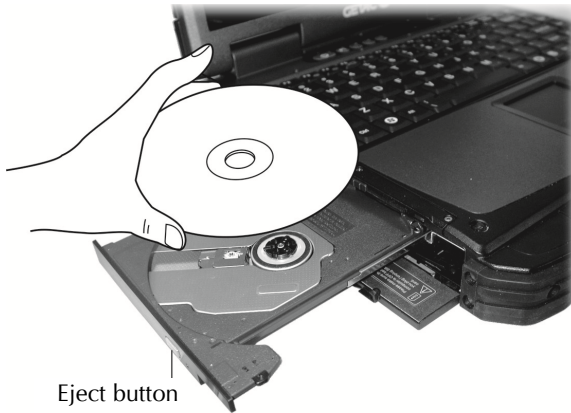

To remove a disc, hold the disc by its outer edge and lift it up from the tray.

5. Gently push the tray back into the drive.
6. Close the multi-purpose bay cover.

NOTE: In the unlikely event that you are unable to release the drive tray by pressing the eject button, you can manually release the disc. (See “Optical Drive Problems” in Chapter 8.)

Using Network and Wireless Connections

Using the LAN

The internal 10/100/1000Base-T LAN (Local Area Network) module allows you to connect your computer to a network. It supports data transfer rate up to 1000 Mbps.



Using the WLAN

The WLAN (Wireless Local Area Network) module supports IEEE 802.11ac, compatible with 802.11a/b/g/n.

Turning On/Off the WLAN Radio

To turn on the WLAN radio:

Click  → **Settings** → **Network & Internet** → **Wi-Fi**. Slide the **Wi-Fi** switch to the **On** position.

To turn off the WLAN radio:

You can turn off the WLAN radio the same way you turn it on.

If you want to quickly turn off all wireless radio, simply switch on Airplane mode. You can control the Airplane mode using one of the below methods.

- Press **Fn+F1**.
- Click  → **Settings** → **Network & Internet** → **Airplane mode**.

Connecting to a Wireless Network

1. Make sure that the WLAN function is enabled (as described above).
2. Click the network icon  in the lower right of the task bar.
3. In the list of available wireless networks, click a network, and then click **Connect**.
4. Some networks require a network security key or passphrase. To connect to one of those networks, ask your network administrator or Internet service provider (ISP) for the security key or passphrase.

For more information on setting a wireless network connection, refer to Windows online help.

Using the Bluetooth Feature

The Bluetooth technology allows short-range wireless communications between devices without requiring a cable connection. Data can be transmitted through walls, pockets and briefcases as long as two devices are within range.

Turning On/Off the Bluetooth Radio

To turn on the Bluetooth radio:

Click  → **Settings** → **Devices** → **Bluetooth**. Slide the **Bluetooth** switch to the **On** position.

To turn off the Bluetooth radio:

You can turn off the Bluetooth radio the same way you turn it on.

If you want to quickly turn off all wireless radio, simply switch on Airplane mode. You can control the Airplane mode using one of the below methods.

- Press **Fn+F1**.
- Click  → **Settings** → **Network & Internet** → **Airplane mode**.

Connecting to another Bluetooth Device

1. Make sure that the Bluetooth function is enabled (as described above).
2. Make sure that the target Bluetooth device is turned on, discoverable and within close range. (See the documentation that came with the Bluetooth device.)
3. Click  → **Settings** → **Devices** → **Bluetooth**.
4. Select the device you want to connect from the search results.
5. Depending on the type of Bluetooth device that you want to connect to, you will need to enter the pertinent information.

For detailed information on using the Bluetooth feature, see Windows' online Help.

Using the WWAN Feature (Optional)

A WWAN (Wireless Wide Area Network) uses mobile telecommunication cellular network technologies to transfer data. The WWAN module of your computer supports 3G and 4G LTE.

NOTE :

- The WWAN feature is available to selected countries only.
- Your model only supports data transmission, voice transmission is not supported.
- When using the WWAN feature, pull out the WWAN antenna.

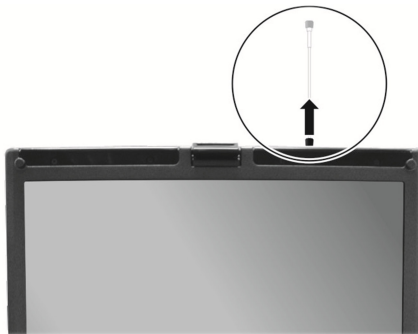

Installing a SIM Card

1. Turn off the computer and disconnect the AC adapter.
2. Locate the SIM card slot on the right side of the computer and open the cover.
3. Unfasten one screw and remove the small plate that covers the SIM card slot.



4. Insert the SIM card into the slot. Make sure the beveled corner on the SIM card is facing towards the slot and that the golden contact area on the card is facing downwards.



5. Close the cover.

NOTE: To remove the SIM card, push inward to release and slide the SIM card out of the slot. You can use the small plate as a tool to push the SIM card.

Turning On/Off the WWAN Radio

To turn on the WWAN radio:

Click  → **Settings** → **Network & Internet** → **Airplane mode**. Slide the **Cellular** switch to the On position.

To turn off the WWAN radio:

You can turn off the WWAN radio the same way you turn it on.

If you want to quickly turn off all wireless radio, simply switch on Airplane mode. You can control the Airplane mode using one of the below methods.

- Press **Fn+F1**.
- Click  → **Settings** → **Network & Internet** → **Airplane mode**.

Setting up a WWAN Connection

Click  → **Settings** → **Network & Internet** → **Cellular**. (For detailed information on cellular settings in Windows 10, see Microsoft Support website.)

Using the Fingerprint Scanner (Optional)

WARNING :

- To protect the fingerprint scanner, be sure to slide close the cover when not using the fingerprint scanner.
- We shall not be liable for any loss or damage whatsoever resulting from your use of the fingerprint scanner or neglect of fingerprint scanner use, or any data loss resulting from such developments as fingerprint authentication malfunctioning.
- It is not recommended that you use the fingerprint scanner in a below-freezing temperature. The moisture on your finger can freeze to the scanner's metal surface when you touch it, resulting in a failed operation. Besides, touching freezing metal with your finger can cause frostbite.

The fingerprint scanner provides a strong authentication mechanism based on fingerprint recognition.

Locate and slide open the fingerprint scanner cover.



NOTE :

- You can enroll a fingerprint only after creating a password for the Windows user account.

- The fingerprint logon process can take a while. This is because the system has to check hardware devices and security configuration before initiating the fingerprint scanner.

To enroll your fingerprint:

1. Click  → **Settings** → **Accounts** → **Sign-in options**.
2. On the right side under **Fingerprint**, click **Set up**.
3. Follow the onscreen instructions to complete.

Chapter 3

Managing Power

Your computer operates either on external AC power or on internal battery power.

This chapter tells you how you can effectively manage power. To maintain optimal battery performance, it is important that you use the battery in the proper way.

AC Adapter

CAUTION:

- The AC adapter is designed for use with your computer only. Connecting the AC adapter to another device can damage the adapter.
- The AC power cord supplied with your computer is for use in the country where you purchased your computer. If you plan to go overseas with the computer, consult your dealer for the appropriate power cord.
- When you disconnect the AC adapter, disconnect from the electrical outlet first and then from the computer. A reverse procedure may damage the AC adapter or computer.
- When unplugging the connector, always hold the plug head. Never pull on the cord.

The AC adapter serves as a converter from AC (Alternating Current) to DC (Direct Current) power because your computer runs on DC power, but an electrical outlet usually provides AC power. It also charges the battery pack when connected to AC power.

The adapter operates on any voltage in the range of 100 ~ 240 V AC.

Battery Pack

The battery pack is the internal power source for the computer. It is rechargeable using the AC adapter.

NOTE: Care and maintenance information for the battery is provided in the “Battery Pack Guidelines” section in Chapter 7.

Charging the Battery Pack

NOTE:

- Charging will not start if the battery’s temperature is below 0 °C (32 °F) or above 40 °C (104 °F).
- The charging process will stop when the battery’s temperature gets above 60 °C (140 °F). The Battery Charge Indicator turns off in this state. Once the battery’s temperature drops within the safe range, charging will automatically resume with the Battery Charge Indicator glowing amber.
- During charging, do not disconnect the AC adapter before the battery has been fully charged; otherwise you will get a prematurely charged battery.

To charge the battery pack, connect the AC adapter to the computer and an electrical outlet. The Battery Charge Indicator () on the computer glows amber to indicate that charging is in progress. You are advised to keep the computer power off while the battery is being charged. When the battery is fully charged, the Battery Charge Indicator lights green.

It takes approximately 3.5 ~ 4.5 hours to fully charge the battery when the computer is off and 4 ~ 6 hours when the computer is on and in an idle state.

CAUTION: After the computer has been fully recharged, do not immediately disconnect and reconnect the AC adapter to charge it again. Doing so may damage the battery.

NOTE: The battery level may automatically lessen due to the self-discharge process (0.21 % per day), even when the battery pack is fully charged (100 %). This happens no matter if the battery pack is installed in the computer.

Initializing the Battery Pack

You need to initialize a new battery pack before using it for the first time or when the actual operating time of a battery pack is much less than expected. Initializing is the process of fully charging, discharging, and then charging. It can take several hours.

A software tool called “Gauge Reset” is provided for the purpose. Use the G-Manager program and select the **Battery** tab to find the tool.

Checking the Battery Level

NOTE: Any battery level indication is an estimated result. The actual operating time can be different from the estimated time, depending on how you are using the computer.

The operating time of a fully charged battery pack depends on how you are using the computer. When your applications often access peripherals, you will experience a shorter operating time.

By Operating System

You can find the battery icon on the Windows taskbar (lower-right corner). The icon shows the approximate battery level.

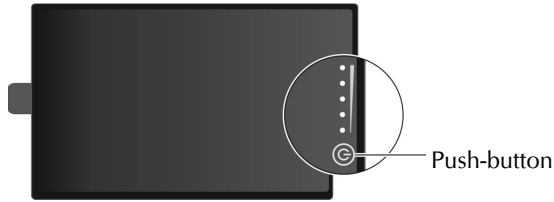

By Gas Gauge

On the exterior side of the battery pack is a gas gauge for displaying the estimated battery charge. When the battery pack is not installed in the computer and you want to know the battery charge, you can press the push-button to see the number of LEDs that light up. Each LED represents 20% charge.



Battery Low Signals and Actions

The battery icon changes appearance to display the current state of the battery.

Battery Icon	Battery Level	Description
	Discharging	The icon shows the charge remaining in 10-percent increments until the charge reaches the low-battery level.
	Low	The battery charge has reached the low-battery level.
	Critically low	The battery charge has reached the critical battery level. By default, Windows will display a notification and put your computer into Hibernation.

When the battery is low, the computer's Battery Charge Indicator () also blinks red to alert you to take actions.

Always respond to low-battery by connecting the AC adapter, placing your computer in Hibernation mode, or turning off the computer.

Replacing the Battery Pack

CAUTION:

- There is danger of explosion if the battery is incorrectly replaced. Replace the battery only with the computer manufacturer's optional battery packs. Discard used batteries according to the dealer's instructions.
- Do not attempt to disassemble the battery pack.

1. Turn off the computer and disconnect the AC adapter.

2. Locate the battery compartment on the left side of the computer.
3. Slide the cover lock to the left (❶) and then lift the release latch (❷) to open the compartment cover.



4. Pull the ribbon strip and slide the battery pack out of the compartment.



5. With the ribbon strip facing outward, insert the new battery pack all the way into the compartment.
6. Close the cover, press the release latch downward to engage, and then slide the lock towards the right to secure the cover.

Power-Saving Tips

Aside from enabling your computer's power saving mode, you can do your part to maximize the battery's operating time by following these suggestions.

- Do not disable Power Management.
- Decrease the LCD brightness to the lowest comfortable level.
- Shorten the length of time before Windows turn off the display.
- When not using a connected device, disconnect it.
- Remove the card (such as PC card, ExpressCard, and Smart Card) if not using it.
- Turn off the wireless radio if you are not using the wireless module (such as WLAN, Bluetooth, or WWAN).
- Turn off the computer when you are not using it.

Chapter 4

Expanding Your Computer

You can expand the capabilities of your computer by connecting other peripheral devices.

When using a device, be sure to read the instructions accompanying the device together with the relevant section in this chapter.

Connecting Peripheral Devices

Connecting a Display Monitor

If you want the benefits of a larger display screen with higher resolution, you can connect an external display monitor to your computer.

Your computer supports a VGA connector and a HDMI connector. HDMI (High-Definition Multimedia Interface) is an audio/video interface that transmits uncompressed digital data and therefore delivers true HD quality.

Follow this procedure to connect an external monitor:

1. Turn off the computer.
2. Depending on the type of your monitor, plug the monitor's signal connector to the computer's VGA or HDMI connector.

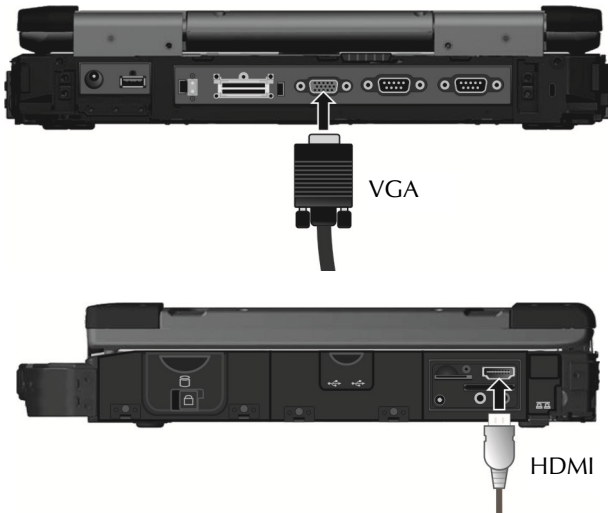

3. Plug one end of the monitor's power cord into the power socket on the monitor and the other end to an electrical outlet.
4. To use the monitor, turn on the monitor before turning on the computer.

5. The connected device should respond by default. If not, you can switch the display output by pressing the **Fn+F5** hot keys. (You can also change the display through Windows **Control Panel**.)

CAUTION: Do not disconnect the external monitor while the computer is in the Sleep mode or Hibernation mode. If no external monitor is connected when the computer resumes, the LCD might not display properly.

Connecting a Serial Device

Your computer has two serial ports for connecting a serial device such as a serial mouse or serial communication device (modem).

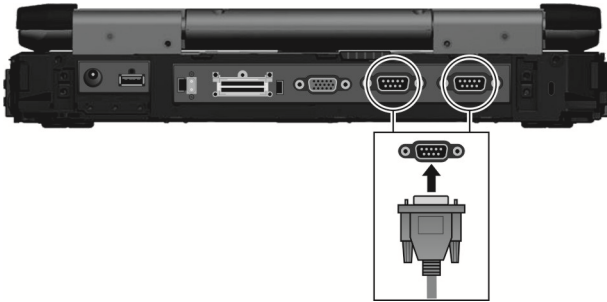

NOTE: Portable modems that derive power through the serial port cannot be used with the computer. Instead, use a modem that is powered by its own internal battery or external AC power.

Connecting a USB Device

Your computer has three USB 3.0 port for connecting USB devices, such as a digital camera, scanner, printer, modem, and mouse.



Connecting Audio Devices

For higher audio quality, you can send or receive sound through external audio devices.

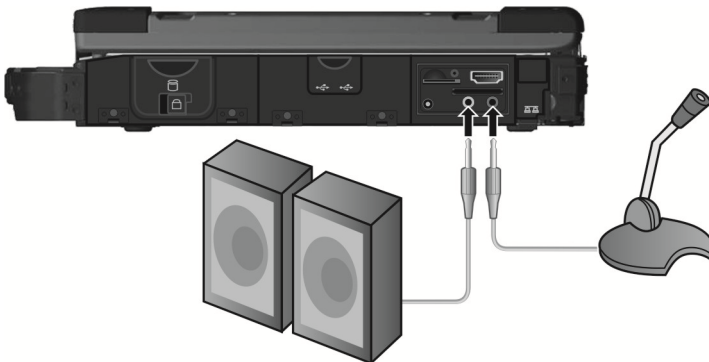

- **Audio Output Connector** (green) can be connected to speakers, headphones, or earphone set.

- **Microphone Connector** (pink) can be connected to an external microphone for recording voice or sound.

NOTE :

- After connecting an external audio device, make sure that you specify the use of the correct audio device in Windows.
- When using the external speakers/headphones or microphone, you cannot use the internal one.

Using Various Card Readers

Using Smart Cards

NOTE: On your computer, the Smart Card reader is a part of the super multi drive module. If the super multi drive module is replaced by a secondary battery pack or hard disk drive, you cannot use the Smart Card reader.

With an embedded microcontroller, smart cards have the unique ability to store large amounts of data, carry out their own on-card functions (e.g., encryption and mutual authentication), and interact intelligently with a smart card reader.

To insert a smart card:

1. Locate the smart card slot on the left of the computer and open the cover.
2. Slide the smart card, with its label and embedded computer chip facing up into the slot.

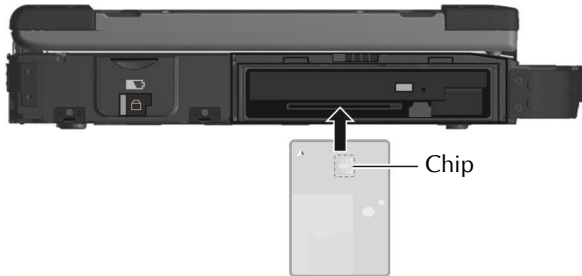

To remove a smart card:

1. Make sure that the third-party smart card software is not accessing the smart card.
2. Pull the card out of the slot.
3. Close the cover.

Using PC Cards

NOTE :

- Some PC cards require additional system resources. Before using such PC card, you may have to free other system resources for the PC card.
- Although some PC cards can be inserted and removed without turning off the computer, you cannot remove or install PC cards during Sleep mode.

Your computer has one PC card slot which supports type II card and CardBus specifications.

To insert a PC card:

1. Locate the PC card slot on the right side of the computer and open the cover.
2. Slide the PC card, with its label facing up, into the slot until the eject button pops out.

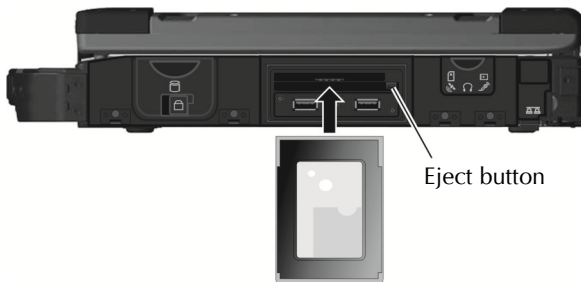

To remove a PC card:

1. Double-click the **Safety Remove Hardware**  icon found on the Windows taskbar and the **Safety Remove Hardware** window appears on screen.
2. Select (highlight) the PC card from the list to disable the card.
3. Push the eject button and the card will slide out slightly.
4. Pull the card out of the slot.
5. Close the cover.