

*Getac*

V110  
USER MANUAL

January 2016

**TRADEMARKS**

All brand and product names are trademarks or registered trademarks of their respective companies.

**NOTE**

The information in this manual is subject to change without notice. For the latest version of the manual, please visit the Getac website at [www.getac.com](http://www.getac.com).

# Table of Contents

<b>Chapter 1</b>	<b>Getting Started</b> .....	<b>1</b>
	Getting the Computer Running .....	2
	Unpacking .....	2
	Connecting to AC Power .....	3
	Opening and Closing the Cover .....	4
	Operating in Tablet Mode .....	5
	Turning On and Off the Computer .....	7
	Taking a Look at the Computer .....	8
	Front Components .....	8
	Rear Components .....	9
	Right-Side Components .....	10
	Left-Side Components .....	11
	Top-open Components .....	12
	Bottom Components .....	14
	Installing the Accessories .....	16
	Attaching the Carrying Strap .....	16
	Using the Tether .....	17
	Attaching the Handgrip Strap (Optional) .....	18
<b>Chapter 2</b>	<b>Operating Your Computer</b> .....	<b>19</b>
	Using the Internal Keyboard .....	20
	Typewriter Keys .....	20
	Cursor-Control Keys .....	20
	Numeric Keypad .....	21
	Function Keys .....	22
	Fn Key .....	22
	Hot Keys .....	22
	Windows Keys .....	23
	Using the Touchpad .....	24
	Configuring the Touchpad .....	26
	Navigating on the Screen .....	27

	Using the Touchscreen .....	27
	Using the Dual Mode Display (Optional) .....	30
	Using the Network Features .....	31
	Using the LAN.....	31
	Using the WLAN .....	31
	Using the BT Feature.....	33
	Turning On/Off the BT Radio .....	33
	Connecting to another BT Device .....	34
	Using the WWAN Feature (Optional) .....	35
	Installing a SIM Card.....	35
	Turning On/Off the WWAN Radio .....	36
	Setting up a WWAN Connection .....	37
	Using the Fingerprint Scanner (Optional) .....	38
<b>Chapter 3</b>	<b>Managing Power.....</b>	<b>40</b>
	AC Adapter .....	41
	Battery Pack .....	42
	Charging the Battery Pack.....	42
	Initializing the Battery Pack .....	43
	Checking the Battery Level.....	43
	Battery Low Signals and Actions .....	44
	Replacing the Battery Pack .....	44
	Power-Saving Tips .....	47
<b>Chapter 4</b>	<b>Expanding Your Computer .....</b>	<b>48</b>
	Connecting an HDMI Display Monitor .....	49
	Connecting a USB Device.....	50
	Connecting a Serial Device .....	51
	Connecting an Audio Device .....	52
	Using Smart Cards.....	53
	Using ExpressCards .....	54
	Using the NFC/RFID Reader (Optional) .....	55
	Replacing the Hard Disk Drive.....	56
	System Memory Upgrade .....	57
<b>Chapter 5</b>	<b>Using BIOS Setup .....</b>	<b>59</b>
	When and How to Use .....	60
	Menu Descriptions .....	61
	Information Menu .....	61
	Main Menu .....	61
	Advanced Menu.....	62
	Security Menu.....	63
	Boot Menu .....	64

	Exit Menu .....	64
<b>Chapter 6</b>	<b>Using Getac Software .....</b>	<b>65</b>
	OSD Control Panel.....	66
	G-Manager .....	67
	Getac Camera (Optional).....	69
	Camera for Windows 10.....	69
	Camera for Windows 7.....	70
<b>Chapter 7</b>	<b>Care and Maintenance .....</b>	<b>71</b>
	Protecting the Computer .....	72
	Using an Anti-Virus Strategy .....	72
	Using the Cable Lock.....	72
	Taking Care of the Computer.....	73
	Location Guidelines .....	73
	General Guidelines .....	73
	Cleaning Guidelines .....	74
	Battery Pack Guidelines.....	74
	Touchscreen Guidelines .....	76
	When Traveling.....	77
<b>Chapter 8</b>	<b>Troubleshooting.....</b>	<b>78</b>
	Preliminary Checklist .....	79
	Solving Common Problems .....	80
	Battery Problems .....	80
	BT Problems.....	80
	Display Problems.....	81
	Hardware Device Problems .....	81
	Keyboard and Touchpad Problems .....	82
	LAN Problems .....	82
	Power Management Problems .....	83
	Sensor Problems (for Windows 10 Models Only) .....	83
	Software Problems .....	84
	Sound Problems .....	84
	Startup Problems .....	85
	WLAN Problems .....	85
	Other Problems.....	87
	Resetting the Computer .....	88
	System Recovery .....	89
	System Restore, Recovery, or Reset (for Windows 10 Models)	89
	.....	89
	System Recovery (a Tool for Windows 7 Models) .....	89
	Using the Driver Disc (Optional) .....	91

**Appendix A Specifications ..... 92**

**Appendix B Regulatory Information ..... 94**

- On the Use of the System .....95
  - Class B Regulations.....95
  - ANSI Warning.....96
  - Safety Notices .....97
- On the Use of the RF Device .....99
  - USA and Canada Safety Requirements and Notices .....99
  - European Union CE Marking and Compliance Notices... 100
- User Notification of Take-back Service..... 102
- ENERGYSTAR 6.1..... 103
- Battery Recycling ..... 105

# Chapter 1

## *Getting Started*







Congratulations on purchasing this rugged computer.

This chapter first tells you step by step how to get the computer up and running. Then, you will find a section briefly introducing the external components of the computer.

# Getting the Computer Running

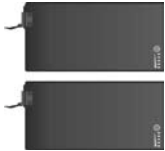
## Unpacking

After unpacking the shipping carton, you should find these standard items:

<ul style="list-style-type: none"><li>● V110 notebook computer</li></ul>	
<ul style="list-style-type: none"><li>● AC adapter</li></ul> 	<ul style="list-style-type: none"><li>● AC power cord</li></ul> 
<ul style="list-style-type: none"><li>● Battery pack x 2</li></ul> 	<ul style="list-style-type: none"><li>● Screen cleaning cloth</li></ul> 
	<ul style="list-style-type: none"><li>● Carrying strap</li></ul> 
<ul style="list-style-type: none"><li>● Stylus</li></ul> 	<ul style="list-style-type: none"><li>● Tether</li></ul> 
<ul style="list-style-type: none"><li>● Document(s)</li></ul>	<ul style="list-style-type: none"><li>● Driver disc (optional)</li></ul>

Inspect all the items. If any item is damaged or missing, notify your dealer immediately.



# Connecting to AC Power

It is suggested that you use AC power when you start up the computer for the very first time.

1. Plug the DC cord of the AC adapter to the power connector of the computer (1)
2. Plug the female end of the AC power cord to the AC adapter and the male end to an electrical outlet (2)

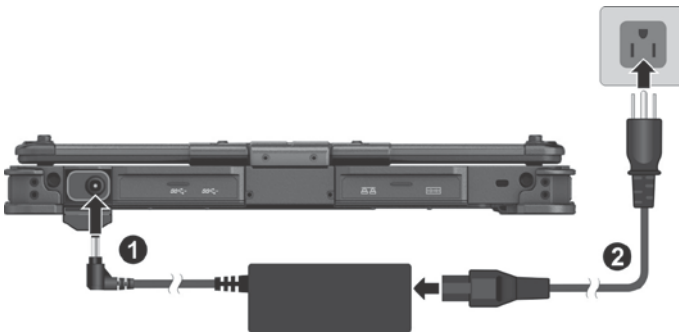

3. Power is being supplied from the electrical outlet to the AC adapter and onto your computer. Now, you are ready to turn on the computer.

**CAUTION:** Use only the AC adapter included with your computer. Using other AC adapters may damage the computer.

**NOTE:** When the AC adapter is connected, it also charges the battery pack. For information on using battery power, see Chapter 3.

# Opening and Closing the Cover

To open the top cover:

1. Pull loose the cover latch ( **1** ) and release the clamp ( **2** ).
2. Lift up the cover ( **3** ). You can tilt the cover forward or backward for optimal viewing clarity.



To close the top cover:

1. Close the display.
2. Lift the cover latch and engage the clamp on the display. Then, push in the cover latch to click it into place.

**CAUTION:** Before engaging the clamp, make sure the two guide pins are correctly seated in place.

**Correct:** guide pin correctly seated



**Correct:** guide pin correctly seated

**Wrong:** guide pin not seated



**Wrong:** guide pin not seated

# Operating in Tablet Mode

In addition to being used as a regular notebook computer (Laptop mode), your computer can also be operated in Tablet mode. In Tablet mode, you operate the computer with a stylus or digitizer pen, or a fingertip, instead of a keyboard or mouse.

1. Open the top cover so that it is almost perpendicular with the keyboard of the computer.
2. Turn the display counter-clockwise by 180°.



**CAUTION:** Do not rotate the display more than 180°, or attempt to rotate the display clockwise.

3. Close the computer with the display facing up.



4. Lift the cover latch and engage the clamp on the display. Then, push in the cover latch to click it into place.

**CAUTION:** Before engaging the clamp, make sure the two guide pins are correctly seated in place.

**Correct:** *guide pin correctly seated*



**Correct:** *guide pin correctly seated*

**Wrong:** *guide pin not seated*



**Wrong:** *guide pin not seated*

# Turning On and Off the Computer





## Turning On

Press the power button (  ). The Windows operating system should start.

**NOTE:** Tapping the screen during startup may invoke a pre-boot menu (unless the default settings have been changed). If the menu appears, simply select **Continue**.

## Turning Off

When you finish a working session, you can stop the system by turning off the power or leaving it in Sleep or Hibernation mode:

To...	Do this...	
	Windows 10	Windows 7
Power off (Shutdown)	Click  →  <b>Power</b> → <b>Shut down</b> .	Use the Windows Start menu in the lower left and follow the shutdown procedure.
Sleep	Use one of these methods: <ul style="list-style-type: none"><li>● Press the power button.*</li><li>● Close the top cover.*</li><li>● Press <b>Fn + F12</b>.*</li><li>● Click  →  <b>Power</b> → <b>Sleep</b>.</li></ul>	Use one of these methods: <ul style="list-style-type: none"><li>● Press the power button.*</li><li>● Close the top cover.*</li><li>● Press <b>Fn + F12</b>.*</li><li>● Use the Windows Start menu to put the computer in Sleep mode.</li></ul>
Hibernate	By default, this option is not shown in the Start menu. If you want to use the feature, set up accordingly in Windows settings.	Use the Windows Start menu to put the computer in Hibernation mode.

\* “Sleep” is the default result of the action. You can change what the action does through Windows settings.





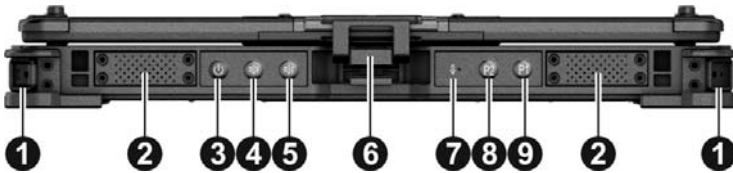

# Taking a Look at the Computer

**NOTE:** Depending on the model you purchased, the appearance of your computer may not be exactly the same as those shown in this manual.

**CAUTION:** You need to open the protective covers to access the connectors. When not using a connector, make sure to close the cover completely for water-, dust-, and fire-proof integrity. (Engage the locking mechanism if existing.)

## Front Components



Ref	Component	Description	See Also
	<b>Strap Holder</b>	Two buckles hold the carrying strap.	P. 16
	<b>Stereo Speaker</b>	Sends out sound and voice from your computer.	
	<b>Power Button</b>	Turns the power on or off. (The default “off” state is “Sleep mode.”)	P. 7
	<b>Up Button</b>	Increases the sound volume.	
		<b>When Function Lock is on:</b> Increases the LCD brightness.	
	<b>Down Button</b>	Decreases the sound volume.	
		<b>When Function Lock is on:</b> Decreases the LCD brightness.	
	<b>Top Cover Latch</b>	Locks the top cover.	P. 4
	<b>Microphone</b>	Receives sound and voice to record voice.	

Ref	Component	Description	See Also
E	P2 Button	Starts the Getac Camera program and serves as the shutter release button.	P. 69
		<b>When Function Lock is on:</b> Enables or disables the touchscreen feature.	
		Can be changed to another set of predefined functions using G-Manager.	
E	P1 Button	Switches on or off <b>Function Lock (FL)</b> , which changes the <b>P2</b> , <b>Up</b> , and <b>Down</b> buttons to an alternative function. When <b>FL</b> is on, the icon appears on Windows taskbar.	
		<b>When pressed longer:</b> Serves as the <b>Ctrl+Alt+Del</b> keyboard keys.	P. 88





## Rear Components

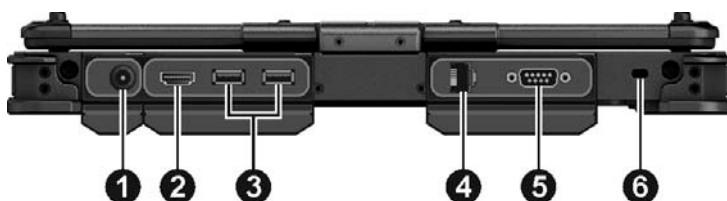

To access a connector, open its protective cover by lifting up the tab of the cover. When closing the cover, push the tab downward until the cover clicks into place.





Ref	Component	Description	See Also
1	Power Connector	Connects the AC adapter.	P. 3
2	HDMI Connector	Connects a HDMI monitor or TV set.	P. 49

Ref	Component	Description	See Also
	<b>USB 3.0 Port</b>	Connects a USB device, such as a flash disk, printer, digital camera, joystick, and more.	P. 50
	<b>RJ-45 Connector</b>	Connects the LAN cable.	P. 31
	<b>Serial Port</b>	Connects a serial device.	P. 51
	<b>Kensington Lock</b>	Locks the computer to a stationary object for security.	P. 72



## Right-Side Components

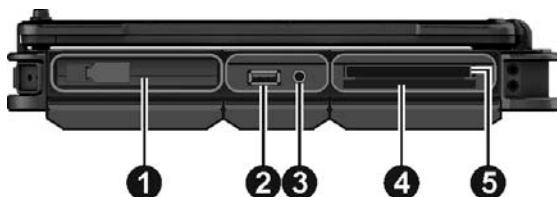

To access a connector, open its protective cover by lifting up the tab of the cover. When closing the cover, push the tab downward until the cover clicks into place.

To access a device bay, slide the cover latch toward the unlocked position (  ) and then lift up the tab to release the cover. When closing the cover, push the tab downward until the cover clicks into place and then slide the latch toward the locked position (  ).



Ref	Component	Description	See Also
	<b>Battery Pack</b>	Inside is the battery pack (Battery 2) that supplies power to your computer when external power is not connected.	P. 42
	<b>USB 2.0 Port</b>	Connects a USB device, such as a flash disk, printer, digital camera, joystick, and more.	P. 50



Ref	Component	Description	See Also
E	<b>Combo Audio Connector</b>	Connects a set of headphones or external speakers with amplifier	P. 52
		Supports a headset microphone with 4-pole TRRS 3.5mm jack.	
4	<b>Smart Card Slot</b>	Accepts a smart card for additional security feature.	P. 53
5	<b>ExpressCard Slot</b>	Accepts an ExpressCard for additional functions.	P. 54

## Left-Side Components

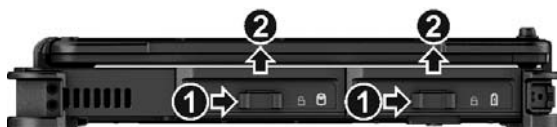

To access a device bay, slide the cover latch toward the unlocked position (🔓) and then lift up the tab to release the cover. When closing the cover, push the tab downward until the cover clicks into place and then slide the latch toward the locked position (🔒).

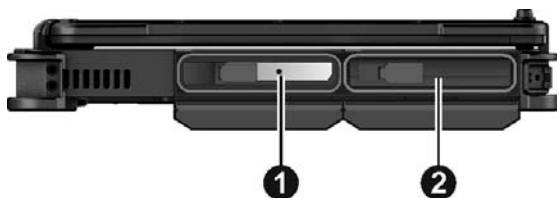





Ref	Component	Description	See Also
1	<b>Hard Disk Drive</b>	Inside is the hard disk drive.	P. 55
2	<b>Battery Pack</b>	Inside is the battery pack (Battery 1) that supplies power to your computer when external power is not connected.	P. 42

# Top-open Components



Ref	Component	Description	See Also
1	<b>RFID Antenna</b> (optional)	Reads data from NFC/RFID tags.	P. 55
2	<b>Touchscreen</b>	Displays and receives information for the computer.	P. 27
3	<b>Camera Lens</b> (optional)	Allows you to use your computer's camera function. When the camera lens is in use, the LED beside it lights up.	P. 69
4	<b>Fingerprint Scanner</b> (optional)	Serves as the fingerprint verification, preventing unauthorized access to your computer.	P. 38

Ref	Component	Description	See Also	
	<b>Light Sensor</b>	Detects the surrounding lighting condition for automatic adjustment of the LCD brightness.		
	<b>Windows Logo Button</b>	<b>For Windows 10:</b> Opens or closes the Start menu.		
		<b>For Windows 7:</b> Opens or closes the OSD Control Panel.	P. 66	
	<b>Indicators</b>	Show the current status of the computer's devices.		
	<b>Power</b>	Lights green when the computer is turned on.	P. 7	
		Blinks green when the computer is in Sleep mode.		
	<b>Battery Charge</b>	Lights amber when the battery is being charged.	P. 42	
		Lights green when battery charging is completed.		
		Blinks green to indicate the battery's built-in high temperature protection mechanism is activated. <b>CAUTION: Do not remove the battery during this period.</b>		
		Blinks red when the battery's capacity is below 10%.		P. 44
		Blinks amber when the battery charging is in an abnormal state. Replace the battery in case this happens.		
	<b>Hard Disk Drive In-Use</b>	Lights green when the computer is accessing the hard disk drive.		
 <b>Caps Lock</b>	Lights green when Caps Lock is on.			
<b>RF (Radio Frequency)</b>	Lights green when the RF radio of any RF feature (WLAN/BT/WWAN) is on.			
	<b>Keyboard</b>	Serves as the data input device.	P. 20	

Ref	Component	Description	See Also
<b>E</b>	<b>Touchpad</b>	Serves as the pointing device.	P. 24

## Bottom Components

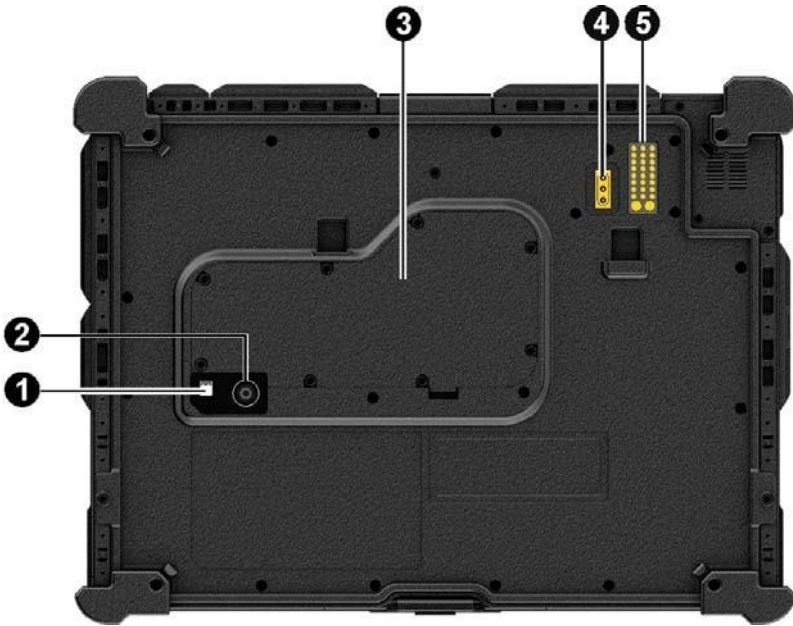

Ref	Component	Description	See Also
<b>1</b>	<b>Camera Indicator</b> (optional)	Lights up when the camera lens beside it is in use.	
	<b>Flash</b> (optional)	Provides extra light when taking pictures.	
<b>2</b>	<b>Camera Lens</b> (optional)	Allows you to use the camera function.	P. 69
<b>E</b>	<b>Memory Slots</b>	Inside are the memory slots for expanding the memory size of your computer.	P. 57
	<b>SIM Card Slot</b> (optional)	Inside is the SIM card slot.	P. 35

Ref	Component	Description	See Also
4	<b>Antenna Pass-through</b> (optional)	Connects to the docking station for using external WWAN/WLAN/GPS antenna. <i>WWAN</i> <i>WLAN</i> <i>GPS</i>	
5	<b>Docking Connector</b>	Inside is the docking connector for connecting an office dock or vehicle dock (purchased separately).	

# Installing the Accessories

## Attaching the Carrying Strap

Insert one end of the strap into one strap holder ( **1** ) on your computer and feed it through the slider buckle ( **2** ). Use the fastener ( **3** ) to fix the end in place. Secure the other end of the strap to the computer in the same way.



The strap provides a slot for storing the stylus ( **4** ).

# Using the Tether

A tether is available for attaching the stylus to your computer.

1. Insert one of the tether's loop ends through the hole of the stylus (as indicated by **1** below). Then, insert the other end through the first bob (as indicated by **2** below) and pull it tight.

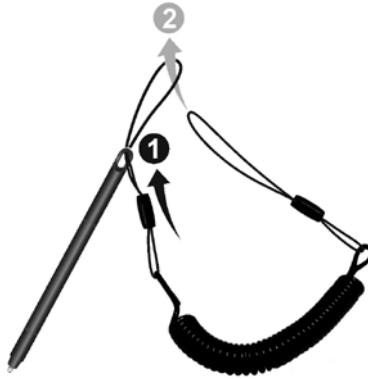

2. Insert the other loop end to the strap holder on computer (as indicated by **1** below). Then, insert the stylus end through the loop (as indicated by **2** below) and pull it tight.

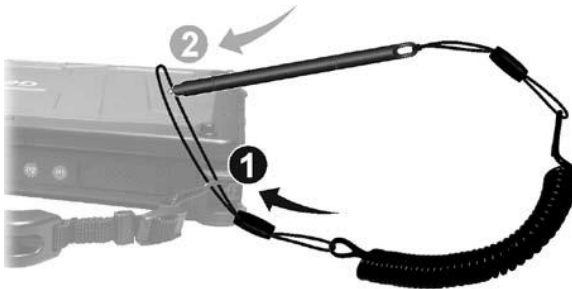

# Attaching the Handgrip Strap (Optional)

1. Insert a hook to each of the computer's four bottom corners. Secure each hook with a screw.

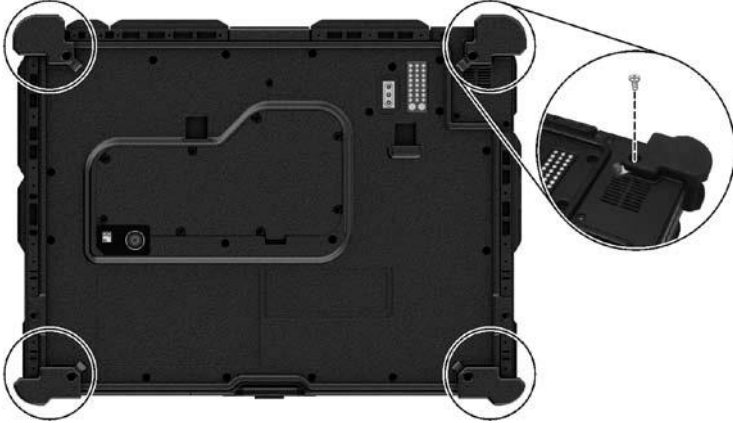

2. Attach the four loops of the handgrip strap to the four hooks. Make sure the loops are securely hooked.



When you need to operate and hold your computer at the same time, insert your hand through the strap for a firm grip.



# Chapter 2

# *Operating Your Computer*

This chapter provides information about the use of the computer.

If you are new to computers, reading this chapter will help you learn the operating basics. If you are already a computer user, you may choose to read only the parts containing information unique to your computer.

**CAUTION:**

Do not expose your skin to the computer when operating it in a very hot or cold environment.

The computer can get uncomfortably warm when you use it in high temperatures. As a safety precaution in such a circumstance, do not place the computer on your lap or touch it with your bare hands for extended periods of time. Prolonged body contact can cause discomfort and potentially a burn.

# Using the Internal Keyboard

Your keyboard has all the standard functions of a full-sized computer keyboard plus an **Fn** key added for specific functions.

The standard functions of the keyboard can be further divided into four major categories:

- Typewriter keys
- Cursor-control keys
- Numeric keys
- Function keys

## Typewriter Keys

Typewriter keys are similar to the keys on a typewriter. Several keys are added such as the **Ctrl**, **Alt**, **Esc**, and lock keys for special purposes.

The Control (**Ctrl**) / Alternate (**Alt**) key is normally used in combination with other keys for program-specific functions. The Escape (**Esc**) key is usually used for stopping a process. Examples are exiting a program and canceling a command. The function depends on the program you are using.

## Cursor-Control Keys

Cursor-control keys are generally used for moving and editing purposes.

**NOTE:** The word “cursor” refers to the indicator on the screen that lets you know exactly where on your screen anything you type will appear. It can take the form of a vertical or horizontal line, a block, or one of many other shapes.

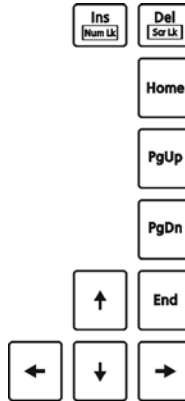

## Numeric Keypad

A 15-key numeric keypad is embedded in the typewriter keys as shown next:

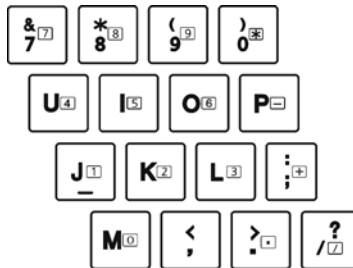

Numeric keys facilitate entering of numbers and calculations. When Num Lock is on, the numeric keys are activated; meaning you can use these keys to enter numerals.

### NOTE:

When the numeric keypad is activated and you need to type the English letter in the keypad area, you can turn Num Lock off or you can press **Fn** and then the letter without turning Num Lock off.

Some software may not be able to use the numeric keypad on the computer. If so, use the numeric keypad on an external keyboard instead.

- The **Num Lock** key can be disabled. (See “Main Menu” in Chapter 5.)

# Function Keys

On the top row of the keys are the function keys: **F1** to **F12**. Function keys are multi-purpose keys that perform functions defined by individual programs.









## Fn Key

















The **Fn** key, at the lower left corner of the keyboard, is used with another key to perform the alternative function of a key. To perform a desired function, first press and hold **Fn**, then press the other key.

## Hot Keys



Hot keys refer to a combination of keys that can be pressed any time to activate special functions of the computer. Most hot keys operate in a cyclic way. Each time a hot key combination is pressed, it shifts the corresponding function to the other or next choice.



You can easily identify the hot keys with the icons imprinted on the keytop. The hot keys are described next.

Key	Description
 	Switches the keyboard backlight on and off (option).
 	Switches the RF (radio frequency) radio on and off. When off, all wireless modules (such as WLAN, BT, and WWAN) cannot be used. When on, individual settings of the module work.
 	Decreases the sound volume.
 	Increases the sound volume.

Key	Description
 	<p>Switches the display output to the next choice if an external display is connected. Choices are:</p> <ul style="list-style-type: none"> <li>→ LCD only</li> <li>↓ LCD + External display (Duplicate)</li> <li>↓ LCD + External display (Extend)</li> <li>↓ External display only</li> </ul> <p>The hot keys are equivalent to Windows logo key + <b>P</b>.</p>
 	Decreases the LCD brightness.
 	Increases the LCD brightness.
 	Switches the touchscreen on or off.
 	Switches the touchpad off or on.
 	Switches the system sound output off (mute) or on.
 	Switches the display on or off.
 	Serves as the sleep button that you can define with Windows' <b>Power Options</b> .

## Windows Keys

The keyboard has two keys that perform Windows-specific functions:  Windows Logo key and  Application key.

The  Windows Logo key opens the **Start** menu and performs software-specific functions when used in combination with other keys. The  Application key usually has the same effect as a right mouse click.

# Using the Touchpad

**CAUTION:** Do not use a sharp object such as a pen on the touchpad. Doing so may damage the touchpad surface.

**NOTE:**

Press **Fn+F9** to toggle the touchpad on or off.

For optimal performance of the touchpad, keep your fingers and the pads clean and dry. When tapping on the pad, tap lightly. Do not use excessive force.

The touchpad is a pointing device that allows you to communicate with the computer by controlling the location of the pointer on the screen and making selection with the buttons.







The touchpad consists of a rectangular pad (work surface) and a left and right buttons. To use the touchpad, place your forefinger or thumb on the pad. The rectangular pad acts like a miniature duplicate of your display. As you slide your fingertip across the pad, the pointer (also called cursor) on the screen moves accordingly. When your finger reaches the edge of the pad, simply relocate yourself by lifting the finger and placing it on the other side of the pad.

Here are some common terms that you should know when using the touchpad:

Term	Action
Point	Move your finger on the pad until the cursor points to the selection on the screen.
Click	Press and release the left button. –or– Tap gently anywhere on the pad.
Double-click	Press and release the left button twice in quick succession. –or– Tap twice on the pad rapidly.
Drag and drop	Press and hold the left button, then move your finger until you reach your destination (drag). Finally, release the button (drop) when you finish dragging your selection to the destination. The object will drop into the new location. –or– Gently tap twice on the pad and on the second tap, keep your finger in contact with the pad. Then, move your finger across the pad to drag the selected object to your destination. When you lift your finger from the pad, the selected object will drop into place.

The touchpad also supports the core touch gestures for Windows 10 as described below.

Gestures	Actions	Descriptions
Two-finger slide		Horizontal or vertical scroll
Two-finger pinch		Zoom

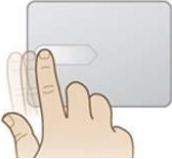
Gestures	Actions	Descriptions
Swipe in from the right edge		Open the Charms bar.
Swipe down from the top edge		Perform the same function as a right-click.
Swipe in from the left edge		Switch to the previous application.

## Configuring the Touchpad

You may want to configure the touchpad to suit your needs. For example, if you are a left-handed user, you can swap the two buttons so that you can use the right button as the left button and vice versa. You can also change the size of the on-screen pointer, the speed of the pointer, and so on.

To configure the touchpad, go to **Settings** → **Devices** → **Mouse & touchpad** (in Windows 10) or **Control Panel** → **Mouse** (in Windows 7).



# Navigating on the Screen

The screen of your computer is touch-sensitive. You can operate the computer by touching the screen with your finger or the stylus.

**CAUTION:** Do not use a sharp object such as a ballpoint pen or pencil on the touchscreen. Doing so may damage the touchscreen surface.

**NOTE:** An optical film has been attached to the screen before shipment. The film is a consumable, which will be worn out by possible scratches. You can purchase a new one when replacement is required.

## Using the Touchscreen

Your computer has a capacitive touchscreen. This type of touchscreen responds to objects that have conductive properties, such as fingertips and a capacitive-tipped stylus.

Your computer has a capacitive touchscreen, which senses conductivity to register input. By default settings, your touchscreen responds best to fingertips. If you prefer using a capacitive-tipped stylus (such as the one supplied with your model) or if you are wearing gloves, you should change the touchscreen settings to suit your scenario. Double-tap **Touch Screen Mode** on Windows desktop to open the settings menu and select one of the options (as shown below).



*This mode works best with fingertips.*

*Select this if you are using a capacitive-tipped stylus.*

*Select this if you are wearing gloves (referring to warm gloves or work gloves, not referring to touchscreen-capable gloves).*



The following table shows how you use the touchscreen to obtain equivalent mouse functions.

Term/Action	Equivalent Mouse Function
<b>Tap:</b> Touch the screen once.	Click/Point
<b>Double-tap:</b> Touch the screen twice rapidly.	Double-click
<b>Tap and hold:</b> Tap and hold until a popup menu appears.	Right-click
<b>Drag:</b> Hold the stylus (or finger) on the screen and drag across the screen until reaching your destination.	Drag

## Using Multi-touch Gestures

You can interact with your computer by placing two fingers on the screen. The movement of the fingers across the screen creates “gestures,” which send commands to the computer.

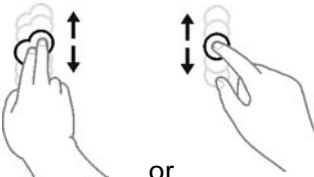
Here are the multi-touch gestures that you can use:

Gestures	Actions ( = finger down; = finger up)	Descriptions
Pan (Scroll)	 <p>or Drag 1 or 2 fingers up or down.</p>	Use panning to see another part of a page that has scroll bars.
Zoom (Pinch)	 <p>Move two fingers apart/toward each other.</p>	Use zooming to make an item (a photo for example) on the screen larger or smaller. The gesture works in applications that support mouse wheel zooming.

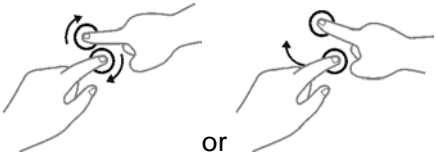
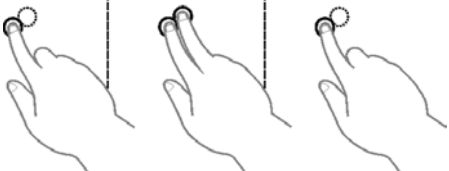
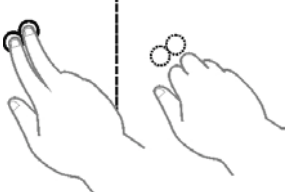
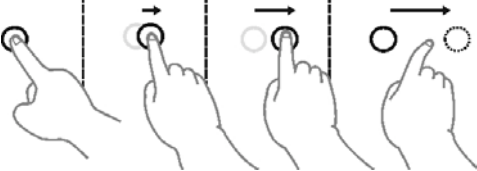
Gestures	Actions ( = finger down; = finger up)	Descriptions
Rotate	 <p>Move two fingers in opposing directions. -or- Use one finger to pivot around another.</p>	Use rotating to move a picture or other item on the screen in a circular direction (clockwise or counter-clockwise). The gesture works in applications that support the specific gesture.
Press and Tap	 <p>Press on target and tap using a second finger.</p>	Use press and tap to access the shortcut menu.
Two-finger Tap	 <p>Tap two fingers at the same time (where the target is in the midpoint between the fingers).</p>	The function is defined by applications that support the specific gesture.
Flicks	 <p>Make quick drag gestures in the desired direction.</p>	Flick left or right to navigate back and forward in a browser and other applications. The gesture works in most applications that support back and forward.

## Using the Dual Mode Display (Optional)

Dual mode display (if your model has the feature) incorporates both touchscreen and digitizer functions.

The display is set to Touchscreen mode by default. Touchscreen mode provides all the functionalities that an ordinary touchscreen has. When the Computer receives signals from the digitizer pen, the display automatically switches to Digitizer mode.

You can move the cursor by bringing the digitizer pen close to the screen, without actually touching the screen's surface.

# Using the Network Features

## Using the LAN

To connect the network cable to the LAN module, connect one end of the LAN cable to the RJ-45 connector on the computer and the other end to the network hub.

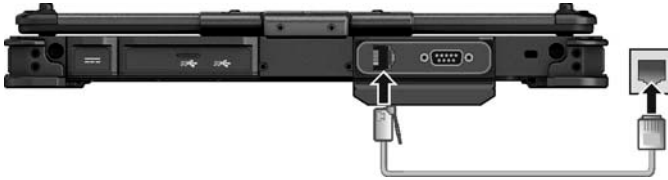



## Using the WLAN

The WLAN (Wireless Local Area Network) module of your computer supports IEEE 802.11a/b/g/n/ac.

## Turning On/Off the WLAN Radio

**To turn on the WLAN radio:**

1. Make sure that the Airplane mode is switched off. You can control the Airplane mode using one of the below methods.
  - Press **Fn+F1**.
  - Use the **Airplane Mode** button in the OSD Control Panel.
  - **For Windows 10:** Click  → **Settings** → **Network & Internet** → **Airplane mode**. Slide the **Airplane mode** switch to the **Off** position.
2. If you have previously turned off the WLAN radio, use one of the below methods to turn it on.
  - **For Windows 10:** Click  → **Settings** → **Network & Internet** → **Wi-Fi**. Slide the **Wi-Fi** switch to the **On** position.
  - **For Windows 7:** Use either Windows Mobility Center or Getac Quick-Bar. To open Getac Quick Bar, right-click the Getac Utility icon  on

Windows taskbar and select **Quick Bar**. Click the WLAN button in the Quick Bar (an X over the button means the radio is currently off).





### To turn off the WLAN radio:

You can turn off the WLAN radio the same way you turn it on.

If you want to quickly turn off all wireless radio, simply switch on Airplane mode.

## Connecting to a WLAN Network

1. Make sure that the WLAN function is enabled (as described above).
2. **For Windows 10:** Click the network icon  in the lower right of the taskbar.

**For Windows 7:** Click the Wireless Network icon  on the taskbar. (An orange light in the icon  indicates connections are available.)

3. Select the device you want to connect from the search results.
4. Some networks require a network security key or passphrase. To connect to one of those networks, ask your network administrator or Internet service provider (ISP) for the security key or passphrase.

For more information on setting a wireless network connection, refer to Windows online help.



**NOTE:** You can use Intel® PROSet Wireless to take full advantage of the Wi-Fi capabilities of your computer. See the Help of the utility for instructions.

# Using the BT Feature

The BT technology allows short-range wireless communications between devices without requiring a cable connection. Data can be transmitted through walls, pockets and briefcases as long as two devices are within range.

## Turning On/Off the BT Radio

### To turn on the BT radio:

1. Make sure that the Airplane mode is switched off. You can control the Airplane mode using one of the below methods.
  - Press **Fn+F1**.
  - Use the **Airplane Mode** button in the OSD Control Panel.
  - **For Windows 10:** Click  → **Settings** → **Network & Internet** → **Airplane mode**. Slide the **Airplane mode** switch to the **Off** position.
2. If you have previously turned off the BT radio, use one of the below methods to turn it on.
  - **For Windows 10:** Click  → **Settings** → **Devices** → **BT**. Slide the **BT** switch to the **On** position.
  - **For Windows 7:** Use Getac Quick Bar. To open Getac Quick Bar, right-click the Getac Utility icon  on Windows taskbar and select **Quick Bar**. Click the BT button in the Quick Bar (an X over the button means the radio is currently off).



## To turn off the BT radio:

You can turn off the BT radio the same way you turn it on.

If you want to quickly turn off all wireless radio, simply switch on Airplane mode.

## Connecting to another BT Device

1. Make sure that the BT function is enabled (as described above).
2. Make sure that the target BT device is turned on, discoverable and within close range. (See the documentation that came with the BT device.)

3. **For Windows 10:** Click  → **Settings** → **Devices** → **BT**.

**For Windows 7:** Right-click the BT icon on Windows taskbar. Click **Add a Device**.

4. Select the device you want to connect from the search results.
5. Depending on the type of BT device that you want to connect to, you will need to enter the pertinent information.

For detailed information on using the BT feature, see Windows' online Help.



# Using the WWAN Feature (Optional)

A WWAN (Wireless Wide Area Network) uses mobile telecommunication cellular network technologies to transfer data. The WWAN module of your computer supports 3G and 4G LTE.

**NOTE:** Your model only supports data transmission. Voice transmission is not supported.

## Installing a SIM Card

1. Turn off the computer and disconnect the AC adapter.
2. Carefully place the computer upside down.
3. Remove the 8 screws to open the compartment cover.



4. Locate the SIM card holder.

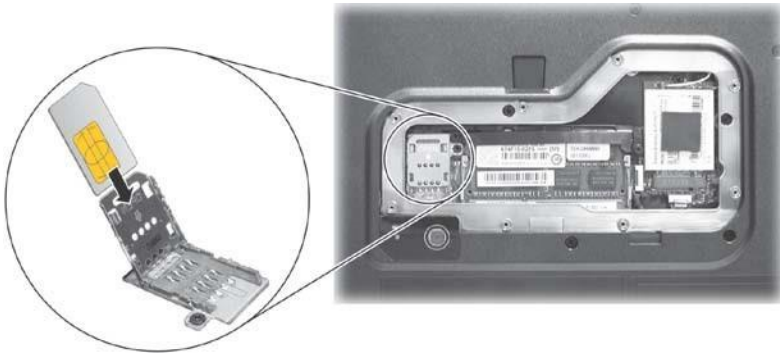

Slide the SIM card holder tray toward the **OPEN** direction to unlock. Lift up the tray and, noting the orientation, insert the SIM card into the tray. Close the holder tray and slide it back to the locked position.



5. Close the compartment cover and secure with 8 screws.

## Turning On/Off the WWAN Radio

### To turn on the WWAN radio:

1. Make sure that the Airplane mode is switched off. You can control the Airplane mode using one of the below methods.
  - Press **Fn+F1**.
  - Use the **Airplane Mode** button in the OSD Control Panel.
  - **For Windows 10:** Click  → **Settings** → **Network & Internet** → **Airplane mode**. Slide the **Airplane mode** switch to the **Off** position.
2. If you have previously turned off the WWAN radio, use one of the below methods to turn it on.
  - **For Windows 10:** Click  → **Settings** → **Network & Internet** → **Airplane mode**. Slide the **Cellular** switch to the On position.
  - **For Windows 7:** Use the WWAN utility software or Getac Quick Bar. To open Getac Quick Bar, right-click the Getac Utility icon  on Windows taskbar and select **Quick Bar**. Click the WWAN button in the Quick Bar (an X over the button means the radio is currently off).

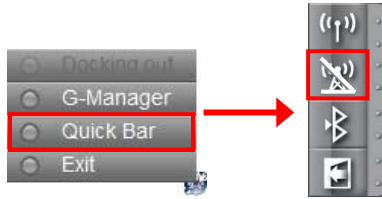

### To turn off the WWAN radio:

You can turn off the WWAN radio the same way you turn it on.

If you want to quickly turn off all wireless radio, simply switch on Airplane mode.

## Setting up a WWAN Connection

1. Make sure that the SIM card is inserted and the WWAN function is enabled (as described above).
2. Start the WWAN utility software (**Skylight**).



3. You can use the WWAN utility software to configure and use WWAN connections. See the online help for information.

# Using the Fingerprint Scanner (Optional)

## CAUTION:

We shall not be liable for any loss or damage whatsoever resulting from your use of the fingerprint scanner or neglect of fingerprint scanner use, or any data loss resulting from such developments as fingerprint authentication malfunctioning.

- It is not recommended that you use the fingerprint scanner in a below-freezing temperature. The moisture on your finger can freeze to the scanner's metal surface when you touch it, resulting in a failed operation. Besides, touching freezing metal with your finger can cause frostbite.

The fingerprint scanner (if your model has the feature) provides a strong authentication mechanism based on fingerprint recognition.



## NOTE:

You can enroll a fingerprint only after creating a password for the Windows user account.

The fingerprint login process can take a while. This is because the system has to check hardware devices and security configuration before initiating the fingerprint scanner.

As you can use the computer in different orientations, be sure to swipe your finger in the correct direction. The fingerprint scanner has a small triangle icon to remind you of the direction.

To enroll your fingerprint:

### For Windows 10

1. Click  → **Settings** → **Accounts** → **Sign-in options**.
2. On the right side under **Fingerprint**, click **Set up**.
3. Follow the onscreen instructions to complete.

### For Windows 7

1. Start **BioExcess**. Follow the wizard to enroll your fingerprints.
2. You can then use the fingerprint software to set up how the fingerprint authentication works. For detailed information, click the Help button of the software.



# Chapter 3

## *Managing Power*

Your computer operates either on external AC power or on internal battery power.

This chapter tells you how you can effectively manage power. To maintain optimal battery performance, it is important that you use the battery in the proper way.

# AC Adapter

## CAUTION:

The AC adapter is designed for use with your Computer only. Connecting the AC adapter to another device can damage the adapter. The AC power cord supplied with your Computer is for use in the country where you purchased your Computer. If you plan to go overseas with the Computer, consult your dealer for the appropriate power cord. When you disconnect the AC adapter, disconnect from the electrical outlet first and then from the Computer. A reverse procedure may damage the AC adapter or Computer. When unplugging the connector, always hold the plug head. Never pull on the cord.

The AC adapter serves as a converter from AC (Alternating Current) to DC (Direct Current) power because your Computer runs on DC power, but an electrical outlet usually provides AC power. It also charges the battery pack when connected to AC power.

The adapter operates on any voltage in the range of 100~240 V AC.

# Battery Pack

Your computer has two battery packs. The battery pack is the internal power source for the computer. It is rechargeable using the AC adapter.

**NOTE:** Care and maintenance information for the battery is provided in the “Battery Pack Guidelines” section in Chapter 7.

## Charging the Battery Pack

### NOTE:

- Charging will not start if the battery’s temperature is outside the allowed range, which is between 0 °C (32 °F) and 50 °C (122 °F). Once the temperature meets the requirements, charging automatically resumes.

During charging, do not disconnect the AC adapter before the battery has been fully charged; otherwise you will get a prematurely charged battery.

The battery has a high temperature protection mechanism which limits the maximum charge of the battery to 80% of its total capacity in the event of high temperature conditions. In such conditions, the battery will be regarded as fully charged at 80% capacity.

The battery level may automatically lessen due to the self-discharge process (0.21% per day), even when the battery pack is fully charged (100%). This happens no matter if the battery pack is installed in the computer.

To charge the battery pack, connect the AC adapter to the computer and an electrical outlet. The Battery Charge Indicator (  ) on the computer glows amber to indicate that charging is in progress. You are advised to keep the computer power off while the battery is being charged. When the battery is fully charged, the Battery Charge Indicator glows green.

The two battery packs are charged in parallel. It takes approximately 5 hours to fully charge the two battery packs when the power is off and approximately 6 hours when the power is on (may need a longer charging time at lower temperatures).

**CAUTION:** After the computer has been fully recharged, do not immediately disconnect and reconnect the AC adapter to charge it again. Doing so may damage the battery.



# Initializing the Battery Pack

You need to initialize a new battery pack before using it for the first time or when the actual operating time of a battery pack is much less than expected. Initializing is the process of fully charging, discharging, and then charging. It can take several hours.

A software tool called “Gauge Reset” is provided for the purpose. Use the G-Manager program and select the **Battery** tab to find the tool.

## Checking the Battery Level

**NOTE:** Any battery level indication is an estimated result. The actual operating time can be different from the estimated time, depending on how you are using the computer.

The operating time of a fully charged battery pack depends on how you are using the computer. When your applications often access peripherals, you will experience a shorter operating time.

The two battery packs are discharged in parallel.

## By Operating System

You can check the approximate battery level using the battery meter function of the operating system. To read the battery level in Windows, click the battery icon on the taskbar.







## By Gas Gauge

On the exterior side of the battery pack is a gas gauge for displaying the estimated battery charge. When the battery pack is not installed in the computer and you want to know the battery charge, you can press the push-button to see the number of LEDs that light up. Each LED represents 20% charge.

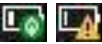

# Battery Low Signals and Actions

The battery icon changes appearance to display the current state of the battery.

Battery Icon		Battery Level	Description
Windows 10	Windows 7		
		Discharging	The icon shows the charge remaining in 10-percent increments until the charge reaches the low-battery level.
		Low	The battery charge has reached the low-battery level.
		Critically low	The battery charge has reached the critical battery level. By default, Windows will display a notification and put your computer into Hibernation.

When the battery is low, the computer's Battery Charge Indicator () also blinks red to alert you to take actions.

Always respond to low-battery by connecting the AC adapter, placing your computer in Hibernation mode, or turning off the computer.





## Replacing the Battery Pack

### CAUTION:

- There is danger of explosion if the battery is incorrectly replaced. Replace the battery only with the computer manufacturer's battery packs. Discard used batteries according to the dealer's instructions. Do not attempt to disassemble the battery pack.

**NOTE:** You can hot swap one battery pack while the other one is supplying the power.

To replace the battery pack, follow these steps:

1. Depending on which battery pack ( on the left side or  on the right side) you want to replace, open the respective cover.  
  
Slide the cover latch toward the unlocked position () () and then lift up the tab () to release the cover.



(Battery 1 as the example)

2. Hold the battery latch and slide it toward the right to unlock.

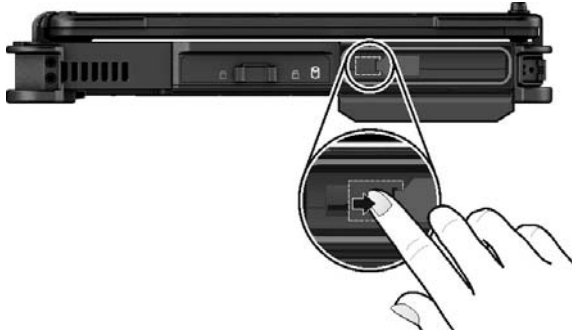

(Battery 1 as the example)

**CAUTION:** To unlock or lock, always hold the battery latch itself to move it. Never use the ribbon strip to pull the battery latch. The wrong method can cause a broken strip or an incorrect battery pack installation.

3. Remove the battery pack out of the slot by pulling the ribbon strip.
4. Noting the orientation, insert the new battery pack all the way into the slot.
5. Hold the battery latch and slide it toward the left to the locked position.

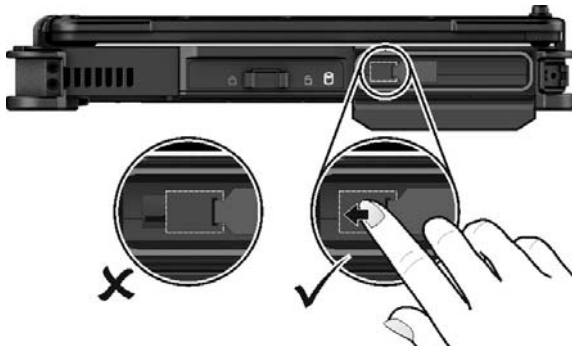

(Battery 1 as the example)

- When closing the cover, push the tab downward until the cover clicks into place and then slide the latch toward the locked position (🔒).

**CAUTION:** Make sure the latch is correctly locked, not revealing the underneath red part.



Correct



Incorrect (revealing red part)

# Power-Saving Tips

Aside from enabling your computer's power saving mode, you can do your part to maximize the battery's operating time by following these suggestions.

- Do not disable Power Management.
- Decrease the LCD brightness to the lowest comfortable level.
- Shorten the length of time before Windows turn off the display.
- When not using a connected device, disconnect it.  
Turn off the wireless radio if you are not using the wireless module (such as WLAN, BT, or WWAN).

Turn off the computer when you are not using it.

# Chapter 4

## *Expanding Your Computer*

You can expand the capabilities of your computer by connecting other peripheral devices.

When using a device, be sure to read the instructions accompanying the device together with the relevant section in this chapter.

# Connecting an HDMI Display Monitor

If you want the benefits of a larger display screen with higher resolution, you can connect an external display monitor to your computer.

Your computer supports an HDMI connector. HDMI (High-Definition Multimedia Interface) is an audio/video interface that transmits uncompressed digital data and therefore delivers true HD quality.



You can switch the display output by using **Fn+F5**, Windows **Control Panel**, or OSD Control Panel.

# Connecting a USB Device

Your computer has three USB ports (two USB 3.0 ports at the rear and one USB 2.0 port at the right side) for connecting USB devices, such as a digital camera, scanner, printer, modem, and mouse.

USB 3.0 supports a transfer rate up to 5 Gbit/s and USB 2.0 a transfer rate up to 480 MB/s.

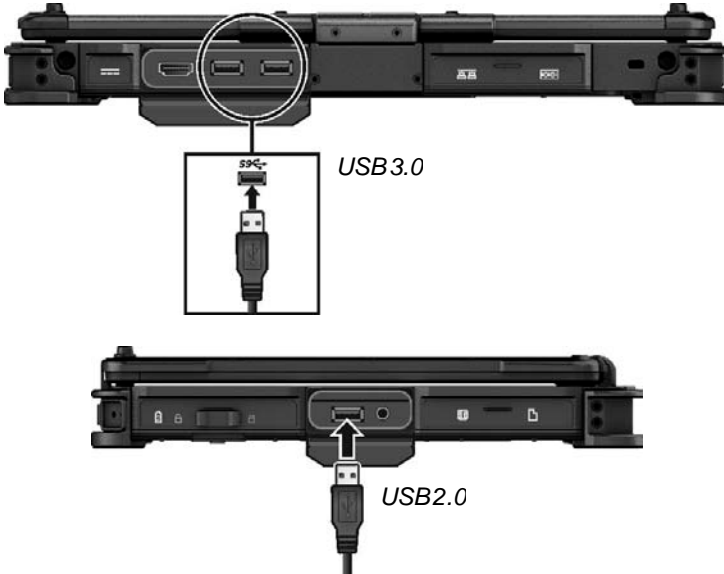



# Connecting a Serial Device

Your computer has a serial port for connecting a serial device such as a serial mouse or serial communication device.



# Connecting an Audio Device

For higher audio quality, you can send sound through an external audio device.

The combo connector is the “4-pole TRRS 3.5mm” type (Apple iPhone Recessed) so you can connect a compatible headset microphone.



**SAFETY WARNING:** 

To prevent possible hearing damage, do not listen at high volume levels for long periods.

# Using Smart Cards

With an embedded microcontroller, smart cards have the unique ability to store large amounts of data, carry out their own on-card functions (e.g., encryption and mutual authentication), and interact intelligently with a smart card reader.

To insert a smart card:

1. Locate the smart card reader. Open its protective cover by lifting up the tab of the cover.
2. Slide the smart card, with its label and embedded computer chip facing up into the slot (the lower one).



3. When closing the cover, push the tab downward until the cover clicks into place.

**NOTE:** An ExpressCard in the lower slot hinders the removal of the smart card. In this case, first remove the ExpressCard so that you can remove the smart card.

To remove a smart card:

1. Make sure that the software is not accessing the smart card.
2. Open the cover.
3. Slightly push the card to release and then pull it out of the slot.
4. Close the cover.

# Using ExpressCards

The ExpressCard slot can accommodate a 54 mm (ExpressCard/54) or 34 mm (ExpressCard/34) wide ExpressCard. Typical ExpressCards support a very extensive range of applications including memory, wired and wireless communication cards, and security devices.

To insert an ExpressCard:

1. Locate the ExpressCard slot. Open its protective cover by lifting up the tab of the cover.
2. Slide the ExpressCard, with its label facing up, all the way into the slot (the upper one) until the rear connectors click into place.



3. When a new card is seated, the computer will detect it and try to install the appropriate driver. Follow the on-screen instructions to complete the process.
4. When closing the cover, push the tab downward until the cover clicks into place.

To remove an ExpressCard:

1. Double-click on the **Safely Remove Hardware**  icon found on the Windows taskbar and the **Safely Remove Hardware** window appears on screen.
2. Select (highlight) the ExpressCard from the list to disable the card.
3. Open the cover.
4. Pull the card out of the slot.
5. Close the cover.

# Using the NFC/RFID Reader (Optional)

If your model has the NFC/RFID reader module, you can read data from NFC (Near Field Communication) and RFID (Radio Frequency Identification) tags.



## NOTE:

For optimal results when reading an NFC/RFID tag, have the tag face the antenna in the same orientation as indicated by the icon on the exterior of the computer. For your model, the icon shows a horizontal position.

When not using an NFC/RFID card, do not leave it within or near the antenna area.

For enhanced applications and customization of the module, contact your authorized Getac dealer.

The NFC reader requires specialized applications. For further information, ask your system administrator.

# Replacing the Hard Disk Drive

1. Turn off the computer and disconnect the AC adapter.
2. Slide the cover latch toward the unlocked position (  ) ( **1** ) and then lift up the tab ( **2** ) to release the cover.

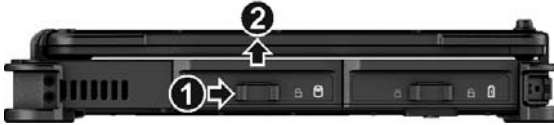

3. Using the ribbon strip, first pull the small latch toward the right to unlock ( **1** ) and then pull the hard disk drive out of the device bay ( **2** ).

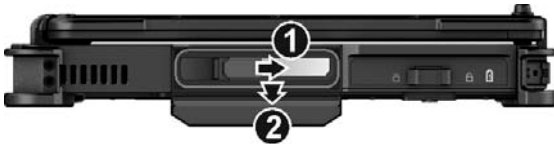

4. Noting the orientation, insert the new hard disk drive all the way into the slot until the small latch clicks into place.
5. When closing the cover, push the tab downward until the cover clicks into place and then slide the latch toward the locked position (  ).

**CAUTION:** Make sure the latch is correctly locked, not revealing the underneath red part.



Correct



Incorrect (revealing red part)

# System Memory Upgrade

You can upgrade your computer by expanding system memory.

## CAUTION:

It is not recommended that you buy and install RAM modules by yourself. If you want to expand system memory, please ask Getac service center to install DRAM modules for you so that full compatibility can be guaranteed.

RAM modules are extremely sensitive to static electricity. There are cases where static electricity generated by the human body has adversely affected such modules. When inserting or removing a RAM module, do not touch the terminals or internal components, insert objects other than the module, or allow foreign particles to enter. Doing so has been known to cause damage, fire, or electrical shock.

To install the RAM module:

1. Disconnect the AC adapter and remove the battery packs.
2. Carefully place the computer upside down.
3. Remove the 8 screws to open the compartment cover.



4. Remove the plastic bar by unfastening two screws.

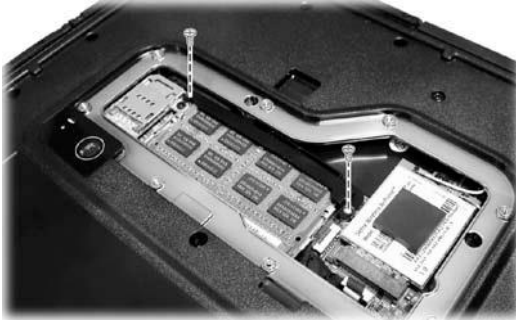

5. To install the RAM module, match the module's notched part with the socket's projected part and firmly insert the module into the socket at a 20-degree angle ( **1** ). Then push down until the retaining clips lock the module into position ( **2** ).

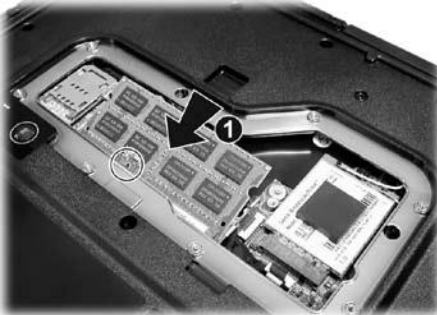

**CAUTION:** If the RAM module is difficult to insert or difficult to push down, do not force it. Check once more to ensure that the module is positioned correctly.

6. Replace the plastic bar and secure with two screws.
7. Close the compartment cover and secure with 8 screws.
8. Replace the battery packs.



# Chapter 5

## *Using BIOS Setup*

BIOS Setup Utility is a program for configuring the BIOS (Basic Input/ Output System) settings of the computer. BIOS is a layer of software, called firmware, that translates instructions from other layers of software into instructions that the computer hardware can understand. The BIOS settings are needed by your computer to identify the types of installed devices and establish special features.

This chapter tells you how to use the BIOS Setup Utility.

# When and How to Use

## NOTE:

The actual setting items on your model may differ from those described in this chapter.

The availability of some setting items depends on the Windows version your computer is running.

You need to run BIOS Setup Utility when:

You see an error message on the screen requesting you to run BIOS Setup Utility.

- You want to restore the factory default BIOS settings.
- You want to modify some specific settings according to the hardware.
- You want to modify specific settings to optimize the system performance.

To run BIOS Setup Utility:

**Method 1:** During system startup when the logo screen appears, click the ~~screen~~ or press the **Windows Logo** button on your Computer. In the pre-boot menu that appears, select **Setup Utility**.

## NOTE:

- If you don't want any accidental tapping to invoke the pre-boot menu, you can disable this method by setting the "**Screen Tapping for Boot Options**" item in the BIOS Setup Utility.  
For Windows 10 models, the time period in which you can use the above method is extremely short. You can use the other method as described below.

**Method 2 (for Windows 10 models only):** Click  → **Settings** → **Update & security** → **Recovery**. Under **Advanced startup**, click **Restart now**. In the boot options menu, click **Troubleshoot** → **Advanced options** → **UEFI Firmware Settings**. Click **Restart**. In the pre-boot menu that appears, select **Setup Utility**.

**Method 2 (for Windows 7 models only):** Press the **F2** key when the prompt appears on the screen during system startup.

# Menu Descriptions

## Information Menu

The Information menu contains the basic configuration information of the system. There are no user-definable items in this menu.

**NOTE:** The “Asset Tag” information appears when you have entered the asset number for this computer using the asset management program. The program is provided in the **Asset tag** folder of the Driver disc.

## Main Menu

The Main menu contains the various system settings.

- **System Date** sets the system date.
- **System Time** sets the system time.
- **OS Select** specifies which version of Windows your computer is running.
- **Boot Priority** determines the boot order between UEFI and legacy devices. If you have a dual boot system, you can select **Legacy First** or **UEFI First** according to your needs.
- **Legacy USB Support** enables or disables the system’s support for Legacy USB.
- **CSM Support** enables or disables CSM (Compatibility Support Mode). You can set this item to **Yes** for backward compatibility with legacy BIOS services.
- **PXE Boot** sets the PXE boot to **UEFI** or **Legacy**. PXE (Preboot eXecution Environment) is an environment to boot computers using a network interface independently of data storage devices or installed operating systems.
- **Internal Numlock** sets if the Num Lock function of the built-in keyboard can work. When set to **Enabled**, you can press **Fn + Num Lock** to activate the numeric keypad, which is embedded in the typewriter keys. When set to **Disabled**, Num Lock does not work. In this case, you can still press **Fn +** a letter key to enter a number.

# Advanced Menu

The Advanced menu contains the advanced settings.

## Wake Up Capability

**Any-key Wake Up From S3 state** allows any key to wake up the system from S3 (Sleep) state.

**USB Wake-Up From S3** allows a USB device activity to wake up the system from S3 (Sleep) state.

**System Policy** allows you to choose between *Performance* and *Balance*. If battery life is your first priority, select *Balance*. If you need system performance more than battery life, select *Performance*.

**AC Initiation** sets if connecting AC power will automatically start or resume the system.

**Screen Tapping for Boot Options** sets if tapping the screen during startup will invoke the boot options menu which provides access to some pre-boot operations. If disabled, tapping the screen during startup has no effect to the system's booting process.

**Active Management Technology Support** (This item appears only on models supporting vPro.)

**Intel AMT Support** enables or disables Intel® Active Management Technology BIOS extension execution. AMT allows the system administrator to access an AMT featured computer remotely.

**Intel AMT Setup Prompt** determines whether the prompt for entering Intel AMT Setup appears or not during POST.

## Virtualization Technology Setup

- **Intel(R) Virtualization Technology** enables or disables Intel® VT (Intel Virtualization Technology) feature which provides hardware support for processor virtualization. When enabled, a VMM (Virtual Machine Monitor) can utilize the additional hardware virtualization capabilities provided by this technology.

**Intel(R) VT for Directed I/O (VT-d)** enables or disables VT-d (Intel® Virtualization Technology for Directed I/O). When enabled, VT-d helps enhance Intel platforms for efficient virtualization of I/O devices.

## Graphics Setup

**DVMT Pre-Allocated** sets the amount of pre-allocated (fixed) graphics memory for use by the internal graphics device.

**Device Configuration** enables or disables several hardware components. The items available for setting depend on your model.

## Security Menu

The Security menu contains the security settings, which safeguard your system against unauthorized use.

### NOTE:

You can set the user password only when the supervisor password has been set.

If both the supervisor and user passwords are set, you can enter any of them for starting up the system and/or entering BIOS Setup. However, the user password only allows you to view/change the settings of certain items.

A password setting is applied right after it is confirmed. To cancel a password, leave the password empty by pressing the **Enter** key.

**Set Supervisor/User Password** sets the supervisor/user password. You can set the supervisor/user password to be required for starting up the system and/or entering BIOS Setup.

**Password on Boot** allows you to enable or disable the entering of password for booting up your system.

**Set HDD 0 User Password** sets the password for locking the Primary Master hard disk drive. After setting a password, the hard disk drive can only be unlocked by the password no matter where it is installed.

### TPM Setup Menu

**TPM Support** enables or disables TPM (Trusted Platform Module) support. TPM (Trusted Platform Module) is a component on your computer's mainboard that is specifically designed to enhance platform security by providing a protected space for key operations and other security critical tasks.

**Change TPM Status** allows you to select between *No Change* and *Clear*.

**Intel Trusted Execution Technology** enables utilization of additional

- hardware capabilities provided by Intel® Trusted Execution Technology.

# Boot Menu

The Boot menu sets the sequence of the devices to be searched for the operating system.

**Boot Type Order** determines the boot order. You can rearrange the order by dragging the boot device name up or down in the list.

Each boot device can be individually set to *On* or *Off*. If you want to exclude a boot device from the boot order, set the device to *Off*.

# Exit Menu

The Exit menu displays ways of exiting BIOS Setup Utility. After finishing with your settings, you must save and exit so that the changes can take effect.

**Exit Saving Changes** saves the changes you have made and exits BIOS Setup Utility.

**Exit Discarding Changes** exits BIOS Setup Utility without saving the changes you have made.

**Load Setup Defaults** loads the factory default values for all the items.

**Discard Changes** restores the previous values for all the items.

**Saves Changes** saves the changes you have made.

# Chapter 6

## *Using Getac Software*

Getac software includes application programs for specific computer components and utility programs for overall management.

This chapter briefly introduces the programs.

# OSD Control Panel

The OSD (On Screen Display) Control Panel provides a user-friendly interface for you to quickly activate or operate certain functions on your computer with a simple click of the screen.

To open the OSD Control Panel, start the program named **OSDC**. If you have a Windows 7 model, you can also press the **Windows Logo** button on your computer to open it. The following screen appears.



For detailed information on the program, see the program's online help.



# G-Manager

G-Manager is a unified user interface utility that allows you to view, manage, or configure your computer features.

With G-Manager, you can perform all or some of the tasks listed below.

- View system information.
- Check the battery status and configure the battery.
- Configure ECO modes (or called power profiles).
- Set the touchscreen sensitivity mode.
- Set if a warning message will appear when a connected docking station is removed unexpectedly.
- Enable the use of external GPS/WWAN/WLAN antenna signal.
- Change the function of the hardware button.
- Configure how your system works with the vehicle ignition.
- Monitor the system.
- View GPS information.

Right-click the Getac Utility icon  located on Windows taskbar and select **G-Manager** to start the program. The G-Manager window appears, containing several tabs.

**NOTE:** Depending on your model, the actual items and information appearing on the screen may differ from those shown in this manual.

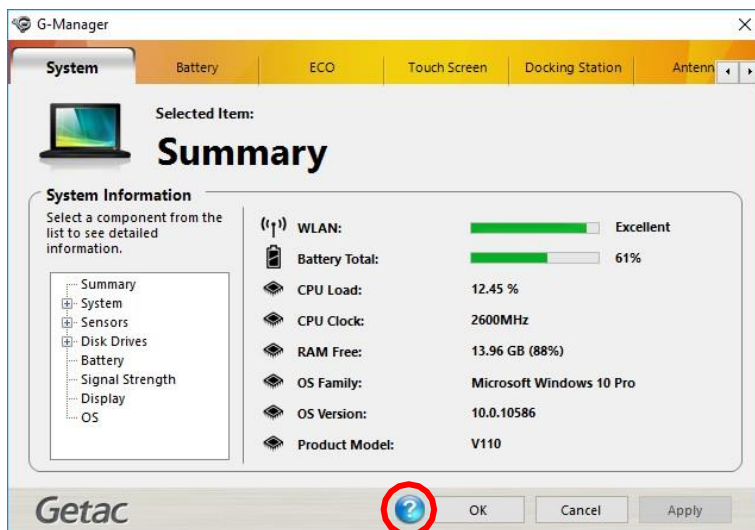

*Help*

For detailed information on the program, see the program's online help.

# Getac Camera (Optional)

## Camera for Windows 10

Start **Getac Camera**. The Getac Camera window appears as shown below.

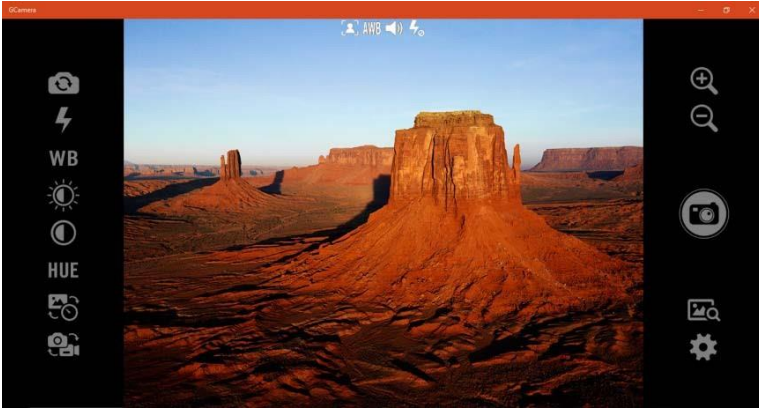

For detailed information on the program, see the program's online help.

# Camera for Windows 7

Getac Camera is a geo-tagging camera program, which allows you to stamp geographical information on photos as watermarks and embed such information into JPEG files as EXIF 2.2 metadata.



**NOTE:** Before starting Getac Camera, close any other program that uses the camera; otherwise, Getac Camera can only provide limited functions.

Start **Getac Camera**. The Getac Camera window appears as shown below.



The GPS positioning will be automatically activated. When the GPS positioning is completed, you will see the geographical information in the watermark area on the image.

For detailed information on the program, see the program's online help.

Click  **About** and then .

# Chapter 7

## *Care and Maintenance*

Taking good care of your computer will ensure a trouble-free operation and reduce the risk of damage to your computer.

This chapter gives you guidelines covering areas such as protecting, storing, cleaning, and traveling.

# Protecting the Computer

To safeguard the integrity of your computer data as well as the computer itself, you can protect the computer in several ways as described in this section.

## Using an Anti-Virus Strategy

You can install a virus-detecting program to monitor potential viruses that could damage your files.

## Using the Cable Lock

You can use a Kensington-type cable lock to protect your computer against theft. The cable lock is available in computer stores.

To use the lock, loop the lock cable around a stationary object such as a table. Insert the lock to the Kensington lock hole and turn the key to secure the lock. Store the key in a safe place.

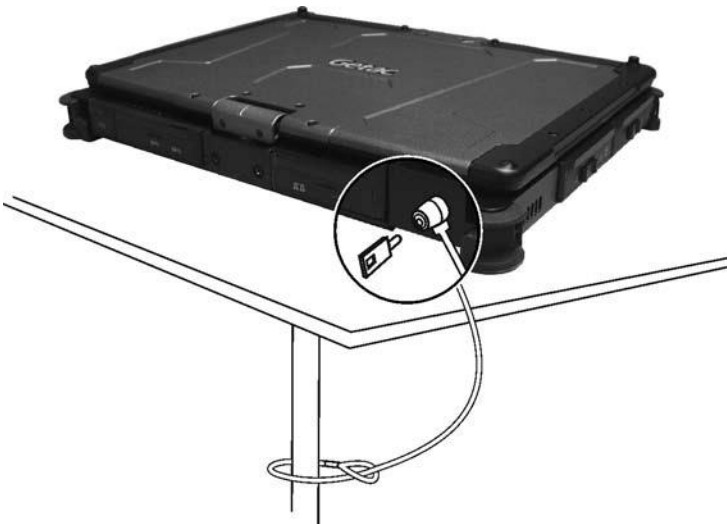

# Taking Care of the Computer

## Location Guidelines

- For optimal performance, use the computer where the recommended temperature is between 0 °C (32 °F) and 55 °C (131 °F). (Actual operating temperature depends on product specifications.)  
Avoid placing the computer in a location subject to high humidity, extreme temperatures, mechanical vibration, direct sunlight, or heavy dust. Using in extreme environments for long periods can result in product deterioration and a shortened product life.
- Operating in an environment with metallic dust is not allowed.  
Place the computer on a flat and steady surface. Do not stand the computer on its side or store it in an upside-down position. A strong impact by dropping or hitting may damage the computer.  
Do not cover or block any ventilation openings on the computer. For example, do not place the computer on a bed, sofa, rug, or other similar surface. Otherwise, overheating may occur that results in damage to the computer.  
As the computer can become very hot during operation, keep it away from objects that are vulnerable to heat.  
Keep the computer at least 13 cm (5 inches) away from electrical appliances that can generate a strong magnetic field such as a TV, refrigerator, motor, or a large audio speaker.
- Avoid moving the computer abruptly from a cold to a warm place. A temperature difference of more than 10 °C (18 °F) may cause condensation inside the unit, which may damage the storage media.

## General Guidelines

Do not place heavy objects on top of the computer as this may damage the display.

Do not move the computer simply by grasping the display screen.

The screen surface is easily scratched. Avoid touching it with a sharp object such as a pen or pencil.

LCD image sticking occurs when a fixed pattern is displayed on the screen for a prolonged period of time. You can avoid the problem by limiting the amount of static content on the display. It is recommended that you use a screen saver or turn off the display when it is not in use.

To maximize the life of the backlight in the display, allow the backlight to automatically turn off as a result of power management.

## Cleaning Guidelines

- Never clean the computer with its power on.  
Use a soft cloth moistened with water or a non-alkaline detergent to wipe the exterior of the computer.
- Gently wipe the display with a soft, lint-free cloth.  
Dust or grease on the touchpad can affect its sensitivity. Clean the pad by using adhesive tape to remove the dust and grease on its surface.  
If water or liquid is split onto the computer, wipe it dry and clean when possible. Though your computer is water-proof, do not leave the computer wet when you can dry it.
- If the computer gets wet where the temperature is 0°C (32°F) or below, freeze damage may occur. Make sure to dry the wet computer.

## Battery Pack Guidelines

Recharge the battery pack when it is nearly discharged. When recharging, make sure that the battery pack is fully charged. Doing so may avoid harm to the battery pack.

The battery pack is a consumable product and the following conditions will shorten its life:

- when frequently charging the battery pack
- when using, charging, or storing the battery in high temperature condition



To avoid hastening the deterioration of the battery pack thereby prolonging its useful life, minimize the number of times you charge it so as not to frequently increase its internal temperature.

- Charge the battery pack between 10 °C ~ 30 °C (50 °F ~ 86 °F) temperature range. A higher environment temperature will cause the battery pack's temperature to rise. Avoid charging the battery pack inside a closed vehicle and in hot weather condition. Also, charging will not start if the battery pack is not within the allowed temperature range. It is recommended that you do not charge the battery pack more than once a day.

It is recommended that you charge the battery pack with the computer's power off.

To maintain the battery pack's operating efficiency, store it in a cool dark place removed from the computer and with 30 % ~ 40 % charge remaining.

Important guidelines when using the battery pack.

When installing or removing the battery pack take note of the following:

- avoid installing or removing the battery pack when the computer is in Sleep mode. Abruptly removing the battery pack may cause loss of data or the computer may become unstable.
- avoid touching the battery pack terminals or damage may occur, thereby causing improper operation to it or the computer.

The computer's input voltage and surrounding temperature will directly affect the battery pack's charge and discharge time:

- charging time will be prolonged when the computer is turned on. To shorten the charging time, it is recommended that you place the computer in Sleep or hibernation mode.
- a low temperature will prolong the charging time as well as hasten the discharge time.

When using battery power in an extremely low temperature environment, you may experience shortened operating time and incorrect battery level reading. This phenomenon comes from the chemical characteristics of batteries. The appropriate operating temperature for the battery is -10 °C ~ 50 °C (14 °F ~ 122 °F).

Do not leave the battery pack in storage for more than six months without recharging it.

# Touchscreen Guidelines

Use your finger or the stylus (if purchased) on the display. Using a sharp or metallic object other than your finger or stylus may cause scratches and damage the display, thereby causing errors.

Use a soft cloth to remove dirt on the display. The touchscreen surface has a special protective coating that prevents dirt from sticking to it. Not using a soft cloth may cause damage to the special protective coating on the touchscreen surface.

Turn off the computer power when cleaning the display. Cleaning the display with the power on may cause improper operation.

Do not use excessive force on the display. Avoid placing objects on top of the display as this may cause the glass to break thereby damaging the display.

- Using the touchscreen during low temperature (below 5 °C / 41 °F) may cause a slower response time, this is normal. A normal response time may be restored upon returning to room temperature. When there is noticeable discrepancy in the operation of the touchscreen function (wrong location on intended operation or improper display resolution), refer to the Windows online Help for instructions on recalibrating the touchscreen display.

# When Traveling

Before traveling with your computer, make a backup of your hard disk data into flash disks or other storage devices. As an added precaution, bring along an extra copy of your important data.

- Make sure that the battery pack is fully charged.  
Make sure that the computer is turned off and the top cover is securely closed.  
Make sure that all the connector covers are closed completely to ensure the waterproof integrity.
- Do not leave objects in between the keyboard and closed display.  
Disconnect the AC adapter from the computer and take it with you. Use the AC adapter as the power source and as a battery-charger.
- Hand-carry the computer. Do not check it in as luggage.  
If you need to leave the computer in the car, put it in the trunk of the car to avoid exposing the computer to excessive heat.

When going through airport security, it is recommended that you send the computer and flash disks through the X-ray machine (the device you set your bags on). Avoid the magnetic detector (the device you walk through) or the magnetic wand (the handheld device used by security personnel).

If you plan to travel abroad with your computer, consult your dealer for the appropriate AC power cord for use in your country of destination.

# Chapter 8

## *Troubleshooting*

Computer problems can be caused by hardware, software, or both. When you encounter any problem, it might be a typical problem that can easily be solved.

This chapter tells you what actions to take when solving common computer problems.

# Preliminary Checklist

Here are helpful hints to follow before you take further actions when you encounter any problem:

- Try to isolate which part of the computer is causing the problem.  
Make sure that you turn on all peripheral devices before turning on the computer.  
If an external device has a problem, make sure that the cable connections are correct and secure.  
Make sure that the configuration information is properly set in the BIOS Setup program.
- Make sure that all the device drivers are correctly installed.  
Make notes of your observations. Are there any messages on the screen? Do any indicators light? Do you hear any beeps? Detailed descriptions are useful to the service personnel when you need to consult one for assistance.

If any problem persists after you follow the instructions in this chapter, contact an authorized dealer for help.

# Solving Common Problems

## Battery Problems

**The battery does not charge (Battery Charge indicator does not light amber).**

- Make sure that the AC adapter is properly connected.  
Make sure that the battery is not too hot or cold. Allow time for the battery pack to return to room temperature.  
If the battery doesn't charge after it has been stored in very low temperatures, try disconnecting and reconnecting the AC adapter to solve the problem.
- Make sure that the battery pack is installed correctly.
- Make sure that the battery terminals are clean.

**The operating time of a fully charged battery becomes shorter.**

If you often partially recharge and discharge, the battery might not be charged to its full potential. Initialize the battery to solve the problem.

**The battery operating time indicated by the battery meter does not match the actual operating time.**

The actual operating time can be different from the estimated time, depending on how you are using the computer. If the actual operating time is much less than the estimated time, initialize the battery.

## BT Problems

**I cannot connect to another device with BT wireless technology.**

- Make sure that both devices have activated BT feature.  
Make sure that the distance between the two devices is within the limit and that there are no walls or other obstructions between the devices.
- Make sure that the other device is not in “Hidden” mode.  
Make sure that both devices are compatible.

# Display Problems

## **Nothing appears on the screen.**

During operation, the screen may automatically turn off as a result of power management. Press any key to see if the screen comes back.

- The brightness level might be too low. Increase the brightness.  
The display output might be set to an external device. To switch the display back to the LCD, press the **Fn+F5** hot key or change the display through the **Display Settings** Properties.

## **The characters on the screen are dim.**

- Adjust the brightness and/or contrast.

## **The display brightness cannot be increased.**

As a protection, the display brightness will be fixed at a low level when the surrounding temperature is too high or too low. It is not a malfunction in this situation.

## **Bad dots appear on the display at all times.**

A small number of missing, discolored, or bright dots on the screen are an intrinsic characteristic of TFT LCD technology. It is not regarded as a LCD defect.

## **Clouding (or called “mura”) happens on the screen when you exert forces on the left or right side of the LCD frame.**

- This is a normal phenomenon, not a defect.

# Hardware Device Problems

## **The computer does not recognize a newly installed device.**

The device may not be correctly configured in the BIOS Setup program.

Run the BIOS Setup program to identify the new type.

Make sure if any device driver needs to be installed. (Refer to the documentation that came with the device.)

Make sure if the device needs any jumper or switch settings. (Refer to the documentation that came with the device.)

- Check the cables or power cords for correct connections.  
For an external device that has its own power switch, make sure that the power is turned on.

## Keyboard and Touchpad Problems

### **The keyboard does not respond.**

Try connecting an external keyboard. If it works, contact an authorized dealer, as the internal keyboard cable might be loose.

### **Water or liquid is spilt into the keyboard.**

Immediately turn off the computer and unplug the AC adapter. Then turn the keyboard upside down to drain the liquid out of the keyboard. Make sure to clean up any part of the spill you can get to. Though the keyboard of your computer is spill-proof, liquid will remain in the keyboard enclosure if you don't remove it. Wait for the keyboard to air dry before using the computer again.

### **The touchpad does not work, or the pointer is difficult to control with the touchpad.**

- Make sure that the touchpad is clean.

## LAN Problems

### **I cannot access the network.**

Make sure that the LAN cable is properly connected to the RJ-45 connector and the network hub.

Make sure that the network configuration is appropriate.

Make sure that the user name or password is correct.



# Power Management Problems

## **The computer does not enter Sleep or Hibernation mode automatically.**

If you have a connection to another computer, the computer does not enter Sleep or Hibernation mode if the connection is actively in use.

- Make sure that the Sleep or Hibernation time-out is enabled.

## **The computer does not enter Sleep or Hibernation mode immediately.**

If the computer is performing an operation, it normally waits for the operation to finish.

## **The computer does not resume from Sleep or Hibernation mode.**

The computer automatically enters Sleep or Hibernation mode when the battery pack is empty. Do any one of the following:

- Connect the AC adapter to the computer.
- Replace the empty battery pack with a fully charged one.

# Sensor Problems (for Windows 10 Models Only)

## **The built-in digital compass doesn't seem to be accurate.**

Rotating the display can affect the accuracy of the digital compass. This is normal, not a malfunction. The sensors for the compass require periodic recalibration. Follow this method to recalibrate the sensors:

1. Make sure you are far away from any large metal objects or magnetic fields.
2. Start an application that utilizes the digital compass.
3. Hold the computer level with the horizon, with the LCD side facing up.
4. Rotate the computer 360° at least three times around each axis (X, Y, and Z) as shown below.



## Software Problems

### **An application program does not work correctly.**

- Make sure that the software is correctly installed.  
If an error message appears on the screen, consult the software
- program's documentation for further information.
- If you are sure the operation has stop, reset the computer.

## Sound Problems

### **No sound is produced.**

Make sure that the volume control is not set too low. Increase the volume.

- Make sure that the sound is not muted.
- Make sure that the computer is not in Sleep mode.  
If using an external speaker, make sure that the speaker is properly connected.

**Distorted sound is produced.**

Make sure that the volume control is not set too high or too low. In most cases, a high setting can cause the audio electronics to distort the sound.

## Startup Problems

**When you turn on the computer, it does not respond and the Power Indicator does not light green.**

If you are using an external AC power, make sure that the AC adapter is correctly and securely connected. If so, make sure that the electrical outlet works properly.

If you are using the battery power, make sure that the battery is not discharged.

- When the ambient temperature is below -20 °C (-4 °F), the computer will start up only if both battery packs are installed.

**When you turn on the computer, it stops after POST.**

- Reset your computer.

## WLAN Problems

**I cannot use the WLAN feature.**

- Make sure that the WLAN feature is turned on.

**Transmission quality is poor.**

Your computer may be in an out-of-range situation. Move your computer closer to the Access Point or another WLAN device it is associated with.

Check if there is high interference around the environment and solve the problem as described next.

**Radio interference exists.**

Move your computer away from the device causing the radio interference such as microwave oven and large metal objects.

Plug your computer into an outlet on a different branch circuit from that used by the affecting device.

- Consult your dealer or an experienced radio technician for help.

**I cannot connect to another WLAN device.**

- Make sure that the WLAN feature is turned on.  
Make sure that the SSID setting is the same for every WLAN device in the network.
- Your computer is not recognizing changes. Restart the computer.
- Make sure that the IP address or subnet mask setting is correct.

**I cannot communicate with the computer in the network when Infrastructure mode is configured.**

Make sure that the Access Point your computer is associated with is powered on and all the LEDs are working properly.

If the operating radio channel is in poor quality, change the Access Point and all the wireless station(s) within the BSSID to another radio channel.

Your computer may be in an out-of-range situation. Move your computer closer to the Access Point it is associated with.

Make sure that your computer is configured with the same security option (encryption) to the Access Point.

Use the Web Manager/Telnet of the Access Point to check whether it is connected to the network.

Reconfigure and reset the Access Point.

**I cannot access the network.**

Make sure that the network configuration is appropriate.

Make sure that the user name or password is correct.

You have moved out of range of the network.

- Turn off power management.

## Other Problems

### **The date/time is incorrect.**

Correct the date and time via the operating system or BIOS Setup program.

After you have performed everything as described above and still have the incorrect date and time every time you turn on the computer, the RTC (Real-Time Clock) battery is at the end of its life. Call an authorized dealer to replace the RTC battery.

# Resetting the Computer

You may have to reset (reboot) your computer on some occasions when an error occurs and the program you are using hangs up.

If you are sure the operation has stopped and you cannot use the “restart” function of the operating system, reset the computer.

Reset the computer by any one of these methods:

Press **Ctrl+Alt+Del** on the keyboard. This opens the **Ctrl-Alt-Del** screen where you can select actions including **Restart**.

Press and hold the **P1** button for more than 2 seconds. This opens the **Ctrl-Alt-Del** screen where you can select actions including **Restart**.

If the above action does not work, press and hold the power button for more than 5 seconds to force the system to turn off. Then turn on the power again.

# System Recovery

## System Restore, Recovery, or Reset (for Windows 10 Models)

Click  → **Settings** → **Update & security**. You have several options.

### **System Restore**

This option allows you to restore Windows to an earlier point in time if you have created a restore point.

### **Recover from a drive**

If you have created a recovery drive on Windows 10, you can use the recovery drive to reinstall Windows

### **Reset this PC**

This option allows you to reinstall Windows with or without keeping your files.

See Microsoft website for more information.

**NOTE:** System recovery for Windows 10 typically will take several hours to complete.

## System Recovery (a Tool for Windows 7 Models)

Use System Recovery when:

The Windows 7 operating system does not start at all.

You want to restore the system to the factory state.

### **WARNING:**

- Using this feature will reinstall Windows to your system and configure it to the system's factory default settings. All data on the hard disk drive will be lost.  
Make sure that power is not interrupted during the recovery process. An unsuccessful recovery may result in Windows startup problems.

To run System Recovery:

1. Connect the AC adapter.

- Turn on the computer. During system startup when the following screen appears, press **Ctrl + Alt + F2** keys for four second.
- In the screen that appears, select **Recovery** to start the recovery process.



- The progress bar shows the percentage completed. When it reaches 100%, the system turns off.
- Turn on the computer. The Windows setup wizard starts. Follow the onscreen prompts to continue.
- When the system restarts, the installer screen appears. The installer will perform system hardware detection and driver installation.



- When completed, the system restarts and displays Windows desktop.



# Using the Driver Disc (Optional)

**NOTE:** You can download the latest drivers and utilities from Getac website at <http://www.getac.com> → **Support**.

The Driver disc contains drivers and utilities required for specific hardware in your computer.

Since your computer comes with drivers and utilities pre-installed, you normally do not need to use the Driver disc. In case you want to manually install Windows, you will have to install the drivers and utilities one by one after installing Windows.

To manually install drivers and utilities:

1. Start up the computer.
2. Prepare an external CD/DVD drive (with USB connection). Connect the drive to your computer. Wait for the computer to recognize the drive.
3. Insert the Driver disc. Make sure you use the disc that matches the Windows version of your computer.
4. The autorun program should automatically start. You will see the installation menu. Click **NEXT** to go to the next page if there is more than one.
5. To install a driver or utility, just click the particular button and follow the onscreen instructions to complete the installation.

# Appendix A

## Specifications

**NOTE:** Specifications are subject to change without any prior notice.

Parts		Specifications
CPU		Skylake Platform <ul style="list-style-type: none"> <li>- Intel® Core™ i7-6500U Processor, 2.5GHz, up to 3.1GHz 4M cache</li> <li>- Intel® Core™ i5-6200U Processor, 2.3GHz, up to 2.8GHz 3M cache</li> <li>- Option: Intel® Core™ i5-6300U vPro™ Processor, 2.4GHz, up to 3.0GHz 3M cache</li> <li>- Option: Intel® Core™ i7-6600U vPro™ Processor, 2.6GHz, up to 3.4GHz 4M cache</li> </ul>
BIOS		Insyde, Flash EEPROM, 16MB, supporting ACPI, TPM, vPro, NIST, Computrace, and HDD Security Erasure
RAM		4GB/8GB DDR4 2133MHz, SO-DIMM slot x 2
Video	Controller	UMA - Intel® HD Graphics 520
	Display Panel	11.6-inch (16:9) TFT LCD, HD 1366x768, dimmer mode, blackout mode, sunlight readable, 800 Nits maximum brightness
Touchscreen		Capacitive multi-touch screen - 10 point
Audio	Features	Azalia, High Definition audio
	Speaker	1.5W x 2
	Microphone	Integrated
Keyboard		Standard keys with numeric pad keys, 12 function keys, special <b>Fn</b> (Function) key and Windows keys, with water-proof membrane or backlight (option)
Pointing device		ClickPad, glide touchpad with multi-touch feature, capacitive type
Hard disk drive		128/256/512 GB SSD (Solid-State Disk)

Parts		Specifications
Card slots		ExpressCard/54 Smart Card
I/O ports		USB 3.0 x 2, USB 2.0, RS232, HDMI, combo audio (4-pole TRRS 3.5mm type), RJ-45, Docking
LAN		Intel® i219-LM Gigabit Network Connection, 10/100/1000 Mbps Ethernet
Wireless LAN + BT		Intel 8260NGW 2x2 802.11 AC + BT combo, BT 4.2 class1+ EDR
GPS (option)		Internal UART
WWAN (option)		Sierra EM7355 / EM7305, 3G/4G LTE
Camera (option)		Front: FHD 2MP Rear: 8M pixel, autofocus, LED, video capture
RFID Reader (option)		Contactless, UART, supporting ISO14443A/B and 15693
Security		Kensington lock TPM 2.0 Fingerprint scanner (option)
Power	AC adapter	Universal 65 W; input: 100~240 V, 50/60 Hz; output: 19V
	Battery pack x 2	Lithium-ion Prismatic type, 3-cell
Dimension (LxWxD)		299 x 223 x 34mm (11.77 x 8.78 x 1.34 inch)
Weight		1.98 kg (4.36 lb)

# Appendix B

## *Regulatory Information*

This appendix provides regulatory statements and safety notices on your computer.

**NOTE:** Marking labels located on the exterior of your computer indicate the regulations that your model complies with. Please check the marking labels and refer to the corresponding statements in this appendix. Some notices apply to specific models only.

# On the Use of the System

## Class B Regulations

### USA

#### Federal Communications Commission Radio Frequency Interference Statement

##### NOTE:

This equipment has been tested and found to comply with the limits for a Class B digital device pursuant to Part 15 of the FCC Rules. These limits are designed to provide reasonable protection against harmful interference in a residential installation. This equipment generates, uses, and can radiate radio frequency energy and, if not installed and used in accordance with the instructions, may cause harmful interference to radio communications. However, there is no guarantee that interference will not occur in a particular installation. If this equipment does cause harmful interference to radio or television reception, which can be determined by turning the equipment off and on, the user is encouraged to try to correct the interference by one or more of the following measures:

- Reorient or relocate the receiving antenna.
- Increase the separation between the equipment and receiver.
- Connect the equipment into an outlet on a circuit different from that to which the receiver is connected.

Consult the dealer or an experienced radio/TV technician for help.

Any changes or modifications not expressly approved by the manufacturer could void the user's authority to operate the equipment.

##### Please note:

The use of a non-shielded interface cable with this equipment is prohibited.

This device complies with FCC radiation exposure limits set forth for an uncontrolled environment.

# Canada

## Canadian Department of Communications Radio Interference Regulations Class B Compliance Notice

This Class B digital apparatus meets all requirements of the Canada Interference-Causing equipment regulations.

Cet appareil numérique de Classe B respecte toutes les exigences du Règlement Canadien sur le matériel brouilleur.

This digital apparatus does not exceed the Class B limits for radio noise emissions from digital apparatus set out in the Radio Interference Regulations of the Canadian Department of Communications.

Le présent appareil numérique n'émet pas de bruits radioélectriques dépassant les limites applicables aux appareils numériques de la classe B prescrites dans le Règlement sur le brouillage radioélectrique édicté par le ministère des Communications du Canada.

## ANSI Warning

Equipment approved for ANSI/ISA 12.12.01, Nonincendive Electrical Equipment for use in Class 1, Division 2, Group A, B, C, and D.

Maximum ambient temperature: 40°C

**WARNING:** To prevent ignition of a hazardous atmosphere, batteries must only be changed or charged in an area known to be non-hazardous.

**EXPLOSION HAZARD WARNING:** External connections/hubs through the connectors as mentioned (USB connector, Ethernet connector, phone connector, video port, serial port, power supply connector, microphone jack, headphones jack, and buttons/switches) and super multi DVD/combo drive are not to be used in a hazardous location.

Power adapter shall not be used in hazardous locations.

# Safety Notices

## About the Battery

### Caution Texts Concerning Lithium Batteries

#### **DANISH**

ADVARSEL! Lithiumbatteri – Eksplosionsfare ved fejlagtig håndtering. Udskiftning må kun ske med batteri af samme fabrikat og type. Levér det brugte batteri tilbage til leverandøren.

#### **NORWEGIAN**

ADVARSEL: Eksplosjonsfare ved feilaktig skifte av batteri. Benytt samme batteritype eller en tilsvarende type anbefalt av apparatfabrikanten. Brukte batterier kasseres i henhold til fabrikantens instruksjoner.

#### **SWEDISH**

VARNING: Explosionsfara vid felaktigt batteribyte. Använd samma batterityp eller en ekvivalent typ som rekommenderas av apparattillverkaren. Kassera använt batteri enligt fabrikantens instruktion.

#### **FINNISH**

VAROITUS: Paristo voi räjähtää, jos se on virheellisesti asennettu. Vaihda paristo ainoastaan valmistajan suosittelemaan tyyppiin. Hävitä käytetty paristo valmistajan ohjeiden mukaisesti.

#### **ENGLISH**

CAUTION: Danger of explosion if battery is incorrectly replaced. Replace only with the same or equivalent type recommended by the equipment manufacturer. Discard used batteries according to manufacturer's instructions.

#### **DEUTSCH**

VORSICHT: Explosionsgefahr bei unsachgemäßem Austausch der Batterie. Ersatz nur durch denselben oder einen vom Hersteller empfohlenen gleich-wertigen Typ. Entsorgung gebrauchter Batterien nach Angaben des Herstellers.

#### **FRENCH**

ATTENTION: Il y a danger d'explosion s'il y a un remplacement incorrect de la batterie. Remplacer uniquement avec une batterie du même type ou d'un type équivalent recommandé par le constructeur. Mettre au rebut les batteries usagées conformément aux instructions du fabricant.

## **Attention (for USA Users)**

The product that you have purchased contains a rechargeable battery. The battery is recyclable. At the end of its useful life, under various state and local laws, it may be illegal to dispose of this battery into the municipal waste stream. Check with your local solid waste officials for details in your area for recycling options or proper disposal.

## **About the AC Adapter**

Use only the AC adapter supplied with your computer. Use of another type of AC adapter will result in malfunction and/or danger.

Do not use the adapter in a high moisture environment. Never touch the adapter when your hands or feet are wet.

Allow adequate ventilation around the adapter when using it to operate the device or charge the battery. Do not cover the AC adapter with paper or other objects that will reduce cooling. Do not use the AC adapter while it is inside a carrying case.

Connect the adapter to a proper power source. The voltage requirements are found on the product case and/or packaging.

- Do not use the adapter if the cord becomes damaged.
- Do not attempt to service the unit. There are no serviceable parts inside.
- Replace the unit if it is damaged or exposed to excess moisture.



# On the Use of the RF Device

## USA and Canada Safety Requirements and Notices

### Radio Frequency Interference Requirements and SAR

This device meets the government's requirements for exposure to radio waves.

This device is designed and manufactured not to exceed the emission limits for exposure to radio frequency (RF) energy set by the Federal Communications Commission of the U.S. Government.

### EMC Requirements

This device uses, generates and radiates radio frequency energy. The radio frequency energy produced by this device is well below the maximum exposure allowed by the Federal Communications Commission (FCC).

This device complies with the limits for a Class B digital device pursuant to Part 15 subpart C of the FCC Rules and Regulations. Operation is subject to the following two conditions:

- (1) This device may not cause harmful interference.
- (2) This device must accept any interference received, including interference that may cause undesired operation.

The FCC limits are designed to provide reasonable protection against harmful interference when the equipment is installed and used in accordance with the instruction manual and operated in a commercial environment. However, there is no guarantee that interference will not occur in a particular commercial installation, or if operated in a residential area.

If harmful interference with radio or television reception occurs when the device is turned on, the user must correct the situation at the user's own expense. The user is encouraged to try one or more of the following corrective measures:

- Reorient or relocate the receiving antenna.
- Increase the separation between the equipment and receiver.
  - Connect the equipment into an outlet on a circuit different from that to which the receiver is connected.
- Consult the dealer or an experienced radio/TV technician for help.

**CAUTION:** The Part 15 radio device operates on a non-interference basis with other devices operating at this frequency. Any changes or modification to said product not expressly approved by the manufacturer could void the user's authority to operate this device.

## Canada Radio Frequency Interference Requirements

To prevent radio interference to the licensed service, this device is intended to be operated indoors and away from windows to provide maximum shielding. Equipment (or its transmit antenna) that is installed outdoors is subject to licensing.

Pour empêcher que cet appareil cause du brouillage au service faisant l'objet d'une licence, il doit être utilisé à l'intérieur et devrait être placé loin des fenêtres afin de fournir un écran de blindage maximal. Si le matériel (ou son antenne d'émission) est installé à l'extérieur, il doit faire l'objet d'une licence.

## European Union CE Marking and Compliance Notices

### Statements of Compliance

#### English

This product follows the provisions of the European Directive 1999/5/EC.

#### Danish

Dette produkt er i overensstemmelse med det europæiske direktiv 1999/5/EC.

**Dutch**

Dit product is in navolging van de bepalingen van Europees Directief 1999/5/EC.

**Finnish**

Tämä tuote noudattaa EU-direktiivin 1999/5/EC määräyksiä.

**French**

Ce produit est conforme aux exigences de la Directive Européenne 1999/5/EC.

**German**

Dieses Produkt entspricht den Bestimmungen der Europäischen Richtlinie 1999/5/EC.

**Greek**

Το προϊόν αυτό πληροί τις προβλέψεις της Ευρωπαϊκής Οδηγίας 1999/5/EC.

**Icelandic**

Þessi vara stenst reglugerð Evrópska Efnahags Bandalagsins númer 1999/5/EC.

**Italian**

Questo prodotto è conforme alla Direttiva Europea 1999/5/EC.

**Norwegian**

Dette produktet er i henhold til bestemmelsene i det europeiske direktivet 1999/5/EC.

**Portuguese**

Este produto cumpre com as normas da Diretiva Europeia 1999/5/EC.

**Spanish**

Este producto cumple con las normas del Directivo Europeo 1999/5/EC.

**Swedish**

Denna produkt har tillverkats i enlighet med EG-direktiv 1999/5/EC.

**Restrictions**

This device is restricted to indoor use when operating in the 5150 to 5350 MHz frequency range.

# User Notification of Take-back Service

To Institutional (B2B) Users in United States:

Getac believes in providing our institutional customers with easy-to-use solutions to recycle your Getac-brand products for free. Getac understands the institutional customers will likely be recycling multiple items at once and as such. Getac wants to make the recycling process for these larger shipments as streamlined as possible. Getac works with recycling vendors with the highest standards for protecting our environment, ensuring worker safety, and complying with global environmental laws. Our commitment to recycling our old equipment grows out of our work to protect the environment in many ways.

Please see the product type below for information on Getac product, battery and packaging recycling in USA.

## **For Product Recycling:**

Your portable Getac products contain hazardous materials. While they pose no risk to you during normal use, they should never be disposed with other wastes. Getac provides a free take-back service for recycling your Getac products. Our electronics recycler will provide competitive bids for recycling non-Getac products as well.

## **For Battery Recycling:**

The batteries used to power your portable Getac products contain hazardous materials. While they pose no risk to you during normal use, they should never be disposed with other wastes. Getac provides a free take-back service for recycling your batteries from Getac products.

## **For Packaging Recycling:**

Getac has chosen the packaging materials used to transport our products carefully, to balance the requirements of shipping the product to you safely while minimizing the amount of material used. The materials used in our packaging are designed to be recycled locally.

If you have the above for recycling, please contact our recycler, All Green Electronics Recycling, LLC. For more information on recycling, visit the website <http://www.allgreenrecycling.com>.

# ENERGY STAR 6.1



ENERGY STAR<sup>®</sup> is a government program that offers businesses and consumers energy-efficient solutions, making it easy to save money while protecting the environment for future generations.

Please reference ENERGY STAR<sup>®</sup> related information from <http://www.energystar.gov>.

As an ENERGY STAR<sup>®</sup> Partner, Getac Technology Corporation has determined that this product meets the ENERGY STAR<sup>®</sup> guidelines for energy efficiency.

An ENERGY STAR<sup>®</sup> qualified computer uses 70 % less electricity than computers without enabled power management features.

## Earning the ENERGY STAR<sup>®</sup>

- When every home office is powered by equipment that has earned the ENERGY STAR<sup>®</sup>, the change will keep over 289 billion pounds of greenhouse gases out of the air.

If left inactive, ENERGY STAR<sup>®</sup> qualified computers enter a low-power mode and may use 15 watts or less. New chip technologies make power management features more reliable, dependable, and user-friendly than even just a few years ago.

Spending a large portion of time in low-power mode not only saves energy, but helps equipment run cooler and last longer.

Businesses that use ENERGY STAR<sup>®</sup> enabled office equipment may realize additional savings on air conditioning and maintenance.

Over its lifetime, ENERGY STAR® qualified equipment in a single home office (e.g., computer, monitor, printer, and fax) can save enough electricity to light an entire home for more than 4 years.

Power management (“sleep settings”) on computers and monitors can result in much savings annually.

## Remember, saving energy prevents pollution

Because most computer equipment is left on 24 hours a day, power management features are important for saving energy and are an easy way to reduce air pollution. By using less energy, these products help lower consumers’ utility bills, and prevent greenhouse gas emissions.

## Getac Product Compliance

All Getac products with ENERGY STAR® logo comply with the ENERGY STAR® standard, and the power management feature is enabled by default. As recommended by the ENERGY STAR® program for optimal energy savings, the computer is automatically set to sleep after 15 minutes (in battery mode) and 30 minutes (in AC mode) of user inactivity. To wake up the computer, press the power button.

If you want to configure power management settings such as inactivity time and ways to initiate/end Sleep mode, go to **Power Options** by right-clicking the battery icon on the Windows taskbar and then selecting **Power Options** in the pop-up menu.

Please visit <http://www.energystar.gov/powermanagement> for detail information environment.

# Battery Recycling

For the U.S. and Canada only:

To recycle the battery, please go to the RBRC Call2Recycle website or use the Call2Recycle Helpline at 800-822-8837.

Call2Recycle® is a product stewardship program providing no-cost battery and cellphone recycling solutions across the U.S. and Canada. Operated by Call2Recycle, Inc., a 501(c)4 nonprofit public service organization, the program is funded by battery and product manufacturers committed to responsible recycling. See more at: <http://www.call2recycle.org>

