

Getac

MX50
USER MANUAL

Rugged Mobile Computing Solution

September 2016

Trademarks

Google and Android are trademarks of Google Inc.

The Bluetooth word mark and logos are owned by the Bluetooth SIG, Inc.

All other brand and product names are trademarks or registered trademarks of their respective companies.

Disclaimer

Specifications and manuals are subject to change without notice. Getac assumes no liability for damage incurred directly or indirectly from errors, omissions, or discrepancies between the device and the manuals.

Notes

Depending on the specific model purchased, the color and look of your device and accessories may not exactly match the graphics shown in this document.

The screenshots and other presentations shown in this document are for reference only. They may differ from the actual screens and presentations generated by the actual product.

Your device is based on Google's Android 5.1.1 operating system, with additions by Getac.

For the latest version of the manual, please visit the Getac website at www.getac.com.

Table of Contents

Chapter 1	Getting Started.....	1
	Identifying Hardware Components	1
	Front Components.....	1
	Back Components	2
	Top Components.....	3
	Right-Side Components.....	4
	Getting Your Device Ready for Use	5
	Connecting to AC Power and Charging the Battery	5
	Performing the Initial Startup	6
	Using the Chest Mount.....	7
Chapter 2	Basic Skills.....	9
	Sleeping and Shutting Down	9
	Navigating on the Screen	9
	Home Screen	10
	Extensions to the Home Screen	11
	Customizing Your Home Screen	11
	Using Applications	12
	Navigation Bar	12
	Status Bar and Notifications Panel	13
	Quick Settings	13
	Entering Information.....	14
Chapter 3	Getting Connected	15
	Wireless Connections	15
	Using Wi-Fi Networks.....	15
	Using the Bluetooth Function.....	16
	External Connections	17
	Using a MicroSD Card.....	17
	Connecting an Audio Device	18
	Connecting to a Computer via USB.....	19

Chapter 4	Android Preinstalled Applications	20
	Google Applications Overview.....	20
	Camera.....	22
	Taking Pictures.....	22
	Taking Panoramic Pictures	23
	Shooting Videos.....	23
Chapter 5	Getac Applications	25
	File Manager	25
	Button Descriptions	25
	Opening a File.....	26
	GPS-ECompass	27
	Satellite Position	27
	Electronic Compass.....	28
	Location Information	29
	Settings.....	29
	GPS Logging.....	30
Chapter 6	Managing Your Device	31
	Managing Power.....	31
	Low Battery Signals and Actions	31
	Power-Saving Tips.....	32
	Settings.....	33
	Wireless and Networks Settings	33
	Device Settings.....	34
	Personal Settings	35
	System Settings	35
Chapter 7	Care and Maintenance	36
	Resetting Your Device	36
	Caring for Your Device	36
Chapter 8	Regulatory Information	38
	Regulations Statements.....	38
	USA Class B Regulations	38
	European Union CE Marking and Compliance Notices.....	39
	Safety Precautions.....	40
	About Charging	40
	About the AC Adapter	41

Chapter 1

Getting Started

This chapter introduces you to the external components of your device and guides you through the process of setting up your device for use.

Identifying Hardware Components

Front Components

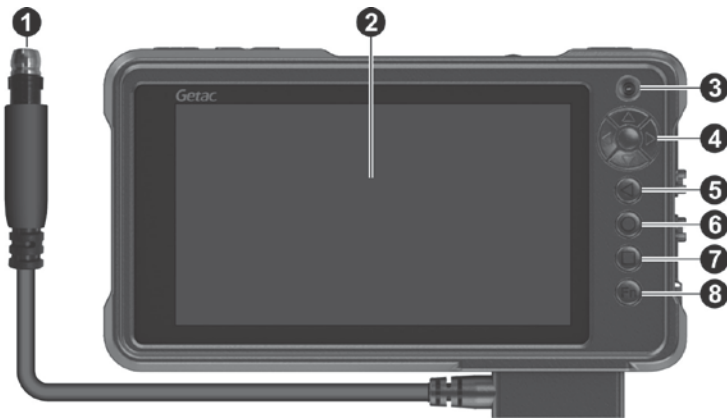

Ref	Component	Description
①	Power connector	Connects to an external power source.
②	Touch screen	Displays the output of your device and responds to your touching.
③	Camera lens	Takes still pictures or records video clips.

Ref	Component	Description
④	OK button	Confirms your selection or input.
	Arrow buttons	Moves up, down, left and right within the screen or menu.
⑤	Back button	Goes back to the previous screen.
⑥	Home button	Opens the Home screen.
⑦	Recent button	Opens a screen containing thumbnails of applications you've used recently. Touch a thumbnail to open that application.
⑧	Fn quick button	Opens the Camera application (default setting).
		Can be assigned to a different function through Settings.

Back Components

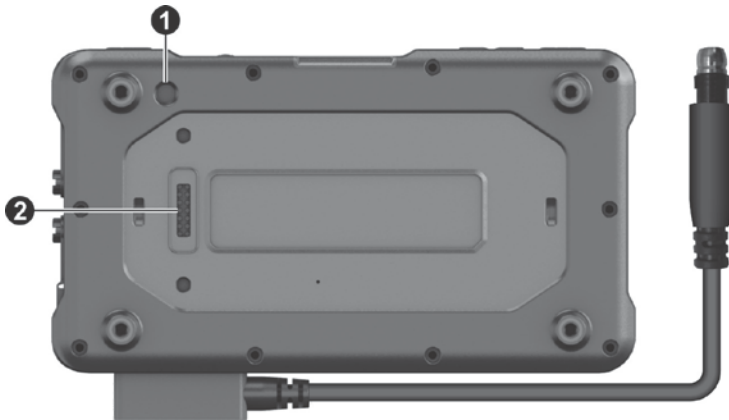

Ref	Component	Description
①	Camera lens	Takes still pictures or records video clips.
②	Expansion connector (Pogo pin)	Connects to a proprietary snap-on module.

Top Components



Ref	Component	Description
①	P1 quick button	Disables/enables the touch screen (default setting). When disabled, you will see a frame around the screen and a message at the bottom of the screen. Can be assigned to a different function through Settings.
②	Minus button	Decreases the brightness level (default setting). Can be assigned to a different function through Settings.
③	Plus button	Increases the brightness level (default setting). Can be assigned to a different function through Settings.
④	Power button	Starts up the device. Turns off or restores the screen. When pressed longer: Opens a menu with Power off option.
⑤	Reset switch	Restarts your device when pressed for more than 5 seconds.
⑥	P2 quick button	Captures the current screen and saves it as an image file (default setting). Can be assigned to a different function through Settings.

Right-Side Components

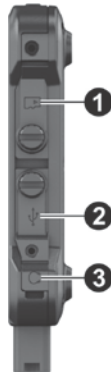

Ref	Component	Description
①	MicroSD card slot (inside the cover)	Accepts a microSD card for removable storage.
②	Micro USB host connector (inside the cover)	Connects to a computer via USB cable for data transfer.
③	Combo Audio Connector (inside the cover)	Connects a set of headphones.
		Supports a headset microphone with 4-pole TRRS 3.5mm jack.

Getting Your Device Ready for Use

Connecting to AC Power and Charging the Battery

1. Connect the AC adapter to the power connector of MX50 (❶).

Connect one end of the power cord to the AC adapter (❷) and the other end to an electrical outlet (❸).



NOTE: AC adapter and power cord types vary with countries.

2. Power is being supplied from the external power source to MX50.

When external power is connected, it also charges the internal battery. For information on using battery power, see “Managing Power” in Chapter 6.

CAUTION: For optimal performance of the lithium battery, take note of the following:

- Use the included AC adapter only.
- There is no need to fully discharge the battery before charging. You can charge the battery before it is discharged.
- Do not charge the battery where the temperature is high (e.g. in direct sunlight).

- As a battery protection, store the device where the temperature is appropriate. Avoid high temperatures.
- The battery can be charged when its temperature is between 0°C (32°F) and 40°C (104°F).
- If you will not use the product for a long period of time, be sure to fully charge the battery at least once every two weeks. Over discharge of the battery can affect the charging performance.

Performing the Initial Startup

When turning on your device for the very first time, you will be guided through a setup process.

1. Make sure that your device is either connected to AC power or the battery has power.
2. Press the power button.
The device powers up and displays the initial screen.
3. Follow the on-screen instructions to complete the initial setup process.

After the setup is completed, the Home screen appears. You can now use your device.

Using the Chest Mount

1. Feed the two lower tabs of the mount through lower webbing.

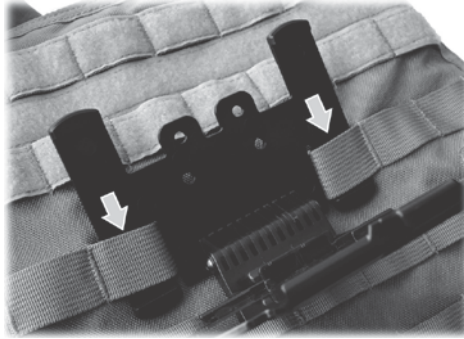

2. Feed all four top tabs through upper webbing.



3. Insert the retention-cord piece to the webbing above the center of the mount.



- Align the bottom grooves of MX50 with the counterparts on the mount and insert MX50 at an angle (❶). Then press the holder and MX50 together until the clamp clicks into place (❷).

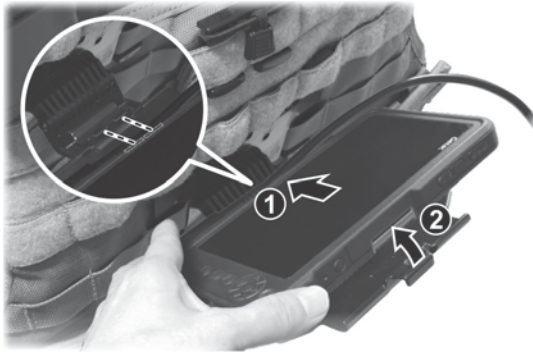

- When you flip up the mount, pull the cord over the clamp.



Chapter 2

Basic Skills

This chapter familiarizes you with the basic operations of your device.

CAUTION: The device can get uncomfortably warm when you use it in high temperatures. In such a circumstance, please take safety measures (such as wearing gloves) to protect yourself. Prolonged body contact can cause discomfort and potentially a burn.

Sleeping and Shutting Down

You can manually put your device to sleep by briefly pressing the power button. To wake up, press the power button.

To shut down, press and hold the power button until a menu pops up. Touch **Power off** and then **OK**.

Navigating on the Screen

CAUTION: Do not use sharp objects on the touch screen. Doing so may damage the display surface.

Use your finger to navigate and select objects on the screen.





Here are some common terms that you should know when using the touch screen:

- **Touch**
Touch the screen once with your finger to open an item or select an object.
- **Touch and hold**
Touch and hold your finger on an item to see a list of actions available for that item.
- **Drag**
Hold your finger on an item and, without lifting the finger, move across the screen until you reach the target position.
- **Swipe or slide**
Move your finger across the screen, without pausing when you first touch it (so you don't "drag" instead). For example, you slide the screen up or down to scroll a list.
- **Pinch**
In some applications (such as Maps and Gallery), you can zoom in and out by placing two fingers on the screen at once and pinching them together (to zoom out) or spreading them apart (to zoom in).

Home Screen

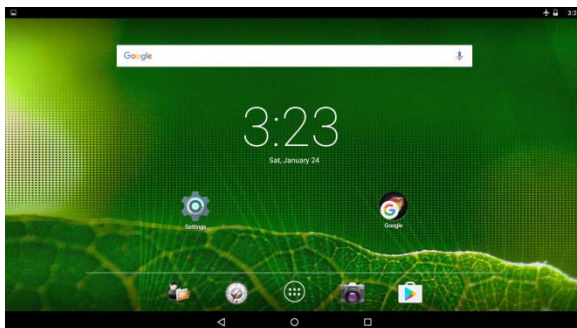
The Home screen is your starting point to access all the features on your device. You can have it display application icons, widgets, shortcuts, and other features that you want. The default Home screen already contains some application icons and widgets. At the bottom of every Home screen is the Favorites tray.



To return to the Home screen at any time, touch  at the bottom of the screen or the **Home** button on the device.

Extensions to the Home Screen

You can slide left or right across the Home screen to see other parts of the Home screen. Extensions to the Home screen provide more space for widgets, shortcuts, and other items.

Customizing Your Home Screen

You can add application icons, shortcuts, widgets, and other items to any part of the Home screen where there's free space. You can also change the wallpaper.

Adding an Item to the Home Screen

1. Touch  on the Home screen.
2. Touch **APPS** or **WIDGETS** depending on the type of item you want to add.
3. Touch and hold an item to add. Drag it to the where you want to place it and then release it.

Removing an Item from the Home Screen

Touch and hold the item you want to remove. Drag it to the X icon at the top of the screen.

Using Applications

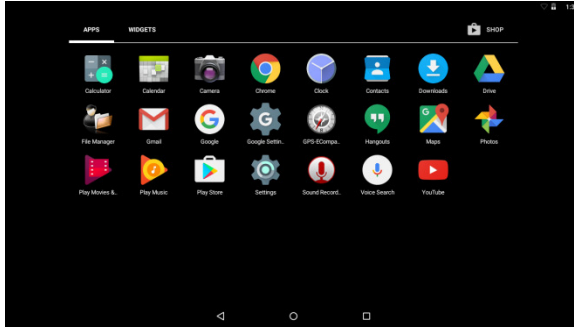

Touch  (in the Favorites tray) on the Home screen to open the All Apps screen. The screen holds icons for all of the applications on your device. Touch an icon to open the application.



Most applications include a Menu icon  near the top or lower right corner of the screen. The menu contains tools that apply to the activities of the current screen or application.

Navigation Bar

The navigation bar at the bottom of the screen provides buttons for navigation purposes and frequently-used tasks.

Button	Name	Description
	Back	Goes back to the previous screen.
	Home	Opens the Home screen.
	Recent	Opens a screen containing thumbnails of applications you've used recently. Touch a thumbnail to open that application.

Status Bar and Notifications Panel

The Status bar appears at the top of almost every screen. It displays icons indicating that you've received notifications (on the left) and icons indicating the current status (on the right), along with the current time.



You can open the Notifications panel by swiping down from the top.

Quick Settings

Use Quick Settings to quickly change common settings such as screen brightness, Wi-Fi, Bluetooth, Airplane mode, and others.

You can open Quick Settings from anywhere on your device. Swipe down from the top to open the Notifications panel and swipe down again to open the Quick Settings panel.

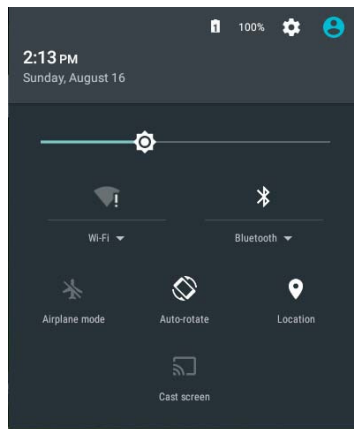

Entering Information

You enter text, numbers, and symbols using the onscreen keyboard. Some applications open the keyboard automatically. In others, you touch an input field where you want to enter text to open the keyboard.

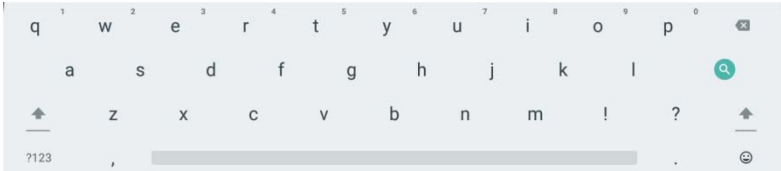

To enter text, touch the keys on the keyboard to type. To enter numbers or symbols, touch the Symbols key **?123** to switch to the numbers and symbols keyboard.

Chapter 3

Getting Connected

This chapter tells you how you can get your device connected through a variety of ways.

Wireless Connections

Using Wi-Fi Networks

Turning On/Off the Wi-Fi Radio

Go to **Quick Settings** and touch the Wi-Fi icon.

- Or -

Go to **Settings**. Find the **Wi-Fi** item under **WIRELESS & NETWORKS**. Slide the Wi-Fi switch on or off.

When the Wi-Fi radio is turned on, the icon  appears in the status bar. If your device finds a network that you connected to previously, it connects to it.

Connecting to a Wi-Fi Network

1. Make sure the Wi-Fi radio is on (as described in the previous section).
2. Go to **Quick Settings** and touch the down arrow of the Wi-Fi item.
- Or -
Go to **Settings**. Touch **Wi-Fi**.
3. Your device scans for available Wi-Fi networks and displays the names in the screen.
4. On the list of discovered networks, touch the one you want to connect to.
5. If the network is secured, you're prompted to enter a password or other credentials.

If the network is open, you are prompted to confirm that you want to connect to that network by touching **Connect**

Using the Bluetooth Function

NOTE: Getac does not guarantee the product's compatibilities with the Bluetooth headsets/devices from all manufacturers.

Turning On/Off the Bluetooth Radio

Go to **Quick Settings** and touch the Bluetooth icon.

- Or -

Go to **Settings**. Find the **Bluetooth** item under **WIRELESS & NETWORKS**. Slide the Bluetooth switch on or off.

When the Bluetooth radio is turned on, the icon  appears in the status bar.

Pairing with a Bluetooth Device

The first time you use a new Bluetooth device with your device, you must "pair" them, so that they know how to connect securely to each other. After that, you can simply connect to a paired device.

1. Make sure that the other Bluetooth device is set as "discoverable" and within range.
2. Make sure the Bluetooth radio is on (as described in the previous section).
3. Go to **Quick Settings** and touch the down arrow of the Bluetooth item.
- Or -
Go to **Settings**. Touch **Bluetooth**.
4. Your device scans for and displays the IDs of all available Bluetooth devices in range.
5. On the list of discovered devices, touch the ID of the device you want to pair with.
6. The devices pair with each other. If you're prompted to enter a passcode, try entering 0000 or 1234 (the most common passcodes), or consult the documentation that came with the device to learn its passcode.

If the pairing is successful, your device connects to the device.

External Connections

Using a MicroSD Card

Inserting a MicroSD Card

1. Open the microSD card slot cover by loosening the slotted screw.
2. Insert the card into the slot, with the golden contacts pointing to the slot and facing front.



3. Close the cover and tighten the screw.

CAUTION: When closing the cover, you must firmly press all over the cover to ensure its sealing capability.



Removing MicroSD card

You can safely remove the microSD card from your device any time the device is shut down. If you need to remove the card while the device is on, unmount the card first to prevent corrupting or damaging the card.

To unmount:

1. Go to **Settings**.
2. Touch **Storage** and touch **Unmount SD card** under **EXTERNAL SD CARD**.
3. Open the microSD card slot cover. Press the edge of the card to release it and then pull the card out of the slot.

Connecting an Audio Device

The audio combo connector is the “4-pole TRRS 3.5mm” type (Apple iPhone Recessed) so you can connect a compatible headset microphone.



SAFETY WARNING:



To prevent possible hearing damage, do not listen at high volume levels for long periods.

Connecting to a Computer via USB

You can connect your device to a computer with the USB cable, to transfer files between your device and the computer.

1. Open the micro USB connector cover by loosening the slotted screw.
2. Use the USB cable (available to you as an option) to connect the device to a USB port on your computer.

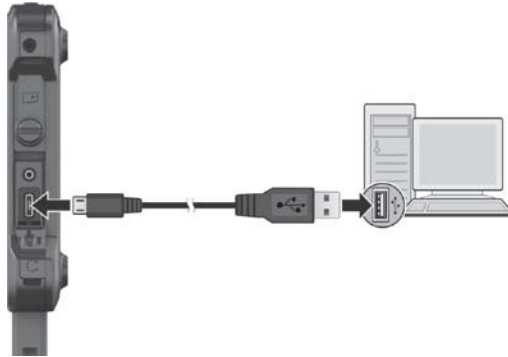

CAUTION: When closing the cover, you must firmly press all over the cover to ensure its sealing capability.



Chapter 4

Android Preinstalled Applications

This chapter briefly introduces the Android 5.1.1 preinstalled applications from Google.

Google Applications Overview

For instructions on using the Google applications, check Google official website for online help.

NOTE: The table below does not include Getac applications. See the next chapter for information on Getac applications.

Apps	Descriptions
Calculator	Use Calculator to solve arithmetic problems. You can then paste the results into another application.
Calendar	The Calendar app works with the web-based Google Calendar calendaring service. It also works with the Microsoft Exchange ActiveSync calendaring service.
Camera	Use Camera to take pictures and shoot videos. (See "Camera" later in this chapter for more information.)
Chrome	This is the web browser from Google. Sign in to sync your Chrome browser experience from your computer
Clock	Use Clock to display the date and time in large characters on your screen.
Contacts	The Contacts app gives you quick and easy access to the people you want to reach.

Apps	Descriptions
Downloads	The Downloads app lets you to manage most downloads.
Drive	Use Drive to store your files securely in the cloud and also to access them.
Gmail	Gmail works with Google’s web-based email service.
Google	Use Google to easily and quickly find what you need on the web and on your device.
Google Settings	Use Google Settings to manage settings for Google apps and services.
Hangouts	Use Hangouts to send messages, make voice and video calls, and share photos.
Maps	This is the Google Maps app for Android.
Photos	Use Photos to manage photos and videos on your device.
Play Movies & TV Shows	You can play digital content through the service of Google. However, the availability of the service depends on your geographical location. The app icons will disappear from the screen if you are in a region where the service is currently unavailable.
Play Music	Use Play Music to organize and listen to music and audio files.
Play Store	Use Play Store to get all your applications and entertainment in one place.
Settings	The Settings app contains most of the tools for customizing and configuring your device. (See “Settings” in Chapter 7 for more information.)
Sound Record	This is a tool for recording sound.
Voice Search	Use Voice Search to quickly search your device, the web, and nearby locations by speaking, instead of typing.
YouTube	This is the official YouTube app for Android.



Camera

Use the Camera application to take pictures and shoot videos. In addition, you can have GPS information embedded into the picture/video file.

Taking Pictures

1. Open the Camera application. Touch  if you are not in Camera mode.



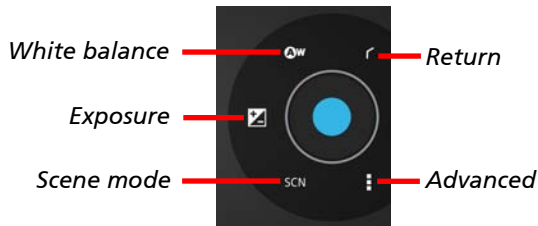

2. Touch  to select the front or rear camera lens.
3. If you want to adjust settings, touch .



4. To zoom in or out, drag  toward  or .
5. To take the picture, touch .
6. The picture you just took is displayed as a thumbnail at the corner. You can touch the thumbnail to view the picture.

The file is saved to the internal storage of your device.

Taking Panoramic Pictures



1. Open the Camera application. Touch  to switch to Panoramic mode.
2. Aim the camera lens at the starting point of the intended view. Touch  to start.
3. Slowly pan your device toward the other side. The status bar shows your progress.

4. To end, touch .

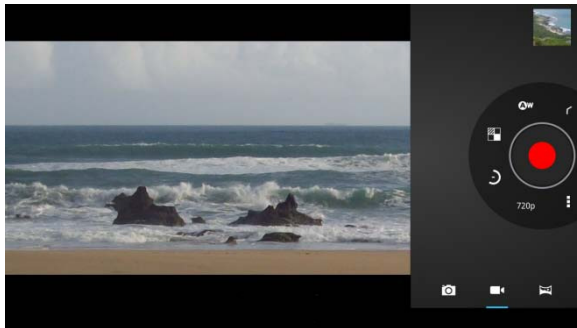

Shooting Videos

1. Open the Camera application. Touch  to switch to Video mode.

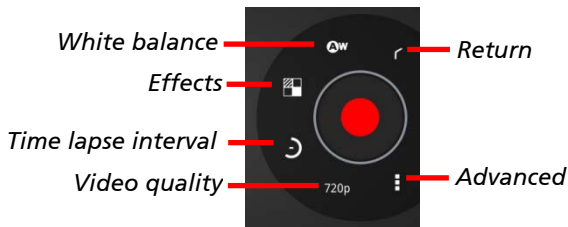

2. Touch  to select the front or rear camera lens.
3. If you want to adjust settings, touch .



4. To zoom in or out, drag  toward  or .

5. To start shooting the video, touch .

The elapsed time shows at the corner.

6. To stop, touch .

7. An image from your most recent video is displayed as a thumbnail at the corner. You can touch the thumbnail to view the video.

The file is saved to the internal storage of your device.

Chapter 5

Getac Applications

This chapter describes the applications added by Getac for special features of your device.

File Manager

File Manager allows you to organize your data in the internal SD card and any connected external storage (such as a microSD card or USB disk).

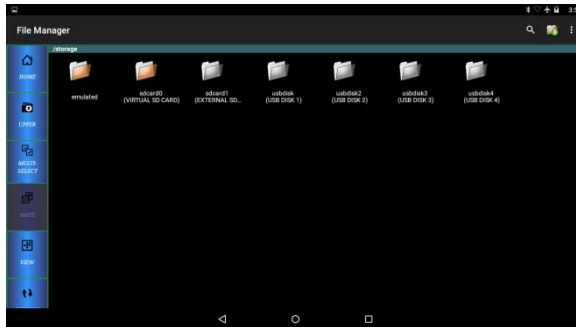

To exit, touch  → Exit.



Button Descriptions

Left side buttons:

Buttons	Descriptions
Home	Goes to the root directory.
Upper	Goes one level up to the parent directory.

Buttons	Descriptions
Multi-Select	Enables or disables multiple selections. When enabled, you can touch multiple files or folders for one batch operation. A set of buttons appear on the left side of the screen for you to use.
Paste	Pastes what you have cut or copied to the current directory.
View	Switches between icon and list view.
Refresh	Refreshes the current directory.

Upper-right buttons:

Buttons	Descriptions	
 Search	Opens the Search box.	
 Add Folder	Adds a folder in the current directory.	
 Menu	Settings	
	Show all files/directories	Check to show all files/directories.
	Show image thumbnail(s)	Check to have images shown as thumbnails.
	Display type	Sets the view to icon or list view.
	Sort by	Specifies the sorting order.
	Home directory setting	Specifies a folder as the home directory in File Manager.

Opening a File

When you touch a filename, File Manager tries to open or execute the file depending on the file type.

NOTE: Not all files can be opened in this way.

GPS-ECompass

GPS-ECompass can:

- Function as a compass.
- Receive GPS satellite signals to calculate the location of your device.
- Record GPS logs.

When opening the application, you will be asked to turn on GPS if it is off. The icon  in the status bar indicates GPS service is in use.

The application has three pages as described later. Touch one of the three buttons (**Satellite Position**, **Electronic Compass**, and **Location Information**) at the left side of the screen to see the page.

Satellite Position

The **Satellite Position** page shows the positions of the overhead satellites and their signal strength. It also indicates the on/off status of the SBAS and logging functions.



SBAS (satellite-based augmentation system) provides additional accuracy and reliability for the GPS devices. Ground stations are necessary to achieve the purpose. The SBAS feature works where such stations exist. You can enable the SBAS feature. (See “Getac Settings” in Chapter 7.)

Electronic Compass

The **Electronic Compass** page shows directions of movement including orientation, pitch angle, roll angle, and azimuth angle.



The Accuracy reading is for your reference. When the application determines that calibration is needed, it will pop up the “Calibration” graphics asking you to calibrate the compass. Hold the device and swing it in the way as shown on the screen. Do this several times until the popup graphics disappear.

NOTE: Follow these guidelines when using the compass.

- Keep the device away from objects that generate magnetic fields, such as cars, large belt buckles, computers, cell phones, etc.
- If you must use the compass inside a car, the device should be at least 20 cm (7.87 inches) away from metal objects such as car doors, dashboard, air vents, etc.

Location Information

The **Location Information** page shows the geographic information of the current location once GPS positioning is completed.



Settings

Touch  and touch **Setting**.

Items	Descriptions
Location Service	Check GPS satellites to turn on GPS receiver.
Satellites Log	See the next subsection for information.
Rotation Type	Set to Needle Compass for a pivoting needle on a fixed dial or Wheel Compass for a fixed needle on a rotating dial.
Display	Check Calibration to display the Accuracy reading on the Electronic Compass screen. Check Balance to display the Pitch/Roll reading on the Electronic Compass screen.

Touch **OK** for the changes to take effect.

GPS Logging

You can record a GPS log file for the use of other applications. The output format is NMEA.

1. Touch  and touch **Setting**.
2. Touch **Start to write Log in /storage/sdcard0/GpsLog**.
3. In the selection menu that pops up, touch **..** to accept the default folder for storing the file.

If you want to specify a different folder, select it in the menu.

4. Touch **OK**. The recording will continue until you stop it.
5. To stop, touch  and touch **Setting**. Touch **Stop to write Log in**
6. Touch **OK**.

Chapter 6

Managing Your Device

This chapter tells you how to manage power and configure your device.

Managing Power

The operating time of a fully charged battery depends on how you are using the device. Some functions, such as using multimedia or operating an SD card, may consume the battery power considerably.

Low Battery Signals and Actions

CAUTION: When you recharge the battery upon a warning of low power, you should charge for at least 30 minutes. If you unplug the AC adapter soon, you may not have sufficient battery power for your operation.

The battery status (charging or discharging) and level (as a percentage of fully charged) are displayed at the top of the screen. To check the battery information, go to **Settings** → **Battery**.

You should save your data and recharge the battery immediately upon a warning of low power; otherwise your device will turn off automatically. You need to connect the device to external AC power for charging before you can use it again.

Power-Saving Tips

You can extend your battery's life between charges by turning off features that you don't need. You can also monitor how applications and system resources consume battery power.

- Turn off radios that you aren't using.
- Lower the screen brightness and set a shorter screen timeout.
- Lower the volume.
- If you don't need it, turn off automatic syncing for all applications.
- Avoid power-consuming applications. To check which applications consume the most battery power, go to the Home screen, go to **Settings** → **Battery**.



Settings

NOTE:

- Incorrect settings may cause your system to malfunction. Make sure that you fully understand the function of a certain item before any adjustment.
- Some setting items are available only for specific models or applications you have in your device.

The Settings application contains most of the tools for customizing and configuring your device.

To open Settings, use any of the below methods:

- Tap the **Settings** icon in the Home screen.
- Touch  (on the Home screen) → **Settings**.
- Open **Quick Settings** and touch the Settings icon .

Wireless and Networks Settings

Item	Description
Wi-Fi	To configure and use Wi-Fi.
Bluetooth	To configure and use Bluetooth.
Data usage	To view the amount of data uploaded or downloaded by your device during a given period. You can set up conditions for data usage.
More...	
Airplane mode	Check to turns off all wireless radios.
VPN	To set the type of VPN to add and view the list of VPNs that you've previously configured.

Device Settings

Item	Description
Display	To set brightness, wallpaper, sleep timeout, and font size.
Sound & notification	To configure sound-related settings such as volume, phone ringtone, vibration with ringing, notification sound, etc.
Storage	To view the used and available space on your device's storage.
Battery	To view battery usage data.
Apps	To view details about the applications installed on your device and to manage them.
Users	To add, change, or delete users.
Getac settings	See below.

Getac Settings

Item	Description
Sensors status	To view sensors data.
Physical buttons	To assign a function or application to a hardware button on your device.
Night vision	To toggle night vision on/off.
Common Criteria	To toggle Common Criteria on/off. "Common Criteria" is an international standard (ISO/IEC 15408), which define a common framework for evaluating security features and capabilities of Information Technology security products.
Global Navigation Satellite System	To toggle the below functions on/off. <ul style="list-style-type: none">• GPS• GLONASS• SBAS

Personal Settings

Item	Description
Location	To configure how you want your device to determine your location and how you want to share your location with Google and others.
Security	To configure screen lock, power-on password, device administration, and credential storage.
Accounts	To add accounts.
	The screen lists the account(s) you have added to the device. To manage an account, touch it.
Language & input	To set up display language, personal dictionary, keyboard language, input method, voice search, and text-to-speech output.
Backup & reset	To back up data and settings and to reset to factory default state.

System Settings

Item	Description
Date & time	To use automatic data and time or to enter manually
	To choose data and time format.
Accessibility	To modify your device's accessibility settings
Printing	To add printing services to your device and to manage service settings.
About tablet	To upgrade your device's firmware.
	To update the system.
	To view legal, hardware, and software information of your device.

Chapter 7

Care and Maintenance

This chapter provides guidelines on taking care of your device.

Resetting Your Device

To restart the device, press and hold the Reset Switch (shown below) for more than 5 seconds.



Alternatively, you can force the device to power off by pressing and holding the power button for more than 10 seconds. Then turn it on again.

Caring for Your Device

Taking good care of your device will ensure trouble-free operation and reduce the risk of damage to your device.

- Keep your device away from excessive moisture and extreme temperatures.
- Avoid exposing your device to direct sunlight or strong ultraviolet light for extended periods of time.
- Do not place anything on top of your device or drop objects on your device.

- Do not drop your device or subject it to severe shock.
- Do not subject your device to sudden and severe temperature changes. This could cause moisture condensation inside the unit, which could damage your device. In the event of moisture condensation, allow your device to dry out completely before use.
- The screen surface can easily be scratched. Avoid touching it with sharp objects. Non-adhesive generic screen protectors designed specifically for use on portable devices with LCD panels may be used to help protect the screen from minor scratches.
- Never clean your device with it powered on. Use a soft, lint-free cloth to wipe the screen and the exterior of your device.
- Do not use paper towels to clean the screen.
- Never attempt to disassemble, repair or make any modifications to your device. Disassembly, modification or any attempt at repair could cause damage to your device and even bodily injury or property damage and will void the warranty.
- Do not store or carry flammable liquids, gases or explosive materials in the same compartment as your device, its parts or accessories.

Chapter 8

Regulatory Information

NOTE: Marking labels located on the exterior of your device indicate the regulations that your model complies with. Please check the marking labels on your device and refer to the corresponding statements in this chapter. Some notices apply to specific models only.

Regulations Statements

USA Class B Regulations

Federal Communications Commission Radio Frequency Interference Statement

NOTE:

This equipment has been tested and found to comply with the limits for a Class B digital device pursuant to Part 15 of the FCC Rules. These limits are designed to provide reasonable protection against harmful interference in a residential installation. This equipment generates, uses, and can radiate radio frequency energy and, if not installed and used in accordance with the instructions, may cause harmful interference to radio communications. However, there is no guarantee that interference will not occur in a particular installation. If this equipment does cause harmful interference to radio or television reception, which can be determined by turning the equipment off and on, the user is encouraged to try to correct the interference by one or more of the following measures:

- Reorient or relocate the receiving antenna.

- Increase the separation between the equipment and receiver.
- Connect the equipment into an outlet on a circuit different from that to which the receiver is connected.
- Consult the dealer or an experienced radio/TV technician for help.

Any changes or modifications not expressly approved by the manufacturer could void the user's authority to operate the equipment.

Please note:

The use of a non-shielded interface cable with this equipment is prohibited.

European Union CE Marking and Compliance Notices

Statements of Compliance

English

This product follows the provisions of the European Directive 1999/5/EC.

Danish

Dette produkt er i overensstemmelse med det europæiske direktiv 1999/5/EC.

Dutch

Dit product is in navolging van de bepalingen van Europees Directief 1999/5/EC.

Finnish

Tämä tuote noudattaa EU-direktiivin 1999/5/EC määräyksiä.

French

Ce produit est conforme aux exigences de la Directive Européenne 1999/5/EC.

German

Dieses Produkt entspricht den Bestimmungen der Europäischen Richtlinie 1999/5/EC.

Greek

Το προϊόν αυτό πληροί τις προβλέψεις της Ευρωπαϊκής Οδηγίας 1999/5/EC.

Icelandic

Þessi vara stenst reglugerð Evrópska Efnahags Bandalagsins númer 1999/5/EC.

Italian

Questo prodotto è conforme alla Direttiva Europea 1999/5/EC.

Norwegian

Dette produktet er i henhold til bestemmelsene i det europeiske direktivet 1999/5/EC.

Portuguese

Este produto cumpre com as normas da Diretiva Europeia 1999/5/EC.

Spanish

Este producto cumple con las normas del Directivo Europeo 1999/5/EC.

Swedish

Denna produkt har tillverkats i enlighet med EG-direktiv 1999/5/EC.

Restrictions

This device is restricted to indoor use when operating in the 5150 to 5350 MHz frequency range.

Safety Precautions

- Prolonged listening of music in maximum volume can damage the ears.
- The use of headphones other than those recommended/supplied can cause hearing impairment due to excessive sound pressure.
- **Caution for service personnel:** Risk of explosion if battery is replaced by an incorrect type. Dispose of used batteries according to the instructions.

About Charging

- Use only the AC adapter supplied with your device. Use of another type of AC adapter will result in malfunction and/or danger.
- Use only the car charger supplied by the manufacturer. Use of another type of car charger will result in malfunction and/or danger.

- This product is intended to be supplied by a LISTED Power Unit marked with "LPS," "Limited Power Source," and output rated + 12 V dc / 2.0 A.
- Use a specified cradle approved by the manufacturer.
- Use a specified battery in the equipment.

About the AC Adapter

- Do not use the AC adapter in a high moisture environment. Never touch the AC adapter when your hands or feet are wet.
 - Allow adequate ventilation around the AC adapter when using it to operate the device or charge the battery. Do not cover the AC adapter with paper or other objects that will reduce cooling. Do not use the AC adapter while it is inside a carrying case.
 - Connect the AC adapter to a proper power source. The voltage and grounding requirements are found on the product case and/or packaging.
 - Do not use the AC adapter if the cord becomes damaged.
 - Do not attempt to service the unit. There are no serviceable parts inside. Replace the unit if it is damaged or exposed to excess moisture.
 - This device complies with part 15 of the FCC Rules. Operation is subject to the following two conditions: (1) This device may not cause harmful interference, and (2) this device must accept any interference received, including interference that may cause undesired operation.
 - This device is designed and manufactured not to exceed the emission limits for exposure to radio frequency (RF) energy set by the Federal Communications Commission of the U.S. Government.
- 本電池如果更換不正確會有爆炸的危險 廢電池請回收 
請依製造商說明書處理用過之電池
- 經型式認證合格之低功率射頻電機，非經許可，公司、商號或使用者均不得擅自變更頻率、加大功率或變更原設計之特性及功能。
低功率射頻電機之使用不得影響飛航安全及干擾合法通信；經發現有干擾現象時，應立即停用，並改善至無干擾時方得繼續使用。
前項合法通信，指依電信法規定作業之無線電通信。低功率射頻電機須忍受合法通信或工業、科學及醫療用電波輻射性電機設備之干擾。
 - 在5.25-5.35 兆赫頻帶內操作之無線資訊傳輸設備，限於室內使用。
 - 使用過度恐傷害視力 (1). 使用30分鐘請休息10分鐘。
(2). 2歲以下幼兒不看螢幕，2歲以上每天看螢幕不要超過1小時