

**OLYMPIA® OL2400**

**OWNER'S MANUAL**

**OLYMPIA** 

## **Copyright**

© 2002, Wave Industries Ltd. All Rights Reserved.

Reproduction, adaptation, or translation without prior written permission is prohibited, except as allowed under the copyright laws.

First Edition: July 2002

## **Trademark Information**

Olympia® is a registered trademark of Olympia International Holdings Ltd.

## **Warranty**

The information contained in this document is subject to change without notice. Wave Industries makes no warranty of any kind with respect to this information. Wave Industries shall not be liable for any direct, indirect, incidental, consequential, or other damage alleged in connection with the furnishing or use of this information.

Printed in China

TABLE OF CONTENTS

IMPORTANT SAFETY INSTRUCTIONS.....	4
SAFETY INSTRUCTIONS FOR BATTERIES.....	5
EQUIPMENT ATTACHMENT LIMITATIONS.....	6
1 Features.....	7
2 Layout of Keys and Indicators.....	8
2.1 Key Functions.....	8
2.2 LCD Display Indications.....	9
3 Installation and Charging of the Battery Pack.....	10
4 Handset Registration Procedure.....	11
5 Display Messages & Audio Alert.....	12
5.1 Display Message.....	12
5.2 Audible Alerting.....	14
6 Operation Guide.....	15
6.1 Making External Calls.....	15
6.2 Redialing.....	15
6.3 Receiving Calls.....	16
6.4 Flash.....	16
6.5 Page Call.....	16
6.6 Making Internal Calls.....	17
6.7 Call Toggling.....	17
6.8 Call Transfer/Forward.....	18
6.9 Call Back.....	19
6.10 Conference.....	19
6.11 Muting the Microphone.....	19
6.12 Call Waiting.....	19
7 Menu Structure.....	21
7.1 Call Log.....	22
7.2 Phone Book Operation.....	23
7.3 Handset Volume.....	27
7.4 Ring Volume.....	27
7.5 Ring Pattern.....	28
7.6 Auto Answer.....	28
7.7 Key Click.....	29
7.8 Key Lock.....	29
7.9 Handset Name.....	31
7.10 Select LANGUAGE.....	31
7.11 Clear Message Waiting.....	31
7.12 Dial Method.....	32
8 Overview of Telephone Functions.....	33
9 Consumer Information.....	38

## **IMPORTANT SAFETY INSTRUCTIONS**

BEFORE USING YOUR TELEPHONE EQUIPMENT, BASIC SAFETY PRECAUTIONS SHOULD ALWAYS BE FOLLOWED TO REDUCE THE RISK OF FIRE, ELECTRIC SHOCK AND INJURY, INCLUDING THE FOLLOWING

**Read and understand all instructions.**

**Follow all warnings and instructions marked on the product.**

**Unplug this product from the wall outlet before cleaning. Do not use liquid cleaners or aerosol cleaners. Use a damp cloth for cleaning.**

**Do not use this product near water, for example, near a bath tub, wash bowl, kitchen sink, laundry tub, in a wet basement, or near a swimming pool.**

**Do not place this product on an unstable cart, stand, or table. The product may fall, causing serious damage to the product.**

**Slots and openings in the cabinet and the back or bottom are provided for ventilation. To protect it from overheating, these openings must not be blocked or covered. The openings should never be blocked by placing the product on the bed, sofa, rug, or other similar surface. This product should never be placed near or over a radiator or heat register. This product should not be placed in a built-in installation unless proper ventilation is provided.**

**This product should be operated only from the type of power source indicated on the marking label. If you are not sure of the type of power supply to your home, consult your dealer or local power company.**

**Do not allow anything to rest on the power cord. Do not locate this product where the cord will be damaged by persons walking on it.**

**Do not overload wall outlet extension cords, as this can result in the risk of fire or electric shock.**

**Never push objects of any kind into this product through cabinet slots as they may touch dangerous voltage points or short out parts that could result in a risk of fire or electric shock. Never spill liquid of any kind on this product.**

**To reduce the risk of electric shock, do not disassemble this product. Instead, when some repair work is required, take the unit to a qualified technician. Opening or removing covers may expose you to dangerous voltages or other risks. Incorrect reassembly can cause electric shock when the appliance is subsequently used.**

**Unplug this product from the wall outlet and refer servicing to qualified service personnel under the following conditions:**

- a) When the power supply cord or plug is damaged or frayed.
- b) If liquid has been spilled into the product.
- c) If the product has been exposed to rain or water.
- d) If the product does not operate normally by following the operating instructions. Adjust only those controls, that are covered by the operating instructions because improper adjustment of other controls may result in damage and will often require extensive work by a qualified technician to restore the product to normal operation.
- e) If the product has been dropped or cabinet has be damaged.
- f) If the product exhibits a distinct change in performance.

**Avoid using a telephone(other than a cordless type) during an electrical storm. There may be a remote risk of electrical shock from lightning.**

**Do not use the telephone to report a gas leak in the vicinity of the leak.**

## **SAFETY INSTRUCTIONS FOR BATTERIES**

### **Safety Instructions for Batteries Handset Battery Pack**

#### **CAUTION:**

Danger of explosion if battery is incorrectly replaced. Use only an Olympia Phone approved battery pack in the handset of your OL2400 Cordless Telephone. To reduce the risk of fire or injury, always do the following when replacing, discarding, or charging battery. When handling the batteries, be careful not to short the battery with conducting materials such as rings, bracelets, and keys. The Battery or conducting material may overheat and cause burns. Use only the following type and size of battery pack:

FOR HANDSET UNIT:

GP60AAA3BMX 3.6V 600mAh GPI INTERNATIONAL LIMITED



**CONTAINS NICKEL-METAL HYDRIDE BATTERY. BATTERY MUST BE RECYCLED OR DISPOSED OF PROPERLY**

**Do not dispose of the battery in a fire. The cell may explode. Check with local codes for possible special disposal instructions.**

**Do not open or mutilate the battery. Released electrolyte is corrosive and may cause damage to the eyes or skin. It may be toxic if swallowed.**

**Exercise care in handling batteries in order not to short the battery with conducting materials such as rings, bracelets and keys. The battery or conductor may overheat and cause burns.**

**Charge the batteries provided with or identified for use with this product only in accordance with the instructions and limitations specified in this manual.**

**Observe proper polarity orientation between the battery(ies) and battery charger.**

**Do not mix old and new batteries in this product.**

**Do not mix batteries of different sizes or from different manufacturers in this product.**

**SAVE THESE INSTRUCTIONS**

## **EQUIPMENT ATTACHMENT LIMITATIONS**

**“This product meets the applicable Industry Canada technical specifications.”**

Before installing this equipment, users should ensure that it is permissible to be connected to the facilities of the local telecommunications company. The equipment must also be installed using an acceptable method of connection. In some cases, the company’s inside wiring associated with a single line individual service may be extended by means of a certified connector assembly (telephone extension cord). The customer should be aware that compliance with the above conditions may not prevent degradation of service in some situations.

Repairs to certified equipment should be made by an authorized Canadian maintenance facility designated by the supplier. Any repairs or alterations made by the user to this equipment, or equipment malfunctions, may give the telecommunications company cause to request the user to disconnect the equipment.

User should ensure for their own protection that the electrical ground connections of the power utility, telephone lines and internal metallic water pipe system, if present, are connected together. This precaution may be particularly important in rural areas.

Caution: Users should not attempt to make such connections themselves, but should contact the appropriate electric inspection authority, or electrician, as appropriate.

**“The Ringer Equivalence Number is an indication of an maximum number of terminals allowed to be connected to a telephone interface. The termination on an interface may consist of any combination of devices subject only to the requirement that the sum of the Ringer Equivalence Numbers of all the devices does not exceed five.”**

## **1 Features**

- Over 16 million security codes for call security
- CID/Call Waiting CID capable – stores the 20 most recent CID records (requires CID service from your local phone company)
- Alphanumeric display shows CID time and date plus phone status
- 5 phone number redial
- Exchangeable face panels
- 50 name and number phonebook
- Microphone mute feature
- Audible low battery and out of range warnings
- Headset jack
- Multiple Handset capability – up to 4
- Page function from Base
- Tone/Pulse dialing
- Key Click – programmable ON/OFF
- Key Lock – programmable ON/OFF
- Auto Answer (out of cradle) – programmable ON/OFF
- (2) two-way intercom calls can take place simultaneously
- Call Transfer – Handset to Handset
- Auto Hold during Call Transfer
- Adjustable Earpiece Volume Control (8 levels)
- Programmable Ringer OFF/Volume Control (6 levels)
- 10 selectable Ringer Tones
- Rechargeable Ni-NH battery pack

## 2 Layout of Keys and Indicators

### 2.1 Key Functions

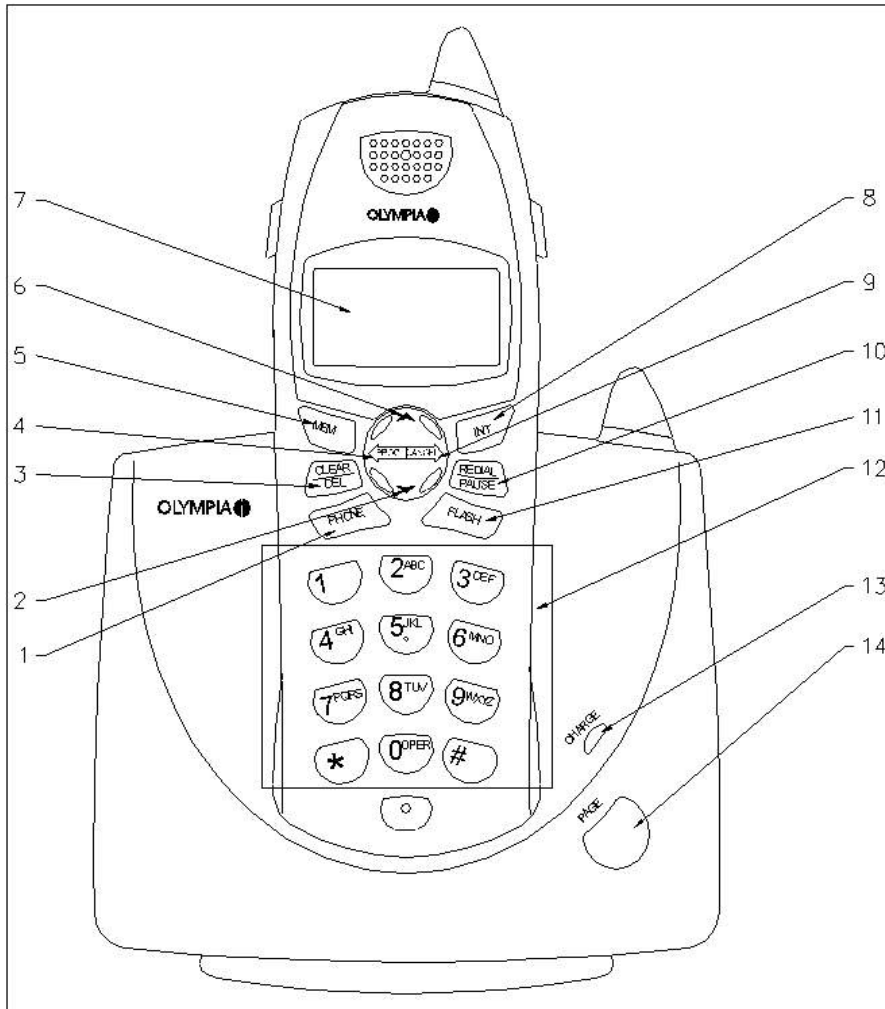

1. Phone key	Press to make or receive a call. Press again to end a call
2. Down key	For navigation
3. Clear/Delete key	Delete input / Microphone muting
4. Program key	Menu selection / Confirm input
5. Memory key	Phone book memory
6. Up key	For navigation
7. LCD Display	Provides information such as Caller ID and programming data
8. INT key	For internal calls
9. Cancel key	Exit menu
10. Redial/Pause key	Last number called / Pause
11. Flash key	For use with call waiting service
12. Keyboard	Dialing telephone numbers
13. Charge LED	Lights when Handset is charging in the base
14. Page	Press at Base to page all registered Handsets



## 2.2 LCD Display Indications

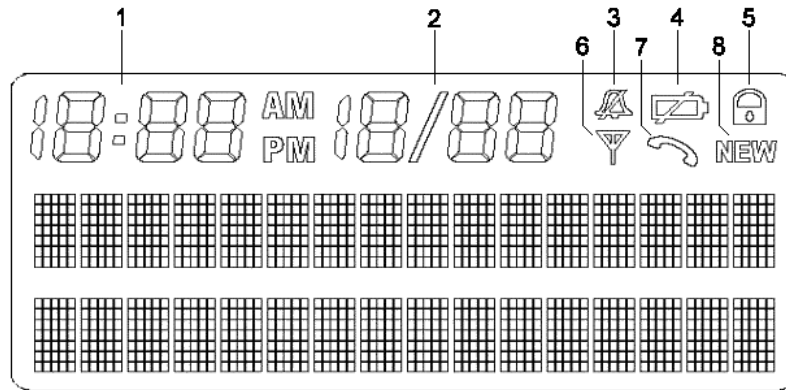

1. Caller ID Time
2. Caller ID Date
3. Ringer OFF icon (displayed when user turns the ringer off)
4. Low battery icon (on only if battery voltage is low)
5. Key lock icon (displayed when user locks the keypad)
6. In Service icon (displayed when Handset is 'in range' of the Base)
7. Off Hook icon (displayed when Handset is on an external or intercom call)
8. NEW icon (displayed when new Caller ID records have been received)

### **3 Installation and Charging of the Battery Pack**

Open the battery compartment by sliding the cover down.

Plug the Battery Pack connector into the Handset battery socket. Place the battery pack and wires in the compartment.

Close the battery compartment.

Mount the belt clip and one of the provided face panels on the Handset.

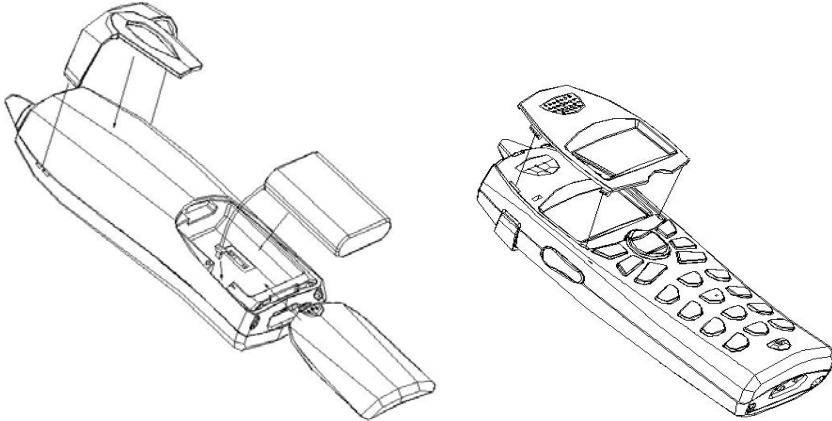

Choose the appropriate mounting bracket. The smaller bracket is for desk or countertop installations. The larger bracket is for wall mounting. You must use one of these brackets. Thread the telephone cord and DC power cord through the large opening in the bracket. Plug the two cords into the corresponding jacks on the bottom of the Base.

Snap the bracket into place on the back of the Base. If you are using the desk top bracket, run the two cords through the channel at the back of the bracket. If you are wall mounting the Base, carefully line up the slots on the wall mount bracket with the studs on the telephone wall plate, and carefully mount the telephone on the wall.

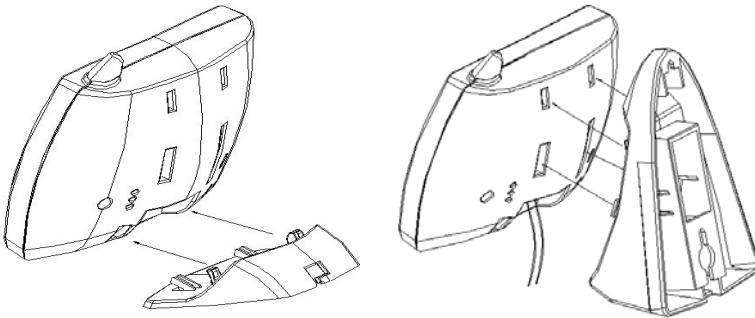

Connect the telephone line cord to the telephone jack, and the power supply to a live power outlet. Make sure you are not using an outlet controlled by a switch.

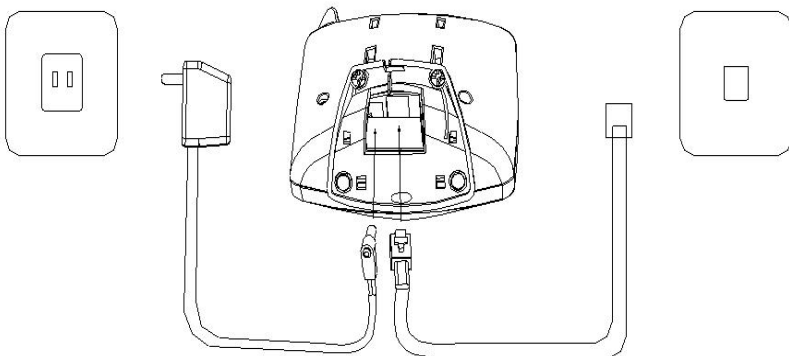

Place the Handset in the Base. The Handset and Base communicate with each other automatically. This process may take a minute.

Leave the Handset in the Base for 10 hours so that the battery pack is fully charged.

The CHARGE indicator on the Base glows when the Handset is charging.

## **4 Handset Registration Procedure**

A Handset, which has not been registered, will display:

NOT REGISTERED PLACE IN BASE
---------------------------------

Plug the power supply into a live electrical outlet and the DC connector into the bottom of the Base. Place the Handset (with battery pack plugged in) into the Base cradle. In approximately **60 seconds**, the Handset will beep, indicating registration has been completed. The Handset display will say **“READY.”**

A previously registered Handset will display **“OUT OF SERVICE”** if taken out of range or if the Base loses power.

OUT OF SERVICE
----------------

Return to the Base or power up the Base again, then place the Handset in the Base cradle. In approximately **one minute**, the Handset will regain its registration.

## **5 Display Messages & Audio Alert**

### **5.1 Display Message**

The handset provides a number of status messages in the display either in the idle state or during conversation.

The following status messages are shown in the idle display.

When the handset is out of range, an "out of service" message is shown in line one.

OUT OF SERVICE

When the handset has no valid registration, the display shows:

NOT REGISTERED  
PLACE IN BASE

If a new battery has been inserted and the battery voltage is too low to guarantee significant conversation time, the display shows:

PLACE IN CHARGER

When the battery pack has first reached a minimal charge (but not enough to assure continuous operation), it will display "CHARGING."

CHARGING

When a handset has completed registration, it will display "READY."

READY

If the phone line is disconnected, "NO LINE" is displayed.

READY  
NO LINE

When the keypad is locked, the status is presented in line two.

READY  
KEY LOCKED

If the phone line is in use (by another telephone connected to the same line), "EXT IN USE" is displayed. It is still possible to go off-hook during this condition.

If one handset is engaged in an external call, the message is presented in line two of the other handset's display.

READY  
EXT IN USE

In the presence of new, unplayed voicemail messages, "MESSAGE WAITING" is displayed.

READY  
MESSAGE WAITING

When there is one or more new Caller ID records in the call log, the status is presented in line two: e.g.

READY  
10 CALL/3 NEW

When the ringer is switched off, the status is presented in line two.

READY  
RINGER OFF

The following messages may occur in the display during conversation.

When the battery low level is reached, the "charge battery" recommendation is shown in line two.

TALK 1:32:56  
CHARGE BATTERY

When the microphone is muted, the status is presented in line two.

TALK 1:32:56  
MIC MUTE

## 5.2 Audible Alerting

### Out of range

- A one-time **triple beep** will be heard at the Handset.

### Low battery

- When off hook, a **double beep** will be heard in the earpiece.
- When on hook, a **double beep** will be heard at the Handset.

### Charging

- The Handset will emit a **single beep** when placed in the Base charger.

### Registration

- The Handset will emit a **single beep** indicating successful registration.
- If the registration procedure fails, the Handset will emit a **double beep**.

### Other earpiece tones/alerts

- Conference call establishment (second handset has joined conversation)
- Busy tone
- Congestion tone
- Call waiting
- Microphone mute
- Dial tone
- Ring back tone

### Other handset tones/alerts

- Illegal key press (during programming mode)
- Programming confirmation

## **6 Operation Guide**

### **6.1 Making External Calls**

#### **6.1.1 Post Dialling**

- 1) Press the key and wait for dial tone



- 2) Dial the telephone number 030 1234
- 3) End the call by placing the handset in the cradle or pressing the PHONE key



#### **6.1.2 Pre-dialling**

- 1) Dial the telephone number; e.g. 555-5555
- 2) Delete any incorrect entry with short press or whole entry with long press



- 3) Press the key to dial the number



- 4) End the call by placing the handset in the cradle or pressing the PHONE key



#### **Inserting a Pause in Dialling String**

When programming a number into the phone book, press REDIAL/PAUSE to insert a two-second pause in the dialing sequence. This is useful when speed dialing on a PBX system. Each press of REDIAL/PAUSE adds two additional seconds to the pause. Press the key to insert a pause and "P" appears in the display.



### **6.2 Redialing**

Each system handset stores the last 5 telephone numbers dialed.

#### **6.2.1 Post-dialling**

- 1) Press PHONE key and wait for dial tone.



- 2) Press REDIAL until you see the desired number.

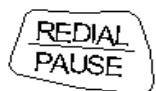

- 3) Press PROG to dial the displayed number.



- 4) End your call by placing the handset in the cradle or pressing PHONE.



#### **6.2.2 Pre-dialling**

1) Press REDIAL until you see the desired number.

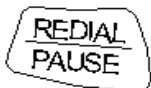

2) Press PHONE.



3) End your call by placing the handset in the cradle or pressing PHONE.



### 6.3 Receiving Calls

When an external call is received, all the handsets ring; EXTERNAL CALL is shown on the display.

#### 6.3.1 The Handset Is Located in the Cradle

1) Take the handset from the cradle; a connection is automatically established when the AUTO ANSWER function is activated OR

Press the PHONE key or any key from 1...9, 0, \*, # when the AUTO ANSWER function is deactivated, to answer the call



or 1/...9/ 0/ \*/ #

2) End your call by placing the handset in the cradle or pressing PHONE.



#### 6.3.2 The Handset Is not located in the Cradle

1) Press the PHONE key or any key from 1...9, 0, \*, # to answer the call.



Or 1/...9/ 0/ \*/ #

### 6.4 Flash

During external call, a flash is generated on the line by pressing the key



### 6.5 Page Call

The page call function is used as an aid to locate the handsets.

#### 6.5.1 Paging from Base

Paging of all handsets is done by pressing the Page key in Base unit.



#### 6.5.2 Paging from Handset

Paging of all handsets is done by making an internal call to all handset as shown in the next section 'Making internal calls'.



## 6.6 Making Internal Calls

In order to carry out internal calls, more than one handset must be registered on the same base station.

1) Press the key.



2) Press the number of the required handset or '\*' key to page all handsets.

1...4 \*

OR

Press the UP/DOWN key to select the desired handset(s) in the menu, then press PHONE or PROG.



3) End the call by placing the handset in the cradle or pressing the PHONE key.



**Note:** If an external call is received during an internal call, a short acoustic signal is issued.

## 6.7 Call Toggling

If a portable is engaged in an external connection, it is possible to put the external call on hold and establish an internal call in the same way as the previous section 'Making internal calls'.

Then the display will become as below if handset #1 is selected.

TALK 1:35:06
HANDSET #1 H

The 'H' in the right hand side of the third line indicates having the external call on hold.

It is possible to toggle between an internal call and external call by pressing the key.

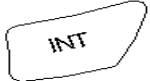

The 'H' is displayed too as below, when the internal call is put on hold.

TALK 1:35:50  
EXTERNAL CALL H

## 6.8 Call Transfer/Forward

An incoming call can be transferred or forwarded to the other handset during an ongoing call. The difference is that, when the call is transferred, the first handset waits for the other to answer before ending the connection, but when the call is forwarded, the first handset ends its connection immediately.

### 6.8.1 The Call is Transferred

1) Press the key (the external call is put on hold)



2) Press the number of the required handset or '\*' key for all handsets.

1... 4 \*

OR

Press the UP/DOWN key to select the desired handset(s) in the menu, then press PHONE or PROG (the external call is put on hold).



3) After the other handset has answered, press PHONE, or place your handset in the charge cradle.



### 6.8.2 The Call is Forwarded

1) Press the key (the external call is put on hold)

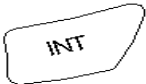

2) Press the number of the required handset or '\*' key for all handsets.

1 .. 4 \*

OR

Press the UP/DOWN key to select the desired handset(s) in the menu, then press PHONE or PROG. (the external call is put on hold)



3) Without waiting for an answer, press PHONE, or place the handset in the charger.



### 6.9 Call Back

After call forwarding, a callback is generated in the forwarding handset if the forwarded call is not answered within a certain period. If there is no CID information available 'Call back' is shown in the display; otherwise normal CID information is shown. If the returned call isn't answered within a certain period, the phone automatically goes on hook.

### 6.10 Conference

It is possible to establish a conference between two handsets and the external line. But only the first handset connected to the external line is allowed to transmit DTMF digits to the line. If digit keys are pressed on the second handset, they are blocked in the base station. If the handset has a connection to the external line, a conference is immediately established when another handset goes off hook by:

Press the key



If a handset has an active connection (internal or external) and another connection on hold, a conference can also be established by holding down the key.



Either handset can leave the conference by pressing PHONE.



The connection continues between the remaining handset and the external party.

### 6.11 Muting the Microphone

During conversation,

1) Press the CLEAR/DEL key to mute the handset microphone during a call.



2) Press CLEAR/DEL again to return to the two-way conversation.



### 6.12 Call Waiting

#### 6.12.1 Call Waiting on Intercom

If the handsets are engaged in an internal connection and an external incoming call arrives, the users are notified about this by a beep in the earpiece. The identity of the caller is presented in the display in the same way as a normal external call. The waiting call can be answered by pressing PHONE on either handset.



Then the internal connection is disconnected automatically.

If the waiting call is not answered, the display returns to previous screen after several seconds

Press and hold INT to disconnect the internal call without answering the waiting external call.



### 6.12.2 Call Waiting on Second External Call

The user may connect to a second external call upon hearing an alerting tone through the earpiece. The waiting call can be answered by pressing FLASH.



FLASH clears the second line in the display. If the waiting call is not answered, the display presentation will return back to normal ongoing call presentation after several seconds. For more convenient use, call waiting deluxe is also available.

## 7 Menu Structure

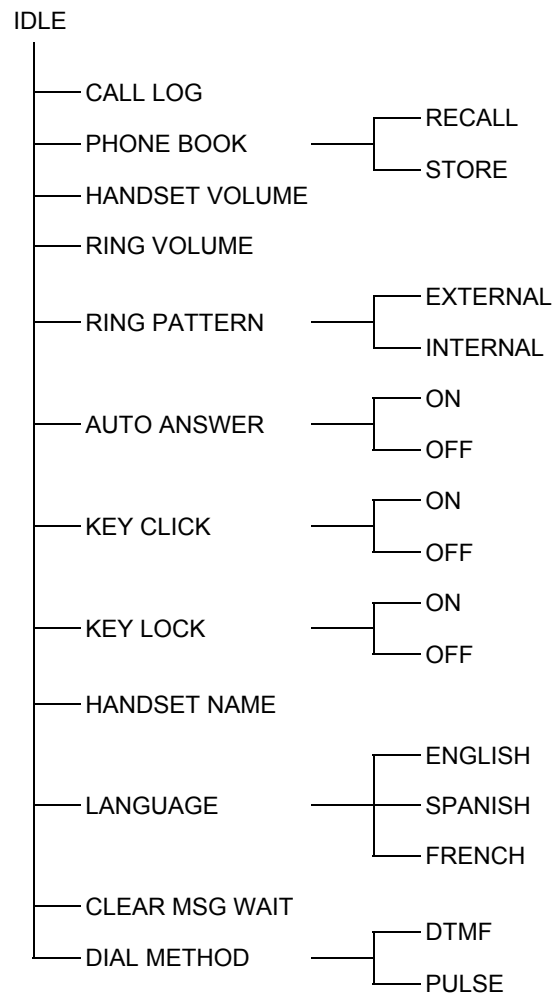

## 7.1 Call Log

### 7.1.1 Caller ID Review

- 1) Press **▼** while handset is in standby (idle) mode.



OR

Press **PROG**, to enter the menu at standby and then...



- 2) Press **PROG** once again, to enter Call log menu.



- 3) Scroll through the call log entries using **▲** and **▼**.



- 4) Dial the displayed CID record by pressing **PHONE**.



OR

- 5) Exit CID review mode by pressing **CANCEL**.



Remarks:

1. If the call log is full, the oldest entry is deleted to make room for the new call. If the call log is empty when the user tries to enter to Call log review, a message 'CALL LOG EMPTY' is displayed.
2. '!'-character in the right hand side of the second line indicates that the call has not previously been reviewed. The '!'-character is cleared when stepping to the next entry in the log or when leaving the call log. The maximum length of the name shown in the second line is 16 characters. If the name is longer, it is right truncated.
3. A number in the right hand side of the third line shows the call log number - 1 is the latest received call. The maximum length of the number shown in the third line is 16 characters. If the number is longer, it is left truncated.
4. The incoming calls are sorted by the order of arrival; the latest is shown first. A number is only contained once in the list. A new call from a caller that is already contained in the log removes the old entry and inserts the new call. All calls with blocked number are stored as individual calls.

### 7.1.2 Storing Caller ID Records

During caller ID review:

- 1) Scroll through the calls log using **▲** and **▼**.



- 2) Press **PROG** to select the record to be stored.



You can edit the name and number as needed.

- 3) Press **PROG** to confirm storage.



**NOTE:** If you attempt to store a CID record without name, an error tone will sound, and user will be required to enter a name.

### 7.1.3 Erasing CID Records

During CID review:

- 1) Scroll through the calls log using ▲ and ▼.



- 2) Press the **CLEAR/DEL** key to delete the displayed record.



The user will be asked 'DELETE?'

OR

- 3) Hold down **CLEAR/DEL** to erase **all** records.



The user will be asked 'DELETE ALL?'

- 4) Press **PROG** to confirm deletion.



OR

- 5) Press **CANCEL** to exit the calls log.



## 7.2 Phone Book Operation

### 7.2.1 Storing Names and Numbers

- 1) Press **PROG**.



- 2) Press ▼ to select PHONE BOOK.



- 3) Press **PROG** to confirm selection.



- 4) Scroll with the ▲/▼ keys.

With STORE in the second line, press **PROG**.



- 5) Enter the phone number, up to 24 digits.

Numbers more than 16 digits are 'left' truncated, with the last 16 digits shown.

- 6) Press **PROG**.



- 7) Using the keypad, enter the name. Each 'letter' key offers upper and lower case letters.

- 8) Press **PROG**.



If the Phone book is full, the Handset will display the 'PHONEBOOK FULL' message.

## 7.2.2 Phone Book Review

1) Press **MEM**.



OR

Press **PROG**, scroll through the menu choices, until **RECALL** is in the second line, then press **PROG**.

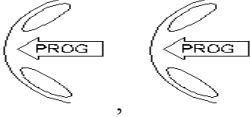

2) Scroll through phone book using the ▲/▼ keys;



OR

Enter the first letter of the desired name.

3) Press **CANCEL** to exit phone book review mode.





### 7.2.3 Editing Phone Book Names/Numbers

During phone book review:

1) Scroll through the phone book using the ▲/▼ keys,



OR

Enter the first letter of the desired name.

2) Press **PROG**, to enter edit mode.



Press **CLEAR/DEL** to erase a digit. Press and hold **CLEAR/DEL** to erase the entire number.



3) Press **PROG** to confirm and enter name edit mode.



4) Press **CLEAR/DEL** or ▼ to erase the right most letter.

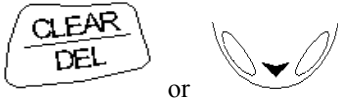

Press and hold **CLEAR/DEL** to erase the entire name.

5) Press **PROG** to confirm.



If the Phone book is full when the user tries to store a new number in it, a message 'PHONEBOOK FULL' is displayed.

### 7.2.4 Deleting Phone Book Names/Numbers

During phone book review:

1) Scroll through the phone book using the ▲/▼ keys.



2) Press **CLEAR/DEL**.

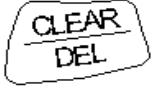

The user will be asked 'DELETE?'

3) Press **PROG** to confirm deletion.



OR

4) Press **CANCEL** to exit without deleting.



### 7.2.5 Dialling from the Phonebook

During phone book review:

1) Scroll through the phone book using the ▲/▼ keys,



OR

Enter the first character of the desired name.

2) Press **PHONE**, to dial.



## 7.3 Handset Volume

### 7.3.1 In Standby (Off) Mode

- 1) Press **PROG**.



- 2) Press ▼ two times



HANDSET VOLUME

- 3) Press **PROG**, to enter volume menu



- 4) Enter 0–7, 0 being the lowest and 7 the highest volume

OR

Use the ▲/▼ keys.



- 5) Press **PROG** to confirm.



### 7.3.2 During Conversation

Use the ▲/▼ keys. The screen will display the volume level in a bar graph.  
The default audio volume is 2.

## 7.4 Ring Volume

- 1) Press **PROG**



- 2) Press ▼ three times.



RING VOLUME

- 3) Press **PROG** to enter volume menu.



- 4) Enter 0 – 6, 0 for OFF and 6 being the loudest ring;

OR

Adjust using ▲/▼ keys. The ring is played as the volume is adjusted.



- 5) Press **PROG** to confirm.



**NOTE:** Ringing is switched off by adjusting the ring volume to zero. A 'ringer off' icon will be displayed on the Handset if that option is selected.

The default ring volume is 6.

## 7.5 Ring Pattern

1) Press **PROG**.



2) Press ▼ four times.



RING PATTERN

3) Press **PROG** to enter pattern menu.



4) Press the ▲/▼ keys to select EXTERNAL or INTERNAL ring setting, then press **PROG**.



5) Enter 0 – 9, or adjust using the ▲/▼ keys.



The user hears the different ring patterns during selection.

6) Press **PROG** to confirm the setting.



The default external and internal ring patterns are 0 and 1 respectively.

## 7.6 Auto Answer

The default setting is auto answer off. However, if you want your Handset to answer an incoming call by simply picking it up from its cradle:

1) Press **PROG**.



2) Press ▼ five times.



AUTO ANSWER

3) Press **PROG** to enter auto answer menu.



4) To turn auto answer On, press 1 or ▲. To disable, press 0 or ▼.



5) Press **PROG** to confirm the setting.



## 7.7 Key Click

Key clicks are the sounds you hear each time a key is pressed. The default mode is key click **ON**.

1) Press **PROG**.



2) Press ▼ six times.



**KEY CLICK**

3) Press **PROG** to enter key click menu.



4) Press 1 or ▲ to turn key click On; press 0 or ▼ to turn key click Off.



5) Press **PROG** to confirm your setting.



**NOTE:**Key click is disabled when the key lock is on.

## 7.8 Key Lock

### 7.8.1 Locking the Keypad

It is possible to lock the handset keypad. The key lock function is set/reset by:

1) Press **PROG**.



2) Press ▼ seven times.



**KEY LOCK**

3) Press **PROG** to enter key lock menu.



4) To enable key lock, press 1 or ▲; to disable, press 0 or ▼.



5) Press **PROG** to confirm the setting.



### 7.8.2 Unlocking the Keypad

When keypad is locked, the Handset will display **KEY LOCKED**. Pressing any key will generate **PRESS 159 TO UNLOCK** on the screen.

PRESS 159 TO UNLOCK
------------------------

To unlock, press 1, 5, 9  
'1', '5', '9'

When the keypad is locked, you can still dial and emergency call by first pressing PHONE and then the emergency number (e.g. 000, 110, 112, 119, 911, 999). Key lock is disabled after an emergency call.  
Key lock is disabled by default.

## 7.9 Handset Name

It is possible to name each handset. The name is shown in the first line during idle mode; i.e. it replaces the "READY" indication during idle mode.

1) Press **PROG**.



2) Press ▼ eight times.



HANDSET NAME

3) Press **PROG** to enter name menu.



4) Enter name

e.g. DAD'S PHONE

5) Press **PROG** to confirm.



## 7.10 Select LANGUAGE

Your Handset display can be in English (default mode), Spanish or French.

1) Press **PROG**.



2) Press ▼ nine times.



LANGUAGE

3) Press **PROG** to enter language menu.



4) Press 0 for English, 1 for Spanish, 2 for French;

0/ 1/ 2

OR,

Use the ▲/▼ keys.



5) Press **PROG** to confirm your selection.



## 7.11 Clear Message Waiting

You can remove the Message Waiting alert from the display:

1) Press **PROG**.



2) Press ▼ ten times.



CLEAR MSG WAIT

3) Press **PROG** to enter message menu.



4) Press **PROG** again to clear the alert or **CANCEL** to escape with clearing.

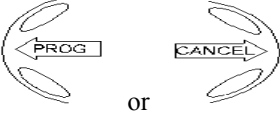

## 7.12 Dial Method

Your **OL2400** is preset for DTMF (Tone) dialing. To change the setting:

1) Press **PROG**.



2) Press ▼ eleven times.



DIAL METHOD

3) Press **PROG** to enter dial method menu.



4) For Pulse dialing, press 1 or ▲; for Tone dialing, press 0 or ▼.







5) Press **PROG** to confirm.





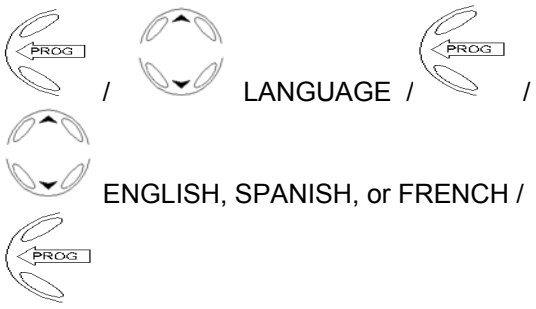
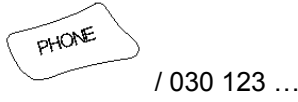
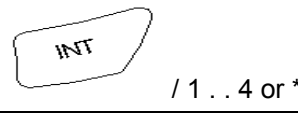























**NOTE:** If your Handset is set for Pulse dialing, if you press \* during a call, the Handset will switch to Tone dialing for the duration of the call.







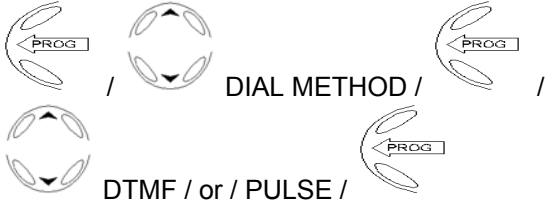

## 8 Overview of Telephone Functions

Select LANGUAGE	
Making external calls	
Making internal calls	
Receiving calls	
Call back	
Redialing	
Mute the microphone	

Storing call numbers	<p>PROG / PHONE BOOK / STORE / / 030 123 / / ABC /</p>
Editing call numbers	<p>MEM / ABC / / 030 12345 / / 030 12344 / / ABC / / ABA /</p>
Deleting call numbers	<p>MEM / ABC / CLEAR DEL DELETE ? /</p>
Dialing from the phonebook	<p>MEM / e.g. ABC / PHONE</p>
Handset receiving volume	<p>PROG / HANDSET VOLUME / 0 .. 7 /</p>

Handset ringing tone volume	 /  RING VOLUME /  /  0...6 / 
Change ringing tone pattern (external / internal)	 /  RING PATTERN /  /  EXTERNAL / or / INTERNAL /  /  0...9 / 
Activate / Deactivate automatic call answer	 /  AUTO ANSWER /  /  ON / or / OFF / 
Activate / Deactivate key tone on handset	 /  KEY CLICK /  /  ON / or / OFF / 
Activate / Deactivate key locking on handset	 /  KEY LOCK /  /  ON / or / OFF / 

Enter / Change handset name	
Dialing method	
Caller ID Review	
Caller ID Store	
Caller ID Erase	
Transferring calls	

<p>Conference calls</p> <p>When a handset has a connection, press the key can also be established.</p>	 A rectangular key icon with the word "PHONE" written inside in a slightly tilted orientation.
<p>Base Page handset</p>	 A semi-circular key icon with the word "PAGE" written inside in a slightly tilted orientation.

## **9 Consumer Information**

This equipment complies with Part 68 of the FCC rules and the requirements adopted by the ACTA. On the back of this equipment is a label that contains, among other information, a product identifier in the format US: 2X6WI00B2G4C2302. If requested, this number must be provided to the telephone company.

An applicable certification jacks Universal Service Order Codes (USOC) for the equipment is provided (i.e., RJ11C) in the packaging with each piece of approved terminal equipment.

A plug and jack used to connect this equipment to the premises wiring and telephone network must comply with the applicable FCC part 68 rules and requirements adopted by the ACTA. A compliant telephone cord and modular plug is provided with this product. It is designed to be connected to a compatible modular jack that is also compliant. See installation instructions for details in section (2).

The REN is used to determine the number of devices that may be connected to a telephone line. Excessive RENs on a telephone line may result in the devices not ringing in response to an incoming call. In most but not all areas, the sum of RENs should not exceed five (5.0). To be certain of the number of devices that may be connected to a line, as determined by the total RENs, contact the local telephone company. The REN for this product is part of the product identifier that has the format US: 2X6WI00B2G4C2302. The digits represented by 00 are the REN without a decimal point (e.g., 03 is a REN of 0.3). The REN is separately shown on the label too.

If this equipment OL2400 causes harm to the telephone network, the telephone company will notify you in advance that temporary discontinuance of service may be required. But if advance notice isn't practical, the telephone company will notify the customer as soon as possible. Also, you will be advised of your right to file a complaint with the FCC if you believe it is necessary.

The telephone company may make changes in its facilities, equipment, operations or procedures that could affect the operation of the equipment. If this happens the telephone company will provide advance notice in order for you to make necessary modifications to maintain uninterrupted service.

Please follow instructions for repairing if any (e.g. battery replacement section); otherwise do not alternate or repair any parts of device except specified.

Connection to party line service is subject to state tariffs. Contact the state public utility commission, public service commission or corporation commission for information.

This equipment is hearing aid compatible.

### **NOTICE:**

1) If your home has specially wired alarm equipment connected to the telephone line, ensure the installation of this OL2400 does not disable your alarm equipment. If you have questions about what will disable alarm equipment, consult your telephone company or a qualified installer.

2) According to telephone company reports, AC electrical surges, typically resulting from lightning strikes, are very destructive to telephone equipment connected to AC power sources. To minimize damage from these types of surges, a surge arrestor is recommended.

Should you experience trouble with this equipment, please contact US Returns Center, Wave Industries, with the below information for warranty information. If the equipment is causing harm to the telephone network, the telephone company may request that you disconnect the equipment until the problem is resolved.

**QUESTIONS??????**

**OUR HELP LINE IS**

**1-866-537-0384**

**Wave Industries c/o Moore Co.  
123 S.E. 2<sup>nd</sup> Ave., Door #13,  
Portland, OR 97214**

**WARNING:** Changes or modifications to this unit not expressly approved by the party responsible for compliance could void the user's authority to operate the equipment.

**CAUTION:** To maintain compliance with the FCC's RF exposure guidelines place the base unit at least 20 cm from nearby persons.

**NOTE:** This equipment has been tested and found to comply with the limits for a Class B digital device, pursuant to Part 15 of the FCC Rules. These limits are designed to provide reasonable protection against harmful interference in a residential installation. For body worn operation, this phone has been tested and meets the FCC RF exposure guidelines when used with the belt clip supplied or designated for this product. Use of other accessories may not ensure compliance with FCC RF exposure guidelines. This equipment generates, uses and can radiate radio frequency energy and, if not installed and used in accordance with the instructions, may cause harmful interference to radio communications. However, there is no guarantee that interference will not occur in a particular installation. If this equipment does cause harmful interference to radio or television reception, which can be determined by turning the equipment off and on, the user is encouraged to try to correct the interference by one or more of the following measures:

- Reorient or relocate the receiving antenna.
- Increase the separation between the equipment and receiver.
- Connect the equipment into an outlet on a circuit different from that to which the receiver is needed.
- Consult the dealer or an experienced radio TV technician for help.

This device complies with part 15 of the FCC rules. Operation is subject to the following two conditions: (1) This device may not cause harmful interference and (2) This device must accept any interference received. Including interference that may cause undesired operation.

Privacy of communications may not be ensured when using this phone.