

# Cobra®

Cobra Electronics Corporation  
6500 West Cortland Street  
Chicago, IL 60707

## If You Think You Need Service

*For technical assistance, please call our Automated Help Desk which can assist you by answering the most frequently asked questions about Cobra products.*

**(773) 889-3087**

*24 hours a day, 7 days a week.*

*A Consumer Service Representative can be reached through this same number 8:00 am - 8:00 pm, Monday through Friday, CST.*

*Technical assistance is also available on-line in the Frequently Asked Questions (FAQ) section at [www.cobraelec.com](http://www.cobraelec.com) or by e-mail to [productinfo@cobraelec.com](mailto:productinfo@cobraelec.com)*

**If you think you need service call 1.773.889.3087**

***"If your product should require factory service please call Cobra first before sending your unit in. This will ensure the fastest turn-around time on your repair."***

You may be asked to send your unit to the Cobra factory. It will be necessary to furnish the following in order to have the product serviced and returned.

1. For Warranty Repair include some form of proof-of-purchase, such as a mechanical reproduction or carbon or a sales receipt. If you send the original receipt it cannot be returned.
2. Send the entire product.
3. Enclose a description of what is happening with the unit. Include a typed or clearly print name and address of where the unit is to be returned.
4. Pack unit securely to prevent damage in transit. If possible, use the original packing material.
5. Ship prepaid and insured by way of a traceable carrier such as United Parcel Service (UPS) or First Class Mail: to avoid loss in transit to: Cobra Factory Service, Cobra Electronics Corporation, 6500 W. Cortland St., Chicago, IL 60707.
6. If the unit is in warranty, upon receipt of your unit it will either be repaired or exchanged depending on the model. Please allow approximately 3 to 4 weeks before contacting us for status. If the unit is out of warranty a letter will automatically be sent informing you of the repair charge or replacement charge. If you have any questions, please call 1.773.889.3087 for assistance.

Cobra Electronics Corp. © 1999  
Printed in Thailand  
Part No. 480-271-P-001

# Cobra® HH38 WX ST

Operating Instructions  
for your Cobra HH 38 WX ST

## Citizens Band 2-Way Handheld CB Radio



"Ingenuous Products for Easier Communication."

# Controls and Indicators

# Our Thanks to You

1. BNC Antenna Connector
2. Squelch Control
3. On/Off Volume Control
4. Removable Belt Clip
5. External Speaker Jack
6. External Microphone Jack
7. Charge LED
8. NiCad Battery Charge Jack
9. DC Power Jack
10. Light Key
11. Channel Up/Down Keys
12. PTT (Push To Talk) Key
13. Battery Chamber
14. LCD Display Panel
15. Lock Key
16. SoundTracker™ Key
17. CB/WX Weather Key and HI/LO Power Key
18. Instant Channel 9 & 19 and Dual Watch Key
19. Function Key
20. Channel Scan
21. Microphone

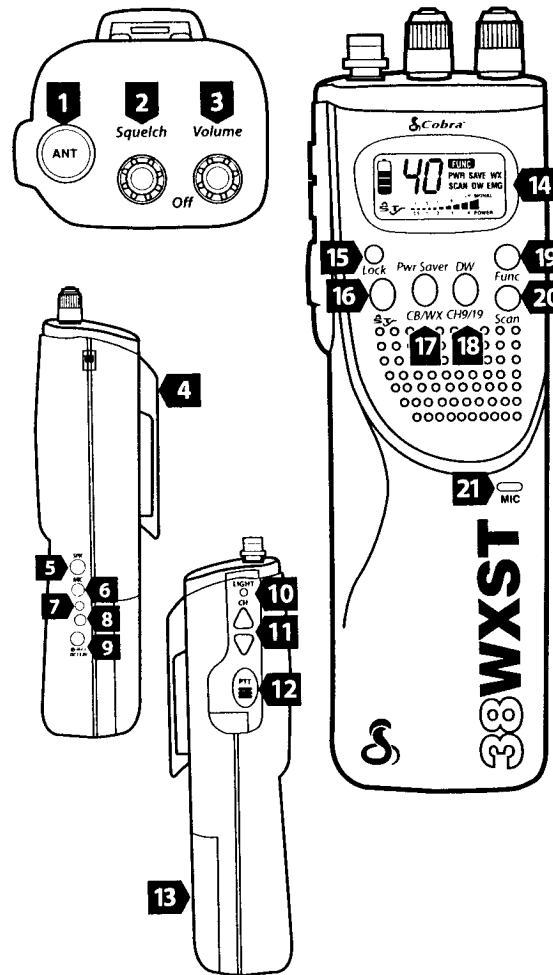

Thank you for purchasing the Cobra HH 38 WX ST handheld CB. Properly used, this Cobra product will give you many years of reliable service.

## SoundTracker™

"Cuts noise coming in...strengthens signals going out."

This Patent pending technology dramatically improves transmission and reception of CB signals.

The revolutionary SoundTracker™ System reconfigures the transmission signal which allows it to be transferred more efficiently through cluttered airwaves.

At the same time, it significantly reduces the amount of static on all incoming CB signals.

The end result is a cleaner, clearer sounding reception of signals and a more powerful transmission which dramatically improves CB communications.

## Customer Support

Should you encounter any problems with the product or not understand its many features, please refer to this owner's manual. If, after referring to the manual, you still need help, call Cobra Customer Service at 773.889.3087.

## Cobra Customer Service

Live operators are available  
M-F 8:00 am - 8:00 pm CST at:  
773.889.3087

Automated Technical Assistance,  
available 24 hours a day, seven  
days a week. E-mail questions  
to:  
productinfo@cobraelec.com

Cobra on the World Wide Web:  
Frequently Asked Questions  
(FAQ) can be found on-line at:  
www.cobraelec.com

# The CB Story

# How to Use Your Cobra<sup>HH</sup> 38 WX ST

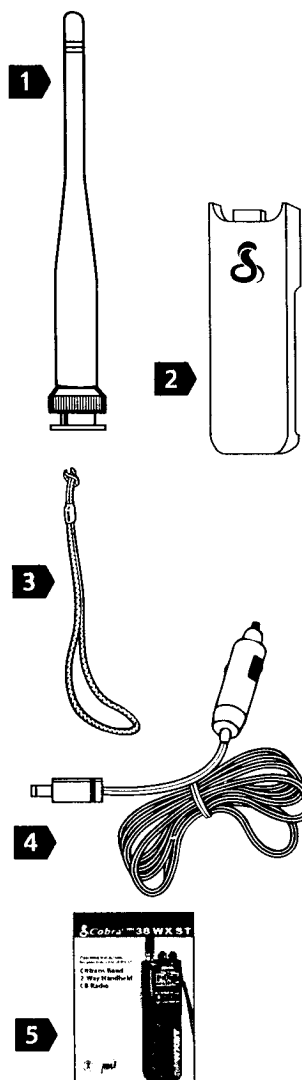

The Citizens Band lies between the shortwave broadcast and 10-meter Amateur radio bands, and was established by law in 1949. The Class D two-way communications service was opened in 1959. (CB also includes a Class A citizens band and Class C remote control frequencies.)

### FCC Regulations

FCC regulations permit only "transmissions" (one party to another) rather than "broadcasts" (to a wide audience). Thus, advertising is not allowed on CB Channels because that is "broadcasting."

### FCC Warnings

All transmitter adjustments other than those supplied by the manufacturer as front panel operating controls, must be made by, or under the supervision of, the holder of an FCC-issued general Radio-Telephone Operator's License.

Replacement or substitution of transistors, regular diodes or other parts of a unique nature, with parts other than those recommended by Cobra, may cause violation of the technical regulations of Part 95 of the FCC Rules, or violation of Type Acceptance requirements of Part 2 of the Rules.

You should read and understand Part 95 (included with this unit) of the FCC Rules and Regulations, before operating your Cobra radio, even though the FCC no longer requires you to obtain an operator's license.

### What's Included with Your HH 38 WX ST

1. High Efficiency Antenna
2. Removable Belt Clip
3. Wrist Strap
4. 12 Volt Cigarette Lighter Plug
5. Operating Manual

## Contents

<b>Features</b> .....	1
<b>The CB Story</b> .....	A1
FCC Regulations	
Included Accessories	
<b>Controls &amp; Indicators</b> .....	A2
<b>Our Thanks to You</b> .....	A3
SoundTracker™ System	
Customer Support	
<b>Operating Your HH 38 WX ST</b>	
Antenna .....	2
Battery Installation .....	3
Belt Clip .....	3
Turning on Your CB .....	4
Setting Squelch .....	4
Selecting a Channel .....	6
LCD Display .....	7
Transmit/Receive .....	8
One Touch Channel 9 & 19 .....	10
All Channel Scan .....	11
Dual Watch .....	12
Weather Channels .....	14
Power High/Low .....	16
Battery Capacity Level .....	18
SoundTracker™ System .....	19
Lighted Display .....	23
Lock Key .....	24
In Vehicle Use .....	25
<b>How Your CB Can Serve You</b> .....	26
A Few Rules You Should Know .....	26
Weather Channel Messages .....	27
Channel 9 Emergency Messages .....	28
CB 10 Codes .....	30
<b>Frequency Ranges</b> .....	32
<b>HH 38 WX ST Specifications</b> .....	33
<b>Warranty Information</b> .....	34
<b>Optional Accessories</b> .....	35
<b>Order Form</b> .....	36
<b>If You Think You Need Service</b> .....	Back Cover

### Features of This Product

- 40 CB Channels
- 10 Weather Channels
- Full Feature LCD Display
- Dual Channel Watch
- Full Channel Scan
- Battery Level Meter
- External Speaker/ Microphone Jack
- Instant Channel 9 & 19
- High/Low Power Saver Switch
- BNC Antenna Connector
- Lock Key

# Operation

## Attach Antenna

### Note

To increase range as a portable, use CA41 telescopic loaded long range antenna. (See Accessory Page 35).

## Attach Antenna

- 1 Insert.

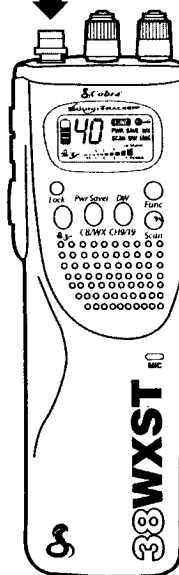

- 2 Turn clockwise. 1/4 turn.

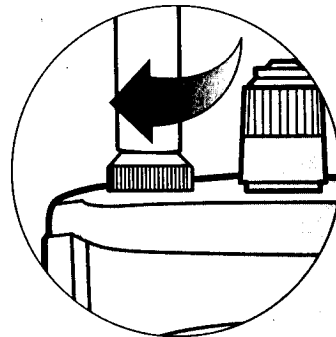

# Operation

## Install Batteries

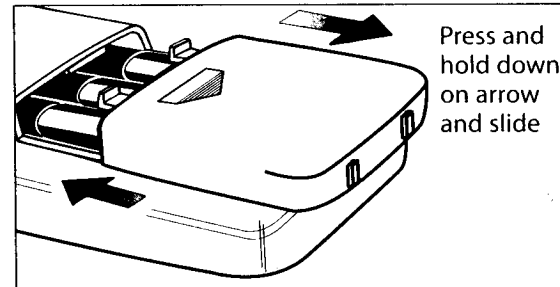

Press and hold down on arrow and slide

- 1 Remove battery chamber cover. Press down on arrow and slide.
- 2 Install batteries by polarity markings.
- 3 Replace cover.

NiCad rechargeable batteries should be charged a minimum of 12 hours with a CA-45C charger.

## Attach Belt Clip

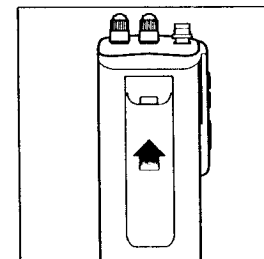

- 1 Slide belt clip up on rails of base until tab locks.

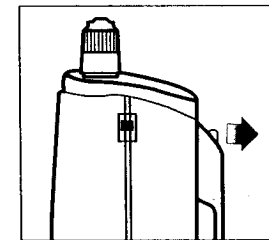

- 2 To remove belt clip, lift tab out and slide belt clip down.

## Battery Installation

### Note

Ignoring polarity markings (+/-) can cause damage to both the unit and the batteries.

The HH 38 WXST requires 9 "AA" alkaline or NiCad batteries (not included with the unit).

When batteries are low or need charging the BATTERY icon will flash on the LCD display. Replace alkaline batteries or recharge NiCad batteries.

NiCad rechargeable batteries should be charged a minimum of 12 hours with a CA-45C charger.

NiCad rechargeables should have a rating of 1.2 vdc, 750 Mah.

## Attach Belt Clip

### Note

Clip slides up to attach and slides down to remove.

# Operation

## Turning On

### Note

When you turn the HH 38 WX ST on, a series of tones will be heard and the icons will briefly appear on the LCD display.

LCD lights on for 5 seconds.

## Turning On

Rotate ON - OFF Volume Control  clockwise.

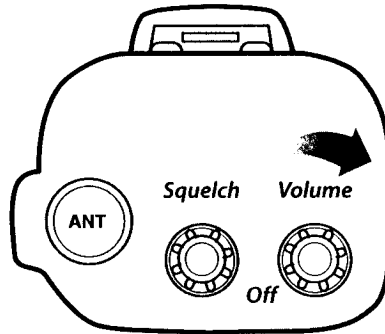

## Setting Squelch

### Gate closed

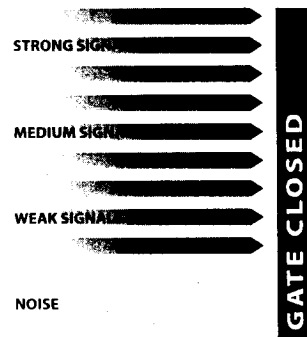

## Setting Squelch

Squelch is the "control gate" for incoming signals.

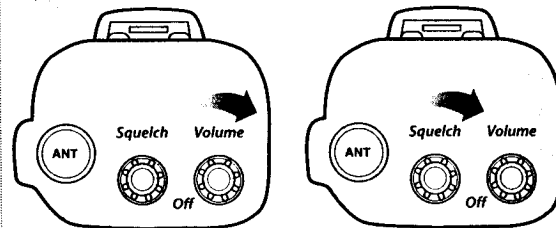

- 1 Turn volume up louder than normal.
- 2 Fully  clockwise closes the "gate", allowing no incoming signals.

4

# Operation

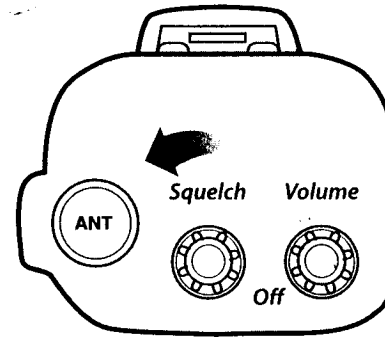

- 2 Fully  counter-clockwise opens the "gate" and all signals enter.

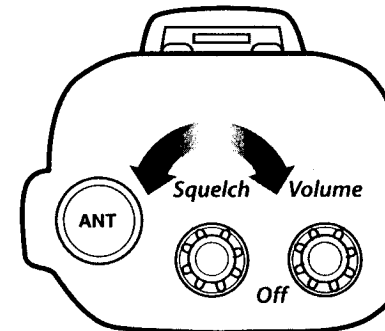

- 3 To achieve the Desired Squelch Setting (DSS), turn the Squelch control  counter-clockwise until you hear noise. Now turn the control *clockwise* just until the noise stops. This is the DSS setting.

### Gate open

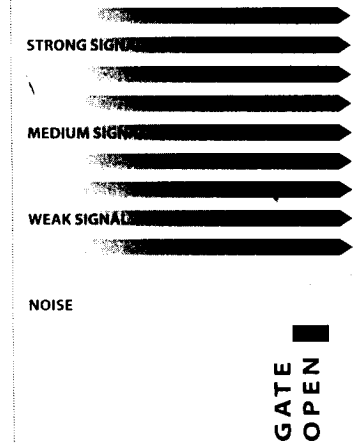

### Gate set to Desired Squelch Setting (DSS)

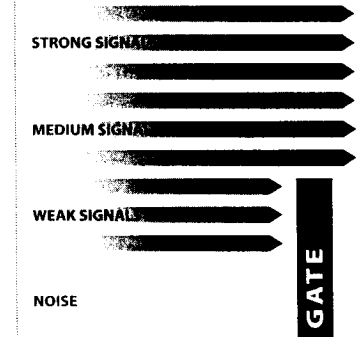

5

# Operation

## Select Channel

**Note**

For quick advance, push and hold arrow key(s).

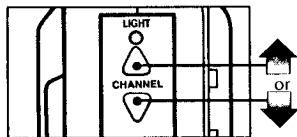

**Note**

When switching from one channel to another, squelch will need to be reset. See Setting Squelch on pages 4 and 5.

## Select Channel

- 1 Turn power ON.
- 2 For higher channel, push  $\triangle$  UP arrow key.
- 3 For lower Channel, push  $\nabla$  DOWN arrow key.

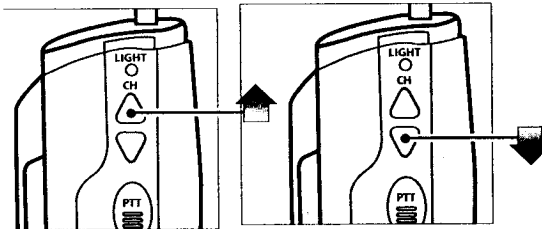

# Operation

## LCD Display

All needed information is displayed on LCD display panel.

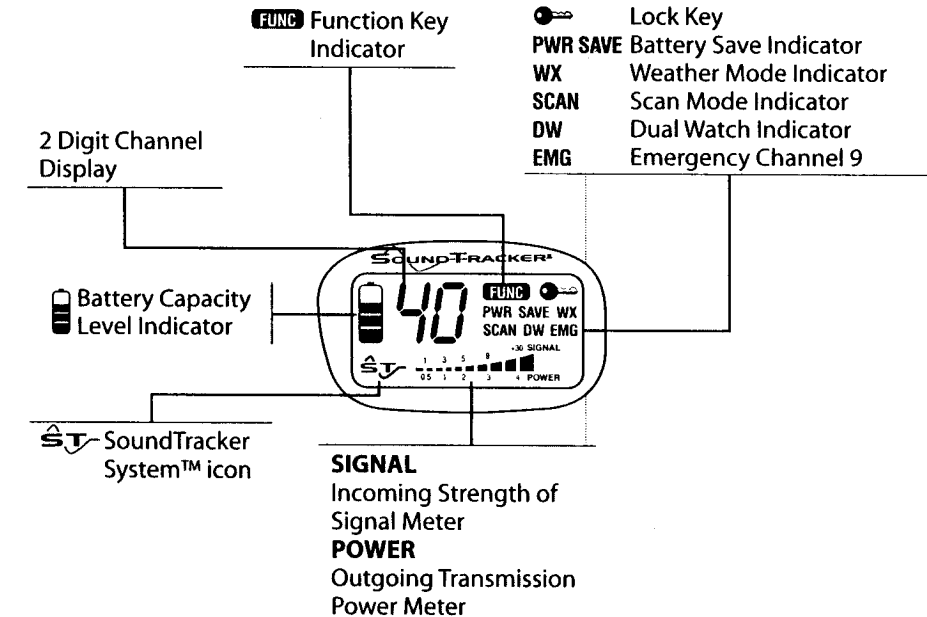

# Operation

## Transmit/Receive

### Stop

Antenna must be installed before TX

### Note

While  PTT button is depressed you cannot receive transmissions.

### Note

During transmit, your outgoing transmission power is measured in watts and displayed on the bar graph.

## Transmit / Receive

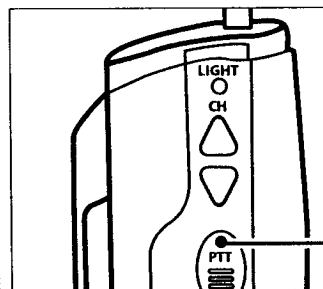

**PUSH & HOLD**

- 1 To transmit, push and hold  PTT button.

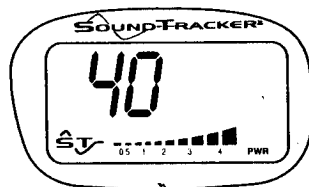

- 2 The TRANSMISSION POWER METER will be displayed when transmitting.

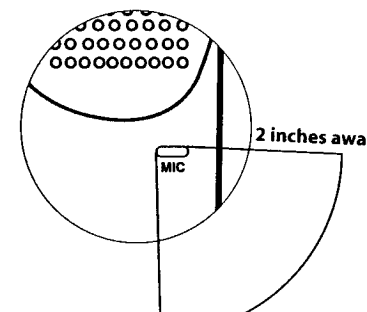

- 3 Hold mic about 2 inches from mouth. Speak in a normal voice.

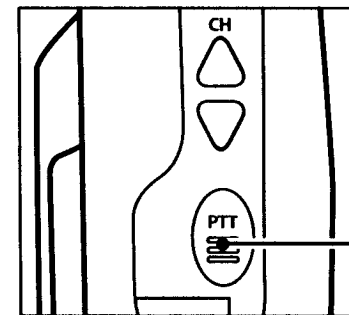

**RELEASE**

- 3 Release  PTT button to receive incoming transmissions.

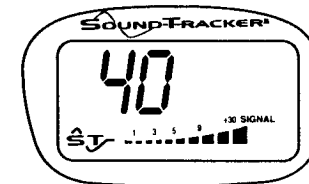

The INCOMING SIGNAL STRENGTH METER will be displayed when a signal is received.

### Note

Your HH38 WX ST is always ready to receive incoming signals when the PTT button is released.

When you are receiving an incoming signal, the strength of that signal will be displayed on the bar graph.

# Operation

# Operation

## One Touch for Channel 9 and Channel 19

**Note**  
Pressing CHANNEL UP/DOWN key will exit you from this mode.

### One Touch For Channel 9 and Channel 19

To gain instant access to Channels 9 (emergency) and 19 (information) from other channels:

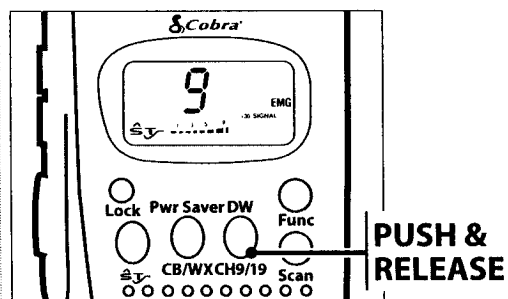

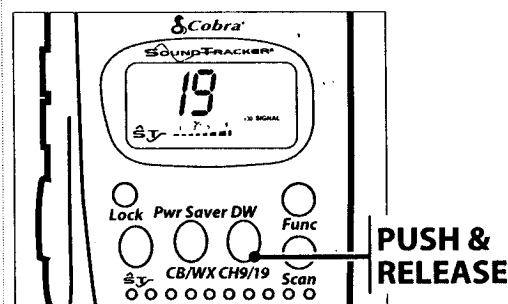

- 1 Push  CH 9/19 once for channel 9.

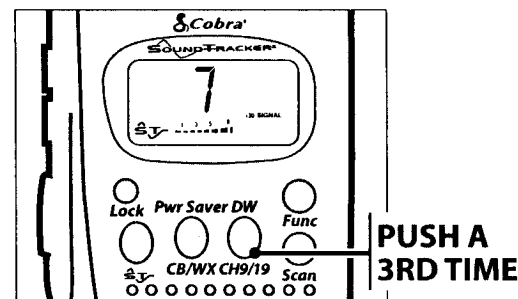

- 2 Push  CH 9/19 twice for Channel 19.

# Operation





- 3 To return to original channel, push  CH 9/19 a third time.

### All Channel Scan

To scan all 40 channels:

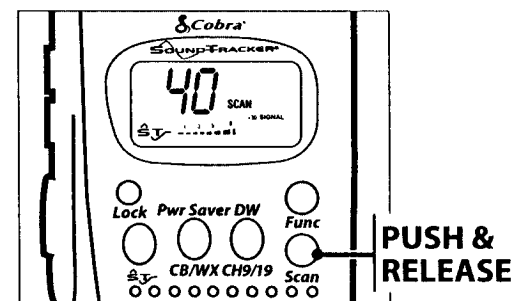
- 1 Set Desired Squelch Setting (DSS).



- 2 Push  SCAN key. The channels will index.
- 3 To stop scanning, push  SCAN key again.

### All Channel Scan

#### Note

When an incoming transmission is received the HH 38 WX ST will stop scanning.

10 seconds after scan stops, scanning will resume.

#### Note

To set Desired Squelch Setting (DSS) see Setting Squelch on pages 4 and 5.

Pressing PTT key or scan key will terminate scan mode.



## Dual Watch

**Note**

To set Desired Squelch Setting (DSS) see Setting Squelch on pages 4 and 5.

### Dual Watch

Dual Watch allows simultaneous monitoring of two preselected channels. To monitor Channel 11 and 17 for incoming transmissions:

- 1 Set Desired Squelch Setting (DSS).
- 2 Select Channel 11 with CHANNEL UP/DOWN key.

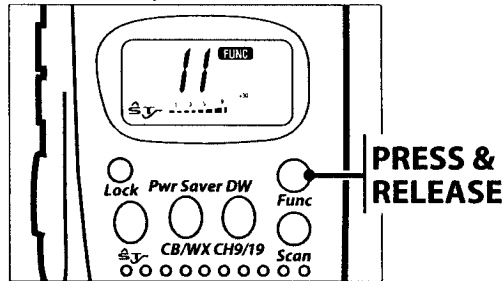

- 3 Push and release FUNCTION key. FUNCTION icon will be displayed.

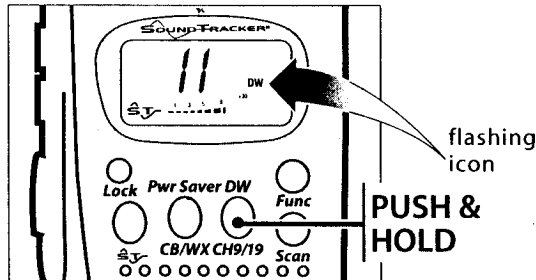

- 4 Push and hold DW key until "beep" is heard. The DW icon will flash and the FUNCTION icon will disappear.

**Note**

At a later time you can recall your preset DW channels by pushing and releasing the FUNCTION key and quickly pushing and releasing the DW key.

- 5 Select Channel 17 with CHANNEL UP/DOWN key.

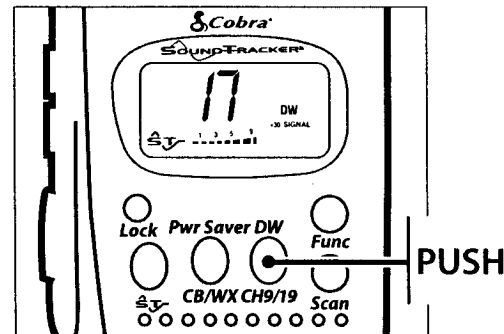

- 6 Push DW key until "beep" is heard. The DW icon will stay on.

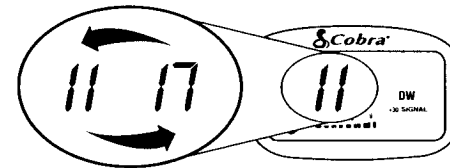

- 7 The HH 38 WX ST display will switch between the selected channels.
- 8 To stop dual watch, push CHANNEL UP/DOWN key on the HH 38 WX ST.

**Note**

When a transmission is received the HH 38 WX ST will stop monitoring. 10 seconds after the DW stops, monitoring will continue between the two channels.

# Operation

## Weather Channels

### Note

The 10 National Weather Channels include 7 NOAA and 3 Canadian channels. These channels provide full coverage to keep you informed of weather conditions, 24 hours a day, 7 days a week.

For a list of weather frequencies see specifications in the Frequency Ranges section on page 36.

### Note

Your 38 WX ST has a special auto squelch circuit for weather transmission which disables your squelch control.

## Weather Channels

10 National Weather Channels provide weather transmission reception.

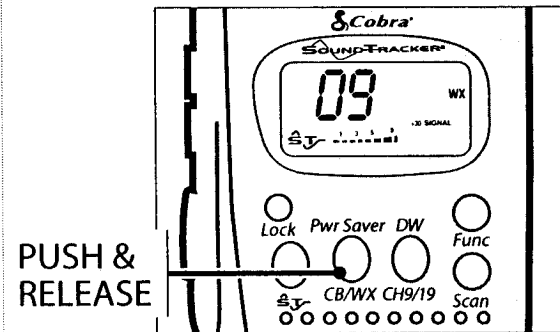

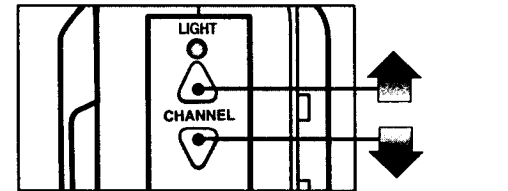

- 1 Push and release the  CB/WX key and the current weather channel will appear.

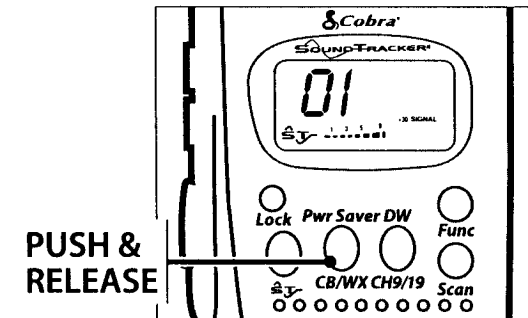

- 2 To change weather channels push the  CHANNEL UP/DOWN arrow keys.

At times, different channels can be received. Select the one with the clearest audio quality.



- 3 To return to normal CB operation, push and release the  CB/WX key again.

The WX icon will disappear.

# Operation

### Note

An agency of the U.S. Department of Commerce, NOAA operates 380 stations which reach about 90% of the U.S. population. If you cannot receive a weather station, you may not have one in your area.

If you wish to receive a listing of NOAA Weather Radio Transmitter locations, contact your nearest National Weather Service Office, or write to:

National Weather Service  
(Attn: W/OM11), NOAA  
Silver Spring, MD 20910

## Power Saver (HI/LOW)



### Note

The low power setting cuts the transmitting range in half, but the receiving range is not affected.

### Power Saver (HI/LOW)

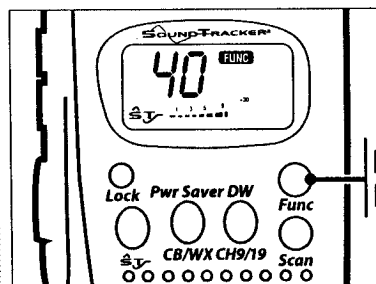
Reduces transmit power output to 1 watt to extend battery life.



- 1 Push and release the  FUNCTION key.  FUNCTION icon will be displayed.

**PRESS & RELEASE**

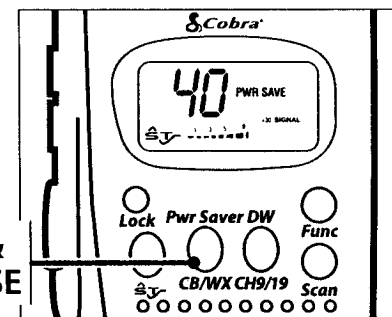

**PUSH & RELEASE**

- 2 Push and release the  key.

The **PWR Save** icon will appear and the **FUNCTION** icon will disappear.

- 1 **To exit Power Saver (HI/LOW) mode:**

Push and release  FUNCTION key.

 FUNCTION icon will be displayed.

- 2 Push and release the  key.

- 3 FUNCTION and PWR Save icon will disappear

### Note

Battery life is increased approximately 50% while in Battery Power Save Mode is activated. This reduces transmit power output to 1 watt.

# Operation

## Battery Capacity Level

**Note**  
Battery life is approximately 20 hours under normal use conditions.

### Battery Capacity Level

To monitor the remaining power level of the HH 38 WX ST battery: check battery icon bands.

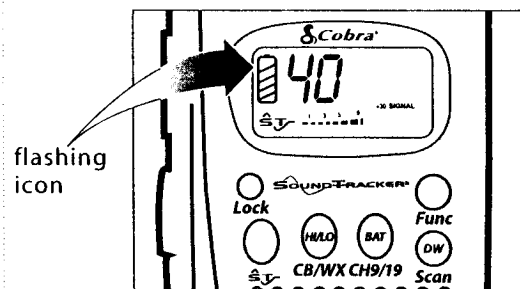

 BATTERY icon will flash if batteries are low. Replace batteries as soon as possible.

# Operation

## The SoundTracker™ System

While previous systems only "blanket out" or limit noise in higher sound frequencies, the revolutionary new SoundTracker™ System actually reduces noise while leaving the signal intact in the reception mode. In the transmission mode, it actually strengthens the signal, providing you with a significant reduction in noise on reception and transmission.

**Sound clarity is measured by the ratio of the signal level to the noise level. The higher the signal-to-noise ratio, the better the sound.**

### How SoundTracker™ Works

*On Reception - "Cuts noise coming in"*

With a normal CB, distant signals fall below the squelch level and are unintelligible. With a SoundTracker™ CB, the noise level is cut up to 90%, which increases the signal-to-noise ratio and dramatically improves signal clarity. This also allows you to significantly reduce the squelch level, which greatly expands your listening range.

*On Transmission - "Strengthens signals going out"*

A SoundTracker™ CB strengthens the transmit signal by more effectively using the available RF power output of the CB. The result is improved transmission signal clarity and an expanded transmission range.

## SOUNDTRACKER™ SYSTEM

### Note

*SoundTracker™ gives you clearer, cleaner reception to improve CB communications while on the air.*

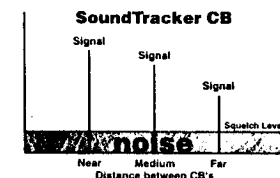
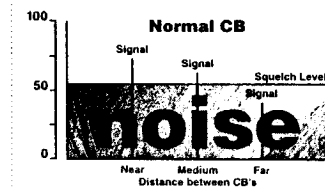

## Activating SoundTracker™

**Note**  
This engages the SoundTracker™ system and reduces the noise level.

### Activating SoundTracker™

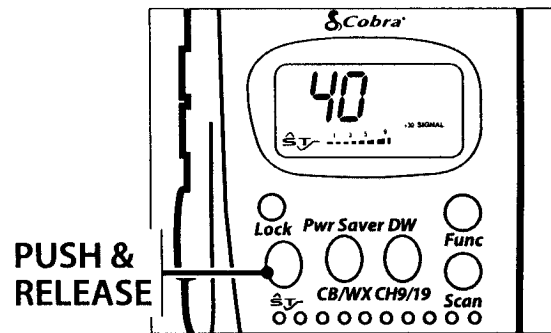

- 1 Push and release the  ST key.

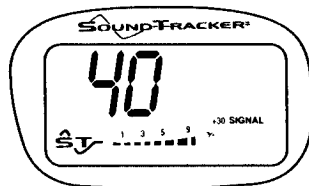

The  SOUNDTRACKER icon will appear.

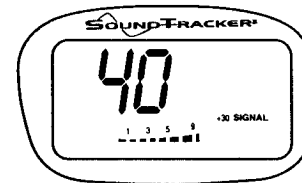

## Testing SoundTracker™

### Testing SoundTracker™

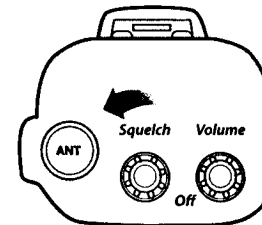

- 1 Select any unused channel on your CB.



- 2 Fully  counterclockwise opens the "gate" and all signals enter. Turn the knob until it stops.
- 3 Deactivate soundtrack mode by pressing  key if the  icon is displayed

continued

# Operation

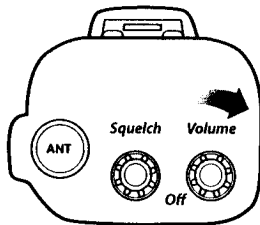

- 3 Turn the volume up louder than your normal listening level.

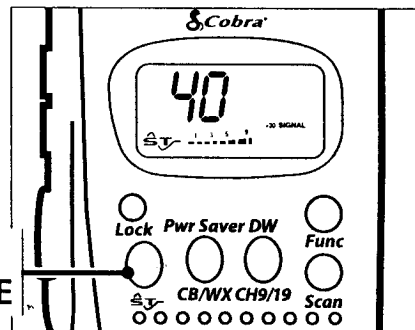

**PUSH & RELEASE**

- 4 Push and release the  ST key.

The  SOUNDTRACKER icon will appear.  
\*Notice the significant reduction in noise.



### Note

At times you may experience different levels of noise reduction. Different terrains and environments will effect the SoundTracker™ System's performance.

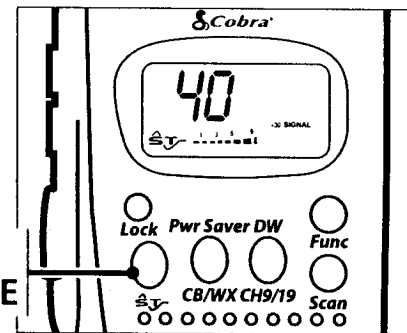
# Operation



**PUSH & RELEASE**

- 5 To disengage SoundTracker™ push and release  ST key again.
- 6  icon will disappear.

### Lighted Display

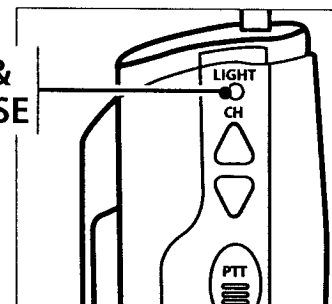

**PUSH & RELEASE**

- 1 To illuminate display, push and release light key. Light will remain on for 10 seconds.

### Lighted Display

# Operation



## Lock Key

**Note**  
PTT, LIGHT, VOLUME,  
SQUELCH and LOCK functions  
are still operational while the  
LOCK function is activated.

## Lock Key

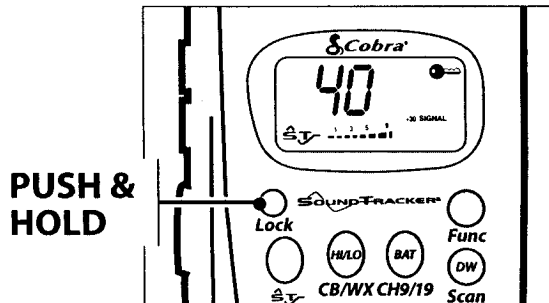
Purpose is to lock most functions to avoid accidental actuation.



- 1 To lock, push and hold the  LOCK key for two seconds. The  LOCK icon will appear.

To unlock, push and hold  LOCK key for 2 seconds again.

# Operation

## In Vehicle Use

The HH 38 WX ST can be connected to your cigarette lighter with the provided adapter. **This power connection does NOT charge the batteries.**

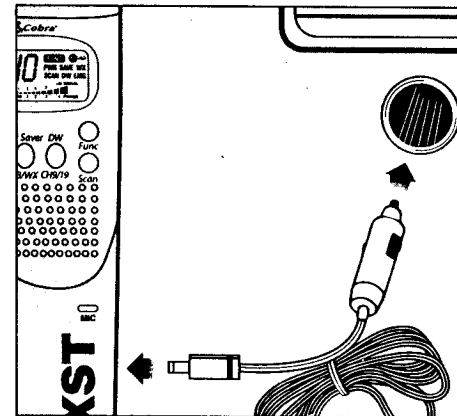

## In Vehicle Use

### Note

Due to the characteristics of CB transmissions, it is necessary to use an external car roof/truck magnet mounted antenna (item # ATW-400) and a BNC adapter (item # CA-43) to receive optimal performance while in your vehicle. See Accessories section on page 39.

### Note

DC/Power Cord is provided.  
To increase range as a portable, use CA41 telescopic loaded long range antenna.

## How Your CB Can Serve You

- Warn of traffic problems
- Provide weather and road data
- Provide help in event of an emergency
- Provide direct contact with home or office
- Assist police by reporting erratic drivers
- Get "local information" to find destination
- Communicate with family and friends
- Suggest spots to eat and sleep
- Keep you alert while traveling

### A Few Rules You Should Know

#### A Few Rules You Should Know

- A. Conversations cannot last more than 5 minutes with another station. A one minute break is required to let others use the channel.
- B. You cannot blast others off the air by use of illegally amplified transmitters or illegally high antennas.
- C. You cannot use CB to promote illegal activities.
- D. Profanity is not allowed.
- E. You may not transmit music with a CB.
- F. Selling of merchandise and/or services is prohibited.

## How Your CB Can Serve You

### Weather Channel Messages

Local weather reports are provided by NOAA (National Oceanic Atmospheric Administration) 24 hours a day, 7 days a week. An agency of the U. S. Department of Commerce, NOAA operates 380 stations which reach about 90% of the U. S. population. If you cannot receive a weather station, you may not have one in your area. A similar network of 15 stations broadcasts continuous weather information across much of southern Canada.

### Weather Channel Messages

#### Note

*If you wish to receive a listing of NOAA Weather Radio Transmitter locations, contact your nearest National Weather Service Office, or write to:*

*National Weather Service  
(Attn: W/OM11), NOAA  
Silver Spring, MD 20910*

*For a list of weather frequencies see specifications in the Frequency Ranges section on page 36.*



## How Your CB Can Serve You

### Channel 9 Emergency Messages

**Note**

If no response on channel 9,  
try channels 19 or 14.

#### 1. Set to channel 9 for emergencies

Be sure antenna is properly connected.

#### 2. CB Distress Data

When transmitting an emergency, you should request a "REACT BASE" and provide the CB distress data (called **CLIP**):

**C** all Sign *Identify yourself.*  
**L** ocation *Be exact.*  
**I** njuries *Number. Type. Trapped?*  
**P** roblem *Give details and help needed.*

Transmit **CLIP** repeatedly so any monitor can assist.

## How Your CB Can Serve You

The FCC gives these examples of permitted and prohibited messages for channel 9. These are only guidelines and not all-inclusive:

Permitted	Example Message
Yes	"Tornado sighted six miles north of town."
No	"Post number 10. No tornado sighted."
Yes	"Out of gas on I-95 at mile marker 211."
No	"Out of gas in my driveway."
Yes	"Four car accident on I-94 at Exit 11. Send police and ambulance."
No	"Traffic moving smoothly on I-94."
Yes	"Weather Bureau has issued thunderstorm warning. Bring sailboat into port."
No	"Attention motorists. Weather Bureau advises snow tomorrow will accumulate 4 to 6 inches."
Yes	"Fire in building at 539 Main, Evanston."
No	"Halloween patrol number 3. All quiet."

## How Your CB Can Serve You

### CB 10-Codes

#### CB 10-Codes

Citizen Bands have adopted the "10-CODES" for standard questions and answers. These codes provide quick and easy communication, especially in noisy areas. Following are some of the more common codes and meanings:

Code	Meaning
10-1	Receiving poorly
10-2	Receiving well
10-3	Stop transmitting
10-4	OK, message received
10-5	Relay message
10-6	Busy, stand by
10-7	Out of service, leaving
10-8	In service, subject to call
10-9	Repeat message
10-10	Transmission completed standing by
10-11	Talking too rapidly
10-12	Visitors present
10-13	Advise weather/roads
10-16	Make pick up at
10-17	Urgent business
10-18	Anything for us?
10-19	Return to base
10-20	My location is
10-21	Call by phone
10-22	Report in person to
10-23	Stand by
10-24	Completed last assignment
10-25	Can you contact
10-26	Disregard last info
10-27	Moving to channel
10-28	Identify your station

## How Your CB Can Serve You

#### Code Meaning

10-29	Time is up for contact
10-30	Does not conform to FCC rules
10-33	Emergency traffic
10-34	Trouble at this station
10-35	Confidential information
10-36	Correct time is
10-37	Wrecker needed at
10-38	Ambulance needed
10-39	Message delivered
10-41	Turn to channel
10-42	Traffic accident at
10-43	Traffic tie up at
10-44	Have a message for
10-45	All units within range please report
10-50	Break channel
10-60	What is next message number?
10-62	Unable to copy. Use phone
10-63	Net directed to
10-64	Net clear
10-65	Awaiting your next message/assignment
10-67	All units comply
10-70	Fire at
10-71	Proceed, transmission in sequence
10-77	Negative contact
10-81	Reserve hotel room for
10-82	Reserve room for
10-85	My address is
10-91	Talk closer to mic
10-93	Check my frequency on this channel
10-94	Give me a long count
10-99	Mission completed, all units secure
10-200	Police needed at

# Frequency Ranges

# HH 38 WX ST Specifications

The COBRA HH 38 WX ST transceiver represents one of the most advanced AM two-way radios used as a Class D station in the Citizens Radio Service. This unit features advanced Phase Lock Loop (PLL) circuitry providing complete coverage of all 40 CB channels and 10 weather channels as shown below.

CB Channel	Channel Freq. In MHz	CB Channel	Channel Freq. In MHz	Weather Channel	Weather Freq. In MHz
1	26.965	21	27.215	1	162.550
2	26.975	22	27.225	2	162.400
3	26.985	23	27.255	3	162.475
4	27.005	24	27.235	4	162.425
				5	162.450
5	27.015	25	27.245	6	162.500
6	27.025	26	27.265	7	162.525
7	27.035	27	27.275	8	161.650
8	27.055	28	27.285	9	161.775
9	27.065	29	27.295	0	163.275
10	27.075	30	27.305		
				<i>*Canadian weather channels are 8, 9 and 10.</i>	
11	27.085	31	27.315		
12	27.105	32	27.325		
13	27.115	33	27.335		
14	27.125	34	27.345		
15	27.135	35	27.355		
16	27.155	36	27.365		
17	27.165	37	27.375		
18	27.175	38	27.385		
19	27.185	39	27.395		
20	27.205	40	27.405		

### GENERAL

CHANNELS	.....	CB - 40 CH
		WEATHER - 10 CH
FREQUENCY RANGE	.....	CB - 26.965 TO 27.405 MHZ
		WEATHER - 161.650 TO 163.275 MHZ
FREQUENCY TOLERANCE	.....	0.005 %
FREQUENCY CONTROL	.....	PLL (PHASE LOCK LOOP) SYNTHESIZER
OPERATING TEMPERATURE RANGE	.....	-30° C TO + 65° C
MICROPHONE	.....	ELECTRET, PUSH-TO-TALK
INPUT VOLTAGE	.....	9V VDC
		12 VDC, EXTERNAL
ANTENNA CONNECTOR	.....	TYPE BNC
METER	.....	LCD DISPLAY, ICONS
WEIGHT	.....	9 oz.

### TRANSMITTER

POWER OUTPUT	.....	4.0 W AT 13.8 VDC - HIGH, 1.0 IN LOW
MODULATION	.....	AM
FREQUENCY RESPONSE	.....	300 - 3000 HZ AT -6 DB
OUTPUT IMPEDANCE	.....	50 OHMS, UNBALANCED

### RECEIVER

CB		
SENSITIVITY	.....	LESS THAN 1 $\mu$ V FOR 10 DB S/N
IF FREQUENCY	.....	DUAL CONVERSION
		1 ST - 10.690 MHZ, 2ND - 455 KHZ
AUDIO OUTPUT	.....	500 mW MAXIMUM AT 10 % DISTORTION
FREQUENCY RESPONSE	.....	300 - 3000 HZ AT -6 DB
2ND IF IMAGE REJECTION	.....	GREATER THAN 60 DB
ADJACENT CH. REJECTION	.....	50 DB MIN.
AUTOMATIC NOISE LIMITER	.....	BUILT-IN
FREQUENCY CONTROL	.....	PLL (PHASE LOCK LOOP)

### WEATHER

SENSITIVITY	.....	LESS THAN 1 $\mu$ V FOR 12 DB SINAD
IF FREQUENCY	.....	DUAL CONVERSION
		1st: -10.690 MHz
		2nd: -455 KHz
AUDIO OUTPUT	.....	MAXIMUM 500 mW AT 10 % DISTORTION
FREQUENCY RESPONSE	.....	300 - 3000 HZ AT -6 DB

## Limited Two Year Warranty



### Cobra Electronics Corporation

6500 West Cortland Street  
Chicago, Illinois 60707

**COBRA ELECTRONICS CORPORATION** warrants that its COBRA CB Radios, and the component parts thereof, will be free of defects in workmanship and materials for period of two (2) years from the date of first consumer purchase. This warranty may be enforced by the first consumer purchaser, provided that the product is utilized within the U.S.A.

COBRA will, without charge, repair or replace, at its option, defective CB radios, products or component parts upon delivery to the COBRA factory Service Department, accompanied by proof of the date of first consumer purchase, such as a duplicated copy of a sales receipt.

You must pay any initial shipping charges required to ship the product for warranty service, but the return charges will be at Cobra's expense, if the product is repaired or replaced under warranty.

**Exclusions:** This limited warranty does not apply; 1) to any product damaged by accident; 2) in the event of misuse or abuse of the product or as a result of unauthorized alterations or repairs; 3) if the serial number has been altered, defaced or removed; 4) if the owner of the product resides outside the U.S.A.

**All implied warranties, including warranties of merchantability and fitness for a particular purpose are limited in duration to the length of this warranty. COBRA shall not be liable for any incidental, consequential or other damages; including, without limitation, damages resulting from loss of use or cost of installation.**

Some states do not allow limitations on how long an implied warranty lasts and/or do not allow the exclusion or limitation of incidental or consequential damages, so the above limitations may not apply to you.

## Optional Accessories



### Ear Bud Mic with PTT

Integrated speaker/mic adapter that fits in your ear. Includes shirt clip.

MA-EBM \$29.95

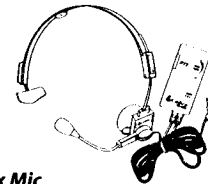

### Vox Mic

VOX (Voice Operated Transmitter) adapter allows you hands-free operation.

MA-VOX \$49.95



### (1) High Performance Ni-Cad Rechargeable Battery Cell

212-001-N-001 \$3.95 ea.



### Replacement Belt Clip

HA-BC \$4.95



### 120 Volt A/C Wall Charger with Plug

Charges 9 Ni-Cad battery cells in 24 hours right in the unit.

CA-45C \$10.00

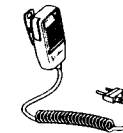

### Lapel Microphone

Remote microphone/speaker connection.

CA-40 \$25.95

### Long Range Antenna

Doubles the range of your HH 38 ST.

CA-41 \$25.95

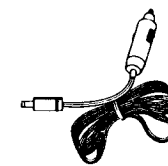

### Replacement DC Power Cord

For in vehicle use

420-017-N-001 \$7.00

### Magnetic Mount Weather Antenna

Allows greater transmission range while in a moving vehicle.

ATW-400 \$29.95

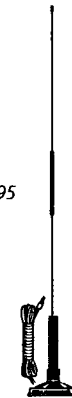

### BNC/SO239 Antenna Adapter

Allows connection of the 38 WX ST to standard antennas.

CA-43 \$5.95

### You Can Find These Fine Accessories At Your Local Cobra CB Dealer

If you wish, you can order directly from Cobra.

### Order by phone

Call 1.773.889.3087  
(Press 1 from the main menu)  
8 a.m.-8 p.m. M-F CST.

### Order by mail or fax

Please fill out order form on next page, and mail/fax directly to Cobra.

# Accessory Order Form

## Shipping & Handling

Amount of Order	Shipping/Handling
\$25.00 and under	\$4.75 minimum
\$25.01-\$40.00	\$6.95
\$40.01-\$80.00	\$9.00
\$80.01-\$120.00	\$10.00
\$120.01-\$160.00	\$11.50
\$160.01 and up	\$14.25

**For AK, HI and PR please add an additional \$15.00 for UPS shipments.**

Item #	Description	Cost Ea.	Qty.	Amount
MA-EBM	Ear Bud Mic	\$29.95		
MA-VOX	Vox Mic	\$49.95		
212-001-N-001	(1) Ni-Cad Rechargeable Battery Cell	\$3.95		
HA-BC	Replacement Belt Clip	\$4.95		
CA-45C	120 V A/C Wall Charger with Plug	\$10.00		
CA-40	Lapel Microphone	\$25.95		
CA-41	Long Range Antenna	\$25.95		
ATW-400	Magnetic Mount Weather Antenna	\$29.95		
CA-43	BNC/S0239 Antenna Adapter	\$5.95		
420-017-N-001	Replacement DC Power Cord	\$7.00		

Prices subject to change without notice.	Subtotal	_____
<b>Tax Table</b>	(Tax if applicable)	_____
Illinois residents add 7%	Shipping/handling	_____
Cook Co. residents add .75% (7.75% total)	<b>Total</b>	_____
Chicago residents add 1% (8.75% total)		

Indiana residents add 5%  
Michigan residents add 4%  
Minnesota residents add 6%  
Ohio residents add 6%  
Wisconsin residents add 5%

For credit card orders fill out order form and fax to: 1.773.622.2269 or call 1.773.889.3087 (Press 1 from the main menu) 8:00 am - 8:00 pm, M-F, CST.

Make check or money order (no stamps) payable to: Cobra Accessories Dept. 6500 West Cortland St. Chicago, IL 60707

Please print clearly

Name \_\_\_\_\_

Address (No P.O. Box) \_\_\_\_\_

City \_\_\_\_\_ State \_\_\_\_\_

Zip \_\_\_\_\_

Telephone (\_\_\_\_) \_\_\_\_\_

Credit Card No. \_\_\_\_\_ Exp. Date \_\_\_\_\_

Customer Signature \_\_\_\_\_

Circle One: Visa MasterCard Discover

Allow 4 to 6 weeks for delivery. Offer valid in Continental U.S. only.