

User Manual

**Model BL300-1/BL300-2
Digital Cordless Phone**

TABLE OF CONTENTS

Important Safety Instructions	3
Safety Instructions for Handset Battery Pack	4
LCD Display	6
Getting Started.....	7
Install and Charge the Battery Pack	7
Basic Operation	10
Making Internal Calls.....	10
Making External Calls.....	10
Receiving External Calls.....	11
Receiving Internal Call.....	11
Redialing	11
Dialing from the Phone Book.....	13
Muting the Microphone.....	13
Muting the Ringer volume	13
Call Transfer / Forwarding	13
Three Party Conference.....	14
Changing the Earpiece Volume	14
Paging the Handset.....	14
Handset Speaker Phone.....	14
Key Lock.....	14
Short Key Definition	14
Phone Book	15
Date & Time	17
Call List.....	17
Display Setup	18
Base Setup.....	19
Ringer	19
Dial Mode.....	20
MW Indication	20
Reset Base	20
HS Settings.....	20
Ringer Setup.....	21
Set Alarm.....	22
Auto Talk.....	23
Registration	23
Select Base	24
Tones On/Off.....	24
Reset Handset.....	24
GFM Guarantee.....	27

Important Safety Instructions

BEFORE USING YOUR TELEPHONE EQUIPMENT, BASIC SAFETY PRECAUTIONS SHOULD ALWAYS BE FOLLOWED TO REDUCE THE RISK OF FIRE, ELECTRIC SHOCK AND INJURY TO PERSON, INCLUDING THE FOLLOWING:

1. **Read and understand all instructions.**
2. **Follow all warnings and instructions marked on the product.**
3. **Unplug this product from the wall outlet before cleaning. Do not use liquid cleanser or aerosol cleanser. Use a damp cloth for cleaning.**
4. **Do not use this product near water, for example, near a bath tub, wash bowl, kitchen sink, laundry tub, in a wet basement, or near a swimming pool.**
5. **Do not place this product on an unstable cart, stand, or table. The product may fall, causing serious damage to the product.**
6. **Slots and openings in the cabinet and the back or bottom are provided for ventilation. To protect it from overheating, these openings must not be blocked or covered. The openings should never be blocked by placing the product on the bed, sofa, rug, or other similar surface. This product should never be placed near or over a radiator or heat register. This product should not be placed in a built-in installation unless proper ventilation is provided.**
7. **This product should be operated only from the type of power source indicated on the label. If you are not sure of the type of power supply to your home, consult your dealer or local power company.**
8. **Do not allow anything to rest on the power cord. Do not locate this product where the cord will be damaged by persons walking on it.**
9. **Do not overload wall outlet extension cords, as this can result in the risk of fire or electric shock.**
10. **Never push objects of any kind into this product through cabinet slots as they may touch dangerous voltage points or short out parts that could result in a risk of fire or electric shock. Never spill liquid of any kind on this product.**
11. **To reduce the risk of electric shock, do not disassemble this product. Instead, when repair work is required, take the unit to a qualified technician. Opening or removing covers may expose you to dangerous voltages or other risks. Incorrect reassembly can cause electric shock when the appliance is subsequently used.**
12. **Use only the power cord and batteries indicated in this manual. Do not dispose of batteries in a fire. They may explode.**
13. **Unplug this product from the wall outlet and refer servicing to a qualified service personnel under the following conditions:**
 - a. **When the power supply cord or plug is damaged or frayed.**
 - b. **If liquid has been spilled into the product.**
 - c. **If the product has been exposed to rain or water.**
 - d. **If the product does not operate normally by following the operating instructions. Adjust only those controls that are covered by the operating instructions because improper adjustment of other controls may result in damage and will often require extensive work by a qualified technician to restore the product to normal operation.**

- e. If the product has been dropped or cabinet has been damaged.
 - f. If the product exhibits a distinct change in performance.
14. **Avoid using a telephone (other than a cordless type) during an electrical storm. There may be a remote risk of electrical shock from lightning.**
 15. **Do not use the telephone to report a gas leak in the vicinity of the leak.**
 16. **This power unit is intended to be correctly oriented in a vertical or floor mount position.**
 17. ** Use only with Class (Class 2) power source 7.5VDC 320mA.**

SAVE THESE INSTRUCTIONS

Safety Instructions for Handset Battery Pack

CAUTION:

There is danger of explosion if the battery is incorrectly replaced. Use only an approved battery pack in the handset of your Cordless Telephone System. To reduce the risk of fire or injury, always do the following when replacing, discarding, or charging battery. When handling the batteries, be careful not to short the battery with conducting materials such as rings, bracelets, and keys. The Battery or conducting material may overheat and cause burns. Risk of explosion if battery is replaced by an Incorrect type. Dispose of used batteries according to the instructions. Use only with (GPI GP60AAAH2BMJZR; (2.4V,600mAH) NiMH rechargeable battery) / LEXEL LH065-3A43C2BRJS1P (2.4V,600mAH) NiMH rechargeable battery)



CONTAINS NICKEL-METAL HYDRIDE BATTERY. BATTERY MUST BE RECYCLED OR DISPOSED OF PROPERLY

18. **Do not dispose of the battery in a fire. The cell may explode. Check with local codes for possible special disposal instructions.**
19. **Do not open or mutilate the battery. Released electrolyte is corrosive and may cause damage to the eyes or skin. It may be toxic if swallowed.**
20. **Exercise care in handling batteries in order not to short the battery with conducting materials such as rings, bracelets and keys. The battery or conductor may overheat and cause burns.**
21. **Charge the batteries provided with, or identified for use, with this product only in accordance with the instructions and limitations specified in this manual.**
22. **Observe proper polarity orientation between the battery(ies) and the battery charger.**
23. **Do not mix old and new batteries in this product.**
24. **Do not mix batteries of different sizes or from different manufacturers in this product.**

SAVE THESE INSTRUCTIONS

Handset Layouts

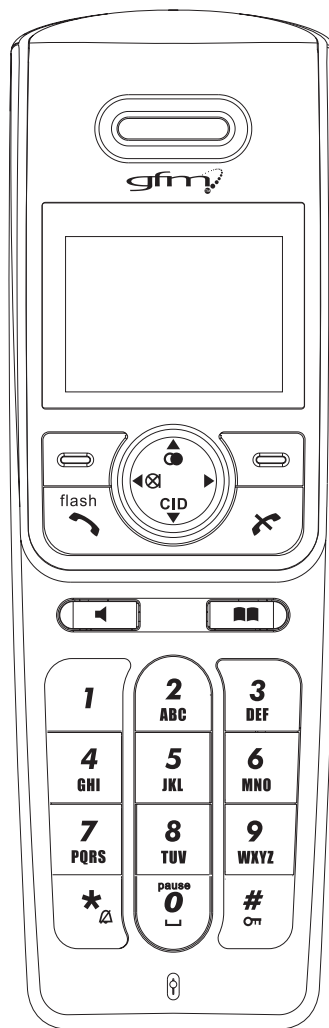

	Redial / Up key
	CID key / down key
	Left soft key (SKL) /Menu OK key
	Right soft key (SKR) / Intercom key
	Right key
	Phonebook key
	Left key/Mute key
	External Call key/Flash key
	Speaker phone key
	End call key
	Asterisk / Ringer off key
	Pause / Space key
	Hash key / Lock key

Base layouts

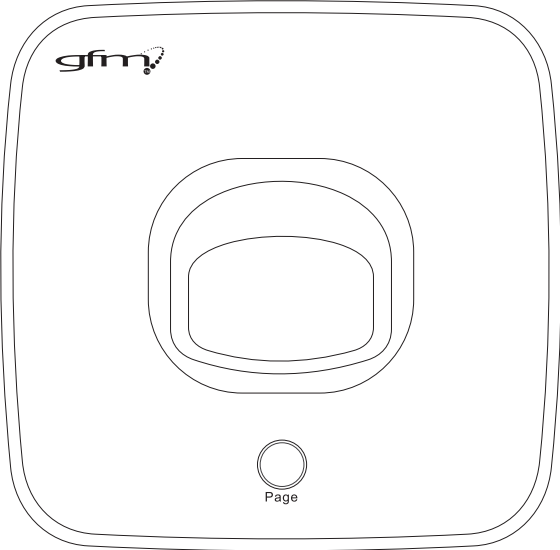

	Paging
--	--------

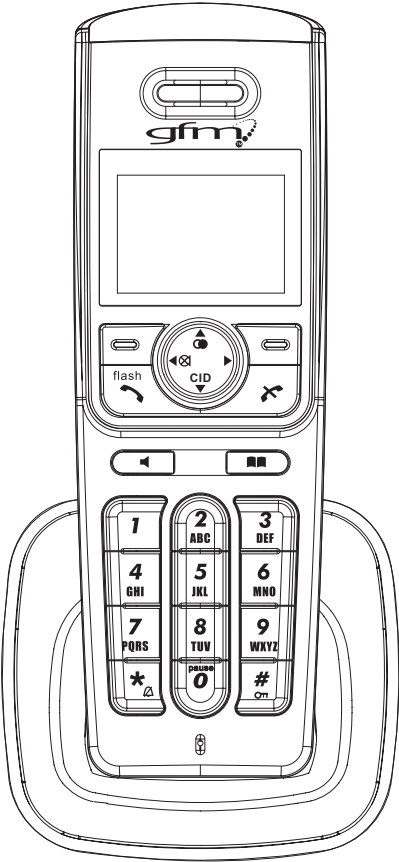

Charger suitable for Model BL300-2

LCD Display



Icon	Icon Name
Small Icon	
	Battery icon
	Key lock icon
	Line in use icon
	Speak phone icon
	Mic mute icon
	No ring icon
	Signal icon
	Alarm icon
Large Icon	
	Date & Time icon
	Calls List icon
	Display Setup icon
	Base Setup icon
	Phone Book icon
	HS Settings icon

Getting Started

Install and Charge the Battery Pack

- 1 Open the battery compartment by sliding the cover down.
- 2 Plug the Battery Pack connector into the Handset socket, then place the battery pack and wires in the compartment.
- 3 Slide the battery cover back into place.

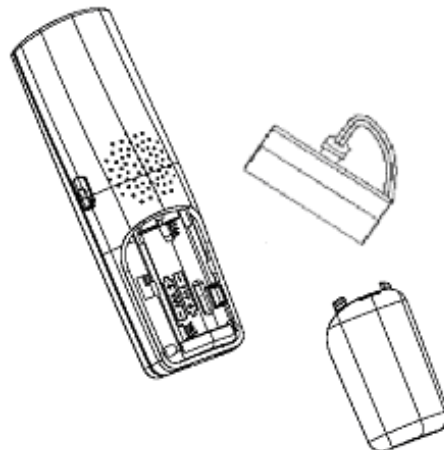

Place the handset in the base station to charge for 16 hours prior for first use. If you don't properly charge the phone, battery performance will be compromised.

Connecting the Base Station and Power Plug

Connecting the plugs to the corresponding sockets in the base station (they can not be connected incorrectly because the sockets and plugs are designed prevent reverse poling). Lay the cable under the telephone to the rear. Plug the telephone line in the telephone connection socket. Insert the power plug at the other end in the power outlet. The base station is now ready to operate.

Only use the connection cable supplied.

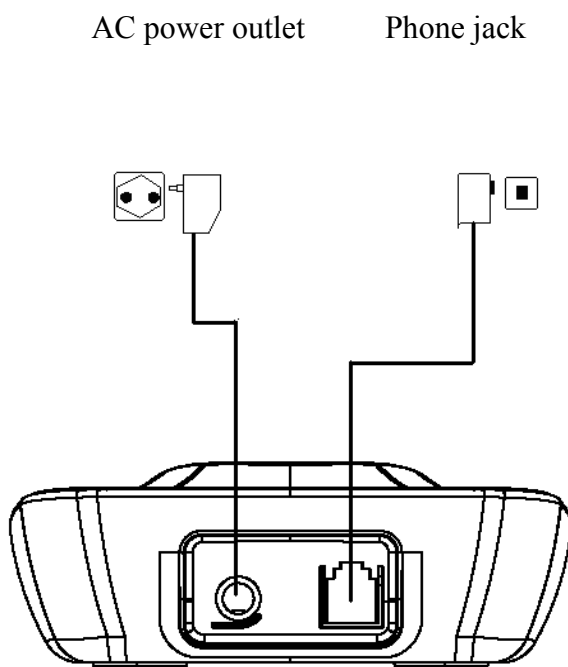

▲ CAUTION:
Plug the adapter to the socket outlet that near the equipment and shall be easily accessible. Use only the power supply that came with this unit. Using other power supplies may damage the unit.

Features

We are very pleased that you have purchased this highly sophisticated, cordless telephone which is equipped with the following features:

1. Digital cordless telephone complying to DECT standards
2. Operation instruction in 3 languages
3. Teleconference
4. Call transfer/forwarding
5. Internal, free communication between handsets
6. Automatic call answering on/off
7. Phone book group function (6 groups)
8. Color display with icon driven menu
9. Phone book for 50 entries
10. Extended redialing for 10 call numbers
11. Caller ID* function with 30 name/number call list
12. Microphone and ringer muting function
13. Low battery and out of range indicators
14. Key lock
15. Key tone on/off
16. 14 incoming call ringing melodies
17. Ringing volume control (5 levels)
18. Internal/External call separate ring tone
19. DTMF/Pulse dialing
20. Operation of up to 4 handsets
21. Paging function from base station to handset
22. Up to 100 hours standby
23. Up to 10 hours continuous call time.
24. Operation with 2 standard AAA batteries (NiMH)
25. Adjustable flash time



*DECT Digital Enhanced Cordless Telecommunication = Standard for Cordless Telephones.

Using the Handset Telephone

Basic Operation

Making Internal Calls

If more than one handset is registered on the base station, internal calls can be made free of charge.

- Press [SKR] key.
- Press  or  key to select the required handset (Handset 1, Handset 2...).
- Press [SKL] key to carry out the conversation.
- Press  key to end the call.

Note: During the conversation, you can use  or  key to adjust the speaking volume (5 levels).

Making External Calls

Pre-dialing:

- Press  key and wait for a dialing tone.

Dial the telephone number as required.

It will start counting when the call is connected, the call timer format is HH:MM:SS.

After the connection is established, user can view Redial、Calls List、Phone Book by pressing [SKL] button.

- Press  key to terminate the call.

Note: During the conversation, you can use  or  key to adjust the speaking volume (5 levels).

Post-dialing:

Dial the telephone number.

Delete any incorrect entries by pressing [SKR] button.

- Press  key. The number entered is dialed and a connection established.

It will start counting when the call is connected, the call timer format is HH:MM:SS.

After the connection is established, user can view Redial、 Calls List、 Phone Book by pressing [SKL] button.

- Press  key to terminate the call.

Receiving External Calls

When an external call is received, all handsets registered and the base station ring , and  flashes in the handset display, if configured, the telephone number of the caller appears (network depended). If the caller has been entered in your phone book, the name appears.

- Press  key to establish the connection.

If auto answer is enabled, the line can also be automatically connected after the handset is lifted up from the base.

- Press  key to terminate the call.

Receiving Internal Call

When an internal call arrives, the handset will ring and show the caller's handset number, and  flashes in the handset display.

- Press  key to establish the connection.

If auto answer is enabled, the line can also be automatically connected after the handset is lifted up from the base.

- Press  key to terminate the call.



Redialing

The phone stores the last 10 numbers dialed in the redialling memory

Dial a number form the Redial Memory

- Press  key to view the dialed calls.







Note: If there is no record in the redialing memory, empty information will display

- Press  or  key to select the desired record.





- Press  key to redial the desired record.

- Press  key to terminate the call.





Save Redial Memory

- Press  key to view the dialed calls.
- Press  or  key to select the desired record.
- Press [SKL] key to enter Redial menu..
- Press  or  key to select [Save Number] and press [SKL] key.
- Enter name (max. 15 characters) and press [SKL] key when finished.
- Press  or  key to select a group and press [SKL] key.



Delete a Single Redial Memory



- Press  key to view the dialed calls.
- Press  or  key to select the desired record.
- Press [SKL] key to enter Redial menu..
- Press  or  key to select [Delete Entry] and press [SKL] key , the LCD will display “Delete?” , press [SKL] key to confirm.

Delete all Single Redial Memory

- Press  key to view the dialed calls.
- Press  or  key to select the desired record.
- Press [SKL] key to enter Redial menu..
- Press  or  key to select [Delete All] and press [SKL] key , the LCD will display “Delete All?” , press [SKL] key to confirm.

Use Number





- Press  key to view the dialed calls.
- Press  or  key to select the desired record.
- Press [SKL] key to enter Redial menu.

- Press  or  key to select [Use Number]
- Press [SKL] button to use the telephone number, you may edit the number and make the call, but the edited number cannot be saved in this option.

Dialing from the Phone Book

- Press  button when in standby mode, the first entry in the phone book appears.

Note: If there is no record in phone book, empty information will display



- Press  or  key to select the required subscriber from the phone book.
- Press  key to dial the number.
- Press  key to terminate the call.

Note: How to store entries in the phone book is explained in the Chapter “Phone Book”.

Muting the Microphone



- Press the  button to switch the microphone on or off during a call.

Muting the Ringer Volume

- Press and hold  key in idle mode to activate or deactivate the handset Ringer. The  icon turns on or off.

Call Transfer / Forwarding

It is possible to put external calls on hold and call other handsets registered to the base or to forward calls.



- Press [SKR] key to hold the external call and initiate an internal call.
- Press  or  key to select the required handset (Handset 1, Handset 2...).

The target handset will ring. After the internal connection is made, press  key to transfer the external call to the desired handset.

Note: 1. There must be more than two handsets registered to the base, otherwise the call transfer/forwarding function will be invalid; 2. If [SKR] key is pressed before another handset answer the internal call, the call transfer procedure will be cancelled and the external call is regained;



Three Party Conference

After have received an external call, it is possible to include a second handset in the conversation (three way conference).

- Press [SKR] key to hold the external call and initiate an internal call.
- Press  or  key to select the required handset (Handset 1, Handset 2...) that needs to participate in the conference (e.g. 2).
- Press [SKL] key to establish the conference call after the other handset answered the internal call.
- Press  key to disconnect from the conference call and the other handset continues with the external call.

Note: There is another way to enter conference, the second handset off hook will also enter conference.

Changing the Earpiece Volume



- Press  or  key as often as necessary to change the earpiece volume during a call.

Paging the Handset

If a handset has been misplaced, it is possible to call all the handsets. The handset ring at full volume .

- Press **page** key briefly on the base station.

To stop the page call:

Short press  key or  key or the  key on the handset or press **page** key briefly on the base.

Handset Speaker Phone

- Press  key to activate / deactivate the handset speaker.



Key Lock

It is possible to lock the handset keys against the functioning. Incoming calls can still be received.

#

- Press and hold the  key for 2 seconds to activate or deactivate the key lock.

Short Key Definition

There are three short key: ,  and .

In standby mode, press  key to access Redial







In standby mode, press  key to access Call List

In standby mode, press  key to enter Phone Book.

Phone Book

The telephone can store up to 50 entries in the phone book. Store numbers frequently used in order to be able to dial them quickly and easily. When the function is supported by the telephone provider service and the caller, the handset displays the name of the caller (when stored in the phone book).

New Entry





- Press [SKL] button to enter the main menu.
- Press  or  key to select [phone Book].
- Press [SKL] button to enter [phone Book].
- Press [SKL] button to enter phone Book menu.
- Press  or  key to select [New Entry] and press [SKL] key.
Enter number (max. 24 digits) and press [SKL] key when finished.
Enter name (max. 15 characters) and press [SKL] key when finished.
- Press  or  key to select a group ,the pre-set caller groups are: [VIP], [Business], [Family], [Friends], [School] , [Others] and [No Group].
- Press [SKL] button to confirm the selection and complete storing the entry.



Note: 1. When the capacity is full, Memory full will display.

2. Any incorrect input can be deleted by pressing [SKR] button.







User can also save number into phone book through call log and Redial memory (refer to chapter “Call Log Operation” and “Redial Memory Operation”).

Delete Entry

- Press [SKL] button to enter the main menu.
- Press  or  key to select [phone Book].
- Press [SKL] button to enter [phone Book].
- Press  or  key to select a desired entry.





- Press [SKL] key to access phone book menu, and then press  or  to select the submenu [Delete Entry].
- Press [SKL] key to delete the entry, and the LCD will show “Delete?”
- Press [SKL] button to confirm.

Edit Entry

- Press [SKL] button to enter the main menu.
- Press  or  key to select [phone Book].
- Press [SKL] button to enter [phone Book].
- Press  or  key to select a desired entry.
- Press [SKL] key to access phone book menu, and then press  or  to select the submenu [Edit Entry].
- Press [SKL] to start Number edition and press [SKL] key again to start Name edition and press [SKL] key again to select caller groups .
- Press [SKL] key to confirm.

Note: Press [SKR] key to delete any incorrect input



Delete All

- Press [SKL] button to enter the main menu.
- Press  or  key to select [phone Book].
- Press [SKL] button to enter [phone Book].
- Press [SKL] key to access phone book menu, and then press  or  to select the submenu [Delete All].



Press [SKL] key to delete the entry, and the LCD will show “Delete All PB?”

- Press [SKL] button to confirm.

Use Number

Press  or  to select the required record from the phone book.



Press [SKL] button.

Press  or  to select [Use Number].

Press [SKL] button to use the telephone number, you may edit the number and make the call, but the edited number cannot be saved in this option.

Note: User can access Phone Book directly from standby mode by pressing  button.

Date & Time

- Press [SKL] button to enter the main menu.
- Press  or  key to select [Date&Time].
- Press [SKL] button to enter [Date&Time].

Enter the date (MM:DD:YY).

- Press [SKL] button.

Enter the time (HH:MM).



#

- Press  key to switch the format(am/pm/24).
- Press [SKL] button to confirm the date/time setting.





Call List

IMPORTANT: To use the “Call List” function, you must subscribe to your network operator’s Caller Line Identification (CLI) service.

Call List can contain up to 30 records.

- Press [SKL] button to enter the main menu.
- Press  or  key to select [Call List].
- Press [SKL] button to enter [Call List].

Note: If there is no record in call log, empty information will display

- Press  or  key to find the desired record.
- Press [SKL] button
- Press  or  key to choose the selection [Delete Entry]、 [Save Number]、 [Delete All] or [Use number] .

If you choose [Delete Entry]:

- Press [SKL] key to delete the entry, and the LCD will show “Delete?”
- Press [SKL] button to confirm.

If you choose [Save Number]:

- Press [SKL] key to start Name edition and press [SKL] key again to select caller groups .
- Press [SKL] key to save the record to the phone book.



Note: Press [SKR] key to delete any incorrect input.

If you choose [Delete All],

- Press [SKL] key to delete the entry, and the LCD will show “Delete All?”
- Press [SKL] button to confirm.





If you choose [Use Number], press [SKL] key to view user number.

Display Setup



- Press [SKL] button to enter the main menu.
- Press  or  key to select [Display Setup].

- Press [SKL] button.

Wallpaper

- Press  or  key to choose the selection [Wallpaper] through the submenu [Display Setup].
- Press [SKL] button.
- Press  or  key to select the desired wallpaper or [Wallpaper off].
- Press [SKL] button to confirm the selection.





Handset Name

- Press  or  key to choose the selection [Handset Name] through the submenu [Display Setup].
- Press [SKL] button.





Enter the handset name (press [SKR] button to delete any incorrect input)

- Press [SKL] button to confirm the input.



Display Contrast

- Press  or  key to choose the selection [Display Contrast] through the submenu [Display Setup].
- Press [SKL] button.
- Press  or  key to adjust the contrast level (1-8).
- Press [SKL] button to confirm the setting.



Language

- Press  or  key to choose the selection [Language] through the submenu [Display Setup].
- Press [SKL] button.
- Press  or  key to select the language.
- Press [SKL] button to confirm the setting.





Base Setup

- Press [SKL] button to enter the main menu.
- Press  or  key to select [Base Setup].
- Press [SKL] button to access Base Setup menu.





Ringer

- Press  or  key to choose the selection [Ringer] through the submenu [Base Setup].
- Press [SKL] button.

Ringer Volume

- Press  or  key to choose the selection [Ringer Volume] rough the submenu [Ringer].
- Press [SKL] button.
- Press  or  key to select a ringer volume:[Ringer Volume 1], [Ringer Volume 2], [Ringer Volume 3], [Ringer Volume 4], [Ringer Volume 5] or [Off].
- Press [SKL] button to confirm.





Ringtone

- Press  or  key to choose the selection [Ringtone] through the submenu [Ringer].
- Press [SKL] button.
- Press  or  key to choose the selection [Ring Tone 1], [Ring Tone 2], [Ring Tone 3], [Ring Tone 4] or

[Ring Tone 5] , [Ring Tone 6]

- Press [SKL] button to confirm the selection.



Dial Mode

- Press  or  key to choose the selection [Dial Mode] through the submenu [Base Setup].
- Press [SKL] button.
- Press  or  key to select [Tone] or [PULSE].
- Press [SKL] button to confirm the selection.

MW Indication

If you have subscribed to a voice messaging service, the  icon will be displayed to alert you if you have a new messages waiting.

You can turn Visual Message Waiting Indication (VMWI) off



- Press  or  key to choose the selection [MW Indication] through the submenu [Base Setup].
- Press [SKL] button.

You will be prompted ‘VMWI OFF?’



- Press [SKL] button to confirm the setting.

Note: This service need subscription to local operator and it supports the FSK CLI system only.

Reset Base







- Press  or  key to choose the selection [Reset Base] through the submenu [Base Setup].
- Press [SKL] button, “Default Reset?” display.
- Press [SKL] button to reset to the default settings or press [SKR] button to cancel.

HS Settings





- Press [SKL] button to enter the main menu.
- Press  or  key to select [HS Settings].
- Press [SKL] button.

Ringer Setup





Ringer Volume

- Press  or  key to choose the selection [Ringer Setup] through the submenu [HS Settings].
- Press [SKL] button.
- Press  or  key to choose the selection [Ringer Volume]
- Press [SKL] button.
- Press  or  key to select a ringer volume: [Ringer Volume 1], [Ringer Volume 2], [Ringer Volume 3], [Ringer Volume 4], [Ringer Volume 5] or [Off].
- Press [SKL] button to confirm.







Ext.Ringtone

- Press  or  key to choose the selection [Ext.Ringtone] through the submenu [Ringer Setup].
- Press [SKL] button.
- Press  or  key to select one type of ring tone (14 ring melodies).
- Press [SKL] button to confirm the ring type.





Int.Ringtone

- Press  or  key to choose the selection [Int.Ringtone] through the submenu [Ringer Setup].
- Press [SKL] button.
- Press  or  key to select one type of ring tone (14 ring melodies).
- Press [SKL] button to confirm the ring type.



Group Melody

- Press  or  key to choose the selection [Group Melody] through the submenu [Ringer Setup].
- Press [SKL] button. There are 6 pre-set caller groups: [VIP], [Business], [Family], [Friends], [School] and [Others].
- Press  or  key to choose one of the groups.
- Press [SKL] button.
- Press  or  key to select one type of ring tone (14 ring melodies).
- Press [SKL] button to confirm.

Set Alarm

- Press  or  key to choose the selection [Set Alarm] through the submenu [HS Settings].
- Press [SKL] button.
- Press  or  key to choose [Set Alarm] or [Alarm Tone]
- Press [SKL] button .

If you select 'Set Alarm',



- Press  or  key to select [Off] ,[Once] or [Daily].
- Press [SKL] button.

Enter the time (HH:MM).

#





- Press  key to switch the format(am/pm).
- Press [SKL] button to confirm the setting.

If you select 'Alarm Tone',



- Press  or  key to select one type of ring tone (14 ring melodies).
- Press [SKL] button to confirm the setting

Auto Talk





The automatic talk function enables the incoming call to be taken immediately when the handset is removed from the base station.

- Press  or  key to choose the selection [Auto Talk] through the submenu [HS Settings].
- Press [SKL] button.
- Press  or  key to select [Off] or [On].
- Press [SKL] button to confirm the setting

Registration

- Press  or  key to choose the selection [Registration] through the submenu [HS Settings].
- Press [SKL] button.

Register Handset

- Press  or  key to choose the selection [Register Handset] through the submenu [Registration].
- Press [SKL] button.
- Press  or  key to select [Base1],[Base2],[Base3]or [Base4].
- Press [SKL] button.



Handset display shows Searching....

Press and hold Page key on the base station for 10 seconds until acknowledgement signal is heard.

Note: 1.Once the registration procedure is complete, the new handset will automatically be allocated the next available handset number.

2. The base will be ready for registration for 2 minutes when the **Page** key is pressed and hold for more than 10 seconds. During the handset searching for a base station which is available for registration. “searching” will be shown on the LCD display .

Deregister HS





- Press  or  key to choose the selection [Deregister HS] through the submenu [Registration].
- Press [SKL] button.

If necessary, use  or  key to select the handset and press [SKL] key. “Deregister HS?” will







show on the display.

- Press [SKL] key to confirm.



Select Base

- Press  or  key to choose the selection [Select Base] through the submenu [HS Settings].
- Press [SKL] button.
- Press  or  key to select a Base.
- Press [SKL] button to confirm the selection.

Tones On/Off

- Press  or  key to choose the selection [Tones on/off] through the submenu [HS Settings].
- Press [SKL] button.
- Press  or  key to choose [Key tone], [Battery Low] and [Out of Range].
- Press [SKL] button.
- Press  or  key to select [Off] or [On].
- Press [SKL] button to confirm the selection.

Reset Handset

- Press  or  key to choose the selection [Reset Handset] through the submenu [HS Settings].
- Press [SKL] button, “Default Reset?” display.
- Press [SKL] button to reset to the default settings or press [SKR] button to cancel.

Consumer Information

1. This equipment complies with Part 68 of the FCC rules and the requirements adopted by the ACTA. On the back of this equipment is a label that contains, among other information, a product identifier in the format US: DDKW401BBL300X. If requested, this number must be provided to the telephone company.
2. An applicable certification jacks Universal Service Order Codes (USOC) for the equipment is provided (i.e., RJ11C) in the packaging with each piece of approved terminal equipment.
3. A plug and jack used to connect this equipment to the premises wiring and telephone network must comply with the applicable FCC part 68 rules and requirements adopted by the ACTA. A compliant telephone cord and modular plug is provided with this product. It is designed to be connected to a compatible modular jack that is also compliant. See“Getting Started ”section for details.
4. The REN is used to determine the number of devices that may be connected to a telephone line. Excessive RENs on a telephone line may result in the devices not ringing in response to an incoming call. In most but not all areas, the sum of RENs should not exceed five (5.0). To be certain of the number of devices that may be connected to a line, as determined by the total RENs, contact the local telephone company. The REN for this product is part of the product identifier that has the format US: DDKW401BBL300X. The digits represented by 01 are the REN without a decimal point (e.g., 03 is a REN of 0.3). The REN is separately shown on the label too.
5. If this equipment causes harm to the telephone network, the telephone company will notify you in advance that temporary discontinuance of service may be required. But if advance notice isn't practical, the telephone company will notify the customer as soon as possible. Also, you will be advised of your right to file a complaint with the FCC if you believe it is necessary.
6. The telephone company may make changes in its facilities, equipment, operations or procedures that could affect the operation of the equipment. If this happens the telephone company will provide advance notice in order for you to make necessary modifications to maintain uninterrupted service.
7. Please follow instructions for repairing if any (e.g. battery replacement section); otherwise do not alternate or repair any parts of device except specified.
8. Connection to party line service is subject to state tariffs. Contact the state public utility commission, public service commission or corporation commission for information.
9. This equipment is hearing aid compatible.

NOTICE:

1) If your home has specially wired alarm equipment connected to the telephone line, ensure that the installation of this phone does not disable your alarm equipment. If you have questions about what will disable alarm equipment, consult your telephone company or a qualified installer.

2) According to telephone company reports, AC electrical surges, typically resulting from lightning strikes, are very destructive to telephone equipment connected to AC power sources. To minimize damage from these types of surges, a surge protector is recommended.

3) This device complies with part 15 of the FCC Rules. Operation is subject to the following two conditions: (1) This device may not cause harmful interference; and (2) This device must accept any interference received, including interference that may cause undesired operation.

4) For body worn operation, this handset has been tested and meets the FCC RF exposure guidelines. Use of accessories may not ensure compliance with FCC RF exposure guidelines.

5) The FCC ID for base of this product is:RAQBL300BS,for handset is RAQBL300US.

If the equipment is causing harm to the telephone network, the telephone company may request that you disconnect the equipment until the problem is resolved.

WARNING: Changes or modifications to this unit not expressly approved by the party responsible for compliance could void the user's authority to operate the equipment.

CAUTION: To maintain compliance with the FCC's RF exposure guidelines place the base unit at least 20 cm from nearby persons.

NOTE: This equipment has been tested and found to comply with the limits for a Class B digital device, pursuant to Part 15 of the FCC Rules. These limits are designed to provide reasonable protection against harmful interference in a residential installation. This equipment generates uses and can radiate radio frequency energy and, if not installed and used in accordance with the instructions, may cause harmful interference to radio communications. However, there is no guarantee that interference will not occur in a particular installation. If this equipment does cause harmful interference to radio or television reception, which can be determined by turning the equipment off and on, the user is encouraged to try to correct the interference by one or more of the following measures:

- Reorient or relocate the receiving antenna.
- Increase the separation between the equipment and receiver.
- Connect the equipment into an outlet on a circuit different from that to which the receiver is needed.
- Consult the dealer or an experienced radio TV technician for help.

You can purchase a suitable headset through service center or retailer shop. For servicing or replacement please contact us for suitable headset.

Giant International Ltd.

3500 Lenox Road, Suite 630 Atlanta, GA 30326

Contact person: Terry Uhrich

GFM Guarantee

If you are not totally satisfied with this GFM product, you may return it to any Meijer store for a full refund within 6 months (180 days) of purchase when accompanied by a receipt.

For customer support, please call (866) 845-9436 or go to www.gfmproducts.com.

Dist. by Wholesale Merchandisers, Inc.,

2929 Walker, NW,

Grand Rapids, MI 49544

Made in China