

For product support, visit
Para obtener asistencia técnica, visite
Pour en savoir plus sur l'assistance sur les produits, visitez le site

www.philips.com/support

HTL1170B



Quick start guide

P&F USA, Inc.

PHILIPS

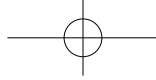

EN: For further assistance, call the customer support service in your country.

- To obtain assistance in the U.S.A., Canada, Puerto Rico, or the U.S. Virgin Islands, contact Philips Customer Care Center at 1 866 310 0744
- To obtain assistance in Mexico, contact Philips Customer Care Center at 01 800 839 1989

ES: Para obtener mas informacion, llame al servicio de soporte al cliente de su pais.

- Para obtener asistencia en los Estados Unidos, en Canada, Puerto Rico o en las Islas Virgenes de los Estados Unidos, comuniquese con Centro de atencion al cliente de Philips al 1 866 310 0744
- Solo para Mexico CENTRO DE ATENCION A CLIENTES LADA.
01 800 839 1989 Solo Para Mexico.

FR-CA: Pour obtenir de l'aide supplementaire, communiquez avec le centre de service a la clientele de votre pays.

- Pour obtenir de l'aide aux Etats-Unis, au Canada, a Puerto Rico ou aux Iles Vierges americaines, communiquez avec le centre de service a la clientele Philips au : 1 866 310 0744
- Pour obtenir l'aide au Mexique, entrez en contact avec le centre de soin de client de Philips a 01 800 839 1989

For Product recycling information, please visit - www.recycle.philips.com

Para obtener información de productos de reciclaje, por favor visite - www.recycle.philips.com

Pour tout renseignement sur le recyclage des produits, veuillez visiter - www.recycle.philips.com



- EN** Before using your product, read all accompanying safety information
- ES** Antes de usar su producto, lea toda la información de seguridad adjunta
- FR-CA** Avant d'utiliser votre appareil, prenez le temps de lire toute l'information de sécurité connexe

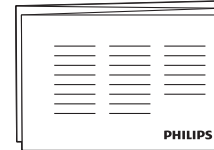
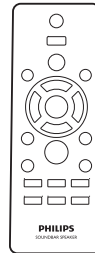



1

EN Position the SoundBar
Wall mount the SoundBar
(optional)

ES Colocación del SoundBar:
Montaje en pared del SoundBar
(opcional)

FR-CA Positionnez le SoundBar:
Fixez le SoundBar au mur
(facultatif)

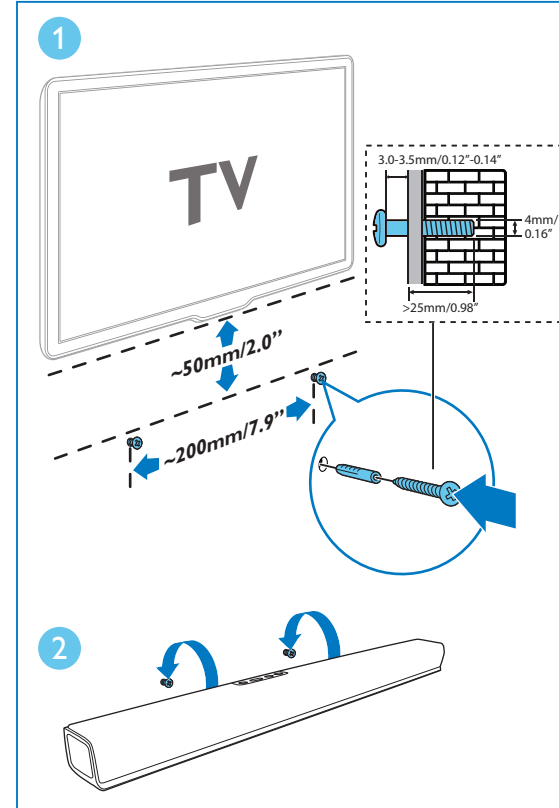
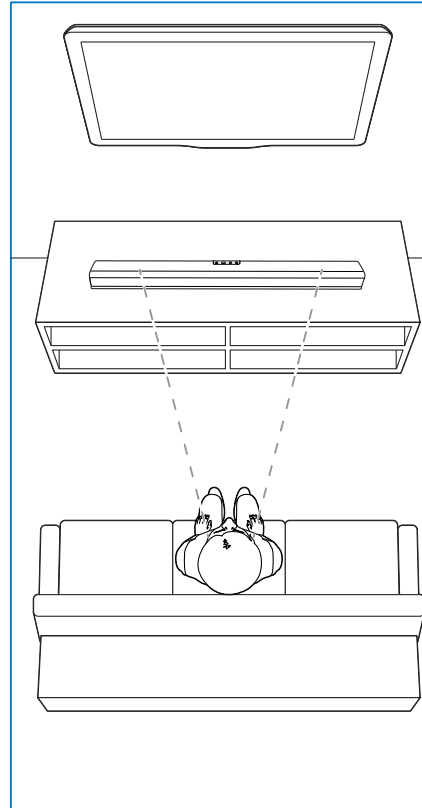

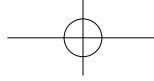

2

- EN** Connect the SoundBar
- ES** Conexión del SoundBar
- FR-CA** Branchez le SoundBar

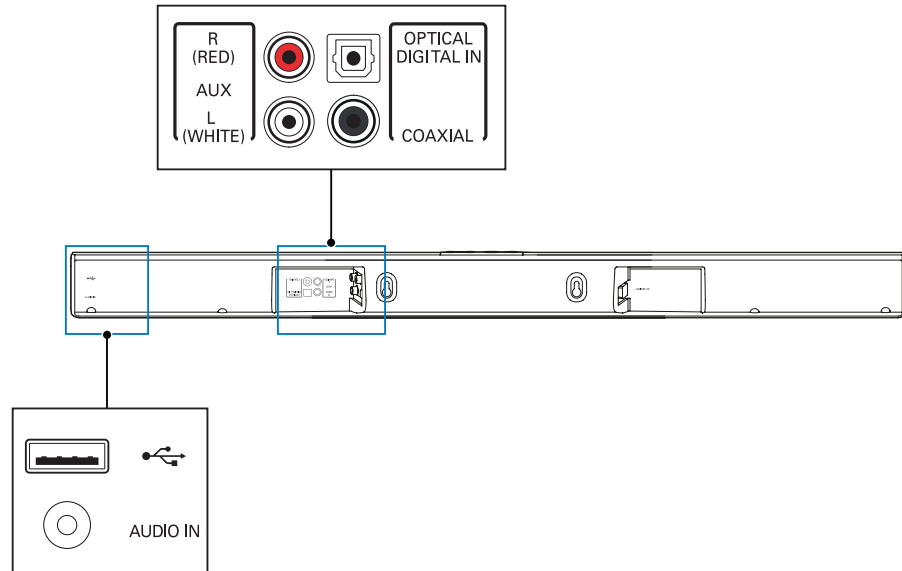



3

- EN** Hear audio from TV in one of the following ways (Mute your TV).
- ES** Escuche el audio del televisor de una de las siguientes formas (silenciar el televisor).
- FR-CA** Vous pouvez diffuser l'audio du téléviseur des façons suivantes (son du téléviseur coupé).

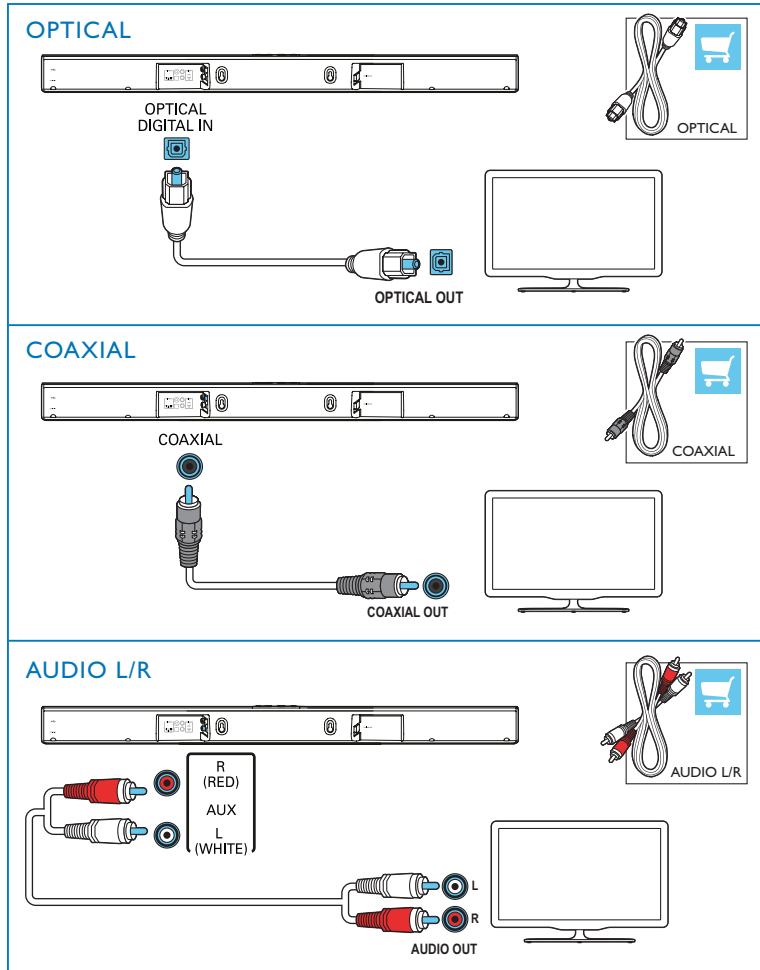

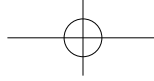

4

- EN** Enjoy audio from your devices
- ES** Disfrute el audio de sus dispositivos
- FR-CA** Profitez du contenu audio de vos appareils

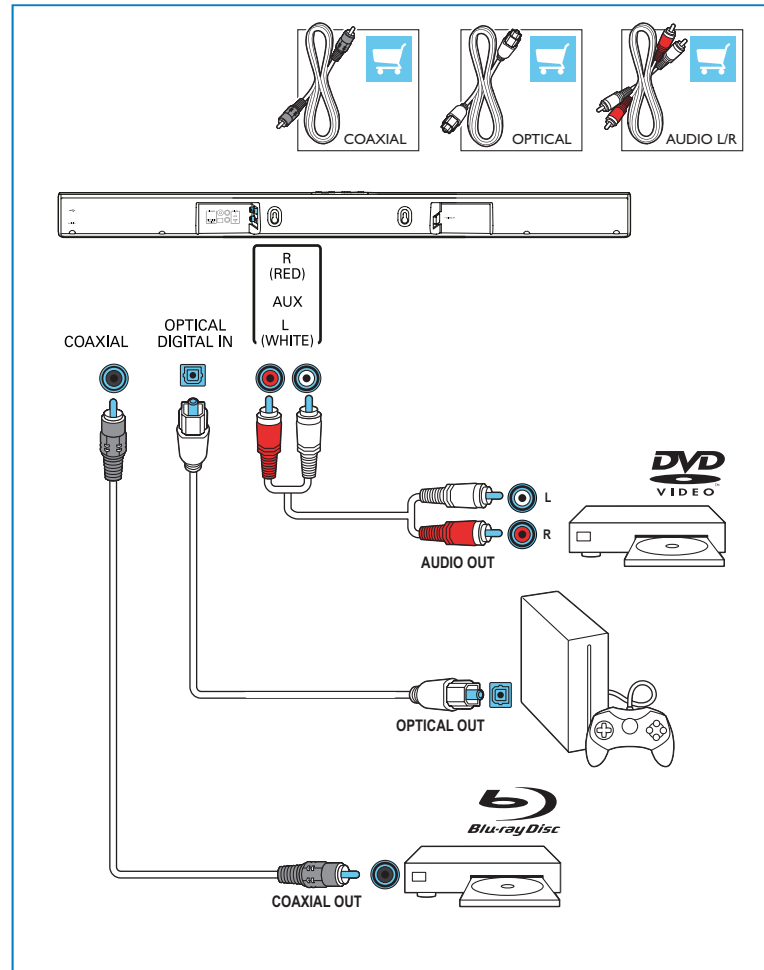

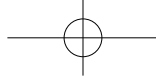

5

- EN** Switch on the SoundBar
- ES** Encendido del SoundBar
- FR-CA** Allumez le SoundBar

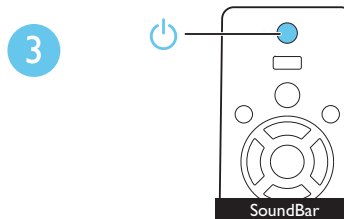
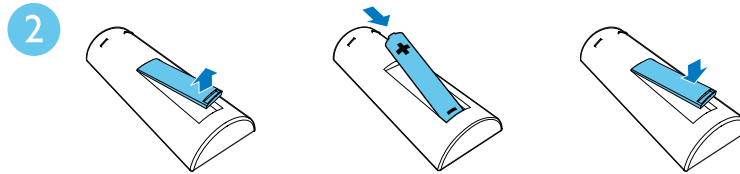
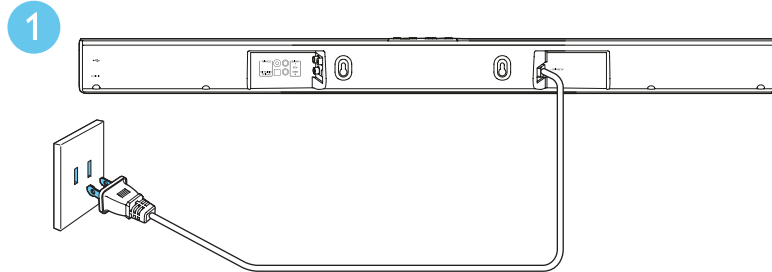

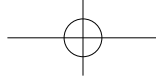

6

- EN** Select the correct audio source
- ES** Selección de la fuente de audio correcta
- FR-CA** Sélectionnez la source audio appropriée

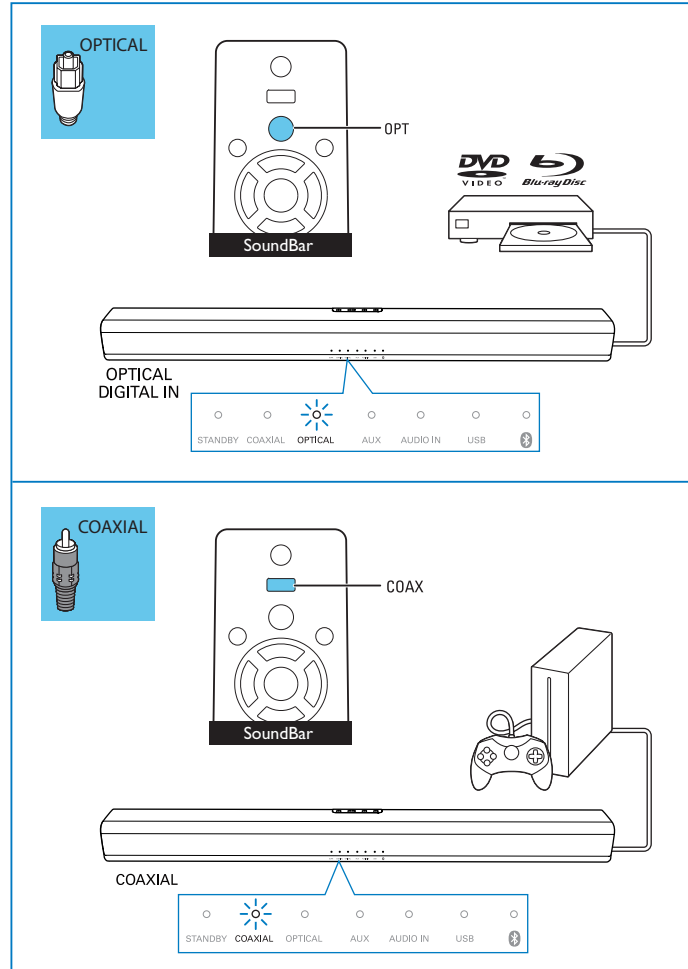

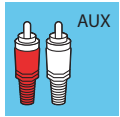
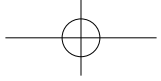

1

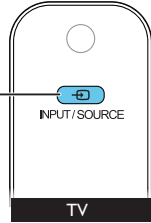

2

AUX

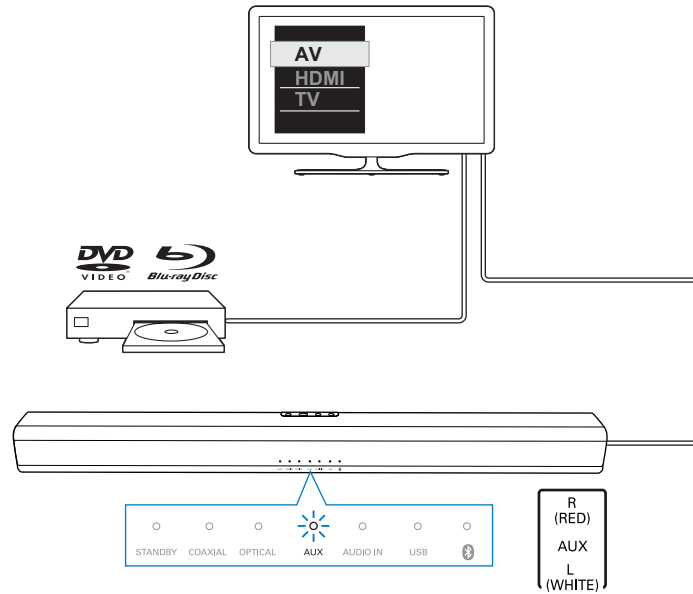
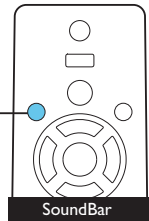

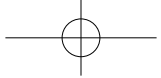

7

- EN** Play other devices
- ES** Reproducción de otros dispositivos
- FR-CA** Lisez le contenu d'autres appareils

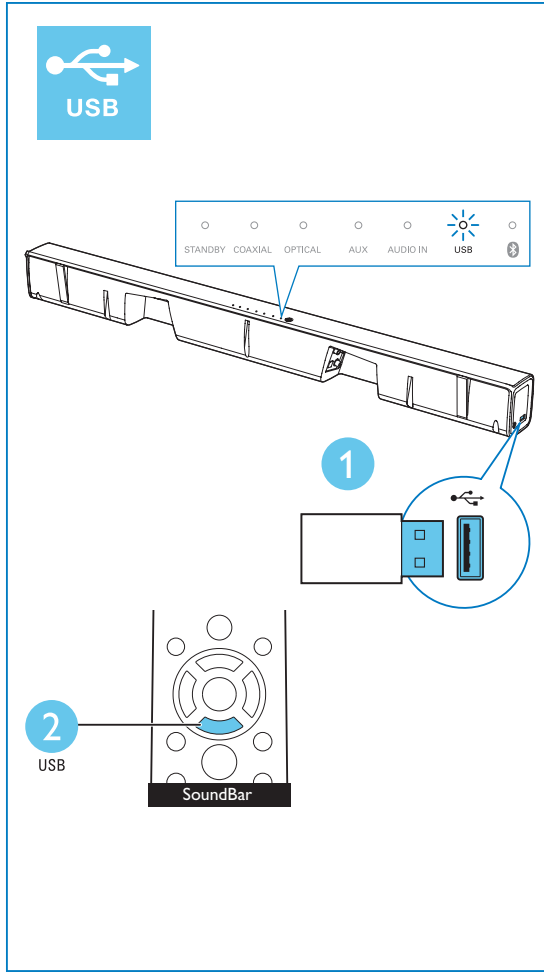
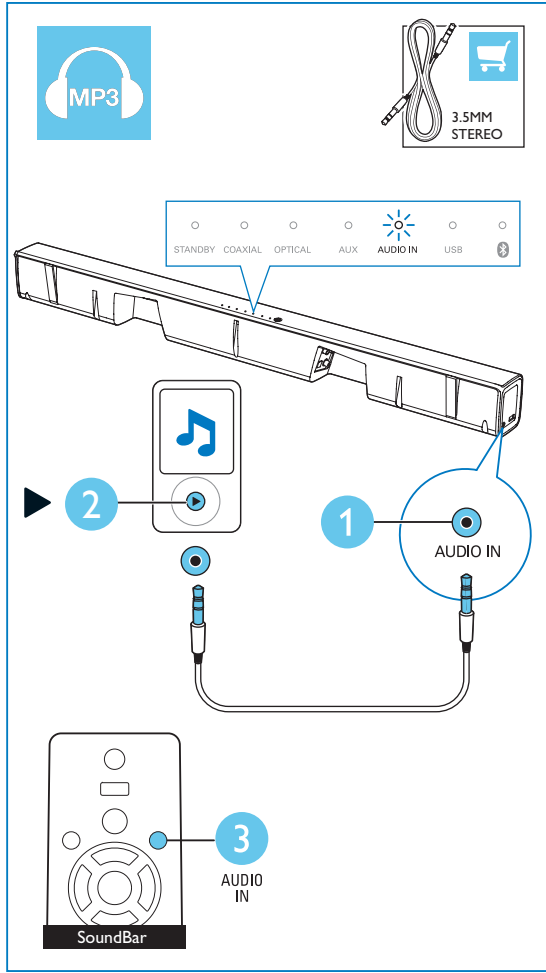



8

- EN** Play audio through Bluetooth
- ES** Reproducción de audio a través de Bluetooth
- FR-CA** Lisez du contenu audio par connexion Bluetooth

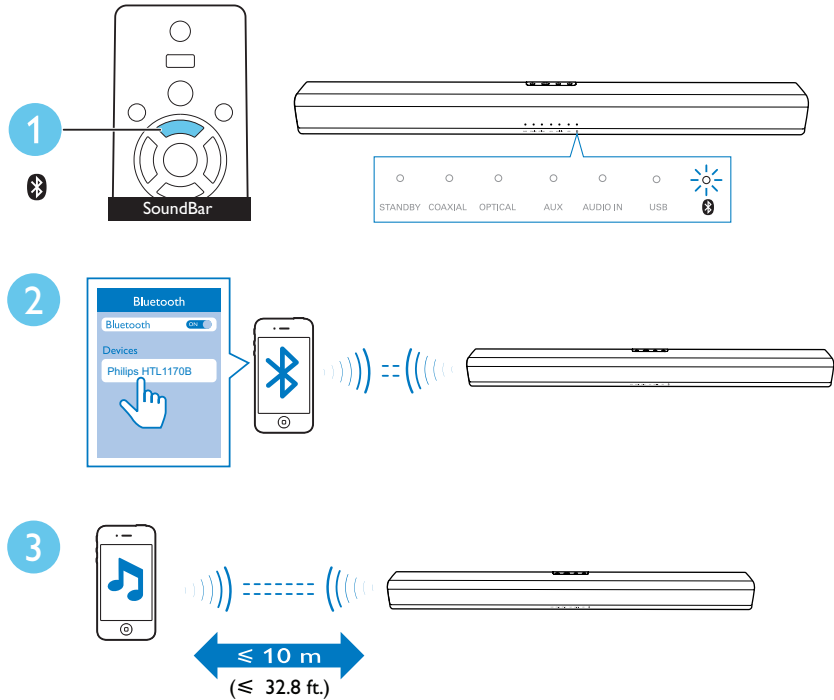

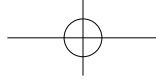

- EN** For more information about using this product, visit www.philips.com/support
- ES** Para obtener más información sobre este producto, visite www.philips.com/support
- FR-CA** Pour en savoir plus sur l'utilisation de ce produit, visitez le site www.philips.com/support



www.philips.com/support

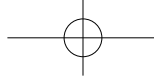

Manufactured under license from Dolby Laboratories. Dolby and the double-D symbol are trademarks of Dolby Laboratories.



The Bluetooth® word mark and logos are registered trademarks owned by Bluetooth SIG, Inc. and any use of such marks by WOOX Innovations is under license. Other trademarks and trade names are those of their respective owners.

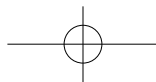
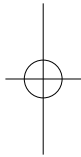
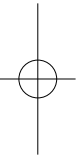

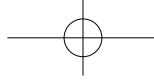

P&F USA, Inc.
PO Box 2248 Alpharetta, GA 30023-2248



Specifications are subject to change without notice
2014 © WOOX Innovations Limited. All rights reserved.
Philips and the Philips' Shield Emblem are registered trademarks of Koninklijke Philips N.V. and are used by
WOOX Innovations Limited under license from Koninklijke Philips N.V.

HTL1170B_F7_QSG_V1.0

