

Two folding paper with 1 color printing:
Finished size – W89 × H144 mm

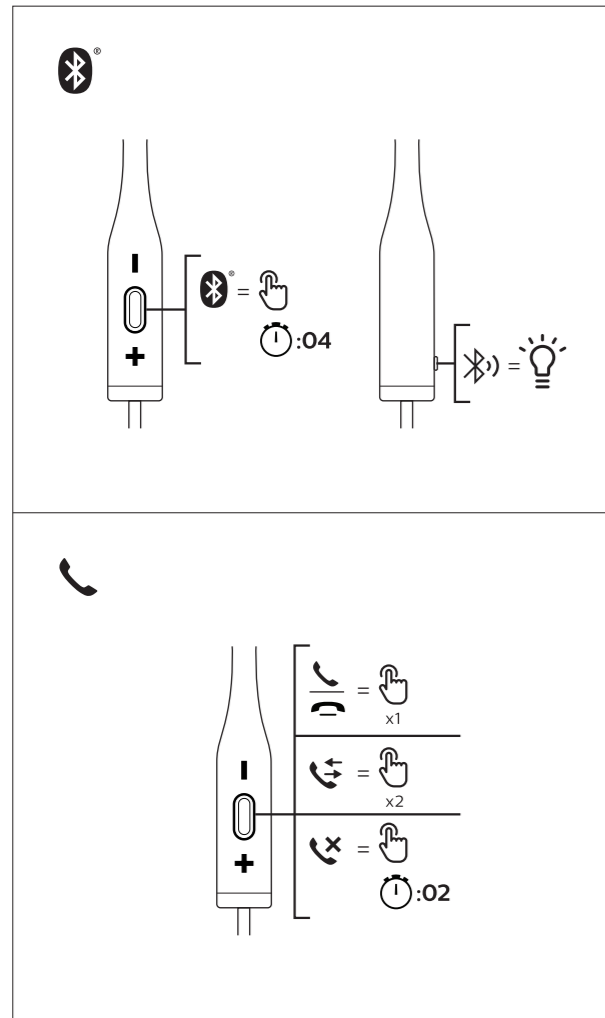

Welcome to Philips!
For an optimal experience register your product at:
www.philips.com/welcome

2015 © Gibson Innovations Limited. All rights reserved. This product has been manufactured by and is sold under the responsibility of Gibson Innovations Ltd, and Gibson Innovations Ltd, is the warrantor in relation to this product, Philips and the Philips Shield Emblem are registered trademarks of Koninklijke Philips N.V. and are used under license from Koninklijke Philips N.V.

低功率電波輻射性電機管理辦法

第十二條

經型式認證合格之低功率射頻電機，非經許可，公司、商號或使用者均不得擅自變更頻率、加大功率或變更原設計之特性及功能。

第十四條

低功率射頻電機之使用不得影響飛航安全及干擾合法通信；經發現有干擾現象時，應立即停用，並改善至無干擾時方得繼續使用。前項合法通信，指依電信法規定作業之無線電通信。低功率射頻電機須忍受合法通信或工業、科學及醫療用電波輻射性電機設備之干擾。

ADVERTÊNCIA: Cuidados com a utilização e descarte de pilhas e baterias.
Não descarte as pilhas e baterias juntamente ao lixo doméstico.
O descarte inadequado de pilhas e baterias pode representar riscos ao meio ambiente e à saúde humana.
Para contribuir com a qualidade ambiental e com sua saúde, a Philips receberá pilhas e baterias comercializadas ou fornecidas com seus produtos após seu fim de vida, que serão encaminhadas à destinação ambientalmente correta.
A Philips dispõe de pontos de coleta em Assistências Técnicas.

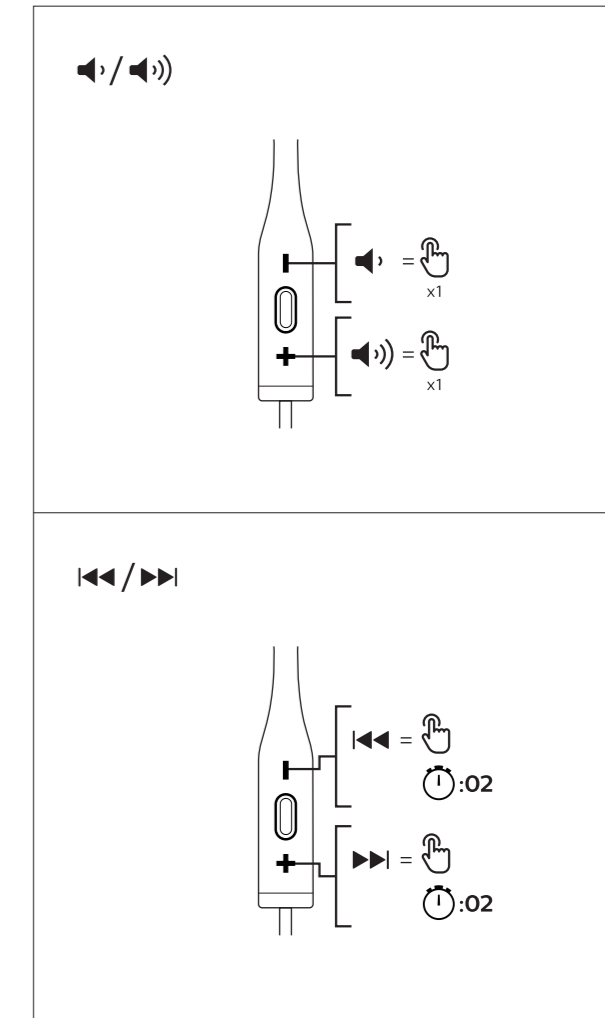
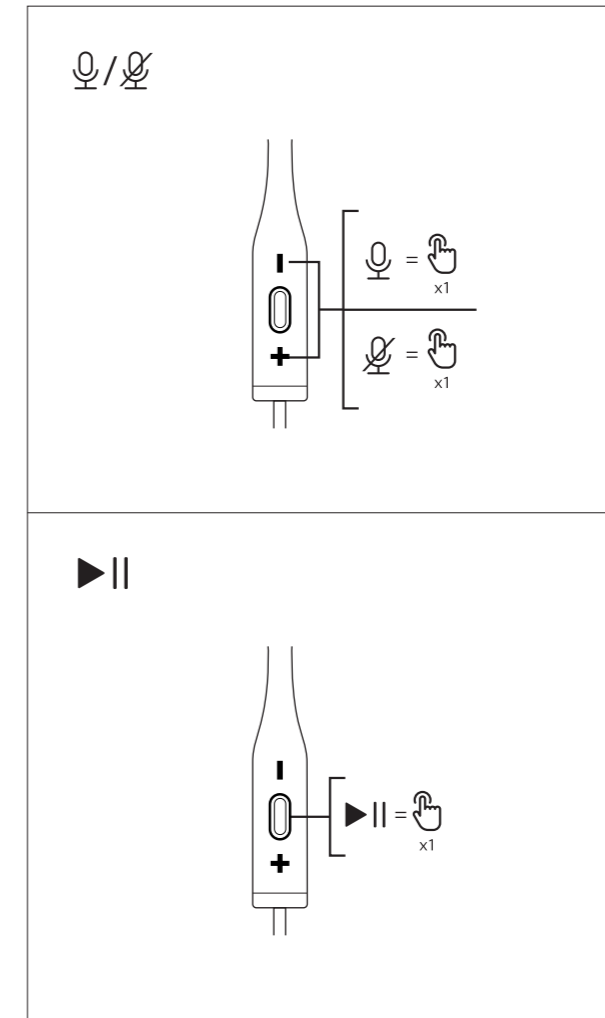
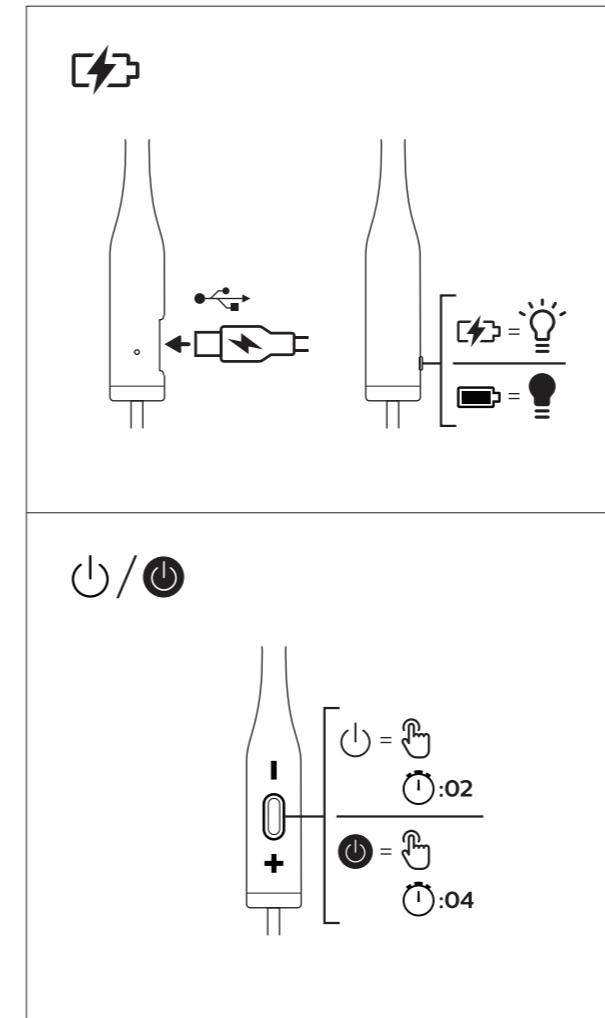
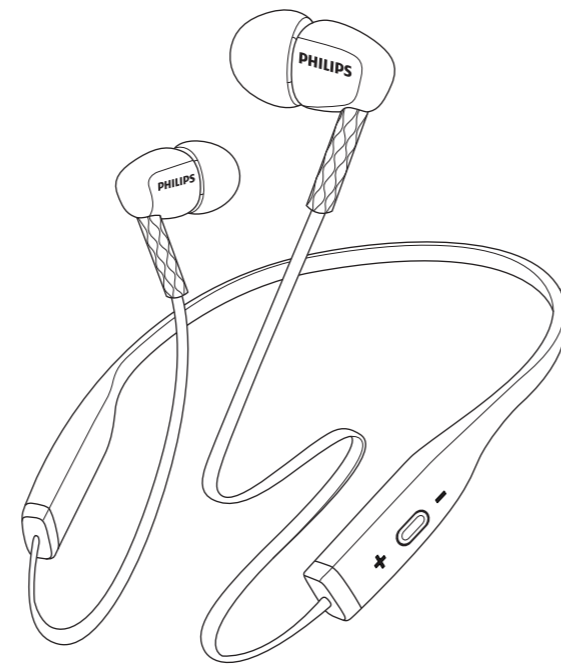
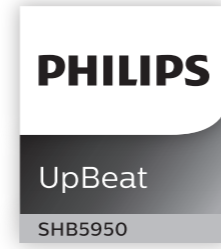
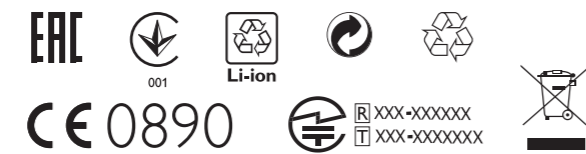

Version history		QSG ARTWORK		Scale: 100% Unit: mm			
Project:	SHB5950	Design Lead:	Liza Lau	DO NOT ERASE THIS TABLE			
Version	Summary of updates	Approved for use by	Date	Version	Summary of updates	Approved for use by	Date
v1.0	Artwork release	Liza Lau	20151202
...
...
...
...
...
...
...

Template version 2.0 | GI - B - 019 - 06 | Confidential