



When you installing AGP card, please make sure the following notice is fully understood and practiced. If your AGP card has "AGP 4X/8X(1.5V) notch"(show below), please make sure your AGP card is AGP 4X/8X(1.5V).



Caution: AGP 2X(3.3V) card is not supported by VIA® KT600. You might experience system unable to boot up normally. Please insert an AGP 4X/8X(1.5V) card

Example 1: Diamond Vipper V770 golden finger is compatible with 2X/4X mode AGP slot. It can be switched between AGP 2X(3.3V) or 4X(1.5V) mode by adjusting the jumper. The factory default for this card is 2X(3.3V).

The GA-7VT600(-L) (or any AGP 4X only) motherboards might not function properly, if you install this card without switching the jumper to 4X(1.5V) mode in it.

Example 2: Some ATI Rage 128 Pro graphics cards made by "Power Color", the graphics card manufacturer & some SiS 305 cards, their golden finger is compatible with 2X(3.3V)/4X(1.5V) mode AGP slot, but they support 2X(3.3V) only. The GA-7VT600(-L) (or any AGP 4X only) motherboards might not function properly, If you install this card in it.

Note : Although Gigabyte's AG32S(G) graphics card is based on ATI Rage 128 Pro chip, the design of AG32S(G) is compliance with AGP 4X(1.5V) specification. Therefore, AG32S (G)will work fine with VIA® KT600 based motherboards.



- ☛ The author assumes no responsibility for any errors or omissions that may appear in this document nor does the author make a commitment to update the information contained herein.
- ☛ Third-party brands and names are the property of their respective owners.
- ☛ Please do not remove any labels on motherboard, this may void the warranty of this motherboard.
- ☛ Due to rapid change in technology, some of the specifications might be out of date before publication of this booklet.



WARNING: *Never run the processor without the heatsink properly and firmly attached. PERMANENT DAMAGE WILL RESULT!*

Mise en garde : *Ne faites jamais tourner le processeur sans que le dissipateur de chaleur soit fixé correctement et fermement. UN DOMMAGE PERMANENT EN RÉSULTERA !*

Achtung: *Der Prozessor darf nur in Betrieb genommen werden, wenn der Wärmeableiter ordnungsgemäß und fest angebracht ist. DIES HAT EINEN PERMANENTEN SCHADEN ZUR FOLGE!*

Advertencia: *Nunca haga funcionar el procesador sin el dissipador de calor instalado correcta y firmemente. ¡SE PRODUCIRÁ UN DAÑO PERMANENTE!*

Aviso: *Nunca execute o processador sem o dissipador de calor estar adequado e firmemente conectado. O RESULTADO SERÁ UM DANO PERMANENTE!*

警告: 將散熱板牢固地安裝到處理器上之前，不要運行處理器。過熱將永遠損壞處理器！

警告: 將散熱器牢固地安裝到處理器上之前，不要運行處理器。過熱將永遠損壞處理器！

경고: 히트싱크를 제대로 또 단단히 부착시키지 않은 채 프로세서를 구동시키지 마십시오. 영구적 고장이 발생할 수 있습니다!

警告: 永久的な損傷を防ぐため、ヒートシンクを正しくしっかりと取り付けるまでは、プロセッサを動作させないようにしてください。

Declaration of Conformity

We, Manufacturer/Importer
(full address)

G.B.T. Technology Trädng GmbH
Ausschlagler Weg 41, 1F, 20537 Hamburg, Germany

declare that the product
(description of the apparatus, system, installation to which it refers)

Mother Board

GA-7VT600

is in conformity with

(reference to the specification under which conformity is declared)
in accordance with 89/336 EEC-EMC Directive

<input type="checkbox"/> EN 55011	Limits and methods of measurement of radio disturbance characteristics of industrial, scientific and medical (ISM) high frequency equipment	<input type="checkbox"/> EN 61000-3-2* <input checked="" type="checkbox"/> EN 60555-2	Disturbances in supply systems cause by household appliances and similar electrical equipment "Harmonics"
<input type="checkbox"/> EN 55013	Limits and methods of measurement of radio disturbance characteristics of broadcast receivers and associated equipment	<input type="checkbox"/> EN 61000-3-3* <input checked="" type="checkbox"/> EN 60555-3	Disturbances in supply systems cause by household appliances and similar electrical equipment "Voltage fluctuations"
<input type="checkbox"/> EN 55014	Limits and methods of measurement of radio disturbance characteristics of household electrical appliances, portable tools and similar electrical apparatus	<input checked="" type="checkbox"/> EN 50081-1 <input checked="" type="checkbox"/> EN 50082-1	Generic emission standard Part 1: Residual commercial and light industry Generic immunity standard Part 1: Residual commercial and light industry
<input type="checkbox"/> EN 55015	Limits and methods of measurement of radio disturbance characteristics of fluorescent lamps and luminaries	<input type="checkbox"/> EN 55081-2	Generic emission standard Part 2: Industrial environment
<input type="checkbox"/> EN 55020	Immunity from radio interference of broadcast receivers and associated equipment	<input type="checkbox"/> EN 55082-2	Generic emission standard Part 2: Industrial environment
<input checked="" type="checkbox"/> EN 55022	Limits and methods of measurement of radio disturbance characteristics of information technology equipment	<input type="checkbox"/> ENV 55104	Immunity requirements for household appliances tools and similar apparatus
<input type="checkbox"/> DIN VDE 0855 <input type="checkbox"/> part 10 <input type="checkbox"/> part 12	Cabled distribution systems: Equipment for receiving and/or distribution from sound and television signals	<input type="checkbox"/> EN50091-2	EMC requirements for uninterruptible power systems (UPS)

CE marking



(EC conformity marking)

The manufacturer also declares the conformity of above mentioned product
with the actual required safety standards in accordance with LVD 73/23 EEC

<input type="checkbox"/> EN 60065	Safety requirements for mains operated electronic and related apparatus for household and similar general use	<input type="checkbox"/> EN 60950	Safety for information technology equipment including electrical bussiness equipment
<input type="checkbox"/> EN 60335	Safety of household and similar electrical appliances	<input type="checkbox"/> EN 50091-1	General and Safety requirements for uninterruptible power systems (UPS)

Manufacturer/Importer

(Stamp)

Date :Jan. 12, 2004

Signature: Timmy Huang
Name: Timmy Huang

DECLARATION OF CONFORMITY

Per FCC Part 2 Section 2.1077(a)



Responsible PartName: G.B.T. INC. (U.S.A.)

**Address: 17358 Railroad Street
City of Industry, CA 91748**

Phone/Fax No: (818) 854-9338/ (818) 854-9339

hereby declares that the product

Product Name: Motherboard

Model Number:GA-7VT600

Conforms to the following specifications:

FCC Part 15, Subpart B, Section 15.107(a) and Section 15.109
(a),Class B Digital Device

Supplementary Information:

This device complies with part 15 of the FCC Rules. Operation is subject to the following two conditions: (1) This device may not cause harmful and (2) this device must accept any inference received, including that may cause undesired operation.

Representative Person's Name: ERIC LU

Signature: *Eric Lu*

Date: Jan. 12,2004

GA-7VT600(-L)
AMD Socket A Processor Motherboard

USER'S MANUAL

AMD Athlon™ / Athlon™ XP / Duron™ Socket A Processor Motherboard

Rev. 2001

12ME-7VT600-2001

Table of Contents

Item Checklist	4
WARNING!	4
Chapter 1 Introduction	5
Features Summary	5
GA-7VT600(-L) Motherboard Layout	7
Block Diagram	8
Chapter 2 Hardware Installation Process	11
Step 1: Set System Jumper (JP1)	12
Step 2: Install the Central Processing Unit (CPU)	13
Step 2-1: CPU Installation	13
Step 2-2: CPU Cooling Fan Installation	14
Step 3: Install Memory Modules	15
Step 4: Install Expansion Cards	17
Step 5: Connect Ribbon Cables, Cabinet Wires and Power Supply	18
Step 5-1 : I/O Back Panel Introduction	18
Step 5-2 : Connectors Introduction	20
Chapter 3 BIOS Setup	31
The Main Menu (For example: BIOS Ver. : F4c)	32
Standard CMOS Features	34
Advanced BIOS Features	37
Integrated Peripherals	39
Power Management Setup	43
PnP/PCI Configurations	46

PC Health Status	47
Frequency/Voltage Control	49
Load Fail-Safe Defaults	51
Load Optimized Defaults	52
Set Supervisor/User Password	53
Save & Exit Setup	54
Exit Without Saving	55
Chapter 4 Technical Reference	57
@BIOS™ Introduction	57
EasyTune™ 4 Introduction	58
Flash BIOS Method Introduction	59
2- / 4- / 6-Channel Audio Function Introduction	74
Jack-Sensing Introduction	80
Xpress Recovery Introduction	82
Chapter 5 Appendix	85

Item Checklist

- | | |
|---|--|
| <input checked="" type="checkbox"/> The GA-7VT600(-L) motherboard | <input type="checkbox"/> 4 Port USB cable x 1 |
| <input checked="" type="checkbox"/> CD for motherboard driver & utility (Driver CD) | <input type="checkbox"/> Audio combo kit x 1 |
| <input checked="" type="checkbox"/> The GA-7VT600(-L) user's manual | <input type="checkbox"/> IEEE 1394 cable x 1 |
| <input checked="" type="checkbox"/> Quick PC installation guide | <input type="checkbox"/> Serial ATA cable x 2 |
| <input type="checkbox"/> RAID manual | <input type="checkbox"/> Serial ATA power cable x 1 |
| <input checked="" type="checkbox"/> IDE cable x 2 / Floppy cable x 1 | <input checked="" type="checkbox"/> I/O shield |
| <input checked="" type="checkbox"/> 2 Port USB cable x 1 | <input checked="" type="checkbox"/> Motherboard settings label |



WARNING!

Computer motherboards and expansion cards contain very delicate Integrated Circuit (IC) chips. To protect them against damage from static electricity, you should follow some precautions whenever you work on your computer.

1. Unplug your computer when working on the inside.
2. Use a grounded wrist strap before handling computer components. If you do not have one, touch both of your hands to a safely grounded object or to a metal object, such as the power supply case.
3. Hold components by the edges and try not touch the IC chips, leads or connectors, or other components.
4. Place components on a grounded antistatic pad or on the bag that came with the components whenever the components are separated from the system.
5. Ensure that the ATX power supply is switched off before you plug in or remove the ATX power connector on the motherboard.

Installing the motherboard to the chassis...

If the motherboard has mounting holes, but they don't line up with the holes on the base and there are no slots to attach the spacers, do not become alarmed you can still attach the spacers to the mounting holes. Just cut the bottom portion of the spacers (the spacer may be a little hard to cut off, so be careful of your hands). In this way you can still attach the motherboard to the base without worrying about short circuits. Sometimes you may need to use the plastic springs to isolate the screw from the motherboard PCB surface, because the circuit wire may be near by the hole. Be careful, don't let the screw contact any printed circuit write or parts on the PCB that are near the fixing hole, otherwise it may damage the board or cause board malfunctioning.

Chapter 1 Introduction

Features Summary

Form Factor	<ul style="list-style-type: none"> • 30.5cm x 20.0cm ATX size form factor, 4 layers PCB.
CPU	<ul style="list-style-type: none"> • Socket A processor • AMD Athlon™/ Athlon™ XP/ Duron™ (K7) • 128K L1 & 512K/256K/64K L2 cache on die • 200/266/333/400 MHz FSB • Supports 1.4GHz and faster
Chipset	<ul style="list-style-type: none"> • VIA KT600 Memory/AGP Controller (PAC) • VIA VT8235 Integrated Peripheral Controller (PSIPC)
Memory	<ul style="list-style-type: none"> • 3 184-pin DDR sockets • Supports DDR DRAM PC2100/PC2700/PC3200 • Supports up to 3.0GB DDR (Max) • Supports only 2.5V DDR DIMM
I/O Control	<ul style="list-style-type: none"> • IT8705
Slots	<ul style="list-style-type: none"> • 1 AGP slot supports 8X/4X mode(1.5V) & AGP 3.0 compliant • 5 PCI slots supports 33MHz & PCI 2.2 compliant
On-Board IDE	<ul style="list-style-type: none"> • 2 IDE controllers provides IDE HDD/CD-ROM (IDE1, IDE2) with PIO, Bus Master (Ultra DMA33/ATA66/ATA100/ATA133) operation mode
On-Board Peripherals	<ul style="list-style-type: none"> • 1 Floppy port supports 2 FDD with 360K, 720K,1.2M, 1.44M and 2.88M bytes • 1 Parallel port supports Normal/EPP/ECP mode • 2 Serial port (COMA & COMB) • 6 x USB 2.0/1.1 (4 by cable)
Hardware Monitor	<ul style="list-style-type: none"> • CPU/System Fan Revolution detect • CPU/System temperature detect • System voltage detect • CPU/System fan fail warning • Thermal shutdown function
On-Board Sound	<ul style="list-style-type: none"> • Realtek ALC655 CODEC • Supports Jack Sensing function • Line Out / 2 front speaker • Line In / 2 rear speaker(by s/w switch) • Mic In / center & subwoofer(by s/w switch) • SPDIF Out /SPDIF In • CD In / AUX In / Game connector

to be continued.....

On-Board USB 2.0	<ul style="list-style-type: none"> • Built in VIA VT8235 Chipset
On-Board LAN *	<ul style="list-style-type: none"> • VIA VT6103L • 1 RJ45 port
PS/2 Connector	<ul style="list-style-type: none"> • PS/2 Keyboard interface and PS/2 Mouse interface
BIOS	<ul style="list-style-type: none"> • Licensed Award BIOS • Supports Q-Flash
Additional Features	<ul style="list-style-type: none"> • PS/2 Keyboard power on by password, • PS/2 Mouse power on by double click • External Modem wake up • STR(Suspend-To-RAM) • AC Recovery • Poly fuse for keyboard over-current protection • USB KB/Mouse wake up from S3 • Supports @BIOS • Supports EasyTune 4
Overclocking	<ul style="list-style-type: none"> • Over Voltage (CPU/AGP/DDR/PCI) by BIOS • Over Clock (CPU/AGP/DDR/PCI) by BIOS



Please set the CPU host frequency in accordance with your processor's specifications.

We don't recommend you to set the system bus frequency over the CPU's specification because these specific bus frequencies are not the standard specifications for CPU, chipset and most of the peripherals. Whether your system can run under these specific bus frequencies properly will depend on your hardware configurations, including CPU, Memory, Cards...etc.

" * " For GA-7VT600-L only.

GA-7VT600(-L) Motherboard Layout

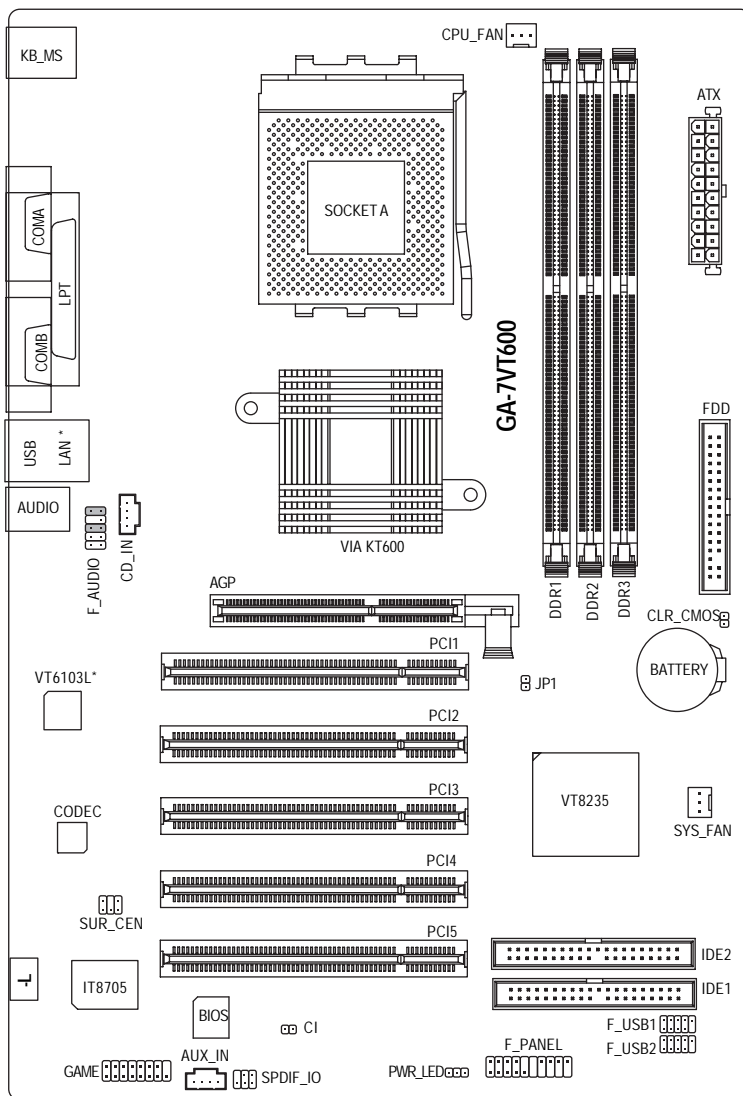

* * * For GA-7VT600-L only.

Block Diagram

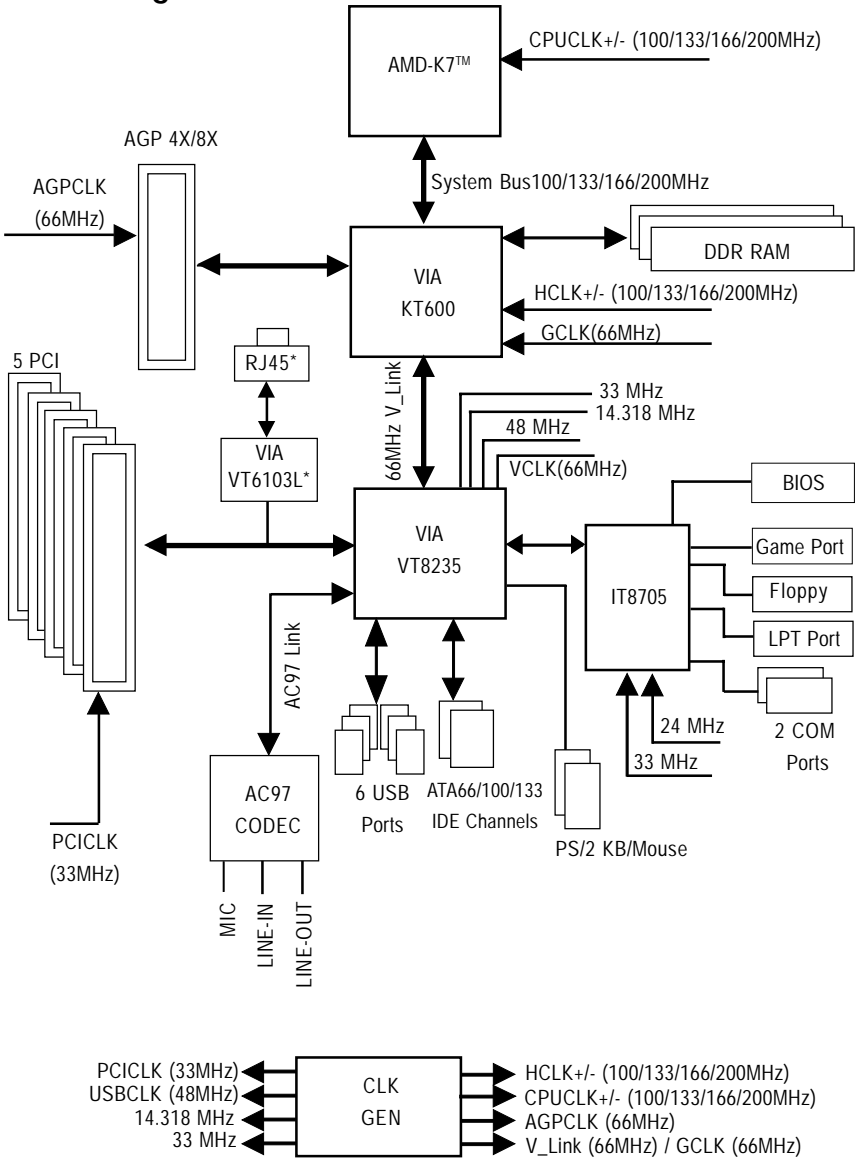

* * * For GA-7VT600-L only.

Chapter 2 Hardware Installation Process

To set up your computer, you must complete the following steps:

Step 1- Set System Jumper (JP1)

Step 2- Install the Central Processing Unit (CPU)

Step 3- Install memory modules

Step 4- Install expansion cards

Step 5- Connect ribbon cables, cabinet wires, and power supply

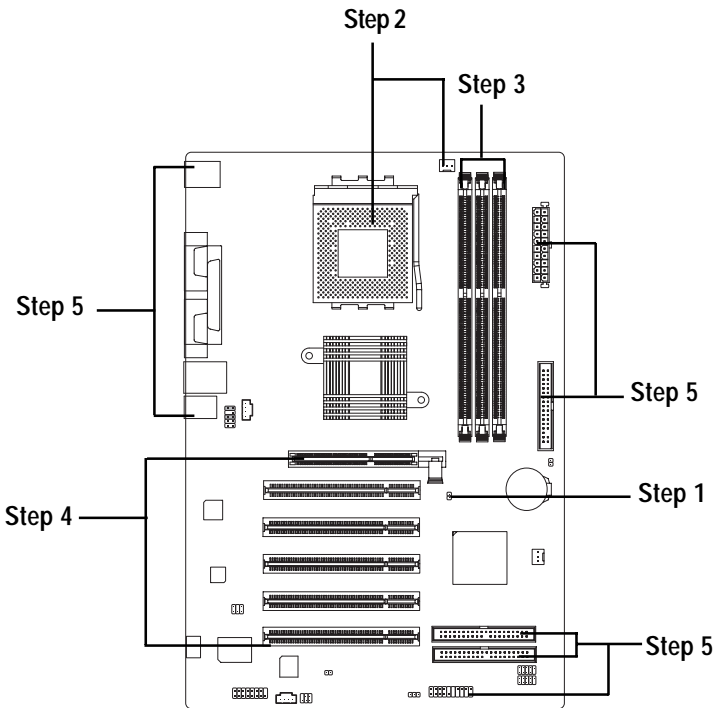



Congratulations you have accomplished the hardware installation!

Turn on the power supply or connect the power cable to the power outlet. Continue with the BIOS/software installation.

Step 1: Set System Jumper (JP1)

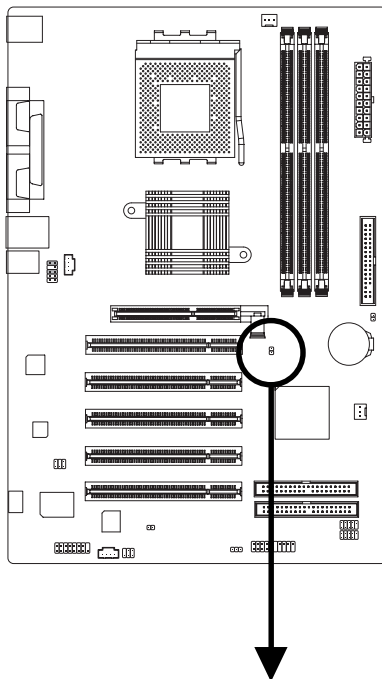
The system bus frequency can be switched at 100/133/166/200MHz by adjusting system jumper (JP1).
(The internal frequency depend on CPU.)



 Open: Auto
1

 Close: 100MHz (Default)
1

JP1	CPU CLOCK	
		100MHz
1-2	Close	Open

100MHz : Fix FSB 200MHz CPU

Auto : Support FSB 266/333/400 MHz CPU



The "JP1" must set to "Auto" when you are using FSB 266/333/400MHz CPU.

Step 2: Install the Central Processing Unit (CPU)



Before installing the processor, adhere to the following warning:

1. Please make sure the CPU type is supported by the motherboard.
2. If you do not match the CPU socket Pin 1 and CPU cut edge well, it will cause improper installation. Please change the insert orientation.

Step 2-1: CPU Installation



CPU Top View

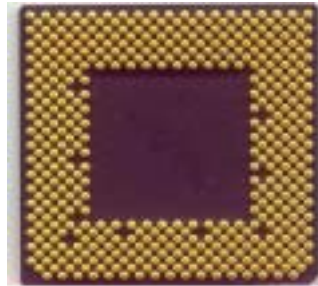

CPU Bottom View

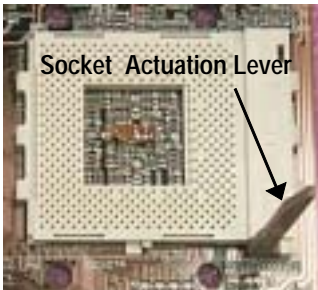

1. Pull up the CPU socket lever and up to 90-degree angle.

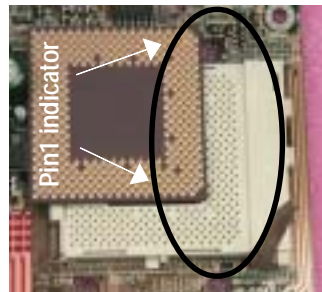

2. Locate Pin 1 in the socket and look for a (golden) cut edge on the CPU upper corner. Then insert the CPU into the socket.

Step 2-2: CPU Cooling Fan Installation



Before installing the CPU cooling fan, adhere to the following warning:

1. Please use AMD approved cooling fan.
2. We recommend you to apply the thermal tape to provide better heat conduction between your CPU and cooling fan.
3. Make sure the CPU fan power cable is plugged in to the CPU fan connector, this completes the installation.

Please refer to CPU cooling fan user's manual for more detail installation procedure.



1. Press down the CPU socket lever and finish CPU installation.



2. Use qualified fan approved by AMD.

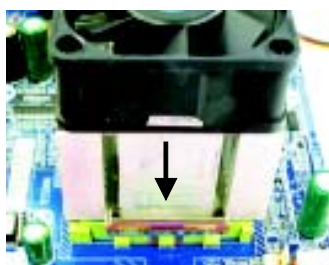

3. Fasten the cooling fan supporting-base onto the CPU socket on the motherboard.

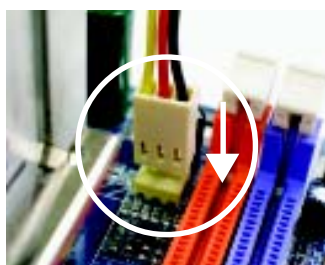

4. Make sure the CPU fan is plugged to the CPU fan connector, then install completely.

Step 3: Install Memory Modules



Before installing the memory modules, adhere to the following warning:

1. Please note that the DIMM module can only fit in one direction due to the notch. Wrong orientation will cause improper installation. Please change the insert orientation.

The motherboard has 3 dual inline memory module (DIMM) sockets. The BIOS will automatically detects memory type and size. To install the memory module, just push it vertically into the DIMM socket. The DIMM module can only fit in one direction due to the notch. Memory size can vary between sockets.

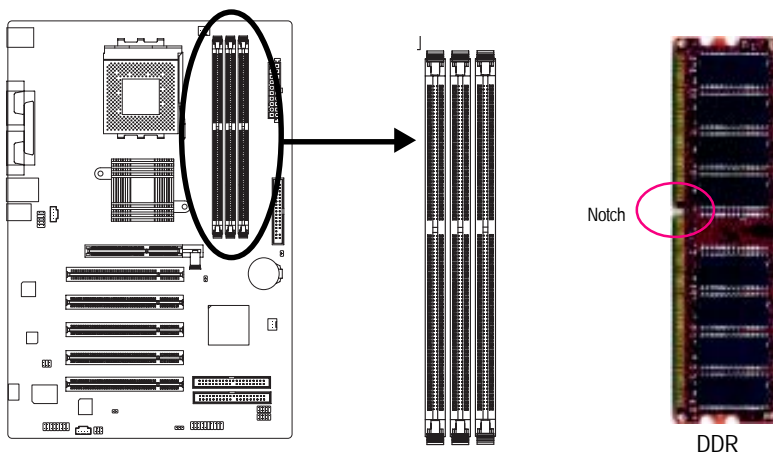

Support Unbuffered DDR DIMM Sizes type:

64 Mbit (2Mx8x4 banks)	64 Mbit (1Mx16x4 banks)	128 Mbit(4Mx8x4 banks)
128 Mbit(2Mx16x4 banks)	256 Mbit(8Mx8x4 banks)	256 Mbit(4Mx16x4 banks)
512 Mbit(16Mx8x4 banks)	512 Mbit(8Mx16x4 banks)	
Total System Memory (Max3GB)		

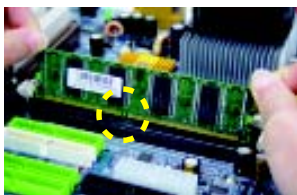

1. The DIMM slot has a notch, so the DIMM memory module can only fit in one direction.
2. Insert the DIMM memory module vertically into the DIMM slot. Then push it down.
3. Close the plastic clip at both edges of the DIMM slots to lock the DIMM module.
Reverse the installation steps when you wish to remove the DIMM module.

DDR Introduction

Established on the existing SDRAM infrastructure, DDR (Double Data Rate) memory is a high performance and cost-effective solution that allows easy adoption for memory vendors, OEMs, and system integrators.

DDR memory is a great evolutionary solution for the PC industry that builds on the existing SDRAM architecture, yet make the awesome advances in solving the system performance bottleneck by doubling the memory bandwidth. Nowadays, with the highest bandwidth of 3.2GB/s of DDR400 memory and complete line of DDR400/333/266/200 memory solutions, DDR memory is the best choice for building high performance and low latency DRAM subsystem that are suitable for servers, workstations, and full range of desktop PCs.

Step 4: Install Expansion Cards

1. Read the related expansion card's instruction document before install the expansion card into the computer.
2. Remove your computer's chassis cover, necessary screws and slot bracket from the computer.
3. Press the expansion card firmly into expansion slot in motherboard.
4. Be sure the metal contacts on the card are indeed seated in the slot.
5. Replace the screw to secure the slot bracket of the expansion card.
6. Replace your computer's chassis cover.
7. Power on the computer, if necessary, setup BIOS utility of expansion card from BIOS.
8. Install related driver from the operating system.



AGP Card

Please carefully pull out the small white-drawable bar at the end of the AGP slot when you try to install/uninstall the AGP card. Please align the AGP card to the onboard AGP slot and press firmly down on the slot. Make sure your AGP card is locked by the small white-drawable bar.

Step 5: Connect Ribbon Cables, Cabinet Wires and Power Supply

Step 5-1 : I/O Back Panel Introduction

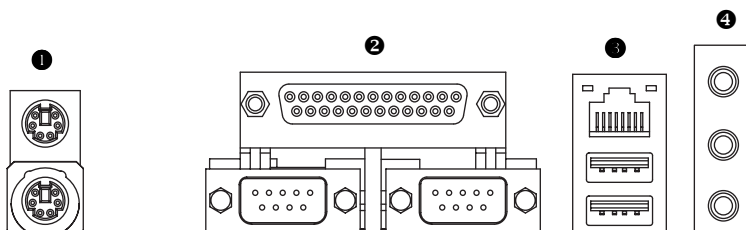

❶ PS/2 Keyboard and PS/2 Mouse Connector



PS/2 Mouse Connector
(6 pin Female)

PS/2 Keyboard Connector
(6 pin Female)

➤ This connector supports standard PS/2 keyboard and PS/2 mouse.

❷ Parallel Port and Serial Ports (COMA / COMB)

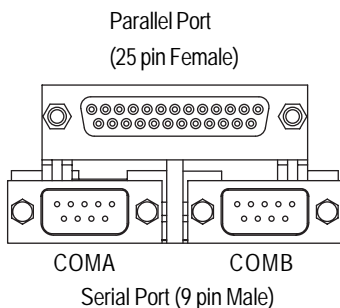

➤ This connector supports 2 standard COM ports and 1 Parallel port. Device like printer can be connected to Parallel port; mouse and modem etc. can be connected to Serial ports.

③ USB/LAN* Connector

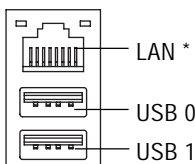

- LAN is fast Ethernet with 10/100Mbps speed.
- Before you connect your device(s) into USB connector(s), please make sure your device(s) such as USB keyboard, mouse, scanner, zip, speaker... etc. Have a standard USB interface. Also make sure your OS supports USB controller. If your OS does not support USB controller, please contact OS vendor for possible patch or driver upgrade. For more information please contact your OS or device(s) vendors.

④ Audio Connectors

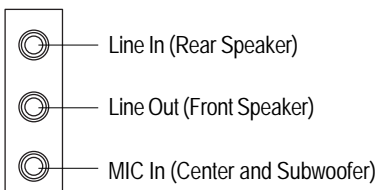

- After install onboard audio driver, you may connect speaker to Line Out jack, microphone to MIC In jack. Device like CD-ROM, walkman etc. can be connected to Line-In jack.

Please note:

You are able to use 2-/4-/6-channel audio feature by S/W selection.

If you want to enable 6-channel function, you have 2 choose for hardware connection.

Method1:

Connect "Front Speaker" to "Line Out"

Connect "Rear Speaker" to "Line In"

Connect "Center and Subwoofer" to "MIC Out".

Method2:

You can refer to page 26, and contact your nearest dealer for optional SUR_CEN cable.



If you want the detail information for 2-/4-/6-channel audio setup installation, please refer to page 74.

* * * For GA-7VT600-L only.

Step 5-2 : Connectors Introduction

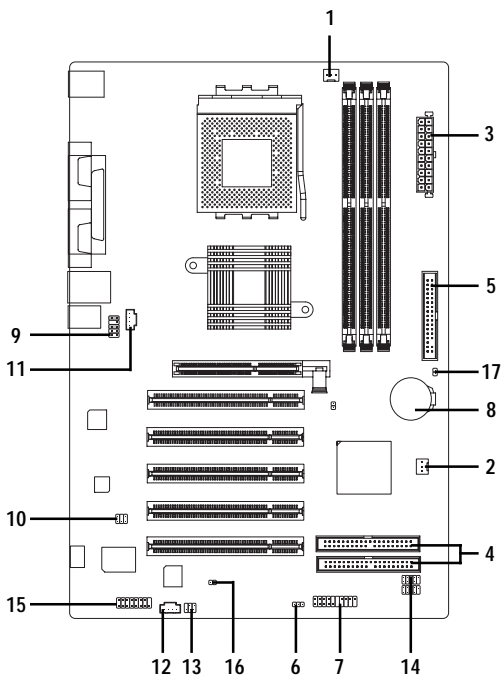

1) CPU_FAN	10) SUR_CEN
2) SYS_FAN	11) CD_IN
3) ATX (ATX Power)	12) AUX_IN
4) IDE1 / IDE2	13) SPDIF_IO
5) FDD	14) F_USB1 / F_USB2
6) PWR_LED	15) GAME
7) F_PANEL	16) CI (Case Open)
8) BATTERY	17) CLR_CMOS
9) F_AUDIO	

1) CPU_FAN (CPU FAN Connector)

Please note, a proper installation of the CPU cooler is essential to prevent the CPU from running under abnormal condition or damaged by overheating. The CPU fan connector supports Max. current up to 600 mA.

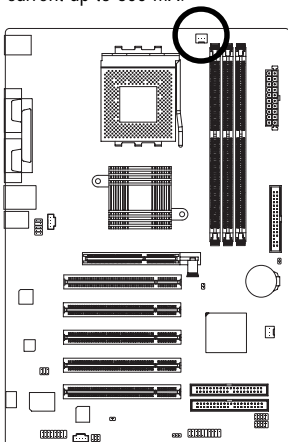

Pin No.	Definition
1	GND
2	+12V
3	Sense

2) SYS_FAN (System FAN Connector)

This connector allows you to link with the cooling fan on the system case to lower the system temperature.

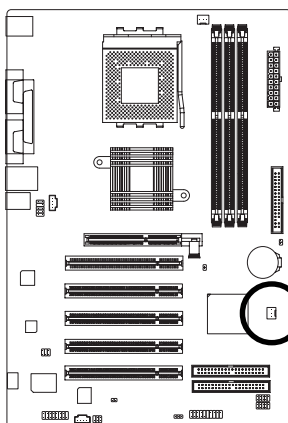

Pin No.	Definition
1	GND
2	+12V
3	Sense

3) ATX (ATX Power Connector)

AC power cord should only be connected to your power supply unit after ATX power cable and other related devices are firmly connected to the mainboard.

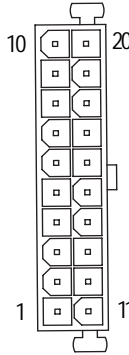
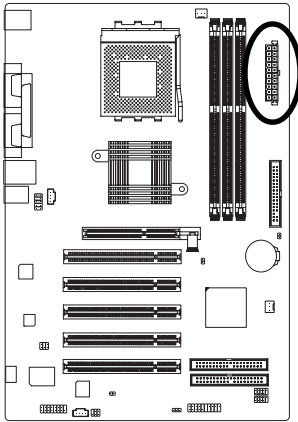

Pin No.	Definition
1	3.3V
2	3.3V
3	GND
4	VCC
5	GND
6	VCC
7	GND
8	Power Good
9	5V SB (stand by +5V)
10	+12V
11	3.3V
12	-12V
13	GND
14	PS_ON(soft on/off)
15	GND
16	GND
17	GND
18	-5V
19	VCC
20	VCC

4) IDE1/ IDE2(IDE1/IDE2 Connector)

Please connect first harddisk to IDE1 and connect CDROM to IDE2. The red stripe of the ribbon cable must be the same side with the Pin1.

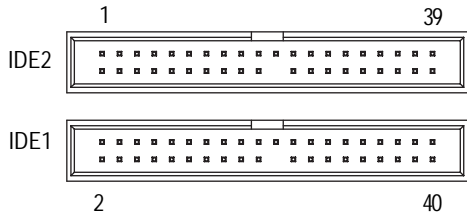
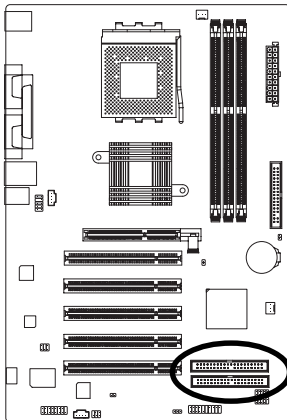

5) FDD (Floppy Connector)

Please connect the floppy drive ribbon cables to FDD. It supports 360K,720K,1.2M,1.44M and 2.88Mbytes floppy disk types. The red stripe of the ribbon cable must be the same side with the Pin1.

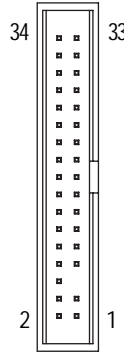
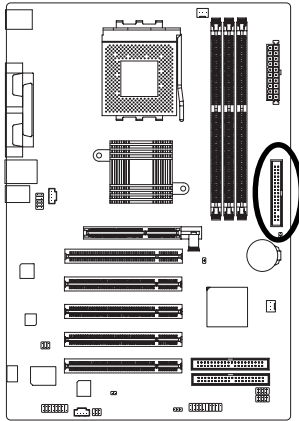

6) PWR_LED

PWR_LED is connect with the system power indicator to indicate whether the system is on/off. It will blink when the system enters suspend mode. If you use dual color LED, power LED will turn to another color.

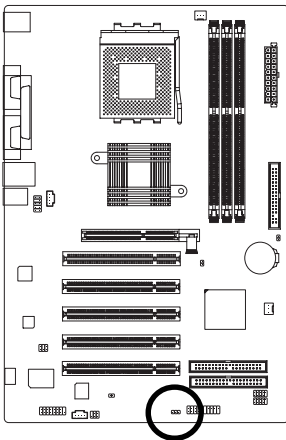

Pin No.	Definition
1	MPD+
2	MPD-
3	MPD-

7) F_PANEL (2 x 10 pins Connector)

Please connect the power LED, PC speaker, reset switch and power switch etc. of your chassis front panel to the F_PANEL connector according to the pin assignment below.

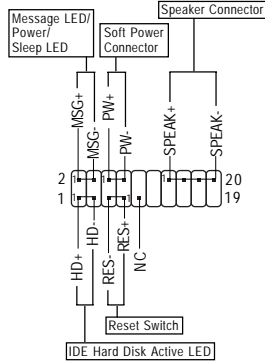
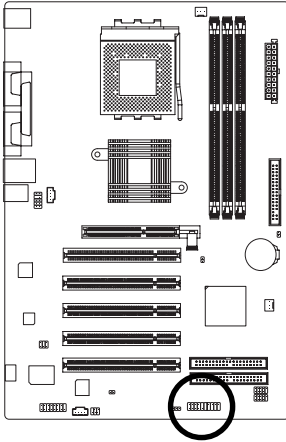

HD (IDE Hard Disk Active LED) (Blue)	Pin 1: LED anode(+) Pin 2: LED cathode(-)
SPK (Speaker Connector) (Amber)	Pin 1: VCC(+) Pin 2- Pin 3: NC Pin 4: Data(-)
RES (Reset Switch) (Green)	Open: Normal Operation Close: Reset Hardware System
PW (Soft Power Connector) (Red)	Open: Normal Operation Close: Power On/Off
MSG(Message LED/Power/Sleep LED) (Yellow)	Pin 1: LED anode(+) Pin 2: LED cathode(-)
NC (Purple)	N C

8) BATTERY (Battery)

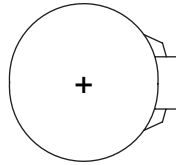
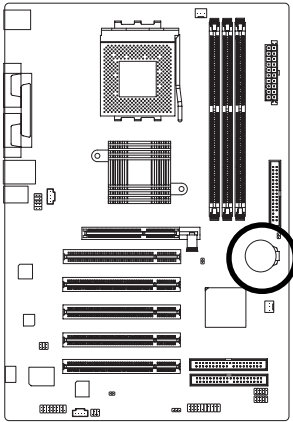

CAUTION

- ❖ Danger of explosion if battery is incorrectly replaced.
- ❖ Replace only with the same or equivalent type recommended by the manufacturer.
- ❖ Dispose of used batteries according to the manufacturer's instructions.

If you want to erase CMOS...

1. Turn off the computer and unplug the power cord.
2. Remove the battery, wait for 30 second.
3. Re-install the battery.
4. Plug the power cord and turn on the computer.

9) F_AUDIO (Front Audio Connector)

If you want to use Front Audio connector, you must remove 5-6, 9-10 Jumper.

In order to utilize the front audio header, your chassis must have front audio connector. Also please make sure the pin assignment on the cable is the same as the pin assignment on the MB header. To find out if the chassis you are buying support front audio connector, please contact your dealer. Please note, you can have the alternative of using front audio connector or of using rear audio connector to play sound.

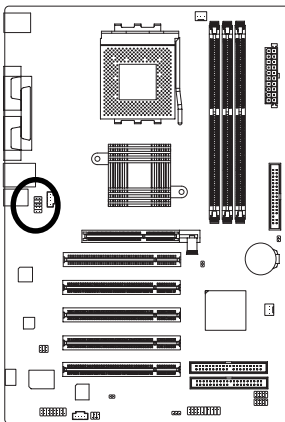

Pin No.	Definition
1	MIC
2	GND
3	REF
4	Power
5	Front Audio (R)
6	Rear Audio (R)
7	Reserved
8	No Pin
9	Front Audio (L)
10	Rear Audio (L)

10) SUR_CEN (Surround Center Connector)

Please contact your nearest dealer for optional SUR_CEN cable.

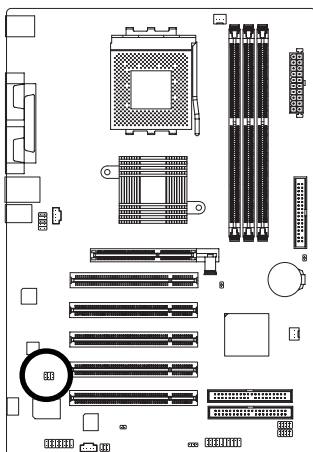

Pin No.	Definition
1	SUR OUTL
2	SUR OUTR
3	GND
4	No Pin
5	CENTER_OUT
6	BASS_OUT

11) CD_IN (CD In Connector)

Connect CD-ROM or DVD-ROM audio out to the connector.

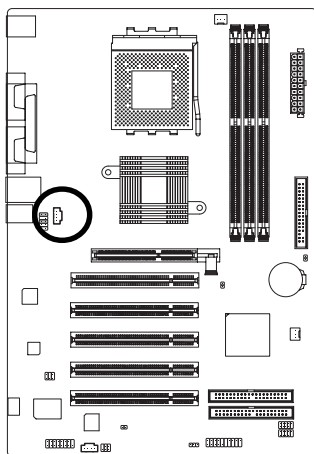

Pin No.	Definition
1	CD-L
2	GND
3	GND
4	CD-R

12) AUX_IN (AUX In Connector)

Connect other device (such as PCI TV Tuner audio out)to the connector.

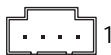
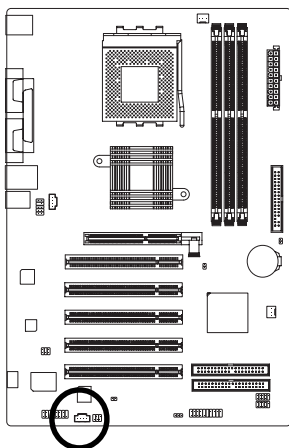

Pin No.	Definition
1	AUX-L
2	GND
3	GND
4	AUX-R

13) SPDIF_IO (SPDIF In/Out Connector)

The SPDIF output is capable of providing digital audio to external speakers or compressed AC3 data to an external Dolby Digital Decoder. Use this feature only when your stereo system has digital input and output function. Use SPDIF in feature only when your device has digital output function. Be careful with the polarity of the SPDIF_IO connector. Check the pin assignment carefully while you connect the SPDIF cable, incorrect connection between the cable and connector will make the device unable to work or even damage it. For optional SPDIF cable, please contact your local dealer.

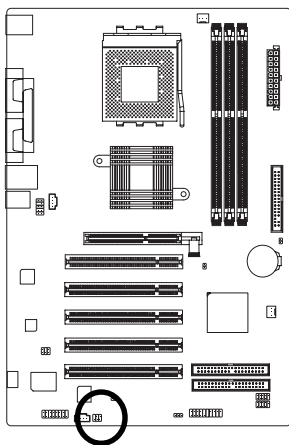

Pin No.	Definition
1	VCC
2	No Pin
3	SPDIF
4	SPDIF I
5	GND
6	GND

14) F_USB1 / F_USB2 (Front USB Connector, Yellow)

Be careful with the polarity of the F_USB connector. Check the pin assignment carefully while you connect the F_USB cable, incorrect connection between the cable and connector will make the device unable to work or even damage it. For optional F_USB cable, please contact your local dealer.

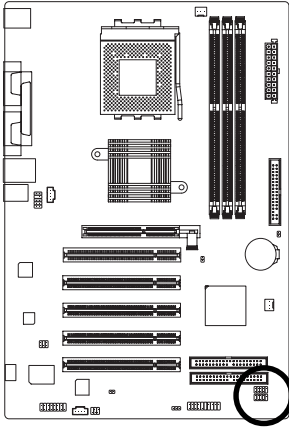

Pin No.	Definition
1	Power
2	Power
3	USB0 DX-/USB2 DX-
4	USB1 Dy-/USB3 Dy-
5	USB0 DX+/USB2 DX+
6	USB1 Dy+/USB3 Dy+
7	GND
8	GND
9	No Pin
10	NC

15) GAME (Game Connector)

This connector supports joystick, MIDI keyboard and other relate audio devices. Check the pin assignment while you connect the game cables. Please contact your nearest dealer for optional game cables.

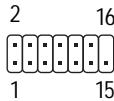
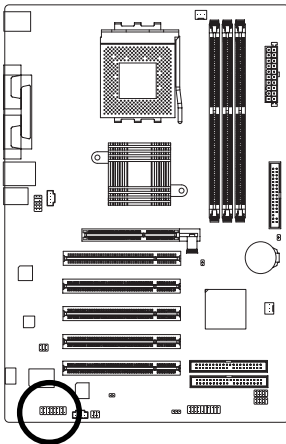

Pin No.	Definition
1	VCC
2	GRX1_R
3	GND
4	GPSA2
5	VCC
6	GPX2_R
7	GPY2_R
8	MSL_R
9	GPSA1
10	GND
11	GPY1_R
12	VCC
13	GPSB1
14	MSSO_R
15	GPSB2
16	No Pin

16) CI (Chassis Intrusion, Case Open)

This 2-pin connector allows your system to enable or disable the "case open" item in BIOS if the system case begin remove.

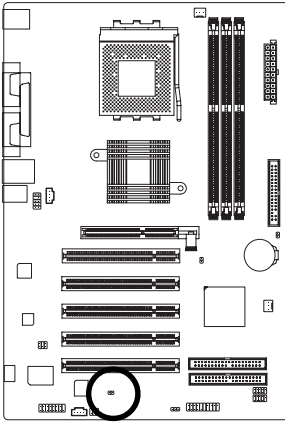

Pin No.	Definition
1	Signal
2	GND

17) CLR_CMOS (Clear CMOS)

You may clear the CMOS data to its default values by this jumper. To clear CMOS, temporarily shor 1-2 pin. Default doesn't include the "Shunter" to prevent from improper use this jumper.

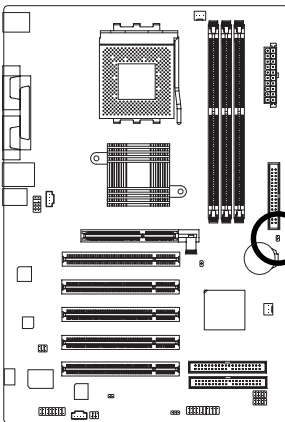

Short: Clear CMOS



Open: Normal

Chapter 3 BIOS Setup

BIOS Setup is an overview of the BIOS Setup Program. The program that allows users to modify the basic system configuration. This type of information is stored in battery-backed CMOS RAM so that it retains the Setup information when the power is turned off.

ENTERING SETUP

After power on the computer, pressing immediately during POST (Power On Self Test) it will allow you to enter standard BIOS CMOS SETUP.

If you require more advanced BIOS settings, please go to "Advanced BIOS" setting menu. To enter Advanced BIOS setting menu, press "Ctrl+F1" key on the BIOS screen.

CONTROL KEYS

<↑>	Move to previous item
<↓>	Move to next item
<←>	Move to the item in the left hand
<→>	Move to the item in the right hand
Enter	Select item
<Esc>	Main Menu - Quit and not save changes into CMOS Status Page Setup Menu and Option Page Setup Menu - Exit current page and return to Main Menu
<+/PgUp>	Increase the numeric value or make changes
<-/PgDn>	Decrease the numeric value or make changes
<F1>	General help, only for Status Page Setup Menu and Option Page Setup Menu
<F2>	Item help
<F3>	Reserved
<F4>	Reserved
<F5>	Restore the previous CMOS value from CMOS, only for Option Page Setup Menu
<F6>	Load the default CMOS value from BIOS default table, only for Option Page Setup Menu
<F7>	Load the Setup Defaults
<F8>	Q-Flash
<F9>	System Information
<F10>	Save all the CMOS changes, only for Main Menu

GETTINGHELP

Main Menu

The on-line description of the highlighted setup function is displayed at the bottom of the screen.

Status Page Setup Menu / Option Page Setup Menu

Press F1 to pop up a small help window that describes the appropriate keys to use and the possible selections for the highlighted item. To exit the Help Window press <Esc>.

The Main Menu (For example: BIOS Ver. : F4c)

Once you enter Award BIOS CMOS Setup Utility, the Main Menu (Figure 1) will appear on the screen. The Main Menu allows you to select from eight setup functions and two exit choices. Use arrow keys to select among the items and press <Enter> to accept or enter the sub-menu.

CMOS Setup Utility-Copyright (C) 1984-2003 Award Software

▶ Standard CMOS Features	Load Fail-Safe Defaults
▶ Advanced BIOS Features	Load Optimized Defaults
▶ Integrated Peripherals	Set Supervisor Password
▶ Power Management Setup	Set User Password
▶ PnP/PCI Configurations	Save & Exit Setup
▶ PC Health Status	Exit Without Saving
▶ Frequency/Voltage Control	
ESC: Quit	↑↓→←: Select Item
F8: Q-Flash	F10: Save & Exit Setup
Time, Date, Hard Disk Type...	

Figure 1: Main Menu



If you can't find the setting you want, please press "Ctrl+F1" to search the advanced option widden.

- **Standard CMOS Features**

This setup page includes all the items in standard compatible BIOS.

- **Advanced BIOS Features**

This setup page includes all the items of Award special enhanced features.

- **Integrated Peripherals**
This setup page includes all onboard peripherals.
- **Power Management Setup**
This setup page includes all the items of Green function features.
- **PnP/PCI Configurations**
This setup page includes all the configurations of PCI & PnP ISA resources.
- **PC Health Status**
This setup page is the System auto detect Temperature, voltage, fan, speed.
- **Frequency/Voltage Control**
This setup page is control CPU's clock and frequency ratio.
- **Load Fail-Safe Defaults**
Fail-Safe Defaults indicates the value of the system parameters which the system would be in safe configuration.
- **Load Optimized Defaults**
Optimized Defaults indicates the value of the system parameters which the system would be in better performance configuration.
- **Set Supervisor password**
Change, set, or disable password. It allows you to limit access to the system and Setup, or just to Setup.
- **Set User password**
Change, set, or disable password. It allows you to limit access to the system.
- **Save & Exit Setup**
Save CMOS value settings to CMOS and exit setup.
- **Exit Without Saving**
Abandon all CMOS value changes and exit setup.

Standard CMOS Features

CMOS Setup Utility-Copyright (C) 1984-2003 Award Software

Standard CMOS Features

Date (mm:dd:yy)	Fri, Dec 26 2003	Item Help
Time (hh:mm:ss)	22:31:24	Menu Level ►
►IDE Primary Master	[None]	Change the day, month, year
►IDE Primary Slave	[None]	<Week>
►IDE Secondary Master	[None]	Sun. to Sat.
►IDE Secondary Slave	[None]	<Month>
Drive A	[1.44M, 3.5"]	Jan. to Dec.
Drive B	[None]	<Day>
Floppy 3 Mode Support	[Disabled]	1 to 31(or maximum allowed in the month.)
Halt On	[All, But Keyboard]	<year>
Base Memory	640K	1999 to 2098
Extended Memory	127M	
Total Memory	128M	
↑↓ → ←: Move Enter:Select +/-/PU/PD:Value F10:Save ESC:Exit F1:General Help F5:Previous Values F6:Fail-Safe Defaults F7:Optimized Defaults		

Figure 2: Standard CMOS Features

☞ Date

The date format is <week>, <month>, <day>, <year>.

- Week The week, from Sun to Sat, determined by the BIOS and is display only
- Month The month, Jan. Through Dec.
- Day The day, from 1 to 31 (or the maximum allowed in the month)
- Year The year, from 1999 through 2098

☞ Time

The times format is <hour> <minute> <second>. The time is calculated base on the 24-hour military-time clock. For example, 1 p.m. is 13:00:00.

☛ IDE Primary Master, Slave / Secondary Master, Slave

The category identifies the types of hard disk from drive C to F that has been installed in the computer. There are two types: auto type, and manual type. Manual type is user-definable; Auto type which will automatically detect HDD type.

Note that the specifications of your drive must match with the drive table. The hard disk will not work properly if you enter improper information for this category.

If you select User Type, related information will be asked to enter to the following items. Enter the information directly from the keyboard and press <Enter>. Such information should be provided in the documentation form your hard disk vendor or the system manufacturer.

- ▶▶ Capacity: The hard disk size. The unit is Mega Bytes.
- ▶▶ Access Mode: The options are: Auto / Large / LBA / Normal.
- ▶▶ Cylinder: The cylinder number of hard disk.
- ▶▶ Head: The read / Write head number of hard disk.
- ▶▶ Precomp: The cylinder number at which the disk driver changes the write current.
- ▶▶ Landing Zone: The cylinder number that the disk driver heads(read/write) are seated when the disk drive is parked.
- ▶▶ SECTORS: The sector number of each track define on the hard disk.

If a hard disk has not been installed select NONE and press <Enter>.

☛ Drive A / Drive B

The category identifies the types of floppy disk drive A or drive B that has been installed in the computer.

- ▶▶ None: No floppy drive installed
- ▶▶ 360K, 5.25": 5.25 inch PC-type standard drive; 360K byte capacity.
- ▶▶ 1.2M, 5.25": 5.25 inch AT-type high-density drive; 1.2M byte capacity (3.5 inch when 3 Mode is Enabled).
- ▶▶ 720K, 3.5": 3.5 inch double-sided drive; 720K byte capacity
- ▶▶ 1.44M, 3.5": 3.5 inch double-sided drive; 1.44M byte capacity.
- ▶▶ 2.88M, 3.5": 3.5 inch double-sided drive; 2.88M byte capacity.

☛ Floppy 3 Mode Support (for Japan Area)

- ▶▶ Disabled: Normal Floppy Drive. (Default value)
- ▶▶ Drive A: Enabled 3 mode function of Drive A.
- ▶▶ Drive B: Enabled 3 mode function of Drive B.
- ▶▶ Both: Drive A & B are 3 mode Floppy Drives.

☛ Halt on

The category determines whether the computer will stop if an error is detected during power up.

- ▶▶ NO Errors The system boot will not stop for any error that may be detected and you will be prompted.
- ▶▶ All Errors Whenever the BIOS detects a non-fatal error the system will be stopped.
- ▶▶ All, But Keyboard The system boot will not stop for a keyboard error; it will stop for all other errors. (Default value)
- ▶▶ All, But Diskette The system boot will not stop for a disk error; it will stop for all other errors.
- ▶▶ All, But Disk/Key The system boot will not stop for a keyboard or disk error; it will stop for all other errors.

Memory

The category is display-only which is determined by POST (Power On Self Test) of the BIOS.

Base Memory

The POST of the BIOS will determine the amount of base (or conventional) memory installed in the system.

The value of the base memory is typically 512 K for systems with 512 K memory installed on the motherboard, or 640 K for systems with 640 K or more memory installed on the motherboard.

Extended Memory

The BIOS determines how much extended memory is present during the POST.

This is the amount of memory located above 1 MB in the CPU's memory address map.

Advanced BIOS Features

CMOS Setup Utility-Copyright (C) 1984-2003 Award Software

Advanced BIOS Features

First Boot Device	[Floppy]	Item Help
Second Boot Device	[HDD-0]	Menu Level▶
Third Boot Device	[CDROM]	
Password Check	[Setup]	
↑↓ → ← : Move Enter:Select +/-/PU/PD:Value F10:Save ESC:Exit F1:General Help F5:Previous Values F6:Fail-Safe Defaults F7:Optimized Defaults		

Figure 3: Advanced BIOS Features

☛ First / Second / Third Boot device

☛ This feature allows you to select the boot device priority.

- ▶▶ Floppy Select your boot device priority by Floppy.
- ▶▶ LS120 Select your boot device priority by LS120.
- ▶▶ HDD-0-3 Select your boot device priority by HDD-0-3.
- ▶▶ SCSI Select your boot device priority by SCSI.
- ▶▶ CDROM Select your boot device priority by CDROM.
- ▶▶ LAN Select your boot device priority by LAN.
- ▶▶ USB-CDROM Select your boot device priority by USB-CDROM.
- ▶▶ USB-ZIP Select your boot device priority by USB-ZIP.
- ▶▶ USB-FDD Select your boot device priority by USB-FDD.
- ▶▶ USB-HDD Select your boot device priority by USB-HDD.
- ▶▶ ZIP Select your boot device priority by ZIP.
- ▶▶ Disabled Disabled this function.

🔑 Password Check

- ▶▶ System The system can not boot and can not access to Setup page will be denied if the correct password is not entered at the prompt.
- ▶▶ Setup The system will boot, but access to Setup will be denied if the correct password is not entered at the prompt. (Default value)

Integrated Peripherals

CMOS Setup Utility-Copyright (C) 1984-2003 Award Software

Integrated Peripherals

OnChip IDE Channel0	[Enabled]	Item Help
OnChip IDE Channel1	[Enabled]	Menu Level ►
AC97 Audio	[Auto]	
VIA Onboard LAN *	[Enabled]	
USB 1.1 Controller	[Enabled]	
USB 2.0 Controller	[Enabled]	
USB Keyboard Support	[Disabled]	
USB Mouse Support	[Disabled]	
VIA LAN Boot ROM *	[Disabled]	
Onboard Serial Port 1	[3F8/IRQ4]	
Onboard Serial Port 2	[2F8/IRQ3]	
Onboard Parallel Port	[378/IRQ7]	
UART Mode Select	[Normal]	
Parallel Port Mode	[SPP]	
Game Port Address	[201]	
Midi Port Address	[330]	
Midi Port IRQ	10	
↑↓→←: Move Enter:Select +/-/PU/PD: Value F10: Save ESC:Exit F1: General Help F5: Previous Values F6: Fail-Safe Defaults F7: Optimized Defaults		

Figure 4: Integrated Peripherals

* * * For GA-7VT600-L only.

☛ OnChip IDE Channel0

☛ When enabled, allows you to use the onboard primary PCI IDE. If a hard disk controller card is used, set at Disabled.

- ▶▶ Enabled Enable onboard 1st channel IDE port. (Default value)
- ▶▶ Disabled Disable onboard 1st channel IDE port.

☛ OnChip IDE Channel1

☛ When enabled, allows you to use the onboard secondary PCI IDE. If a hard disk controller card is used, set at Disabled.

- ▶▶ Enabled Enable onboard 2nd channel IDE port. (Default value)
- ▶▶ Disabled Disable onboard 2nd channel IDE port.

☛ AC97 Audio

- ▶▶ Enabled BIOS will automatically detect onboard AC97 Audio. (Default value)
- ▶▶ Disabled Disabled AC97 Audio.

☛ VIA Onboard LAN*

- ▶▶ Enabled Enable VIA Onboard LAN function. (Default value)
- ▶▶ Disabled Disable this function.

☛ USB 1.1 Controller

☛ Disable this option if you are not using the onboard USB feature.

- ▶▶ Enabled Enabled USB Controller. (Default value)
- ▶▶ Disabled Disabled USB Controller.

☛ USB 2.0 Controller

☛ Disable this option if you are not using the onboard USB 2.0 feature.

- ▶▶ Enabled Enabled USB 2.0 Controller. (Default value)
- ▶▶ Disabled Disabled USB 2.0 Controller.

☛ USB Keyboard Support

☛ When a USB keyboard is installed, please set at Enabled.

- ▶▶ Enabled Enabled USB Keyboard Support.
- ▶▶ Disabled Disabled USB Keyboard Support. (Default value)

" * " For GA-7VT600-L only.

☛ USB Mouse Support

- ▶▶ Enabled Enabled USB Mouse Support.
- ▶▶ Disabled Disabled USB Mouse Support. (Default value)

☛ VIA LAN Boot ROM *

This function decide whether to invoke the boot ROM of the onboard LAN chip.

- ▶▶ Disabled Disable this function. (Default Value)
- ▶▶ Enabled Enable this function.

☛ Onboard Serial Port 1

- ▶▶ Auto BIOS will automatically setup the port 1 address.
- ▶▶ 3F8/IRQ4 Enable onboard Serial port 1 and address is 3F8,Using IRQ4. (Default value)
- ▶▶ 2F8/IRQ3 Enable onboard Serial port 1 and address is 2F8,Using IRQ3.
- ▶▶ 3E8/IRQ4 Enable onboard Serial port 1 and address is 3E8,Using IRQ4.
- ▶▶ 2E8/IRQ3 Enable onboard Serial port 1 and address is 2E8,Using IRQ3.
- ▶▶ Disabled Disable onboard Serial port 1.

☛ Onboard Serial Port 2

- ▶▶ Auto BIOS will automatically setup the port 2 address.
- ▶▶ 3F8/IRQ4 Enable onboard Serial port 2 and address is 3F8,Using IRQ4.
- ▶▶ 2F8/IRQ3 Enable onboard Serial port 2 and address is 2F8,Using IRQ3. (Default Value)
- ▶▶ 3E8/IRQ4 Enable onboard Serial port 2 and address is 3E8,Using IRQ4.
- ▶▶ 2E8/IRQ3 Enable onboard Serial port 2 and address is 2E8,Using IRQ3.
- ▶▶ Disabled Disable onboard Serial port 2.

☛ OnBoard Parallel port

🔗 This feature allows you to select from a given set of parameters if the parallel port uses the onboard I/O controller.

- ▶▶ 378/IRQ7 Enable onboard LPT port and address is 378, Using IRQ7.(Default Value)
- ▶▶ 278/IRQ5 Enable onboard LPT port and address is 278,Using IRQ5.
- ▶▶ 3BC/IRQ7 Enable onboard LPT port and address is 3BC,Using IRQ7.
- ▶▶ Disabled Disable onboard parallel port.

" * " For GA-7VT600-L only.

🔑 UART Mode Select

This item allows you to determine which Infra Red(IR) function of Onboard I/O chip.

- ▶▶ Normal Set onboard I/O chip UART to Normal Mode. (Default Value)
- ▶▶ IrDA Set onboard I/O chip UART to IrDA Mode.
- ▶▶ ASKIR Set onboard I/O chip UART to ASKIR Mode.
- ▶▶ SCR Set onboard I/O chip as Smart Card interface.

🔑 Parallel Port Mode

🔑 This feature allows you to connect with an advanced print via the port mode it supports.

- ▶▶ SPP Using Parallel port as Standard Parallel Port using IRQ7. (Default Value)
- ▶▶ EPP Using Parallel port as Enhanced Parallel Port IRQ5.
- ▶▶ ECP Using Parallel port as Extended Capabilities Port using IRQ7.
- ▶▶ ECP+EPP Using Parallel port as ECP & EPP mode.

🔑 Game Port Address

- ▶▶ Disabled Disabled this function.
- ▶▶ 201 Set Game Port Address to 201. (Default Value)
- ▶▶ 209 Set Game Port Address to 209.

🔑 Midi Port Address

- ▶▶ Disabled Disabled this function. (Default Value)
- ▶▶ 300 Set Midi Port Address to 300.
- ▶▶ 330 Set Midi Port Address to 330.

🔑 Midi Port IRQ

- ▶▶ 5 Set 5 for Midi Port IRQ.
- ▶▶ 10 Set 10 for Midi Port IRQ.(Default value)

Power Management Setup

CMOS Setup Utility-Copyright (C) 1984-2003 Award Software

Power Management Setup

		Item Help
ACPI Suspend Type	[S1(POS)]	Menu Level ►
x USB Device Wake-Up From S3	Disabled	[S1]
Power LED in S1 state	[Blinking]	Set suspend type to
Soft-Off by PWRBTN	[Instant-off]	Power On Suspend under
AC Back Function	[Soft-Off]	ACPI OS
Keyboard Power On	[Disabled]	
Mouse Power On	[Disabled]	[S3]
PME Event Wake Up	[Enabled]	Set suspend type to
ModemRingOn/WakeOnLAN	[Enabled]	Suspend to RAM under
Resume by Alarm	[Disabled]	ACPI OS
x Date (of Month) Alarm	Everyday	
x Time (hh:mm:ss) Alarm	0 : 0 : 0	
↑↓→←: Move Enter:Select +/-/PU/PD:Value F10:Save ESC:Exit F1:General Help F5:Previous Values F6:Fail-Safe Defaults F7:Optimized Defaults		

Figure 5: Power Management Setup

☛ ACPI Suspend Type

- ▶▶ S1(POS) Set suspend type to Power On Suspend under ACPI OS(Power On Suspend). (Default value)
- ▶▶ S3(STR) Set suspend type to Suspend To RAM under ACPI OS (Suspend To RAM).

☛ USB Device Wakeup From S3(When ACPI Suspend Type is set [S3(STR)])

USB device wakeup From S3 can be set when ACPI standby state set to S3/STR.

- ▶▶ Enabled USB Device can wakeup system from S3.
- ▶▶ Disabled USB Device can't wakeup system from S3. (Default value)

☛ **Power LED in S1 state**

- ▶▶ Blinking In standby mode(S1), power LED will blink. (Default value)
- ▶▶ Dual/Off In standby mode(S1):
 - a. If use single color LED, power LED will turn off.
 - b. If use dual color LED, power LED will turn to another color.

☛ **Soft-off by PWRBTN**

- ▶▶ Instant-off Press power button then Power off instantly. (Default value)
- ▶▶ Delay 4 Sec. Press power button 4 sec to Power off. Enter suspend if button is pressed less than 4 sec.

☛ **AC Back Function**

- ▶▶ Memory System power on depends on the status before AC lost.
- ▶▶ Soft-Off Always in Off state when AC back. (Default value)
- ▶▶ Full-On Always power on the system when AC back.

☛ **Keyboard Power On**

This feature allows you to set the method for powering-on the system.

The option "Password" allows you to set up to 8 alphanumeric characters to power-on the system.

The option "Keyboard 98" allows you to use the standard keyboard 98 to power on the system.

- ▶▶ Password Enter from 1 to 8 characters to set the Keyboard Power On Password.
- ▶▶ Disabled Disabled this function. (Default value)
- ▶▶ Keyboard 98 If your keyboard have "POWER Key" button, you can press the key to power on your system.

☛ **Mouse Power On**

- ▶▶ Disabled Can't Power on system by Mouse Event. (Default value)
- ▶▶ Enabled Can Power on system by Mouse Event.

☛ **PME Event Wake up**

When set at Enabled, any PCI-PM event awakes the system from a PCI-PM controlled state.

This feature requires an ATX power supply that provides at least 1A on the +5VSB lead.

- ▶▶ Disabled Disabled PME Event Wake up function.
- ▶▶ Enabled Enabled PME Event Wake up function. (Default Value)

☛ **ModemRingOn/WakeOnLAN (When AC Back Function set to [Soft-Off])**

You can enable wake on LAN feature by the "ModemRingOn/WakeOnLAN" or "PME Event Wake up" when the M/B has "WOL" onboard connector. Only enabled the feature by "PME Event Wake up".

An incoming call via modem awakes the system from its soft-off mode. When set at Enabled, an input signal comes from the other client.

Server on the LAN awakes the system from a soft off state if connected over LAN.

- ▶▶ Disabled Disabled Modem Ring On / Wake On LAN function.
- ▶▶ Enabled Enabled Modem Ring On / Wake On LAN function. (Default Value)

☛ **Resume by Alarm**

You can set "Resume by Alarm" item to enabled and key in Data/time to power on system.

- ▶▶ Disabled Disable this function. (Default Value)
- ▶▶ Enabled Enable alarm function to POWER ON system.

If RTC Alarm Lead To Power On is Enabled.

Date (of Month) Alarm : Everyday, 1-31

Time (hh: mm: ss) Alarm : (0-23) : (0-59) : (0-59)

PnP/PCI Configurations

CMOS Setup Utility-Copyright (C) 1984-2003 Award Software

PnP/PCI Configurations

PCI1/PCI5 IRQ Assignment	[Auto]	Item Help
PCI2 IRQ Assignment	[Auto]	Menu Level▶
PCI3 IRQ Assignment	[Auto]	
PCI4 IRQ Assignment	[Auto]	
↑↓ → ← : Move Enter:Select +/-/PU/PD:Value F10:Save ESC:Exit F1:General Help F5:Previous Values F6:Fail-Safe Defaults F7:Optimized Defaults		

Figure 6: PnP/PCI Configurations

☛ PCI1/PCI5 IRQ Assignment

- ▶▶ Auto Auto assign IRQ to PCI 1/ PCI 5. (Default value)
- ▶▶ 3,4,5,7,9.,10,11,12,14,15 Set 3,4,5,7,9,10,11,12,14,15 to PCI1/ PCI5.

☛ PCI2 IRQ Assignment

- ▶▶ Auto Auto assign IRQ to PCI 2. (Default value)
- ▶▶ 3,4,5,7,9.,10,11,12,14,15 Set 3,4,5,7,9,10,11,12,14,15 to PCI2.

☛ PCI3 IRQ Assignment

- ▶▶ Auto Auto assign IRQ to PCI 3. (Default value)
- ▶▶ 3,4,5,7,9.,10,11,12,14,15 Set 3,4,5,7,9,10,11,12,14,15 to PCI3.

☛ PCI4 IRQ Assignment

- ▶▶ Auto Auto assign IRQ to PCI 4. (Default value)
- ▶▶ 3,4,5,7,9.,10,11,12,14,15 Set 3,4,5,7,9,10,11,12,14,15 to PCI4.

PC Health Status

CMOS Setup Utility-Copyright (C) 1984-2003 Award Software

PC Health Status

Reset Case Open Status	[Disabled]	Item Help
Case Opened	No	Menu Level ►
Vcore	1.810V	[Disabled]
DDR Vtt	1.248V	Don't reset case
+3.3V	3.280V	open status
+5V	4.919V	
+12V	11.968V	[Enabled]
5VSB	5.053V	Clear case open
Current System Temperature	27°C	status at next boot
Current CPU Temperature	37°C	
Current CPU FAN Speed	4687 RPM	
Current SYSTEM FAN Speed	0 RPM	
CPU FAN Fail Warning	[Disabled]	
SYSTEM FAN Fail Warning	[Disabled]	
↑↓→←: Move Enter:Select +/-/PU/PD:Value F10:Save ESC:Exit F1:General Help F5:Previous Values F6:Fail-Safe Defaults F7:Optimized Defaults		

Figure7: PC Health Status

☞ Reset Case Open Status

☞ Case Opened

If the case is closed, "Case Opened" will show "No".

If the case have been opened, "Case Opened" will show "Yes".

If you want to reset "Case Opened" value, set "Reset Case Open Status" to "Enabled" and save CMOS, your computer will restart.

☛ **Current Voltage (V) Vcore / DDR Vtt / +3.3V / +5V / +12V / 5VSB**

Detect system's voltage status automatically.

☛ **Current System Temperature (°C)**

Detect System Temp. automatically.

☛ **Current CPU Temperature (°C)**

Detect CPU Temp. automatically.

☛ **Current CPU FAN / SYSTEM FAN Speed (RPM)**

Detect Fan speed status automatically.

☛ **Fan Fail Warning (CPU / SYSTEM)**

- ▶▶ Disabled Don't monitor current fan speed. (Default value)
- ▶▶ Enabled Alarm when stops.

Frequency/Voltage Control

CMOS Setup Utility-Copyright (C) 1984-2003 Award Software

Frequency/Voltage Control

Spread Spectrum Modulated	[Enabled]	Item Help
CPU Host Clock Control	[Disable]	Menu Level▶
※CPU Host Frequency(MHz)	133	
※PCI/AGP Frequency(MHz)	33/66	
DRAM Clock(MHz)	[Auto]	
CPU OverVoltage Control	[Auto]	
AGP OverVoltage Control	[Auto]	
DIMM OverVoltage Control	[Auto]	
↑↓→←: Move Enter:Select +/-/PU/PD:Value F10:Save ESC:Exit F1:General Help F5:Previous Values F6:Fail-Safe Defaults F7:Optimized Defaults		

Figure 8: Frequency/Voltage Control

※Those items will be available when "CPU Host Clock Control" is set to Enabled.

☛ Spread Spectrum Modulated

- ▶▶ Disabled Disable clock spread spectrum.
- ▶▶ Enabled Enable clock spread spectrum.(Default value)

☛ CPU Host Clock Control

Note: If system hangs up before enter CMOS setup utility, wait for 20 sec for times out reboot . When time out occur, system will reset and run at CPU default Host clock at next boot.

- ▶▶ Disable Disable CPU Host Clock Control.(Default value)
- ▶▶ Enable Enable CPU Host Clock Control.

☛ CPU Host Frequency (MHz) (By switch SW1)

- ▶▶ 100 Set CPU Host Clock to 100MHz~132MHz.
- ▶▶ 133 Set CPU Host Clock to 133MHz~165MHz.
- ▶▶ 166 Set CPU Host Clock to 166MHz~200MHz.
- ▶▶ 200 Set CPU Host Clock to 200MHz~254MHz.

⚙️ **PCI/AGP Frequency (MHz)**

- ▶▶ The values depend on CPU Host Frequency(Mhz) .

⚙️ **DRAM Clock (MHz)**

- ▶▶ Please set DRAM Clock according to your requirement. (Default value: Auto)

If you use DDR266 DRAM module, please set "DRAM Clock(MHz)" to "133-DDR266". If you use DDR333 DRAM module, please set "DRAM Clock(MHz)" to "166-DDR333". If you use DDR400 DRAM module, please set "DRAM Clock(MHz)" to "200-DDR400".

Incorrect using it may cause your system broken. For power End-User use only!

⚙️ **CPU OverVoltage Control**

Increase CPU voltage may get stable for Over_Clock. But it may damage to CPU when enable this feature.

- ▶▶ Auto Supply voltage as CPU required. (Default value)
- ▶▶ +5% / +7.5% / +10% Increase voltage range as user selected.

⚙️ **AGP OverVoltage Control**

Increase AGP voltage may get stable for Over_Clock. But it may damage to AGP Card when enable this feature.

- ▶▶ Auto Supply voltage as AGP Card required. (Default value)
- ▶▶ +0.1V ~ +0.3V Set AGP voltage from 1.6V~1.8V.

⚙️ **DIMM OverVoltage Control**

Increase DRAM voltage may get stable for Over_Clock. But it may damage to DRAM module when enable this feature.

- ▶▶ Auto Supply voltage as DRAM module required. (Default value)
- ▶▶ +0.1V ~ +0.3V Set DIMM voltage from 2.6V~2.8V.

Load Fail-Safe Defaults

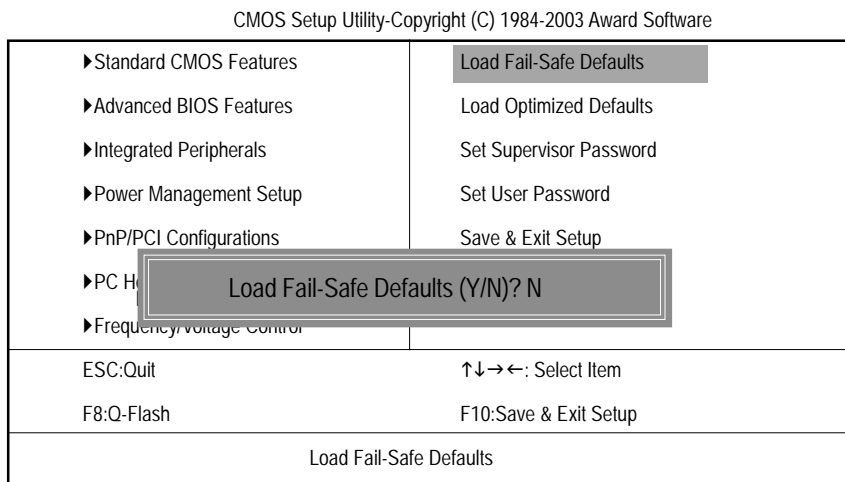

Figure 9: Load Fail-Safe Defaults

☛ Load Fail-Safe Defaults

Fail-Safe defaults contain the most appropriate values of the system parameters that allow minimum system performance.

Load Optimized Defaults

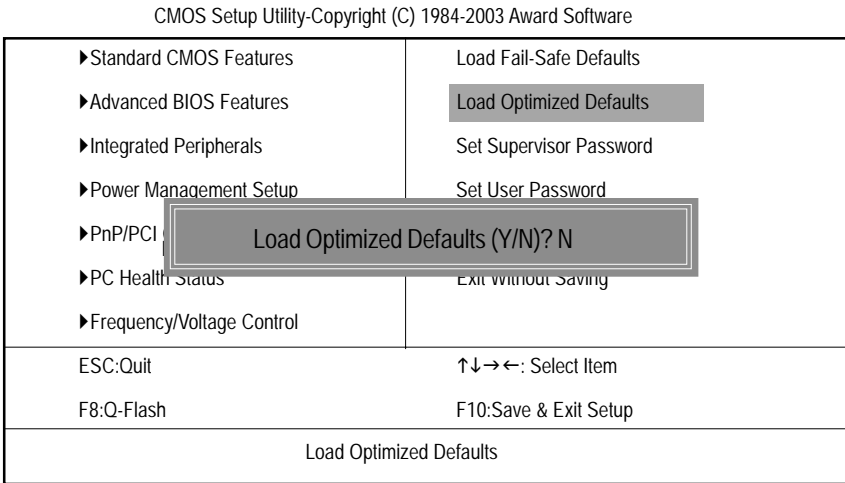

Figure 10: Load Optimized Defaults

☛ Load Optimized Defaults

Selecting this field loads the factory defaults for BIOS and Chipset Features which the system automatically detects.

Set Supervisor/User Password

CMOS Setup Utility-Copyright (C) 1984-2003 Award Software

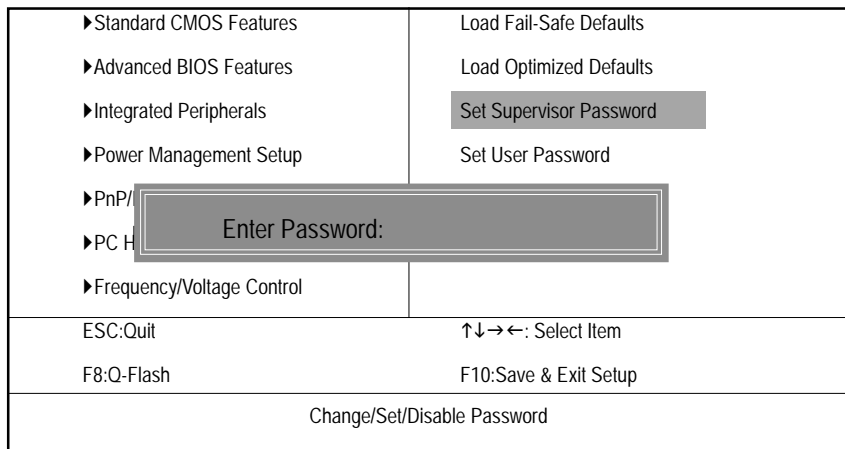

Figure 11: Password Setting

When you select this function, the following message will appear at the center of the screen to assist you in creating a password.

Type the password, up to eight characters, and press <Enter>. You will be asked to confirm the password. Type the password again and press <Enter>. You may also press <Esc> to abort the selection and not enter a password.

To disable password, just press <Enter> when you are prompted to enter password. A message "PASSWORD DISABLED" will appear to confirm the password being disabled. Once the password is disabled, the system will boot and you can enter Setup freely.

The BIOS Setup program allows you to specify two separate passwords: a SUPERVISOR PASSWORD and a USER PASSWORD. When disabled, anyone may access all BIOS Setup program function. When enabled, the Supervisor password is required for entering the BIOS Setup program and having full configuration fields, the User password is required to access only basic items.

If you select "System" at "password check" in Advance BIOS Features Menu, you will be prompted for the password every time the system is rebooted or any time you try to enter Setup Menu.

If you select "Setup" at "password check" in Advance BIOS Features Menu, you will be prompted only when you try to enter Setup.

Save & Exit Setup

CMOS Setup Utility-Copyright (C) 1984-2003 Award Software

▶Standard CMOS Features	Load Fail-Safe Defaults
▶Advanced BIOS Features	Load Optimized Defaults
▶Integrated Peripherals	Set Supervisor Password
▶Power Management Setup	Set User Password
▶PnP	
▶PC	
▶Frequency/Voltage Control	
Save to CMOS and EXIT (Y/N)? Y	
ESC:Quit	↑↓→←: Select Item
F8:Q-Flash	F10:Save & Exit Setup
Save Data to CMOS	

Figure 12: Save & Exit Setup

Type "Y" will quit the Setup Utility and save the user setup value to RTC CMOS.

Type "N" will return to Setup Utility.

Exit Without Saving

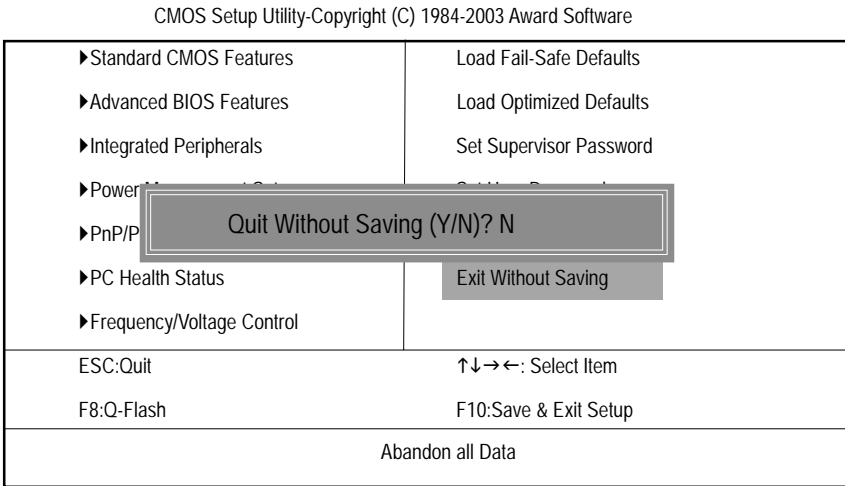

Figure 13: Exit Without Saving

Type "Y" will quit the Setup Utility without saving to RTC CMOS.

Type "N" will return to Setup Utility.

Chapter 4 Technical Reference

@BIOS™ Introduction

Gigabyte announces @BIOS™

Windows BIOS live update utility



Have you ever updated BIOS by yourself? Or like many other people, you just know what BIOS is, but always hesitate to update it? Because you think updating newest BIOS is unnecessary and actually you don't know how to update it.

Maybe not like others, you are very experienced in BIOS updating and spend quite a lot of time to do it. But of course you don't like to do it too much. First, download different BIOS from website and then switch the operating system to DOS mode. Secondly, use different flash utility to update BIOS. The above process is not a interesting job. Besides, always be carefully to store the BIOS source code correctly in your disks as if you update the wrong BIOS, it will be a nightmare.

Certainly, you wonder why motherboard vendors could not just do something right to save your time and effort and save you from the lousy BIOS updating work? Here it comes! Now Gigabyte announces @BIOS - the first Windows BIOS live update utility. This is a smart BIOS update software. It could help you to download the BIOS from internet and update it. Not like the other BIOS update software, it's a Windows utility. With the help of "@BIOS", BIOS updating is no more than a click.

Besides, no matter which mainboard you are using, if it's a Gigabyte's product, @BIOS help you to maintain the BIOS. This utility could detect your correct mainboard model and help you to choose the BIOS accordingly. It then downloads the BIOS from the nearest Gigabyte ftp site automatically. There are several different choices; you could use "Internet Update" to download and update your BIOS directly. Or you may want to keep a backup for your current BIOS, just choose "Save Current BIOS" to save it first. You make a wise choice to use Gigabyte, and @BIOS update your BIOS smartly. You are now worry free from updating wrong BIOS, and capable to maintain and manage your BIOS easily. Again, Gigabyte's innovative product erects a milestone in mainboard industries.

For such a wonderful software, how much it costs? Impossible! It's free! Now, if you buy a Gigabyte's motherboard, you could find this amazing software in the attached driver CD. But please remember, connected to internet at first, then you could have a internet BIOS update from your Gigabyte @BIOS.

EasyTune™ 4 Introduction

Gigabyte announces EasyTune™ 4

Windows based Overclocking utility

EasyTune 4 carries on the heritage so as to pave the way for future generations.



Overclock might be one of the most common issues in computer field. But have many users ever tried it? The answer is probably "no". Because "Overclock" is thought to be very difficult and includes a lot of technical know-how, sometimes "Overclock" is even considered as special skills found only in some enthusiasts. But as to the experts in "Overclock", what's the truth? They may spend quite a lot of time and money to study, try and use many different

hardware or BIOS tools to do "Overclock". And even with these technologies, they still learn that it's quite a risk because the safety and stability of an "Overclock" system is unknown. Now everything is different because of a Windows based overclocking utility "EasyTune 4" --announced by Gigabyte. This windows based utility has totally changed the gaming rule of "Overclock". This is the first windows based overclocking utility is suitable for both normal and power users. Users can choose either "Easy Mode" or "Advanced Mode" for overclocking at their convenience. For users who choose "Easy Mode", they just need to click "Auto Optimize" to have autoed and immediate CPU overclocking. This software will then overdrive CPU speed automatically with the result being shown in the control panel. If users prefer "Overclock" by them, there is also another choice. Click "Advanced Mode" to enjoy "sport drive" class Overclocking user interface. "Advanced Mode", allows users to change the system bus / AGP / Memory working frequency in small increments to get ultimate system performance. It operates in coordination with Gigabyte motherboards. Besides, it is different from other traditional over-clocking methods, EasyTune 4 doesn't require users to change neither BIOS nor hardware switch/ jumper setting; on the other hand, they can do "Overclock" at easy step. Therefore, this is a safer way for "Overclock" as nothing is changed on software or hardware. If user runs EasyTune 4 over system's limitation, the biggest lost is only to restart the computer again and the side effect is then well controlled. Moreover, if one well-performed system speed has been tested in EasyTune 4, user can "Save" this setting and "Load" it in next time. Obviously, Gigabyte EasyTune 4 has already turned the "Overclock" technology toward to a newer generation. This wonderful software is now free bundled in Gigabyte motherboard attached in driver CD. Users may make a test drive of "EasyTune 4" to find out more amazing features by themselves.

*Some Gigabyte products are not fully supported by EasyTune 4. Please find the products supported list in the web site.

*Any "Overclocking action" is at user's risk, Gigabyte Technology will not be responsible for any damage or instability to your processor, motherboard, or any other components.

Flash BIOS Method Introduction

Method 1 : Q-Flash



Flash BIOS Method Introduction

Q-Flash™ is a BIOS flash utility embedded in Flash ROM. With this utility, users only have to stay in the BIOS menu when they want to update BIOS. Q-Flash™ allows users to flash BIOS without any utility in DOS or Windows. Using Q-Flash™ indicating no more fooling around with any complicated instructions and operating system since it is in the BIOS menu.



Please note that because updating BIOS has potential risk, please do it with caution!! We are sorry that Gigabyte Technology Co., Ltd is not responsible for damages of system because of incorrect manipulation of updating BIOS to avoid any claims from end-users.

Before You Begin:

Before you start updating BIOS with the Q-Flash™ utility, please follow the steps below first.

1. Download the latest BIOS for your motherboard from Gigabyte's website.
2. Extract the BIOS file downloaded and save the BIOS file (the one with model name.Fxx. For example, 7VRXP.F12) to a floppy disk.
3. Reboot your PC and press **Del** to enter BIOS menu.

The BIOS upgrading guides below are separated into two parts.

If your motherboard has dual BIOS, please refer to Part One.

If your motherboard has single BIOS, please refer to Part Two.

Part One:

Updating BIOS with Q-Flash™ Utility on Dual BIOS Motherboards.

Some of Gigabyte motherboards are equipped with dual BIOS. In the BIOS menu of the motherboards supporting Q-Flash™ and Dual BIOS, the Q-Flash™ utility and Dual BIOS utility are combined in the same screen. This section only deals with how to use Q-Flash™ utility.

In the following sections, we take GA-7VRXP as the example to guide you how to flash BIOS from an older version to the latest version. For example, from F10 to F12.

The BIOS file is F10 before updating



Entering the Q-Flash™ utility:

Step1: To use Q-Flash™ utility, you must press **Del** in the boot screen to enter BIOS menu.

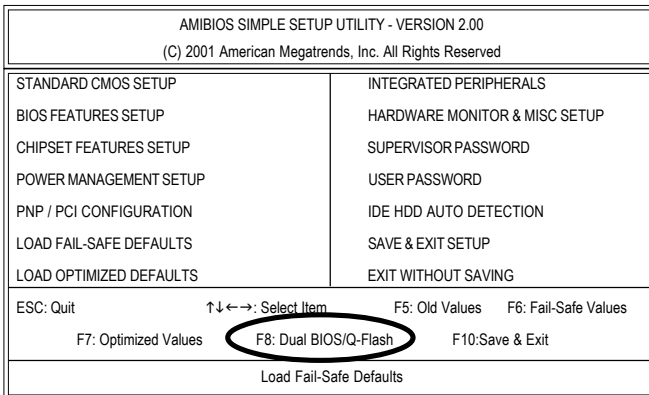

Step 2: Press **F8** button on your keyboard and then **Y** button to enter the Q-Flash™ utility.

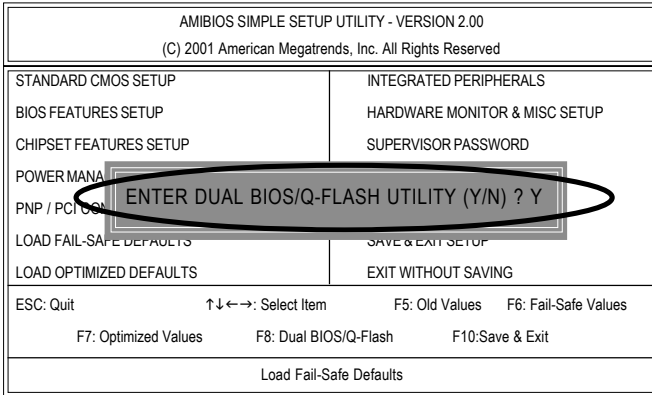

Exploring the Q-Flash™/Dual BIOS utility screen

The Q-Flash™/Dual BIOS utility screen consists of the following key components.

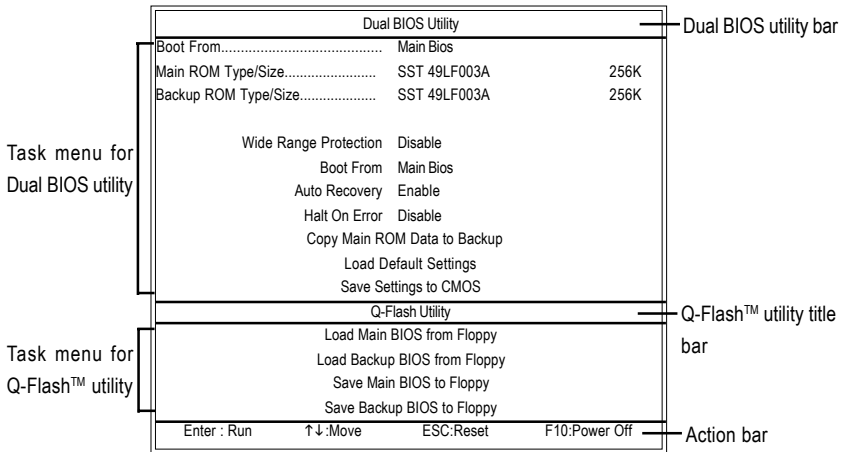

Task menu for Dual BIOS utility:

Contains the names of eight tasks and two item showing information about the BIOS ROM type.

Blocking a task and pressing **Enter** key on your keyboard to enable execution of the task.

Task menu for Q-Flash™ utility:

Contains the names of four tasks. Blocking a task and pressing **Enter** key on your keyboard to enable execution of the task.

Action bar:

Contains the names of four actions needed to operate the Q-Flash™/Dual BIOS utility. Pressing the buttons mentioned on your keyboards to perform these actions.

Using the Q-Flash™ utility:

This section tells you how to update BIOS using the Q-Flash™ utility. As described in the "Before you begin" section above, you must prepare a floppy disk having the BIOS file for your motherboard and insert it to your computer. If you have already put the floppy disk into your system and have entered the Q-Flash™ utility, please follow the steps below to flash BIOS.

Steps:

1. Press arrow buttons on your keyboard to move the light bar to "Load Main BIOS from Floppy" item in the Q-Flash™ menu and press **Enter** button.



If you want to save the current BIOS for backup purpose, you can begin Step 1 with "Save Main BIOS to Floppy" item.

Dual BIOS Utility		
Boot From.....	Main Bios	
Main ROM Type/Size.....	SST 49LF003A	256K
Backup ROM Type/Size.....	SST 49LF003A	256K
Wide Range Protection Disable		
Boot From Main Bios		
Auto Recovery Enable		
Halt On Error Disable		
Copy Main ROM Data to Backup		
Load Default Settings		
Save Settings to CMOS		
Q-Flash Utility		
Load Main BIOS from Floppy		
Load Backup BIOS from Floppy		
Save Main BIOS to Floppy		
Save Backup BIOS to Floppy		
Enter : Run	↑↓:Move	ESC:Reset F10:Power Off

4. Press any keys to return to the Q-Flash™ menu when the BIOS updating procedure is completed.

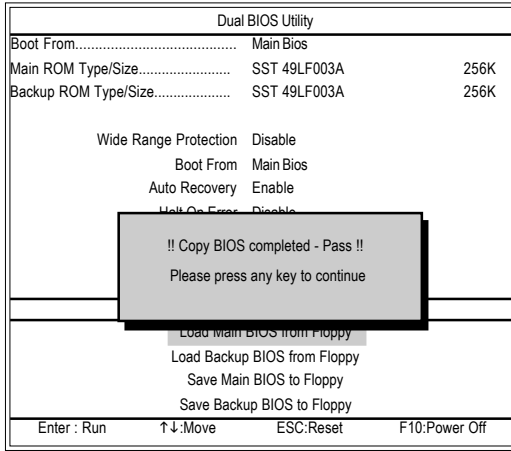

You can repeat Step 1 to 4 to flash the backup BIOS, too.

5. Press **Esc** and then **Y** button to exit the Q-Flash™ utility. The computer will restart automatically after you exit Q-Flash™.

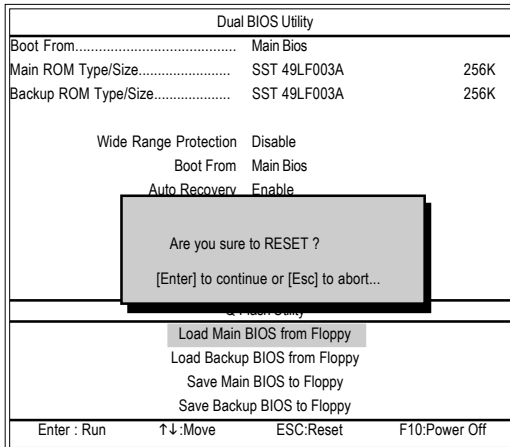

After system reboots, you may find the BIOS version on your boot screen becomes the one you flashed.

The BIOS file becomes F12 after updating

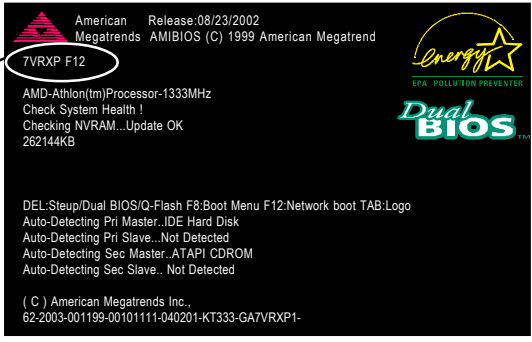

The following is an AMI BIOS menu screen. However, you can also find similar option in AWARD BIOS menu.

- Press **Del** to enter BIOS menu after system reboots. When you are in BIOS menu, move to **Load Fail-Safe Defaults** item and press **Enter** to load BIOS Fail-Safe Defaults. Normally the system redetects all devices after BIOS has been upgraded. Therefore, we highly recommend reloading the BIOS defaults after BIOS has been upgraded.

Press Enter on your keyboard

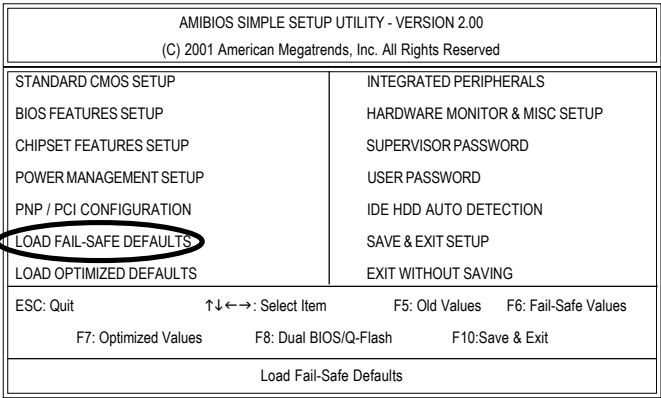

Press Y on your keyboard to load defaults.

AMIBIOS SIMPLE SETUP UTILITY - VERSION 2.00	
(C) 2001 American Megatrends, Inc. All Rights Reserved	
STANDARD CMOS SETUP	INTEGRATED PERIPHERALS
BIOS FEATURES SETUP	HARDWARE MONITOR & MISC SETUP
CHIPSET FEATURES SETUP	SUPERVISOR PASSWORD
POWER MANAGEMENT	
PNP / PCI CONFIGURATION	
Load Fail-Safe Defaults (Y/N)? Y	
LOAD FAIL-SAFE DEFAULTS	SAVE & EXIT SETUP
LOAD OPTIMIZED DEFAULTS	EXIT WITHOUT SAVING
ESC: Quit	↑↓←→: Select Item
F7: Optimized Values	F5: Old Values
F8: Dual BIOS/Q-Flash	F6: Fail-Safe Values
F10: Save & Exit	
Load Fail-Safe Defaults	

7. Select **Save & Exit Setup** item to save the settings to CMOS and exit the BIOS menu. System will reboot after you exit the BIOS menu. The procedure is completed.

Press Y on your keyboard to save and exit.

AMIBIOS SIMPLE SETUP UTILITY - VERSION 2.00	
(C) 2001 American Megatrends, Inc. All Rights Reserved	
STANDARD CMOS SETUP	INTEGRATED PERIPHERALS
BIOS FEATURES SETUP	HARDWARE MONITOR & MISC SETUP
CHIPSET FEATURES SETUP	SUPERVISOR PASSWORD
POWER MANAGEMENT	
PNP / PCI CONFIGURATION	
SAVE to CMOS and EXIT (Y/N) ? Y	
LOAD FAIL-SAFE DEFAULTS	SAVE & EXIT SETUP
LOAD OPTIMIZED DEFAULTS	EXIT WITHOUT SAVING
ESC: Quit	↑↓←→: Select Item
F7: Optimized Values	F5: Old Values
F8: Dual BIOS/Q-Flash	F6: Fail-Safe Values
F10: Save & Exit	
Load Fail-Safe Defaults	

Exploring the Q-Flash™ utility screen

The Q-Flash™ BIOS utility screen consists of the following key components.

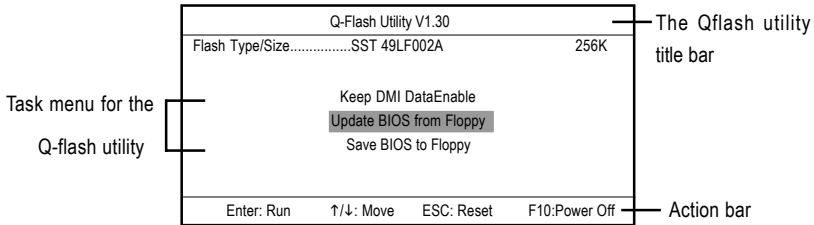

Task menu for the Q-Flash™ utility: Contains the names of three tasks. Blocking a task and pressing **Enter** key on your keyboard to enable execution of the task.

Action bar: Contains the names of four actions needed to operate the Q-Flash™ utility. Pressing the buttons mentioned on your keyboard to perform these actions.

Using the Q-Flash™ utility:

This section tells you how to update BIOS using the Q-Flash™ utility. As described in the "Before you begin" section above, you must prepare a floppy disk having the BIOS file for your motherboard and insert it to your computer. If you have already put the floppy disk into your system and have enter the Q-Flash™ utility, please follow the steps below to flash BIOS.

Steps:

1. Press arrow buttons on your keyboard to move the light bar to "Load Main BIOS from Floppy" item in the Q-Flash™ menu and press **Enter** button.



If you want to save the current BIOS for backup purpose, you can begin Step 1 with **Save Main BIOS to Floppy** item.

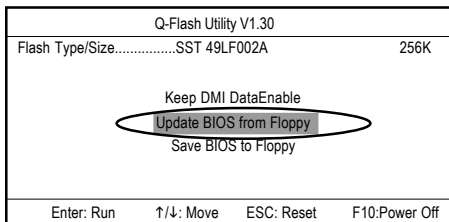

Later, you will see a box showing the BIOS files you downloaded to the floppy disk. In this example, we only download one BIOS for this board, 8GE800.F4 so only one BIOS file is listed.

2.Highlight the BIOS file you want to flash and press **Enter** button on your keyboard to enable reading from the BIOS file from the floppy.



Please confirm again you have the correct BIOS file for your motherboard.

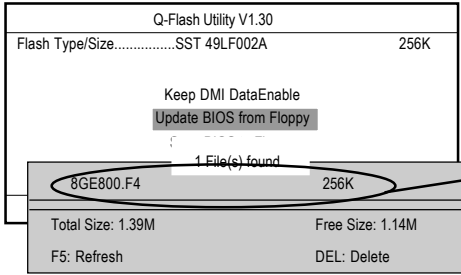

BIOS file in the floppy.

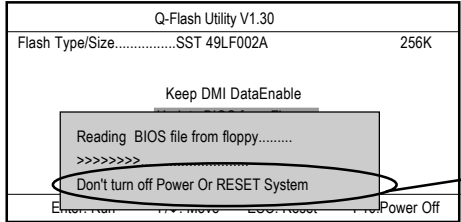

Do not turning power or reset your system at this stage!

After BIOS file is read, you'll see a confirmation dialog box asking you "Are you sure to update BIOS?"

Method 2 : @BIOS Utility

If you don't have DOS boot disk, we recommend that you used Gigabyte @BIOS™ program to flash BIOS.

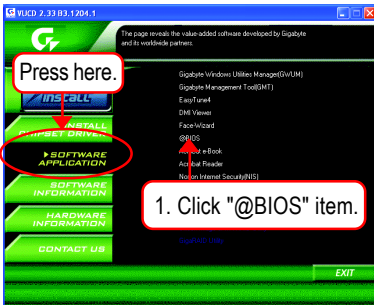

(1)

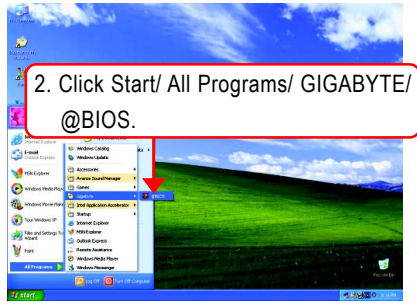

(2)

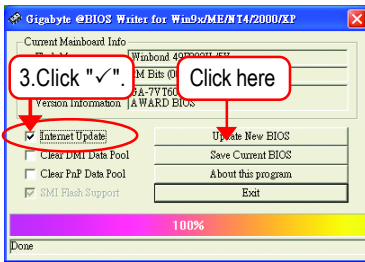

(3)

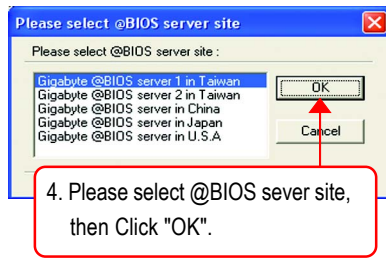

(4)

Methods and steps:

- I. Update BIOS through Internet
 - a. Click "Internet Update" icon
 - b. Click "Update New BIOS" icon
 - c. Select @BIOS™ sever
 - d. Select the exact motherboard name on your motherboard.
 - e. System will automatically download and update the BIOS.

II. Update BIOS NOT through Internet:

- a. Do not click "Internet Update" icon
- b. Click "Update New BIOS"
- c. Please select "All Files" in dialog box while opening the old file.
- d. Please search for BIOS unzip file, downloading from internet or any other methods (such as: 7VT600.F4c).
- e. Complete update process following the instruction.

III. Save BIOS

In the very beginning, there is "Save Current BIOS" icon shown in dialog box. It means to save the current BIOS version.

IV. Check out supported motherboard and Flash ROM:

In the very beginning, there is "About this program" icon shown in dialog box. It can help you check out which kind of motherboard and which brand of Flash ROM are supported.

Note:

- a. In method I, if it shows two or more motherboard's model names to be selected, please make sure your motherboard's model name again. Selecting wrong model name will cause the system unbooted.
- b. In method II, be sure that motherboard's model name in BIOS unzip file are the same as your motherboard's. Otherwise, your system won't boot.
- c. In method I, if the BIOS file you need cannot be found in @BIOS™ server, please go onto Gigabyte's web site for downloading and updating it according to method II.
- d. Please note that any interruption during updating will cause system unbooted

2- / 4- / 6-Channel Audio Function Introduction

The installation of Windows 98SE/2K/ME/XP is very simple. Please follow next step to install the function!

Stereo Speakers Connection and Settings:

We recommend that you use the speaker with amplifier to acquire the best sound effect if the stereo output is applied.

STEP 1:

Connect the stereo speakers or earphone to "Line Out".



Line Out

STEP 2 :

After installation of the audio driver, you'll find an  icon on the taskbar's status area. Click the audio icon "Sound Effect" from the windows tray at the bottom of the screen.



STEP 3:

Select "Speaker Configuration", and choose the "2 channels for stereo speakers out put".

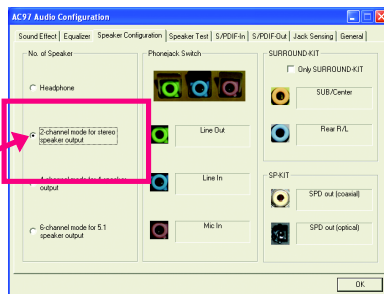
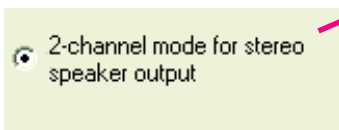

4 Channel Analog Audio Output Mode

STEP 1 :

Connect the front channels to "Line Out", the rear channels to "Line In".



Line Out Line In

STEP 2 :

After installation of the audio driver, you'll find an  icon on the taskbar's status area. Click the audio icon "Sound Effect" from the windows tray at the bottom of the screen.

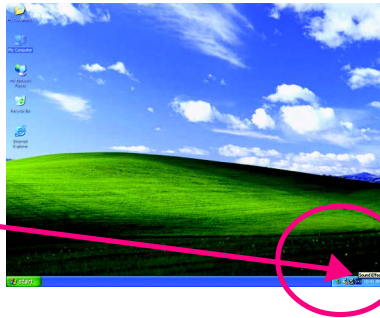

STEP 3 :

Select "Speaker Configuration", and choose the "4 channels for 4 speakers out put".

Disable "Only SURROUND-KIT", and press "OK".

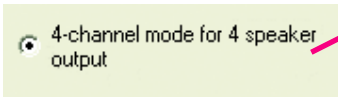

When the "Environment settings" is "None", the sound would be performed as stereo mode (2 channels output). Please select the other settings for 4 channels output.

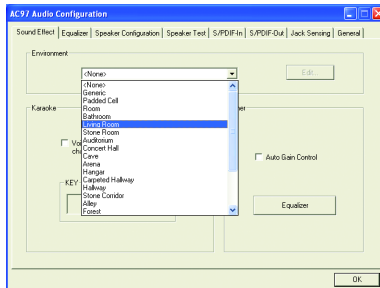

Basic 6 Channel Analog Audio Output Mode

Use the back audio panel to connect the audio output without any additional module.

STEP 1 :

Connect the front channels to "Line Out", the rear channels to "Line In", and the Center/Subwoofer channels to "MIC In".

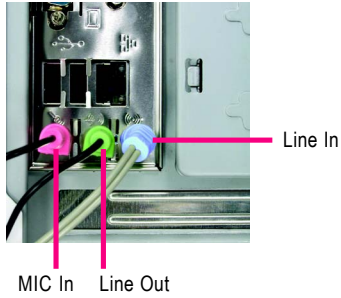

STEP 2 :

After installation of the audio driver, you'll find an  icon on the taskbar's status area. Click the audio icon "Sound Effect" from the windows tray at the bottom of the screen.

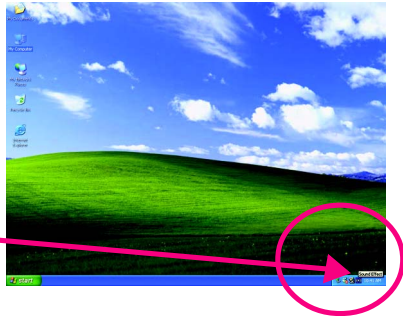

STEP 3 :

Select "Speaker Configuration", and choose the "6 channels for 5.1 speakers out put". Disable "Only SURROUND-KIT" and pess "OK".

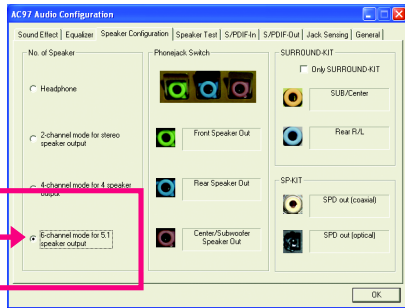
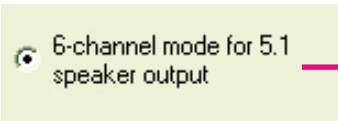

Advanced 6 Channel Analog Audio Output Mode (using Audio Combo Kit, Optional Device):

(Audio Combo Kit provides SPDIF output port : optical & coaxial and SURROUND-KIT : Rear R/L & Center/subwoofer)

SURROUND-KIT access analog output to rear channels and Center/Subwoofer channels. It is the best solution if you need 6 channel output, Line In and MIC at the same time. "SURROUND-KIT" is included in the GIGABYTE unique "Audio Combo Kit" as picture.



STEP 1 :

Insert the "Audio Combo Kit" in the back of the case, and fix it with the screw.



STEP 2 :

Connect the "SURROUND-KIT" to SUR_CEN on the M/B.

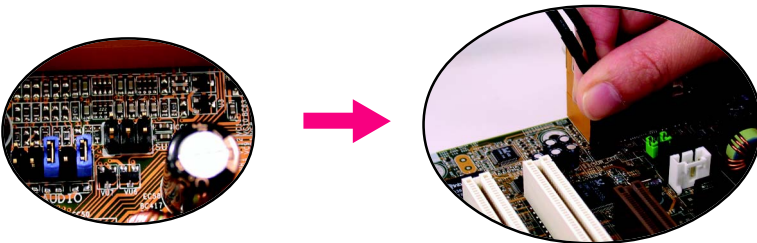

STEP 3 :

Connect the front channels to back audio panel's "Line Out", the rear channels to SURROUND-KIT's REAR R/L, and the Center/Subwoofer channels to SURROUND-KIT's SUB CENTER.

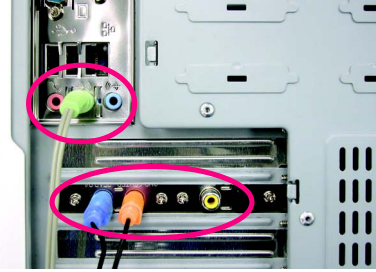

STEP 4 :

Click the audio icon "Sound Effect" from the windows tray at the bottom of the screen.

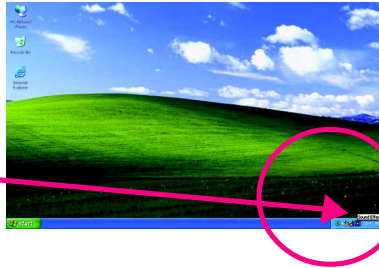
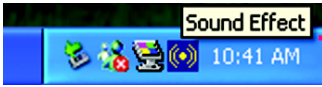

STEP 5 :

Select "Speaker Configuration", and choose the "6 channels for 5.1 speakers out put". Enable "Only SURROUND-KIT" and press "OK".

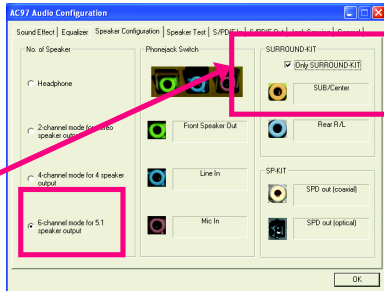
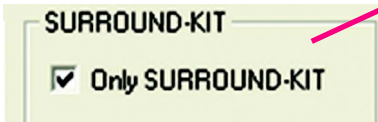

Basic & Advanced 6 Channel Analog Audio Output Mode Notes:

When the "Environment" is "None", the sound would be performed as stereo mode (2 channels output). Please select the other settings for 6 channels output.

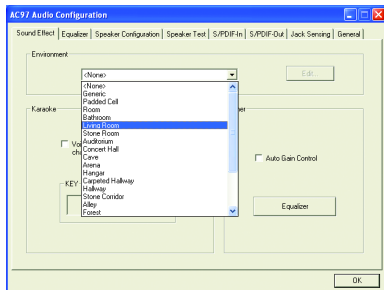

SPDIF Output Device (Optional Device)

A "S/PDIF output" device is available on the motherboard. Cable with rear bracket is provided and could link to the "S/PDIF output" connector (As picture.) For the further linkage to decoder, rear bracket provides coaxial cable and Fiber connecting port.

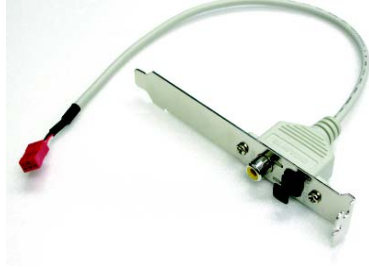

1. Connect the SPDIF output device to the rear bracket of PC, and fix it with screw.

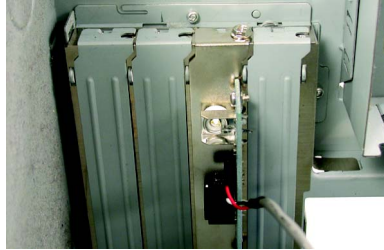

2. Connect SPDIF wire to the motherboard.

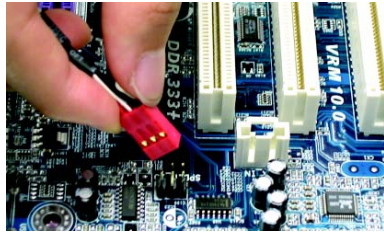

3. Connect co-axial or optical output to the AC3 decoder.

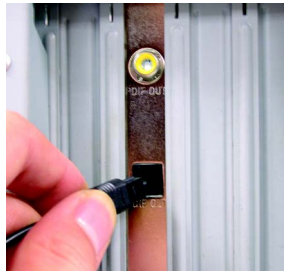

Jack-Sensing Introduction



Jack-Sensing provides audio connectors error-detection function.



Install Microsoft DirectX8.1 before to enable Jack-Sensing support for Windows 98/98SE/2000 /ME.

Jack-Sensing includes 2 parts: AUTO and MANUAL. Following is an example for 2 channels (Windows XP):

Introduction of audio connectors

You may connect CDROM, Walkman or others audio input devices to Line In jack, speakers, earphone or others output devices to Line Out jack, and microphone to MIC In jack.

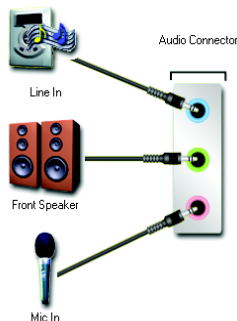

Auto-detecting:

Please connect the devices to the right jacks as above. A window will appear as right picture if you setup the devices properly.

Please note that 3D audio function will only appear when 3D audio inputs.

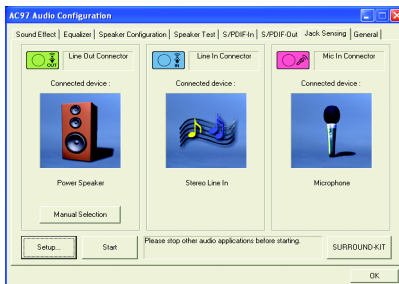

If you set wrong with the connectors, the warning message will come out as right picture.



Manual setting:

If the device picture shows different from what you set, please press "Manual Selection" to set.

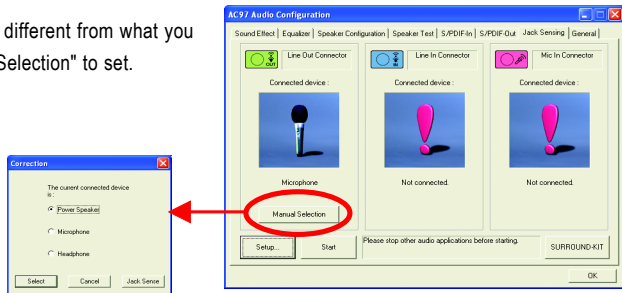

Xpress Recovery Introduction

What is Xpress Recovery?

Xpress Recovery utility is an utility for backing up and restoring O.S. partition. If the hard drive can not work properly, you can restore it to the original state.



1. It supports FAT16, FAT32, NTFS format.
2. It must be connected to IDE1 Master.
3. It's only allows you to install one O.S.
4. It must be used with IDE hard disk supporting HPA.
5. The first partition must be set as the boot partition. When the boot partition is backed up, please do not change its size.
6. It is not recommend to use Xpress Recovery if you had ever used Ghost to return boot manager to NTFS format.



1. System data and hard disk's reading/writing speed will affect backing up speed.
2. We recommend that you install Xpress Recovery immediately after installing O.S, drivers and applications.

How to use the Xpress Recovery

There are two ways to enter the Xpress Recovery utility. (see the below)

1. Text Mode: press F9 during powering on the computer.

Press F9 during powering on the computer.

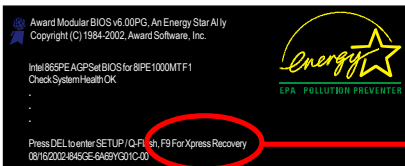

F9 For Xpress Recovery

2. BMP Mode: boot from CD-ROM

Please go to "Advanced BIOS" setting menu and set boot from CD-ROM, then save and exit the BIOS menu. Later, please insert MB driver CD into your drive when "Boot from CD:" appears at the bottom of the screen, press any key to enter Xpress Recovery.



Boot from CD:

You can highlight the item by using the arrows keys on your keyboard and enter key to enter the menu.

Text Mode:

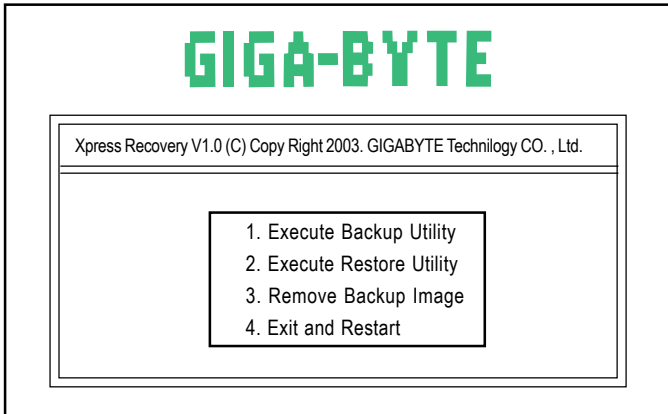

BMP Mode:

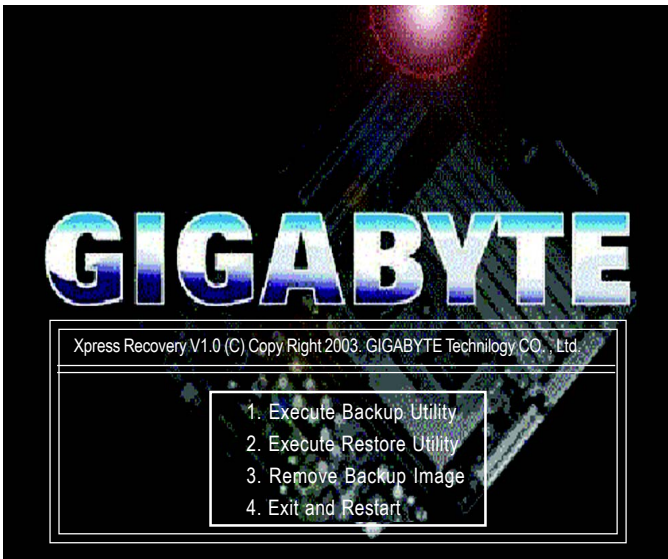

If you ever entered Xpress Recovery by booting from CD-ROM, you'll still be directed to BMP mode by pressing F9 in the bootup screen.

1. Execute Backup Utility:

 **Press B to Backup your System or Esc to Exit**

The Backup utility will scan the system automatically and back it up.

The backed up data will be saved as a hidden image .

2. Execute Restore Utility:

 **This program will recover your system to factory default.**

Press R to recover your system.

Press Esc to exit

Restore the backup image to the original state.

3. Remove Backup Image:

 **Are you sure to remove backup image? (Y/N)**

Remove the backup image.

4. Exit and Restart:

Exit and restart your computer.

Chapter 5 Appendix

Install Drivers



NOTE

Picture below are shown in Windows XP

Insert the driver CD-title that came with your motherboard into your CD-ROM drive, the driver CD-title will auto start and show the installation guide. If not, please double click the CD-ROM device icon in "My computer", and execute the setup.exe.

INSTALL CHIPSET DRIVER

This page shows the drivers that need to be installed for the system. Click each item to install the driver manually or switch to the  to install the drivers automatically.

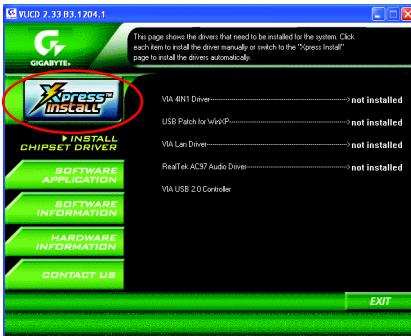

The "Xpress Install" uses the "Click and GO" technology to install the drivers automatically. Just select the drivers you want then click the "GO" button. The  will finish the installation for you automatically.

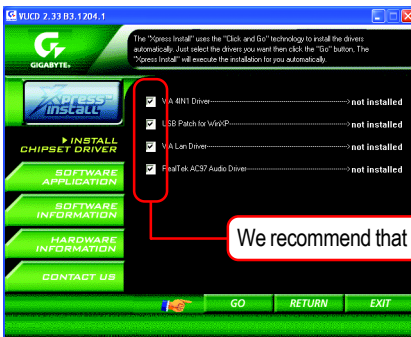

NOTE

Message: Some device drivers will restart your system automatically. After restarting your system the "Xpress Install" will continue to install other drivers.

We recommend that you install all components in the list.

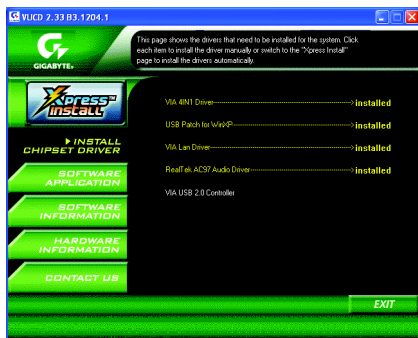

Driver install finished !

You have to reboot system !

Item Description

- VIA 4IN1 Driver
For INF, AGP, IDE and DMA Driver
- USB Path for WinXP
This patch driver can help you to resolve the USB device wake up S3 hang up issue in XP
- VIA Lan Driver *
VIA 10/100 LAN driver for VT6103L chips
- RealTek AC97 Audio Driver
Audio driver for Realtek AC97 codec chipset
- VIA USB 2.0 Controller
USB 2.0 Driver information for XP



For USB2.0 driver support under Windows XP operating system, please use Windows Service Pack. After install Windows Service Pack, it will show a question mark "?" in "Universal Serial Bus controller" under "Device Manager". Please remove the question mark and restart the system (System will auto-detect the right USB2.0 driver).

" * " For GA-7VT600-L Only.

SOFTWARE APPLICATION

This page reveals the value-added software developed by Gigabyte and its worldwide partners.

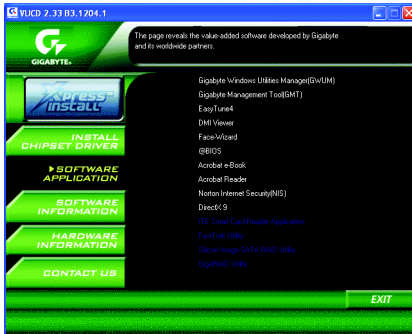

- Gigabyte Windows Utilities Manager(GWUM)
This utility can integrate the Gigabyte's applications in the system tray
- Gigabyte Management Tool(GMT)
A useful tool which can manage the computer via the network
- EastTune4
Powerful utility that integrates the overclocking and hardware monitoring functions
- DMI Viewer
Windows based utility which is used to browse the DMI/SMBIOS information of the system
- Face-Wizard
New utility for adding BIOS logo
- @BIOS
Gigabyte windows flash BIOS utility
- Acrobat e-Book
Useful utility from Adobe
- Acrobat Reader
Popular utility from Adobe for reading .PDF file format documents
- Norton Internet Security(NIS)
Integrated utility which includes anti-virus, ad control, etc.
- DirectX 9.0
Install Microsoft DirectX 9 to enable 3D hardware acceleration that support for operating system to achieve better 3D performance.

EasyTune 4 Utilities Installation

Powerful utility that integrates the overclocking and hardware monitoring functions

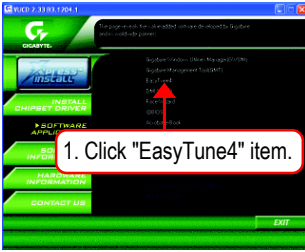

(1)

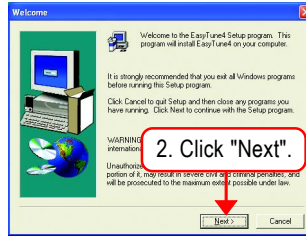

(2)

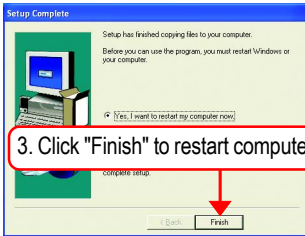

(3)



(4)

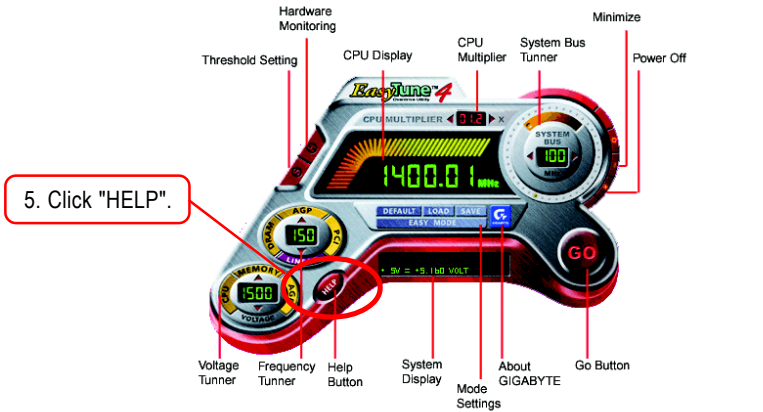

FAQ

Below is a collection of general asked questions. To check general asked questions based on a specific motherboard model, please log on to <http://tw.giga-byte.com/faq/faq.htm>

Question 1: I cannot see some options that were included in previous BIOS after updating BIOS. Why?

Answer: Some advanced options are hidden in new BIOS version. Please press Ctrl and F1 keys after entering BIOS menu and you will be able to see these options.

Questions 2: Why is the light of my keyboard/optical mouse still on after computer shuts down?

Answer: In some boards, a small amount of electricity is kept on standby after computer shuts down and that's why the light is still on.

Question 3: Why cannot I use all functions in EasyTune™ 4?

Answer: The availability of the listed functions in EasyTune™ 4 depends on the MB chipset. If the chipset doesn't support certain functions in EasyTune™ 4, these functions will be locked automatically and you will not be able to use them.

Question 4: Why do I fail to install RAID and ATA drivers under Win 2000 and XP on boards that support RAID function after I connect the boot HDD to IDE3 or IDE4 ?

Answer: First of all, you need to save some files in the CD-ROM to a floppy disk before installing drivers. You also need to go through some rather different steps in the installation process. Therefore, we suggest that you refer to the installation steps in the RAID manual at our website. (Please download it at http://tw.giga-byte.com/support/user_pdf/raid_manual.pdf)

Question 5: How do I clear CMOS?

Answer: If your board has a Clear CMOS jumper, please refer to the Clear CMOS steps in the manual. If your board doesn't have such jumper, you can take off the on-board battery to leak voltage to clear CMOS. Please refer to the steps below:

Steps:

1. Turn off power.
2. Disconnect the power cord from MB.
3. Take out the battery gently and put it aside for about 10 minutes (Or you can use a metal object to connect the positive and negative pins in the battery holder to make them short for one minute).
4. Re-insert the battery to the battery holder.
5. Connect power cord to MB again and turn on power.
6. Press Del to enter BIOS and load Fail-Safe Defaults.
7. Save changes and reboot the system.

Question 6: Why does system seem unstable after updating BIOS?

Answer: Please remember to load Fail-Safe Defaults (Or Load BIOS Defaults) after flashing BIOS. However, if the system instability still remains, please clear CMOS to solve the problem.

Question 7: Why do I still get a weak sound after turning up the speaker to the maximum volume?

Answer: Please make sure the speaker you are using is equipped with an internal amplifier. If not, please change another speaker with power/amplifier and try again later.

Question 8: How do I disable onboard VGA card in order to add an external VGA card?

Answer: Gigabyte motherboards will auto-detect the external VGA card after it is plugged in, so you don't need to change any setting manually to disable the onboard VGA.

Question 9: Why cannot I use the IDE 2?

Answer: Please refer to the user manual and check whether you have connected any cable that is not provided with the motherboard package to the USB Over Current pin in the Front USB Panel. If the cable is your own cable, please remove it from this pin and do not connect any of your own cables to it.

Question 10: Sometimes I hear different continuous beeps from computer after system boots up. What do these beeps usually stand for?

Answer: The beep codes below may help you identify the possible computer problems. However, they are only for reference purposes. The situations might differ from case to case.

→ AMI BIOS Beep Codes

*Computer gives 1 short beep when system boots successfully

*Except for beep code 8, these codes are always fatal.

- 1 beep Refresh failure
- 2 beeps Parity error
- 3 beeps Base 64K memory failure
- 4 beeps Timer not operational
- 5 beeps Processor error
- 6 beeps 8042 - gate A20 failure
- 7 beeps Processor exception interrupt error
- 8 beeps Display memory read/write failure
- 9 beeps ROM checksum error
- 10 beeps CMOS shutdown register read/write error
- 11 beeps Cache memory bad

→ AWARD BIOS Beep Codes

1 short: System boots successfully

- 2 short: CMOS setting error
- 1 long 1 short: DRAM or M/B error
- 1 long 2 short: Monitor or display card error
- 1 long 3 short: Keyboard error
- 1 long 9 short: BIOS ROM error
- Continuous long beeps: DRAM error
- Continuous short beeps: Power error

Question 11: How to set in the BIOS in order to bootup from SATA HDDs by either RAID or ATA mode?

Answer: Please set in the BIOS as follow:

1. Advanced BIOS features--> SATA/RAID/SCSI boot order: "SATA"
2. Advanced BIOS features--> First boot device: "SCSI"
3. Integrated Peripherals--> Onboard H/W Serial ATA: "enable"

Then it depends on the SATA mode that you need to set "RAID" to RAID mode or "BASE" to normal ATA mode in the item named Serial ATA function.

Question 12: For the M/B which have RAID function, how to set in the BIOS in order to bootup from IDE3, 4 by either RAID or ATA mode?

Answer: Please set in the BIOS as follow:

1. Advanced BIOS features-->(SATA)/RAID/SCSI boot order: "SATA"
2. Advanced BIOS features--> First boot device: "SCSI"
3. Integrated Peripherals--> Onboard H/W ATA/RAID: "enable"

Then it depends on the RAID mode that you need to set "RAID" to RAID mode or "ATA" to normal ATA mode in the item named RAID controller function.

Question 13: How to set in the BIOS to bootup from the IDE/ SCSI/ RAID card ?

Answer: Please set in the BIOS as follow:

1. Advanced BIOS features-->(SATA)/RAID/SCSI boot order: "SCSI"
2. Advanced BIOS features--> First boot device: "SCSI"

Then it depends on the mode(RAID or ATA) that you need to set in RAID/ SCSI BIOS.

Troubleshooting



If you encounter any trouble during boot up, please follow the troubleshooting procedures.

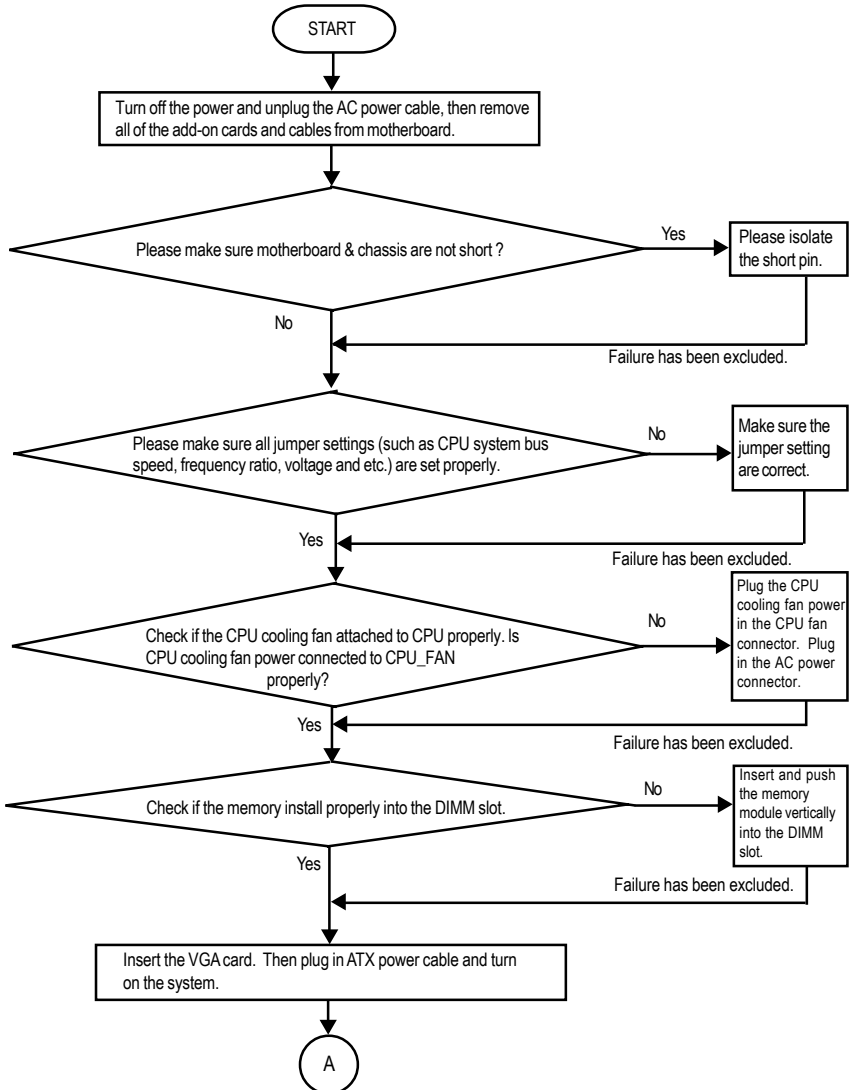

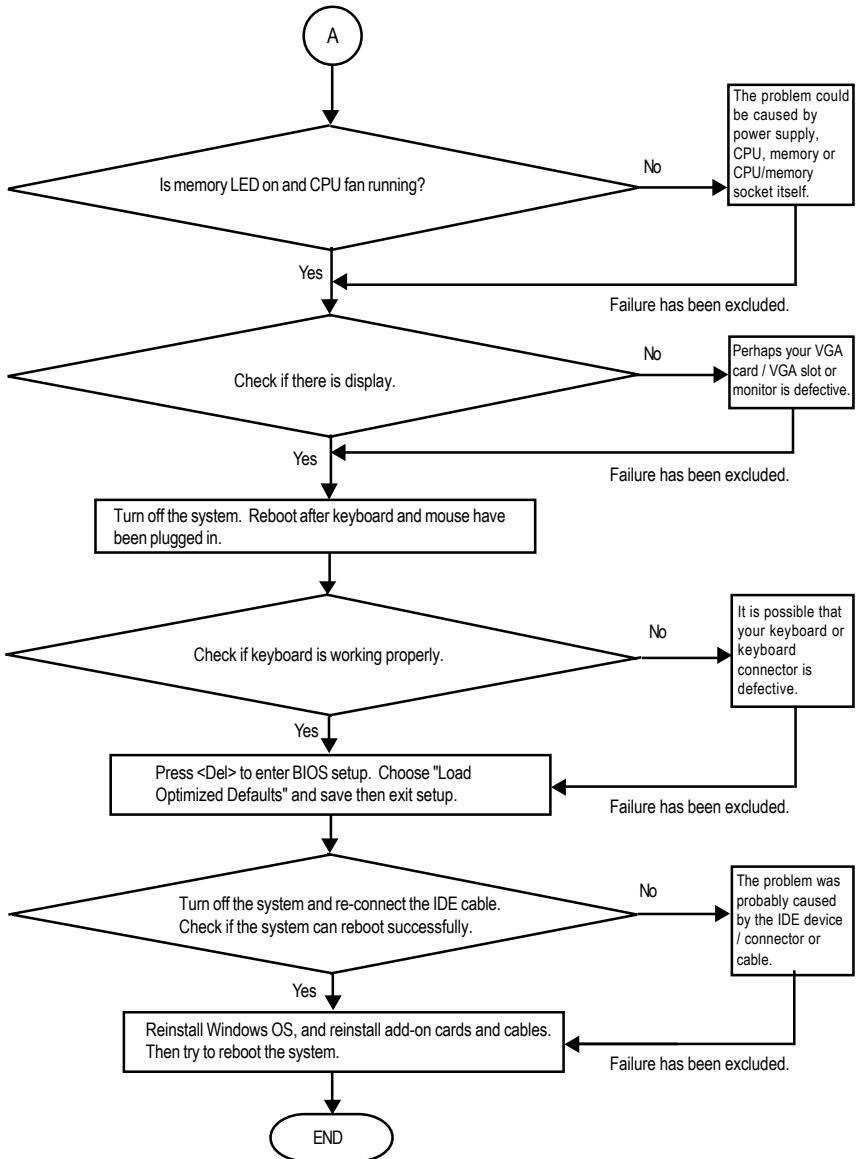

If the above procedure unable to solve your problem, please contact with your local retailer or national distributor for help. Or, you could submit your question to the service mail via Gigabyte website technical support zone (<http://www.gigabyte.com.tw>). The appropriate response will be provided ASAP.



Technical Support/RMA Sheet

Customer/Country:	Company:	Phone No.:
Contact Person:	E-mail Add. :	

Model name/Lot Number:	PCB revision:
BIOS version:	O.S./A.S.:

Hardware Configuration	Mfs.	Model name	Size:	Driver/Utility:
CPU				
Memory Brand				
Video Card				
Audio Card				
HDD				
CD-ROM / DVD-ROM				
Modem				
Network				
AMR / CNR				
Keyboard				
Mouse				
Power supply				
Other Device				

Problem Description:

Appendix E: Acronyms

Acronyms	Meaning
ACPI	Advanced Configuration and Power Interface
APM	Advanced Power Management
AGP	Accelerated Graphics Port
AMR	Audio Modem Riser
ACR	Advanced Communications Riser
BIOS	Basic Input / Output System
CPU	Central Processing Unit
CMOS	Complementary Metal Oxide Semiconductor
CRIMM	Continuity RIMM
CNR	Communication and Networking Riser
DMA	Direct Memory Access
DMI	Desktop Management Interface
DIMM	Dual Inline Memory Module
DRM	Dual Retention Mechanism
DRAM	Dynamic Random Access Memory
DDR	Double Data Rate
ECP	Extended Capabilities Port
ESCD	Extended System Configuration Data
ECC	Error Checking and Correcting
EMC	Electromagnetic Compatibility
EPP	Enhanced Parallel Port
ESD	Electrostatic Discharge
FDD	Floppy Disk Device
FSB	Front Side Bus
HDD	Hard Disk Device
IDE	Integrated Dual Channel Enhanced
IRQ	Interrupt Request
I/O	Input / Output
IOAPIC	Input Output Advanced Programmable Input Controller
ISA	Industry Standard Architecture
LAN	Local Area Network

to be continued.....

Acronyms	Meaning
LBA	Logical Block Addressing
LED	Light Emitting Diode
MHz	Megahertz
MIDI	Musical Instrument Digital Interface
MTH	Memory Translator Hub
MPT	Memory Protocol Translator
NIC	Network Interface Card
OS	Operating System
OEM	Original Equipment Manufacturer
PAC	PCI A.G.P. Controller
POST	Power-On Self Test
PCI	Peripheral Component Interconnect
RIMM	Rambus in-line Memory Module
SCI	Special Circumstance Instructions
SECC	Single Edge Contact Cartridge
SRAM	Static Random Access Memory
SMP	Symmetric Multi-Processing
SMI	System Management Interrupt
USB	Universal Serial Bus
VID	Voltage ID

CONTACT US

Contact us via the information in this page all over the world.

- Taiwan

Gigabyte Technology Co., Ltd.

Address: No.6, Bau Chiang Road, Hsin-Tien, Taipei Hsien, Taiwan, R.O.C.

TEL: 886 (2) 8912-4888

FAX: 886 (2) 8912-4004

E-mail:

We have been constantly striving hard to provide you with faster and more efficient mail replying service.

If you have any inquiry please classify it into the following topics.

The respective department will attend to the inquiry as soon as possible. Thank you for your cooperation!

WEB Address: <http://tw.giga-byte.com>

- USA

G.B.T. INC.

Address: 17358 Railroad St, City of Industry, CA 91748.

Tel: 1 (626) 854-9338

Fax: 1 (626) 854-9339

E-mail: sales@giga-byte.com

support@giga-byte.com

WEB Address: <http://us.giga-byte.com>

- Germany

G.B.T. Technology Trading GmbH

Tel: 49-40-2533040

49-01803-428468 (Tech.)

Fax: 49-40-25492343 (Sales)

49-01803-428329 (Tech.)

E-mail: support@gigabyte.de

WEB Address: <http://de.giga-byte.com>

- Japan

Nippon Giga-Byte Corporation

WEB Address: <http://www.gigabyte.co.jp>

- U.K

G.B.T. TECH. CO. LTD.

Tel: 44-1908-362700

Fax: 44-1908-362709

E-mail: support@gbt-tech.co.uk

WEB Address: <http://uk.giga-byte.com>

- The Netherlands

Giga-Byte Technology B.V.

Address: Verdunplein 8 5627 SZ, Eindhoven, The Netherlands

Tel: +31 40 290 2088

NL Tech.Support : 0900-GIGABYTE (0900-44422983, € 0.2/M)

BE Tech.Support : 0900-84034 (€ 0.4/M)

Fax: +31 40 290 2089

E-mail: info@giga-byte.nl

Tech. Support E-mail: support@giga-byte.nl

WEB Address: <http://nl.giga-byte.com>

- China

Shanghai Office

Tel: 86-21-64737410

Fax: 86-21-64453227

WEB Address: <http://cn.giga-byte.com>

GuangZhou Office

Tel: 86-20-87586273

Fax: 86-20-87544306

WEB Address: <http://cn.giga-byte.com>

Beijing Office

Tel: 86-10-82856054

86-10-82856064

86-10-82856094

Fax: 86-10-82856575

E-mail: bjsupport@gigabyte.com.cn

WEB Address: <http://cn.giga-byte.com>

Chengdu Office

Tel: 86-28-85236930

Fax: 86-28-85256822

WEB Address: <http://cn.giga-byte.com>
