

Gigaset

C590 IP - C595 IP

GIGASET. INSPIRING CONVERSATION.
MADE IN GERMANY

SIEMENS

Safety precautions

Warning:

Read the safety precautions and the user guide before use.

Explain their content and the potential hazards associated with using the telephone to your children.

- > Use only the power adapter supplied, as indicated on the rear of the base.
Use only the cables supplied for fixed line and LAN connection and connect these to the intended port only.
- > Use only **rechargeable batteries** that correspond to the **specification** (see enclosed CD), as this could otherwise result in significant health risks and personal injury.
- > Insert rechargeable batteries with the correct polarity and use them in accordance with the user guide (polarity symbols are displayed in or on the handset battery compartment).
- > Using your telephone may affect nearby medical equipment. Be aware of the technical conditions in your particular environment, e.g., doctor's surgery.
If you use a medical device (e.g. a pacemaker), please contact the device manufacturer. They will be able to advise you regarding the susceptibility of the device to external sources of high frequency energy. Please refer to the "Appendix" chapter in the long user guide (see enclosed CD) for the specifications of this Gigaset product.
- > Do not hold the rear of the handset to your ear when it is ringing or when speaker mode is activated. Otherwise you risk serious and permanent damage to your hearing.
Your Gigaset is compatible with the majority of digital hearing aids on the market. However, perfect function with all hearing aids cannot be guaranteed.
The handset may cause interference in analogue hearing aids (humming or whistling) or cause them to overload. If you require assistance, please contact the hearing aid supplier.
- > Do not install the base and charger in bathrooms or shower rooms. The base and charger are not splash-proof.
- > Do not use the phone in environments with a potential explosion hazard, e.g., paint shops.
- > The charger and base are designed for use in dry rooms in a temperature range of +5°C to +45°C.
- > Never expose the telephone to heat sources, direct sunlight or other electrical appliances.
- > Protect your Gigaset from moisture, dust, corrosive liquids and fumes.
- > If you give your Gigaset to a third party, make sure that you also give them the user guide.
- > Remove faulty bases from use or have them repaired by our Service, as these could interfere with other wireless services. Disconnect TNV circuit connector before removing cover.
- > Please note that only terminals that are operated in-house (inside buildings) may be connected to the analogue TAE connection.
- > All electrical and electronic products should be disposed of separately from general household waste using designated local authority sites.



If a product displays this symbol of a crossed-out rubbish bin, the product is subject to European Directive 2002/96/EC.

Correct disposal and separate collection of used equipment will help to prevent potential negative consequences for the environment and human health. They are a prerequisite for the re-use and recycling of used electrical and electronic equipment.

For further information on disposing of your used equipment, please contact your local authority, your refuse collection service or the dealer you purchased the product from.

- > Batteries should not be disposed of in general household waste. Observe the local waste disposal regulations, details of which can be obtained from your local authority or the dealer you purchased the product from.

Warning:

- > Not all of the functions described in this user guide are available in all countries.
- > The device cannot be used in the event of a power failure. It is also **not** possible to transmit **emergency calls**.
- > When the keypad lock is active, you cannot call emergency numbers.

Package contents



- 1 Gigaset C590 IP or C595 IP **base**
- 2 Power adapter for connecting the base to the mains power supply
- 3 Phone cord (flattened) for connecting the base to the analogue fixed line network
- 4 Ethernet (LAN) cable for connecting the base to the router (LAN/Internet)
- 5 Gigaset C59H **handset**
- 6 Two batteries for the handset (uncharged)
- 7 Battery cover for the handset
- 8 Belt clip for the handset
- 9 Handset **charger**
- 10 Power adapter for connecting the charger to the mains power supply
- 11 This quick guide and CD with installation wizard for your telephone, licence texts, warranty agreement, links to the long user guide and to key websites.
If the firmware for your base is updated, the user guide will also be updated and made available for download on the Internet at www.gigaset.com.

Keys and functions on the handset



Display keys:

Start function displayed to the left or right of the bottom display line



Speaker key:

Switch between earpiece and speaker mode (key lights up)



Talk key:

Answer a call;
after entering number: start dialling



Control key:

Open menu (press right);
open directory (press down arrow);
open list of online directories (press and hold down arrow); scroll through menus (press up/down);
navigate in text



Message key:

Open calls and messages lists;
flashing: new call, new message/firmware



End call key, on/off key:

End call, cancel function (press briefly);
return to idle status (press and hold);
switch handset on/off (press and hold)



Fast access key (press and hold):

Listen to messages on the network mailbox or on the integrated answering machine



*** key:** Ringer on/off (press and hold)



key: Keypad lock on/off (press and hold)



Recall/pause key (fixed line)



Mute key: Microphone muting

Connection overview



- 1** Preparing the handset: inserting the batteries
- 2** Connecting the charger to the mains power supply and charging the batteries
- 3** Connecting the phone cord and power lead to the base
- 4** Connecting the base to the fixed line network and the mains power supply
- 5** Connecting the base to the router in order to connect the base to the Internet (connection via router and modem or via router with integrated modem)
- 6** Connecting the PC to the LAN (optional) – for advanced configuration of the Gigaset C590/ C595 IP base

Preparing the handset

1 Inserting the supplied batteries and closing the battery cover



- > Check the polarity when inserting the batteries (see symbols in or on the battery compartment).
- > Use only the rechargeable batteries recommended.

Once the batteries have been inserted, the handset switches on automatically.

- > First insert the tab on the top of the battery cover in the recess on the housing **A**.
- > Then press the cover until it clicks into place **B**.

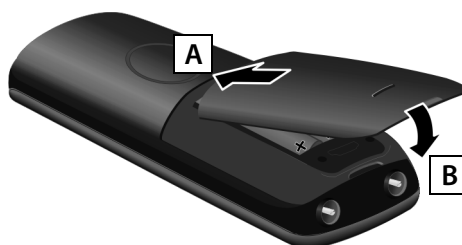

> The display is protected by a plastic film. Please remove the protective film!

2 Connecting the charger and charging the batteries

> **Observe the sequence (A, B)!**

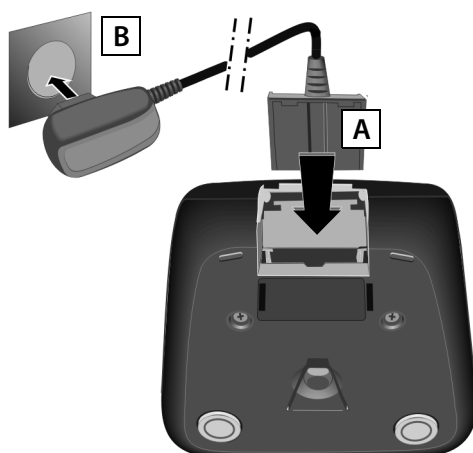

- > Place the handset in the charger and wait until the batteries are fully charged (approx. 10 hours).



- > Do not put the handset back in the charger until the batteries are fully discharged through use.
- > After the first battery charge **and** discharge, you may place your handset in the charger after every call.
- > The battery charging status is displayed in the idle display: (empty to full).

Connecting the base

3 Connecting the phone cord and power lead to the base

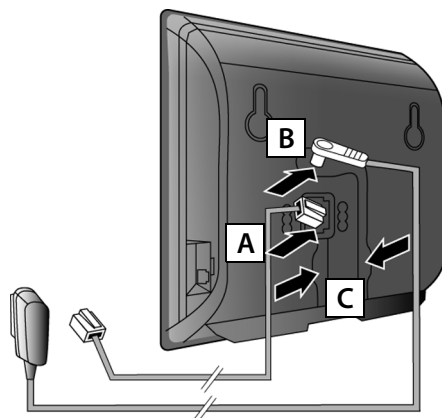

- A** Insert the (flattened) phone cord into the lower connection socket at the rear of the base.
- B** Insert the power lead of the power adapter into the upper connection socket at the rear of the base.
- C** Insert both cables into their respective cable recesses.

Use only the **supplied** phone cord and the supplied power adapter.

4 Connecting the base to the fixed line network and mains power supply

- A** Insert the phone cord into the fixed line network connection socket.
- B** **Then** insert the power adapter into the mains socket.

Keep the power adapter **plugged in at all times** for operation, as the phone does not work without a mains connection.

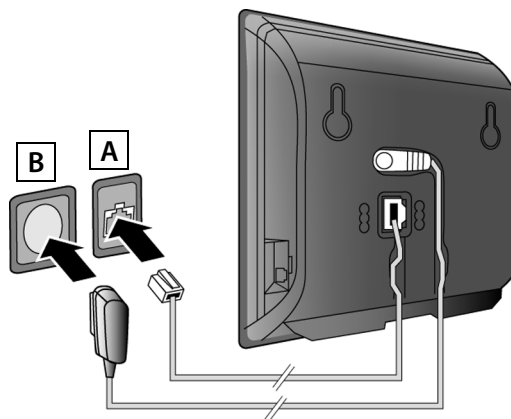

You can now use your phone to make calls via the fixed line network:
Enter the number using the handset, and then press the talk key .

The integrated answering machine **Ans. Mach. 1** starts in answer and record mode.

Connecting the base

5 Connecting the base to the router (Internet)

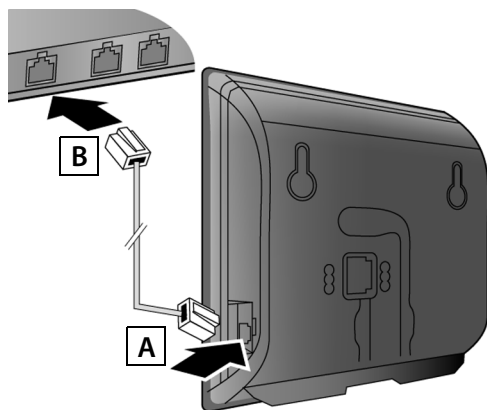

- A** Connect one Ethernet cable plug to the LAN socket at the side of the base.
- B** Insert the second Ethernet cable plug into a LAN socket on the router.

Use the Ethernet cable supplied.

As soon as the cable connecting the phone and router is plugged in and the router is switched on, the key lights up on the front of the base (paging key).

Data protection notice: Further information about saving Gigaset.net service data can be found at www.gigaset.net/privacy-policy.

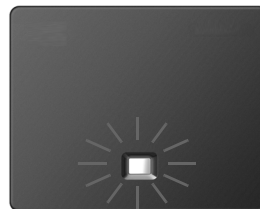

6 Connecting the PC to the router (optional)



You can change the settings on the phone's base using a PC connected to your phone via the router.

> Connect the PC network connection to a free LAN socket on your router.

The procedure below requires that your phone is automatically assigned an IP address by the router (i.e. DHCP is enabled on router and phone).

In **exceptional cases** (e.g. if DHCP is not enabled on the router) you will have to assign a static IP address to the base for LAN access. You must enter this IP address on the handset before carrying out the following steps. Further information on this can be found in the long user guide (see enclosed CD).

The following handset menu can be used to make the entry:

 (Press right on the control key) →  → **System** → **Local Network** → (enter system PIN if required)

Configuring the VoIP connection

Instead of using the following procedure, you can also enter the VoIP access data and the assignment of the VoIP connection as send and receive connection using your PC (steps **7** to **12**):

- > Launch the web browser on your PC.
- > Enter the URL **www.gigaset-config.com** in the address field of the web browser and press the return key.

You are connected to your base's Web configurator. To log in to the Web configurator you will need the system PIN for the telephone (default setting: 0000).

A description of the Web configurator can be found in the long user guide (see enclosed CD) and in the Web configurator online help document.

Prerequisite for the following steps:

Before you can use VoIP to phone any other subscribers on the Internet, the fixed line network or the mobile phone network, you need a VoIP account.

- > Set up a VoIP account with a VoIP provider.
- > Have your VoIP account data you received from your VoIP provider to hand.

You will need:

- > Your registration name (login ID), your password and, if applicable (provider-dependent), a user name (often this is your VoIP phone number).

Or

- > Your personal auto-configuration code (activation code), if your provider supports "automatic configuration".

Configuring the VoIP connection

7 Starting the configuration process

When your handset is sufficiently charged (approx. 20 minutes after you have placed it in the charger), the message key  on the handset flashes.



> Press the message key  on the handset.

If "New firmware available" is shown in the display, updated firmware is already available for your phone. Press the right-hand display key **Yes**. The new firmware is loaded. This takes approx. 6 minutes. The message key  will now flash again.

> Press the message key  to start configuration.

8 Starting the VoIP wizard





> Press the key below **Yes** on the display (= right display key).



> Press the bottom of the control key  to scroll down.

> Press the **OK** display key to continue.

If the connection wizard does not start correctly, or if you cancel the connection wizard, you can start it via the following menu on the handset:

 (press right) →  → **Telephony** → **VoIP Wizard**

Configuring the VoIP connection



A list of all possible IP connections is shown in the display (IP 1 to IP 6). VoIP connections that are already configured are marked with .

- > If necessary, press down on the control key  to select a connection.
- > Press the **OK** display key to continue.

Provided that your phone is set for auto-configuration (default setting), you will see the following display. Otherwise, for more information, see **10**.

If you have received a **registration name/password** and, if applicable, a user name:

- > Press the key below **No** on the display screen.
- > For more information, see **10**.

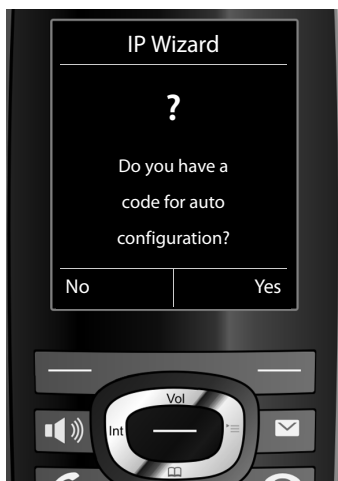

If you have received an **auto-configuration code**:

- > Press the key below **Yes** on the display screen.
- > For more information, see **9**.

If your phone cannot establish a connection to the Internet, the message **Internet connection not available** is displayed.

- > Press the left display key **Info** to display information about the possible causes of errors.
- > Press the right display key **OK** to end the VoIP wizard and start the connection wizard (step **12**).

Configuring the VoIP connection

9 Entering an auto-configuration code



- > Enter your auto-configuration code using the keypad (max. 32 characters).
- > Press the right-hand display key **OK**.

All data required for VoIP telephony is loaded directly from the Internet to your phone.

Following successful download, **Your IP account is registered with your provider.** is shown in the display.

Proceed as described under **12**.

10 Selecting a provider and loading provider data to the base

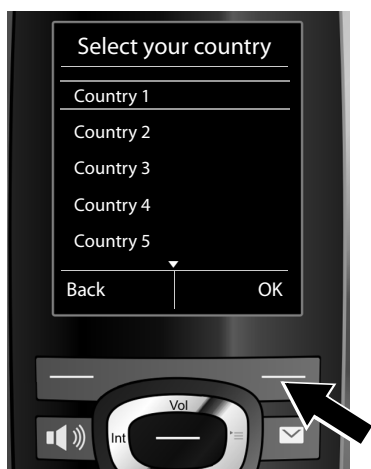

- > Select your country with the control key  (press down arrow).
- > Press the display key **OK**.



- > Select your provider with the control key  (press down arrow).
- > Press the display key **OK**.



The general access data for your VoIP provider will be downloaded and saved on the phone.

Configuring the VoIP connection

If your provider is not in the list, you must cancel the VoIP wizard:

- > Press and **hold** the end call key  to return your handset to idle status.
- > Carry out the configuration and the assignment of the send and receive connection using the Web configurator. Further information on this can be found in the long user guide (see enclosed CD).

11 Entering personal VoIP account data

- > To switch between upper and lower case and digits, press the  key (several times if necessary).
- > Characters entered incorrectly can be deleted using the left display key . The character to the left of the cursor is deleted.
- > You can navigate within the input field using the control key  (press right/left).

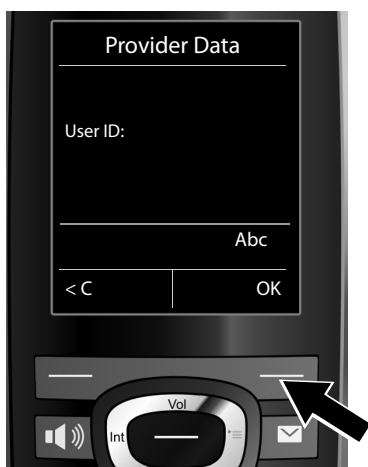

- > Using the number keys, enter the authentication name (user identification) that you received from your VoIP provider. This entry is case-sensitive.
- > Press the right display key **OK**.



- > Using the number keys, enter the authentication password that you received from your provider. This entry is case-sensitive.
- > Press the right display key **OK**.

Depending on your provider, you may be prompted to enter another name (**User name**). Enter it as described above.

If the **User name** is identical to the **User ID**, you only need to press the right display key **OK**.

Assigning the send/receive connection

Once you have entered all the VoIP data fully and correctly, the message "Your IP account is registered with your provider." will appear in the display after a short time. The VoIP wizard is closed.

12 Starting the connection wizard

To call other parties using the newly configured VoIP connection (e.g. IP1), you must assign the connection to one or more of the registered handsets as a send connection.

Default assignment: The VoIP connection is assigned to every registered handset and to the integrated answering machine as a receive connection (incoming calls can be received). It is not assigned to any handset as a send connection.

The following is shown in the display:

a.

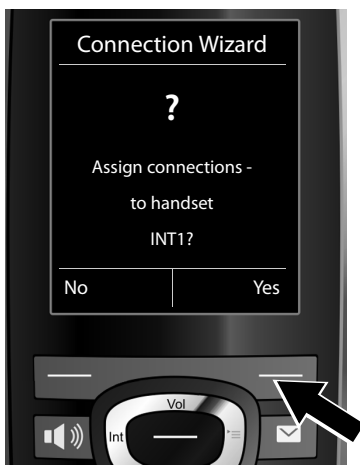

- > Press the display key **Yes** if you wish to change the setting for the send and receive connections of the handset with the internal name INT1.
- > Press the display key **No** if you do not wish to change the setting for this handset.

b.



The list of receive connections currently assigned is displayed.

Press down on the control key  to scroll through the list if necessary.

- > Press the display key **Change** if you wish to change the receive connection setting.
- > Press the display key **OK** if you do not wish to change the setting. The following steps are skipped. Continue from e.

Assigning the send/receive connection

c.

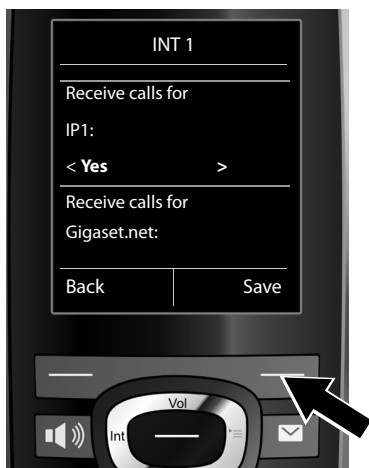

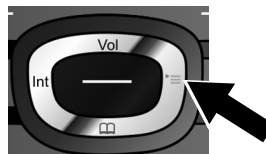

If no calls to the VoIP connection **IP1** are to be signalled on the handset:

- > Press **right** on the control key  to set to **No**.

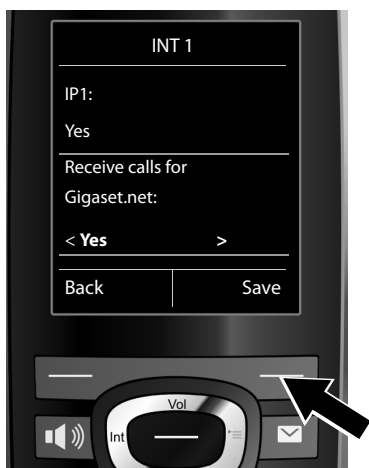

d.



- > Press **down** on the control key  to switch to the next connection. Select either **Yes** or **No** as described above.
- > Repeat the steps for each connection.
- > Press the display key **Save** once you have finished configuring the settings for the handset.

The updated list of receive connections is displayed one more time for you to check. Press the display key **OK** to confirm the assignment.

Assigning the send/receive connection

e.



The send connection currently set for the handset is displayed: **Fixed Line**.

- > Press the display key **OK** if you do not wish to change the setting. Skip the following step.
- > To change the setting, press the display key **Change**.

f.



Which connection/phone number should the handset use to make a call:

- > Press **right** on the control key  repeatedly, until the required connection is displayed (in the example, **IP1**).

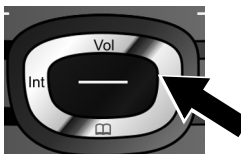

- > Press the display key **Save** to save the settings.

Instead of a fixed connection, you can also select **Sel. at each call**. Each time you make a call, you can then select the connection you wish to use.

You can go on to initially start the connection wizard for each additional handset registered to the base. The following is displayed in sequence for each handset:

Assign connections to handset xxx?

- > Carry out steps a. to f. (see above) for each registered handset.

Assigning the send/receive connection

On the Gigaset C595 IP:

You can then start the connection wizard for the three Gigaset answering machines. For each answering machine, the following will be shown in the display:

Assign connections to answering machine ?

> Carry out steps **a.** to **d.** (see above) for the individual answering machines to assign individual base connections to the answering machines.

Please note:

Each connection may only be assigned to one of the three integrated answering machines as a receive connection. If you assign a receive connection to an answering machine and this connection is already assigned to another answering machine, the "old" assignment is deleted.

Completing the installation

After successfully configuring the settings, **Connection assignment complete** is displayed briefly. Afterwards, the handset returns to idle status (an example of the display in idle status):



The following are displayed:

Reception between the base and the handset:
good to low: no reception: (red)

Charge status of the batteries:

(Empty to full)

Flashes red: batteries almost empty

(Charging)

INT 1: Internal name of the handset

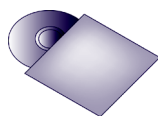

You can configure five additional VoIP connections (VoIP phone numbers) on your Gigaset. The long user guide for your phone (see enclosed CD) contains detailed information on setting up the device, configuring new connections and operating the phone, as well as possible solutions to frequently asked questions and common problems.



To ensure that you can always be reached via the Internet, the router must be permanently connected to the Internet.

Gigaset.net directory entry

Entering your name in the Gigaset.net directory

Gigaset.net* is a VoIP service provided by Gigaset Communications GmbH, which you can use to make **free calls** to other Gigaset VoIP users.

The **first** time you open the Gigaset.net directory, complete the following steps and an entry will be created in the Gigaset.net directory for you:

- > Press and **hold** the control key .
- > Press down on the control key  repeatedly until **Gigaset.net** is selected.
- > Press the display key **OK**.

A connection to the Gigaset.net online directory is established. You will see the following display:



- > Using the number keys, enter the name that you would like to be listed under in the Gigaset.net directory**.
- > Press the right display key **Save**.

If an entry already exists with this name, the message "**Nickname already exists. Please change.**" will appear. You will be prompted to enter a name again.

* Exclusion of liability

Gigaset.net is a voluntary service provided by Gigaset Communications GmbH with no liability or guarantee for the availability of the network. This service can be terminated at any time with a notice period of three months.

** Data protection notice

Nicknames are stored on a central Gigaset server and displayed in the Gigaset.net directory. You can receive calls from other users of the Gigaset.net service under this nickname. **By entering your data, you agree to having your data saved.** If you do not wish this to happen, you can cancel the operation by pressing the right display key **Save** without making an entry.

Further information about saving Gigaset.net service data can be found at www.gigaset.net/privacy-policy.

Making calls / operating the answering machine

Making calls





- > Enter a phone number using your handset's number keys.
Please note that, even with local calls, you must always dial the area code for calls via VoIP (provider-dependent).
- > Press the talk key .
- > If you have assigned the handset a **fixed send connection** (default assignment: fixed line connection), the number will be dialled via this send connection.

Or

- > If you have assigned the handset **Sel. at each call**, the list of connections for your phone will be displayed (**Fixed Line, IP1** etc.).
- > Select a send connection and press the talk key ; the number will be dialled via the selected send connection.

Operating the Gigaset C595 IP answering machine



Switching the answering machine on/off

- > Press right on the control key  to open the menu.
- > Press down on the control key  to select the  symbol and then press the display key **OK**.
- > Press down on the control key  to select the **Activation** function and then press the display key **OK**.

If you have assigned multiple integrated answering machines to the phone's connections, a list of answering machines is displayed, to which at least one phone connection is assigned as a receive connection. An answering machine is activated if it is marked with ✓. Use the control key  to select an answering machine and press the display key **OK**.

- > Use the control key  (press right/left) to select **On** or **Off**; this activates or deactivates answer and record mode (default setting) for the answering machine.
- > Press the display key **Save**.

Listening to messages

- > Press the message key . Select one of the answering machine lists (**Ans. Mach. 1, Ans. Mach. 2, Ans. Mach. 3**) using the control key  (press down) and press the display key **OK**.

Message playback starts.

FCC / ACTA Information

Industry Canada Certification

Operation is subject to the following two conditions (1) this device may not cause interference, and (2) this device must accept any interference, including interference that may cause undesired operation of the device.

NOTICE: The Industry Canada label identifies certified equipment. This certification means that the equipment meets certain telecommunications network, protective, operational and safety requirements as prescribed in the appropriate Terminal Equipment Technical Requirements document(s). The Department does not guarantee the equipment will operate to the user's satisfaction.

Before installing this equipment, users should ensure that it is permissible to be connected to the facilities of the local telecommunications company. The equipment must also be installed using an acceptable method of connection. The customer should be aware that compliance with the above conditions may not prevent degradation of service in some situations.

Repairs to certified equipment should be coordinated by a representative designated by the supplier.

Any repairs or alterations made by the user to this equipment, or equipment malfunctions, may give the telecommunications company cause to request the user to disconnect the equipment.

Users should ensure for their own protection that the electrical ground connections of the power utility, telephone lines and internal metallic water pipe system, if present, are connected together.

This precaution may be particularly important in rural areas

NOTE: Users should not attempt to make such connections themselves, but should contact the appropriate electric inspection authority, or electrician, as appropriate.

This product meets the applicable Industry Canada technical specifications.

The Ringer Equivalence Number is an indication of the maximum number of devices allowed to be connected to a telephone interface. The termination of an interface may consist of any combination of devices subject only to the requirement that the sum of the RENs of all devices does not exceed five.

This Class B digital apparatus complies with Canadian ICES-003.

Cet appareil numérique de la classe B est conforme à la norme NMB-003 du Canada.

FCC / ACTA Information

Warning: Changes or modifications to this unit not expressly approved by Gigaset Communications USA LLC could void the FCC authority to operate the equipment. This includes the addition of any external antenna device.

This equipment complies with Part 68 of the FCC rules and the requirements adopted by the ACTA. On the bottom of the base station is a label that contains, among other information, a product identifier in the format US:AAAEQ##TXXXX. If requested, this number must be provided to the telephone company.

A plug and jack used to connect this equipment to the premises wiring and telephone network must comply with the applicable FCC Part 68 rules and requirements adopted by the ACTA. A compliant telephone cord and modular plug is provided with this product. It is designed to be connected to a compatible modular jack that is also compliant. See installation instructions for details.

The REN is used to determine the number of devices that may be connected to a telephone line. Excessive RENs on a telephone line may result in the devices not ringing in response to an incoming call. In most but not all areas, the sum of RENs should not exceed five (5.0). To be certain of the number of devices that may be connected to a line, as determined by the total RENs, contact the local telephone company. For products approved after July 23, 2001, the REN for this product is part of the product identifier that has the format US:AAAEQ##TXXXX. The digits represented by ## are the REN without a decimal point (e.g., 03 is a REN of 0.3). For earlier products, the REN is separately shown on the label.

A copy of the supplier's Declaration of Conformity (SDoC) is available at this Internet address: www.gigaset.com/docs.

If this equipment causes harm to the telephone network, the telephone company will notify you in advance, that temporary discontinuance of service may be required. But if advance notice isn't practical, the telephone company will notify the customer as soon as possible. Also, you will be advised of your right to file a complaint with the FCC if you believe it is necessary.

The telephone company may make changes in its facilities, equipment, operations or procedures that could affect the operation of the equipment. If this happens the telephone company will provide advance notice in

FCC / ACTA Information

order for you to make necessary modifications to maintain uninterrupted service. If you experience trouble with this telephone system, disconnect it from the network until the problem has been corrected or until you are sure that the equipment is not malfunctioning.

If trouble is experienced with this equipment, for repair or warranty information, please contact Support at 1-866-247-8758. If the equipment is causing harm to the telephone network, the telephone company may request that you disconnect the equipment until the problem is resolved. This equipment is of a type that is not intended to be repaired by the Customer (user).

This telephone system may not be used on coin service provided by the telephone company. Connection to party line service is subject to state tariffs. Contact the state public utility commission, public service commission or corporation commission for information. Privacy of communications may not be ensured when using this phone.

If your home has specially wired alarm equipment connected to the telephone line, ensure the installation of this equipment does not disable your alarm equipment. If you have questions about what will disable alarm equipment, consult your telephone company or a qualified installer.

This telephone system equipment has been tested and found to comply with the limits for Class B digital device, pursuant to Part 15 of the FCC Rules. Operation is subject to the following two conditions: (1) This device may not cause harmful interference, and (2) This device must accept any interference received, including interference that may cause undesired operation. These limits are designed to provide reasonable protection against harmful interference in a residential installation. Some cordless telephones operate at frequencies that may cause interference to nearby TV's and VCR's; to minimize or prevent such interference, the system base should not be placed near or on top of a TV or VCR; and, if interference is experienced, moving the base farther away from the TV or VCR will often reduce or eliminate the interference.

However, there is no guarantee that interference will not occur in a particular installation. If this telephone system does cause harmful interference to radio or television reception, which can be determined by turning the system off and on, the user is encouraged to try to correct the interference by one or more of the following measures:

1. Reorient or relocate the receiving antenna.
2. Increase the separation between the base station and receiver.
3. Connect the base station into an outlet on a circuit different from that to which the receiver is connected.
4. Consult the dealer or an experienced radio TV technician for help.

Notice for Direct Inward Dialing ("DID")

ALLOWING THIS EQUIPMENT TO BE OPERATED IN SUCH A MANNER AS TO NOT PROVIDE FOR PROPER ANSWER SUPERVISION IS A VIOLATION OF PART 68 OF THE FCC'S RULES.

Notice to Hearing Aid Wearers:

This phone system is compatible with inductively coupled hearing aids.

Power Outage:

In the event of a power outage, your cordless telephone will not operate. The cordless telephone requires electricity for operation. You should have a telephone that does not require electricity available for use during power outages.

Notice:

The installation of the base unit should allow at least 8 inches between the base and persons to be in compliance with FCC RF exposure guidelines.

For body worn operation, the portable part (handset) has been tested and meets FCC RF exposure guidelines. Use with an accessory that contains metal parts may not ensure compliance with FCC RF exposure guidelines.

Notice to telephone company service:

If you need service from your telephone company, please provide them with the information

- Facility interface Code (FIC)
- Service Order Code (SOC)
- Universal Service Order Code (USOC)

as indicated on the label on the bottom side of the base station.

Safety precautions

Before using your telephone equipment, basic safety instructions should always be followed to reduce the risk of fire, electric shock and injury to persons.

1. Read and understand all instructions.
2. Follow all warnings and instructions marked on the product.
3. Unplug this product from the wall telephone jack and power outlet before cleaning. Do not use liquid cleaners or aerosol cleaners. Use damp cloth for cleaning.
4. Do not use this product near water, for example, near a bathtub, wash bowl, kitchen sink, or laundry tub, in a wet basement or near a swimming pool.
5. Place this product securely on a stable surface. Serious damage and/or injury may result if the unit falls.
6. Slots or openings in the cabinet and the back and bottom are provided for ventilation, to protect it from over-heating. These openings must not be blocked or covered. This product should never be placed near or over a radiator or heat register, or in a place where proper ventilation is not provided.
7. This product should be operated only from the type of power source indicated on the marking label. If you are not sure of the type of AC line power to your home, consult your dealer or local power company.
8. Do not place objects on the power cord. Install the unit where no one can step or trip on the cord.
9. Do not overload wall outlets and extension cords as this can result in the risk of fire or electric shock.
10. Never push objects of any kind into this product through cabinet slots as they may touch dangerous voltage points or short out parts that could result in the risk of fire or electric shock. Never spill liquid of any kind on this product.
11. To reduce the risk of electric shock or burns, do not disassemble this product. Take it to a qualified service center when service is required. Opening or removing covers may expose you to dangerous voltages, dangerous electrical current or other risks. Incorrect reassembly can cause electric shock when the appliance is subsequently used. Disconnect TNV circuit connector before removing cover.
12. Unplug the product from the wall outlet and refer servicing to qualified service personnel under the following conditions:
 - a.) When the power cord is damaged or frayed.
 - b.) If liquid has been spilled into the product.
 - c.) If the product has been exposed to rain or water.
 - d.) If the product does not operate normally by following the operating instructions. Adjust only those controls that are covered by the operating instructions because improper adjustment of other controls may result in damage and may require extensive work by a qualified technician to restore the product to normal operation.
 - e.) If the product has been dropped or physically has been damaged.
 - f.) If the product exhibits a distinct change in performance.
13. Avoid using a telephone (other than a cordless type) during a thunderstorm. There may be a remote risk of electrical shock from lightning. Therefore we suggest a surge arrester.
14. Do not use the telephone to report a gas leak in the vicinity of the leak.
15. Emergency/911 numbers may not be dialed if the keypad is locked.
16. Minimum No. 26 AWG telecommunication line cord must be used with this phone.



ETL LISTED
 CONFORMS TO
 ANSI/UL STD 60950-1
 CERTIFIED TO
 CAN/CSA C22.2 No.60950-1

Service (Customer Care)

BATTERY SAFETY PRECAUTIONS

To reduce the risk of fire, injury or electric shock, and to properly dispose of batteries, please read and understand the following instructions.

CONTAINS NICKEL METAL HYDRIDE BATTERY. BATTERY MUST BE RECYCLED OR DISPOSED OF PROPERLY. DO NOT DISPOSE OF IN MUNICIPAL WASTE.

1. Only use the batteries specified for use with this product.
2. DO NOT USE NICKEL CADMIUM OR LITHIUM BATTERIES, or mix batteries of different sizes or from different manufacturers in this product. DO NOT USE NONRECHARGEABLE BATTERIES.
3. Do not dispose of the batteries in a fire; the cells may explode. Do not expose batteries to water. Check with local codes for special disposal instructions.
4. Do not open or mutilate the batteries. Released electrolyte is corrosive and may cause damage to the eyes or skin. The electrolyte may be toxic if swallowed.
5. Exercise care in handling the batteries in order not to short the batteries with conducting materials such as rings, bracelets, and keys. The batteries or conducting material may overheat and cause burns or fire.
6. Charge the batteries provided with, or identified for use with, this product only in accordance with the instructions and limitations specified in the user's manual. Do not attempt to charge the batteries with any means other than that specified in the users manual.
7. Periodically clean the charge contacts on both the charger and handset.

Service (Customer Care)

Customer Care Warranty for Cordless Products
To obtain Customer Care Warranty service,
product operation information, or for problem resolution, call:
Toll Free: 1-866 247-8758

End-user limited warranty

This product is covered by a one year limited warranty. Any repair replacement or warranty service, and all questions about this product should be directed to: 1-866 247-8758.

This limited, non-transferable warranty is provided to the original buyer/end-consumer ("you") for systems, handsets and accessories (collectively, "Product") provided by Gigaset Communications USA LLC or Gigaset Communications Canada Inc. (collectively "Gigaset NAM"). Gigaset NAM warrants to you that at the date of purchase, the Product is free of defects in workmanship and materials and the software included in the Product will perform in substantial compliance to its program specifications.

1. WARRANTY PERIOD

The Product warranty period is one (1) year from the original date of purchase by you. Proof of purchase (e.g., sales slip or invoice) must be provided with any Product returned during the warranty period. Batteries supplied with the Products are warranted to be free from defects at the time of purchase only.

2. EXCLUSIVE REMEDY

Gigaset NAM's entire liability and your exclusive remedy if the Product is defective in materials or workmanship during the warranty period and is returned shall be that the Product will be repaired or replaced as set forth in Section 4 below. Reconditioned replacement components, parts or materials may be used in the replacement or repair. Data in the memory of the Product may be lost during repair.

Service (Customer Care)

3. THIS LIMITED WARRANTY DOES NOT COVER AND IS VOID WITH RESPECT TO THE FOLLOWING:

- Cosmetic damage, physical damage to the surface of the Product, including, without limitation, breakage, cracks, dents, scratches or adhesive marks on the LCD screen or outside casing of the Product.
 - Products which have been repaired, maintained or modified (including the antenna) by anyone other than Gigaset NAM or a Gigaset NAM-approved repair facility, or that have been improperly installed.
 - Cost of installation, removal or reinstallation.
 - Damage due to any telephone, electronic, hardware or software program, network, Internet or computer malfunctions, failures, or difficulties of any kind, including without limitation, server failure or incomplete, incorrect, garbled or delayed computer transmissions.
 - Equipment and components not manufactured, supplied or authorized by Gigaset NAM.
 - Modification of the Product's components, or operation of the Product in an unsuitable environment or in a manner for which it is not intended, including but not limited to failures or defects caused by misuse, abuse, accidents, physical damage, abnormal operation, improper handling or storage, neglect, alterations, unauthorized installation, removal or repairs, failure to follow instructions, problems caused by the carrier's network coverage, exposure to fire, water or excessive moisture or dampness, floods, or extreme changes in climate or temperature, acts of God, riots, acts of terrorism, spills of food or liquids, viruses or other software flaws introduced into the Product or other acts which are not the fault of Gigaset NAM and which the Product is not specified to tolerate, including damage caused by mishandling or blown fuses.
 - Products which have had warranty stickers, electronic serial number and/or serial number label removed, altered, rendered illegible or fraudulently applied to other equipment.
 - Signal reception problems (unless caused by defect in material or workmanship in the Product).
 - Products operated outside published maximum ratings.
 - Performance of the Products when used in combination with other products or equipment not manufactured, supplied or authorized by Gigaset NAM.
 - Consumables (such as batteries and fuses).
 - Payments for labor or service to representatives or service centers not authorized to perform product maintenance by Gigaset NAM.
 - Loss of data.
 - Testing and examination discloses that the alleged defect or malfunction in the Product does not exist.
- This warranty does not cover customer education, instruction, installation or removal, set up adjustments, problems related to service(s) provided by a carrier or other service provider, and/or signal reception problems. Gigaset NAM shall not be responsible for software, firmware, information, or memory data contained in, stored on, or integrated with any Products returned for repair, whether under warranty or not. This warranty is valid only in the country in which it is purchased (*i.e.*, the United States of America or Canada respectively, but not both).

USE WITH ACCESSORIES NOT SUPPLIED BY GIGASET NAM OR NOT OTHERWISE EXPRESSLY AUTHORIZED BY GIGASET NAM MAY VOID WARRANTY.

4. WARRANTY CLAIM PROCEDURE

All warranty claims must be made by notifying Gigaset NAM prior to the expiration of the warranty period. Gigaset NAM's obligation to provide warranty support shall not extend past the end of the warranty period, except that any product repaired or replaced during the warranty period shall continue to be warranted for the balance of such warranty period or thirty (30) days, whichever is greater.

Support service will be provided for you by accessing the toll free customer service number:

1-866 247-8758

Service (Customer Care)

5. LIMITATION OF WARRANTY

Gigaset NAM makes no warranty or representation that the software in the Products will meet your requirements or will work in combination with any hardware or applications software products provided by third parties, that the operation of the software will be uninterrupted or error free, or that all defects in the software products will be corrected.

6. LIMITATION ON REMEDIES; NO CONSEQUENTIAL OR OTHER DAMAGES

Your exclusive remedy for any breach of this limited warranty is as set forth above. Except for any refund elected by Gigaset NAM, **YOU ARE NOT ENTITLED TO ANY DAMAGES, INCLUDING BUT NOT LIMITED TO CONSEQUENTIAL DAMAGES**, if the Product does not meet the limited warranty, and, to the maximum extent allowed by applicable law, even if any remedy fails of its essential purpose. The terms below ("Exclusion of Incidental, Consequential and Certain Other Damages") are also incorporated into this limited warranty. Some states/jurisdictions/provinces do not allow the exclusion or limitation of incidental or consequential damages, so the above limitation or exclusion may not apply to you. This limited warranty gives you specific legal rights. You may have others which vary from state/jurisdiction/province to state/jurisdiction/province.

7. DISCLAIMER OF WARRANTIES

GIGASET NAM AND ITS SUPPLIERS PROVIDE THE PRODUCT AND SUPPORT SERVICES (IF ANY) AS IS AND WITH ALL FAULTS. THE LIMITED WARRANTY IS IN LIEU OF ANY OTHER EXPRESS WARRANTIES (IF ANY) CREATED BY ANY DOCUMENTATION OR PACKAGING EXCEPT FOR THE LIMITED WARRANTY, AND TO THE MAXIMUM EXTENT PERMITTED BY APPLICABLE LAW IS IN LIEU OF ANY IMPLIED OR STATUTORY WARRANTIES, INCLUDING, BUT NOT LIMITED TO, THE IMPLIED WARRANTIES OF MERCHANTABILITY AND FITNESS FOR A PARTICULAR PURPOSE, OF ACCURACY OR COMPLETENESS OR RESPONSES, OF RESULTS, OF WORKMANLIKE EFFORT, OF LACK OF VIRUSES AND OF LACK OF NEGLIGENCE, ALL WITH REGARD TO THE PRODUCT, AND THE PROVISION OF OR FAILURE TO PROVIDE SUPPORT SERVICES. ALSO, THERE IS NO WARRANTY OR CONDITION OF TITLE, QUIET ENJOYMENT, QUIET POSSESSION, OR CORRESPONDENCE TO DESCRIPTION OR NONINFRINGEMENT WITH REGARD TO THE PRODUCT. Some states/jurisdictions/provinces do not allow limitations on how long an implied warranty lasts or the exclusion or limitation of incidental or consequential damages, so the above exclusions or limitations may not apply to you. If an implied warranty or condition is created by your state/province and federal or state/provincial law prohibits disclaimer of it, you also have an implied warranty or condition, BUT ONLY AS TO DEFECTS DISCOVERED DURING THE PERIOD OF THIS LIMITED WARRANTY (ONE YEAR). AS TO ANY DEFECTS DISCOVERED AFTER THE ONE YEAR PERIOD, THERE IS NO WARRANTY OR CONDITION OF ANY KIND. This limited warranty gives you specific legal rights, and you may also have other rights which vary from state to state/province to province. In no event shall Gigaset NAM's liability exceed the cost of repairing or replacing defective Products as provided herein, and any such liabilities will terminate upon expiration of the warranty period.

Any supplements or updates to the Product or the software in the Product, including without limitation, any (if any) software fixes or upgrades or bug fixes provided to you after the expiration of the one year limited warranty period are not covered by any warranty or condition, express, implied or statutory.

8. EXCLUSION OF INCIDENTAL, CONSEQUENTIAL AND CERTAIN OTHER DAMAGES

TO THE MAXIMUM EXTENT PERMITTED BY APPLICABLE LAW, IN NO EVENT SHALL GIGASET NAM, SELLER OR THEIR SUPPLIERS BE LIABLE FOR ANY SPECIAL, INCIDENTAL, INDIRECT, OR CONSEQUENTIAL DAMAGES WHATSOEVER (INCLUDING, BUT NOT LIMITED TO, DAMAGES FOR LOSS OF PROFITS OR CONFIDENTIAL OR OTHER INFORMATION, FOR BUSINESS INTERRUPTION, FOR PERSONAL INJURY, FOR LOSS OF PRIVACY, FOR FAILURE TO MEET ANY DUTY INCLUDING OF GOOD FAITH OR OF REASONABLE CARE, FOR NEGLIGENCE, AND FOR ANY OTHER PECUNIARY OR OTHER LOSS WHATSOEVER) ARISING OUT OF OR IN ANY WAY RELATED TO THE USE OF OR INABILITY TO USE THE PRODUCT, THE PROVISION OF OR FAILURE TO PROVIDE SUPPORT SERVICES, OR OTHERWISE UNDER OR IN CONNECTION WITH ANY PROVISION OF THIS LIMITED WARRANTY, EVEN IN THE EVENT OF THE FAULT, TORT (INCLUDING NEGLIGENCE), STRICT LIABILITY, BREACH OF CONTRACT OR BREACH OF WARRANTY OF GIGASET NAM OR SELLER OR ANY SUPPLIER, AND EVEN IF GIGASET NAM OR SELLER OR ANY SUPPLIER HAS BEEN ADVISED OF THE POSSIBILITY OF SUCH DAMAGES. REPAIR OR REPLACEMENT, AS PROVIDED UNDER THE WARRANTY, IS YOUR SOLE AND EXCLUSIVE REMEDY FOR BREACH OF THE LIMITED WARRANTY.

Service (Customer Care)

9. LIMITATION OF LIABILITY AND REMEDIES

NOTWITHSTANDING ANY DAMAGES THAT YOU MIGHT INCUR FOR ANY REASON WHATSOEVER (INCLUDING, WITHOUT LIMITATION, ALL DAMAGES REFERENCED ABOVE AND ALL DIRECT OR GENERAL DAMAGES), THE ENTIRE LIABILITY OF GIGASET NAM, SELLER AND ANY OF THEIR SUPPLIERS UNDER ANY PROVISION OF THIS LIMITED WARRANTY AND YOUR EXCLUSIVE REMEDY FOR ALL OF THE FOREGOING (EXCEPT FOR ANY REMEDY OF REPAIR OR REPLACEMENT ELECTED BY GIGASET NAM OR SELLER OR SUPPLIER WITH RESPECT TO ANY BREACH OF THE LIMITED WARRANTY) SHALL BE LIMITED TO THE GREATER OF THE AMOUNT ACTUALLY PAID BY YOU FOR THE PRODUCT OR FIVE DOLLARS (\$5.00 USD/CAN). THE FOREGOING LIMITATIONS, EXCLUSIONS AND DISCLAIMERS SHALL APPLY TO THE MAXIMUM EXTENT PERMITTED BY APPLICABLE LAW, EVEN IF ANY REMEDY FAILS ITS ESSENTIAL PURPOSE.

10. GOVERNING LAW

If this Product was purchased in the United States of America this limited warranty will be governed by the laws of Texas, and exclude the United Nations Convention on Contracts for the International Sale of Goods. If this Product was purchased in Canada this limited warranty will be governed by the laws of the Province of Ontario and the federal laws of Canada applicable therein, and exclude the United Nations Convention on Contracts for the International Sale of Goods.

If you want to learn more about Gigaset Service or for Support on your Gigaset phone, visit our web site at <http://www.gigaset.com> or please call 1-866 247-8758.

Issued by

Gigaset Communications GmbH

Frankenstr. 2a, D-46395 Bocholt

Manufactured by Gigaset Communications GmbH under trademark license of Siemens AG.

© Gigaset Communications GmbH 2010

All rights reserved.

Subject to availability. Rights of modifications reserved.

Product attributes subject to change.

We reserve the right, to make changes without notice in equipment design and/or components.

Part Number: A31008-M2215-R301-1-6043

© Copyright 2010.

Issued by

Gigaset Communications GmbH

Frankenstr. 2a, D-46395 Bocholt

Manufactured by Gigaset Communications GmbH

under trademark license of Siemens AG.

As of 1 Oct. 2011 Gigaset products bearing the trademark 'Siemens' will exclusively use the trademark 'Gigaset'.

© **Gigaset Communications GmbH 2010**

All rights reserved. Subject to availability.

Rights of modification reserved.

www.gigaset.com

This user guide is made from 100% recycled paper.