

Congratulations

Congratulations on your purchase of the Siemens Gigaset E45 telephone system! This phone's DECT6.0 frequency standard and high-speed digital voice encoding provide reception and voice clarity that is superior to other cordless phones. And, its digital spread spectrum technology will provide you with secure, private conversations.



**DO NOT RETURN
THIS PRODUCT TO THE
STORE!**

Please read the following important information.

For Siemens Customer Care, product operation information, or for problem resolution, call toll-free

1-888-777-0211

9 a.m. to 8 p.m. Central Standard Time Monday-Saturday

SIEMENS

www.my-siemens.com

Register now!

It's fast progress in the world of communication. Register today for the world of Siemens Communications on "my-siemens.com" and stay current with customized information on Siemens latest products and applications.

Please go to: www.icm.siemens.com/register

Contents

Congratulations	1
Handset at a glance	2
Safety precautions	4
Gigaset E45 – a handset with many extras	5
First Steps	5
Pack contents	5
Setting up the handset for use	5
Making calls	8
Making an external call	8
Ending a call	8
Answering a call	8
Handsfree operation	9
Muting	9
Making internal calls	9
Operating the handset	9
Switching the handset on/off	9
Activating/deactivating the keypad lock	9
Control key	10
Display keys	10
Returning to idle status	11
Menu guidance	11
Correcting incorrect entries	11
Using the directory and lists ...	11
Directory and call-by-call list	11
Last number redial list	14
Opening lists with the message key	14
Using a handset as a room monitor	14
Activating the room monitor and entering the number to be called ...	15
Handset settings	16
Changing the display language	16
Setting the display	16
Setting the screen picture	16
Setting display illumination	17
Activating/deactivating auto answer .	17
Adjusting the loudspeaker volume ..	17
Changing ringtones	17

Activating/deactivating advisory tones	18
Setting the alarm clock	19
Restoring the handset default settings	19
Appendix	20
Care	20
Contact with liquid	20
Questions and answers	20
Troubleshooting	20
Specifications	21
FCC	22
Industry Canada Certification	22
Safety precautions	23
Notes on the operating instructions	26
Symbols used	26
Example: menu input	26
Example: multiple line input	27
Writing and editing names	27
Accessories	28
Index	29

Safety precautions

Safety precautions^{*)}



Only use the **power supply unit supplied** as indicated on the underside of the device.



Only insert **approved rechargeable batteries of the same type**.
Never use ordinary (non-rechargeable) batteries as they may pose a health hazard or cause injury.



Make sure the rechargeable battery is inserted the right way round.



Use the battery specified in these operating instructions.



The phone may affect medical equipment so always switch your phone off before entering hospitals or doctors' practices.



The handset may cause an unpleasant humming noise in hearing aids.



Do not operate the phone in places where there is a risk of explosion (such as paint workshops).



The handset is not splash-proof (see page 20).



Drivers must not use the phone while driving.



The phone must be switched off at all times in an aircraft. Make sure it cannot be switched on accidentally.



If you give your Gigaset to someone else you should also give them the operating instructions.



Dispose of batteries and the phone carefully. Do not pollute the environment.

Emergency numbers cannot be dialed if the keypad lock is activated!

^{*)} see also page 23

Gigaset E45 – a handset with many extras

Your Gigaset E45 not only lets you store up to 150 telephone numbers (page 11) – your Gigaset E45 can do much, much more:

- ◆ You can designate important people as VIPs so you can identify important calls from the ringtone (page 12).
- ◆ You can store anniversary dates (page 13) in your phone and it will remind you of them in advance.
- ◆ Select frequently used phone numbers at the press of a **single** key (page 13).
- ◆ Select 12 or 24-hour format for displaying the time (page 8).

Have fun using your new Gigaset E45!

First Steps

Pack contents

- ◆ one Gigaset E45 handset,
- ◆ one charging cradle (incl. power adapter),
- ◆ one battery pack,
- ◆ one battery cover,
- ◆ one lock ring,
- ◆ one belt clip,
- ◆ one headset socket cover,
- ◆ one user guide.

Gigaset E45 – a handset with many extras

Setting up the handset for use

Connecting up the charging cradle and mounting it on the wall (if required) is described at the end of these instructions.

Fitting the battery pack

Caution:

Use only the rechargeable battery pack recommended by Siemens (page 21). On no account may a conventional (non-rechargeable) battery pack or other type of battery be used, as this may cause significant damage to health and property – the outer casing of the battery or battery pack could be destroyed or the battery pack could explode. The phone could also malfunction or be damaged as a result of using batteries that are not of the recommended type. Use of battery packs not authorized by Siemens may void the warranty on this product.

- ▶ Fit the plug into the socket.
- ▶ Insert the battery pack.
- ▶ Place the cords in the cord routing.

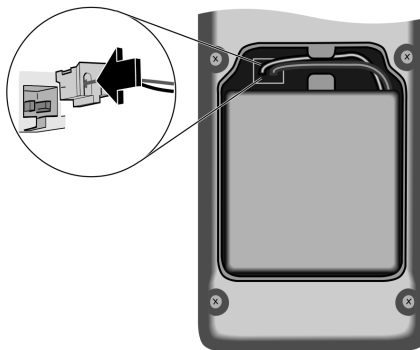

First Steps

Closing the battery cover

- ▶ Hold the battery cover at a slight angle and install the two lower clips into the casing first. Then close the cover, press on the top so that it clicks into place.

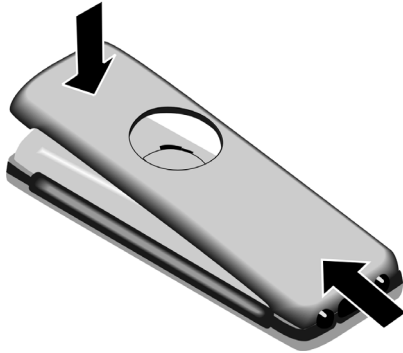

Locking the battery cover

Insert the catches on the lock ring or belt clip into the notches in the casing and make sure that the arrow markings on the casing are aligned with those on the bottom of the ring. Turn the lock ring or belt clip clockwise to the end stop. When both holes are horizontally aligned with the upper edge of the handset the lock ring is closed.

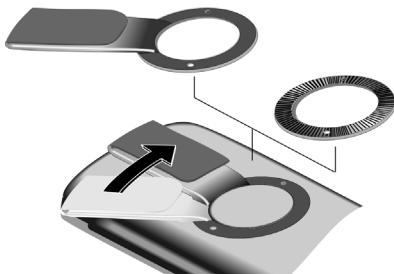

Opening the battery cover

Position both thumbs on the lock ring and simultaneously turn the lock ring or belt clip anticlockwise and remove.

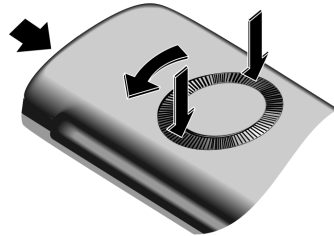

- ▶ Insert a coin into the cavity at the top of the battery cover and twist it until the cover opens.

Registering your phone

Before you can use your Gigaset E45 you must register it to a base station. It can be registered to a maximum of four base stations. The actual registration procedure will depend on the type of base station.

Automatic registration Gigaset E45 to Gigaset E450

Important: The handset must not yet be registered to any base station.

Registering the handset to the Gigaset E450 base station occurs automatically. (For the E455 base station you need to register your handset manually, see page 7.)

- ▶ Place the handset in the base with its **display facing outwards**.

Registration takes around 1 minute. During this process, **Regstr.Procedure** appears in the display and the name of the base station flashes, for example **Base 1**. When the handset has been registered, its screen displays its internal number, for example **INT 2** for internal number 2. The handset is assigned the lowest available internal intercom number (1-6). If all internal numbers 1-6 have been assigned, number 6 is overwritten, provided the

handset with the internal number 6 is in idle status.

Notes:

- Automatic registration is not possible when the base station on which you wish to register the handset is being used to make a call.
- Each key press interrupts the automatic registration.
- If automatic registration does not work, you will have to register the handset manually.

Manual registration of the Gigaset E45

If the handset does not activate automatically when the battery pack is fitted, you must first charge the battery pack.

You must activate manual registration of the handset at both the handset and the base station.

After it has been registered, the handset returns to idle status. The handset's internal number is shown in the display, for example INT 1. If it is not, repeat the procedure.

1. On the handset



→ → Handset → Register H/Set



Select base station, for example **Base 1**, and press **OK**.



Enter the system PIN of the base station (the default is 0000) and press **OK**. The screen will display the number, for example **Base 1**.

2. On the base station

Within 60 secs. press and **hold** the registration/paging key on the base station (page 2) (approx. 3 secs.).

Headset socket

Most headsets with standard 2.5mm mini plugs are compatible with this handset.

If you do not connect a headset, please insert the cover supplied for the headset socket to support the splash proof feature.

Charging the battery pack

- ▶ Plug the power adapter of the charging cradle into an electrical outlet.
- ▶ Place the handset in the base with its display facing forward.

To charge the battery pack, leave the handset in the charging cradle. If the handset is activated, the flashing battery icon  in the top right of the display indicates that the battery pack is being charged. During handset operation, the battery icon indicates the charge status of the battery pack (page 2).

Initial charging and discharging of the battery pack

The correct charge status can only be displayed if the battery pack is first fully charged **and** discharged.

- ▶ To do this, leave the handset in the charging cradle **continuously** for **ten** hours. Your handset need not be switched on for it to charge.
- ▶ Afterwards, remove the handset from the charging cradle and do not put it back again until the battery pack is fully discharged.

Notes:

- The handset should only be placed in a base station or charging cradle that is designed for it.
- When the handset is in the cradle, it charges even if it is switched off.
- If the handset has switched itself off because the battery has no charge, and it is then placed in the cradle, it will switch itself on automatically.
- After the first battery charge **and** discharge you may replace your handset in the charging cradle after every call.

Making calls

Please remember:

- ◆ Always repeat the charging and discharging procedure if you remove the battery pack from the handset and insert it again.
- ◆ The battery pack may feel warm as it is charging. This is normal.

Setting the date and time

To set the date and time, press the display key **Time** to open the input menu.

To change the time, open the input field via:

 → **Date/Time**

- ▶ Change multiple line input:

Date:

Enter month, day and year in 6-digit format.

Time:

Enter hours and minutes with 4 digits, for example

Time mode:

Choose between 12 and 24-hour time format.

If you have selected the **12-hour** time format, use the display key **am/pm** to switch between am and pm.

Save Press the display key.

Changing the base station

If your handset is registered to more than one base station, you can set it to a particular base station or to the base station that has the best reception (**Best Base**).

 → **Handset** → **Select Base**

 Select one of the registered base stations or **Best Base** and press **OK**.



Making calls

Making an external call

External calls are calls using the public telephone network.

 Enter the number and press the talk key.

Or:

 Press and **hold** the talk key  and then enter the number.

To cancel the dialing operation, press the end call key .

You are shown the duration of the call while the call is in progress.

Notes:

- Dialing using the directory, call-by-call list (page 2, page 11) or last number redial list (page 14) saves time re-entering numbers and network provider access codes ("call-by-call numbers").



Ending a call

 Press the end call key.

Answering a call

The handset indicates an incoming call in three ways: by ringing, by a display on the screen and by the flashing handsfree key .

You can accept the call by:

- ▶ Pressing the talk key .
- ▶ Pressing the handsfree key .

If the handset is in the charging cradle and the **Auto Answer** function is activated (page 17), the call will be answered automatically when you lift the handset from the cradle.

Press the display key **Silence** to mute the ringer without answering the call. You can answer the call as long the call is displayed on the screen.

Handsfree operation

You can activate the speakerphone at any time to provide handsfree operation during a call.

Activating/deactivating handsfree

Activating while dialing

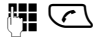

Enter the number and press the talk key.

- ▶ You should inform your caller before you use the handsfree function so that they know someone else is listening.



Switching between earpiece and handsfree mode



Press the handsfree key.

During a call switch handsfree on or off.

If you wish to place the handset in the charging cradle during a call:

- ▶ Press and hold the handsfree key  while placing the handset in the base station. If the handsfree key  does not light up, press the key again.

For how to adjust the volume, see page 17.

Muting

You can deactivate the microphone in your handset during an external call. The other party hears a wait melody.



Press the control key on the left to mute the handset.



Press the display key to reactivate the microphone.

Making internal calls

Internal calls to other handsets registered on the same base station are free.

Calling a specific handset



Initiate internal call.



Enter the number of the handset.

Or:



Initiate internal call.



Select handset.



Press the talk key.

Calling all handsets ("group call")



Initiate internal call.



Press the star key. All handsets are called.

Ending a call



Press the end call key.

Operating the handset

Switching the handset on/off



Press and **hold** the end call key. You will hear the confirmation beep.

Activating/deactivating the keypad lock



Press and **hold** the pound key.

You will hear the confirmation beep. The icon  appears in the display when the keypad lock is activated.

The keypad lock is deactivated automatically if someone calls you. It is re-activated when the call is finished.

Operating the handset



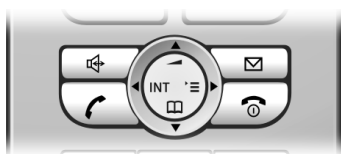

Control key







In the following information the side of the control key (top, bottom, right, left) you have to press in each operating situation is shown in black (e.g.  for "press the right of the control key").

The control key has a number of different functions:





When the handset is in idle status

-  Open the directory.
-  Open main menu.
-  Open list of handsets.
-  Set the ringtones on the handset (page 17).



In the main menu and in input fields

You can use the control key to move the cursor up , down , right  or left .

In lists and submenus

-  /  Scroll up/down line by line.
-  Open submenu or confirm selection.
-  Go back one menu level, or cancel.

During an external call

-  Open the directory.
-  Initiate an internal consultation call.
-  Adjust loudspeaker volume for earpiece and handsfree mode.

Display keys

The function of the display keys changes depending on the particular operating situation. Example:

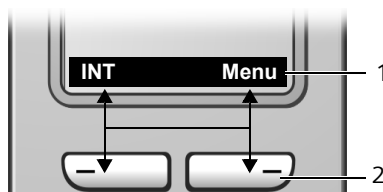







1 Current display key functions are shown in the bottom display line.

2 Display keys

Press the display key below to launch the function.

The most important display symbols are:

-  **Menu** Open the main menu.
-  **Options** Open a context-dependent menu.
-  **<C** Delete key: backspace deletes one character at a time.
-  Go back one menu level, or cancel.
-  **→ □** Copy number into directory.
-  **→ 00** On bases with built-in answering machines: forward external call to the answering machine.
-  **→→** Open the last number redial list (depending on the base station).

Returning to idle status

You can go back to idle status from anywhere in the menu as follows:

- ▶ Press and **hold** the end call key .

Or:

- ▶ Do not press any key: after 2 minutes the display will **automatically** revert to idle status.

Changes that you have not confirmed or saved by pressing **OK**, **Yes**, **Save**, **Send** or **Save Entry** **OK** will be lost.

An example of the display in idle status is shown on page 2.

Menu guidance

Your telephone's functions are accessed using a menu that has a number of levels.

Main menu (first menu level)

- ▶ Press  with the handset in idle status to open the main menu.

The main menu functions are shown in the display as a list with icon and name.

Accessing a function, i.e. opening the corresponding submenu (next menu level):

- ▶ Navigate to the function using the control key . Press the display key **OK**.

Submenus

The functions in the submenus are displayed as lists.

To access a function:

- ▶ Scroll to the function with the control key  and press **OK**.

Or:

- ▶ Enter the corresponding digit combination.

A **short** press on the end call key  returns you to the previous menu level / cancels the operation.

Correcting incorrect entries

You can correct incorrect characters in the text by navigating to the incorrect input using the control key. You can then:

- ◆ press **⏪** to delete the character to the left of the cursor,
- ◆ insert characters to the left of the cursor,
- ◆ overwrite the (flashing) character when entering the time and date etc.
- ◆ **You will find examples of symbols used, menu entries and multiple line input in the appendix to this user guide, page 26.**

Using the directory and lists

You can store a maximum of 150 entries in the directory and call-by-call list (the actual number depends on the size of the individual entries).

You create the directory and call-by-call list for your own individual handset. You can, however, send lists/entries to other handsets or the base station (page 13).

Directory and call-by-call list

In the **directory**, you can store numbers and names associated with them.

- ▶ With the handset in idle status, open the directory by pressing the  key.

The **call-by-call list** is used to store the access codes for network providers (so-called "call-by-call numbers").

- ▶ Open the call-by-call list in idle status by pressing the  key.

Length of entries

Number: max. 32 digits

Name: max. 16 characters

Note:

For quick access to a number from the directory or the call-by-call list (quick dial), you can assign the number to a key.

Using the directory and lists

Storing a number in the directory

 → **New Entry**

▶ Change multiple line input:

Number:

Enter number.

Name:

Enter name.

Annivers.:

Enter anniversary if required (page 13).

Speed Dial:

Select key for quick dial.

▶ Save changes.

Storing a number in the call-by-call list

 → **New Entry**

▶ Change multiple line input:



Number:

Enter number.



Name:

Enter name.

Selecting entries in the directory and call-by-call list

 /  Open directory or call-by-call list.

You have the following options:

- ◆ Use  to scroll through the entries until the required name is selected.
- ◆ Enter the first character of the name, or scroll to the entry with  if required.

Dialing from the directory/call-by-call list

 /  →  (select entry)

 Press the talk key. The number is dialed.

Managing entries in the directory/call-by-call lists

 /  →  (select entry)

Viewing an entry



View Press the display key.
The entry is displayed.
Back with **OK**.

Editing entries

View Edit Press display keys one after the other.

▶ Carry out changes and save.

Using other functions

 /  →  (select entry)
→ **Options** (open menu)

The following functions can be selected with :

Display Number

Edit or add to a stored number.
Then dial or call up further functions by pressing **Options**.

Edit Entry

Edit selected entry.

Delete Entry

Delete selected entry.

VIP Entry (directory only)

Mark a directory entry as **VIP** (Very Important Person) and assign it a particular ringtone. You can then identify VIP calls by their ringtones.

Requirement: Caller ID display ("CIP")

Copy Entry

Send a single entry to a handset (page 13).

Delete List

Managing entries in the directory/call-by-call lists

Copy List (depending on the receiving handset)

Send complete list to a handset (page 13).

Available Memory

Display the available entries in the directory and call-by-call list (page 11).



Using quick dial keys

- ▶ Press and **hold** the required quick dial key.

Sending the directory/call-by-call list to another handset

Requirements:

- ◆ The sending and receiving handsets must both be registered to the same base station.
- ◆ The other handset and base station can send and receive directory entries. Please read the relevant user guide for further information.

 /  →  (select entry)
→ **Options** (open menu)
→ **Copy Entry / Copy List**



Enter the internal number of the receiving handset.
You see **Copying entry**.

Yes / No Press the display key.

A successful transfer is confirmed by a message and confirmation tone on the receiving handset.

Please remember:

- ◆ Entries with identical numbers won't be overwritten on the receiving handset.
- ◆ The transfer will be canceled if the phone rings or if the memory of the receiving handset is full.

Saving an anniversary in the directory

You can store an anniversary for every number in the directory, and specify a time when you will receive a reminder call on the anniversary.

 →  (Select entry; page 12)

View **Edit** Press display keys one after the other.



Scroll to the **Annivers.:** line.

Edit Press the display key.

- ▶ Change multiple line input:

Date:

Enter the month/day in 4-digit format.

Time:

Enter the hour/minute for the reminder call in 4-digit format.

Prompt:



Select the type of signal for the reminder and press **OK**.

- ▶ Save changes (page 27).

Note:

Reminder calls require a time stamp. If you select a visual signal, then a time stamp is not required and is automatically set to 00.00.

Deleting anniversaries

 →  (Select entry; page 12)

View **Edit** Press display keys one after the other.



Scroll to the **Annivers.:** line.

Edit **Delete** **Save**
Press display keys one after the other.

Reminder call on an anniversary

A reminder call is signaled on the handset using the selected ringtone.

Silence Press the display key to stop the reminder call.

Using a handset as a room monitor

Last number redial list

The last number redial list contains the ten numbers last dialed with the handset (max. 32 numbers). If one of the numbers is in the directory, then the corresponding name will be displayed.

Manual last number redial



Press the key **briefly**.



Select entry.



Press the talk key again. The number is dialed.

When a name is displayed, you can display the corresponding phone number by pressing the display key **View**.

Managing entries in the last number redial list



Press the key **briefly**.



Select entry.

Options

Open the menu.

The following functions can be selected with :

Display Number (as in the directory, page 12)

Copy to Directory

Copy an entry to the directory (page 12).

Delete Entry (as in the directory, page 12)

Delete List (as in the directory, page 12)

Opening lists with the message key

The message key will illuminate after each missed call whether the caller left a voice mail message or not. An advisory tone sounds as soon as a **new entry** appears on a list. The key flashes (it will go off when the key is pressed). In idle status, the display shows an icon for the new message.

If you press the key, you access the lists which contain new messages.

Using a handset as a room monitor

If the room monitor is activated, a previously stored destination number is called as soon as a set noise level is reached. You can store an internal or external number in your handset as the destination number.

The room monitor call to an external number stops after approx. 90 seconds. The room monitor call to an internal number (handset) stops after approx. 3 minutes (depending on the base station). While the room monitor is activated, all keys are locked except the end call key. The handset's speaker is muted.

When the room monitor is activated, incoming calls to the handset are indicated **without a ringtone** and are only shown on the screen. The display and keypad are not illuminated and advisory tones are also turned off.

If you accept an incoming call, the room monitor mode is suspended for the duration of the call, but the function **remains** activated.

If you switch off the handset, the room monitor mode is deactivated. You will need to reactivate the function after switching on the handset again.

Caution:

- You should always check the operation of the room monitor before use. For example, test its sensitivity. Check the connection if you are diverting the room monitor to an outside number.
- When the function is switched on, the handset's operating time is severely reduced. If necessary, place the handset in the charging cradle. This ensures that the battery pack will not run down.
- Ideally the handset should be positioned 1 to 2 meters away from the sound being monitored. The microphone must be directed towards the monitored sound.
- The connection to which the room monitor is diverted must not be blocked by an activated answering machine.

Activating the room monitor and entering the number to be called

 →  → Room Monitor

- ▶ Change multiple line input:

Room M.:

Select **On** to activate.

Call to:

Press the display key **Edit** and enter destination number.

External number: select number from the directory or enter directly. Only the last 4 digits are displayed.

Internal number: delete any stored external number. **INT**  (select handset or **Call All**, if all registered handsets are to be called) **OK**.

Store number with **Save**.



Level:

Set noise level sensitivity (**Low** or **High**).

- ▶ Save changes (page 27).

The function is now activated. With , you can move directly to settings.

Changing previously set external destination number

 →  → Room Monitor



 Scroll to the **Call to:** line.

Edit Press the display key.

<C Delete existing number.

- ▶ Enter number as described in "Activating the room monitor and entering the number to be called" (page 15).
- ▶ Save changes (page 27).

Changing previously set external destination number

 →  → Room Monitor

 Scroll to the **Call to:** line.

Edit Press the display key.

Yes Press the display key to confirm the prompt.

- ▶ Enter number as described in "Activating the room monitor and entering the number to be called" (page 15).
- ▶ Save changes (page 27).

Deactivating the room monitor remotely

Requirements: The phone must support touch tone dialing and the room monitor must be set to an external destination number.

- ▶ Take the call from the room monitor and press keys  .

The room monitor function will deactivate after the call ends. There will be no further room monitor calls. The other room monitor settings on the handset (such as no ringtone) will however remain activated until you press the display key **Off** on the handset.

To reactivate the room function with the same phone number:

- ▶ Turn on the activation again and save with **Save** (page 15).

Handset settings

Handset settings

Changing the display language

You can view the display texts in different languages.

 →  → **Handset** → **Language**

The current language is indicated by .

 Select a language and press **OK**.

 Press and **hold** (idle status).



If you accidentally choose a language you do not understand:

 **5 jkl** **4 ghi** **1 aop**
Press display keys one after the other.

 Select the correct language and press **OK**.



Setting the display

You have a choice of four color schemes and several different contrasts.

 →  → **Display**

Color Scheme

Select and press **OK**.

 Select a color scheme and press **OK** ( = current color).

 Press **briefly**.

Contrast Select and press **OK**.

 Select contrast.

Save Press the display key.

 Press and **hold** (idle status).

Setting the screen picture

You can display a screen picture (picture or digital clock) when the handset is in idle status.

This will replace the idle status display. It may conceal the date, time and name.

The screen picture is not displayed in certain situations, e.g. during a call or when the handset has been deregistered.

If a screen picture has been activated, the menu item **Screen Saver** is marked with .

 →  → **Display** → **Screen Saver**

The current setting is displayed.

▶ Change multiple line input:

Activation:

Select **On** (screen picture is displayed) or **Off** (no screen picture).

Selection:

Change screen picture if necessary (see below).

▶ Save changes (page 27).

If the screen picture conceals the display, press the end call key briefly to show the idle display with time and date.

Changing the screen picture

 →  → **Display** → **Screen Saver**

 Scroll to the **Selection** line.

View Press the display key. The active screen picture is displayed.

 Select picture/Clock.

Save Press the display key.

▶ Save changes.

Setting display illumination

Depending on whether or not the handset is in the charging cradle you can set different levels of display illumination. If the charging cradle is switched on, the display is permanently dimmed.

 →  → **Display** → **Backlight**

The current setting is displayed.

▶ Change multiple line input:

In Charger

Select **On** or **Off**.

without Charger

Select **On** or **Off**.

Save Press the display key.



 Press and **hold** (idle status).

Note:

When the display lighting is switched on, the standby time of the handset is reduced to approx. 30 hours.

Activating/deactivating auto answer

If you have activated this function, when you get a call you can simply lift the handset out of the charging cradle without having to press the talk key .

 →  → **Handset**

Auto Answer

Select and press **OK** ( = on).

 Press and **hold** (idle status).

Adjusting the loudspeaker volume

You can set the loudspeaker volume for handsfree speaking to five different levels and the earpiece volume to three different levels. You can only make these adjustments during a call.

The handsfree volume can only be adjusted when this function is set.

You are conducting an external call.

 Open menu.

 Select volume.

Save Press display key if necessary to save the setting permanently.

If  is assigned a different function:



Options Open menu.

Volume Select and press **OK**.

Configure setting (see above).

Changing ringtones

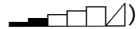
◆ **Volume:**

You can choose between five volumes (1–5; e.g. volume 2 = ) and the "Crescendo" ring (6; volume increases with each ring = .

◆ **Ringtones:**

You can choose between 15 different melodies.

You can configure the following functions with different ringtones:

◆ **Ext. Calls:** For external calls

◆ **Internal Calls:** For internal calls

◆ **All:** The same for all functions

Handset settings

Settings for individual functions

Set the volume and melody depending on the type of signaling required.

 →  → **Audio Settings**
→ **Ringer Settings**

 Setting, for example select **Ext. Calls** and press **OK**.

▶ Change multiple line input:

 Set volume (1–6).

 Scroll to the next line.

 Select melody.

Save Press the display key to confirm the prompt.

In idle status, you can also open the menu **Ringer Settings** by pressing  briefly.

Settings for all functions to ring the same

 →  → **Audio Settings**
→ **Ringer Settings** → **All**

▶ Set volume and ringtone (see "Settings for individual functions").

Yes Press the display key to confirm the prompt.

 Press and **hold** (idle status).

Activating/deactivating the ringtone

Before answering a call or while your handset is in idle status, it is possible for you to cancel the ringtone permanently or for the current call. The ringtone cannot be re-activated while an external call is in progress.

Deactivating the ringtone permanently

 Press the star key and hold until you can no longer hear the ringtone.

The  icon appears in the display.

Re-activating the ringtone

 Press and **hold** the star key.

Deactivating the ringtone for the current call

Silence Press the display key.

Activating/deactivating the alert tone

In place of the ringtone you can activate an alert tone. When you get a call, you will hear a **short tone** ("Beep") instead of the ringtone.

 Press and **hold** the star key and **within 3 seconds**:

Beep on Press the display key. A call is now signaled by **one** brief alert tone. You will now see  in the display.

Activating/deactivating advisory tones

Your handset uses 'advisory tones' to tell you about different activities and statuses. The following advisory tones can be activated and deactivated independently of each other:

◆ **Key beep**: Each key press is acknowledged.

◆ **Acknowledge tones**:

- **Confirmation tone** (rising tone sequence): at the end of the entry/setting and when a new entry arrives in the calls list
- **Error beep** (descending tone sequence): when you make an incorrect entry
- **Menu end tone**: when scrolling at the end of a menu

◆ **Battery low beep**: the battery pack requires charging.

 →  → **Audio Settings**
→ **Advisory Tones**

▶ Change multiple line input:

Key Tones:

Select **On** or **Off**.

Confirm.:

Select **On** or **Off**.

Battery:

Select **On**, **Off** or **In Call**. The battery tone is activated/deactivated or only sounds during a call.

- ▶ Save changes (page 27).

You cannot deactivate the confirmation tone for placing the handset in the charging cradle.

Setting the alarm clock

Requirement: the date and time must have already been set (page 8).

Activating/deactivating the alarm clock and setting the wake-up time

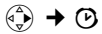

- ▶ Change multiple line input:

Alarm Clock:

Select **On** or **Off**.

Time:

Enter the wake-up time in 4-digit format.

Melody:

Select melody.

Volume:

Set the volume (1-6).

- ▶ Save changes (page 27).

You will see the  icon.

A wake-up call with the selected ringer melody is signaled on the handset. The wake up call sounds for 60 seconds. The display shows **Alarm Clock**. If no key is pressed the wake-up call is repeated twice at five minute intervals and then switched off.

During a call, the wake-up call is signaled by a short tone.

Deactivating the wake-up call/ repeating after a pause (sleep mode)

Requirement: A wake-up call is sounding.

Off

Press the display key. The wake-up call is deactivated.

Or:**Snooze**

Press the display key or any key. The wake-up call is deactivated and then repeated after 5 minutes. After the second repetition the wake-up call is deactivated completely.

Restoring the handset default settings

You can reset any individual settings and changes you have made. This will not affect entries in the directory, call-by-call list or calls list, or the handset's registration to the base station.

**Yes**

Press the display key.



Press and **hold** (idle status).

Cancel the restoring process by pressing

 or the display key **No**.

Appendix

Appendix

Care

- ▶ Wipe the charging cradle and the handset with a **damp** cloth (do not use solvent) or an antistatic cloth.

Never use a dry cloth. This can cause static.

Contact with liquid

Your handset is splash and dust resistant.

If it comes into contact with water, knock the water out of the microphone opening and remove any water on the handset with an absorbent cloth.

Your handset is ready for use.

If your handset comes into contact with a larger amount of liquid take the following steps:

1. **Do not switch the handset on under any circumstances!**
2. Remove the battery pack immediately.
3. Remove the headset socket cover.
4. Hold the handset horizontally with the open battery compartment facing down.
5. Hold the handset vertically. Tilt the handset backwards and forwards slightly, giving it a gentle shake each time.
6. Dab all parts dry and then leave the handset for **at least 72 hours** with the battery compartment open and the keypad facing down in a dry, warm place (not a microwave, oven or similar).

When it has fully dried out, you will normally be able to use it again.

Questions and answers

If you have any queries about the use of your telephone, you can contact us at any time at

www.siemens.com/gigasetcustomercare.

The table below contains a list of common problems and possible solutions.

Troubleshooting

The display is blank.

1. The handset is not switched on.
 - ▶ Press and **hold** the end call key .
2. The battery pack is empty.
 - ▶ Charge/replace the battery pack (page 5).

The handset does not respond to a key press.

The keypad lock is activated.

- ▶ Press and **hold** the pound key  (page 9).

"Base station x" is flashing in the display.

1. The handset is outside the range of the base station.
 - ▶ Reduce the distance between handset/base station.
2. The handset has been de-registered.
 - ▶ Register the handset (page 6).

Base Search is flashing in the display.

Handset is set for **Best Base** and no base station is within range.

- ▶ Reduce the distance between handset/base station.

Handset does not ring.

The ringtone is switched off.

- ▶ Activate the ringtone (page 18).

The other party cannot hear you.

You have pressed the  (INT) key. The handset is "muted".

- ▶ Switch on the microphone again (page 9).

You hear an error tone when keying an input (a descending sequence of tones).

Action has failed/invalid input.

- ▶ Repeat the operation. Watch the display and refer to the operating instructions if necessary.

Specifications

Recommended battery pack

(Valid at the time of going to press)

Nickel-metal-hydride (NiMH):

V30145-K1310-X382

The handset is supplied with the recommended battery pack.

Handset operating times/charging times

Capacity	620 mAh
Standby time	Approx. 160 hours (6 days)
Calling time	Approx. 12 hours
Charging time	approx. 6 hours

The operating and charging times apply only when using the recommended battery pack.

Note:

When the display lighting is switched on, the standby time of the handset is reduced to approx. 30 hours.

General specifications

Handset dimensions	143 x 51 x 25 mm (L x W x H)
Weight of handset with battery pack	133 g

Appendix

FCC

Warning: Changes or modifications to this unit not expressly approved by Siemens Cordless Products could void the FCC authority to operate the equipment. This includes the addition of any external antenna device.

If trouble is experienced with this equipment, for repair or warranty information, please contact Siemens Customer Care, Tel. 1-888-777-0211. If the equipment is causing harm to the telephone network, the telephone company may request that you disconnect the equipment until the problem is resolved. This equipment is of a type that is not intended to be repaired by the Customer (user).

Privacy of communications may not be ensured when using this phone.

This telephone system equipment has been tested and found to comply with the limits for Class B digital device, pursuant to Part 15 of the FCC Rules.

Operation is subject to the following two conditions:

(1) This device may not cause harmful interference, and (2) This device must accept any interference received, including interference that may cause undesired operation. These limits are designed to provide reasonable protection against harmful interference in a residential installation. Some cordless telephones operate at frequencies that may cause interference to nearby TV's and VCR's; to minimize or prevent such interference, the system base should not be placed near or on top of a TV or VCR; and, if interference is experienced, moving the base farther away from the TV or VCR will often reduce or eliminate the interference.

However, there is no guarantee that interference will not occur in a particular installation. If this telephone system does cause harmful interference to radio or television reception, which can be determined by turning the system off and on, the user is encouraged to try to correct the interference by one or more of the following measures:

1. Reorient or relocate the receiving antenna.
2. Increase the separation between the base station and receiver.
3. Connect the base station into an outlet on a circuit different from that to which the receiver is connected.
4. Consult the dealer or an experienced radio TV technician for help.

Notice to Hearing Aid Wearers:

This portable part is compatible with inductively coupled hearing aids.

Power Outage:

In the event of a power outage, your cordless telephone will not operate. The cordless telephone requires electricity for operation. You should have a telephone that does not require electricity available for use during power outages.

Notice:

For body worn operation, the portable part (handset) has been tested and meets FCC RF exposure guidelines. Use with an accessory that contains metal parts may not ensure compliance with FCC RF exposure guidelines.

Industry Canada Certification

Operation is subject to the following two conditions (1) this device may not cause interference, and (2) this device must accept any interference, including interference that may cause undesired operation of the device.

NOTICE: The Industry Canada label identifies certified equipment. This certification means that the equipment meets certain, protective, operational and safety requirements as prescribed in the appropriate Terminal Equipment Technical Requirements document(s). The Department does not guarantee the equipment will operate to the user's satisfaction.

Repairs to certified equipment should be coordinated by a representative designated by the supplier.

Any repairs or alterations made by the user to this equipment, or equipment malfunctions, may give the telecommunications company cause to request the user to disconnect the equipment.

Users should ensure for their own protection that the electrical ground connections of the power utility, telephone lines and internal metallic water pipe system, if present, are connected together.

This precaution may be particularly important in rural areas

NOTE: Users should not attempt to make such connections themselves, but should contact the appropriate electric inspection authority, or electrician, as appropriate.

This product meets the applicable Industry Canada technical specifications.

The Ringer Equivalence Number is an indication of the maximum number of devices allowed to be connected to a telephone interface. The termination of an interface may consist of any combination of devices subject only to the requirement that the sum of the RENs of all devices does not exceed five.

Safety precautions

Before using your telephone equipment, basic safety instructions should always be followed to reduce the risk of fire, electric shock and injury to persons.

1. Read and understand all instructions.
2. Follow all warnings and instructions marked on the product.
3. Unplug this product from the wall telephone jack and power outlet before cleaning. Do not use liquid cleaners or aerosol cleaners. Use damp cloth for cleaning.
4. Do not use this product near water, for example, near a bathtub, wash bowl, kitchen sink, or laundry tub, in a wet basement or near a swimming pool.
5. Place this product securely on a stable surface. Serious damage and/or injury may result if the unit falls.
6. Slots or openings in the cabinet and the back and bottom are provided for ventilation, to protect it from overheating. These openings must not be blocked or covered. This product should never be placed near or over a radiator or heat register, or in a place where proper ventilation is not provided.
7. This product should be operated only from the type of power source indicated on the marking label. If you are not sure of the type of power supply to your home, consult your dealer or local power company.
8. Do not place objects on the power cord. Install the unit where no one can step or trip on the cord.
9. Do not overload wall outlets and extension cords as this can result in the risk of fire or electric shock.
10. Never push objects of any kind into this product through cabinet slots as they may touch dangerous voltage points or short out parts that could result in the risk of fire or electric shock. Never spill liquid of any kind on this product.
11. To reduce the risk of electric shock or burns, do not disassemble this product. Take it to a qualified service center when service is required. Opening or removing covers may expose you to dangerous voltages, dangerous electrical current or other risks. Incorrect reassembly can cause electric shock when the appliance is subsequently used.
12. Unplug the product from the wall outlet and refer servicing to qualified service personnel under the following conditions:
 - a.) When the power cord is damaged or frayed.
 - b.) If liquid has been spilled into the product.
 - c.) If the product has been exposed to rain or water.

- d.) If the product does not operate normally by following the operating instructions. Adjust only those controls that are covered by the operating instructions because improper adjustment of other controls may result in damage and may require extensive work by a qualified technician to restore the product to normal operation.
 - e.) If the product has been dropped or physically has been damaged.
 - f.) If the product exhibits a distinct change in performance.
13. Avoid using a telephone (other than a cordless type) during a thunderstorm. There may be a remote risk of electrical shock from lightning. Therefore we suggest a surge arrester.
 14. Do not use the telephone to report a gas leak in the vicinity of the leak.
 15. Emergency/911 numbers may not be dialed if the keypad is locked.

BATTERY SAFETY PRECAUTIONS

To reduce the risk of fire, injury or electric shock, and to properly dispose of batteries, please read and understand the following instructions.

CONTAINS ALKALINE NICKEL METAL HYDRIDE BATTERY. BATTERY MUST BE RECYCLED OR DISPOSED OF PROPERLY. DO NOT DISPOSE OF IN MUNICIPAL WASTE.

1. Only use the batteries specified for use with this product.
2. **DO NOT USE ALKALINE NICKEL CADMIUM OR ALKALINE LITHIUM BATTERIES**, or mix batteries of different sizes or from different manufacturers in this product. **DO NOT USE NONRECHARGEABLE BATTERIES.**
3. Do not dispose of the batteries in a fire; the cells may explode. Do not expose batteries to water. Check with local codes for special disposal instructions.
4. Do not open or mutilate the batteries. Released electrolyte is corrosive and may cause damage to the eyes or skin. The electrolyte may be toxic if swallowed.
5. Exercise care in handling the batteries in order not to short the batteries with conducting materials such as rings, bracelets, and keys. The batteries or conducting material may overheat and cause burns or fire.
6. Charge the batteries provided with, or identified for use with, this product only in accordance with the instructions and limitations specified in the user's manual. Do not attempt to charge the batteries with any means other than that specified in the users manual.
7. Periodically clean the charge contacts on both the charger and handset.

Safety precautions

Customer Care Warranty for Cordless Products
**To obtain Siemens Customer Care Warranty service,
product operation information, or for problem resolution, call:**
Toll Free: 1-888-777-0211
9:00 a.m. – 8:00 p.m. Central Standard Time seven days a week

www.siemens.com/gigasetcustomercare

Limited Warranty

This limited, non-transferable warranty is provided to the original purchaser. The product is warranted to be free from defects in materials and workmanship under normal installation, use, and service for period of one (1) year from the date of purchase as shown on the purchaser's receipt.

Our obligation under this warranty is limited to repair or replacement (at our option) of the product or any part(s), that are defective, provided that the product is returned to Siemens during the warranty period. A copy of the dated purchase receipt must accompany products returned. In the absence of a purchase receipt, the warranty period shall be one (1) year from the date of manufacture. Repair or replacement of the product is your sole and exclusive remedy.

If the product is repaired, reconditioned component parts or materials may be used. If the product is replaced, we may choose to replace it with a new or reconditioned product of the same or similar design. The repaired or replacement product will be warranted for either (a) 90 days or (b) the remainder of the original one (1) year warranty period, whichever is longer. Batteries are warranted to be free from defects at the time of purchase.

EXCLUSIONS: This warranty does not cover (a) the adjustment of customer-operated controls as explained in the appropriate model's instruction manual, or (b) the repair of any product, which has been altered or defaced. This warranty shall not apply to the cabinet or cosmetic parts, antenna, buttons, batteries, or routine maintenance. This warranty does not apply to repairs or replacements necessitated by any cause beyond the control of SIEMENS including, but not limited to, any malfunction, defect or failure caused by or resulting from unauthorized service or parts, improper maintenance, damage from leaking batteries, operation contrary to furnished instructions, shipping or transit accidents, modification or repair by the user, abuse, misuse, neglect, accident, incorrect line voltage, fire, flood or other Acts of God, or normal wear and tear.

This warranty shall be void if the product is damaged as a result of defacement, misuse, abuse, neglect, accidents, destruction, or alteration of the serial number, improper electrical voltages or currents, repair, alteration or maintenance by any person or party other than our authorized service facility or any violation of instructions furnished by us.

The warrantor is not liable for incidental or consequential damages resulting from the use of this product, or arising out of any breach of this limited warranty. (As examples, this excludes damages for lost time, lost calls or messages, cost of having someone remove or re-install an installed unit if applicable, travel to and from servicer. The items listed are not exclusive, but are for illustration only.)

This warranty is also void if this product is removed from the country in which the original purchaser purchased it, if it is used in a country, which it not registered for use, or if it is used in a country for which it was not designed. Due to variations in telephone systems and communications laws, this product may be illegal for use in some countries. We assume no responsibility for damages or penalties incurred resulting from the use of this product in a manner or location other than that for which it is intended.

Safety precautions

THIS ONE-YEAR LIMITED WARRANTY IS IN LIEU OF ALL OTHER WARRANTIES EXPRESS OR IMPLIED. ANY IMPLIED WARRANTIES, INCLUDING BUT NOT LIMITED TO THE IMPLIED WARRANTIES OF MERCHANTABILITY AND FITNESS FOR A PARTICULAR PURPOSE, SHALL BE LIMITED IN DURATION TO THE ONE-YEAR DURATION OF THIS WRITTEN LIMITED WARRANTY. EXCEPT AS EXPRESSLY SET FORTH HEREIN, WE DISCLAIM ANY LIABILITY FOR DAMAGES ARISING FROM OWNERSHIP, USE, OR LOSS OF USE OF THE PRODUCTS, LOSS OF TIME, INCONVENIENCE, INJURY TO CUSTOMER OR ANY OTHER PERSON, OR DAMAGE TO CUSTOMER PROPERTY CAUSED BY THE PRODUCT, LOSS OF REVENUE OR PROFIT, OR DAMAGES FOR ANY FAILURE TO PERFORM. IN NO EVENT SHALL WE BE LIABLE FOR ANY SPECIAL, INCIDENTAL, PUNITIVE OR CONSEQUENTIAL DAMAGES EVEN IF WE ARE ADVISED OF THE POSSIBILITY OF SUCH DAMAGES. IN NO EVENT SHALL SIEMENS' LIABILITY EXCEED THE COST OF REPAIRING OR REPLACING THE DEFECTIVE PRODUCT AS PROVIDED HEREIN, AND ANY SUCH LIABILITIES WILL TERMINATE UPON EXPIRATION OF THE WARRANTY PERIOD.

Some states do not allow limitations on how long an implied warranty lasts, or the exclusion or limitation of incidental or consequential damages, so the above limitations may not apply to you.

This limited warranty is the sole and exclusive warranty provided for the product. This limited warranty is valid only in Canada and the United States (excluding all U.S. territories and protectorates). This limited warranty gives you specific legal rights, and you may also have other rights, which vary from state to state or province to province.

If you want to learn more about Siemens Gigaset, or for technical assistance with your Gigaset, visit our web site at <http://www.my-siemens.com> or, please call (888) 777-0211, or for TDD access (888) 777-0209.

Issued by Siemens Cordless Products
Siemens and Gigaset are registered trademarks of Siemens Home and Office Communication Devices GmbH & Co. KG.

Siemens Cordless Products is a division of Siemens Home and Office Communication Devices GmbH & Co. KG.

Product attributes subject to change.

Siemens reserves the right, to make changes without notice in equipment design and/or components.

Part Number: A31008-M1751-R101-2-6Z19

© Copyright 2005 Siemens Home and Office Communication Devices GmbH & Co. KG. All rights reserved.

Notes on the operating instructions

Notes on the operating instructions

This section explains the meaning of certain symbols and typographical conventions that are used in this user guide.

Symbols used

Copy Entry / Copy List (example)

Select one of the two menu functions specified.



Save

Enter digits or letters.

The display keys' current functions are shown reverse highlighted in the bottom display line.



Press the top or the bottom of the control key: scroll up or down.



Press the right or left of the control key: foreexample, select setting.



/ 0+ / *△ etc.

Press the corresponding key on the handset.

Example: menu input

In the user guides, the steps you need to perform are shown in abbreviated form. This is illustrated below using the example of "Contrast". The things you need to do are explained in the boxes.

→ → Display

- ▶ With the handset in idle status, press on the right of the control key to open the main menu.
- ▶ Select the icon using the control key – press the control key at the top or bottom.

In the display header, **Settings** is displayed.

- ▶ Press the display key **OK** to confirm the function **Settings**.

The **Settings** submenu is displayed.

- ▶ Press the bottom of the control key repeatedly until **Display** is selected.
- ▶ Press the display key **OK** to confirm the selection.

Contrast Select and press **OK**.

- ▶ Press the bottom of the control key repeatedly until **Contrast** is selected.
- ▶ Press the display key **OK** to confirm the selection.



Select contrast and press **OK**.

- ▶ Press right or left on the control key to select the contrast.
- ▶ Press the display key **Save** to confirm the selection.



Press and **hold** (idle status).

- ▶ Press and hold the end call key until the handset returns to idle status.

Example: multiple line input

There are many situations in which you can change the settings of a display or enter data in several lines.

In this user guide symbols are used to guide you step by step through multiple line input. This is illustrated below using the example of "Setting the date and time". The things you need to do are explained in the boxes.

You will see the following display (example):

Date/Time	
Date:	06.03.06
Time:	[11:11]am
Time Mode:	12 hour
am/pm	Save

Date:

Enter month, day and year in 6-digit format.

The date in the first line is marked with [] to show it is active.

- ▶ Enter the date using the digit keys.

Time:

Enter hours/minutes in 4-digit format.

- ▶ Press the  key.

The time in the second line is marked with [] to show it is active.

- ▶ Enter the date using the digit keys.

Time mode:

Select 12-hour or 24-hour time format.

- ▶ Press the  key.

The time format is marked with [] to show it is active.







- ▶ Select time format.
- ▶ With 12-hour time format, use the display key **am/pm** to switch between am and pm.

- ▶ Save changes.

▶ Press the display key **Save**.
▶ Then press and **hold** the  key.
The handset changes to idle status.

Writing and editing names

The following rules apply when creating an entry:

- ◆ Control the cursor with    .
- ◆ Characters are added to the left of the cursor.
- ◆ Press the star key  to show the table of special characters.
- ◆ Press and **hold** the hash key  to switch from "Abc" mode to "123" and from "123" to "abc" and from "abc" to "Abc" (upper case: 1st letter upper case, all others lower case). Press the hash key  **before** entering the letter.
- ◆ The first letter of the name of directory entries is automatically capitalized, followed by lower case letters.

Entering special characters

You can call up the table of special characters using the  key. Select the required character and insert it with **Insert**.

Order of directory entries

Directory entries are usually sorted in alphabetical order. Spaces and digits take first priority. The sort order is as follows:

1. Space
2. Digits (0–9)
3. Letters (alphabetical)
4. Other characters

To get around the alphabetical ordering of the entries, insert a space or a digit in front of the name. These entries will then move to the beginning of the directory. Names which you have preceded with an asterisk will move to the end of the directory.

Accessories

Accessories

All accessories and batteries are available from the Siemens customer care website:

XXXXX



Only use original accessories. This will avoid possible health risks and damage, and also ensure that all relevant regulations are complied with.

Index

A

Accessories	28
Acknowledge tones	18
Activating	
advisory tones	18
call acceptance	17
handset	9
keypad lock	9
room monitor	15
Adjusting	
loud speaker volume	17
Advisory tones	18
Alarm clock	
setting	19
Alert tone	18
Anniversary	13
Answering a call	8
Auto answer	8, 17

B

Base station	
changing	8
Battery icon	7
Battery pack	
charging	2, 7
display	2
inserting	5
recommended battery pack	21
symbol	2
Battery tone	18
Best base station	8

C

Call	
ending	8
external	8
internal	9
Call acceptance	17
Call duration	8
Call-by-call list	11
key	2, 11
Call-by-call numbers	11
Calls list	14
Canceling (operation)	10
Care, phone	20
Changing	
destination number	15

display language	16
ringtone	17
Charge status display	2, 7
Confirmation beep	18
Control key	2, 10
Correcting incorrect input	11

D

Deactivating	
handset	9
keypad lock	9
Default settings	
handset	19, 20
Delete key	10
Deleting	
characters	11
Digital clock	16
Directory	11
managing entries	12
opening	10
order of entries	27
saving entry	12
sending entry/list to handset	13
store anniversary	13
Display	
changing display language	16
color scheme/contrast	16
display keys	2, 10
illumination	17
in idle status	11
memory	12
screen picture	16
setting	16
wrong language	16

E

Earpiece mode	9
Earpiece volume	17
End call key	2, 8
Ending a call	8
Enter dialing pause	2
Entering special characters	27
Error beep	18
Example	
menu input	26
multiple line entry	27

F

Flash key	2
-----------	---

Index**G**

Group call 9

H**Handset**

activating/deactivating 9

advisory tones 18

changing to best reception 8

changing to different base station . . . 8

contact with liquid 20

display illumination 17

display language 16

idle status 11

list 10

loudspeaker volume 17

muting 9

operating and charging times 21

registering 6

registering on another

base station 8

restoring default settings 19

screen picture 16

using room monitor 14

Handset charging times 21

Handset operating time 21

in room monitor mode 15

Handsfree

key 2

Handsfree talking 9

Headset socket 7

Hearing aids 4

I**Icon**

alarm clock 19

ringtone 18

Idle status (display) 11

Idle status, returning to 11

Incorrect input (correction) 11

Internal call 9

K

Key 1 (fast access) 2

Key click 18

Keypad lock 9

Keys

assigning directory entry 12

call-by-call key 2

cancel key 10

control key 2, 10

delete key 10

display keys 2, 10

end call key 2, 8

fast access 2

flash key 2

handsfree key 2

menu key 10

message key 2

On/Off key 2

pound key 2, 9

quick dial 12

recall key 2

star key 2, 18

talk key 2, 8

L

Language, display 16

Last number redial list 14

Last number redial, manual 14

Liquid 20

List

calls list 14

handsets 10

Lock

activating/deactivating keypad

lock 9

Loudspeaker volume 17

M**Making calls**

answering a call 8, 9

external 8

internal 9

Manual last number redial 14

Medical equipment 4

Memory

directory 12

Menu

back one menu level 10

end tone 18

key 10

open 10

Menu input 26

Message key 2

opening lists 14

Microphone 2

Multiple line entry 27

Muting 9

N

- Network provider (number list) 11
- Number
 - as destination for room monitor . . . 15
 - saving in directory 12
- Number list (network provider) 11

O

- On/Off key 2
- Open
 - menu 10
- Opening
 - directory 10
- Order of entries in directory 27

P

- Pack contents 5
- Phoning
 - internal 9
- Pound key 2, 9
- Power supply unit 4

Q

- Quick dial 12, 13

R

- Recall key 2
- Registering (handset) 6
- Reminder call 13
- Reset 19
- Ringtone
 - changing 17
 - setting melody 18
 - setting volume 17
- Room monitor 14
 - activating 15
 - entering destination number 15
 - sensitivity 15

S

- Safety precautions 4
- Screen picture 16
- Searching in directory 12
- Sending
 - directory entry to handset 13
- Setting
 - alarm clock 19
 - date 8
 - display illumination 17
 - display language 16
 - loud speaker volume 17

- melody 18
- ringtone volume 17
- screen picture 16
- time 8
- volume, melody 18

Settings, see Setting

- Sleep mode 19

Sound

- ringtone 17
- Specifications 21
- Star key 2, 18

T

- Talk key 2, 8
- Troubleshooting 20

V

- VIP 12

Volume

- earpiece 17
- handset loudspeaker 17
- loudspeaker 17
- ringtone 17
- setting 18

W

- Wait melody 9
- Warning beep, see Advisory tones
- Writing, editing text 27

Index

