

## The handset at a glance

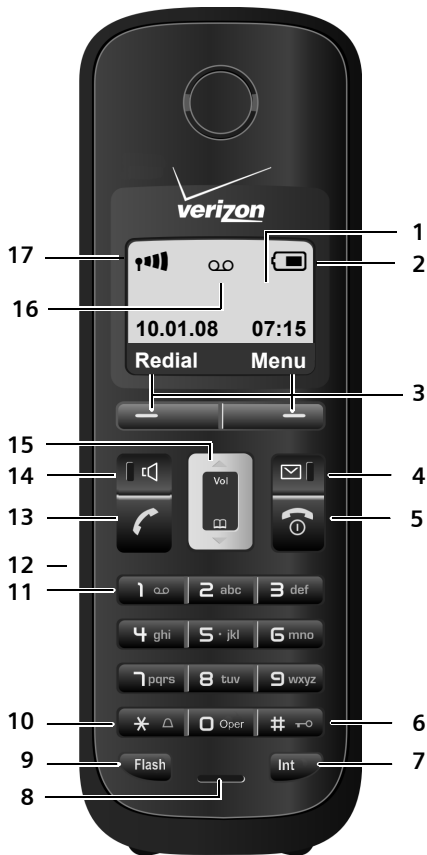

- 1 **Display** in idle status (example)
- 2 **Charge status of the batteries** ( → page 13)
- 3 **Display keys** ( → page 20)
- 4 **Message key** ( → page 30)  
Access to calls and message lists;  
Flashes: new message or new call
- 5 **End Call key, On/Off key**  
End call, cancel function, go back one menu level (press briefly), back to idle status (press and hold), activate/deactivate handset (press and hold in idle status)
- 6 **Pound key**  
Keypad lock on/off (press and hold in idle status);  
toggle between uppercase/lowercase and digits
- 7 **Internal key**  
Make an internal call ( → page 40)
- 8 **Microphone**
- 9 **Flash key** ( → page 45)  
- Recall (flash)  
- Insert a dialing pause (press and hold)
- 10 **Asterisk key**  
Ringer melodies on/off (press and hold);  
With an existing connection:  
Switch between pulse dialing/touch-tone dialing (press briefly)
- 11 **Key 1** ( → page 37)  
Dial answer machine/network mailbox (press and hold)
- 12 **Connection socket** for headset ( → page 18)
- 13 **Talk key**  
Answer a call, open last number redial list (press briefly), start dialing (press and hold)
- 14 **Handsfree key**  
Switch between earpiece and handsfree mode;  
Lights up: Handsfree activated  
Flashes: Incoming call
- 15 **Control key** ( → page 20)
- 16 **Answer machine icon**  
Answer machine switched on;  
Flashes: Answer machine is recording a message or is being operated by another internal party
- 17 **Signal strength** ( → page 13)

## The base station at a glance

### The base station at a glance

You can use the keys on the base station to register handsets to the base station, search for handsets (paging) → page 39 and operate the integrated answer machine.

#### Verizon 310AM base station

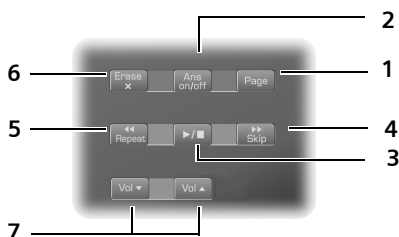

#### 1 Registration/Paging key:

Press **briefly**: Search for handsets (paging), → page 39.

Press and **hold**: Register handsets and DECT devices, → page 39.

#### 2 On/Off key: Activate/deactivate answer machine.

**LED lights up**: Answer machine is activated.

**LED flashes**: The answer machine is recording a new message.

#### During message playback:

##### 3 Play/Stop key:

Play back new messages from answer machine or cancel the playback (press **briefly**).

Play back new and old messages (press and **hold**).

**LED flashes**: At least one new message is present.

**LED flickers**: Memory is full.

##### 4 Skip to next message (press once) or message after next (press twice).

##### 5 Skip back to beginning of the message (press once) or to the previous message (press twice).

##### 6 Delete current message.

##### 7 Adjust volume during message playback:

[Vol ↓] = quieter; [Vol ↑] = louder.

While an external call is being signaled: Adjust ringer melody volume.

#### Please note:

- ◆ If the answer machine is being operated from a handset, or if it is recording a message, you cannot operate it from the base station.
- ◆ If the LED flashes although the answer machine is switched off, it means there is still at least one new message that has not been played back yet.

# Contents

<b>The handset at a glance</b> .....	<b>1</b>
<b>The base station at a glance</b> .....	<b>2</b>
<b>Safety precautions</b> .....	<b>6</b>
<b>First steps</b> .....	<b>7</b>
Check the package contents .....	7
Setting up the base station and charging cradle (if included) .....	10
Connecting the base station .....	10
Connecting the charging cradle (if included) .....	11
Setting up the handset for use .....	12
Area codes .....	17
Connecting the headset .....	18
What would you like to do next? .....	19
<b>Using the phone</b> .....	<b>20</b>
Control key .....	20
Display keys .....	20
Keys on the keypad .....	21
Correcting incorrect entries .....	21
Menu guidance .....	21
Activating/deactivating the handset .....	22
Activating/deactivating the keypad lock .....	22
Illustration of operating steps in the user guide .....	23
<b>Menu tree</b> .....	<b>24</b>
<b>Making calls</b> .....	<b>26</b>
Making an external call .....	26
Ending a call .....	26
Answering a call .....	26
Caller ID .....	26
Handsfree talking .....	27
Muting .....	27
CID 2.5 services (network services) .....	27
<b>Using the directory and lists</b> .....	<b>28</b>
Directory .....	28
Last number redial list .....	30
Opening lists with the Message key .....	30
<b>Making cost-effective calls</b> .....	<b>32</b>
Displaying the call duration .....	32

## Contents

<b>Operating the answer machine of the Verizon 310AM base station</b> .....	<b>33</b>
Operation using the handset .....	33
Activating/deactivating call screening .....	35
Setting up the answer machine .....	35
Resetting fast access for the answer machine using Key 1 .....	35
Operating when on the move (remote operation) .....	36
<b>Using the network mailbox</b> .....	<b>37</b>
Configuring fast access for the network mailbox .....	37
Viewing the network mailbox report .....	37
<b>ECO DECT</b> .....	<b>38</b>
<b>Setting the alarm clock</b> .....	<b>38</b>
<b>Using several handsets</b> .....	<b>39</b>
Registering handsets .....	39
De-registering handsets .....	39
Locating a handset ("paging") .....	39
Making internal calls .....	40
Listening in to an external call (conference) .....	40
<b>Handset settings</b> .....	<b>41</b>
Changing date and time .....	41
Changing the display language .....	41
Setting the display .....	41
Activating/deactivating auto answer .....	41
Changing the handsfree/earpiece volume .....	41
Changing ringer melodies .....	42
Activating/deactivating muting for the first ringer tone .....	42
Advisory tones .....	43
Restoring the handset to the factory settings .....	43
<b>Base station settings</b> .....	<b>43</b>
Protecting against unauthorized access .....	43
Changing ringer melodies .....	44
Repeater support .....	44
Restoring the base station to the factory settings .....	44
<b>Connecting the phone to a PABX</b> .....	<b>45</b>
Dialing modes and recall .....	45
Setting pauses .....	45
Switching temporarily to touch-tone dialing (DTMF) .....	45
<b>Troubleshooting</b> .....	<b>46</b>

**Contents**

**Appendix** ..... **47**  
Care ..... 47  
Contact with liquid ..... 47  
Specifications ..... 47  
Writing and editing text ..... 48  
FCC / ACTA Information ..... 49  
Safety precautions ..... 50  
Service (Customer Care) ..... 52  
End-user limited warranty ..... 52

**Accessories** ..... **56**

**Mounting the base station on the wall** ..... **57**

**Mounting the charging cradle on the wall** ..... **57**

**Index** ..... **58**

## Safety precautions

# Safety precautions \*

### Warning

Read the safety precautions and the user guide before use.

Explain them and the potential hazards associated with using the telephone to your children.



Only use the power adapter supplied, as indicated on the underside of the base station or charging cradle..



Only insert **approved rechargeable batteries of the same type**.

Never use ordinary (non-rechargeable) batteries as they may pose a health hazard or cause injury.

Do not charge the handset in charging cradle or base station while the headset is connected.



The operation of medical appliances may be affected. Be aware of the technical conditions in your particular environment, such as a doctor's office.



Notice to Hearing Aid Wearers:

This phone system is compatible with inductively coupled hearing aids.



Do not install the base station or charging cradle in bathrooms or shower rooms. The base station and charging cradle are not splash proof (→ page 47).



Do not use your phone in environments with a potential explosion hazard (e.g. paint shops).



If you give your telephone to someone else, make sure you include the user guide.



Please remove faulty base stations from use or have them repaired by Verizon Service, as they could interfere with other wireless services.



Dispose of batteries and the phone carefully. Do not pollute the environment.

**Emergency numbers cannot be dialed if the keypad lock is activated!**

\* also see page 50

## First steps

---

### Check the package contents

#### Verizon 310AM-1



- 1 One Verizon 310AM-1 base station
- 2 One power adapter for the base station
- 3 One handset
- 4 One phone cord
- 5 Two batteries
- 6 One battery cover
- 7 One belt clips
- 8 One user guide

## First steps

### Verizon 310AM-2



- 1 One Verizon 310AM-2 base station
- 2 One power adapter for the base station
- 3 One charging cradle
- 4 One power adapter for charging cradles
- 5 Two handsets
- 6 One phone cord
- 7 Four batteries
- 8 Two battery covers
- 9 Two belt clips
- 10 One user guide



First steps

Verizon 310AM-3



- 1 One Verizon 310AM-3 base station
- 2 One power adapter for the base station
- 3 Two charging cradles
- 4 Two power adapters for charging cradles
- 5 Three handsets
- 6 One phone cord
- 7 Six batteries
- 8 Three battery covers
- 9 Three belt clips
- 10 One user guide

## First steps

### Setting up the base station and charging cradle (if included)

The base station and charging cradle are designed for use in enclosed dry rooms within a temperature range of +41°F to +113°F.

- ▶ Set up the base station and charging cradles at a central location, on a flat, nonslip surface in your house or apartment.

#### Please note

Keep in mind the range of the base station. It is up to 984 feet in unobstructed outdoor areas and up to 165 feet inside buildings. The range is reduced when Eco Mode (→ page 38) is activated.

The phone's feet do not usually leave any marks on surfaces. However, due to the multitude of different varnishes and polishes used on today's furniture, the occurrence of marks on the surfaces cannot be completely ruled out.

For instructions on how to mount the base station and charging cradle on a wall, → page 57.

#### Please note:

- ◆ Never expose the telephone to heat sources, direct sunlight, or other electrical devices.
- ◆ Protect your telephone from moisture, dust, and corrosive liquids and vapors.

### Connecting the base station

- ▶ **First** connect the power adapter **1**.
- ▶ **Then** connect the telephone jack **2**, and insert the cables into the cableducts.



#### Please note:

- ◆ The power adapter must **always be connected**, as the phone will not operate without a power connection.
- ◆ Only use the power adapter and phone cord **supplied**. Pin connections on telephone cables can vary (pin connections → page 48).

## Connecting the charging cradle (if included)

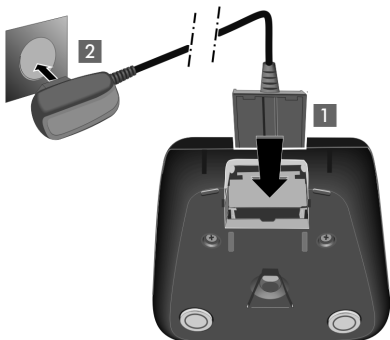

- ▶ Connect the flat plug of the power adapter **1**.
- ▶ Plug the power adapter into the plug socket **2**.

If you need to disconnect the plug from the charging cradle, press the release button **1** and disconnect the plug **2**.

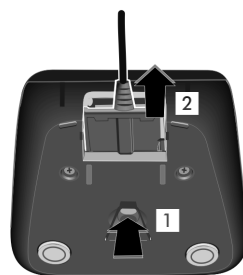

## First steps

### Setting up the handset for use

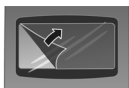

The display is protected by a plastic film. **Please remove the protective film!**

### Inserting the batteries and closing the battery cover

#### Warning

Use only rechargeable UL approved AAA batteries. Never use a conventional (non-rechargeable) battery or other battery types, as this could result in significant health risks and personal injury. For example, the batteries could explode. The phone could also malfunction or be damaged as a result of using batteries that are not of the recommended type.

- ▶ Insert the batteries in the correct orientation. The polarity is indicated in/on the battery compartment.

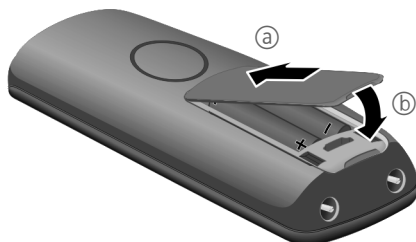

- ▶ First insert the battery cover at the top (a).
- ▶ Then press the cover (b) until it clicks into place.

If you need to open the battery cover, for example, to replace the batteries, place your fingertip into the cavity on the casing and pull the battery cover upwards.



## Attaching the belt clip

The handset has notches on each side to accommodate the belt clip.

- ▶ Press the belt clip onto the back of the handset so that the notches on the belt clip click into position.



## Placing the handset into the base station and registering



Before you can use the phone, you must first register the handset to the base station.

- ▶ Place the handset with the **display facing up** in the base station.

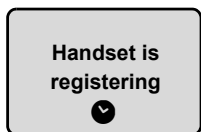

The handset registers automatically. Registration can take **up to 5 minutes**. **Do not remove the handset from the base station during this time.**



The following is displayed after successful registration:

- ◆ The strength of the reception signal between base station and handset:
  - Good to poor: [4 bars] [3 bars] [2 bars] [1 bar]
  - No reception: [no bars] flashes
- ◆ Battery charge status:
  - [empty] [1/4] [2/4] [3/4] [full] (flat to full)
  - [empty] flashes: batteries almost flat
  - [1/4] [2/4] [3/4] flashes: charging procedure

If you purchased a **model with multiple handsets**, repeat the registration process for each handset. Handsets are assigned the lowest available internal number (1–4). If more than one handset is registered to the base station, the internal handset number appears on the display (e.g. INT 2). If the internal numbers 1–4 are already assigned to other devices, the number 4 will be overwritten.

## First steps

### Please note

- ◆ Each key press interrupts the automatic registration.
- ◆ If automatic registration does not work, you must register the handset manually (→ page 39).

To charge the batteries, leave the handset in the charging cradle.

### Please note

Only place the handset in the base station or charging cradle that is intended for it.

Should you have any questions and problems → page 46.

## Initial charging and discharging of batteries

The correct charge level can only be displayed if the batteries are first fully charged **and** discharged.



- ▶ Place the handset in the base station or charging cradle for **eleven** hours.



- ▶ Then remove the handset from the base station or charging cradle, and do not replace it until the batteries are completely discharged.

### Please note

- ◆ After the first battery charge **and** discharge, you may replace your handset in its base station or charging cradle after every call.
- ◆ Always repeat the charging and discharging procedure if you remove the batteries from the handset and reinsert them.
- ◆ The batteries may warm up during charging. This is not dangerous.
- ◆ After a while, the charge capacity of the batteries will decrease for technical reasons.

## Setting the date and time

Set the date and time so that the correct date and time can be assigned to incoming calls, and so that the alarm can be used.



- ▶ Press the key below **Menu** on the display screen to open the main menu.



- ▶ Press the bottom of the Control key ...

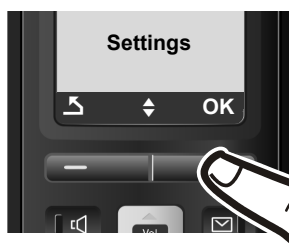

... until the **Settings** menu item appears.

- ▶ Press the key below **OK** on the display screen to confirm your selection.

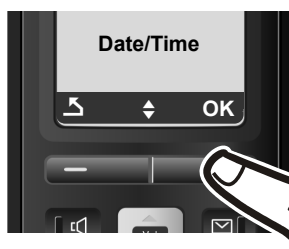

The **Date/Time** menu item appears on the display.

- ▶ Press the key below **OK** on the display screen to open the input field.

## First steps

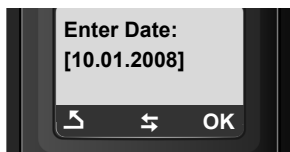

- ▶ The active line is marked [...]. Enter month, day and year as an 8-digit number using the handset (e.g. for 10/1/08).



If you want to correct an entry, press the top or bottom of the Control key to toggle between fields.

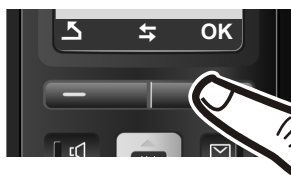
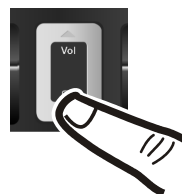

- ▶ Press the key below **OK** on the display screen to confirm your selection.

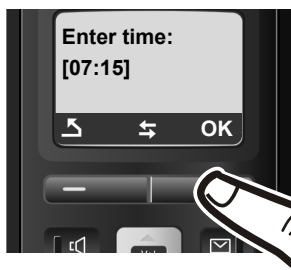

- ▶ Enter the hours and minutes as four digits using the handset (e.g. for 07:15 AM). If necessary, use the Control key to toggle between fields.
- ▶ Press the key below **OK** on the display screen to confirm your selection.



The display shows **Saved**. You will hear a confirmation tone.



- ▶ Press and **hold** the End Call key to return to the idle status.



## Area codes

In order to call back a caller using the incoming caller ID list (→ page 22), your phone's **area code** ("local area code") must be stored. If your phone is in a "multiple area code" area, the **extra codes** for this area must also be stored.

### Local Area Code

**Menu** → **Settings** → **Base**

#### Local Area Code

Select and press **OK**.



Enter local area code.



Press the display key.



Press and **hold** (idle status).

### Extra Codes

**Menu** → **Settings** → **Base**

#### Extra Codes

Select and press **OK**.



Enter extra code.



Press the display key.



Press and **hold** (idle status).

Repeat the above steps until all extra codes for your area have been entered. A maximum of 5 extra codes can be stored.

### Display in idle status

Once the phone is registered and the time set, the idle display is shown, as in this example. If the answer machine is activated, the answer machine icon  will also be displayed in the header.

Your answer machine is set with a prerecorded announcement.

**Your phone is now ready to use.**

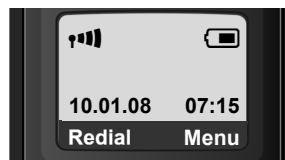

## First steps

### Connecting the headset



You can connect various headset types (with 2.5-mm jack connector), including HAMA Plantronics M40, MX100, and MX150.

A compatibility list of tested headsets can be found on the Internet at:

[www.plantronics.com/productfinder](http://www.plantronics.com/productfinder).

Please call the Verizon Service number 1-866 374 3864 or contact us at <http://www.verizon.com> for information.

#### **Warning**

Do not charge the handset in the charging cradle or base station while the headset is connected.

## What would you like to do next?

Now that you have successfully started your Verizon 310AM, you will probably want to adapt it to your personal requirements. Use the following guide to quickly locate the most important topics.

If you are unfamiliar with menu-driven devices, such as other Verizon telephones, you should first read the section titled "Using the phone" → page 20.

Information on ...	... is located here.
Setting the ringer melody and volume	▶ page 42
Setting the handset volume	▶ page 41
Recording a personal message for the answer machine	▶ page 33
Setting Eco Mode	▶ page 38
Operating the telephone on a PABX	▶ page 45
Registering existing handsets to a base station	▶ page 39
Transferring directory entries from existing handsets to the new handset(s)	▶ page 29

If you have any questions about using your phone, please read the tips on troubleshooting (→ page 46) or contact our Customer Care team (→ page 52).

Using the phone

## Using the phone



### Control key

In the following description, the side of the Control key you need to press for each operation is indicated accordingly, (e.g.  for "press the top of the Control key.")



The Control key has a number of different functions:





#### When the handset is in idle status

-  Open the directory
-  Display the menu for setting the handset's call volume (→ page 41), ringer melodies (→ page 42), and advisory tones (→ page 43).



#### In the main menu, in submenus and lists

-  /  Scroll up/down line by line.

#### In input fields

Use the Control key to move the cursor to the left  or right .

#### During an external call

-  Open the directory
-  Adjust the loudspeaker volume for earpiece and handsfree mode

### Display keys

The function of the display keys changes depending on the particular operating situation. Example:

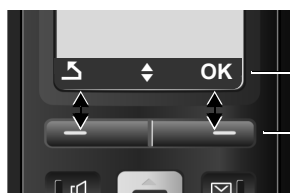

Current display key functions are shown in the bottom display line.

Display keys

Important display keys:

- Menu** Open a context-dependent menu.
- OK** Confirm selection.
- <C** Delete key: Deletes one character at a time from right to left.
-  Go back one menu level or cancel operation.
- Redial** Open the last number redial list.

## Keys on the keypad

 /  / , etc.

Press the matching key on the handset.



Enter digits or letters.

## Correcting incorrect entries

You can correct incorrect characters in the text by navigating to the incorrect entry using the Control key. You can then:

- ◆ Press **<C>** to delete the character to the left of the cursor
- ◆ Insert characters to the left of the cursor
- ◆ Overwrite the character (flashing) when entering the time, date, and so on

## Menu guidance

Your phone's functions are accessed using a menu that has a number of levels.

### Main menu (first menu level)

▶ When the handset is in idle status, press **Menu** to open the main menu.

The main menu functions are shown on the display as a list with a name and icon.

To access a function, meaning to open the corresponding submenu (next menu level):

▶ Navigate to the function using the Control key . Press the display key **OK**.

### Submenus

The functions in the submenus are displayed as lists.

To access a function:

▶ Scroll to the function with the Control key  and press **OK**.

Or:

▶ Enter the corresponding digit combination ( → page 24).

**Briefly** press the End Call key  once to return to the previous menu level/ cancel the operation.

### Reverting to idle status

You can revert to idle status from anywhere in the menu as follows:

▶ Press and **hold** the End Call key .

Or:

▶ Do not press any key: After two minutes, the display will **automatically** revert to idle status.

Any settings you have not confirmed by pressing **OK** will be discarded.

An example of the display in idle status is shown on → page 17.

## Using the phone

### Activating/deactivating the handset



With the phone in idle status, press and **hold** the End Call key (confirmation tone) to switch off the handset.  
Press and **hold** the End Call key again to switch the handset on.

### Activating/deactivating the keypad lock

The keypad lock prevents any inadvertent use of the phone.



Press and **hold** the pound key to activate or deactivate the keypad lock. You will hear the confirmation tone.

When the keypad lock is activated, you will see the  icon on the display and a message when you press a key.

The keypad lock is deactivated automatically if someone calls you. It is reactivated when the call is finished.

## Illustration of operating steps in the user guide

The operating steps are shown in abbreviated form.

### Example:

The illustration:

**Menu** → **Settings** → **Handset** → **Auto Answer** (✓ = on)

means:



- ▶ Press the display key **Menu** to open the main menu.

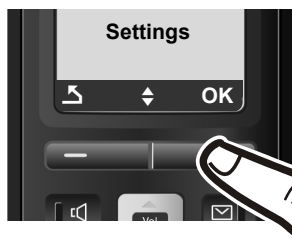

- ▶ Press the bottom of the Control key  until the **Settings** menu item appears on the display.
- ▶ Press the display key **OK** to confirm your selection.



- ▶ Press the bottom of the Control key  until the **Handset** menu item appears on the display.
- ▶ Press the display key **OK** to confirm your selection.

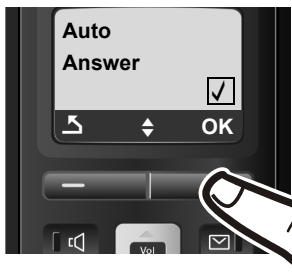

The **Auto Answer** menu item appears on the display.

- ▶ Press the display key **OK** to activate/deactivate the function (✓ = on).

## Menu tree

## Menu tree

---

Instead of scrolling to locate a menu function, you can select a function more quickly by opening the menu and keying in a digit combination (or shortcut).

**Example:** **Menu** **7** **2 abc** **2 abc** for "Set ringer melody volume."

With the telephone in **idle status**, press **Menu** (open main menu):

### 4 Alarm Clock

4-1	Activation	→ page 38
4-2	Wake up time	→ page 38

### 5 Voice Mail

5-1	Set Key 1	5-1-1	Network Mailbox	→ page 37
		5-1-2	Answering Machine	→ page 37
5-2	Answering Machine	→ page 33		
5-3	Call Screening	5-3-1	Handset	→ page 35
		5-3-2	Base	→ page 35
5-4	Announcements	5-4-1	Record Announcement	→ page 33
		5-4-2	Play Announcement	→ page 33
		5-4-3	Delete Announcement	→ page 33
5-5	Message Length	5-5-1	Unlimited	→ page 35
		5-5-2	1 Minute	
		5-5-3	2 Minutes	
		5-5-4	3 Minutes	
5-6	Ring Delay	5-6-1	Immediately	→ page 35
		5-6-2	10 sec	
		5-6-3	18 sec	
		5-6-4	30 sec	
		5-6-5	Auto	



Menu tree

7  Settings



7-1	Date/Time	→ page 15			
7-2	Audio Settings	7-2-1	Call Volume → page 41		
		7-2-2	Ringer Volume → page 42		
		7-2-3	Ringer Melody → page 42		
		7-2-4	Advisory Tones → page 43		
		7-2-5	Battery Low → page 43		
7-3	Handset	7-3-1	Display → page 41		
		7-3-2	Language → page 41		
		7-3-3	Auto Answer → page 41		
		7-3-4	Register Handset → page 39		
		7-3-5	Reset Handset → page 43		
7-4	Base	7-4-1	Audio Settings (Verizon 310AM base station only) → page 44		
		7-4-2	Calls List Type → page 31		
		7-4-3	System PIN → page 43		
		7-4-4	Base Reset → page 44		
		7-4-5	Additional Features	7-4-5-1	Repeater Mode → page 44
				7-4-5-3	Eco Mode → page 38
7-4-6	Listening in → page 40				

## Making calls



### Making calls

#### Making an external call

External calls are calls using the public telephone network.

  Enter the number and press the Talk key.

Or:

  Press and **hold** the Talk key , and then enter the number.

You can cancel the dialing operation with the End Call key .

You are shown the duration of the call while the call is in progress.

#### Please note

- ◆ Dialing with the directory (→ page 28), calls list (→ page 30) and last number redial list (→ page 30) saves you from repeatedly typing numbers.
- ◆ You can assign a number from the directory as a shortcut to the selected key (→ page 29).



#### Ending a call

 Press the End Call key.

#### Answering a call

The handset indicates an incoming call in three ways: by ringing, by a display on the screen, and by the flashing Handsfree key .

You can answer the call by:

- ▶ Pressing the Talk key .
- ▶ Pressing the Handsfree key .

If the handset is in the charging cradle and the **Auto Answer** function is activated (→ page 41), the handset automatically answers the call when you remove it from the charging cradle.

To deactivate the ringer melody, press the **Menu** display key and select **Silent**. You can take the call as long as it is displayed on the screen.

#### Caller ID

Caller ID (CID) and Caller Name ID (CNID) are optional subscription services provided by your telephone service provider. These features supply incoming caller identification information that will be displayed on your handset.

#### Call display with Caller ID/ Name

If the caller's number is saved in your directory, the caller's name will also be displayed.

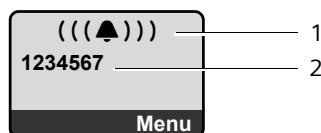

- 1 Ringer melody icon
- 2 Number or name of caller

The following is displayed in place of the number:

- ◆ **External Call**, if no number is transmitted.
- ◆ **Withheld**, if the caller has withheld caller ID.
- ◆ **Unavailable**, if the caller has not arranged caller ID.

## Display with CNIP

If you have CNIP, then the name (town/city) that is registered with your network provider for the caller's number will **also** be displayed. If the number of the caller is stored in your directory, the CNIP display is replaced by the corresponding directory entry.

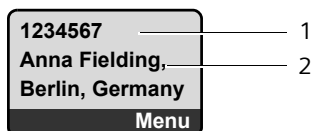

- 1 Caller's number
- 2 Name and town

The display shows:

- ◆ **Withheld**, if the caller has withheld caller ID.
- ◆ **Unavailable**, if the caller has not arranged caller ID.

## Handsfree talking

In handsfree mode, instead of holding the handset to your ear, you can place it, for example, on a table in front of you. This allows others to participate in the call.

## Activating/deactivating handsfree mode

### Activating while dialing

 Enter the number and press the Handsfree key.



- ▶ You should inform your caller before you use the handsfree function so that the caller knows someone else is listening.

### Switching between earpiece and handsfree mode

 Press the Handsfree key.

During a call and when listening to the answer machine, activate or deactivate handsfree mode.

If you wish to place the handset in the charging cradle during a call:

- ▶ Press and hold the Handsfree key  while placing the handset in the base station. If the Handsfree key  does not light up, press the key again.

For instructions on how to adjust the loudspeaker volume, → page 41.

## Muting

You can deactivate the microphone in your handset during an external call.

**Mute** Press the display key to mute the handset.

**On** Press the display key to switch the microphone back on.

## CID 2.5 services (network services)

If CID is activated and a waiting call is displayed, 4 different CID 2.5 services (network services) are selected.

During a call:

**Options** Press the display key

Select with :

### TAKE MSG

The waiting caller is forwarded to the central office mailbox.

### HOLD MSG

The waiting caller is put on hold and hears a message to this effect from the central office.

### CALL BACK

The waiting caller is prompted by the central office to call again at a later time.

### ADD 2ND

The central office is prompted to initiate a conference call.

### Note:

When the handset is muted and **ADD 2ND** selected, the microphone will be automatically reactivated.

## Using the directory and lists

### Using the directory and lists

The options are:

- ◆ Directory
- ◆ Last number redial list
- ◆ Call history
- ◆ Answer machine list

You can save up to 150 entries in the directory.

You can create a personalized directory for your particular handset. And you can also send the list or individual entries to other handsets (→ page 29).

### Directory

In the **directory**, you can save numbers and corresponding names.

- ▶ With the handset in idle status, open the directory by pressing the  key.

#### Length of entries

Number: max. 32 digits

Name: max. 16 characters

#### Please note

You can assign a number from the directory as a shortcut to the selected key → page 29.

### Saving the first number in the directory

 → Dir. empty New entry?

 Enter the number and press **OK**.

 Enter the name and press **OK**.

### Storing a number in the directory

 → **Menu** → New Entry

 Enter the number and press **OK**.

 Enter the name and press **OK**.

### Order of directory entries

Directory entries are usually sorted in alphabetical order. Spaces and digits take first priority. The sort order is as follows:



1. Space
2. Digits (0–9)
3. Letters (alphabetical)
4. Other characters

To get around the alphabetical ordering of the entries, insert a space or a digit in front of the name. These entries will then move to the beginning of the directory.

### Selecting a directory entry

 Open the directory

You have the following options:

- ◆ Use  to scroll to the entry until the desired name is selected.
- ◆ Enter the first character of the name, or scroll to the entry using , if necessary.

### Dialing with the directory

 →  (Select entry)

 Press the Talk key. The number is dialed.

### Managing directory entries

 →  (Select entry)

#### Editing entries

**Menu** → Edit Entry

 Edit the number, if necessary, and press **OK**.

 Edit the name, if necessary, and press **OK**.

## Using the directory and lists

### Using other functions

**Menu** Press the display key.

The following functions can be selected with :

#### Use Number

Save or modify a saved number, and then dial with , or save as a new entry; to do so, press **Menu** → **Copy to Directory** → **OK** after the number appears on the display.

#### Delete Entry

Delete selected entry.

#### Send Entry

Send a single entry to a handset (→ page 29).

#### Delete List

Delete **all** directory entries.

#### Send List



Send complete list to a handset (→ page 29).

#### Shortcut

Assign the current entry as a shortcut to the selected key.

## Using shortcut keys

You can assign directory entries to the keys 0 and 2–9:



 →  (select entry) → **Menu** → **Shortcut** →  (press the key you want to assign the number to)

**To dial**, press and **hold** the required shortcut key.

## Sending the directory to another handset

### Preconditions:

- ◆ The sending and receiving handsets must both be registered to the same base station.
- ◆ The other handset and the base station can send and receive directory entries.

 →  (select entry) → **Menu** (open menu) → **Send Entry / Send List**

 Enter the internal number of the receiving handset and press **OK**.

Successful transmission is acknowledged with the message **Entry copied**. You can transfer several individual entries one after the other by responding **OK** to the **Next entry?** prompt.

### Please note:

- ◆ Entries with identical numbers won't be overwritten on the receiving handset.
- ◆ The transfer will be canceled if the phone rings or if the memory of the receiving handset is full.

## Copying a displayed number to the directory

You can copy numbers displayed in a list (e.g. the calls list or redial list) to the directory.

If you have CNIP, the first 16 characters of the transmitted name are copied to the **Enter name** line.

A number is displayed:

**Menu** → **Copy to Directory**

▶ Complete the entry → page 28.

Message playback is interrupted during the number transfer from the answer machine list.

## Using a number from the directory

In some operating situations, you can open the directory to copy a number, for example. Your handset need not be in idle status.

 Open the directory.

 Select entry.

**OK** Press the display key.



Select function with .

## Using the directory and lists



### Last number redial list

The last number redial list contains the ten numbers last dialed with the handset (max. 32 numbers). If one of the numbers is in the directory, the corresponding name will be displayed.

### Manual last number redial

-  Press the key **briefly**.
-  Select entry.
-  Press the Talk key again. The number is dialed.

### Managing entries in the last number redial list

-  Press the key **briefly**.
-  Select entry.
-  **Menu** Open menu.

The following functions can be selected with :

**Use Number** (as in the directory, → page 29)

#### Copy to directory

Copy an entry to the directory (→ page 28).

**Delete Entry** (as in the directory, → page 29)

**Delete List** (as in the directory, → page 29)

### Opening lists with the Message key

You can use the Message key  to open the following list selection:

- ◆ Answer machine list or network mailbox, if your network provider supports this function and the fast access is set for the network mailbox (→ page 37).
- ◆ Call history

The Message key  will flash as soon as a **new entry** is received in a list (switches off when the key is pressed). The message **You have new messages** appears in the display in **idle status**.

30

### Please note

If calls are saved in the network mailbox, you will receive a message if the appropriate settings have been made (see your network provider user guide).

### List selection

The lists displayed after pressing the Message key  depend on whether there are any new messages.

#### key does not flash (no new messages):

Select a list with . To open, press **OK**.

#### key flashes (new messages received):

You see all the lists with new messages. If only one list contains new messages, it will open automatically.

### Call history

**Precondition:** Caller ID (CI, → page 26)

The calls list contains the last 25 numbers, depending on the settings

- ◆ All calls
  - Answered calls
  - Unanswered calls
  - Calls recorded by the answer machine
- ◆ Missed calls
  - Unanswered calls
  - Calls not recorded by the answer machine

The calls list is displayed as follows:

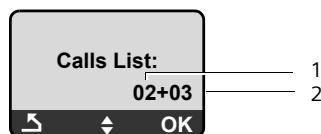

- 1 Number of new entries
- 2 Number of old, read entries

## Setting the call history type

**Menu** → Settings → Base → Calls List

Missed Calls / All Calls

Select and press **OK** (✓ = on).



Press and **hold** (idle status).

The call history entries are retained when you change the list type.

## Answer machine list

You can use the answer machine list to listen to the messages that are on the answer machine.

The answer machine list is displayed as follows:

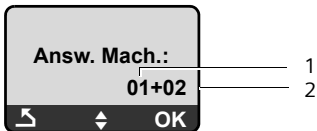

1 Number of new entries

2 Number of old, read entries

## Opening calls/answer machine list

**Envelope icon** → Calls List / Answ. Mach. 01+02

The last incoming call is displayed in the **calls list**.

The first new message received is displayed in the **answer machine list**. Playback begins. New messages are placed after old messages after they have been played back.

You can scroll through the list with .

### List entry

Example of a list entry:



- ◆ Status of entry

### In the calls list

**New Call:** new missed call.

**Old Call:** entry already read.

**Call recv.:** call taken.

### In the answer machine list

**Ans Mach.:**

The answer machine took the call.

A message was left.

**New Msg.:**

New message on the answer machine.

**Old Msg.:**

Previously played back message on the answer machine.

- ◆ Entry number

For example, 01/02 means the first of two entries.

- ◆ Number or name of caller

Press the Talk key to make a return call.

You can add the caller's number to the directory (→ page 29).

- ◆ Call date and time (if set, page 41).

You can delete the current entry with

**Menu** → Delete Entry.

## Answer machine list

You can use the **answer machine list** to listen to the messages that are on the answer machine.

## Displaying CNIP information

If you have CNIP, you can display the name and town/city that is registered with your network provider for this number.

You have selected a list entry.

**Menu** → Show Name

If the name and town/city are not shown, it means that the caller has not requested caller ID or that caller ID has been withheld.

Press **OK** to return to the list.

## Making cost-effective calls

# **Making cost-effective calls**

## **Displaying the call duration**

The duration of a call is displayed

- ◆ during the conversation
- ◆ until about three seconds after the call has ended if you do not replace the handset in the base station or charging cradle.

### **Please note**

The actual duration of the call can vary by a few seconds from that shown.



## Operating the answer machine of the Verizon 310AM base station



You can operate the answer machine that is integrated into the base station using the keys on the base station (→ page 2) or the handset, or through remote operation (other landline/mobile phone). You can only record your own announcement messages using the handset.

### Operation using the handset

The handset loudspeaker activates **automatically** if you receive an audible prompt or message during operation. You can switch it off with the Handsfree key .

### Activating/deactivating the answer machine

**Menu** → Voice Mail → Answering Machine (√ = on)

When the answer machine is activated, the remaining memory time is announced. The  icon appears on the display. The  key lights up on the base station.

The telephone is supplied with a prerecorded announcement. This prerecorded announcement is used if no personal announcement is available.

If the memory is full, a corresponding message will appear on the display, and the answer machine will be automatically deactivated. It automatically reactivates when you delete old messages.



### Recording your own announcement

**Menu** → Voice Mail → Announcements → Record Announcement

**OK** Press the display key to start the recording.

You will hear the ready tone (short tone).

- ▶ Now say your announcement (at least 3 seconds).

Cancel recording with  or .

Restart the recording with **OK**.

**OK** Press the display key to end the recording.

After recording, the announcement is played back for you to check.

#### Please note:

- ◆ Recording ends automatically when the maximum recording time of 170 seconds has been reached or if there is silence for more than two seconds.
- ◆ If you cancel the recording, the prerecorded announcement will be used again.
- ◆ The recording is cancelled if the answer machine memory is full.
  - ▶ If necessary, delete old messages and repeat the recording.

### Playing back announcements

**Menu** → Voice Mail → Announcements → Play Announcement

 Press and **hold** (idle status).

You will hear the prerecorded announcement if you have not recorded one of your own.

### Deleting announcements

**Menu** → Voice Mail → Announcements → Delete Announcement

**OK** Press the display key to confirm the prompt.



 Press and **hold** (idle status).

The prerecorded announcement is used again after a personal announcement has been deleted.

## Operating the answer machine of the Verizon 310AM base station

### Playing back messages

The date and time of each message is logged (provided this has been set; see → page 15). If caller ID is activated, the caller's number or name is displayed. If the caller's number is saved in the directory, the caller's name is displayed.

New messages that have not yet been played back are indicated by a message in the display and by the  key flashing on the handset. The  key flashes on the base station.

#### To listen to messages:

 Press the Message key.

Answ. Mach.



Select as required and press **OK**.

If you have new messages, playback will start with the first new message, otherwise with the first old message.



See also answer machine list → page 31.



### Stopping and controlling playback

During message playback:

 Pause playback. Press  again to resume.  
**or**

**Menu** Stop playback. Press **OK** to resume.

 **or**  Return to the start of the current message.  
Press twice to go back to the previous message.

 **or**  Skip to the next message.  
Press twice to skip to the message after next.

If playback is interrupted for over a minute, the answer machine returns to idle status.

### Reading CNIP information of a message

During playback or pause:

**Menu** → **Show Name**

▶ Please also see → page 31.

### Copying the phone number of a message to the directory

During playback or pause:

**Menu** → **Copy to Directory**

▶ Complete the entry → page 28.

### Deleting messages

You can either delete all old messages together or individually.

#### Deleting all old messages

During playback or pause:

**Menu** → **Delete all**

**OK** Press the display key to confirm the prompt.



#### Deleting individual old messages

While playback is paused:

**<C** Press the display key.

### Answering up a call from the answer machine

You can answer a call while the answer machine is recording it:

 /  Press the Talk or Handsfree key.

Recording stops and you can speak to the caller.

If three seconds of the call has already been recorded when you answer it, the call will be displayed as a new message. The  key on the handset flashes.

You can answer the call even if it is not signaled on the handset.

## Operating the answer machine of the Verizon 310AM base station

### Activating/deactivating call screening

While a message is recording, you can screen calls through the loudspeaker of the base station and registered handsets.

#### Permanently activating/deactivating call screening

**Menu** → **Voice Mail** → **Call Screening**  
→ **Handset / Base** (✓ = on)

 Press and **hold** (idle status).

Call screening can be simultaneously activated on the base station and handset.

#### Deactivating call screening for the current recording

 Press the End Call key.

### Setting up the answer machine

The answer machine has already been preconfigured at the factory. Set up individual settings using the handset.

#### Setting call acceptance

You can set when you want the answer machine to answer a call.

The options are: **Immediately**, **10 sec**, **18 sec** or **30 sec** and **Auto**.

In **Auto** mode, the following applies to call acceptance:

- ◆ If there are no new messages, the answer machine answers a call after **18 seconds**.
- ◆ If new messages are present, the answer machine accepts a call after just **10 seconds**.

**Menu** → **Voice Mail** → **Ring Delay**

 Select an option **Immediately / 10 sec / 18 sec / 30 sec / Auto** and press **OK** (✓ = on).

 Press and **hold** (idle status).

### Setting the recording time

You can set the maximum recording time for a message.

The options are: **1 Minute**, **2 Minutes**, **3 Minutes** or **Unlimited**.

**Menu** → **Voice Mail** → **Message Length**

 Select a recording time and press **OK** (✓ = on).

 Press and **hold** (idle status).

### Changing the language for voice prompts and prerecorded announcements

**Menu** → **1 prep** **4 ght** **5 wxyz** **2 abc** **1 oo**

 Enter a digit for the required language (**2 abc** = English, **1 oo** = Spanish) and press **OK**.

### Resetting fast access for the answer machine using Key 1

The integrated answer machine has already been factory preset for fast access. However, if you have set the network mailbox for fast access (→ page 37), you can reset this setting.

**Menu** → **Voice Mail** → **Set Key 1**

#### Answering Machine

Select and press **OK**.

 Press and **hold** (idle status).

When you have selected the answer machine, press and **hold** Key 1. You will be connected directly.

The setting for fast access applies to all registered handsets.

## Operating the answer machine of the Verizon 310AM base station

### Operating when on the move (remote operation)

---

You can check and activate your answer machine from any other telephone (hotel, pay phone, etc.).

#### Preconditions:

- ◆ You have set a system PIN other than 0000 (→ page 43).
- ◆ The phone you are using for remote operation has touch-tone dialing (DTMF), meaning you hear different tones when you press the keys. Alternatively, you can use a code transmitter (available from your cell phone retailer).

### Calling the answer machine and playing back messages

---



Dial your own number.



When you hear your announcement, press **9** and enter the system PIN.

You will be informed whether any new messages have been recorded. The messages are then played back. You can now operate the answer machine with the keypad.

The following keys are used:

- 1** To return to the start of the current message.  
Press twice to go back to the previous message.
- 2** Stop playback. Press again to resume.
- 3** Go to the next message.
- 0** Delete current message.

### Activating the answer machine

---

- ▶ Phone home and let the phone ring until you hear: "Please enter PIN."



Enter system PIN.

Your answer machine is now activated and tells you how much memory time is left.

The messages are then played back.

The answer machine cannot be deactivated remotely.

## Using the network mailbox

The network mailbox is your network provider's answer machine within the network. You cannot use the network mailbox unless you have **requested** it from your network provider.

## Configuring fast access for the network mailbox

With fast access, you can directly dial the network mailbox or the integrated answer machine.

The integrated answer machine is set for fast access. Instead, you can define fast access for the network mailbox. Ask your network provider about this.

## Configuring fast access for the network mailbox and entering the network mailbox number

**Menu** → **Voice Mail** → **Set Key 1**

### Network Mailbox

Select and press **OK** ( = on).



Enter the network mailbox number and press **OK**.



Press and **hold** (idle status).

The setting for fast access applies to all handsets.

## Calling your network mailbox



Press and **hold**. You are connected directly to the network mailbox.



Press the Handsfree key , if required. You will hear the network mailbox announcement.

## Viewing the network mailbox report

When a message is recorded, you receive a call from the network mailbox. If you have requested caller ID, the network mailbox number will be displayed. If you take the call, the new messages are played back. If you do not take the call, the network mailbox number will be saved in the missed calls list, and the Message key flashes (→ page 30).

## ECO DECT

### ECO DECT

You are helping to protect the environment with your Verizon 310AM.

#### Reduced energy consumption

Your telephone has an energy-saving adapter plug and uses less energy.

#### Reduced transmission power

The transmission power of your telephone is **automatically** reduced.

- ◆ The handset's transmission power is reduced depending on its distance to the base station.
- ◆ The transmission power at the base station is reduced to virtually zero when only one handset is registered and is standing in the base station.

You can reduce the transmission power of the handset and base station even further by using Eco Mode:

- ◆ **Eco Mode**  
80% transmission power reduction in standby and talk modes.

#### Activate/deactivate Eco Mode:

**Menu** → Settings → Base → Additional Features → Eco Mode

**OK** Press the display key  
( = on).

#### Status displays

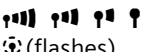
Display icon	
 (flashes)	Reception strength: – Good to low – No reception
Icon green	<b>Eco Mode</b> enabled

#### Please note

- ◆ Activating **Eco Mode** reduces the range of the base station.
- ◆ **Eco Mode** and repeater support (→ page 44) cancel each other out, meaning you cannot use Eco Mode when using a repeater.

## Setting the alarm clock

**Precondition:** The date and time have already been set (→ page 15).

### Activating/deactivating the alarm clock

**Menu** → Alarm Clock → Activation  
( = on)

After you activate the alarm clock, the menu for setting the wake-up time opens automatically (→ page 38).

If the alarm clock is set, the wake-up time appears with the  icon in the display instead of the date.

### Setting the wake-up time

**Menu** → Alarm Clock → Wake up time



Enter the wake-up time in hours and minutes, then press **OK**.

### When the alarm clock rings...

#### Alarm repeats after 5 minutes

**Snooze** Press the display key or any key.

If you press **Snooze** three times, the alarm clock switches off for 24 hours.

#### Turning off the alarm clock for 24 hours

**Off** Press the display key.

## Using several handsets

### Registering handsets

You can register up to four handsets to your base station.

#### Please note

Each additional handset must be registered on the base station in order for it to work properly!

For how to register your handset automatically, → page 13.

If automatic registration does not work, you must register the handset manually.

### Manual registration of the handset to Verizon 310AM

You must activate manual registration of the handset to both the handset and the base station.

Once it has been registered, the handset returns to idle status. The handset's internal number is shown in the display (e.g. INT 1). If it does not appear, repeat the procedure.

#### On the handset

**Menu** → Settings → Handset  
→ Register Handset



Enter the system PIN of the base station (the default is 0000) and press **OK**. Handset is registering flashes on the display.

#### On the base station

Within 60 sec., press and **hold** the Registration/Paging key on the base station (→ page 2) (approx. 3 seconds).

### Registering other handsets

You can register other Verizon handsets and handsets for other devices with GAP functionality as follows:

#### On the handset

- ▶ Start to register the handset as described in its user guide.

#### On the base station

Press and **hold** the Registration/Paging key on the base station (→ page 2) (approx. 3 seconds).

### De-registering handsets

Handsets can only be de-registered by resetting the base station to its default settings. **This will also reset every other setting** → page 44.

### Locating a handset ("paging")

You can locate your handset using the base station.

- ▶ **Briefly** press the Registration/Paging key on the base station (→ page 2).
- ▶ All handsets will ring simultaneously ("paging"), even if the ringer melodies are deactivated.

#### Ending paging

- ▶ **Briefly** press the Registration/Paging key on the base station or press the Talk key  on the handset.

## Using several handsets

### Making internal calls

---

Internal calls to other handsets registered with the same base station are free.

#### Calling other handsets

 Start internal call. The display shows **Enter INT No.**

 Enter the internal number of the receiving handset and press **OK**. The handset is called.

or:

 Press the display key and **OK**. All handsets are called.

#### Ending a call

 Press the End Call key.

### Transferring a call to another handset/ making an internal consultation call

---

You are talking to an external party and can call an internal party at the same time to forward the call or to consult.

- ▶ Calling internal parties

When an internal party answers:

- ▶ If necessary, announce the external call.

#### Either

 Press the End Call key. The call is transferred.

or:

 Press the display key. You are reconnected with the external party.

When transferring a call, you can also press the End Call key  before the internal party answers. Then, if the internal party does not answer or the line is busy, the call will automatically return to you (the display will show **Recall**).

### Answering a waiting call

---

If you receive an **external** call during an **internal** call, you will hear the call waiting tone (short tone). The caller's number or name will appear in the display if caller ID is enabled.

 Press the End Call key to end the internal call.

 Press the Talk key to take the external call.

### Listening in to an external call (conference)

---

You are conducting an external call. An internal party can listen in on this call and take part in the conversation. A signal tone and **Conference Call** on the display indicate to all parties the inclusion of a new party in the conversation.

**Precondition:** The **Listening in** function must be activated.

### Activating/deactivating listening in

---

**Menu** → **Settings** → **Base**

→ **Listening in** (✓ = on)

 Press and **hold** (idle status).

### Internal listening in

---

The line is engaged with an external call. Your screen will display information indicating this status. You want to listen in to the external call.

 Press and **hold** the Talk key.

You join the call. All parties hear a signal tone. **Conference Call** appears in the display.

### Ending listening in

 An internal party presses the End Call key.

All parties hear a signal tone.

This does not affect the connection between the other internal parties and the external caller.



## Handset settings

Your handset is preconfigured, but you can change the settings to suit your individual requirements.

### Changing date and time

To change the time, open the input field with:

**Menu** → **Settings** → **Date/Time**

**Enter Date:**

Enter the month, day, and year in 8-digit format, for example,

for 10/01/08.

**Enter time:**

Enter hours and minutes as 4 digits, for example, for 07:15 AM.

**OK** Press the display key

### Changing the display language

You can view the display texts in different languages.

**Menu** → **Settings** → **Handset** → **Language**

The current language is indicated by  $\surd$ .

Select a language and press **OK**.

Press and **hold** (idle status).

If you accidentally choose a language you do not understand:

**Menu** Press keys in sequence.

Select the correct language and press **OK**.

### Setting the display

You have a choice of four color schemes and several different contrasts. You can also set a screensaver and backlight.

**Menu** → **Settings** → **Handset** → **Display**

You have the following options:

#### Screensaver

The available settings are **No Screensaver**, **Globe** or **Digital Clock**.

#### Color Scheme

Four color schemes are available. When the backlight is turned off, the display is shown in black and white, regardless of the selected setting.

#### Contrast

There are five available contrast levels.

#### Backlight

**In Charger / Out of Charger**. Determines whether the backlight stays on permanently or is turned off after a certain time ( $\surd$  = permanently switched on).

#### Please note

If the backlight is turned on outside the charging cradle, the standby time for the handset is considerably reduced!

### Activating/deactivating auto answer

When this function is activated, when a call arrives, you can simply lift the handset out of the base station without having to press the Talk key .

**Menu** → **Settings** → **Handset** → **Auto Answer** ( $\surd$  = on)

Press and **hold** (idle status).

### Changing the handsfree/earpiece volume

You can adjust the volume for handsfree talking to one of five settings (1–5, e.g. volume 3 = ) and the earpiece volume to one of three (1–3, e.g. volume 2 = ).

### Setting the volume during a call

The setting applies to the current mode (earpiece or handsfree).

You are conducting an external call.

## Handset settings

 Press the Control key.

 Set the volume.

The setting will automatically be saved after approx. 3 seconds. If not, press the display key **OK**.

## Adjusting the volume using the menu













**Menu** → **Settings** → **Audio Settings**  
→ **Call Volume** → **Earpiece Volume / Handsfree Volume**

 Adjust the volume and press **OK**.

 Press and **hold** (idle status).

## Changing ringer melodies

### ◆ Volume:

Five volume levels (1–5; e.g. volume 3 =      ) and "crescendo" ring (6; volume increases with each ringer melody =      .

### ◆ Melody:

List of preloaded ringer melodies. The first three melodies are the "classic" ringer melodies.

You can also set different ringer melodies for the following functions:

- ◆ **External Calls:** For external calls
- ◆ **Internal Calls:** For internal calls
- ◆ **Alarm Clock:** For the alarm clock

For how to set the ringer melodies for the base station, → page 44.

## Setting the ringer volume

The ringer volume is the same for all types of ringer melodies.

**Menu** → **Settings** → **Audio Settings**  
→ **Ringer Volume**

Or in idle status:

 Press **briefly**.

Then:

 Adjust the volume and press **OK**.

 Press and **hold** (idle status).

## Setting the ringer melody

Set different ringer melodies for external calls, internal calls, and the alarm clock.

**Menu** → **Settings** → **Audio Settings**  
→ **Ringer Melody**

**External Calls / Internal Calls / Alarm Clock**  
Select and press **OK**.



 Select melody (✓ = on) and press **OK**.

 Press and **hold** (idle status).

## Activating/deactivating the ringer melody

You can turn off the ringer melody on your handset before you answer a call or while the phone is in idle status. You can take a call so long as it is displayed on the screen.

### Deactivating the ringer melody

 Press the Asterisk key **and hold** until the  icon appears on the display.

### Reactivating the ringer melody

 Press and **hold** the Asterisk key in idle status.

## Activating/deactivating muting for the first ringer tone

**Menu** Press the display key.

      
Press keys.

 **OK** Make the first ring audible.

Or:

 **OK** Mute the first ring.

## Advisory tones

Your handset uses "advisory tones" to tell you about different activities and statuses. The following advisory tones can be activated and deactivated independently of each other:

- ◆ **Advisory tones:**
  - **Key click:** every key press is confirmed.
  - **Confirmation tone** (rising tone sequence): at the end of an entry/setting, when the handset is placed in the base station and on arrival of a new entry in the answer machine list or the calls list.
  - **Error tone** (descending tone sequence): When you make an incorrect entry.
  - **Menu end tone:** When scrolling at the end of a menu.
- ◆ **Battery low beep:** the battery requires charging.

You cannot deactivate the confirmation tone for placing the handset in the base station.

## Activating/deactivating advisory tones

**Menu** → **Settings** → **Audio Settings**  
→ **Advisory Tones**

Select and press **OK** (✓ = on).

## Setting the battery low beep

**Menu** → **Settings** → **Audio Settings**  
→ **Battery Low**

**On / Off / During Call**

Select and press **OK** (✓ = on). The low-battery beep is activated or deactivated or sounds during a call.

## Restoring the handset to the factory settings

You can reset any individual settings and changes you have made. This will not affect entries in the directory, calls list, or the handset's registration to the base station.

**Menu** → **Settings** → **Handset**  
→ **Reset Handset**

Confirm query with **OK**, or reject it with **↵**.

 Press and **hold** (idle status).

## Base station settings

The base station settings are carried out using a registered handset.

## Protecting against unauthorized access

Protect the system settings of the base station with a PIN known only to you. You may have to enter the system PIN into the base station when manually registering a handset.

## Changing the system PIN

You can change the base station's 4-digit default system PIN ("0000") to a 4-digit PIN known only to you.

**Menu** → **Settings** → **Base** → **System PIN**

 Enter the **old** system PIN and press **OK**. For security, the PIN is shown as four asterisks (\*\*\*\*).

 Enter your **new** system PIN and press **OK**.

 Press and **hold** (idle status).

## Base station settings

### Resetting the system PIN

If you have forgotten the system PIN, you can reset it to the original code **0000** by resetting the base station to its default settings. **This will also reset every other setting**, see "Restoring the base station to the factory settings" → page 44.

### Changing ringer melodies

- ◆ Volume:  
You can choose between five volumes and the "crescendo" ring, → page 42. Select "0" to deactivate the base station ringer melody.
- ◆ Ringer melodies:  
You can set a ringer melody for external calls, → page 42.

**Menu** → Settings → Base → Audio Settings  
→ Ringer Volume / Ringer Melody

For how to adjust the settings,  
→ page 42.

### Repeater support

With a repeater, you can increase the range and reception strength of your base station. You will need to activate repeater mode. This will terminate any calls that are in progress at the time.

**Precondition:** A repeater is registered. The **Eco Mode** mode is deactivated.

**Menu** → Settings → Base  
→ Additional Features → Repeater Mode

**Yes** Press the display key.

When repeater mode is active, the menu item is marked with .

#### Please note

Repeater support and **Eco Mode** (→ page 38) cancel each other out, meaning both functions cannot be used at the same time.

### Restoring the base station to the factory settings

When restoring factory settings:

- ◆ Handsets are de-registered
  - **When resetting using the menu:**  
All Verizon handsets
  - **When resetting using the key on the base station:** Also all handsets of other GAP-capable devices
- ◆ Individual settings are reset
- ◆ All lists are deleted
- ◆ The system PIN is reset to the original code **0000**

Only the date and time are retained.

### Resetting the base station using the menu

**Menu** → Settings → Base → Base Reset  
**OK** Press the display key to confirm.

### Resetting the base station using a key on the base station

- ▶ Disconnect the power cord from the base station.
- ▶ Hold down the Registration/Paging key (→ page 2) on the base station while reconnecting the power cable to the base station. Press and hold the key until you hear a confirmation tone.

The base station has now been reset.

## Connecting the phone to a PABX

The following settings are only necessary when your PABX requires them; see the PABX user guide.

### Dialing modes and recall

The current setting is indicated by .

#### Changing the dialing mode



The following dialing modes can be selected:

- ◆ Touch-tone dialing (DTMF)
- ◆ Pulse dialing (DP)

   Pulse dialing (DP).

Or:

   Touch-tone dialing (DTMF).

 Press and **hold** (idle status).

#### Setting recall

For operation on a PABX, you may have to change this value. Please refer to the user guide of your PABX.

 Enter digits for the recall time and press .

**0** = 80 ms; **1** = 100 ms; **2** = 120 ms;

**3** = 180 ms; **4** = 250 ms; **5** = 300 ms;

**6** = 600 ms; **7** = 800 ms



 Press and **hold** (idle status).

## Setting pauses

### Changing the pause after line seizure

You can change the pause length that is inserted between pressing the Talk key  and sending the number.



 Enter digit for the pause length (**1** = 1 sec.; **2** = 3 sec.; **3** = 7 sec) and press .

 Press and **hold** (idle status).

### Changing the pause after pressing the Flash key

You can change the pause length if your PABX requires this (refer to the user guide for your PABX).

 Enter a digit for the pause length (**1** = 800 ms; **2** = 1600 ms; **3** = 3200 ms) and press .

 Press and **hold** (idle status).

### Switching temporarily to touch-tone dialing (DTMF)

If your PABX still operates with pulse dialing (DP), but you need touch-tone dialing (DTMF) for a connection (e.g. to listen to the network mailbox), you must switch to touch-tone dialing for the call.

**Precondition:** You are conducting a call or have already dialed an external number.

 Press the Asterisk key.  
After the call has ended, pulse dialing is automatically reactivated.

## Troubleshooting

### Troubleshooting

If you have any questions about the use of your telephone, you can contact us at any time at <http://www.verizon.com>.

The table below contains a list of common problems and possible solutions.

<p><b>The display is blank.</b></p> <ol style="list-style-type: none"> <li>The handset is not on.           <ul style="list-style-type: none"> <li>Press <b>and hold</b> the End Call key .</li> </ul> </li> <li>The batteries are dead.           <ul style="list-style-type: none"> <li>Charge or replace the batteries (→ page 12).</li> </ul> </li> </ol>	<p><b>Forgotten the system PIN.</b></p> <ul style="list-style-type: none"> <li>Reset the system PIN to 0000 (→ page 44).</li> </ul>
<p><b>"Base" flashes in the display.</b></p> <ol style="list-style-type: none"> <li>The handset is outside the range of the base station.           <ul style="list-style-type: none"> <li>Move the handset closer to the base station.</li> </ul> <p>The base station's range is shorter because Eco Mode mode is activated.</p> <ul style="list-style-type: none"> <li>Deactivate Eco Mode (→ page 38) or reduce the distance between the handset and base station.</li> </ul> </li> <li>The base station is not on.           <ul style="list-style-type: none"> <li>Check the base station's power adapter (→ page 10).</li> </ul> </li> </ol>	<p><b>The other party cannot hear you.</b></p> <p>You have pressed the <b>Mute</b> display key. The handset is on "mute."</p> <ul style="list-style-type: none"> <li>Activate the microphone again (→ page 27).</li> </ul>
<p><b>Handset does not ring.</b></p> <p>The ringer melody is deactivated.</p> <ul style="list-style-type: none"> <li>Activate the ringer melody (→ page 42).</li> </ul>	<p><b>The number of the caller is not displayed despite CIP.</b></p> <p>Caller ID is not enabled.</p> <ul style="list-style-type: none"> <li><b>The caller</b> should ask the network provider to activate caller ID (CI).</li> </ul>
<p><b>You cannot hear a ringer melody/dial tone from the fixed line network.</b></p> <p>The phone cord supplied was not used or was replaced with a different cord that has the wrong pin connections.</p> <ul style="list-style-type: none"> <li>Always use the phone cord supplied or make sure that the pin connections are correct when purchasing one from a retailer (→ page 48).</li> </ul>	<p><b>You hear an error tone (descending tone sequence) when pressing keys.</b></p> <p>Action has failed/invalid input.</p> <ul style="list-style-type: none"> <li>Repeat the operation. Watch the display and refer to the user guide if necessary.</li> </ul>
<p><b>Error tone sounds after system PIN prompt.</b></p> <p>You have entered the wrong system PIN.</p> <ul style="list-style-type: none"> <li>Reset the system PIN to 0000 (→ page 44).</li> </ul>	<p><b>You cannot listen to messages in the network mailbox.</b></p> <p>Your PABX is set for pulse dialing.</p> <ul style="list-style-type: none"> <li>Set your PABX to touch-tone dialing.</li> </ul> <p><b>No time is specified for a message in the answer machine history.</b></p> <p>Date/time is not set.</p> <ul style="list-style-type: none"> <li>Set the date/time (→ page 15).</li> </ul>
	<p><b>The answer machine announces "PIN is incorrect" during remote operation.</b></p> <ol style="list-style-type: none"> <li>You have entered the wrong system PIN.           <ul style="list-style-type: none"> <li>Enter the system PIN again.</li> </ul> </li> <li>The system PIN is still set to 0000.           <ul style="list-style-type: none"> <li>Change the system PIN (→ page 43).</li> </ul> </li> </ol>
	<p><b>The answer machine will not record any messages.</b></p> <p>Its memory is full.</p> <ul style="list-style-type: none"> <li>Delete old messages.</li> <li>Play back new messages and delete.</li> </ul>

## Appendix

### Care

- ▶ Wipe the base station, charging cradle, and handset with a **damp** cloth (do not use solvent) or an antistatic cloth.

**Never** use a dry cloth. This can create static.

### Contact with liquid

If the handset should come into contact with liquid:

1. **Immediately turn the handset off and remove the batteries.**
2. Allow the liquid to drain from the handset.
3. Pat all parts dry, and then place the handset with the battery compartment open and the keypad facing down in a dry, warm place **for at least 72 hours (never in a microwave oven, convection oven, etc.)**.
4. **Do not switch on the handset again until it has completely dried.**

When it has fully dried, you should be able to use it again normally.

## Specifications

### Recommended batteries

Technology:

Nickel-metal hydride (NiMH)

Size: AAA (Micro, HR03)

Voltage: 1.2 V

Capacity: 550–1000 mAh

We recommend the following battery types because these are the only ones that guarantee the specified operating times, full functionality, and long service life:

- ◆ GP 700 mAh
- ◆ Yuasa Phone 700 mAh

- ◆ Yuasa Phone 800 mAh
- ◆ Yuasa AAA 800
- ◆ Peacebay 600 mAh

The handset is supplied with UL approved AAA batteries.

### Handset operating times/charging times

The operating time of your telephone depends on the capacity and age of the batteries and the way they are used. (All times are maximum possible times and apply when the display backlight is switched off).

	Capacity (mAh) approx.			
	550	650	800	1000
Standby time (hours)	210	240	305	380
Talk time (hours)	21	25	31	38
Operating time for 1.5 hours of calls per day (hours)	85	100	125	155
Charging time, base station (hours)	9	11	14	17
Charging time, charging cradle (hours)	7	8	10	12

At the time of publication, batteries up to 800 mAh were available and had been tested in the system. In light of continuous advances in battery technology, the list of recommended batteries is regularly updated.

### Base station power consumption

<b>In standby mode</b>	
– Handset in charging cradle	approx. 1.3 W
– Handset off charging cradle	approx. 1.3 W
<b>During a call</b>	approx. 1.5 W

## Appendix

### General specifications

DECT standard	Supported
GAP standard	Supported
No. of channels	60 duplex channels
Radio frequency range	1880–1900 MHz
Duplex method	Time multiplex, 10 ms frame length
Channel grid	1728 kHz
Bit rate	1152 Kbps
Modulation	GFSK
Language code	32 Kbps
Transmission power	10 mW, average power per channel
Range	Up to 984 feet outdoors, up to 165 feet indoors
Base station power supply	230 V ~/50 Hz
Environmental operating conditions	+5°C to +45°C, 20% to 75% relative humidity
Dialing mode	DTMF (touch-tone dialing)/DP (pulse dialing)

### Telephone jack pin connections

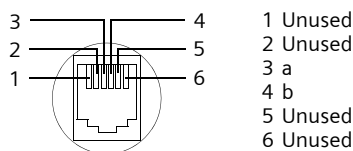

### Writing and editing text

The following rules apply when writing text:

- ◆ Use to move the cursor to the right or left.
- ◆ Characters are inserted to the left of the cursor.
- ◆ The first letter of directory entry names is automatically capitalized, followed by lowercase letters.

### Entering characters

Press the relevant key several times to enter letters/characters.

#### Standard characters

	1x	2x	3x	4x	5x	6x	7x	8x	9x	10x	11x	12x	13x	14x
		<sup>1)</sup>	<sup>2)</sup>	1	€	£	\$	¥	□					
	a	b	c	2	ä	á	à	â	ã	ç				
	d	e	f	3	ë	é	è	ê						
	g	h	i	4	ï	í	ì	î						
	j	k	l	5										
	m	n	o	6	ö	ñ	ó	ò	ô	õ				
	p	q	r	s	7	ß								
	t	u	v	8	ü	ú	ù	û						
	w	x	y	z	9	ÿ	ÿ	æ	ø	å				
	.	,	?	!	0	+	-	:	;	"	'	;	-	
	*	/	(	)	<	=	>	%						
# key"/>	#	@	\	&	§									

- 1) Space
- 2) Line break

When you press and **hold** a key, the characters of that key appear in the display and are highlighted one after the other. When you release the key, the highlighted character is inserted into the input field.

#### Setting uppercase/lowercase or digits

Press the Pound key **briefly** to switch from "Abc" mode to "123," from "123" to "abc," and from "abc" to "Abc" (uppercase: 1st letter uppercase, all others lowercase). Press the Pound key **before** entering the letter.

You can see briefly in the display whether uppercase, lowercase, or digits is selected.



## FCC / ACTA Information

**Warning:** Changes or modifications to this unit not expressly approved by Gigaset Communications USA LLC could void the FCC authority to operate the equipment. This includes the addition of any external antenna device.

This equipment complies with Part 68 of the FCC rules and the requirements adopted by the ACTA. On the bottom of the base station is a label that contains, among other information, a product identifier in the format US:AAAEQ##TXXXX. If requested, this number must be provided to the telephone company.

A plug and jack used to connect this equipment to the premises wiring and telephone network must comply with the applicable FCC Part 68 rules and requirements adopted by the ACTA. A compliant telephone cord and modular plug is provided with this product. It is designed to be connected to a compatible modular jack that is also compliant. See installation instructions for details.

The REN is used to determine the number of devices that may be connected to a telephone line. Excessive RENs on a telephone line may result in the devices not ringing in response to an incoming call. In most but not all areas, the sum of RENs should not exceed five (5.0). To be certain of the number of devices that may be connected to a line, as determined by the total RENs, contact the local telephone company.

For products approved after July 23, 2001, the REN for this product is part of the product identifier that has the format US:AAAEQ##TXXXX. The digits represented by ## are the REN without a decimal point (e.g., 03 is a REN of 0.3). For earlier products, the REN is separately shown on the label.

If this equipment causes harm to the telephone network, the telephone company will notify you in advance, that temporary discontinuance of service may be required. But if advance notice isn't practical, the telephone company will notify the customer as soon as possible. Also, you will be advised of your right to file a complaint with the FCC if you believe it is necessary. The telephone company may make changes in its facilities, equipment, operations or procedures that could affect the operation of the equipment. If this happens the telephone company will provide advance notice in order for you to make necessary modifications to maintain uninterrupted service. If you experience trouble with this telephone system, disconnect it from the network until the problem has been

corrected or until you are sure that the equipment is not malfunctioning.

If trouble is experienced with this equipment, for repair or warranty information, please contact Verizon Support at 1-866 374 3864. If the equipment is causing harm to the telephone network, the telephone company may request that you disconnect the equipment until the problem is resolved. This equipment is of a type that is not intended to be repaired by the Customer (user).

This telephone system may not be used on coin service provided by the telephone company. Connection to party line service is subject to state tariffs. Contact the state public utility commission, public service commission or corporation commission for information. Privacy of communications may not be ensured when using this phone.

If your home has specially wired alarm equipment connected to the telephone line, ensure the installation of this equipment does not disable your alarm equipment. If you have questions about what will disable alarm equipment, consult your telephone company or a qualified installer.

This telephone system equipment has been tested and found to comply with the limits for Class B digital device, pursuant to Part 15 of the FCC Rules. Operation is subject to the following two conditions: (1) This device may not cause harmful interference, and (2) This device must accept any interference received, including interference that may cause undesired operation. These limits are designed to provide reasonable protection against harmful interference in a residential installation. Some cordless telephones operate at frequencies that may cause interference to nearby TV's and VCR's; to minimize or prevent such interference, the system base should not be placed near or on top of a TV or VCR; and, if interference is experienced, moving the base farther away from the TV or VCR will often reduce or eliminate the interference.

However, there is no guarantee that interference will not occur in a particular installation. If this telephone system does cause harmful interference to radio or television reception, which can be determined by turning the system off and on, the user is encouraged to try to correct the interference by one or more of the following measures:

1. Reorient or relocate the receiving antenna.
2. Increase the separation between the base station and receiver.

## Appendix

3. Connect the base station into an outlet on a circuit different from that to which the receiver is connected.
4. Consult the dealer or an experienced radio TV technician for help.

### Notice for Direct Inward Dialing ("DID")

ALLOWING THIS EQUIPMENT TO BE OPERATED IN SUCH A MANNER AS TO NOT PROVIDE FOR PROPER ANSWER SUPERVISION AS A VIOLATION OF PART 68 OF THE FCC'S RULES.

### Notice to Hearing Aid Wearers:

This phone system is compatible with inductively coupled hearing aids.

### Power Outage:

In the event of a power outage, your cordless telephone will not operate. The cordless telephone requires electricity for operation. You should have a telephone that does not require electricity available for use during power outages.

### Notice:

The installation of the base unit should allow at least 8 inches between the base and persons to be in compliance with FCC RF exposure guidelines.

For body worn operation, the portable part (handset) has been tested and meets FCC RF exposure guidelines. Use with an accessory that contains metal parts may not ensure compliance with FCC RF exposure guidelines.

### Notice to telephone company service:

If you need service from your telephone company, please provide them with the information

- Facility interface Code (FIC): 02LS2
- Service Order Code (SOC): 9.0Y
- Universal Service Order Code (USOC)  
Jack: RJ11C

as indicated on the label on the bottom side of the base station.

## Safety precautions

Before using your telephone equipment, basic safety instructions should always be followed to reduce the risk of fire, electric shock and injury to persons.

1. Read and understand all instructions.
2. Follow all warnings and instructions marked on the product.
3. Unplug this product from the wall telephone jack and power outlet before cleaning. Do not use liquid cleaners or aerosol cleaners. Use damp cloth for cleaning.
4. Do not use this product near water, for example, near a bathtub, wash bowl, kitchen sink, or laundry tub, in a wet basement or near a swimming pool.
5. Place this product securely on a stable surface. Serious damage and/or injury may result if the unit falls.
6. Slots or openings in the cabinet and the back and bottom are provided for ventilation, to protect it from overheating. These openings must not be blocked or covered. This product should never be placed near or over a radiator or heat register, or in a place where proper ventilation is not provided.
7. This product should be operated only from the type of power source indicated on the marking label. If you are not sure of the type of power supply to your home, consult your dealer or local power company.
8. Do not place objects on the power cord. Install the unit where no one can step or trip on the cord.
9. Do not overload wall outlets and extension cords as this can result in the risk of fire or electric shock.
10. Never push objects of any kind into this product through cabinet slots as they may touch dangerous voltage points or short out parts that could result in the risk of fire or electric shock. Never spill liquid of any kind on this product.
11. To reduce the risk of electric shock or burns, do not disassemble this product. Take it to a qualified service center when service is required. Opening or removing covers may expose you to dangerous voltages, dangerous electrical current or other risks. Incorrect reassembly can cause electric shock when the appliance is subsequently used.

12. Unplug the product from the wall outlet and refer servicing to qualified service personnel under the following conditions:

- a.) When the power cord is damaged or frayed.
- b.) If liquid has been spilled into the product.
- c.) If the product has been exposed to rain or water.
- d.) If the product does not operate normally by following the operating instructions. Adjust only those controls that are covered by the operating instructions because improper adjustment of other controls may result in damage and may require extensive work by a qualified technician to restore the product to normal operation.
- e.) If the product has been dropped or physically has been damaged.
- f.) If the product exhibits a distinct change in performance.

13. Avoid using a telephone (other than a cordless type) during a thunderstorm. There may be a remote risk of electrical shock from lightning. Therefore we suggest a surge arrestor.

14. Do not use the telephone to report a gas leak in the vicinity of the leak.

15. Emergency/911 numbers may not be dialed if the keypad is locked.

16. Minimum No. 26 AWG telecommunication line cord must be used with this phone.

## BATTERY SAFETY PRECAUTIONS

To reduce the risk of fire, injury or electric shock, and to properly dispose of batteries, please read and understand the following instructions.

CONTAINS ALKALINE NICKEL METAL HYDRIDE BATTERY. BATTERY MUST BE RECYCLED OR DISPOSED OF PROPERLY. DO NOT DISPOSE OF IN MUNICIPAL WASTE.

1. Only use the batteries specified for use with this product.
2. DO NOT USE ALKALINE NICKEL CADMIUM OR ALKALINE LITHIUM BATTERIES, or mix batteries of different sizes or from different manufacturers in this product. DO NOT USE NONRECHARGEABLE BATTERIES.
3. Do not dispose of the batteries in a fire; the cells may explode. Do not expose batteries to water. Check with local codes for special disposal instructions.
4. Do not open or mutilate the batteries. Released electrolyte is corrosive and may cause damage to the eyes or skin. The electrolyte may be toxic if swallowed.
5. Exercise care in handling the batteries in order not to short the batteries with conducting materials such as rings, bracelets, and keys. The batteries or conducting material may overheat and cause burns or fire.
6. Charge the batteries provided with, or identified for use with, this product only in accordance with the instructions and limitations specified in the user's manual. Do not attempt to charge the batteries with any means other than that specified in the users manual.
7. Periodically clean the charge contacts on both the charger and handset.

## Appendix

### Service (Customer Care)

**Customer Care Warranty for Cordless Products**  
**To obtain Customer Care Warranty service,**  
**product operation information, or for problem resolution, call:**  
**Toll Free: 1-866-374-3864**  
**9:00 a.m. – 5:00 p.m. Monday-Saturday**

#### System Information

When calling the Customer Care service, you may be asked to provide your phone's system information.

During the call, proceed as follows:

**Menu** →  → **System Info**

##### Operation Hours

Select entry and press **OK**.

The number of hours your system has been operating.

**Back** Press display key.

 **HS S/W Version**

Select entry and press **OK**.

The software version of the handset is displayed. Use  to scroll through all of the information.

**Back** Press the display key.

 **Base S/W Ver.**

Select entry and press **OK**.

The software version of the base station is displayed. Use  to scroll through all of the information.

**Back** Press the display key three times to return to normal telephone mode.

#### End-user limited warranty

The Verizon brand and the Verizon trademark are used under license. This product is covered by a one year limited warranty. Any repair replacement or warranty service, and all questions about this product should be directed to: 1-866-374-3864.

This limited, non-transferable warranty is provided to the original buyer/end-consumer ("you") for systems, handsets and accessories (collectively, "Product") provided by Gigaset Communications USA LLC ("Gigaset USA"). Gigaset USA warrants to you that at the date of purchase, the product is free of defects in workmanship and materials and the software included in the Product will perform in substantial compliance to its program specifications.

##### **1. WARRANTY PERIOD**

The Product warranty period is one (1) year from the original date of purchase by you. Proof of purchase (e.g., sales slip or invoice) must be provided with any Product returned during the warranty period. Batteries supplied with the Products are warranted to be free from defects at the time of purchase only.

##### **2. EXCLUSIVE REMEDY**

Gigaset USA's entire liability and your exclusive remedy if the Product is defective in materials or workmanship during the warranty period and is returned shall be that the Product will be repaired or replaced as set forth in Section 4 below. Reconditioned replacement components, parts or materials may be used in the replacement or repair. Data in the memory of the Product may be lost during repair.

### 3. THIS LIMITED WARRANTY DOES NOT COVER AND IS VOID WITH RESPECT TO THE FOLLOWING:

- Cosmetic damage, physical damage to the surface of the Product, including, without limitation, breakage, cracks, dents, scratches or adhesive marks on the LCD screen or outside casing of the Product.
- Products which have been repaired, maintained or modified (including the antenna) by anyone other than Gigaset USA or a Gigaset USA-approved repair facility, or that have been improperly installed.
- Cost of installation, removal or reinstallation.
- Damage due to any telephone, electronic, hardware or software program, network, Internet or computer malfunctions, failures, or difficulties of any kind, including without limitation, server failure or incomplete, incorrect, garbled or delayed computer transmissions.
- Equipment and components not manufactured, supplied or authorized by Gigaset USA.
- Modification of the Product's components, or operation of the Product in an unsuitable environment or in a manner for which it is not intended, including but not limited to failures or defects caused by misuse, abuse, accidents, physical damage, abnormal operation, improper handling or storage, neglect, alterations, unauthorized installation, removal or repairs, failure to follow instructions, problems caused by the carrier's network coverage, exposure to fire, water or excessive moisture or dampness, floods, or extreme changes in climate or temperature, acts of God, riots, acts of terrorism, spills of food or liquids, viruses or other software flaws introduced into the Product, or other acts which are not the fault of Gigaset USA and which the Product is not specified to tolerate, including damage caused by mishandling or blown fuses.
- Products which have had warranty stickers, electronic serial number and/or serial number label removed, altered, rendered illegible or fraudulently applied to other equipment.
- Signal reception problems (unless caused by defect in material or workmanship in the Product).
- Products operated outside published maximum ratings.

- Performance of the Products when used in combination with other products or equipment not manufactured, supplied or authorized by Gigaset USA.
- Consumables (such as batteries and fuses).
- Payments for labor or service to representatives or service centers not authorized to perform product maintenance by Gigaset USA.
- Loss of data.
- Testing and examination discloses that the alleged defect or malfunction in the Product does not exist.

This warranty does not cover customer education, instruction, installation or removal, set up adjustments, problems related to service(s) provided by a carrier or other service provider, and/or signal reception problems. Gigaset USA shall not be responsible for software, firmware, information, or memory data contained in, stored on, or integrated with any Products returned for repair, whether under warranty or not.

This warranty is valid only in the United States.

**USE WITH ACCESSORIES NOT SUPPLIED BY GIGASET USA OR NOT OTHERWISE EXPRESSLY AUTHORIZED BY GIGASET USA MAY VOID WARRANTY.**

### 4. WARRANTY CLAIM PROCEDURE

All warranty claims must be made by notifying Gigaset USA prior to the expiration of the warranty period. Gigaset USA's obligation to provide warranty support shall not extend past the end of the warranty period, except that any product repaired or replaced during the warranty period shall continue to be warranted for the balance of such warranty period or thirty (30) days, whichever is greater.

Throughout the warranty period, Verizon Support will be available Monday through Saturday from 9:00 a.m. to 5:00 p.m., excluding National holidays. Support service will be provided for you by accessing the toll free customer service number:

**1-866-374-3864**

## Appendix

### 5. LIMITATION OF WARRANTY

Gigaset USA makes no warranty or representation that the software in the Products will meet your requirements or will work in combination with any hardware or applications software products provided by third parties, that the operation of the software will be uninterrupted or error free, or that all defects in the software products will be corrected.

### 6. LIMITATION ON REMEDIES; NO CONSEQUENTIAL OR OTHER DAMAGES

Your exclusive remedy for any breach of this limited warranty is as set forth above. Except for any refund elected by Gigaset USA, YOU ARE NOT ENTITLED TO ANY DAMAGES, INCLUDING BUT NOT LIMITED TO **CONSEQUENTIAL DAMAGES**, if the Product does not meet the limited warranty, and, to the maximum extent allowed by applicable law, even if any remedy fails of its essential purpose. The terms below ("Exclusion of Incidental, Consequential and Certain Other Damages") are also incorporated into this limited warranty. Some states/jurisdictions do not allow the exclusion or limitation of incidental or consequential damages, so the above limitation or exclusion may not apply to you. This limited warranty gives you specific legal rights. You may have others which vary from state/jurisdiction to state/jurisdiction.

### 7. DISCLAIMER OF WARRANTIES

GIGASET USA AND ITS SUPPLIERS PROVIDE THE PRODUCT AND SUPPORT SERVICES (IF ANY) AS IS AND WITH ALL FAULTS. THE LIMITED WARRANTY IS IN LIEU OF ANY OTHER EXPRESS WARRANTIES (IF ANY) CREATED BY ANY DOCUMENTATION OR PACKAGING EXCEPT FOR THE LIMITED WARRANTY, AND TO THE MAXIMUM EXTENT PERMITTED BY APPLICABLE LAW IS IN LIEU OF ANY IMPLIED OR STATUTORY WARRANTIES, INCLUDING, BUT NOT LIMITED TO, THE IMPLIED WARRANTIES OF MERCHANTABILITY AND FITNESS FOR A PARTICULAR PURPOSE, OF ACCURACY OR COMPLETENESS OR RESPONSES, OF RESULTS, OF WORKMANLIKE EFFORT, OF LACK OF VIRUSES AND OF LACK OF NEGLIGENCE, ALL WITH REGARD TO THE PRODUCT, AND THE PROVISION OF OR FAILURE TO PROVIDE SUPPORT SERVICES. ALSO, THERE IS NO WARRANTY OR CONDITION OF TITLE, QUIET ENJOYMENT, QUIET POSSESSION, OR CORRESPONDENCE TO DESCRIPTION OR NON-INFRINGEMENT WITH REGARD TO THE PRODUCT.

Some states do not allow limitations on how long an implied warranty lasts or the exclusion or limitation of incidental or consequential damages, so the above exclusions or limitations may not apply to you. If an implied warranty or condition is created by your state and federal or state law prohibits disclaimer of it, you also have an implied warranty or condition, BUT ONLY AS TO DEFECTS DISCOVERED DURING THE PERIOD OF THIS LIMITED WARRANTY (ONE YEAR). AS TO ANY DEFECTS DISCOVERED AFTER THE ONE YEAR PERIOD, THERE IS NO WARRANTY OR CONDITION OF ANY KIND. This limited warranty gives you specific legal rights, and you may also have other rights which vary from state to state. In no event shall Gigaset USA's liability exceed the cost of repairing or replacing defective Products as provided herein, and any such liabilities will terminate upon expiration of the warranty period.

Any supplements or updates to the Product or the software in the Product, including without limitation, any (if any) software fixes or upgrades or bug fixes provided to you after the expiration of the one year limited warranty period are not covered by any warranty or condition, express, implied or statutory.

### 8. EXCLUSION OF INCIDENTAL, CONSEQUENTIAL AND CERTAIN OTHER DAMAGES

TO THE MAXIMUM EXTENT PERMITTED BY APPLICABLE LAW, IN NO EVENT SHALL GIGASET USA, SELLER OR THEIR SUPPLIERS BE LIABLE FOR ANY SPECIAL, INCIDENTAL, INDIRECT, OR CONSEQUENTIAL DAMAGES WHATSOEVER (INCLUDING, BUT NOT LIMITED TO, DAMAGES FOR LOSS OF PROFITS OR CONFIDENTIAL OR OTHER INFORMATION, FOR BUSINESS INTERRUPTION, FOR PERSONAL INJURY, FOR LOSS OF PRIVACY, FOR FAILURE TO MEET ANY DUTY INCLUDING OF GOOD FAITH OR OF REASONABLE CARE, FOR NEGLIGENCE, AND FOR ANY OTHER PECUNIARY OR OTHER LOSS WHATSOEVER) ARISING OUT OF OR IN ANY WAY RELATED TO THE USE OF OR INABILITY TO USE THE PRODUCT, THE PROVISION OF OR FAILURE TO PROVIDE SUPPORT SERVICES, OR OTHERWISE UNDER OR IN CONNECTION WITH ANY PROVISION OF THIS LIMITED WARRANTY, EVEN IN THE EVENT OF THE FAULT, TORT (INCLUDING NEGLIGENCE), STRICT LIABILITY, BREACH OF CONTRACT OR BREACH OF WARRANTY OF GIGASET USA OR SELLER OR ANY SUPPLIER, AND EVEN IF GIGASET USA OR SELLER OR ANY SUPPLIER HAS BEEN ADVISED OF THE POSSIBILITY OF SUCH DAMAGES.

REPAIR OR REPLACEMENT, AS PROVIDED UNDER THE WARRANTY, IS YOUR SOLE AND EXCLUSIVE REMEDY FOR BREACH OF THE LIMITED WARRANTY.

### 9. LIMITATION OF LIABILITY AND REMEDIES

NOTWITHSTANDING ANY DAMAGES THAT YOU MIGHT INCUR FOR ANY REASON WHATSOEVER (INCLUDING, WITHOUT LIMITATION, ALL DAMAGES REFERENCED ABOVE AND ALL DIRECT OR GENERAL DAMAGES), THE ENTIRE LIABILITY OF GIGASET USA, SELLER AND ANY OF THEIR SUPPLIERS UNDER ANY PROVISION OF THIS LIMITED WARRANTY AND YOUR EXCLUSIVE REMEDY FOR ALL OF THE FOREGOING (EXCEPT FOR ANY REMEDY OF REPAIR OR REPLACEMENT ELECTED BY GIGASET USA OR SELLER OR SUPPLIER WITH RESPECT TO ANY BREACH OF THE LIMITED WARRANTY) SHALL BE LIMITED TO THE GREATER OF THE AMOUNT ACTUALLY PAID BY YOU FOR THE PRODUCT OR FIVE DOLLARS (\$5.00 USD). THE FOREGOING LIMITATIONS, EXCLUSIONS AND DISCLAIMERS SHALL APPLY TO THE MAXIMUM EXTENT PERMITTED BY APPLICABLE LAW, EVEN IF ANY REMEDY FAILS ITS ESSENTIAL PURPOSE.

### 10. GOVERNING LAW

This limited warranty will be governed by the laws of Texas, and excluding the United Nations Convention on Contracts for the International Sale of Goods.

If you want to learn more about Verizon Service or for Support on your Verizon phone, visit our web site at <http://www.verizon.com> or please call 1-866-374-3864.

Issued by  
Gigaset Communications GmbH  
Schlavenhorst 66, D-46395 Bocholt  
Gigaset Communications GmbH is a trademark licensee of Siemens AG

© Gigaset Communications GmbH 2008  
All rights reserved.  
Subject to availability. Rights of modifications reserved.

Product attributes subject to change.  
We reserve the right, to make changes without notice in equipment design and/or components.

Part Number:A31008-M2026-R351-1-6019  
© Copyright 2008 Verizon. All rights reserved.

## Accessories

# Accessories

---

### Verizon V310AM Handsets

ADD ADDITIONAL VERIZON V310AM HANDSETS TO YOUR CORDLESS TELEPHONE SYSTEM.

#### Verizon V310AM Handset

- ◆ Illuminated graphical color display (65,000 colors)
- ◆ Illuminated keypad
- ◆ Handsfree talking
- ◆ Polyphonic ringer melodies
- ◆ Directory for around 150 entries
- ◆ Headset socket





## Mounting the base station on the wall

---

Verizon 310AM: 46 mm

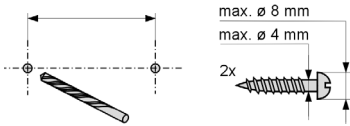

approx.  
2.5 mm

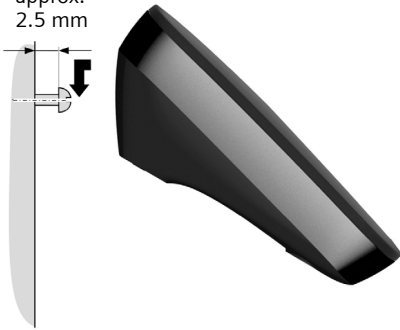

## Mounting the charging cradle on the wall

---

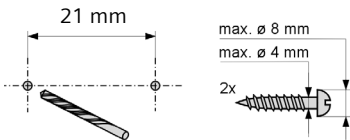

approx.  
2.5 mm

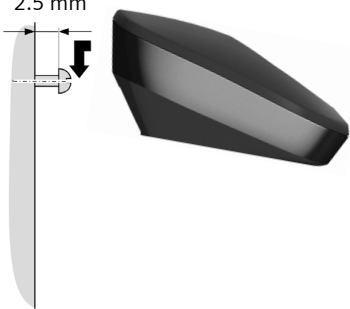

## Index

**Index****A**

- Access protection . . . . . 43
- Accessories . . . . . 56
- Activating
  - advisory tones . . . . . 43
  - answer machine . . . . . 33
  - answer machine
    - (remote operation) . . . . . 36
  - call acceptance . . . . . 41
  - handset . . . . . 22
  - internal call screening . . . . . 40
  - keypad lock . . . . . 22
  - muting ringer . . . . . 42
- Advisory tones . . . . . 43
- Alarm . . . . . 38
- Alarm repeat . . . . . 38
- Answer machine . . . . . 33
  - list . . . . . 30, 31
  - remote operation . . . . . 36
- Answer machine, see also
  - Network mailbox
- Area codes . . . . . 17
  - extra codes . . . . . 17
  - local area code . . . . . 17
- Asterisk key . . . . . 1, 42
- Auto answer . . . . . 41
- Automatic
  - call acceptance . . . . . 26

**B**

- Backlight . . . . . 41
- Base station
  - connecting . . . . . 10
  - connecting to PABX . . . . . 45
  - power consumption . . . . . 47
  - restoring factory settings . . . . . 44
  - setting . . . . . 43
  - setting up . . . . . 10
  - system PIN . . . . . 43, 44
- Battery
  - charging . . . . . 1, 14
  - display . . . . . 1
  - icon . . . . . 1, 13
  - inserting . . . . . 12
  - recommended batteries . . . . . 47
  - warning tone . . . . . 43

**C**

- Call
  - accepting . . . . . 26
  - ending . . . . . 26
  - external . . . . . 26
  - internal . . . . . 40
  - party listening in . . . . . 40
  - picking up from answer machine . . . . . 34
  - transferring (connecting) . . . . . 40
- Call acceptance . . . . . 35, 41
- Call duration . . . . . 26, 32
- Call history . . . . . 30
- Call screening during recording . . . . . 35
- Call waiting during an internal call . . . . . 40
- Caller ID . . . . . 26
- Calling
  - external . . . . . 26
  - internal . . . . . 40
- Care of the telephone . . . . . 47
- Changing
  - dialing mode . . . . . 45
  - earpiece volume . . . . . 41
  - handsfree volume . . . . . 41
  - pause time . . . . . 45
  - system PIN . . . . . 43, 44
- Character set . . . . . 48
- Charge status display . . . . . 1
- CID 2.5 services (network services) . . . . . 27
- Color scheme . . . . . 41
- Conference . . . . . 40
- Configuring the network mailbox . . . . . 37
- Confirmation tone . . . . . 43
- Connecting
  - base station to PABX . . . . . 45
  - headset . . . . . 18
- Contrast . . . . . 41
- Control key . . . . . 1, 20
- Correcting incorrect entries . . . . . 21
- Customer Care . . . . . 52

**D**

- Deactivating
  - advisory tones . . . . . 43
  - answer machine . . . . . 33
  - call acceptance . . . . . 41
  - handset . . . . . 22
  - internal call screening . . . . . 40
  - keypad lock . . . . . 22
  - muting ringer . . . . . 42

Delete key . . . . . 20

Deleting  
     announcement  
         (answer machine) . . . . . 33  
     characters . . . . . 21

Dialing  
     directory . . . . . 28  
     mode . . . . . 45  
     using shortcut keys . . . . . 29

Dialing pause  
     entering . . . . . 1

Digital clock . . . . . 41

Directory . . . . . 28  
     copying number . . . . . 29  
     copying number from text . . . . . 29  
     managing entries . . . . . 28  
     opening . . . . . 20  
     order of entries . . . . . 28  
     saving entry . . . . . 28  
     saving the first number . . . . . 28  
     sending entry/list to handset . . . . . 29

Display  
     backlight . . . . . 41  
     call duration . . . . . 32  
     changing display language . . . . . 41  
     color scheme . . . . . 41  
     contrast . . . . . 41  
     in idle status . . . . . 21  
     keys . . . . . 1, 20  
     network mailbox report . . . . . 37  
     number (CID/CNID) . . . . . 26  
     screensaver . . . . . 41  
     setting . . . . . 41

DP (pulse dialing) . . . . . 45

DTMF (touch-tone dialing method) . . . . . 45

**E**

Earpiece mode . . . . . 27

Earpiece volume . . . . . 41, 42

ECO DECT . . . . . 38

Eco mode . . . . . 38

End Call key . . . . . 1, 26

Ending, call . . . . . 26

Ending, see Deactivating

Entry  
     selecting from directory . . . . . 28

Error tone . . . . . 43

Extra codes . . . . . 17

**F**

Fast access  
     answer machine . . . . . 35  
     network mailbox . . . . . 37

Flash key . . . . . 1  
     pause after . . . . . 45

**G**

General troubleshooting . . . . . 46

**H**

Handset  
     activating/deactivating . . . . . 22  
     advisory tones . . . . . 43  
     contact with liquid . . . . . 47  
     de-registering . . . . . 39, 44  
     display language . . . . . 41  
     earpiece volume . . . . . 41  
     handsfree volume . . . . . 41  
     idle status . . . . . 21  
     locating . . . . . 39  
     muting . . . . . 27  
     paging . . . . . 39  
     registering . . . . . 39  
     restoring factory settings . . . . . 43  
     setting . . . . . 41  
     setting up . . . . . 12  
     transferring a call . . . . . 40  
     using several . . . . . 39

Handsfree key . . . . . 1

Handsfree talking . . . . . 27

Headset socket . . . . . 18

Help . . . . . 46

**I**

Icon  
     battery . . . . . 13  
     display . . . . . 20  
     for new messages . . . . . 30  
     keypad lock . . . . . 22

Idle status  
     display . . . . . 21  
     returning to . . . . . 21

Incorrect input (correction) . . . . . 21

Installing, base station . . . . . 10

Internal  
     call screening . . . . . 40  
     key . . . . . 1  
     making calls . . . . . 40

**Index**

Internal call . . . . . 40  
 call waiting . . . . . 40

**K**

Key 1 (fast access) . . . . . 1, 35  
 Key click . . . . . 43  
 Keypad lock . . . . . 22  
 Keys  
 assigning directory entry . . . . . 29  
 Asterisk key . . . . . 1, 42  
 Control key . . . . . 1, 20  
 Delete key . . . . . 20  
 display keys . . . . . 1, 20  
 End Call key . . . . . 1, 26  
 fast access . . . . . 1, 35  
 Flash key . . . . . 1  
 Handsfree key . . . . . 1  
 Internal key . . . . . 1  
 Message key . . . . . 1  
 On/Off key . . . . . 1  
 Pound key . . . . . 1, 22  
 Shortcut . . . . . 29  
 Talk key . . . . . 1, 26

**L**

Last number redial . . . . . 30

**List**

answer machine . . . . . 30, 31  
 answer machine list . . . . . 31  
 call history . . . . . 30  
 missed calls . . . . . 30, 31  
 network mailbox . . . . . 30

Local area code . . . . . 17

Locating, handset . . . . . 39

**Lock**

activating/deactivating keypad lock . 22

**M****Making calls**

answering a call . . . . . 26  
 cost-effective calls . . . . . 32  
 external . . . . . 26  
 internal . . . . . 40

Manual last number redial . . . . . 30

Medical appliances . . . . . 6

**Menu**

end tone . . . . . 43  
 overview . . . . . 24  
 prompting . . . . . 21

**Message**

copying number to the  
 directory . . . . . 34

deleting . . . . . 34

playing . . . . . 34

Message key . . . . . 1

opening lists . . . . . 30

Microphone . . . . . 1

Missed calls . . . . . 30, 31

**Muting**

first ring . . . . . 42

handset . . . . . 27

**N**

Network services (CID 2.5 services) . . 27

**Number**

copying from directory . . . . . 29

copying to directory . . . . . 29

displaying caller's number (CIP) . . . 26

entering with directory . . . . . 29

saving in the directory . . . . . 28

**O**

On/Off key . . . . . 1

Order in directory . . . . . 28

**P****PABX**

connecting base station . . . . . 45

setting dialing mode . . . . . 45

setting recall . . . . . 45

switching temporarily to touch-  
 tone dialing . . . . . 45

Pack contents . . . . . 7

Paging . . . . . 39

Pause . . . . . 45

PIN change, system PIN . . . . . 43, 44

Pin connections . . . . . 48

**Playing back**

announcement (answer machine) . 33

message (answer machine) . . . . . 34

Pound key . . . . . 1, 22

Power adapter . . . . . 6

Power consumption (base station) . . 47

Protecting the phone against access . . 43

Pulse dialing . . . . . 45

**Q**

Questions and answers . . . . . 46

**R**

- Range . . . . . 10
- Recall . . . . . 45
  - time . . . . . 45
- Reception booster, see Repeater
- Recording time (answer machine). . . . . 35
- Registering (handset). . . . . 39
- Remote operation . . . . . 36
- Repeater . . . . . 44
- Ringer
  - muting . . . . . 42
- Ringer melody
  - changing . . . . . 42
  - setting melody . . . . . 42, 44
  - setting volume . . . . . 42, 44

**S**

- Safety precautions . . . . . 6
- Screen protection, see Screensaver
- Screening a call . . . . . 40
- Screensaver . . . . . 41
- Searching in directory . . . . . 28
- Sending directory entry to handset . . . . . 29
- Service (Customer Care). . . . . 52
- Setting
  - date . . . . . 15, 41
  - melody . . . . . 44
  - melody (ringer melody) . . . . . 42
  - time . . . . . 15, 41
  - wake-up time . . . . . 38
- Setting up
  - handset . . . . . 12
- Shortcut . . . . . 24, 29
- Snooze (alarm clock) . . . . . 38
- Specifications . . . . . 47
- System settings . . . . . 43

**T**

- Talk key . . . . . 1, 26
- Telephone jack, pin connections. . . . . 48
- Telephone system
  - setting pauses . . . . . 45
- Touch-tone dialing . . . . . 45

**U**

- Unknown caller. . . . . 26

**V**

- Viewing the network mailbox report . . . . . 37
- Volume
  - earpiece volume . . . . . 41
  - handset handsfree volume . . . . . 41
  - ringer melody . . . . . 42, 44

**W**

- Warning tone (battery) . . . . . 43
- Writing and editing a text message . . . . . 48