

Automatic handset registration

To start the automatic registration of your handset, please place the handset in the base with the **display facing outwards**.

The registration can take up to 5 minutes!

Please do **NOT** remove your headset from the base station during the registration procedure.

During this time **Registering** will appear on the display.

The registration is complete when you see **"1"** on the display.

Now please continue **directly** with the storage of the local area code (see the Chapter „Area codes“ in your user manual). This step is not essential.

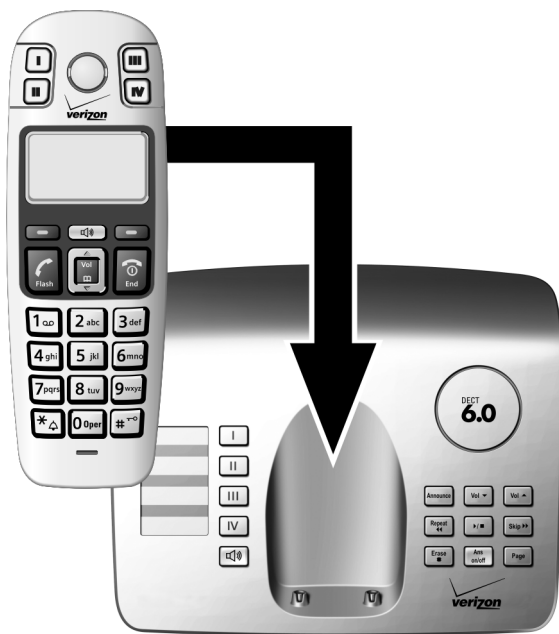

However, if you skip the step, the complete functions of the local area codes will not be available.

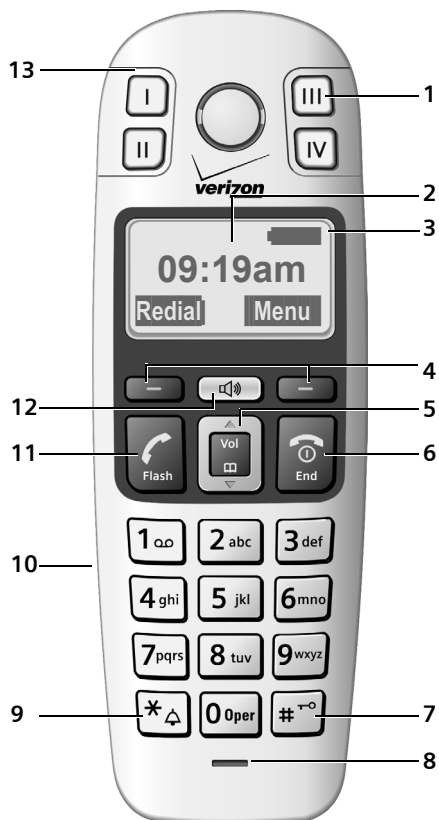

The handset at a glance

The handset at a glance



- 1 **Direct Dialing keys (II to IV)**
Key II: factory preset for internal calls
- 2 **Display in idle status (example)**
- 3 **Battery charge level**
 (1/3 charged to fully charged)
 Flashes: batteries almost dead
 Flashes: battery charging
- 4 **Display keys (page 18)**
- 5 **Control key (page 17)**
- 6 **End Call key, On/Off key**
End call, cancel function, go back one menu level (press briefly), back to idle status (press and hold), activate/deactivate handset (press and hold in idle status)
- 7 **Pound key**
Keypad lock on/off (press and hold in idle status, page 17)
Insert a dialling pause (press and hold)
Switch between uppercase/lowercase letters and digits for text entry (page 41)
- 8 **Microphone**
- 9 **Star key**
Ringers on/off (press and hold)
- 10 **Connection socket for headset (page 43)**
- 11 **Talk key / Flash**
Answer a call, start dialing
During a call: flash functionality
- 12 **Handsfree key**
Toggle between earpiece and handsfree mode
Lights up: handsfree activated
Flashes: incoming call
- 13 **Direct Dialing/SOS key with SOS LED**

Verizon V400AM base station at a glance

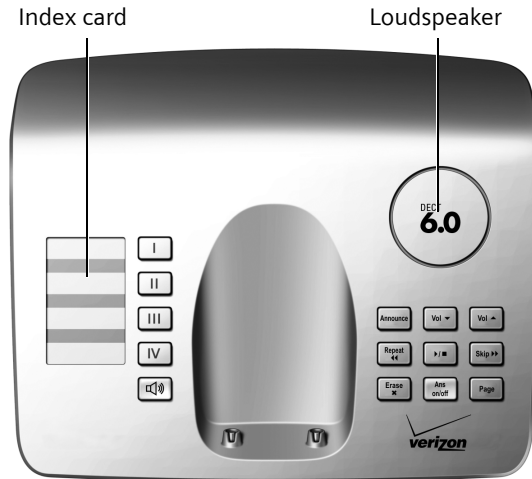

- Direct Dialing/SOS key** with SOS LED (see page 20)
- ... **Direct Dialing keys** (see page 20)
- Handsfree key:** answer/end a call
- Registration/Paging key:**
 - Page handsets (press briefly for paging: see page 28).
 - Register handsets (press and hold: see page 27).

Answer machine keys

- On/Off key:** activate and deactivate answer machine.
 - **Lights up:** answer machine is activated.
 - **Flashes:** there is at least one new message, or a message is being recorded.
 - **Flickers for about four seconds:** memory is full.
- Playback/Stop key:** Play back messages from the answer machine or cancel playback.
- Forward key:** Skip to next message.
- Back key:** Skip to previous message.

- Delete key:** Delete the current message during message playback, or delete all old messages in idle status.

- Announcement key:** Record, play back, and delete a personal announcement.
 - Press and **hold:** record announcement. Press again to end recording.
 - Press **briefly:** play back announcement.

If desired, delete announcement during playback using .

- Volume keys:** adjust volume (= quieter; = louder)
 - **During message playback:** adjust loudspeaker volume.
 - **While an external call is being signaled:** adjust ringer volume.

Please remember:

- If you are operating the answer machine from a handset, or if the handset is recording a message, you cannot operate the handset from the base station.
- If the On/Off key flashes when the answer machine is switched off, there is still at least one new message that has not been played back.

Contents

Contents

Automatic handset registration	1
The handset at a glance	2
Verizon V400AM base station at a glance	3
Safety precautions	6
Special features of the Verizon V400AM	7
SOS mode	7
Verizon V400AM – more than just a telephone	9
First steps	9
Pack contents	9
Installing the base station	9
Connecting the base station	10
Setting up the handset for use	10
Area codes	13
Menu tree	14
Making calls	16
Making external calls and ending calls	16
Answering a call	16
Caller ID	16
Handsfree operation	17
Muting	17
Operating the handset	17
Switching the handset on/off	17
Activating/deactivating the keypad lock	17
Control key on the handset	17
Display keys	18
Returning to idle status	18
Menu guidance	18
Correcting incorrect entries	18
CID 2.5 services (network services)	19
Using the directory, Direct Dialing keys, and lists	19
Directory	19
Direct Dialing and SOS keys	20
Last number redial list	22

Opening the message list with the Display key	22
---	----

Operating the base station answer machine	24
Operation via the handset	24
Activating/deactivating call screening	26
Setting up the answer machine	26
Resetting fast access on the answer machine to Network Voice Mail	26
Using the network mailbox	27
Using the network mailbox to set fast access	27
Viewing your network mailbox messages	27
Using several handsets	27
Registering handsets	27
Locating a handset ("paging")	28
Making internal calls	28
Listening in on an external call	29
Handset settings	29
Changing the display language	29
Screensaver	29
Auto answer	29
Adjusting the loudspeaker volume	29
Changing ringers	30
Activating/deactivating suppression of the first ringer	30
Advisory tones	30
Using the handset as an alarm clock	31
Restoring the handset default settings	31
Base station settings	31
Changing the system PIN	31
Changing ringers	31
Restoring the base station to factory settings	32
Operating the base station on a PABX	32
Appendix	33
Symbols and typographical conventions used	33
Care	33

Contents

Contact with liquid 33
Troubleshooting 33
FCC / ACTA Information 34
Industry Canada Certification 36
Safety precautions 36
Service (Customer Care) 38
End User Limited Warranty 38
Technical data 41
Writing and editing a text message .. 41
Accessories 43
Wall mounting for base station . 43
Index 44

Safety precautions

Safety precautions

Caution:

Read the safety precautions and the user guide before use.

Explain their contents to your children, including the potential hazards associated with using the telephone.



Only use the power adapter supplied, as indicated on the underside of the base station.



Only use the **recommended rechargeable batteries** of the specific type indicated (page 41). Do not use any other battery type or non-rechargeable batteries, as this could result in significant health risks and personal injury.



Insert rechargeable batteries according to the correct polarity, and follow the instructions in this user guide (polarity symbols appear in the handset's battery compartment, page 10).



The operation of medical appliances may be affected. Be aware of your environment and its technical conditions, such as those in a doctor's office.



Do not hold the reverse side of the handset to your ear if the handset is ringing or if the handsfree function is switched on. Otherwise, you risk developing serious, permanent hearing damage.

The handset may cause an unpleasant humming noise in hearing aids.



Do not install the base station in the bathroom. The handset and base station are not splash proof (page 33).



Do not use the phone in environments with a potential explosion hazard, such as auto body paint shops.



If you give your telephone to someone else, make sure you include the user guide.



All electrical and electronic products must be disposed of separately from the municipal waste stream using collection facilities designated by the relevant city or local authority.

This crossed-out wheeled garbage can symbol on the product means the product is covered by the European Directive 2002/96/EC.

The correct disposal and separate collection of your old device will help prevent potential negative consequences for the environment and human health. This is a precondition for reuse and recycling of used electrical and electronic equipment.

For more detailed information about disposing of your old device, please contact your relevant city agency, a waste disposal service, or the store where you purchased the product.

Note:

Not all of the functions described in this user guide are available in all countries.

Special features of the Verizon V400AM

- ◆ Large keys
- ◆ Text and symbols display clearly in large type on the screen
- ◆ Jumbo Font
- ◆ SOS mode
- ◆ Direct dialing keys
- ◆ Internal calls between handset and base station
- ◆ Voice prompted answer machine
- ◆ Compatibility with hearing aids (HAC – Hearing Aid Compatibility)
- ◆ Connection for headset (headset not included)
- ◆ Index card for labeling the SOS/Direct Dialing keys (reverse side of user guide)

SOS mode

Your Verizon V400AM is equipped with a special **SOS function** or SOS procedure. Use this SOS function to request assistance in case of emergency. You can store up to **four SOS numbers**.

SOS numbers can be stored in **SOS/Direct Dialing key I**. In the event of an emergency, you only have to press **Direct Dialing key I**. The SOS procedure is initiated when you press this key.

The SOS procedure automatically dials the first SOS number you entered. If this number is busy or if the person called is not at home, the SOS procedure automatically dials the next SOS number.³

To use the SOS procedure, you have to first program **SOS/Direct Dialing key I** and activate **SOS mode** (page 20).





When SOS mode is activated, the SOS LED lights up permanently on the SOS keys of the handset and base station.

SOS mode

SOS procedure

The SOS procedure operates as described below.

Press the SOS/Direct Dialing key  of the **base station** and the device **immediately dials**.

You must **press and hold** the SOS/Direct Dialing key  of the **handset** to **immediately launch the function**.

If you just press the key briefly and don't hold it down, you must confirm with **Yes** to prevent an emergency call from being initiated inadvertently.

The first SOS number is dialed as soon as you press the SOS Direct Dialing key. At the same time, the message "*Emergency call being sent*" is played back over the loudspeaker.

If the SOS call is answered, the called party automatically hears the message "*This is an emergency call.*" Your name is then announced after this message. You must have programmed the SOS key accordingly for your name to be announced (see page 20). This is followed by the message "*To answer the emergency call, please press key 5.*" If the called party now presses key 5, you can converse with one another.

If the called party does not answer the call, for example, the called party is not at home or his or her answer machine is on, the SOS procedure automatically dials the next SOS number. In the following cases, the SOS procedure automatically calls the next SOS number after 60 seconds:

- ◆ The call is not answered
- ◆ The answer machine for the selected SOS number is on
- ◆ The SOS number is busy

The procedure is repeated at most four times. If none of the calls is answered, the SOS procedure is ended with an error tone.

Recipients of the emergency call must have set their telephones to tone dialing, otherwise confirmation of the SOS call with key 5 will not be recognized.

i

- During the entire procedure, all SOS keys flash on all registered handsets and on the base station. The message "*Emergency call being sent*" is displayed on the handset that initiated the emergency call.
- If an internal call is also programmed, the SOS call can also be answered by an internal user. The text "*Emergency call*" is displayed on all registered handsets and the base station.
- You should perform a test run of the SOS procedure to ensure that SOS mode is programmed correctly. The police, emergency services, or fire department must not be used for a test run.
- Please note that the standby time of the handset will be reduced when SOS mode is activated.
- The SOS LED lights up permanently when SOS mode is activated.

Verizon V400AM – more than just a telephone

Your phone not only enables you to store up to 100 telephone numbers (page 19), it can do a whole lot more:

- ◆ You can program the keys of your phone with important phone numbers. A programmed number is then dialed by simply pressing the corresponding key (page 20).
- ◆ Use the handsfree function (page 17) to keep your hands free when making a call.
- ◆ Use your handset as an alarm clock (page 31)
- ◆ Select 12- or 24-hour format for displaying the time (page 12) .

ECO DECT – What does it mean?

ECO DECT reduces power consumption by using a power supply with low power consumption and also reduces the transmission power of the base station when only one handset is registered on the base station.

Also, your handset automatically reduces transmitting power depending on its distance to the base station (close-up range).

Have fun using your new phone!

Verizon V400AM – more than just a telephone

First steps

Pack contents

The product includes one Verizon V400AM base station, one handset, one power adapter, one telephone cable, two batteries, one battery cover, one belt clip, and a user guide.

Installing the base station

The base station is designed for operation in enclosed, dry areas at temperatures ranging from +5 °C to +45 °C.

Set up or wall mount the base station at a central location in your home.

Please refer to the end of the user guide for information on wall mounting the base station.

Please remember:

- ◆ Never expose the telephone to heat sources, direct sunlight, other electrical appliances.
- ◆ Protect your telephone from moisture, dust, corrosive liquids, and vapors.

First steps

Connecting the base station

- ▶ First connect the power adapter and then the phone jack as shown below, and place the cables into the cable recesses.

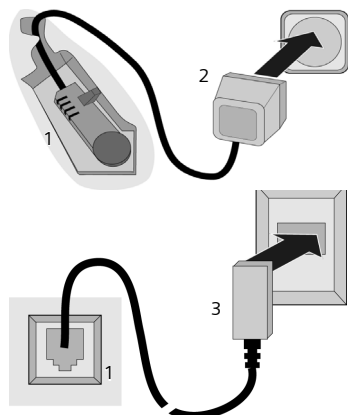

- 1 Underside of the base (partial view)
- 2 110-V power adapter
- 3 Phone jack with phone cord

Please note:

- ◆ This phone requires at least a 26 AWG telecommunication line cord.
- ◆ The power adapter must be **always connected**, as the phone will not operate without an electrical connection.

Setting up the handset for use

Inserting the batteries and closing the cover

Caution:

Use only rechargeable UL approved AAA batteries. Never use conventional (non-rechargeable) batteries or other battery types as this may cause significant damage to health and property. For example, the outer casing of the batteries could be destroyed or the batteries could explode. The phone could also malfunction or be damaged as a result of using batteries that are not of the recommended type.

- ▶ Insert the batteries according to the correct polarity (see diagram).

The polarity is indicated in the battery compartment.

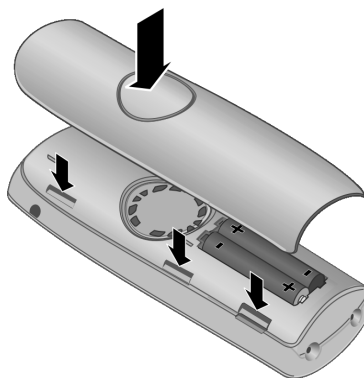

- ▶ First align the notches on the side of the battery cover with the lugs on the inside of the casing.
- ▶ Then press the cover so that it clicks into place.

Attaching the belt clip

There are notches for attaching the belt clip on the side of the handset at the same height as the display.

- ▶ Press the belt clip onto the back of the handset so that the protrusions on the belt clip engage the notches.

You can also attach a cord for carrying the handset in your hand or wearing it around your neck.

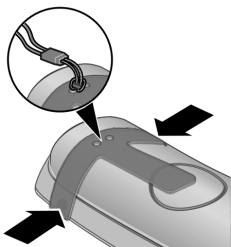

Opening the battery cover

- ▶ Remove the belt clip, if necessary.
- ▶ Reach into the housing cavity and pull the battery cover upwards.

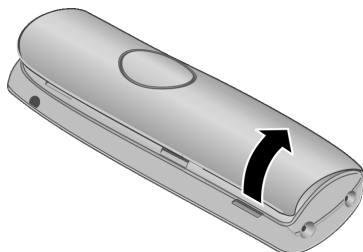

Placing the handset into the base station and registering

Important: the handset must not already be registered to **any** base station.

Registering the handset to the Verizon V400AM base station occurs automatically.

- ▶ Place the handset in the charging cradle of the base station with its **screen facing forward**.

You will hear a confirmation tone.

Automatic registration can take up to 5 minutes. While registration is in progress the screen displays **Registering**. The handset will be assigned the lowest unassigned internal number (1–4). If several handsets are registered to the base, the internal number is shown on the screen after registration (for example, 2). This means that the handset has been assigned the internal number 2.

Notes:

- Automatic registration is only possible when the base station you want to register the handset to is not being used to make a call.
- Pressing a key cancels automatic registration.
- If four handsets are already registered to the base station, there are two options:
 - The handset with the internal number 4 is put on idle status: the handset you want to register is assigned the number 4. The handset that was previously number 4 is de-registered.
 - The handset with internal number 4 is in use: the handset you want to register cannot be registered.
- If automatic registration does not work, the handset must be registered manually (page 27).

- ▶ To charge the batteries, leave the handset in the charging cradle of the base station.



Notes:

- The handset must only be placed in the base/charging cradle provided for it.
- If the handset switches off because its batteries are dead, it will automatically switch on again when it is placed into the base station.

For questions and troubleshooting, see page 33.

First steps

Initial charging and discharging of batteries

Battery charging is indicated in the upper right corner of the display by a flashing battery icon , , or . During handset operation, the battery icon indicates the charge status of the batteries (page 2).

The correct charge status can only be displayed after the batteries have first been fully charged **and** then discharged through use.

- ▶ To do this, leave the handset in the base without interruption until the battery icon stops flashing on the screen (approx. 6 hrs).
- ▶ Once the batteries have fully charged, remove the handset from the charging cradle and do not put it back again until the batteries have fully discharged.

Note:

After the first battery charge **and** discharge cycle, you can place your handset in its base after every call.

Please remember:

- ◆ Always repeat the charging and discharging procedure if you remove the batteries from the handset and reinsert them.
- ◆ The batteries may warm up as they are charging. This is not dangerous.
- ◆ For technical reasons, the charge capacity of the batteries will decrease after a certain period of time.

Note:

The appendix contains explanations of the symbols and typographical conventions used in this user guide (see page 33).

Date and time

Setting the time format

You can set the date/time to the American format (12-hour display and the MM/DD/YY date format, factory settings) or to the European format (24-hour display and the DD/MM/YY date format).

Menu → **Settings** → **OK** → **Date/Time**
 → **OK** → **Time Format** → **OK**
 → **Europe [24h]** or **US [12h]** → **OK** (12 = on)

Setting the date and time

Menu → **Settings** → **OK** → **Date/Time**
 → **OK** → **Set Date/ Time** → **OK**



Enter the month, day and year using 6 digits and then press **OK**. Use  to move between the fields.



Enter hours and minutes using 4 digits (e.g. 07 15 for 07:15) and press **OK**. Use  to move between the fields.

12-hour time format:

Press **am/pm** to switch between am and pm.

Once the phone is registered and the time set, the idle display looks as shown on page 2.

Area codes

In order to call back a caller using the incoming calls list (page 23), your phone's **area code** ("local area code") must be stored. If your phone is in a "multiple area code" area, the **extra codes** for this area must also be stored.

Local Area Code

Menu → Settings → OK → Base → OK
→ Local Area Code → (Enter number)
→ OK

Extra Codes

Menu → Settings → OK → Base → OK
→ Extra Codes → (Enter number)
→ OK

Repeat the above steps until all extra codes for your area have been entered. A maximum of 5 extra codes can be stored.

Your phone is now ready to use.

The answer machine is set with a standard announcement.

Menu tree

Menu tree

There are two ways to select a function:

Using number combinations ("shortcuts")

- ▶ To open the main menu, press **Menu** with the handset in idle status.
- ▶ Enter the number combination that is in front of the function in the menu tree.
- ▶ **Example:** **Menu** **6** **mm** **3** **def** for "Set handset language."

Scrolling through menus (also see page 33)

- ▶ To open the main menu, press **Menu** with the handset in idle status.
- ▶ Scroll to the required function with the Control key and then press **OK**.

1 Directory

2 Calls

4 Alarm Clock

4-1	Activation
4-2	Wakeup time

5 Audio Settings

5-1	Handset Volume		
5-2	Handsfree Volume		
5-3	Ringer Volume		
5-4	Ringer Melody	5-4-1	External Calls
		5-4-2	Internal Calls
		5-4-3	Alarm Clock
5-5	Advisory Tones		
5-6	Battery Low	5-6-1	Off
		5-6-2	On
		5-6-3	During Call
5-7	Headset Volume		

6 Settings

6-1	Date/Time	6-1-2	Set Date/ Time		
		6-1-2	Time Format		
6-2	Direct Diall. Keys				
6-3	Language				
6-4	Jumbo Font				
6-5	Emergency Call Mode				
6-6	Emergency Numbers				
6-7	Handset	6-7-1	Screen Saver		
		6-7-2	Auto Answer		
		6-7-3	Register Handset		
		6-7-4	Reset Handset		
6-8	Base	6-8-1	Audio Settings	6-8-1-1	Loud Speaker
				6-8-1-2	Ringer Volume
				6-8-1-3	Ringer Melody
		6-8-2	System PIN		
		6-8-3	Base Reset		
		6-8-4	Listening in		
		6-8-5	Local Area Code		
		6-8-6	Extra Codes		

7 Voice Mail



7-1	Set Key 1	7-1-1	Network Mailbox		
		7-1-2	Answer Machine		
7-2	Answer Machine				
7-3	Call Screening	7-3-1	Handset		
		7-3-2	Base		
7-4	Announcements	7-4-1	Record Announce.		
		7-4-2	Play Announce.		
		7-4-3	Delete Announce.		
7-5	Message Length	7-5-1	Maximum		
		7-5-2	30 sec		
		7-5-3	60 sec		
		7-5-4	120 sec		
7-6	Ring Delay	7-6-1	Immediately		
		7-6-2	10 sec		
		7-6-3	20 sec		
		7-6-4	30 sec		
		7-6-5	Auto		



Making calls

Making calls

Making external calls and ending calls

External calls are calls using the public telephone network.

 (Enter phone number) → .

The number is dialed. (Also, you can **first** press the  key [ringer] and then enter the number.) You can adjust the earpiece volume during the call using the  key.



End a call or cancel dialing:

Press the End Call key  or place the handset in the base station or charging cradle.

Answering a call

The handset indicates an incoming call in three ways: by ringing, by displaying a message on the screen, and by flashing the Handsfree key .

You can answer the call by:

- ▶ Pressing the Talk key .
- ▶ Pressing the Handsfree key .
- ▶ Pressing the Display key **Accept**.

If the handset is in the base and the **Auto Answer** function is activated (page 29), the call will be answered automatically when you lift the handset from the base.

Press the display key **Silence** to mute the ringer without answering the call. You can answer the call as long as the call is displayed on the screen.

Caller ID

When you receive a call, the caller's number and/or name is displayed on the screen if the following conditions are met:

- ◆ Your network provider supports CIP, CI and CNIP.
 - CI (caller ID): the caller's number is transmitted.
 - CIP (caller ID presentation): the caller's number is displayed.
 - CNIP (Calling Name Identification Presentation): the caller's name is displayed.
- ◆ You have arranged for CIP or CNIP with your network provider.
- ◆ The caller has arranged for CI with the network provider.

Displaying the caller's number





The caller's phone number displays on the screen. Or the caller's phone number and name displays if the name has been stored in the directory or CNIP has been arranged.

Requirements:

1. You have arranged with your network provider to have the caller's phone number (CIP) or name (CNIP) displayed on your screen.
2. The caller has arranged with the network provider to allow his or her phone number to be identified (CI).

The screen displays **Extern. Call** if you have not arranged for calling line identification presentation, **Withheld** if calling line identification has been withheld by the caller, or **Unavailable** if it has not been arranged with the network provider.

Handsfree operation

After entering the phone number, you can make immediate calls (the  key lights up permanently) in handsfree mode by pressing the Handsfree key . Toggle between earpiece and handsfree mode during a call and when playing back the answer machine by pressing the  key. You can adjust the volume during handsfree operation using the  key.

Muting

You can deactivate the microphone in your handset during an external call:

- Mute** Press the display key on the left to mute the handset.
- On** Press the display key to reactivate the microphone.

Operating the handset

Switching the handset on/off

-  Press and hold the End Call key.

You will hear the confirmation tone.

Activating/deactivating the keypad lock

-  Press and **hold** the pound key.

You will hear the confirmation tone. The icon  appears in the display when the keypad lock is activated.

Note:

- The handset displays an advisory message if you press a key by accident while the keypad lock is on. To deactivate the keypad lock, press the pound key  **and hold**.
- The keypad lock does not apply to the SOS key.

Control key on the handset





1 Control key



The side of the Control key to press in the given operating situation is shown in black (top, bottom) in this user guide. Example:  for "press the top of the Control key."

The Control key has a number of different functions:



When the handset is in idle status

-  Open the directory.
-  Adjust the ringer volume of the handset (page 30).



In lists and menus

-  /  Scroll up/down, line by line.

In an input field

-  /  Move the cursor **left** or **right**.

During an external call

-  Open the directory.
-  Adjust loudspeaker volume of earpiece and handsfree mode.

Operating the handset

Display keys

The current display functions are shown in the bottom display line in reversed high-lights. The functions of the display keys change depending on the particular operating situation.

Example:

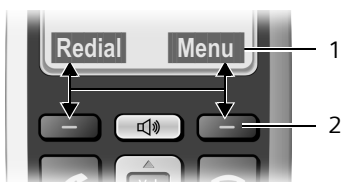

- 1 Current display key functions
- 2 Display keys

The most important display symbols are:

Back	Go back one menu level or cancel operation.
Menu	Open the main menu or a context-dependent menu.
OK	Confirm highlighted selection.
Delete	Delete key: backspace deletes one character at a time.
Redial	Open the last number redial list.

Returning to idle status

You can go back to idle status from anywhere in the menu: Press the End Call key  and **hold**.

If you do not press any key, the display will **automatically** revert to idle status after 2 minutes.

Changes that you have not confirmed/ stored by pressing **OK** will be rejected.

For an example of the display in idle status, see page 2.

Menu guidance

Your telephone's functions are accessed using a menu that has a number of levels.

Main menu (first menu level)

- ▶ To open the main menu, press **Menu** with the handset in idle status.

Accessing a function

- ▶ Scroll to the function with the Control key  and press **OK** or enter the digit that appears before the function in the menu overview (page 14).

The corresponding submenu (the next menu level) is opened.

Submenus

The functions in the submenus are displayed as lists.

To access a function:

- ▶ Scroll to the function with the Control key  and press **OK** or enter the digit combination that appears before the function in the menu overview (page 14).

Briefly pressing the End Call key  returns you to the previous menu level or cancels the operation.

Correcting incorrect entries

- ◆ Navigate to the wrong input with the Control key if  is displayed.
- ◆ Press **Delete** to delete the character to the left of the cursor.
- ◆ Insert a new character to the left of the cursor.
- ◆ When entering the time and date, etc., edit the flashing character.

The appendix contains explanations of the symbols and typographical conventions used in this user guide (page 33).

CID 2.5 services (network services)

If CID is activated and a waiting call is displayed, 4 different CID 2.5 services (network services) are selected.

During a call:

Menu Press the display key

Select with :

Take message

The waiting caller is forwarded to the central office mailbox.

Hold message

The waiting caller is put on hold and hears a message to this effect from the central office.

Call back

The waiting caller is prompted by the central office to call again at a later time.

Add 2nd

The central office is prompted to initiate a conference call.

Using the directory, Direct Dialing keys, and lists

Using the directory, Direct Dialing keys, and lists

A directory, last number redial list, calls list, and answer machine list are available.

You can save up to 100 entries in the directory.

You can create a personalized directory for your particular handset. However, you can send the list or individual entries to other handsets (page 20).

Directory



You can store numbers and the associated names in the **directory**. With the handset in idle status, open the directory by pressing the  key.

Length of an entry



Number: max. 22 digits

Name: max. 16 characters

Storing the first number in the directory

 → Dir empty New entry? → **OK**
 →  (Enter number) → **OK**
 →  (Enter name) → **OK**



Storing a number in the directory

 → **Menu** → New Entry → **OK**
 →  (Enter number) → **OK**
 →  (Enter name) → **OK**

Selecting a directory entry



 Open the directory.

You have the following options:

- ◆ Use  to scroll to the entry until the desired name is selected.
- ◆ Enter the first character of the name, or scroll to the entry with , if necessary.

Using the directory, Direct Dialing keys, and lists



Dialing with the directory

 →  (Select entry; page 19) → 

Managing directory entries

You have selected an entry (page 19).

Editing entries

Menu → **Edit Entry** → **OK** →  (Change number, if required) → **OK** →  (Change name, if required) → **OK**

Using other functions

The following functions can be selected with **Menu** → :

Use Number

Edit or add to a stored number. Then dial or use other functions with **Menu**.

Show Number

Show number.

Delete Entry

Delete selected entry.

Send Entry

Send a single entry to another handset (page 20).

Delete List

Delete **all** directory entries.



Send List

Send the complete list to another handset (page 20).

Sending the directory to another handset

Requirements:

- ◆ The sending and receiving handsets must both be registered to the same base station.
- ◆ The other handset and base station can send and receive directory entries.

 →  (Select entry; page 19)
→ **Menu** → **Send Entry / Send List**
→ **OK** →  (Enter the internal number of the receiving handset)
→ **OK**

A successful transfer is confirmed by a message and confirmation tone on the receiving handset.

Adding a displayed number to the directory

You can copy any numbers to the directory that appear in a list, for example, the calls list or the last number redial list.

If you arranged Caller ID/Name with your network provider, the first 16 characters of the transferred name are also copied to the **Name** line.

A number is displayed.

Menu → **Copy to Directory** → **OK**

- ▶ Complete the entry (page 19).

The message playback is interrupted during the number transfer from the answer machine list.

Direct Dialing and SOS keys

You can store particularly important phone numbers, for example, emergency numbers, in the four **Direct Dialing keys**. You can program the Direct Dialing key I for SOS calls.

Dial the stored direct dialing number

- ◆ **On the base station** by pressing the corresponding Direct Dialing key,
- ◆ **On the handset** by pressing the corresponding Direct Dialing key and the Talk key .

To initiate an SOS call, proceed as described in the section "SOS procedure" (page 8).

Refer to the **font table** (page 42) for information on how to enter the text correctly.

The programmed assignment of the Direct Dialing keys and the SOS key applies to both the handsets and the base station.

Note:

The SOS key works even if the keypad lock is switched on.

Storing/changing Direct Dialing/SOS keys

You can assign external phone numbers and the internal call function to the Direct Dialing keys. You should program Direct Dialing key I for SOS calls (page 21).

Menu → **Settings** → **OK** → Direct Dial.
Keys → **OK** → I: <no entry> → 
 Select Direct Dialing key (I to IV)

Entering/changing an entry

You have selected a Direct Dialing key.

Menu → **Edit Entry** → **OK**

 Enter or edit the number, if required, then press **OK**.

 Enter or edit the name, if required, then press **OK**.

Using other functions

The following functions can be selected with **Menu** → :

Delete Entry

Delete selected entry.

Call. Home Internal

Pressing this key results in all registered handsets and the base station being called.

Use Number

Edit or add to a stored number. Then dial or use other functions with **Menu**.

Note:

When a phone number is displayed on the screen, you can program it into an unassigned Direct Dialing key by pressing and **holding** the relevant Direct Dialing key.

Programming SOS mode

Requirement: SOS mode is not activated.

Menu → **Settings** → **OK** → Direct Dial.
Keys → **OK** → I: <no entry> (Direct Dialing key I selected) → **Menu**
 → **Emergency Call Mode** → **OK**

If SOS mode has already been activated and is then reactivated, **Change no./ name?** appears on the screen. Respond to the request

Using the directory, Direct Dialing keys, and lists

- ◆ With **Yes** to continue the procedure
- ◆ With **No** to continue with **Label with Internal Call**

 Enter or edit the number, if necessary, and press **OK**.

 Enter or edit the name, if required, and press **OK**.

Further number?

Confirm with **Yes** to enter additional SOS numbers. You can enter up to four SOS numbers.

Label with Internal Call

Confirm with **Yes** to initiate an internal call in addition to the stored numbers when the SOS key is pressed.

Record own name/addr.

Confirm with **Yes** to record a message (e.g., name and address), which will be announced automatically to the called party after pressing the SOS key. The message is played back for confirmation and can be changed or deleted.

SOS mode is activated.

Note:

After the SOS procedure has been programmed, you should test the functionality.

Changing/deleting SOS numbers

Requirement: SOS mode is activated.

Menu → **Settings** → **OK** → **Emergency Numbers** → **Menu** → **Edit Entry/Delete Entry** → **OK**

Now change or delete the desired entries.

If your telephone is connected to a PABX, you may have to enter the access code (external line prefix) as the first digit of your entry (see the user guide for your PABX).

Using the directory, Direct Dialing keys, and lists

Note:

The emergency call text that the recipient of your emergency call hears consists of two or three text parts. The called party first hears part-1 text, then part 2, and finally part 3. If you have not added any personal emergency call text (part-2 text), the emergency call only comprises part-1 and part-3 text.

- Part-1 text (predefined by default):
"This is an emergency call"
- Part-2 text (personal emergency call text):
You can say this text yourself (see page 21).
For example, you can state your name and address. Example:
"This is John Smith, 8 Church Road"
- Part-3 text (predefined by default):
"To answer the emergency call, please press key 5"

Switching SOS mode on or off



Menu → **Settings** → **OK** → **Emergency Call Mode** → **OK** (☑ = on)

After switching to SOS mode, proceed as described in the section **Programming SOS mode** (page 21).

Last number redial list

The last number redial list contains the last ten numbers dialed with the handset (max. 22 numbers). If one of the numbers is in the directory, then the corresponding name will be displayed.

Dialing from the last number redial list

- Redial** Press the Display key.
-  Select an entry.
-  Press the Talk key. The number is dialed.

Managing entries in the last number redial list

Redial Press the Display key.

 Select an entry.

Menu Press the Display key.

The following functions can be selected with :

Use Number (as in the directory, page 20)

Copy to Directory (as in the directory, page 20)



Delete Entry (as in the directory, page 20)

Delete List (as in the directory, page 20)

Opening the message list with the Display key

You can use the Display key  to open the the answer machine list, the network mailbox (if your network provider supports this function and the network mailbox is set up for fast access – see page 27), and the calls list.

An advisory tone sounds as soon as a **new entry** appears on a list. A message displays on the screen. If you press the Display key , you will see all the lists that contain new messages. If only one list contains new messages, the list will automatically open. Press any key and the notification of new messages will no longer display.

The display key  is faded out when you exit the list. You can access the answer machine list by pressing key  on the handset (if the handset is set up for fast access) or the keys of the base station; the calls list can be opened via the menu (see page 14). The Display key  becomes available again after making a new entry to one of the lists.

Note:

If calls are stored in your network mailbox, you will receive a message if the appropriate settings have been made (see the network mailbox instructions of your network provider).

Calls/answer machine list

Requirement: CIP (page 16)

Depending on the list type selected, the calls list contains

- ◆ Answered calls
- ◆ Answer machine calls

Depending on the list type selected, the last 20 answered calls are stored.

The list is displayed as follows:

Calls List: 01+02 Voice Mail: 01+02

Number of new messages + number of old, read, or played back messages.

Selecting the list type for the calls list

Menu → **6** miss **8** new **9** read **1** old **0** over
 → Enter digits: **2** all = all calls → **OK**

The entries in the calls list are saved when you change the list type.

Opening the calls/answer machine list

Envelope → **Calls List: / Voice Mail: 01+02**
 → **OK**

Phone Select entry.

The last call received is displayed as the first entry in the **calls list**.

The first new message received is displayed as the first entry in the **answer machine list**. The playback starts.

New messages are placed after old messages after they have been played back.

Using the directory, Direct Dialing keys, and lists

List entry

Example of a list entry:

New Call
1234567890
Back ◆ **Menu**

- ◆ Status of entry

In the calls list

New Call: new missed call.

Old Call: entry already read.

Only for list type "All Calls":

Call Recv.: Call was answered.

Answer M.: The answer machine answered the call. A message was left.

In the answer machine list

New Msg.: New message on the answer machine.

Old Msg.: Previously heard message on the answer machine.

- ◆ Number or name of caller

You can add the number of the caller to the directory (page 20).

You can delete the current entry from

Menu → **Delete Entry**.

If set, you can show the date and time of the call (see page 12) from **Menu** → **Date and Time**.

Dialing from the calls list

Open the calls list (see page 23).



Select an entry.



Press the Talk key. The number is dialed.

Deleting the calls list

Caution! All **old and new** entries will be deleted.

Menu → **Calls List:** → **OK** → **Menu**
 → **Delete List** → **OK**



Press and **hold** (idle status).

Note:

To delete old messages from the answer machine list, see page 25.

Operating the base station answer machine

Operating the base station answer machine



You can operate the answer machine via the handset or using the keys on your base station (page 3).

Operation via the handset

The handset loudspeaker activates **automatically** if you receive an acoustic prompt or message while operating. You can switch it off with the Handsfree key .

Switching answer machine on/off

Menu → **Voice Mail** → **OK** → **Answer Machine** → **OK** (if = on)

After switching on, the remaining memory time is announced. The  icon appears on the display. The  key lights up on the base station.

The telephone is supplied with a prerecorded announcement. This prerecorded announcement is used if no personal announcement is available.

If the memory is full, the answer machine automatically switches itself off. It reactivates automatically when you delete old messages.

Recording your own announcement

Menu → **Voice Mail** → **OK** → **Announcements** → **OK** → **Record Announcement** → **OK** → **Start recording?** → **OK**

You hear the ready tone (short tone).

- ▶ Now record your announcement (at least 3 sec.).

Note:

Announcements must be made speaking directly into the microphone of the handset as if making a call.

Cancel recording with  or **Back**. Restart the recording with **OK**.

OK Press the display key to end the recording.

After recording, the announcement is played back for you to check.

Please remember:

- ◆ Recording ends automatically when the maximum recording time of 170 seconds has been reached or if there is silence for more than two seconds.
- ◆ If you cancel the recording, the prerecorded announcement is then used.
- ◆ The recording is canceled if the answer machine memory is full.
 - ▶ Delete old messages and repeat recording if required.

Playing back announcements

Menu → **Voice Mail** → **OK** → **Announcements** → **OK** → **Play Announcement** → **OK** →  **press and hold** (idle status)

You will hear the prerecorded announcement if you have not recorded one of your own.

Deleting announcements

Menu → **Voice Mail** → **OK** → **Announcements** → **OK** → **Delete Announcement** → **OK**

The prerecorded announcement is used again after a personal announcement has been deleted.

Playing back messages

The date and time of each message is logged (provided this has been set – see page 12). If Caller ID is activated, then the caller's number or name is displayed. If the caller's number is stored in the directory, the corresponding name is displayed.

Playing back new messages

New messages that have not yet been heard are indicated by a message on the screen. The  key flashes on the base station.

Press the Display key .

Voice Mail: 01+02

Select as desired and press .



Playback begins with the first new message.

Playing back old messages

See answer machine list (page 23).

Stopping and controlling playback

During message playback:

 Pause playback. Press  again to resume.

 Go to the start of the current message.

2 x  Go to previous message.

 Go to next message.

2 x  Go to message after next.



After an interruption lasting more than one minute, the answer machine returns to idle status.

Operating the base station answer machine

Marking a message as new

You can mark a message you have already heard as new.

During message playback:

 → **Mark as new** → 

Adding the telephone number of a message to the directory

See "Adding a displayed number to the directory" on page 20.

Deleting messages

You can delete old messages either all at once or individually.

Deleting all old messages

During playback or pause:

 → **Delete all** → 



Deleting individual old messages

During playback:

 Press the display key.

Answering a call from the answer machine

You can take a call while the answer machine is recording it.

 /  Press the Talk or Handsfree key.

Recording stops and you can speak to the caller.

If two seconds of the call have already been recorded when you pick it up, the call will be displayed as a new message.

You can answer the call even if it is not signaled on the handset.

Operating the base station answer machine

Activating/deactivating call screening

While a message is recording, you can listen to it on the loudspeakers in the base and on the registered handsets.

Permanently activating/deactivating call screening

Menu → **Voice Mail** → **OK** → **Call Screening** → **OK** → **Handset / Base** → **OK** (✔ = on)

Call screening can be activated simultaneously on the **Base** and on the **Handset**.

Switching off call screening for the current recording



Press the End Call key.

Setting up the answer machine

The answer machine has already been preset at the factory. Set up individual settings using the handset.

Setting up call answering

You can set when you want the answer machine to answer a call.

Menu → **Voice Mail** → **OK** → **Ring Delay** → **OK**



Immediately / 10 sec / 20 sec / 30 sec / Auto. Select and press **OK** (✔ = on).

The following applies to answering calls using **Auto**:

- ◆ If no new messages are present, the answer machine accepts a call after **20 seconds**.
- ◆ If new messages are present, the answer machine answers a call after **10 seconds**.

Please remember:

You can set your telephone so that the **first ringer** is **suppressed** for all calls (page 30). In this case, the time selected for call answering predetermines how long the caller must wait before the answer machine answers the call.

Setting the recording time

You can set the maximum recording time for a message.

You can choose: **30 sec**, **60 sec**, **120 sec** or **Maximum**.

Menu → **Voice Mail** → **OK** → **Message Length** → **OK** → Choose the recording time → **OK** (✔ = on)

Changing the language of voice prompting and the prerecorded announcement

Menu → **6msg** **8txt** **9msg** **2abc** → Enter the digit for the required language:

1aa

OK

Set American-English.

2abc

OK

Set Canadian-French.

3mex

OK

Set Mexican-Spanish.

Resetting fast access on the answer machine to Network Voice Mail

The integrated answer machine is factory set for fast access. However, if you have set the network mailbox for fast access (page 27), you can reset this setting.

Menu → **Voice Mail** → **OK** → **Set Key 1** → **OK** → **Answer Machine / Network Mailbox** → **OK**

After you have selected the network mailbox or the answer machine, press and hold key **1**. You will be connected directly.

The setting for fast access applies to all registered handsets.

Using the network mailbox

The network mailbox is your network provider's answer machine. You cannot use the network mailbox unless you have **requested it** from your network provider.

Using the network mailbox to set fast access

With fast access, you can dial either your network mailbox or the integrated answer machine directly.

The integrated answer machine is preconfigured for fast access. You can configure the network mailbox by obtaining information from your network provider.

Configuring your network mailbox for fast access, and entering the network mailbox number

Menu → **Voice Mail** → **OK** → **Set Key 1**
 → **OK** → **Network Mailbox** → **OK** (r/v = on)
 → Enter the number of the network mailbox → **OK**

This setting is now valid for all registered handsets.

Calling your network mailbox

 Press and **hold**. This connects you directly to your network mailbox.

Viewing your network mailbox messages

When a message arrives, you will receive a call from the network mailbox. If you have signed up for Caller ID, the display shows the network mailbox number. If you accept the call, the new messages are played back. If you do not accept the call, the network mailbox number will be stored in the list of missed calls (page 23).

Using several handsets

Registering handsets

You can register up to four handsets to your base station.

Automatically registering the handset to the Verizon V400AM base station, see page 11.

Manually registering the handset to the Verizon V400AM

You must activate manual registration of the handset to both the handset and the base station.

After registration, the handset returns to idle status. If several handsets are registered to the base, the internal number of each is shown on the screen after registration (for example, 2).

The registration process is canceled after 60 seconds. If the handset has not registered within that time, repeat the process.

On the handset

Menu → **Settings** → **OK** → **Handset**
 → **OK** → **Register Handset** → **OK**
 → Enter system PIN of base station (default status: 0000) → **OK**

On the base station

 Press and hold the Registration/Paging key on the base station (page 3) (min. 1 sec.).

Registering other handsets

You can register other handsets and handsets for other devices with GAP functionality as follows.

On the handset: Begin registering the handset as described in its user guide.

On the base station: Press and **hold** the Registration/Paging key  of the base station (page 3) (min. 1 sec.).



Using several handsets

Locating a handset ("paging")

You can locate your handset using the base station.

- ▶ Press the Registration/Paging key  of the base station (page 3) **briefly**.
- ▶ All handsets will ring at the same time ("paging"), even if the ringers are switched off.



Ending paging

Briefly press the Registration/Paging key  of the base station (page 3) or press the Talk key  of the handset.

Making internal calls

Internal calls are free calls between handsets that you have registered on the same base station or calls between a handset and the base station. To be able to initiate an internal call, one of the Direct Dialing keys must be programmed for internal calls (see page 20). Direct Dialing key  is factory preset for internal calls.

Calling other handsets



Press the relevant Direct Dialing key ( ... ), which is programmed for internal calls when the handset or base station is in idle mode. If the internal call is initiated from the base station, all handsets are immediately called. If the internal call is initiated from the handset, the query **Call home internal?** must be acknowledged with **Yes**. You will see the message **Calling all handsets** on the screen.

Note:

If no user connects, the handset or the base station switches to idle mode after 3 minutes.

Answering internal calls

Your phone rings and the internal number of the caller is displayed on the screen (for example, 2). If the call is coming from the base station, 0 is displayed.

Press the Talk or Handsfree key  /  on the handset **or** the Handsfree key  on the base station to answer the call.

Ending a call



Press the End Call key  of the handset **or**  the Handsfree key of the base station.

Transferring a call to another handset/ internal consultation

You are calling an **external** subscriber.

- ▶ Initiate an internal call (see "Calling other handsets" on page 28). You can press the Display key **Back** during the internal call to connect again to the external subscriber.

When an internal party answers:





- ◆ **To transfer** the call to the internal party, press the End Call key  of the handset **or** the Handsfree key  of the base station.
- ◆ The internal party must end the call to **terminate the consultation**. You are reconnected with the external caller.

Note:

You can also press the End Call key  **before** connecting the internal caller. If the internal party does not answer, or their phone is in use, the call will automatically return to you.

Accepting a waiting call

If you get an **external** call while conducting an **internal** call, you will hear the call waiting tone (short tone). The caller's number or name will appear on the display if caller ID is enabled.

- ▶ Press the End Call key  of the handset **or** the Handsfree key  of the base station to end the internal call.
- ▶ Press the Talk key  of the handset **or** the Handsfree key  of the base station to answer the external call.

Listening in on an external call



You want to listen in on an existing external call.

Requirement: The **Listening in** function must be activated.



Activating/deactivating the function:

Menu → **Settings** → **OK** → **Base** → **OK**
→ **Listening in** → **OK** (✓ = on)

Listen in on call:

Press the Talk key  on the handset **or** the Handsfree key  of the base station. All participants hear a signal tone. **Conf. Call** is displayed on the handset screen.

Ending listening in:

Press the End Call key  of the handset **or** the Handsfree key  of the base station so that all participants hear a signal tone.

If the **first** internal participant presses the End Call key , the handset that has 'listened-in' remains connected to the external caller.

Handset settings

Your handset comes with default settings. You can change the individual settings.

Changing the display language

You can view the display texts in different languages.

Menu → **Settings** → **OK** → **Language**
→ **OK** →  (Choose language) → **OK**

The current language is indicated by ✓.

If you accidentally choose a language you do not understand:

Menu → **6msd** **3msd** →  (Choose language) → **OK**

Screensaver

When this function is activated, the time is displayed in digital in idle mode, filling the entire screen.

Menu → **Settings** → **OK** → **Handset** → **OK**
→ **Screen Saver** → **OK** (✓ = on)

Auto answer

When this function is activated, you can answer a call by simply lifting the handset out of the base without having to press the Talk key .

Menu → **Settings** → **OK** → **Handset** → **OK**
→ **Auto Answer** → **OK** (✓ = on)

Adjusting the loudspeaker volume

You can set the loudspeaker volume of handsfree operation and the earpiece volume to five different levels (1–5; e.g., volume 2 = .

Menu → **Audio Settings** → **OK**
→ **Handset Volume / Handsfree Volume**
→ **OK**

 Adjust the volume and press **OK**.



Adjust the volume during a call:

 Press the Control key.

 Adjust the volume and press **OK**.

Handset settings

Changing ringers

- ◆ Volume:
 - Five volume levels (1-5; e.g., volume 2 = ) and "off" (volume 0 = ).
- ◆ Melody:
 - List of preloaded ringers. The first three are classic ringers.

You can also set different melodies for the following functions:

- ◆ **External Calls:** External calls
- ◆ **Internal Calls:** Internal calls
- ◆ **Alarm Clock:** Alarm clock

For how to set the ringers for the base station, see page 31.

Setting ringer volume

The ringer volume is the same for all types of signaling.

Menu → **Audio Settings** → **OK**
 → **Ringer Volume** → **OK**
 →  (Adjust volume) → **OK**

Or in idle status:

 **Press briefly** →  (Adjust volume)
 → **OK**

Setting ringer melody

Set different ringer melodies for external calls, internal calls, and the alarm clock.

Menu → **Audio Settings** → **OK**
 → **Ringer Melody** → **OK** → **External Calls / Internal Calls / Alarm Clock** → **OK**
 →  (Select melody) → **OK** (✓ = on)

Activating/deactivating suppression of the first ringer

Menu → **6^{ring}** **8^{sup}** **9^{word}** **2^{alc}** **5^{jk}**
 → Enter digits: **0^{sup}** = make first ringer audible; **1^{sup}** = suppress first ringer → **OK**

Advisory tones

Your handset uses 'advisory tones' to inform you of different operations and statuses. The following advisory tones can be activated and deactivated independently of each other:

- ◆ **Advisory tones:**
 - **Key beep:** Each key press is acknowledged.
 - **Confirmation tone** (rising tone sequence): At the end of an entry/setting, when the handset is placed in the base station and on arrival of a new entry in the answer machine list or calls list.
 - **Error tone** (descending tone sequence): When you make an incorrect entry.
 - **Menu end tone:** When scrolling at the end of a menu.
- ◆ **Battery warning tone:** The battery needs recharging.

You cannot deactivate the confirmation tone sounded when placing the handset in the base station.

Activating/deactivating advisory tones

Menu → **Audio Settings** → **OK**
 → **Advisory Tones** → **OK** (✓ = on)

Setting the battery warning tone

Menu → **Audio Settings** → **OK**
 → **Battery Low** → **OK**
 → **On / Off / During Call** → **OK** (✓ = on)

The battery warning tone is activated/deactivated or only sounds during a call.

Using the handset as an alarm clock

Activating/deactivating the alarm clock

Requirement:

The time is set according to the chosen time format (12-hour or 24-hour format) (see page 12).

Menu → **Alarm Clock** → **OK** → **Activation** → **OK** (☑ = on)

After activating the alarm clock, the menu for setting the wake-up time opens automatically.

If the alarm clock is set, the wake-up time appears with the ☹ icon displayed on the screen

Setting the wake-up time

Menu → **Alarm Clock** → **OK**
 → **Wake up time** → **OK**
 → Enter wake-up time → **OK**

When the alarm clock rings...

Press the display key **Off** or any key to deactivate the alarm clock for 24 hours.

If you do not press any key, the alarm turns off after one minute.

Restoring the handset default settings

You can reset any individual settings and changes you have made. This will not affect entries in the directory, calls list, or the handset's registration to the base station.

Menu → **Settings** → **OK** → **Handset** → **OK**
 → **Reset Handset** → **OK**

Cancel the reset with .

Base station settings

The base station settings are changed using a registered handset.

Changing the system PIN

You must enter the system PIN when registering a handset to the base station.

You can change the base's 4-digit default system PIN ("0000") to a 4-digit PIN known only to yourself.

Menu → **Settings** → **OK** → **Base** → **OK**
 → **System PIN** → **OK** → **PIN:** → **OK**
 → **New PIN:** → **OK**

Should you forget the system PIN, you can reset the base station to the original code 0000:

Remove the power cord from the base station. Press and hold down the Registration/Paging key  of the base station while you reconnect the power cord to the base station. Only release the key when you hear a signal tone.

The base station is now reset and the system PIN is set to 0000.

Changing ringers

◆ Volume:

You can choose between five volumes and the "crescendo" ring (see page 30). Select "0" to deactivate the ringer of the base station.

◆ Melody:

You can set a ringer melody for external calls (see page 30).

Menu → **Settings** → **OK** → **Base** → **OK**
 → **Audio Settings** → **OK**
 → **Ringer Volume / Ringer Melody** → **OK**

For how to adjust the settings, see page 30.

Operating the base station on a PABX

Restoring the base station to factory settings

When the settings are restored, all handsets are de-registered. Each individual setting is restored. Only the date and time are retained.

Menu → **Settings** → **OK** → **Base** → **OK**
→ **Base Reset** → **OK**

Operating the base station on a PABX

The following settings are only needed when your PABX requires them. Please refer to the user guide of your PABX.

Changing the dialing mode

Menu → **6 mms** **8 twt** **9 mms** **1 ca** **1 ca** → Enter digits for dialing mode: **0 DTMF** = Dual-tone multifrequency dialing (DTMF); **1 PD** = Pulse dialing (PD) → **OK**

Switching temporarily to dual-tone multifrequency dialing (DTMF)

If your PABX is still using pulse dialing (PD), but tone dialing is required for a connection (e.g., to play back your network mailbox), you must switch temporarily to tone dialing.

Requirement: You are conducting a call or have already dialed an external number.

Press the flash key **☎**. Tone dialing is now activated **for this call only**.

Setting the flash time

Menu → **6 mms** **8 twt** **9 mms** **1 ca** **2 sec**
→ Enter digits for the flash time:
0 DTMF = 80 ms; **1 ca** = 100 ms;
2 sec = 120 ms; **3 def** = 180 ms;
4 gph = 250 ms; **5 jkl** = 300 ms;
6 mms = 600 ms; **7 Part** = 800 ms → **OK**

Changing the pause after line seizure

You can set the length of the pause between pressing the Talk key **☎** and sending the phone number.

Menu → **6 mms** **8 twt** **9 mms** **1 ca** **9 mms**
→ Enter digits for the current pause length:
1 ca = 1 sec.; **2 sec** = 3 sec.; **3 def** = 7 sec. → **OK**.

Changing the pause after pressing the Flash key

Menu → **6 mms** **8 twt** **9 mms** **1 ca** **4 gph** → Enter the digits for the current pause length:
1 ca = 800 ms; **2 sec** = 1600 ms;
3 def = 3200 ms → **OK**.

Appendix

Symbols and typographical conventions used

This section explains the meaning of certain symbols and typographical conventions used in this user guide.



Enter digits or letters.



The display functions currently appearing on the lower display line are shown in reverse video. Press the relevant display key to launch the function.



Press the top or bottom of the Control key (for example, when scrolling).



/ / etc.

Press the corresponding key of the handset.

External Calls / Internal Calls (example)

Select one of the menu functions (**External Calls** or **Internal Calls**) from the list and press **OK**.



→ **Audio Settings** → **OK**

→ **Ringer Melody (example)** → **OK**

Press **Menu**. Select **Audio Settings** using and press **OK**. Select **Ringer Melody** using and press **OK**.

Care

- ▶ Wipe the base station and handset with a **damp** cloth (do not use solvent) or an antistatic cloth.

Never use a dry cloth. This can cause static.

Contact with liquid

If the handset has come into contact with liquid:

- ▶ **Immediately switch the handset off and remove the batteries.**
- ▶ Allow the liquid to drain from the handset.
- ▶ Pat all parts dry, then place the handset with the battery compartment open and the keypad facing down in a dry, warm place **for at least 72 hours** (not in a microwave or convection oven, etc.).
- ▶ **Do not switch on the handset again until it is completely dry.**

Once fully dried, you should be able to use it again normally.

Troubleshooting

If you have any questions about using your phone, visit us anytime at www.siemens.com/gigasetcustomercare. The table below contains a list of common problems and possible solutions.

The display is blank.

1. The handset is not switched on.
 - ▶ Press and hold the End call key .
2. The battery is dead.
 - ▶ Charge the battery or replace it (page 10).

The handset does not respond to a key press.

The keypad lock is activated.

- ▶ Press and **hold** the pound key (page 17).

Base is flashing on the display.

1. The handset is outside the range of the base station.
 - ▶ Move the handset closer to the base.
2. The base station is not switched on.
 - ▶ Check the base station power cord (page 10).

Appendix

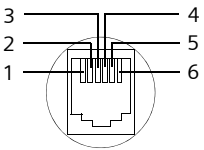
<p>Handset does not ring.</p> <p>The ringer is switched off.</p> <ul style="list-style-type: none"> ▶ Activate the ringer (page 30). 						
<p>You cannot hear a ringer/dialing tone.</p> <p>Base station's phone cord has been replaced.</p> <ul style="list-style-type: none"> ▶ When purchasing a new cord, ensure that it has the correct pin connections. <p>Correct phone jack assignment</p>  <table style="margin-left: 100px;"> <tr><td>1 unused</td></tr> <tr><td>2 unused</td></tr> <tr><td>3 a</td></tr> <tr><td>4 b</td></tr> <tr><td>5 unused</td></tr> <tr><td>6 unused</td></tr> </table>	1 unused	2 unused	3 a	4 b	5 unused	6 unused
1 unused						
2 unused						
3 a						
4 b						
5 unused						
6 unused						
<p>The incoming call number is not displayed although CIP (page 16) is set.</p> <p>Caller ID is not enabled.</p> <ul style="list-style-type: none"> ▶ The caller should ask his or her network provider to enable caller ID (CI). 						
<p>You hear an error tone when keying an input (a descending sequence of tones).</p> <p>Action has failed/invalid input.</p> <ul style="list-style-type: none"> ▶ Repeat the operation. ▶ Watch the display and refer to the operating instructions, if necessary. 						
<p>The calls list does not indicate a time for a message.</p> <p>Date/time is not set.</p> <ul style="list-style-type: none"> ▶ Set the date/time (page 12). 						
<p>The answer machine will not record messages.</p> <p>Its memory is full.</p> <ul style="list-style-type: none"> ▶ Delete old messages. ▶ Play back new messages and delete. 						
<p>Programming the SOS mode did not work.</p> <p>The feature is only available behind extension systems that do not require an "R" or a "P" for obtaining an outside line.</p>						

FCC / ACTA Information

Warning: Changes or modifications to this unit not expressly approved by Siemens Cordless Products could void the FCC authority to operate the equipment. This includes the addition of any external antenna device.

This equipment complies with Part 68 of the FCC rules and the requirements adopted by the ACTA. On the bottom of the base station is a label that contains, among other information, a product identifier in the format

US:AAAEQ##TXXXX. If requested, this number must be provided to the telephone company.

A plug and jack used to connect this equipment to the premises wiring and telephone network must comply with the applicable FCC Part 68 rules and requirements adopted by the ACTA. A compliant telephone cord and modular plug is provided with this product. It is designed to be connected to a compatible modular jack that is also compliant. See installation instructions for details.

The REN is used to determine the number of devices that may be connected to a telephone line. Excessive RENs on a telephone line may result in the devices not ringing in response to an incoming call. In most but not all areas, the sum of RENs should not exceed five (5.0). To be certain of the number of devices that may be connected to a line, as determined by the total RENs, contact the local telephone company. For products approved after July 23, 2001, the REN for this product is part of the product identifier that has the format US:AAAEQ##TXXXX. The digits represented by ## are the REN without a decimal point (e.g., 03 is a REN of 0.3). For earlier products, the REN is separately shown on the label.

If this equipment causes harm to the telephone network, the telephone company will notify you in advance that temporary discontinuance of service may be required. But if advance notice isn't practical, the telephone company will notify the customer as soon as possible. Also, you will be advised of your right to file a complaint with the FCC if you believe it is necessary. The telephone company may make changes in its facilities, equipment, operations, or procedures that could affect the operation of the equipment. If this happens, the telephone company will provide advance notice in order for you to make necessary modifications to maintain uninterrupted service. If you experience trouble with this telephone system, disconnect it from the network until the problem has been

corrected or until you are sure that the equipment is not malfunctioning.

For repair or warranty information, please contact Siemens Customer Care at 1-866-247-8758. If the equipment is causing harm to the telephone network, the telephone company may request that you disconnect the equipment until the problem is resolved. This equipment is of a type that is not intended to be repaired by the customer (user).

This telephone system may not be used on coin service provided by the telephone company. Connection to party line service is subject to state tariffs. Contact the state public utility commission, public service commission, or corporation commission for information. Privacy of communications may not be ensured when using this phone.

If your home has specially wired alarm equipment connected to the telephone line, ensure the installation of this equipment does not disable your alarm equipment. If you have questions about what will disable alarm equipment, consult your telephone company or a qualified installer.

This telephone system equipment has been tested and found to comply with the limits for Class B digital devices, pursuant to Part 15 of the FCC Rules. Operation is subject to the following two conditions: (1) This device may not cause harmful interference, and (2) This device must accept any interference received, including interference that may cause undesired operation. These limits are designed to provide reasonable protection against harmful interference in a residential installation. Some cordless telephones operate at frequencies that may cause interference to nearby TV's and VCR's; to minimize or prevent such interference, the system base should not be placed near or on top of a TV or VCR; and, if interference is experienced, moving the base farther away from the TV or VCR will often reduce or eliminate the interference.

However, there is no guarantee that interference will not occur in a particular installation. If this telephone system does cause harmful interference to radio or television reception, which can be determined by turning the system off and on, the user is encouraged to try to correct the interference by one or more of the following measures:

1. Reorient or relocate the receiving antenna.
2. Increase the separation between the base station and receiver.

3. Connect the base station into an outlet on a circuit different from that to which the receiver is connected.

4. Consult the dealer or an experienced radio TV technician for help.

Notice for Direct Inward Dialing ("DID")

ALLOWING THIS EQUIPMENT TO BE OPERATED IN SUCH A MANNER AS TO NOT PROVIDE FOR PROPER ANSWER SUPERVISION AS A VIOLATION OF PART 68 OF THE FCC'S RULES.

Notice to Hearing Aid Wearers:

This phone system is compatible with inductively coupled hearing aids.

Power Outage:

In the event of a power outage, your cordless telephone will not operate. The cordless telephone requires electricity for operation. You should have a telephone that does not require electricity available for use during power outages.

Notice:

The installation of the base unit should allow at least 8 inches between the base and persons to be in compliance with FCC RF exposure guidelines.

For body worn operation, the portable part (handset) has been tested and meets FCC RF exposure guidelines. Use with an accessory that contains metal parts may not ensure compliance with FCC RF exposure guidelines.

Notice to telephone company service:

If you need service from your telephone company, please provide them with the information

- Facility Interface Code (FIC)
- Service Order Code (SOC)
- Universal Service Order Code (USOC) Jack as indicated on the label on the bottom side of the base station.

Appendix

Industry Canada Certification

Operation is subject to the following two conditions (1) this device may not cause interference, and (2) this device must accept any interference, including interference that may cause undesired operation of the device.

NOTICE: The Industry Canada label identifies certified equipment. This certification means that the equipment meets certain telecommunications network, protective, operational, and safety requirements as prescribed in the appropriate Terminal Equipment Technical Requirements document(s). The Department does not guarantee the equipment will operate to the user's satisfaction.

Before installing this equipment, users should ensure that it is permissible to be connected to the facilities of the local telecommunications company. The equipment must also be installed using an acceptable method of connection. The customer should be aware that compliance with the above conditions may not prevent degradation of service in some situations.

Repairs to certified equipment should be coordinated by a representative designated by the supplier. Any repairs or alterations made by the user to this equipment, or equipment malfunctions, may give the telecommunications company cause to request the user to disconnect the equipment.

Users should ensure for their own protection that the electrical ground connections of the power utility, telephone lines, and internal metallic water pipe system, if present, are connected together.

This precaution may be particularly important in rural areas

NOTE: Users should not attempt to make such connections themselves, but should contact the appropriate electric inspection authority or electrician, as appropriate.

This product meets the applicable Industry Canada technical specifications.

The Ringer Equivalence Number is an indication of the maximum number of devices allowed to be connected to a telephone interface. The termination of an interface may consist of any combination of devices, subject only to the requirement that the sum of the RENs of all devices does not exceed five.

This Class B digital apparatus complies with Canadian ICES-003.

Cet appareil numérique de la classe B est conforme à la norme NMB-003 du Canada.

Safety precautions

Before using your telephone equipment, basic safety instructions should always be followed to reduce the risk of fire, electric shock, and injury to persons.

1. Read and understand all instructions.
2. Follow all warnings and instructions marked on the product.
3. Unplug this product from the wall telephone jack and power outlet before cleaning. Do not use liquid cleaners or aerosol cleaners. Use a damp cloth for cleaning.
4. Do not use this product near water, for example, near a bathtub, wash bowl, kitchen sink, or laundry tub, in a wet basement, or near a swimming pool.
5. Place this product securely on a stable surface. Serious damage and/or injury may result if the unit falls.
6. Slots or openings in the cabinet and the back and bottom are provided for ventilation, to protect it from overheating. These openings must not be blocked or covered. This product should never be placed near or over a radiator or heat register, or in a place where proper ventilation is not provided.
7. This product should be operated only from the type of power source indicated on the marking label. If you are not sure about the type of power supply to your home, consult your dealer or local power company.
8. Do not place objects on the power cord. Install the unit where no one can step or trip on the cord.
9. Do not overload wall outlets and extension cords, as this can result in the risk of fire or electric shock.
10. Never push objects of any kind into this product through cabinet slots, as they may touch dangerous voltage points or short out parts that could result in the risk of fire or electric shock. Never spill liquid of any kind on this product.
11. To reduce the risk of electric shock or burns, do not disassemble this product. Take it to a qualified service center when service is required. Opening or removing covers may expose you to dangerous voltages, dangerous electrical current, or other risks. Incorrect reassembly can cause electric shock when the appliance is subsequently used.

12. Unplug the product from the wall outlet and refer servicing to qualified service personnel under the following conditions:

- a.) When the power cord is damaged or frayed.
- b.) If liquid has been spilled into the product.
- c.) If the product has been exposed to rain or water.
- d.) If the product does not operate normally by following the operating instructions. Adjust only those controls that are covered by the operating instructions, because improper adjustment of other controls may result in damage and may require extensive work by a qualified technician to restore the product to normal operation.
- e.) If the product has been dropped or physically has been damaged.
- f.) If the product exhibits a distinct change in performance.

13. Avoid using a telephone (other than a cordless type) during a thunderstorm. There may be a remote risk of electrical shock from lightning. Therefore we suggest using a surge protector.

14. Do not use the telephone to report a gas leak in the vicinity of the leak.

15. Emergency/911 numbers may not be dialed if the keypad is locked.

16. Minimum No. 26 AWG telecommunication line cord must be used with this phone.

BATTERY SAFETY PRECAUTIONS

To reduce the risk of fire, injury or electric shock, and to properly dispose of batteries, please read and understand the following instructions.

CONTAINS ALKALINE NICKEL METAL HYDRIDE BATTERY. BATTERY MUST BE RECYCLED OR DISPOSED OF PROPERLY. DO NOT DISPOSE OF IN MUNICIPAL WASTE.

1. Only use the batteries specified for use with this product.

2. DO NOT USE ALKALINE NICKEL CADMIUM OR ALKALINE LITHIUM BATTERIES, or mix batteries of different sizes or from different manufacturers in this product. DO NOT USE NONRECHARGEABLE BATTERIES.

3. Do not dispose of the batteries in a fire; the cells may explode. Do not expose batteries to water. Check with local codes for special disposal instructions.

4. Do not open or mutilate the batteries. Released electrolyte is corrosive and may cause damage to the eyes or skin. The electrolyte may be toxic if swallowed.

5. Exercise care in handling the batteries in order not to short the batteries with conducting materials, such as rings, bracelets, and keys. The batteries or conducting material may overheat and cause burns or fire.

6. Charge the batteries provided with, or identified for use with, this product only in accordance with the instructions and limitations specified in the user's manual. Do not attempt to charge the batteries with any means other than that specified in the user manual.

7. Periodically clean the charge contacts on both the charger and handset.

Appendix

Service (Customer Care)

Customer Care Warranty for Cordless Products
To obtain Siemens Customer Care Warranty service,
product operation information, or for problem resolution, call:

Toll Free: 1-866-247-8758.

9:00 a.m. – 5:00 p.m., Monday-Saturday

www.siemens.com/gigasetcustomercare

End User Limited Warranty

This limited, non-transferable warranty is provided to the original buyer/end consumer ("you") for systems, handsets, and accessories (collectively, "Product") manufactured, sold and/or distributed by Siemens Home and Office Communication Devices LLC ("Siemens"). Siemens warrants to you that, at the date of purchase, the product is free of defects in workmanship and materials and the software included in the Product will perform in substantial compliance to its program specifications.

1. WARRANTY PERIOD

The Product warranty period is one (1) year from the original date of purchase by you. Proof of purchase (e.g., sales slip or invoice) must be provided with any Product returned during the Warranty Period. Batteries supplied with the Products are warranted to be free from defects at the time of purchase only.

2. EXCLUSIVE REMEDY

Siemens' entire liability and your exclusive remedy if the Product is defective in materials or workmanship during the Warranty Period and is returned shall be that the Product will be repaired or replaced as set forth in Section 4 below. Reconditioned replacement components, parts or materials may be used in the replacement or repair. Data in the memory of the Product may be lost during repair.

3. THIS LIMITED WARRANTY DOES NOT COVER AND IS VOID WITH RESPECT TO THE FOLLOWING:

- Cosmetic damage, physical damage to the surface of the Product, including, without limitation, breakage, cracks, dents, scratches or adhesive marks on the LCD screen or outside casing of the Product.

- Products which have been repaired, maintained or modified (including the antenna) by anyone other than Siemens or a Siemens-approved repair facility, or that have been improperly installed.
- Cost of installation, removal, or reinstallation.
- "Damage due to any telephone, electronic, hardware or software program, network, Internet or computer malfunctions, failures, or difficulties of any kind, including without limitation, server failure or incomplete, incorrect, garbled or delayed computer transmissions.
- Equipment and components not manufactured, supplied or authorized by Siemens.
- Modification of the Product's components, or operation of the Product in an unsuitable environment or in a manner for which it is not intended, including but not limited to failures or defects caused by misuse, abuse, accidents, physical damage, abnormal operation, improper handling or storage, neglect, alterations, unauthorized installation, removal or repairs, failure to follow instructions, problems caused by the carrier's network coverage, exposure to fire, water or excessive moisture or dampness, floods, or extreme changes in climate or temperature, acts of God, riots, acts of terrorism, spills of food or liquids, viruses or other software flaws introduced into the Product, or other acts which are not the fault of Siemens and which the Product is not specified to tolerate, including damage caused by mishandling or blown fuses.
- Products which have had warranty stickers, electronic serial number and/or serial number label removed, altered, rendered illegible or fraudulently applied to other equipment.

- Signal reception problems (unless caused by defect in material or workmanship in the Product).
- Products operated outside published maximum ratings.
- Performance of the Products when used in combination with other products or equipment not manufactured, supplied or authorized by Siemens.
- Consumables (such as batteries and fuses).
- Payments for labor or service to representatives or service centers not authorized to perform product maintenance by Siemens.
- Loss of data.
- Testing and examination discloses that the alleged defect or malfunction in the Product does not exist.

This warranty does not cover customer education, instruction, installation or removal, set up adjustments, problems related to service(s) provided by a carrier or other service provider, and/or signal reception problems. Siemens shall not be responsible for software, firmware, information, or memory data contained in, stored on, or integrated with any Products returned for repair, whether under warranty or not.

This warranty is valid only in the United States.

USE WITH ACCESSORIES NOT SUPPLIED BY SIEMENS OR NOT OTHERWISE EXPRESSLY AUTHORIZED BY SIEMENS MAY VOID WARRANTY.

4. WARRANTY CLAIM PROCEDURE

All warranty claims must be made by notifying Siemens prior to the expiration of the Warranty Period. Siemens' obligation to provide warranty support shall not extend past the end of the Warranty Period, except that any product repaired or replaced during the Warranty Period shall continue to be warranted for the balance of such Warranty Period or thirty (30) days, whichever is greater.

Throughout the Warranty Period, Siemens will be available to provide you with technical support service Monday through Saturday from 9:00 a.m. to 5:00 p.m. Central Time, excluding national holidays. Support service will be provided to you by accessing Siemens' toll free customer service number:

1-866-247-8758

5. LIMITATION OF WARRANTY

Siemens makes no warranty or representation that the software in the Products will meet your requirements or will work in combination with any hardware or applications software products provided by third parties, that the operation of the software will be uninterrupted or error free, or that all defects in the software products will be corrected.

6. LIMITATION ON REMEDIES; NO CONSEQUENTIAL OR OTHER DAMAGES

Your exclusive remedy for any breach of this Limited Warranty is as set forth above. Except for any refund elected by Siemens, **YOU ARE NOT ENTITLED TO ANY DAMAGES, INCLUDING BUT NOT LIMITED TO CONSEQUENTIAL DAMAGES**, if the Product does not meet the Limited Warranty, and, to the maximum extent allowed by applicable law, even if any remedy fails of its essential purpose. The terms below ("Exclusion of Incidental, Consequential and Certain Other Damages") are also incorporated into this Limited Warranty. Some states/jurisdictions do not allow the exclusion or limitation of incidental or consequential damages, so the above limitation or exclusion may not apply to you. This Limited Warranty gives you specific legal rights. You may have others which vary from state/jurisdiction to state/jurisdiction.

7. DISCLAIMER OF WARRANTIES

SIEMENS AND ITS SUPPLIERS PROVIDE THE PRODUCT AND SUPPORT SERVICES (IF ANY) AS IS AND WITH ALL FAULTS. THE LIMITED WARRANTY IS IN LIEU OF ANY OTHER EXPRESS WARRANTIES (IF ANY) CREATED BY ANY DOCUMENTATION OR PACKAGING EXCEPT FOR THE LIMITED WARRANTY, AND TO THE MAXIMUM EXTENT PERMITTED BY APPLICABLE LAW IS IN LIEU OF ANY IMPLIED OR STATUTORY WARRANTIES, INCLUDING, BUT NOT LIMITED TO, THE IMPLIED WARRANTIES OF MERCHANTABILITY AND FITNESS FOR A PARTICULAR PURPOSE, OF ACCURACY OR COMPLETENESS OR RESPONSES, OF RESULTS, OF WORKMANLIKE EFFORT, OF LACK OF VIRUSES AND OF LACK OF NEGLIGENCE, ALL WITH REGARD TO THE PRODUCT, AND THE PROVISION OF OR FAILURE TO PROVIDE SUPPORT SERVICES. ALSO, THERE IS NO WARRANTY OR CONDITION OF TITLE, QUIET ENJOYMENT, QUIET POSSESSION, OR CORRESPONDENCE TO DESCRIPTION OR NON-INFRINGEMENT WITH REGARD TO THE PRODUCT. Some states or provinces do not allow limitations on how long an implied warranty lasts

Appendix

or the exclusion or limitation of incidental or consequential damages, so the above exclusions or limitations may not apply to you (applies only in the U.S. and Canada). If an implied warranty or condition is created by your state/province and federal or state/provincial law prohibits disclaimer of it, you also have an implied warranty or condition, BUT ONLY AS TO DEFECTS DISCOVERED DURING THE PERIOD OF THIS LIMITED WARRANTY (ONE YEAR). AS TO ANY DEFECTS DISCOVERED AFTER THE ONE YEAR PERIOD, THERE IS NO WARRANTY OR CONDITION OF ANY KIND. This limited warranty gives you specific legal rights, and you may also have other rights, which vary from state to state or from province to province (applies only in the U.S. and Canada). In no event shall Siemens' liability exceed the cost of repairing or replacing defective Products as provided herein, and any such liabilities will terminate upon expiration of the warranty period.

Any supplements or updates to the Product or the software in the Product, including without limitation, any (if any) software fixes or upgrades or bug fixes provided to you after the expiration of the one-year Limited Warranty period are not covered by any warranty or condition, express, implied or statutory.

8. EXCLUSION OF INCIDENTAL, CONSEQUENTIAL AND CERTAIN OTHER DAMAGES

TO THE MAXIMUM EXTENT PERMITTED BY APPLICABLE LAW, IN NO EVENT SHALL SIEMENS, SELLER OR THEIR SUPPLIERS BE LIABLE FOR ANY SPECIAL, INCIDENTAL, INDIRECT, OR CONSEQUENTIAL DAMAGES WHATSOEVER (INCLUDING, BUT NOT LIMITED TO, DAMAGES FOR LOSS OF PROFITS OR CONFIDENTIAL OR OTHER INFORMATION, FOR BUSINESS INTERRUPTION, FOR PERSONAL INJURY, FOR LOSS OF PRIVACY, FOR FAILURE TO MEET ANY DUTY INCLUDING OF GOOD FAITH OR OF REASONABLE CARE, FOR NEGLIGENCE, AND FOR ANY OTHER PECUNIARY OR OTHER LOSS WHATSOEVER) ARISING OUT OF OR IN ANY WAY RELATED TO THE USE OF OR INABILITY TO USE THE PRODUCT, THE PROVISION OF OR FAILURE TO PROVIDE SUPPORT SERVICES, OR OTHERWISE UNDER OR IN CONNECTION WITH ANY PROVISION OF THIS LIMITED WARRANTY, EVEN IN THE EVENT OF THE FAULT, TORT (INCLUDING NEGLIGENCE), STRICT LIABILITY, BREACH OF CONTRACT OR BREACH OF WARRANTY OF SIEMENS OR SELLER OR ANY SUPPLIER, AND EVEN IF SIEMENS OR SELLER OR ANY SUPPLIER HAS

BEEN ADVISED OF THE POSSIBILITY OF SUCH DAMAGES. REPAIR OR REPLACEMENT, AS PROVIDED UNDER THE WARRANTY, IS YOUR SOLE AND EXCLUSIVE REMEDY FOR BREACH OF THE LIMITED WARRANTY.

9. LIMITATION OF LIABILITY AND REMEDIES

NOTWITHSTANDING ANY DAMAGES THAT YOU MIGHT INCUR FOR ANY REASON WHATSOEVER (INCLUDING, WITHOUT LIMITATION, ALL DAMAGES REFERENCED ABOVE AND ALL DIRECT OR GENERAL DAMAGES), THE ENTIRE LIABILITY OF SIEMENS, SELLER AND ANY OF THEIR SUPPLIERS UNDER ANY PROVISION OF THIS LIMITED WARRANTY AND YOUR EXCLUSIVE REMEDY FOR ALL OF THE FOREGOING (EXCEPT FOR ANY REMEDY OF REPAIR OR REPLACEMENT ELECTED BY SIEMENS OR SELLER OR SUPPLIER WITH RESPECT TO ANY BREACH OF THE LIMITED WARRANTY) SHALL BE LIMITED TO THE GREATER OF THE AMOUNT ACTUALLY PAID BY YOU FOR THE PRODUCT OR FIVE DOLLARS (\$5.00 USD). THE FOREGOING LIMITATIONS, EXCLUSIONS AND DISCLAIMERS SHALL APPLY TO THE MAXIMUM EXTENT PERMITTED BY APPLICABLE LAW, EVEN IF ANY REMEDY FAILS ITS ESSENTIAL PURPOSE.

10. GOVERNING LAW

This limited warranty will be governed by the laws of Texas, and excluding the United Nations Convention on Contracts for the International Sale of Goods.

If you want to learn more about Siemens Gigaset, or for technical assistance with your Gigaset, visit our web site at www.siemens.com, or please call (866) 247-8758 or, for TDD access, (888) 777-0209.

Issued by Siemens Cordless Products
Siemens and Gigaset are registered trademarks of Siemens Home and Office Communication Devices GmbH & Co. KG.

Siemens Cordless Products is a division of Siemens Home and Office Communication Devices GmbH & Co. KG.

Product attributes subject to change.
Siemens reserves the right to make changes without notice in equipment design and/or components.

Part Number: A31008-M1805-B101-1-xx19
© Copyright 2007 Siemens Home and Office Communication Devices GmbH & Co. KG. All rights reserved.

Technical data

Recommended batteries

Nickel-metal-hydride (NiMH):

The handset is supplied with the authorized AAA batteries.

Handset operating times/charging times

The following information relates to batteries with a capacity of 650 mAh.

Standby time	approx. 165 hours (7 days)
Calling time	approx. 18 hours
Charging time	approx. 6 hours

The operating and charging times apply only when using the recommended batteries.

Base station power consumption

In standby mode: approx. 2W





During a call: approx. 3W

General specifications

DECT standard	is supported
GAP standard	is supported
Range	up to 300 m outdoors, up to 50 m indoors
Base station power supply	230 V ~/50 Hz
Environmental conditions for operation	+5 °C to +45 °C; 20% to 75% relative humidity

Writing and editing a text message

The following rules apply when writing a text message:

- ◆ The cursor is controlled with  .
- ◆ Characters are added to the left of the cursor.
- ◆ Press the pound key  **briefly** to switch from "Abc" mode to "123," from "123" to "abc," and from "abc" to "Abc" (uppercase: 1st letter uppercase, all others lowercase). Press the pound key  **before** entering the letter.
- ◆ Press the pound key  **three times**: Shows the selection line of the characters assigned to the pound key.
- ◆ The first letter of the name of directory entries is automatically capitalized, followed by lowercase letters.

Editing text

When you press a key and **hold** it, the characters of that key appear in the bottom display line and are highlighted one after the other. When you release the key, the highlighted character is inserted into the input field. For how to enter special characters, see page 42.

The display briefly shows whether uppercase or lowercase letters or digits are selected when you switch from one mode to the next: The bottom text line displays "abc -> Abc," "Abc -> 123" or "123 -> abc."

Appendix

Order of directory entries

Directory entries are usually sorted in alphabetical order. Spaces and digits take first priority. The sort order is as follows:

1. Space (shown here as □)
2. Digits (0–9)
3. Letters (alphabetical)
4. Other characters

To get around the alphabetical ordering of the entries, insert a space or a digit in front of the name. These entries will then move to the beginning of the directory. Names that you have preceded with an asterisk will move to the end of the directory.

Entering special characters

Standard characters

	1□□	0□□□	*□△	#□□
1x	Space	.	*	Abc-> 123
2x	1	,	/	123 -> abc
3x	£	?	(#
4x	\$!)	@
5x	¥	0	<	\
6x	□	+	=	&
7x		-	>	§
8x		:	%	
9x		¿		
10x		¡		
11x		"		
12x		'		
13x		;		
14x		—		

Accessories

Handset

Upgrade your Verizon V400AM to a cordless telephone system.

- ◆ Large keys, illuminated keypad
- ◆ Text and symbols are displayed clearly in large type on the screen
- ◆ Jumbo digits (uppercase)
- ◆ Direct dialing keys
- ◆ Compatibility with hearing aids (HAC)
- ◆ Handsfree operation
- ◆ Phonebook for around 100 entries
- ◆ Headset connection



Connection socket for headset

You can find suitable headsets on the Internet at www.plantronics.com.

All accessories and batteries are available from your mobile phone retailer.



Only use original accessories. This will avoid possible health risks and damage to property and also ensure that all the relevant regulations are complied with.

Wall mounting for base station

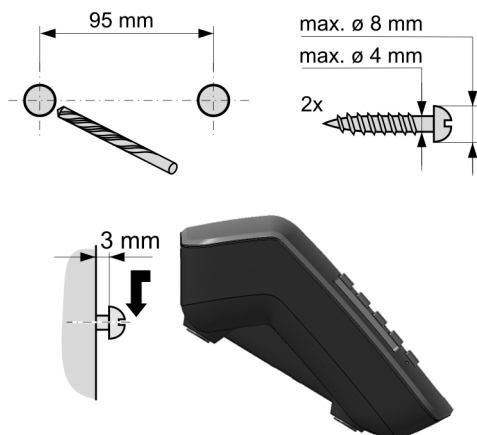

Index

Index**A**

Accessories	43
Activating	
advisory tones	30
answer machine	24
auto answer	29
keypad lock	17
suppressing ringer	30
Advisory tones	30
Alarm clock	31
Answer machine	24
Answer machine, see also Network mailbox	
Area codes	13
extra codes	13
local area code	13
Auto answer	16, 26, 29

B

Base station	
changing system PIN	31
installing and connecting	9, 10
operating on PABX	32
power consumption	41
restoring default settings	32
setting	31
wall mounting	43

Battery

charging	12
display	2, 12
fitting	10
icon	12
recommended batteries	41
warning tone	30

C

Call

answering	16
caller listening in	29
internal	28
picking up from answer machine	25
transferring (connecting)	28
Call screening during recording	26
Call waiting, internal call	28
Caller ID	16

Calling back caller	23
Calling back from calls list	23
Calls list	22, 23
Canceling (operation)	18
Care of the telephone	33
Changing PIN	31
Changing system PIN	31
Characters	
deleting	18
Charge status (battery)	2, 12
Charge status display	12
CI, CIP	16
CID 2.5 services (network services)	19
CNIP	16, 23
Confirmation tone	30
Connection socket for headset	2, 43
Control key	2, 17
Correcting incorrect input	18
Customer Care	38

D

Deactivating

advisory tones	30
answer machine	24
auto answer	29
keypad lock	17
suppressing ringer	30

Dialing

directory	20
mode	32
Direct Dialing keys	7, 20
Directory	19
opening	17
order of entries	42
selecting entry	19
sending entry/list to handset	20
storing entry	19
storing the first number	19

Display

changing display language	29
in idle status	2
keys	2, 18
name (CNIP)	16
network mailbox message	27
number (CI/CIP)	16
setting	29

E

- Earpiece volume 29
- Electricity consumption, see Power consumption
- Emergency call 7
- End Call key 2, 16
- Error tone 30
- Extra codes 13

F

- Fast access
 - answer machine 26
 - network mailbox 27

H

- Handset
 - activating/deactivating 17
 - advisory tones 30
 - charging times 41
 - contact with liquid 33
 - display language 29
 - idle status 18
 - loudspeaker volume 29
 - muting 17
 - operating and charging times 41
 - operating time 41
 - placing on hold 17
 - registering 27
 - restoring default settings 31
 - searching for 28
 - setting (individual) 29
 - setting up for use 10
 - transferring a call 28
 - using several handsets 27
- Handsfree operation 17
 - key 2
- Headset 2, 43
- Hearing aids 6
- Hold 17

I

- Idle status (display) 2, 18
- Incorrect input (correction) 18
- Installing, base station 9
- Internal
 - listening in 29
 - making calls 28
- Internal call 28
 - call waiting 28

K

- Key 1 (fast access) 26
- Key click 30
- Keypad lock 17
- Keys
 - Control key 2, 17
 - Direct Dialing keys 7, 20
 - Display keys 2, 18
 - End Call key 2, 18
 - fast access 26
 - Handsfree key 2
 - keypad lock 17
 - Message key 22
 - On/Off key 2
 - Paging key 3
 - Pound key 2, 17
 - SOS key 7
 - Talk key 2

L

- Last number redial 22
- Last number redial list 22
- Liquid 33
- List
 - calls list 22, 23
 - entry 23
 - missed calls 23
- Listening in to call 29
- Local area code 13
- Lock (keypad) 17
- Loudspeaker volume 29

M

- Making calls
 - answering a call 16, 17
 - cost-effective calls 23
 - external 16
 - internal 28
- Medical appliances 6
- Menu
 - back one menu level 18
 - end tone 30
 - menu guidance 18
 - overview 14
- Message
 - copying number to the directory 25
 - deleting 25
 - marking as new 25
 - playing back 25

Index

Message key
 opening lists 22
 Missed call 23
 Muting 17

N

Name
 display caller's name (CNIP) 16
 Network mailbox 27
 Network services (CID 2.5 services) . . . 19
 Number
 displaying caller's number (CIP) 16
 storing in directory 19, 20

O

On/Off key 2
 Operation (preparing to use
 the phone) 9
 Order of entries in directory 42

P

PABX
 operating base station on PABX 32
 setting dialing mode 32
 setting flash time 32
 switching to tone dialing 32
 Pack contents 9
 Paging 3, 28
 Placing the handset on hold 17
 Playing back
 announcement (answer machine) 24
 message (answer machine) 25
 Playing back/deleting announcements
 (answer machine) 24
 Pound key 2, 17
 Power adapter 6
 Power consumption (base station) . . . 41

Q

Questions and answers 33

R

Recording time (answer machine) 26
 Registering (handset) 11, 27
 Restoring default settings
 base station 32
 handset 31

Ringer
 changing 30, 31
 setting melody 30
 setting volume 17, 30
 suppressing 30

S

Safety precautions 6
 Searching
 handset 28
 in directory 19
 Sending
 directory entry to handset 20
 Service (Customer Care) 38
 Setting
 date 12
 flash time (PABX) 32
 melody (ringer) 30
 time 12
 wake-up time 31
 Setting volume
 earpiece 29
 handset loudspeaker 29
 loudspeaker 29
 ringer 30
 Shortcut (digit combination) 14
 SOS mode 7
 Special characters 42
 Suppressing
 first ring 30

T

Talk key 2
 Technical data 41
 Tone dialing 32
 Troubleshooting 33

V

Viewing network mailbox message . . . 27
 Volume
 ringer 30

W

Wall mounting the base station 43
 Warning tone (battery) 30
 Writing, editing text 41