

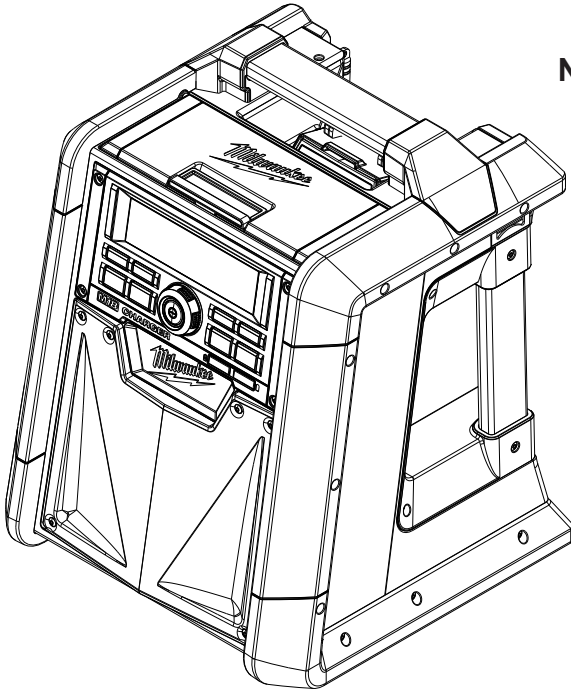

**OPERATOR'S MANUAL
MANUEL de L'UTILISATEUR
MANUAL del OPERADOR**

**Cat. No.
No de Cat.
2792-20**



**M18™ Radio/Charger
Radio/Chargeur M18™
Radio/Cargador M18™**

TO REDUCE THE RISK OF INJURY, USER MUST READ AND UNDERSTAND OPERATOR'S MANUAL.

AFIN DE RÉDUIRE LE RISQUE DE BLESSURES, L'UTILISATEUR DOIT LIRE ET BIEN COMPRENDRE LE MANUEL DE L'UTILISATEUR.

PARA REDUCIR EL RIESGO DE LESIONES, EL USUARIO DEBE LEER Y ENTENDER EL MANUAL DEL OPERADOR.

IMPORTANT SAFETY INSTRUCTIONS

RADIO SAFETY

WARNING

- 1) Read these instructions.
- 2) Keep these instructions.
- 3) Heed all warnings.
- 4) Follow all instructions.
- 5) Do not use this apparatus near water.
- 6) Clean only with dry cloth.
- 7) Do not block any ventilation openings. Install in accordance with the manufacturer's instructions.
- 8) Do not install near any heat sources such as radiators, heat registers, stoves, or other apparatus (including amplifiers that produce heat.)
- 9) Do not defeat the safety purpose of the polarized or grounding-type plug. A polarized plug has two blades with one wider than the other. A grounding type plug has two blades and a third grounding prong. The wide blade or the third prong are provided for your safety. If the provided plug does not fit into your outlet, consult an electrician for replacement of the obsolete outlet.
- 10) Protect the power cord from being walked on or pinched particularly at plugs, convenience receptacles, and the point where they exit from the apparatus.
- 11) Only use attachments/accessories specified by the manufacturer.
- 12) Use only with the cart, stand, tripod, bracket, or table specified by the manufacturer, or sold with the apparatus. When a cart is used, use caution when moving the cart/apparatus combination to avoid injury from tip-over.
- 13) Unplug this apparatus during lightning storms or when unused for long periods of time.
- 14) Refer all servicing to qualified service personnel. Servicing is required when the apparatus has been damaged in any way, such as power-supply cord or plug is damaged, liquid has been spilled or objects have fallen into the apparatus, the apparatus has been exposed to rain or moisture, does not operate normally, or has been dropped.
- 15) **WARNING** To reduce the risk of fire or electric shock, do not expose this apparatus to rain or moisture.
- 16) Only plug power supply into readily accessible outlet to allow the appliance to be unplugged quickly.
- 17) Only operate this apparatus in a well-ventilated area.
- 18) A battery operated radio with integral batteries or a separate battery pack must be recharged only with the specified charger for the battery. A charger that may be suitable for one type of battery may create a risk of fire when used with another battery.

- 19) Use battery operated radio only with specifically designated battery packs. Use of any other batteries may create a risk of fire.
- 20) When battery pack is not in use, keep it away from other metal objects like: paper clips, coins, keys, nails, screws, or other small metal objects that can make a connection from one terminal to another. Shorting the battery terminals together may cause sparks, burns, or a fire.
- 21) Avoid body contact with grounded surfaces such as pipes, radiators, ranges and refrigerators. There is an increased risk of electric shock if your body is grounded.
- 22) Do not use any adaptor plugs.
- 23) When operating a radio outside, use an outdoor extension cord marked "W-A" or "W". These cords are rated for outdoor use and reduce the risk of electric shock.
- 24) Never disassemble the radio or try to do any rewiring on the radio's electrical system.
- 25) Do not expose this apparatus to dripping and splashing, or place objects filled with liquids on this unit.
- 26) Maintain labels and nameplates. These carry important information. If unreadable or missing, contact a MILWAUKEE service facility for a free replacement.
- 27) This radio charger is designed to be powered by a standard 120 volt AC line or AC generator. The radio can also be powered using a MILWAUKEE M18™ Li-Ion battery pack. Radio charger must be plugged into an appropriate receptacle. Do not attempt to use with any other voltage or power supply.

CHARGER SAFETY

- 28) **SAVE THESE INSTRUCTIONS - THIS OPERATOR'S MANUAL CONTAINS IMPORTANT SAFETY AND OPERATING INSTRUCTIONS FOR MILWAUKEE LI-ION M18™ RADIO CHARGER.**
- 29) **BEFORE USING, READ THIS OPERATOR'S MANUAL, YOUR BATTERY PACK OPERATOR'S MANUAL, AND ALL LABELS ON THE BATTERY PACK AND RADIO CHARGER.**
- 30) **CAUTION - TO REDUCE THE RISK OF INJURY, CHARGE MILWAUKEE LITHIUM-ION PACKS ONLY IN THEIR MILWAUKEE LITHIUM-ION CHARGER.** Other types of chargers may cause personal injury or damage. Battery pack and charger are not compatible with V™-technology or NiCd systems. Do not wire a battery pack to a power supply plug or car cigarette lighter. Battery packs will be permanently disabled or damaged.
- 31) **AVOID DANGEROUS ENVIRONMENTS.** Do not charge battery pack in rain, snow, damp or wet locations. Do not use battery pack or charger in the presence of explosive atmospheres (gaseous fumes, dust or flammable materials) because sparks may be generated when inserting or removing battery pack, possibly causing fire.

- 32) CHARGE IN A WELL VENTILATED AREA.** Do not block charger vents. Keep them clear to allow proper ventilation. Do not allow smoking or open flames near a charging battery pack. Vented gases may explode.
- 33) MAINTAIN CHARGER CORD.** When unplugging charger, pull plug rather than cord to reduce the risk of damage to the electrical plug and cord. Never carry charger by its cord. Keep cord from heat, oil and sharp edges. Make sure cord will not be stepped on, tripped over or subjected to damage or stress. Do not use charger with damaged cord or plug. Have a damaged charger replaced immediately.
- 34) DO NOT USE AN EXTENSION CORD UNLESS IT IS ABSOLUTELY NECESSARY.** Using the wrong, damaged or improperly wired extension cord could result in the risk of fire and electrical shock. If an extension cord must be used, plug the charger into a properly wired 16 gauge or larger extension cord with pins that are the same number, size and shape as the pins on the charger. Make sure that the extension cord is in good electrical condition.
- 35) USE ONLY RECOMMENDED ATTACHMENTS.** Use of an attachment not recommended or sold by the battery charger or battery pack manufacturer may result in a risk of fire, electric shock or personal injury.
- 36) UNPLUG CHARGER** when not in use. Remove battery packs from unplugged chargers.
- 37) TO REDUCE THE RISK OF ELECTRIC SHOCK,** always unplug charger before cleaning or maintenance. Use a Ground Fault Circuit Interrupter (GFCI) to reduce shock hazards.
- 38) STORE YOUR BATTERY PACK AND CHARGER** in a cool, dry place. Do not store battery pack where temperatures may exceed 120°F (50°C) such as in direct sunlight, a vehicle or metal building during the summer.

Federal Communications Commission WARNING: Changes or modifications

to this unit not expressly approved by the party responsible for compliance could void the user's authority to operate the equipment.

This equipment has been tested and found to comply with the limits for a Class B digital device, pursuant to Part 15 of the FCC Rules. These limits are designed to provide reasonable protection against harmful interference in a residential installation. This equipment generates, uses and can radiate radio frequency energy and, if not installed and used in accordance with the instructions, may cause harmful interference to radio communications. However, there is no guarantee that interference will not occur in a particular installation. If this equipment does cause harmful interference to radio or television reception, which can be determined by turning the equipment off and on, the user is encouraged to try to correct the interference by one or more of the following measures:

- Reorient or relocate the receiving antenna.
- Increase the separation between the equipment and receiver.









- Connect the equipment into an outlet on a circuit different from that to which the receiver is connected.
- Consult the dealer or an experienced radio/TV technician for help.

SPECIFICATIONS

Cat. No.	AC Input		DC Output *	
	Volts	Amps	Volts	Amps
2792-20	120	2.1	18	3.5

* Charges MILWAUKEE M18™ Li-Ion battery packs 48-11-1815, 48-11-1820, 48-11-1828 and 48-11-1840.

SYMBOLOLOGY

	Volts
	Direct Current
	Alternating Current
	Amps
	Hertz
	Double Insulated
	Presence of important operating instructions.
	Caution. Risk of electric shock.
	Underwriters Laboratories, Inc. United States and Canada

GROUNDING

Double Insulated Radios: Radios with Two Prong Plugs

Radios marked "Double Insulated" do not require grounding. They have a special double insulation system which satisfies OSHA requirements and complies with the applicable standards of Underwriters Laboratories, Inc., the Canadian Standard Association and the National Electrical Code. Double Insulated radios may be used in either of the 120 volt outlets shown in Figures A and B.

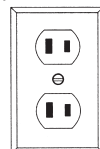

Fig. A

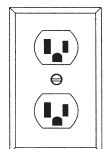
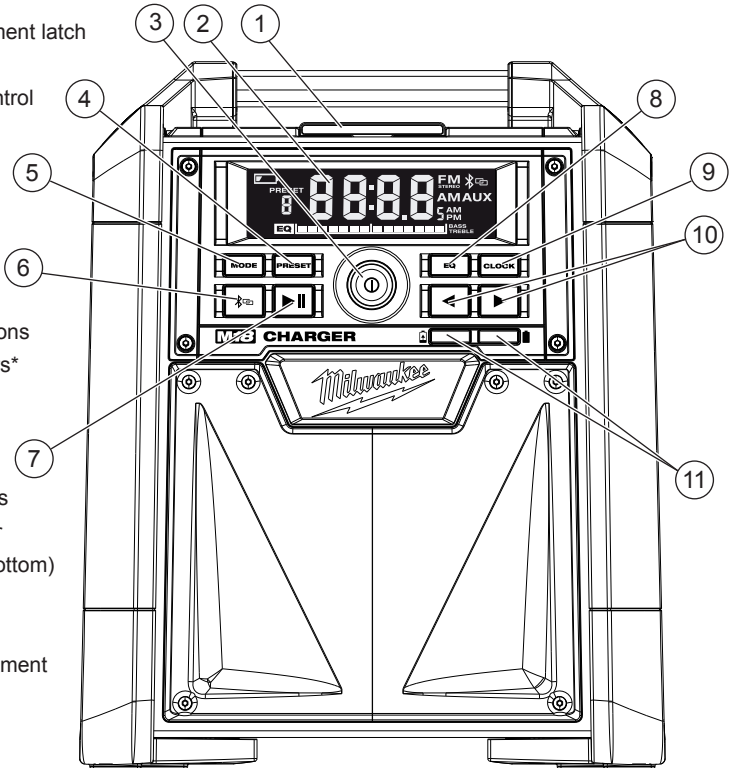

Fig. B





FUNCTIONAL DESCRIPTION

1. Auxiliary compartment latch
2. Display
3. On/Off/Volume control
4. PRESET button
5. MODE button
6. Bluetooth button
7. Play/Pause button
8. EQ button
9. CLOCK button
10. Seek/adjust buttons
11. Charger indicators*
12. Antenna
13. Bottle opener
14. Battery bay
15. Charging contacts
16. Battery bay cover
17. Nameplate (on bottom)
18. Cord
19. Cord wrap
20. Auxiliary compartment
21. Backup-battery compartment (not shown)
22. Stereo AUX jack
23. USB power outlet



* Charger Indicators

When a battery pack is inserted into the charger, the LEDs will indicate the following:

-  Continuous red: Charging
-  Continuous green light: Charging is complete
-  Flashing red: Battery is too hot/cold
Charging will begin when battery reaches correct charging temperature
-  Flashing red/green: Damaged or faulty battery pack

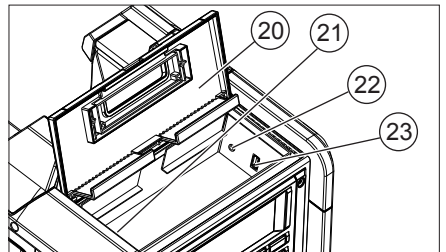
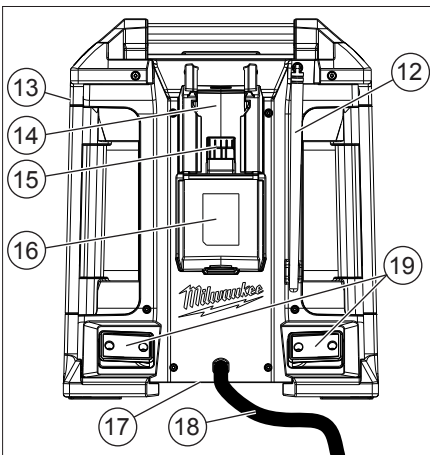

EXTENSION CORDS

Double insulated tools can use either a two or three wire extension cord. As the distance from the supply outlet increases, you must use a heavier gauge extension cord. Using extension cords with inadequately sized wire causes a serious drop in voltage, resulting in loss of power and possible tool damage. Refer to the table shown to determine the required minimum wire size.

The smaller the gauge number of the wire, the greater the capacity of the cord. For example, a 14 gauge cord can carry a higher current than a 16 gauge cord. When using more than one extension cord to make up the total length, be sure each cord contains at least the minimum wire size required. If you are using one extension cord for more than one tool, add the nameplate amperes and use the sum to determine the required minimum wire size.

Guidelines for Using Extension Cords

- If you are using an extension cord outdoors, be sure it is marked with the suffix "W-A" ("W" in Canada) to indicate that it is acceptable for outdoor use.
- Be sure your extension cord is properly wired and in good electrical condition. Always replace a damaged extension cord or have it repaired by a qualified person before using it.
- Protect your extension cords from sharp objects, excessive heat and damp or wet areas.
- Unplug all cords during lightning storms or when unused for long periods of time.

Recommended Min. Wire Gauge for Extension Cords*

Nameplate Amperes	Extension Cord Length				
	25'	50'	75'	100'	150'
0 - 2.0	18	18	18	18	16
2.1 - 3.4	18	18	18	16	14
3.5 - 5.0	18	18	16	14	12
5.1 - 7.0	18	16	14	12	12
7.1 - 12.0	16	14	12	10	
12.1 - 16.0	14	12	10		
16.1 - 20.0	12	10			

* Based on limiting the line voltage drop to five volts at 150% of the rated amperes.

RADIO ASSEMBLY

⚠ WARNING Recharge only with the charger specified for the battery. For specific charging instructions, read the operator's manual supplied with your charger and battery.

Power

The MILWAUKEE M18™ Radio Charger can be powered by MILWAUKEE M18™ Li-Ion battery packs or a standard wall outlet. When plugged into a wall outlet, the battery bay will charge MILWAUKEE M18™ Li-Ion battery packs (see Charger Operation).

Inserting/Removing Battery Pack

1. Open the battery bay cover.
2. To **insert** the battery pack, slide it into the battery bay.
3. To **remove** the battery pack, pull the battery pack off of the bay.
4. Always close the battery bay cover when the bay is not in use.

Low Battery Indicator

When the radio is powered by a battery pack and its charge falls below 10%, the low battery indicator  is displayed.

Battery Pack Protection

To protect the life of the battery pack, the radio will shut off when the battery's charge becomes too low. If this happens, plug radio charger into a 120V outlet and charge the battery pack according to Charger Operation.

Installing an Auxiliary Device

Open the auxiliary compartment to connect an MP3 player, CD player, or other audio device using the stereo auxiliary jack. Small devices can be stored in the compartment during use.

USB Power Outlet

This outlet can be used to charge a cell phone, power an MP3 player or any other device that uses less than 2.1A of DC electrical current.

NOTE: Any device that uses more than 2.1 A of DC electrical current will trip a self-resetting overload and disable the output.

Charging Back-up Batteries



WARNING Batteries may leak chemicals or may explode if used incorrectly. The following care should be taken to prevent such an incident:

- Make sure the positive (+) and negative (-) battery terminals are positioned correctly.
- Do not mix new and old batteries together, or mix different types of batteries.
- Do not try to recharge non-rechargeable batteries.

If chemicals from the batteries come in contact with your skin, wash them off immediately with water. If chemicals leak onto the radio, clean the radio completely.

To hold station presets and clock time when the battery pack is removed and the radio is unplugged, 2 AAA batteries are required.

1. Remove battery pack and unplug radio.
2. Remove the screw and battery cover.
3. Insert two (2) AAA batteries according to matching positive (+) and negative (-) marks.
4. Replace the battery cover and screw.

RADIO OPERATION

⚠ WARNING Always remove battery pack before changing or removing accessories. Only use accessories specifically recommended for this radio. Others may be hazardous.

⚠ WARNING To reduce the risk of fire or electric shock, do not expose this radio to rain or moisture.

① Turning On/Off and Controlling Volume

Plug the cord into an appropriate AC outlet or install a battery pack.

Press the On/Off/Volume control button ① to turn the radio on and off. The radio station (frequency) is displayed. To display the time, press the CLOCK button. Volume is restored to the last setting.

NOTE: When the Radio Charger is running on battery power, the display will dim after 5 minutes to reduce power use.

Rotate the On/Off/Volume control button ① to increase or decrease the volume.

Setting the Clock

1. Press and hold the CLOCK button until the hour begins to flash.
2. Use the ◀ and ▶ buttons to change the hour.
3. Press the CLOCK button again. The minutes will begin to flash. Use the ◀ and ▶ buttons to change the minutes.
4. Press the CLOCK button again to save.

EQ Adjustment

To manually adjust the Bass/Treble sound, press the EQ button. Set the bass sound by rotating the On/Off/Volume control button ①. Press the EQ button again to set the treble sound by rotating the On/Off/Volume control button ①.

Selecting Band

Push the MODE button to select Bluetooth, FM, AM, or AUX.

Tuning and Seeking

Press the ◀ and ▶ buttons to move up and down the band. Press, hold, and release the ◀ and ▶ buttons to SEEK through the band. When a station is found, the SEEK will stop.

PRESET Stations

To **set** the PRESET stations:

1. Tune to desired station.
2. Press and hold the PRESET button until the PRESET indicator on the display begins to flash.
3. Use the ◀ and ▶ buttons to select the PRESET location for the station. Five locations (1-5) are available.
4. Press the PRESET button to save the location.

To **tune** to a PRESET station:

Press and release the PRESET button to step through the PRESET stations.

Using the Stereo AUX Jack

1. Open the Auxiliary Compartment
2. Plug the auxiliary device into the Stereo AUX jack.
3. Use the MODE button to select AUX.
4. Start the auxiliary device.

✳ Using Bluetooth

To enter the Bluetooth mode, press the ✳ button, or press the MODE button to cycle through to Bluetooth.

Pairing

- If no Bluetooth device is connected, Bluetooth pairing will begin automatically and the ✳ icon will flash on the display.
- The radio will continue to search for a signal for 3 minutes.
- To manually pair a device, press and hold bluetooth button until the ✳ icon begins to flash.
- While the ✳ icon is flashing, select "Milwaukee" on the Bluetooth capable device.
- Enter PIN "0000".
- Once the device has successfully paired with the radio, the ✳ icon will be shown on the radio's display.

Connecting

To enter the Bluetooth mode, press the ✳ button, or press the MODE button to cycle through to Bluetooth.

When the radio locates a paired Bluetooth device, the ✳ icon will be shown on the radio's display.

If connection is lost between the radio and the Bluetooth device, the radio will try to reconnect automatically for up to 3 minutes.

Controlling

When streaming music through to the radio via a Bluetooth device, use the ▶|| button to start and pause the music. Use the ◀ and ▶ to move through the tracks.

CHARGER OPERATION

 **WARNING** Charge only **MILWAUKEE M18™** Lithium-Ion battery packs in the **MILWAUKEE** Li-Ion Battery Charger. Other types of batteries may cause personal injury and damage. Battery pack and charger are not compatible with **V™**-technology or **NiCd** systems.

When to Charge **MILWAUKEE** Li-Ion Battery Packs

Remove the battery pack from the tool for charging when convenient for you and your job. **MILWAUKEE** battery packs do not develop a "memory" when charged after only a partial discharge. It is not necessary to run down the battery pack before placing it on the charger.

- Use the Fuel Gauge to determine when to charge your **MILWAUKEE** Li-Ion battery pack.
- You can "Top-Off" your battery pack's charge before starting a big job or long day of use.
- The only time it is necessary to charge the **MILWAUKEE** Lithium-Ion battery pack is when the pack has reached the end of its charge. To signal the end of charge, power to the tool will drop quickly, allowing you just enough power to finish making a cut, drilling a hole, or driving a fastener. Charge the battery pack as needed.

How to Charge the Battery Pack

Plug the Radio Charger into a 120V outlet. The battery packs will not charge if the Radio Charger is not plugged in. Place the battery pack onto the bay by sliding the pack on from the top of the bay. The red light will turn on, either flashing (pack is too hot or cold) or continuous (pack is charging).

- A fully discharged pack with an internal temperature between 32°F and 104°F will charge in 30-Min or 1-Hour, depending on the battery pack.
- Heavily cycled battery packs may take longer to charge completely.
- The Fuel Gauge lights on the battery pack are displayed as the pack is being charged, indicating how fully charged the pack is.
- After charging is complete, the continuous green light will turn on and the fuel gauge will turn off.
- The charger will keep the battery pack fully charged if it is left on the charger.
- If the light indicator flashes red and green, check that the battery pack is fully seated into the bay. Remove the pack and reinsert. If the problem persists, contact a **MILWAUKEE** service facility.
- If the light indicator does not come on, check that the battery pack is fully seated into the bay. Remove the pack and reinsert. If the light indicator still does not come on, contact a **MILWAUKEE** service facility.

Charging a Hot or Cold Battery Pack

The Red flashing indicator light on the charger indicates that the battery pack temperature is outside the charging range. Once the pack is within the acceptable range, normal charging will take place and the red light will be continuous. Hot or cold battery packs may take longer to charge.

Li-Ion Charging Status

Battery Pack Temperature	Red Charger Indicator Light	Charging Status
Too Hot	Flashing	Not charging
Normal Range	Continuous	Normal charging
Too Cold	Flashing	Not charging

MAINTENANCE

 **WARNING** To reduce the risk of injury, always unplug your tool before performing any maintenance. Never disassemble the tool or try to do any rewiring on the tool's electrical system. Contact a **MILWAUKEE** service facility for ALL repairs.

Maintenance and Storage

Store your charger in a cool, dry place.

As a general practice, it is best to unplug battery chargers and remove battery packs when not in use. No battery pack damage will occur, however, if the charger and battery pack are left plugged in.

 **WARNING** To reduce the risk of injury, electric shock and damage to the tool, never immerse your tool in liquid or allow a liquid to flow inside the tool.

Cleaning

Clean out dust and debris from charger vents and electrical contacts by blowing with compressed air. Use only mild soap and a damp cloth to clean the battery pack and charger, keeping away from all electrical contacts. Certain cleaning agents and solvents are harmful to plastics and other insulated parts. Some of these include gasoline, turpentine, lacquer thinner, paint thinner, chlorinated cleaning solvents, ammonia and household detergents containing ammonia. Never use flammable or combustible solvents around battery packs, charger, or tools.

Repairs

If your tool is damaged, return the entire tool to the nearest service center.

ACCESSORIES

 **WARNING** To reduce the risk of injury, always unplug the tool before attaching or removing accessories. Use only specifically recommended accessories. Others may be hazardous.

For a complete listing of accessories refer to your **MILWAUKEE** Electric Tool catalog or go on-line to www.milwaukeetool.com. To obtain a catalog, contact your local distributor or a service center.

LIMITED WARRANTY - USA AND CANADA

Every **MILWAUKEE** power tool (including cordless product – tool, battery pack(s) - see separate & distinct **CORDLESS BATTERY PACK LIMITED WARRANTY** statements & battery charger and Work Lights*) is warranted to the original purchaser only to be free from defects in material and workmanship. Subject to certain exceptions, **MILWAUKEE** will repair or replace any part on an electric power tool which, after examination, is determined by **MILWAUKEE** to be defective in material or workmanship for a period of five (5) years* after the date of purchase unless otherwise noted. Return of the power tool to a **MILWAUKEE** factory Service Center location or **MILWAUKEE** Authorized Service Station, freight prepaid and insured, is required. A copy of the proof of purchase should be included with the return product. This warranty does not apply to damage that **MILWAUKEE** determines to be from repairs made or attempted by anyone other than **MILWAUKEE** authorized personnel, misuse, alterations, abuse, normal wear and tear, lack of maintenance, or accidents.

*The warranty period for, Job Site Radios, M12™ Power Port, M18™ Power Source, and Trade Titan™ Industrial Work Carts is one (1) year from the date of purchase. The warranty period for a LED Work Light and LED Upgrade Bulb is a limited LIFETIME warranty to the original purchaser only, if during normal use the LED bulb fails the Work Light or Upgrade Bulb will be replaced free of charge.

*This warranty does not cover Air Nailers & Stapler, Airless Paint Sprayer, Cordless Battery Packs, Gasoline Driven Portable Power Generators, Hand Tools, Hoist – Electric, Lever & Hand Chain, M12™ Heated Jackets, Reconditioned product and Test & Measurement products. There are separate and distinct warranties available for these products.

Warranty Registration is not necessary to obtain the applicable warranty on a **MILWAUKEE** power tool product. The manufacturing date of the product will be used to determine the warranty period if no proof of purchase is provided at the time warranty service is requested.

ACCEPTANCE OF THE EXCLUSIVE REPAIR AND REPLACEMENT REMEDIES DESCRIBED HEREIN IS A CONDITION OF THE CONTRACT FOR THE PURCHASE OF EVERY **MILWAUKEE** PRODUCT. IF YOU DO NOT AGREE TO THIS CONDITION, YOU SHOULD NOT PURCHASE THE PRODUCT. IN NO EVENT SHALL **MILWAUKEE** BE LIABLE FOR ANY INCIDENTAL, SPECIAL, CONSEQUENTIAL OR PUNITIVE DAMAGES, OR FOR ANY COSTS, ATTORNEY FEES, EXPENSES, LOSSES OR DELAYS ALLEGED TO BE AS A CONSEQUENCE OF ANY DAMAGE TO, FAILURE OF, OR DEFECT IN ANY PRODUCT INCLUDING, BUT NOT LIMITED TO, ANY CLAIMS FOR LOSS OF PROFITS. SOME STATES DO NOT ALLOW THE EXCLUSION OR LIMITATION OF INCIDENTAL OR CONSEQUENTIAL DAMAGES, SO THE ABOVE LIMITATION OR EXCLUSION MAY NOT APPLY TO YOU. THIS WARRANTY IS EXCLUSIVE AND IN LIEU OF ALL OTHER EXPRESS WARRANTIES, WRITTEN OR ORAL. TO THE EXTENT PERMITTED BY LAW, **MILWAUKEE** DISCLAIMS ANY IMPLIED WARRANTIES, INCLUDING WITHOUT LIMITATION ANY IMPLIED WARRANTY OF MERCHANTABILITY OR FITNESS FOR A PARTICULAR USE OR PURPOSE; TO THE EXTENT SUCH DISCLAIMER IS NOT PERMITTED BY LAW, SUCH IMPLIED WARRANTIES ARE LIMITED TO THE DURATION OF THE APPLICABLE EXPRESS WARRANTY AS DESCRIBED ABOVE. SOME STATES DO NOT ALLOW LIMITATIONS ON HOW LONG AN IMPLIED WARRANTY LASTS, SO THE ABOVE LIMITATION MAY NOT APPLY TO YOU, THIS WARRANTY GIVES YOU SPECIFIC LEGAL RIGHTS, AND YOU MAY ALSO HAVE OTHER RIGHTS WHICH VARY FROM STATE TO STATE. This warranty applies to product sold in the U.S.A. and Canada only.

Please consult the 'Service Center Search' in the Parts & Service section of **MILWAUKEE**'s website www.milwaukeekeetool.com or call **1.800.SAWDUST (1.800.729.3878)** to locate your nearest service facility for warranty and non-warranty service on a Milwaukee electric power tool.

LIMITED WARRANTY - MEXICO, CENTRAL AMERICA AND CARIBBEAN

TECHTRONIC INDUSTRIES' warranty is for 5 year since the original purchase date.

This warranty card covers any defect in material and workmanship on this Power Tool.

To make this warranty valid, present this warranty card, sealed/stamped by the distributor or store where you purchased the product, to the Authorized Service Center (ASC). Or, if this card has not been sealed/stamped, present the original proof of purchase to the ASC.

Call toll-free 1 800 832 1949 to find the nearest ASC, for service, parts, accessories or components.

Procedure to make this warranty valid

Take the product to the ASC, along with the warranty card sealed/stamped by the distributor or store where you purchased the product, and there any faulty piece or component will be replaced without cost for you. We will cover all freight costs relative with this warranty process.

Exceptions

This warranty is not valid in the following situations:

- When the product is used in a different manners from the end-user guide or instruction manual.
- When the conditions of use are not normal.
- When the product was modified or repaired by people not authorized by TECHTRONIC INDUSTRIES.

Note: If cord set is damaged, it should be replaced by an Authorized Service Center to avoid electric risks.

Model: _____

Date of Purchase: _____

Distributor or Store Stamp: _____

SERVICE AND ATTENTION CENTER
Av Presidente Mazarik 29 Piso 7, 11570 Chapultepec Morales
Miguel Hidalgo, Distrito Federal, Mexico
Ph. 52 55 4160-3547

IMPORTED AND COMMERCIALIZED BY:
TECHTRONIC INDUSTRIES MEXICO, S.A. DE C.V.
Av Presidente Mazarik 29 Piso 7, 11570 Chapultepec Morales
Miguel Hidalgo, Distrito Federal, Mexico

- RF exposure information: The Maximum Permissible Exposure (MPE) level has been calculated based on a distance of $d=20$ cm between the device and the human body. To maintain compliance with RF exposure requirement, use product that maintain a 20cm distance between the device and human body.