

INSTRUCTIONS

ITEM NO. 9303

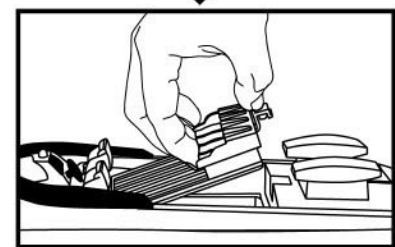
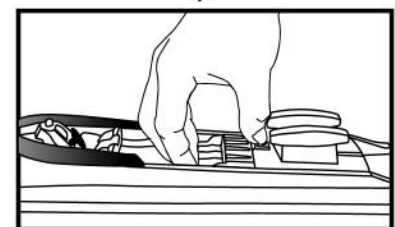
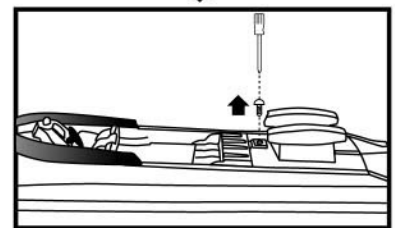
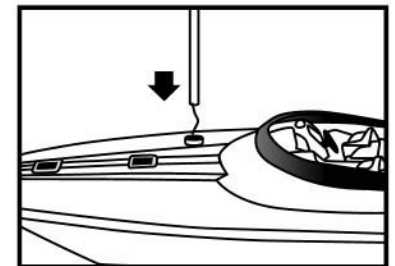
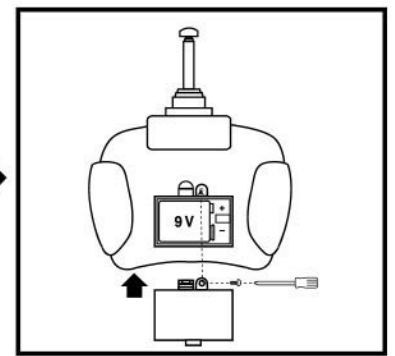
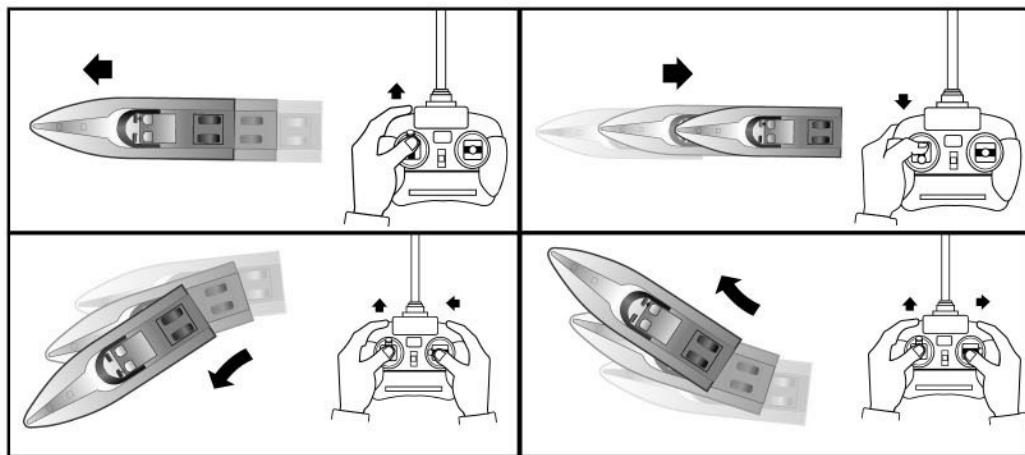
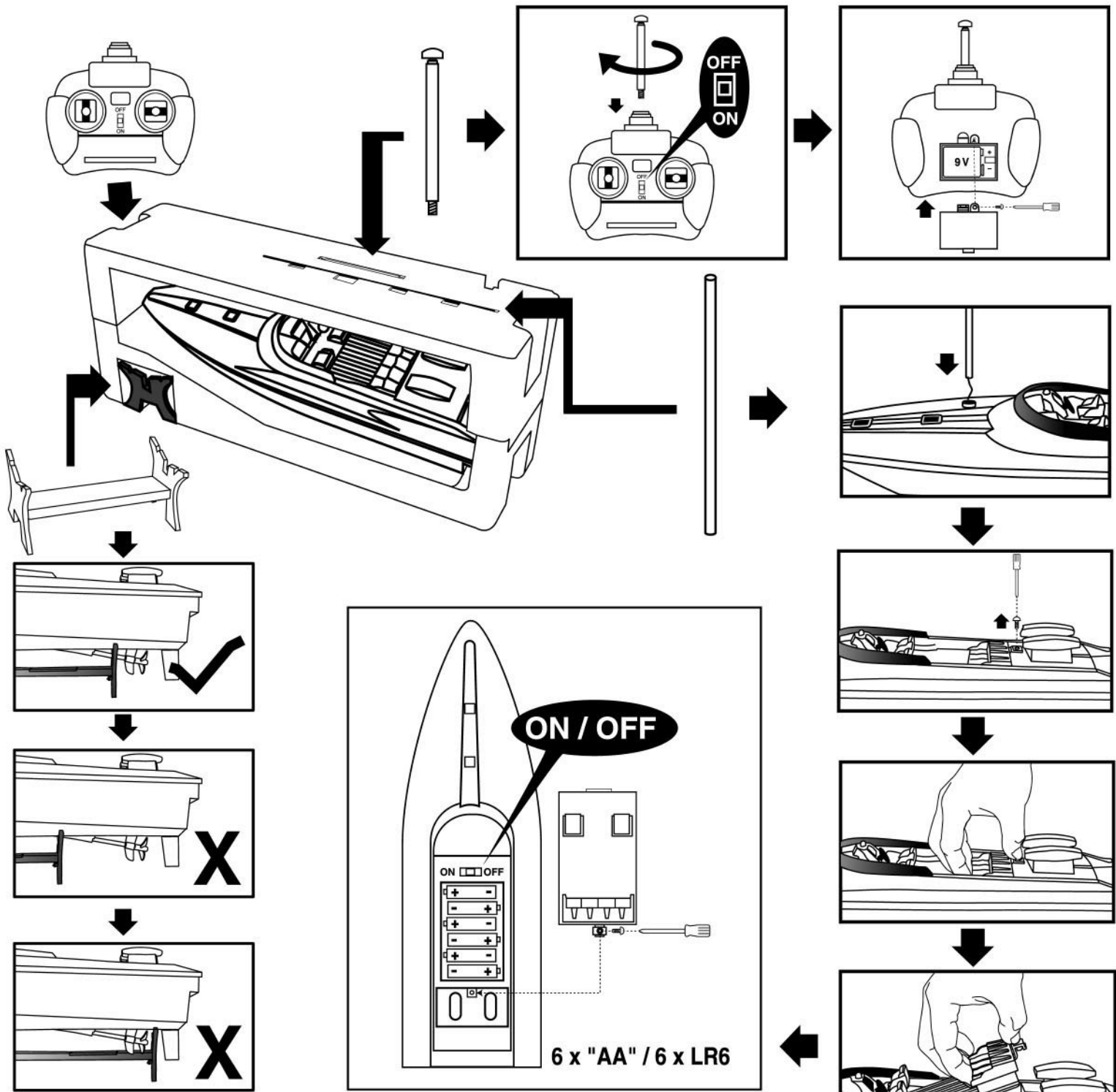

FCC Note:

The manufacturer is not responsible for any radio or TV interference caused by unauthorized modifications to this equipment. Such modifications could void the user's authority to operate the equipment.

IF YOU FIND ANY FUNCTIONAL PROBLEMS IN OPERATING THIS TOY, PLEASE READ CAREFULLY THE INSTRUCTION SHEETS AND/OR E-MAIL US AT THE FOLLOWING ADDRESS: goldenbright@attglobal.net