

GoldStar

<http://www.LGService.com>

e-mail <http://www.LGService.com/techsup.html>

DEHUMIDIFIER OWNER'S MANUAL

Please read the operating instructions and safety precautions carefully and thoroughly before operating your dehumidifier.

You can refer to the Energy Star program in detail at "www.energystar.gov"



As an ENERGY STAR® Partner, LG Electronics Inc. has Determined that this product meets the ENERGY STAR® guidelines for energy efficiency.
(Except DH30E)

**MODEL: DH30E
DH40E
DH50E, DH50EL
DH65E, DH65EL
DH70EL**

Safety Precautions.....3

Operating Instructions.....5

Installation Instructions.....8

Care and Maintenance9

Troubleshooting Tips..... 10

Warranty.....Back cover

Customer Assistance NumbersBack cover



FOR YOUR RECORDS

Write the model and serial numbers here:

You can find them on a label on the back of the dehumidifier behind the bucket.

Model # _____

Serial # _____

Dealer's Name _____

Date Purchased _____

Staple your receipt here. _____



READ THIS MANUAL

Inside you will find many helpful hints on how to use and maintain your dehumidifier properly. Just a little preventive care on your part can save you a great deal of time and money over the life of your dehumidifier.

You'll find many answers to common problems in the chart of Troubleshooting Tips. If you review our chart of Troubleshooting Tips first, you may not need to call for service at all.



PRECAUTION



- Contact an Authorized Service Center for repair or maintenance of this unit.
- The dehumidifier is not intended for use by young children or invalids without supervision.
- Young children should be supervised to ensure that they do not play with the dehumidifier.





Safety Precautions

Read all instruction before using.

- To prevent injury to the user or other people and property damage, the following instructions must be followed.
- Incorrect operation due to ignoring instructions will cause harm or damage; the seriousness is classified by the following indications.

	WARNING	This symbol indicates the possibility of death or serious injury.
	CAUTION	This symbol indicates the possibility of injury or damage to properties only.

- Meanings of symbols used in this manual are as shown below.

	Be sure not to do.
	Be sure to follow the instruction.

WARNING

Complete all grounding and installation requirements as described on page 5.

- Otherwise, it could cause electrical shock or fire.

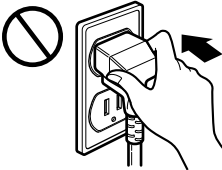

Disconnect power cord from receptacle before servicing or cleaning.

- It could cause electrical shock or fire.

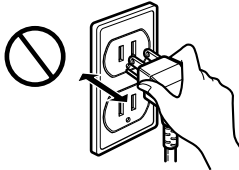

Do not use flammable fluids, solvents, abrasive cleaners, or strong detergents to clean the dehumidifier.

- It could cause fire or product damage hazard.



Do not plug the dehumidifier in until the outside of unit is completely dry.

- It could cause electrical shock and personal injury hazard.

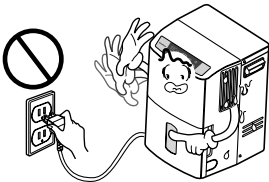

Do not use the water collected in the bucket for drinking purposes.

- It is not sanitary and could cause illness or personal injury hazard.

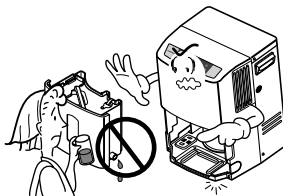

Do not clean the dehumidifier while it is plugged in, especially if it is wet.

- It may cause electrical shock.

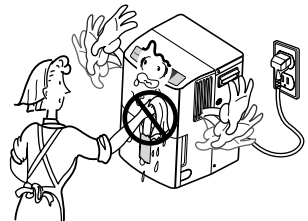

CAUTION

Be sure to block the wheels to prevent unit from falling when installed on a table or shelf.

- It may damage the dehumidifier or cause other damage or injury.

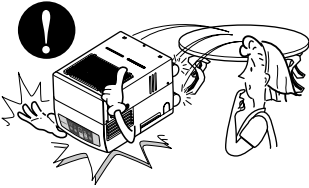

Be sure to replace bucket properly after emptying to prevent water from collecting on the floor.

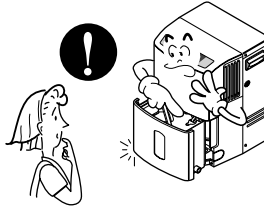

Make sure the dehumidifier is the correct size for the area you want to dehumidify.

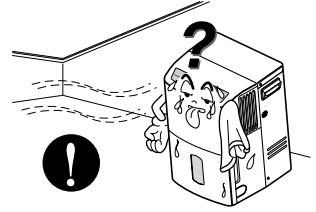

Do not operate switches with wet hands.

- It may cause electrical shock.

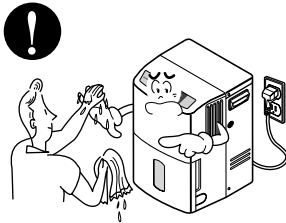

Install the dehumidifier properly on a floor, table, or shelf that is level and strong enough to support it with a full bucket of water.

- It should withstand around 90 lbs (40kg) weight.

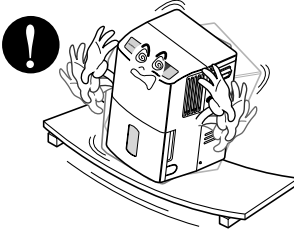

Do not install dehumidifier in an area where temperatures will fall below 65°F (18°C.)

- Low temperatures could cause coils to frost and unit may not start.

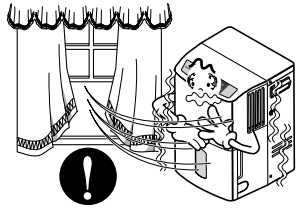

Close all doors, windows and other outside openings to the room.

- The dehumidifier must be operated in an enclosed area to be most effective.

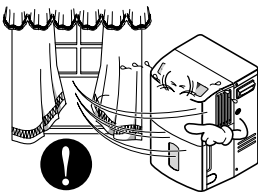

When the unit is to be cleaned, switch it off.

- It will cause electrical shock or fire.

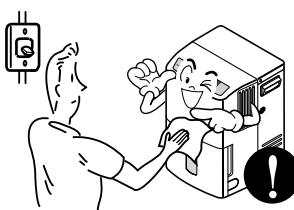

Do not put a pet or house plant where it will be exposed to direct air flow.

- This may injure the pet or plant.

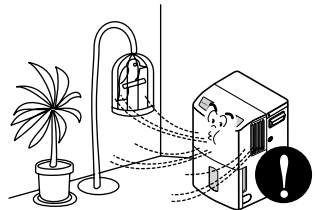

Operating Instructions

Features

This section contains captioned illustrations of your appliance. Use the drawings to become familiar with all parts and features and what they look like.

1. Control panel
2. Case front
3. Power cord
4. Top cover
5. Air filter
6. Water bucket
7. Cabinet

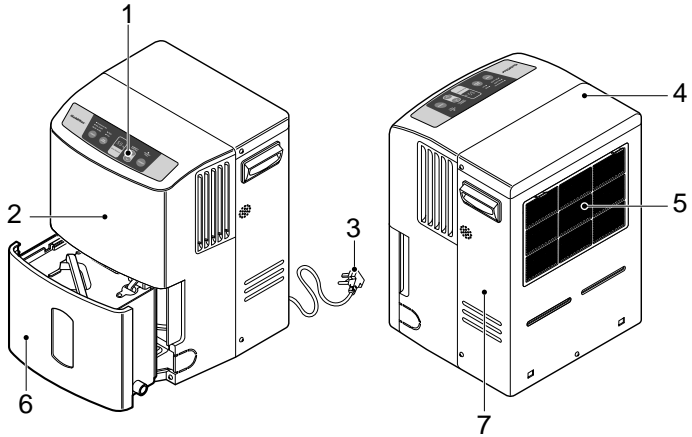

Electrical requirements

OBSERVE ALL LOCAL CODES AND ORDINANCES. DO NOT, UNDER ANY CIRCUMSTANCES, REMOVE THE POWER SUPPLY CORD GROUND PRONG.

Electrical ground is required on this appliance.

A 115-volt 60 Hz, AC only, 15A fused and properly grounded electrical supply is required. A time delay fuse or time delay circuit breaker is recommended.

Use a dedicated circuit, serving only this appliance. Do not use an extension cord.

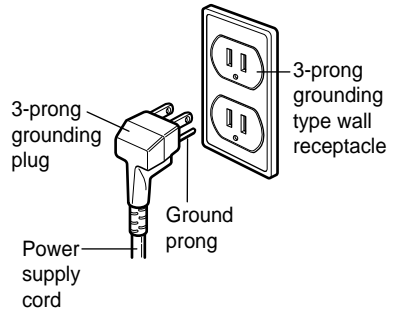

Recommended grounding method

For your personal safety, this appliance must be grounded. This appliance has a power supply cord with a 3-prong grounding plug. To minimize possible shock hazard, the cord must be plugged into a mating grounding type wall receptacle, grounded in accordance with the National Electrical Code (ANSI/NFPA 70) latest edition and all local codes and ordinances. If a mating wall receptacle is not available, it is the personal responsibility and obligation of the customer to have a properly grounded 3-prong wall receptacle installed by a qualified electrician.

Operating your dehumidifier

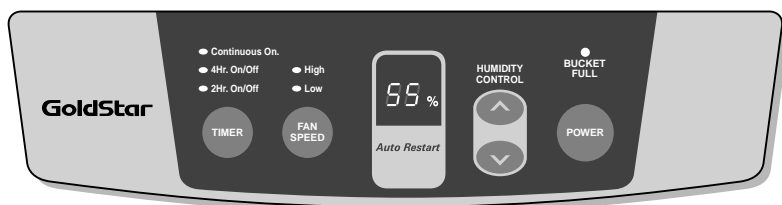



CONTROL PANEL

The dehumidifier control panel contains: Bucket Full Indicator, Humidity Indicator, Power Control, Humidity Control, Fan Speed and Timer Control.

Bucket Full indicator --- This light glows when the water bucket is full and needs to be emptied.

Power --- Operation starts when this button is pressed and stops when the button is pressed again.

Humidity Control --- This button controls the humidity in the room.

-  : To raise the humidity setting
-  : To lower the humidity setting
- The humidity setting can be set to a permanent "On" setting or to a specific humidity setting between 35% and 70% in 5% increments.
 - "On" setting - dehumidifier runs continuously regardless of humidity condition.
 - 35% - 70% setting - dehumidifier shuts on and off according to surrounding humidity conditions.

Fan Speed --- This controls the speed of the airflow.



- High: Fan speed is set to high.
- Low: Fan speed is set to low.
- When Fan Speed button is pressed, the fan speed mode is changed.

Energy Timer --- Press this button to select type of operation.

- Select Constantly On for uninterrupted operation.
- Select either 2 or 4 Hr. On/Off for cycled operation:
 - The unit will operate for 2 or 4 hours, and then shut off completely for 2 or 4 hours.
 - The cycle repeats until you change the setting.
- When Energy Timer button is pressed, the Timer indicator lights shift as follows:
 - Continuous On → 2 Hr. On/Off → 4 Hr. On/Off → Continuous On.

Auto Restart --- Once power is restored after a power failure, the unit returns to its previous operation setting. The fan turns on immediately but, humidity control starts after a 2 minute delay.

TO OPERATE THE DEHUMIDIFIER:

1. Plug the power cord into an electrical outlet. Press the power button.
2. Set the humidity Control to "On" or to a specific humidity level between "35% RH(Relative Humidity) and 70%RH(Relative Humidity)" for normal operation.
 - If you need drier air, press the  Humidity Control button.
 - If you need less moister air, press the  Humidity Control button.
3. Press the Power button to stop the unit manually.
4. Press the Timer button to set the amount of time you want the unit to run.
 - At the end of that time, the unit will shut off.
 - The Timer can be set for : Continuous On, 4 hours or 2 hours.
5. If you want to control the speed of airflow, press Fan Speed button. Each time that the Fan Speed button is pressed, the fan speed mode is shifted: High → Low → High

Note: Be careful not to lose the water bucket.

This dehumidifier doesn't run if the water bucket is not installed properly.

Automatic shut off

The dehumidifier will turn off automatically when the bucket is full, or when the bucket is removed or not replaced in the proper position.

The bucket must be replaced in the proper position for the dehumidifier to work. The light will be on and the dehumidifier will not run if the bucket is not in the proper position.

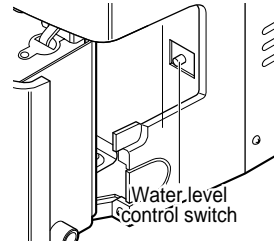

Disposing of collected water

1. Empty the bucket manually.

When the bucket is full, pull out and empty it into a large sink or tub and then replace it properly.

NOTE: Do not overtighten the hose when connecting it to the bucket. Use a rubber washer and tighten by hand firmly without stripping the plastic threads.

NOTE: Be careful while taking out the bucket as it can cause damage.

NOTE: Please do not shake strongly when you carry the bucket. It can cause to breakage of the handle or bucket cover. It is advisable to carry the bucket by supporting it from the bottom.

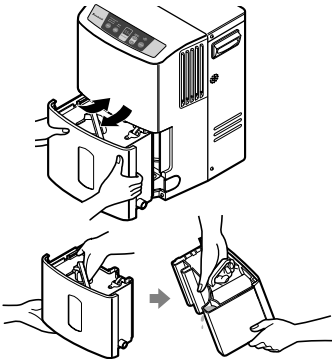

2. Attach a length of garden hose to the threaded bucket drain hose connection to carry water to the drain.

The bucket has a threaded hose connection which can be left open. Drill a 1/4" (6.4 mm) hole in the center of the hose connection. Once opened, the hose connection will continually drain water from the bucket.

NOTE: The nozzle cannot be fixed after puncture. Use an ordinary garden hose cap to reclose if necessary.

NOTE: When inserting the bucket into the unit, lifting up the bottom tip of the bucket lightly makes insertion easily.

When being attached to the bucket drain hose connection, be sure the hose doesn't kink or bend. It should lie flat from the dehumidifier to the drain.

NOTE: The hose attachment will accept a standard garden hose filling. You can attach a screw-on cap to use the bucket without a hose.

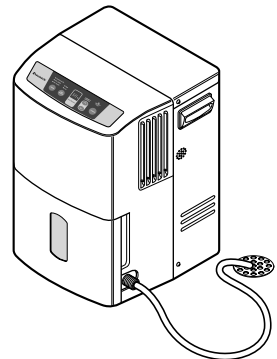
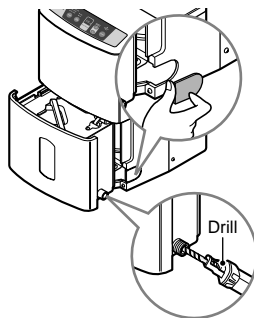

Installation Instructions

Choosing the proper location for your dehumidifier

- Use the dehumidifier in a basement to help prevent moisture damage.
- Use the dehumidifier in laundry drying, bathing, and dishwashing areas which have excessive moisture.
- Use the dehumidifier to prevent moisture damage anywhere books are stored.

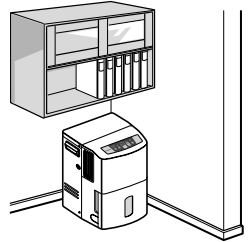
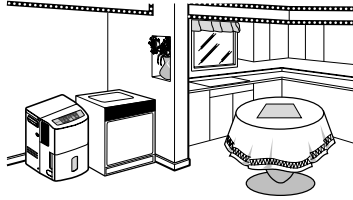
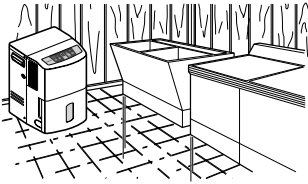

Installing the dehumidifier properly

1. Allow at least 12 inches of space on all sides of the unit for good air circulation.
2. Install your dehumidifier on a floor, table, or shelf. When installing the dehumidifier on a table or shelf, make sure the table or shelf is strong enough to support the weight of the dehumidifier with a full bucket. Do not sit or stand on the dehumidifier.
NOTE: The height of a table or shelf might provide a better position from which to handle the bucket and help prevent icing of the coils due to colder air near the floor (such as in a basement.)
3. Lift the bucket and place it in the dehumidifier, making sure the slots on the bottom side of the bucket are positioned correctly.
4. Rollers let you move the dehumidifier easily.

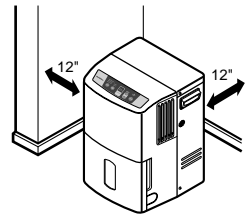
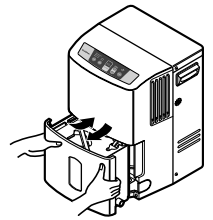

The cleaning of bucket

1. Pull out the bucket cover.
2. Brush off the filth in the bucket.
3. Close the cover.

NOTE: Please push the left side of the cover after the two Upsides are upward completely when closing the cover.

NOTE: Clean the bucket by wiping with brush and cloth dampened in a mild detergent solution.

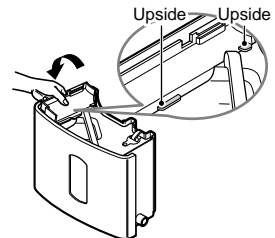
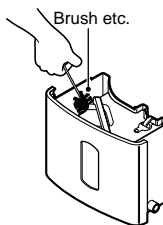
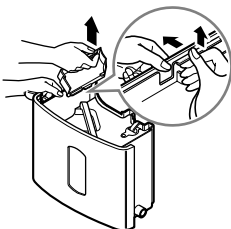

Care and Maintenance

Your dehumidifier is designed to serve you year-round. It needs practically no attention. However, you should check your dehumidifier and inspect the coils annually.

You may want an Authorized Service Center to perform this annual checkup. (Cost of the inspection is the owner's responsibility.)

OR

If you are familiar with electrical appliances and their functions, listed below are instructions which would allow you to perform the inspection and maintenance for yourself.

Cleaning the front case bucket and cabinet

Clean the front case and the cabinet with a soft cloth, warm water, and a mild detergent.

Do not use bleach or abrasives.

Cleaning the air filter

1-1. First pull out the air filter by pressing the filter hooks lightly. Then release two tabs at the bottom side of the filter.

1-2. Wash air filter with warm water and a mild detergent. Rinse and dry it.

Replace it in place.

Cleaning the coil

2-1. Remove air filter from the cabinet regarding to the above.

2-2. Brush the coil gently like arrow in the figure, if necessary, with warm water and a mild detergent. Rinse and dry them thoroughly.

Be careful not to spray the coil with a water hose.

Be careful! Sharp edges!

⚠ WARNING

Electrical Shock Hazard

- Disconnect power supply cord from receptacle before performing any maintenance.
- Be careful when cleaning the coils. Fins are sharp.

Failure to follow the above precautions could result in electrical shock or personal injury.

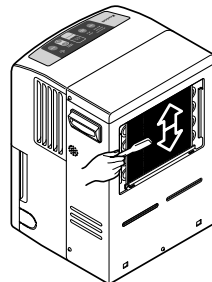
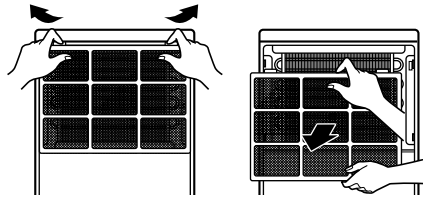
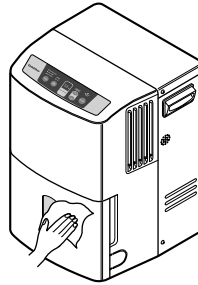

Troubleshooting Tips

Before you call for service, review this list. It may save time and money.

The list includes common occurrences that are not the result of defective workmanship or materials in this appliance.

Problem	Possible Causes	What To Do
Dehumidifier does not start	The dehumidifier power cord is unplugged	<ul style="list-style-type: none"> • Make sure the dehumidifier plug is pushed completely into the outlet.
	The fuse is blown or circuit breaker is tripped.	<ul style="list-style-type: none"> • Check the house fuse or circuit breaker box and replace the fuse or reset the breaker.
	Water bucket is full	<ul style="list-style-type: none"> • The dehumidifier automatically turns off when this occurs. Empty the bucket.
	Bucket is not installed.	<ul style="list-style-type: none"> • Make sure the bucket is in the right place.
	Operation Delay	<ul style="list-style-type: none"> • When unit is first plugged in or after a power outage, there will be a 2 minute delay before operation begins. Operation resumes at previous settings.
Dehumidifier does not dry the air as it should	Did not allow enough time to remove the moisture.	<ul style="list-style-type: none"> • When first installed, allow at least 3 or 4 days to maintain the desired dryness.
	Airflow is restricted.	<ul style="list-style-type: none"> • Make sure there are no curtains, blinds or furniture blocking the front or back of the dehumidifier.
	The Humidity Control may not be set low Humidity.	<ul style="list-style-type: none"> • Press the  Humidity Control button to lower the humidity.
	Doors and windows may not be closed tightly.	<ul style="list-style-type: none"> • Check that all doors, windows and other openings are securely closed.
	Clothes dryer may be blowing moisture-laden air into the room.	<ul style="list-style-type: none"> • Install the dehumidifier away from the dryer. The dryer should be vented to the outside.
	Room temperature is too low.	<ul style="list-style-type: none"> • The unit will not operate satisfactorily if the room temperature is below 65°F. (18 °C.).
	Dehumidifier runs too much	Area to be dehumidified is too large.
Doors and windows are open.		<ul style="list-style-type: none"> • Close all doors and windows to the outside.
Frost appears on the coils	Dehumidifier has been recently turned on or room temperature is below 65°F. (18°C.).	<ul style="list-style-type: none"> • This is normal. Frost will usually disappear within 60 minutes.
Fan noise	Air is moving through the dehumidifier.	<ul style="list-style-type: none"> • This is normal.
Water on floor	Bucket drain hose connection may be loose.	<ul style="list-style-type: none"> • Check the hose if one is attached.
	Water bucket is not all the way in.	<ul style="list-style-type: none"> • See Removing and Emptying The Water Bucket.

GOLDSTAR DEHUMIDIFIER LIMITED WARRANTY – USA

LG Electronics Inc. will repair or replace your product, at LG's option, if it proves to be defective in material or workmanship under normal use, during the warranty period set forth below, effective from the date of original consumer purchase of the product. This limited warranty is good only to the original purchaser of the product and effective only when used in the United States, including U.S. Territories.

<p><u>WARRANTY PERIOD:</u></p> <p>Labor: 1 Year from the Date of Purchase.</p> <p>Parts: 1 Year from the Date of Purchase.</p> <p>Compressor: 5 Years from the Date of Purchase.</p>	<p><u>HOW SERVICE IS HANDLED:</u></p> <p>Call 1-800-243-0000 and choose the appropriate prompt. Please have product type (Dehumidifier) and ZIP code ready.</p> <p>Dehumidifiers receive carry-in service.</p>
--	---

THIS WARRANTY IS IN LIEU OF ANY OTHER WARRANTIES, EXPRESS OR IMPLIED, INCLUDING WITHOUT LIMITATION, ANY WARRANTY OF MERCHANTABILITY OR FITNESS FOR A PARTICULAR PURPOSE. TO THE EXTENT ANY IMPLIED WARRANTY IS REQUIRED BY LAW, IT IS LIMITED IN DURATION TO THE EXPRESS WARRANTY PERIOD ABOVE. LG WILL NOT BE LIABLE FOR ANY CONSEQUENTIAL, INDIRECT, OR INCIDENTAL DAMAGES OF ANY KIND, INCLUDING LOST REVENUES OR PROFITS, IN CONNECTION WITH THE PRODUCT. SOME STATES DO NOT ALLOW LIMITATION ON HOW LONG AN IMPLIED WARRANTY LASTS OR THE EXCLUSION OF INCIDENTAL OR CONSEQUENTIAL DAMAGES, SO THE ABOVE LIMITATIONS OR EXCLUSIONS MAY NOT APPLY TO YOU.

THIS LIMITED WARRANTY DOES NOT APPLY TO:

1. Service trips to your home to deliver, pick up, and/or install the product, instruct, or replace house fuses or correct wiring, or correction of unauthorized repairs; and
2. Damages or operating problems that result from misuse, abuse, operation outside environmental specifications or contrary to the requirements or precautions in the Operating Guide, accident, vermin, fire, flood, improper installation, acts of God, unauthorized modification or alteration, incorrect electrical current or voltage, or commercial use, or use for other than intended purpose.
3. Therefore, the cost of repair or replacement of such a defective product shall be borne by the consumer.

CUSTOMER INTER-ACTIVE CENTER NUMBERS:

<p>To Prove Warranty Coverage</p>	<p>Retain your Sales Receipt to prove date of purchase. A copy of your Sales Receipt must be submitted at the time warranty service is provided.</p>
<p>To Obtain Nearest Authorized Service Center or Sales Dealer, or to Obtain Product, Customer, or Service Assistance</p>	<p>Call 1-800-243-0000 (Monday ~ Friday, 7 AM ~ 8 PM CT; and Saturday, 8 AM ~ 5 PM CT) and choose the appropriate prompt from the menu; or visit our website at http://www.lgservice.com.</p>