

720P Digital Color Video Baby Monitor with 5" HD LCD

USER MANUAL



Model No.: 8203KF

Version 1.0

Please read this user manual carefully before using this product. Failure to understand operation procedures may result in injury.

EU Environmental Protection

Waste electrical products should not be disposed of with household waste. Please recycle where facilities exist. Check with your local authority or retailer for recycling advice.



Introduction

Thank you for choosing our baby monitor. Before using the product please read the instruction carefully in case of damage to the product due to improper operation.

Parts in the package

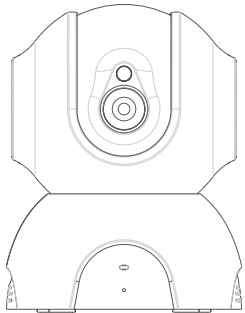

Camera

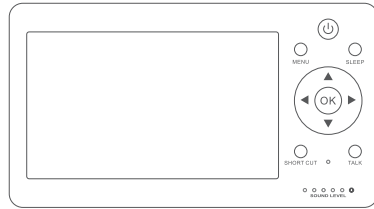

Monitor

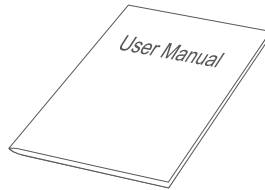

Instruction

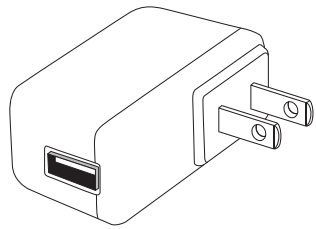

Power adapter (for camera, 5V 1A)

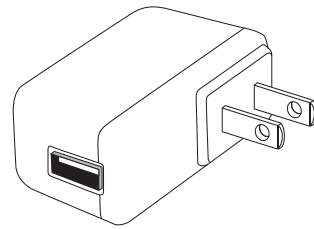

Power adapter (for monitor, 5V 2A)

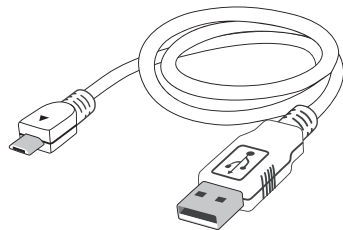

Power cable x2

product structure

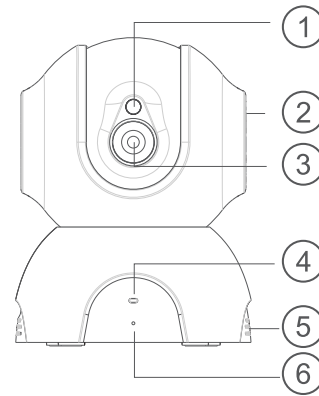

- 1. Photosensitive sensor
- 2. Horn
- 3. Lens
- 4. Indicator LED
- 5. Louver
- 6. Microphone
- 7. SET button
- 8. Temperature sensor
- 9. Antenna
- 10. USB interface

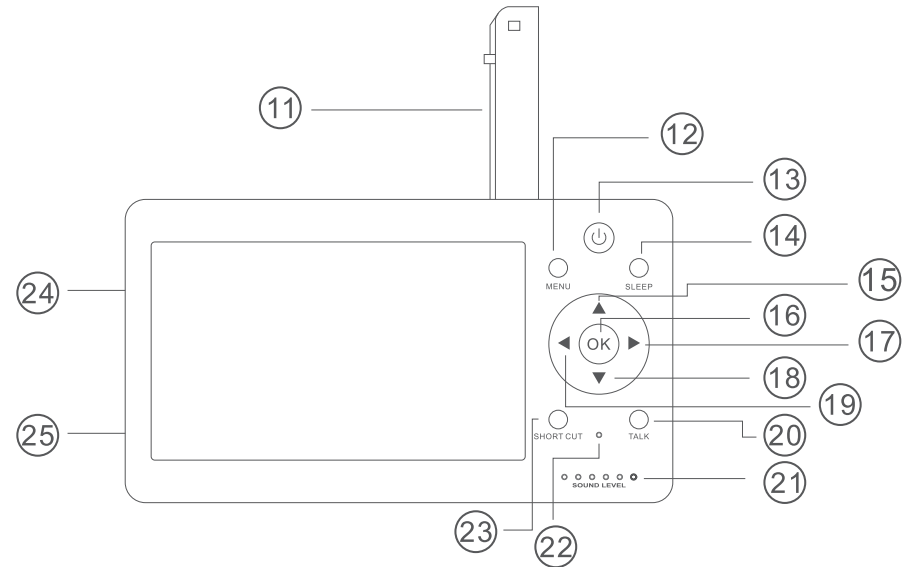

- 11. Antenna
- 12. Menu button/Return
- 13. On/off button
- 14. Sleep button
- 15. Shift up/Brightness+
- 16. Confirmation button/Zoom button
- 17. Shift right/Volume+
- 18. Shift down/Brightness-
- 19. Shift left/Volume-
- 20. Dialogue key
- 21. Status indicator
- 22. Microphone
- 23. Shortcut button
- 24. SET button
- 25. USB interface

Function introduction of buttons for camera



Indicator LED. **When green LED flashes slowly**, startup is successful, or the camera is disconnected with the monitor. **When green LED flashes quickly**, the camera and monitor are being paired. **When green LED is on constantly**, the camera and monitor are paired successfully.

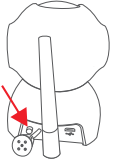

SET button. **Short press it for 1s**, jump to pairing mode; **long press for 5s**, factory reset.

Function introduction of buttons for monitor



Turn on/off the display (press for 2s)



MENU

Press the button to jump to Menu, press the button again, exit from Menu. The button also has the function of returning to previous step.



SLEEP

Sleep button. Press this button, the screen is off, press it again, the screen turns on. (this button does not influence automatic sleep setup. Automatic sleep still functions normally.)



In real-time viewing, by pressing this button, the camera can be controlled to turn left.

In menu interface, by pressing this button, the menu cursor shifts left.

In shortcut interface, press this button to turn down volume.



In real-time viewing, by pressing this button, the camera can be controlled to turn right.

In menu interface, by pressing this button, the menu cursor shifts right.

In shortcut interface, press this button to turn up volume.



In real-time viewing, by pressing this button, the camera can be controlled to turn upward.

In menu interface, by pressing this button, the menu cursor shifts upward.

In shortcut interface, by pressing this button, brightness of the display is increased



In real-time viewing, by pressing this button, the camera can be controlled to turn downward.

In menu interface, by pressing this button, the menu cursor shifts downward.

In shortcut interface, by pressing this button, brightness of the display is decreased



OK

In real-time viewing, by pressing this button, the image size is doubled.

In menu interface, pressing this button to confirm.



SHORT CUT

Shortcut button. By pressing this button, shortcut

interface  pops up, volume and brightness of

the monitor can be adjusted.



TALK

In real-time viewing, by pressing this button, jump to talkback function;

releasing the button, talkback function is off. The voice from camera end cannot be heard till the button is released.



SOUND LEVEL

Status indicator LED:

The first green LED lights constantly: indicates that the camera and monitor are connected successfully

The first green LED flashes slowly (once per second): indicates that it is starting, without connecting the camera

The first green LED flashes quickly (3 times per second): indicates code matching

From the second to fifth green LEDs flash from low to high: Quantity of flashing LED indicates sound volume received









From the second to fifth green LEDs flash simultaneously (once per second): indicates that alert signal is received.

The sixth LED constantly gives off red light: indicates that the lithium battery is being charged; (it always be shown whether it is on or off)



The sixth LED is off: indicates that the battery is charged fully

Explanation for icons

Icon of status bar

	No signal connection between the monitor and camera
	Signal strength between the monitor and camera
	Cradlesong enabled
	Sleep setup of monitor enabled
27°C	Show current room temperature
	Show current battery level. When battery level is too low, the icon will become  and flash
	Sound alarm enabled
	Temperature alarm enabled

Icon for message push

	Camera is not added or camera and monitor are disconnected
	Sound alarm prompt
	Temperature alarm prompt

Equipment installation

1. Position the camera(s)

Find a location for the camera that gives you the best view of your baby in his or her crib.

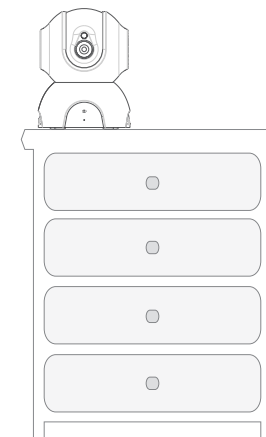
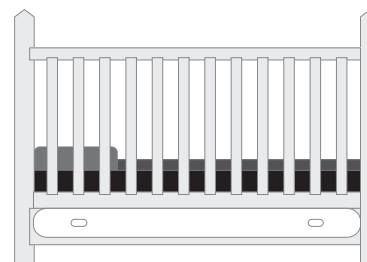

Place the camera on a flat surface, like a dresser.

IMPORTANT: NEVER place the camera or cords of any kind inside the crib. NEVER place the camera or cords within reach of the baby.

Before you start...

Make sure you read the important information sheet included in this package.

WARNING

Strangulation

Hazard: Children have STRANGLED in cords. Keep this cord out of the reach of children (more than 3ft (0.9m) away). Never use extension cords with AC Adapters. Only use the AC Adapters provided.



1. Installation of camera

1. Charge the camera

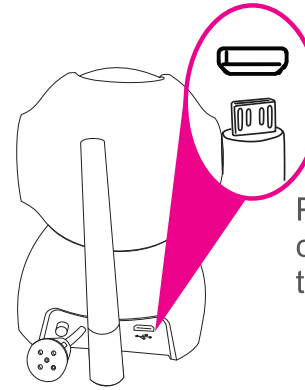

Plug an end of the accompanying charging cable into the USB port in the back of camera.

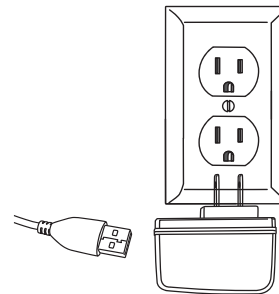

Plug the other end into the accompanying power adapter. Then plug the adapter into a socket.

After the camera is powered on it will start up automatically. (the camera automatically swings up-down ward or from side to side, the indicator LED on camera base lights and the green LED flashes slowly. Now, the camera starts up successfully).

2. Installation of monitor

1. Power on monitor (the monitor has a built-in lithium battery, if it has enough power, please implement the second step operation directly).

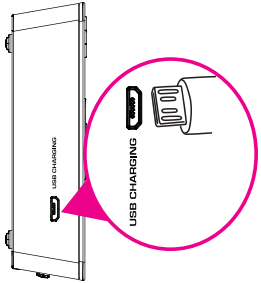

Plug an end of the charging cable into the USB charging port in the side of monitor. Plug the other end of the charging cable into the power adapter. Then plug the adapter into a power socket.

2. Starting up of monitor

Press  on the monitor for 2s





Now, real-time video will be shown on monitor

Note: The equipment had been paired before leaving factory. If no video is shown on the monitor after above operation, please complete equipment pairing operation again. For detailed procedure please see p10, Camera Pairing.

Function setting of the monitor

You can define functions for your baby monitor to meet your demands better. Sound and temperature alarm will inform you automatically. In the chapter every setup that can be defined by you will be explained one by one.

Monitor access menu

In real-time viewing, press the  button on the monitor to return to menu bar. In non-real-time case, press  button for multiple times till the screen jumps to menu bar.

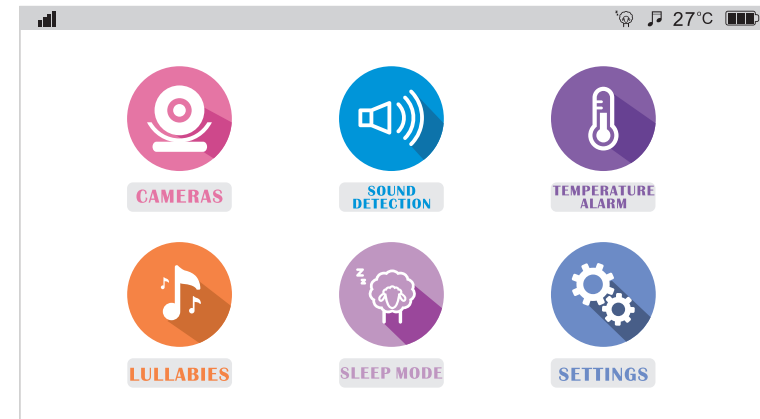



Setting of camera (camera pairing and deletion)

1. Add camera

1. Select the "📷" icon, then press the "OK" button of the monitor.
2. Select the "📷+" icon, then press the "OK" button of the monitor.

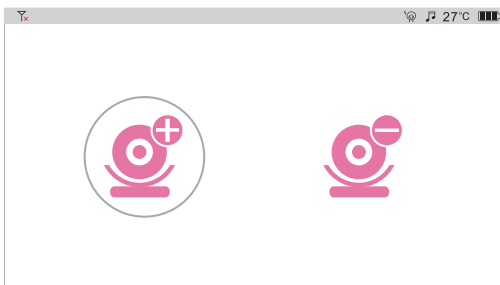

3. Now, the equipment will prompt "camera is no paired"

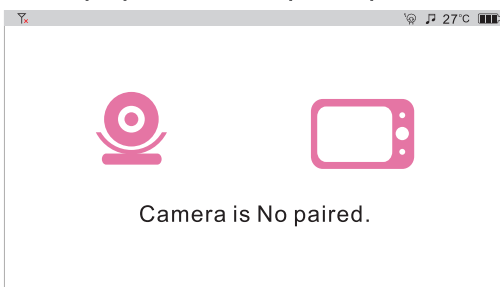

4. Press the yellow SET button behind camera base for 1s, green indicator LED of the camera will flash quickly, now, the equipment jumps to pairing mode. Then, press the "OK" button of the monitor.

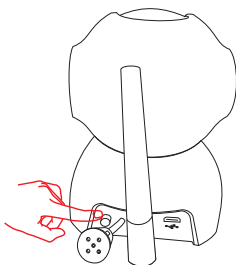

5. Now, the camera and monitor start pairing mode.

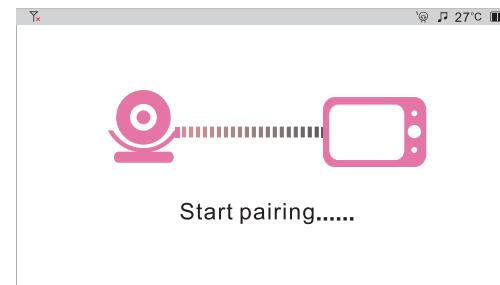

6. When the monitor prompts "pairing is OK", it indicates that equipment is paired successfully.

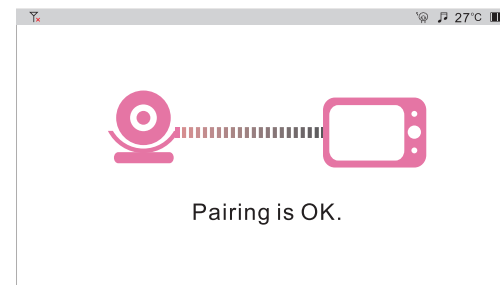

7. The monitor will jump to monitoring screen, and green indicator LED of the camera will light constantly.



2. Delete camera

1. Select the "📷" icon, then press the "OK" button of the monitor.
2. Select the "📷" icon, then press the "OK" button of the monitor.

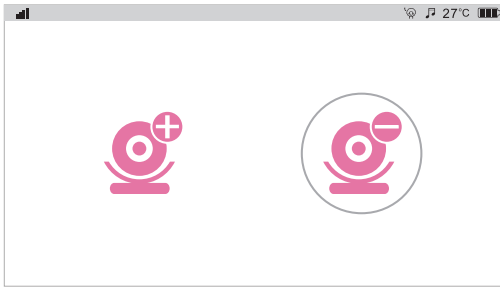

3. Now, the equipment will prompt "camera is paired. Can be deleted". Press the "OK" button of the monitor.

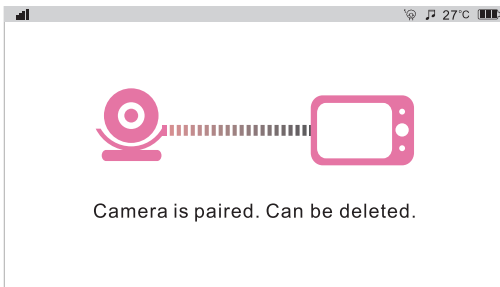

4. When the monitor prompts "Deleting is OK", it indicates that camera has been deleted successfully.

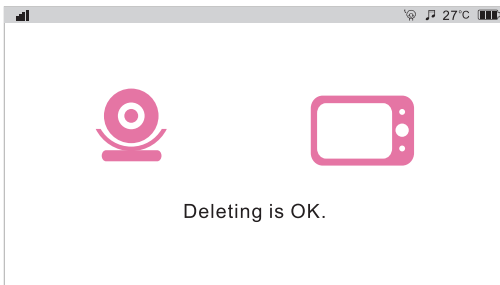

5. The monitor will return to monitoring screen and show no camera added. Green indicator LED of the camera will turn to flash.



Setting of sound alarm

Set alarming range of sound sensitivity. The function will identify loudness of baby's cry, when it exceeds set range, the monitor will send off alarm sound.

1. Select the "🔊" icon, then press the "OK" button of the monitor.
2. Select "Low", "Default", "High" icon as demanded, press the "OK" button of the monitor to complete setting of sound alarm. Press MENU button on the monitor for 2 times, it will return to real-time screen. (if OFF is selected, when "OK" button of the monitor is pressed, the monitor will not push sound alarm any more)

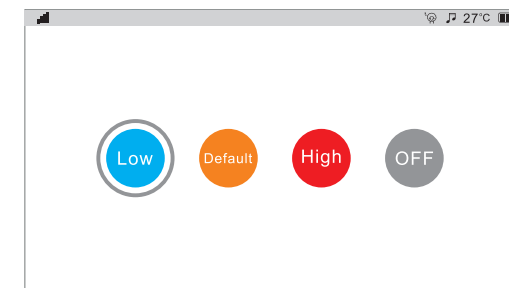

Note: The alarm sound will last for 1 minute. Notice for sound alarm can be closed by pressing any button on the monitor, and it will not receive the notice within 3 minutes after closing.



Setting of temperature alarm

When baby's room is too hot or too cold, temperature alarm will push notice to your monitor.

1. Select the "🌡️" icon, then press the "OK" button of the monitor.

Celsius degree setting

Set as Celsius degree: select °C icon, press the "OK" button of the monitor.

Temperature switch: Select ON press the OK button of the monitor, indicating temperature alarm function enabled.

After setting is OK, press the  button of the monitor for 2 times, it returns to real-time screen.

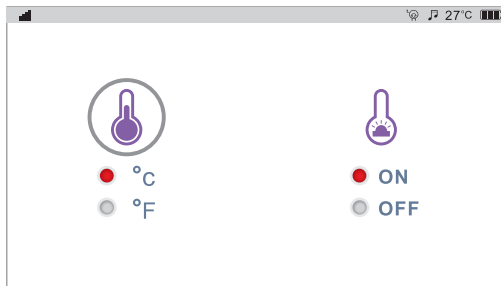

Fahrenheit degree

Set as Celsius degree" select °F icon, press the OK button of the monitor.

Temperature switch: Select ON, press the OK button of the monitor, indicating that temperature alarm function enabled successfully.

After setting is OK, press the  button of the monitor for 2 times to return to real-time screen.

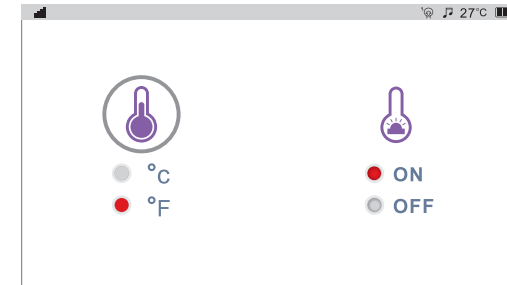

Note: Default normal temperature is 15 - 30°C (59°F - 86°F). When the temperature of baby's room is beyond the range, the monitor will receive the sound of temperature alarm. The sound will last for 1 minute. Notice for temperature alarm can be closed by pressing any button of the monitor, and it will not receive the notice again within 3 minutes after closing.



Cradlesong

The baby monitor has five cradlesongs to help you with coaxing the baby to sleep.

1. Select the "🎵" icon, then press the "OK" button of the monitor to jump to setup page.

2. Select the music you want to play, press the OK button of the monitor and the camera will play the cradlesong selected by you. After setting is OK, pressing the OK button of the monitor again, the cradlesong pauses. When selecting "ALL", all cradlesongs will be played in

loop. After setting is OK, press  button of the monitor and it will return to real-time screen.

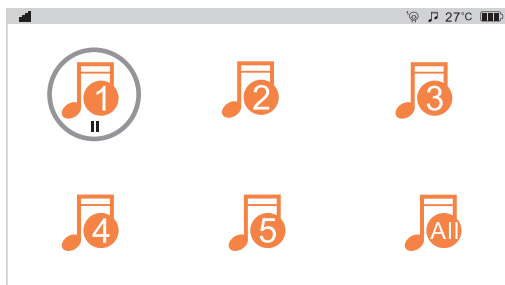

Note: There will be a "II" icon below the option of current song. If the cradlesong pauses, the icon will become "▶".

Sleep mode



You can set your monitor as automatic sleep mode. The setup will automatically jump to sleep mode according to the time set by you.

1. Select "🧠" icon and press the "OK" button of the monitor, it will jump to setup page.
2. Select the time of sleep as demanded. Press OK button of the monitor. Now, the monitor will automatically jump to sleep mode. After setting is OK, press  button of the monitor two times to return to real-time screen.



Note: There are 3 options including 5 minutes, 30 minutes and 60 minutes for sleep time. You can make a choice according to your own demand. By selecting OFF and pressing "OK" button of the monitor, sleep mode will be closed.



Setup

The setup includes time setting, factory reset and viewing of hardware version.

1. Time setting

Calibrate the time of monitor

1. Select "⚙️" icon and press the "OK" button of the monitor, to jump to setup page.
2. Select "🕒" icon and press the OK button of the monitor to jump to setup page.

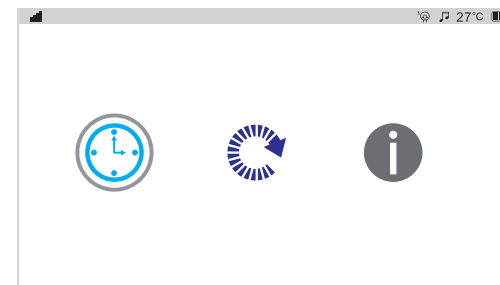

3. You can press the ◀ ▶ button of the monitor to select the item to be adjusted; press the ▲ ▼ button of the monitor to edit the selected item. After setting is OK, press  button of the monitor 3 times, then it will return to real-time screen.



2.Factory reset

Format all setting of the monitor and delete camera.

1.Select "⚙️" icon and press the "OK" button of the monitor, it will jump to setup page.

2. Select "🔄" icon and press the OK button of the monitor, it will jump to setup page.

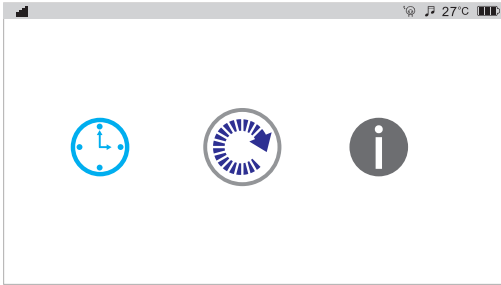

Now, the equipment will prompt you of "Restore to default settings?" Select "YES", press the "OK" button of the monitor. The equipment begins to implement factory reset.

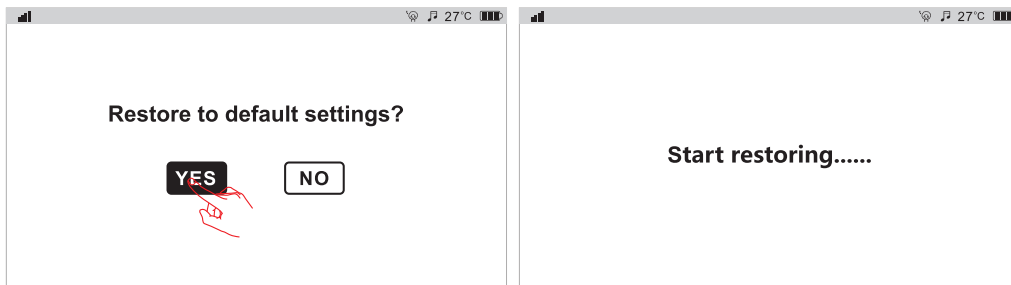

4. After factory reset is OK, the monitor will automatically jump to monitoring screen and show the prompt icon of no camera added. Meanwhile, the green indicator LED of camera will flash.

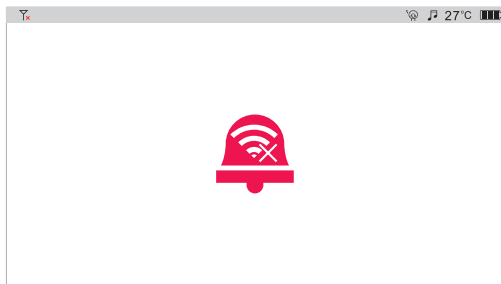



3.Information on version

Check receiver version information

1, Select "⚙️" icon, press "OK" button of the monitor to jump to setup page.

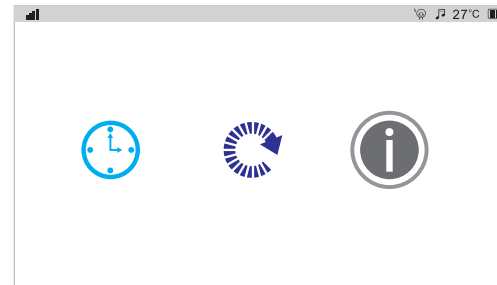
2. Select "i" icon and press the OK button of the monitor to jump to setup page.



3. Now, the receiver will show version related information. After viewing, press  button of the monitor 3 times to return to real-time screen °

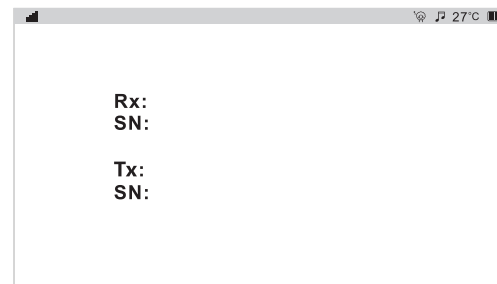

Specifications

Camera	Image sensor	1/4" CMOS
	Video resolution	1280 x 720P/25fps
	Rotation angle	Pan: 340° Tilt:90°
	Night visual range	5m
	Power supply	5V 1A
	Operation temperature	-10°C~50°C
	Storage temperature	-20°C~60°C
	Operation humidity	15~85%
	Dimensions(W*D*H)	84x84x105mm
	Weight	242g
Receiver	LCD	5"
	Number of pixels	720*3RGB(H)x1280(V)
	Wireless transmission Way	2.4GHz FHSS
	Power supply	DC 5V/2A
	Operation temperature	0°C~50°C
	Storage temperature	-20°C~60°C
	Operating humidity	0~75%RH
	Dimensions(W*D*H)	164x98x28 (mm)
Weight	262g	

All the specifications are subject to minor change without prior notice.

CE and FCC Certification Information

NOTE: This equipment has been tested and found to comply with the limits for a Class B digital device, pursuant to part 15 of the FCC Rules. These limits are designed to provide reasonable protection against harmful interference in a residential installation.

This equipment generates uses and can radiate radio frequency energy and, if not installed and used in accordance with the instructions, may cause harmful interference to radio communications. However, there is no guarantee that interference will not occur in a particular installation. If this equipment does cause harmful interference to radio or television reception, which can be determined by turning the equipment off and on, the user is encouraged to try to correct the interference by one or more of the following measures:

- Reorient or relocate the receiving antenna.
- Increase the separation between the equipment and receiver.
- Connect the equipment into an outlet on a circuit different from that to which the receiver is connected.
- Consult the dealer or an experienced radio/TV technician for help

Changes or modifications not expressly approved by the party responsible for compliance could void the user's authority to operate the equipment. This device complies with Part 15 of the FCC Rules. Operation is subject to the following two conditions:

- (1) This device may not cause harmful interference
- (2) This device must accept any interference received, including interference that may cause undesired operation.

Hereby, we declares that this device is in compliance with the essential requirements and other relevant provisions of Directive 2014/53/EU.

Notice: Observe the national local regulations in the location where the device is to be used. This device may be restricted for use in some or all member states of the European Union (EU)

EU Environmental Provisions

E-waste cannot be mixed with household garbage; corresponding local government sector or recycling stations shall be responsible for circular process.



RF Exposure Information:

FCC RF Exposure requirements: The highest SAR value reported under this standard during product certification for use next to the body with the minimum separation distance of 0mm is 1.545W/Kg. This transmitter must not be collocated or operating in conjunction with any other antenna or transmitter.

This product is compliance to FCC RF Exposure requirements and refers to FCC website <https://apps.fcc.gov/oetcf/eas/reports/GenericSearch.cfm> search for FCC ID: TW5GD7603