

折叠示意图

正面

 深圳市高斯贝尔家居智能电子有限公司			<b>技术要求</b>			
绘图：	陈栋 2017-09-13	零件名称：	英文说明书	物料编号：	折叠后成品尺寸：80x110mm 材质：105g铜版纸 颜色：双面四色印刷 工艺：风琴折，封面在外 其他：18P	
审核：		机种名称：	T5886HCB	比例：		电子档1:1
批准：		客户名称：		版本：		1.0
<b>变更履历</b>	新版本	变更时间	变更前		变更后	
	说明：					

# HD WiFi Camera

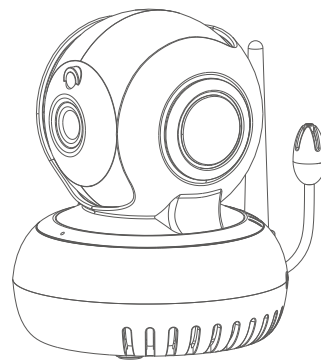

## Quick Start Guide

Model: T5886HCB

Before using the product, please read the guide carefully to avoid any damages to the product in virtue of faulty operation or misuse.

## 1 Appearance

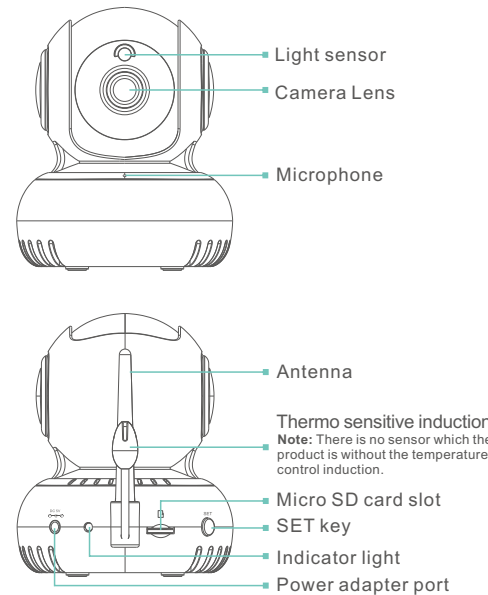

-1-

## 2 Installation

### Preparation prior to Installation

- 2.4G wireless router is required.
- support Android 4.4 and above, iOS 8.0 and above
- Download and install the APP:
  - Open the App Store , search "GOSCOM" and install.
  - Open the Google Play Store , search "GOSCOM" and install.
- Here is an operation example of Android APP, and it can serve as a reference for the IOS APP.
- power-on Camera and there will be prompt sound indicating power on succeed



-2-

### Register/Login

- Tap the "GOSCOM" APP icon to open it (figure 1);
- Use email address for user ID registration (figure 2-3);
- After registration, enter the email address and then password to log in (figure 2)

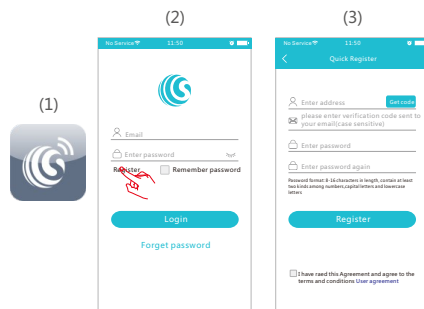

**TIP: For user ID registration, please use an effective email address, (example XXXX@qq.com), in order to retrieve the password.**

-3-

### Scan QR Code to Add

- Click "Add Camera" (figure 4) → Click "scan the QR code to add" (figure 5)

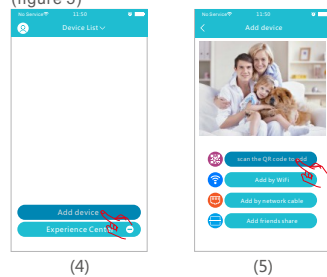

- Configure WIFI, enter WIFI name and password, and Click "Confirm" after that. (figure 6)P.S:Device does not support 5G Wi-Fi network; if this is not your desired network, tap to toggle. (figure 7)

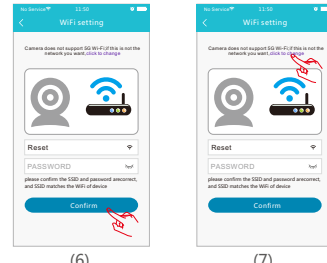

-4-

- Press the "SET" key for 1 second, and then you will hear a "Beep" sound(figure 8)

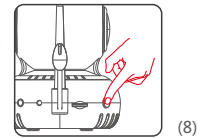

- Click the QR code icon (Figure 9) , switch to the QR code scanning mode, and scan the ID QR code
  - QR Code on the camera sticker (Figure 10) ;
  - Or choose the QR code picture from the album for ID scanning (Figure 11)

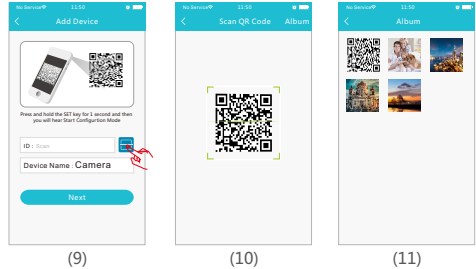

- When the APP Switch to the precaution page before scanning, please read the prompts carefully and click "Next step" (Figure 12) When the mobile phone shows a QR code interface, please align the QR code to the camera, with a distance of about 10 ~ 20cm (Figure 13); if scanning succeeds, you will hear "Beep"twice.

-5-

- After scan the QR Code, and when you hear "Beep" twice Click "I Have Heard It" (Figure 14), and now the camera is connecting to the router WiFi. When you see that the indicator on the device turns from blinking green to be steady on, it indicates that the device is connected and will automatically skip to the device list. (Figure 15)

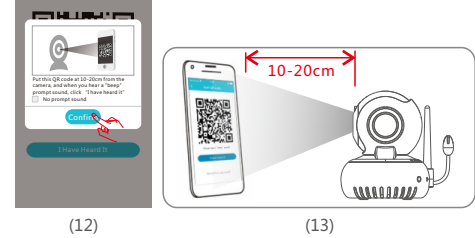

- Click the device to enter the real-time monitoring interface.(Figure 16)

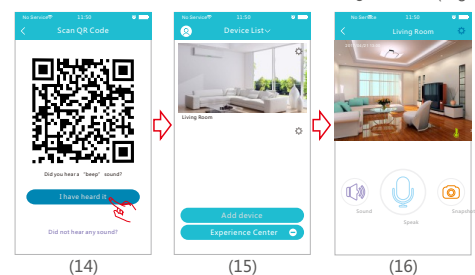

-6-

### Add by WIFI

- Click "Add Camera"(Figure 17) → Click "Add by WIFI" (Figure 18)→ Configure WIFI, enter WIFI name and password, and click "Confirm" after that.(Figure 19)P.S:Device does not support 5G Wi-Fi network; if this is not your desired network, Click to toggle

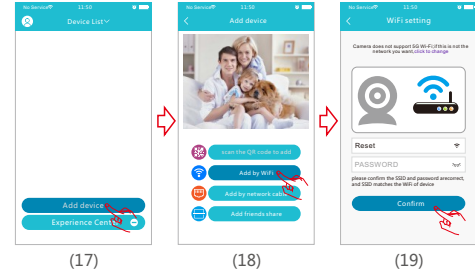

- Press and hold the "SET" key for 1 second, and then you will hear a "Beep" sound(Figure 20)

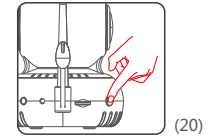

- Click the QR code icon (Figure 21) , switch to the QR code scanning mode, and scan the ID QR code
  - QR Code on the camera sticker (Figure 22) ;
  - Or choose the QR code picture from the album for ID scanning (Figure 23)

-7-

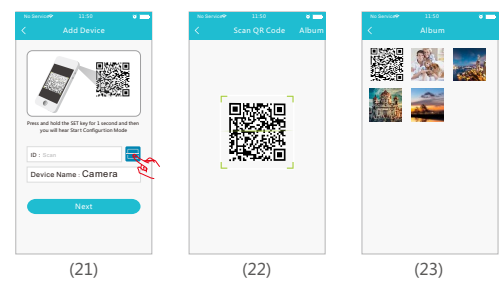

- After you click "Confirm", when you will hear "Beep"twice, indicates that the camera is connecting to the router.(Figure 24) When you see that the indicator on the device turns from blinking green to be steady on, it indicates that the device is connected and will automatically skip to the device list. (Figure 25) Click the device to enter the real-time monitoring interface. (Figure 26)

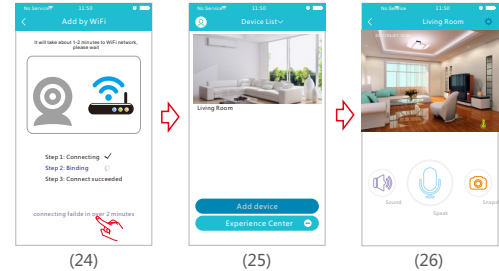

-8-

## 3 View Monitoring and Operate

After the device is connected, you can view real-time monitoring, and take a picture, record a video, speak, set up and make other operations on your mobile phone.

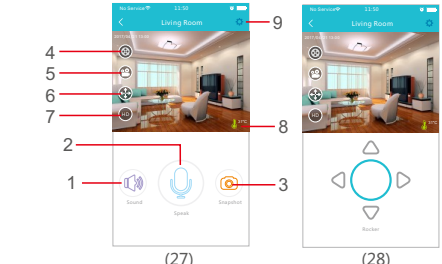

- Voice button: Click to close/disclose the voice
- Talkback button: press and hold this button to talk with the camera.
- Capture button: click to fast capture (save in the settings directory Album Book option).
- Playback button: Click to enter the playback page, you can view the camera SD card video file.
- Record button: Click to start recording, click the button again (stored in the set the directory of the album option).
- PTZ button: Click this button, APP pop-up PTZ control interface for Head level \ vertical angle to adjust (Figure 28).
- Sharpness button: Click to adjust the Resolution pixel for real-time video monitoring (HD/SD)
- Thermometer: Real-time temperature detection
- Set button: Click this button to set the camera-related functions.

-9-

## 4 Features

### Software Upgrade

- Click "Settings" icon(Figure 29) → Click "Device Information" (Figure 30)→ Click "System Firmware" (Figure 31)→ Click "Update Now" (Figure 32)(It can only be upgraded if there is a small red spot on the top right corner of the application firmware)

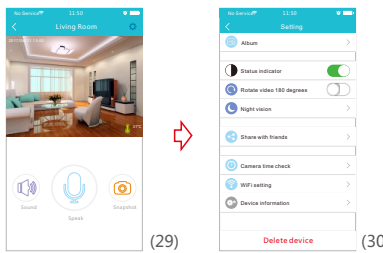

-10-

### Device Unbinding

- Click "Settings" icon(Figure 33) → Click "Delete Device"(Figure 34) APP will automatically switch to camera list, delete the camera you want to Unbundled it from the APP.

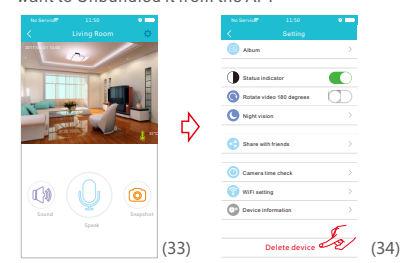

-11-

### Add Friends to Share

- Generate a QR code for sharing(can share this QR code to multi-users)
- Click "setting" icon(Figure 35) → Click "share with friends" (Figure 36)→ you can have the QR code(Figure 37)

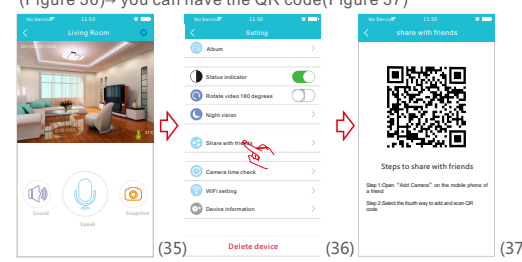

If other users want to add the camera, Click "Add Camera" → select "Add Friends to Share" mode(Figure 38)→ Click the QR code icon (Figure 39) , switch to the QR code scanning mode→ scan the QR code shared by friends→ Enter the Device List(Figure 40)

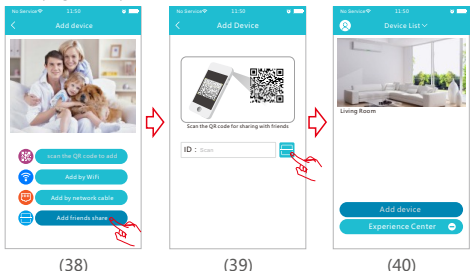

-12-

## 6 Product Specifications

Image sensor	CMOS
Camera resolution	1080P:1920x1080
Camera rotation range	270°horizontal, 120°vertical
Night vision range	< 5m
Audio sensitivity	< -47dB
Operation voltage	DC+5V/1A
Operation temperature	-10°C ~ + 50°C
Operation humidity	15% ~ 85% RH
Size (LxWxH)	85 x88.5 x103.5mm
Net weight	224g

※ No additional notice will be made in case of any minor change. Our company reserves the right of final interpretation.

-13-

## 7 Function Features

- 24/7 live video streaming
- HD provides excellent video quality
- Smart motion detection and notification
- Advanced video recording on micro-SD card (Maximally support the cyclic recording of 64GB micro SD card.)
- Motorized Pan/Tilt
- Night vision (5m visibility)
- Two-way voice transmit
- Quick & easy to set up

## 8 Packing List

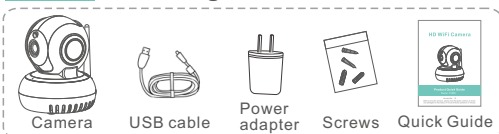

※ The picture is only for reference and the real object shall prevail

-14-

## 9 Tips

- Suggest using qualified micro-SD card to avoid incompatibility. Format micro-SD card before using.
- Movement detection: when movement is detected within the scope of camera, the camera will record video and take photos automatically. Videos and photos will be saved by micro-SD card.
- Share your camera to friends: Share QR code of the device with your friends.
- The main account to delete the camera, this time friends to share Will be deleted together. (You have to re-add the camera to use it again)
- Push message: when movement is detected, alarm message can be sent to server and pushed to your phone.
- Remote monitoring: after the camera is connected to Internet successfully, app can view the monitor via Internet, anytime, anywhere.
- Temperature alarm: In case that the temperature detected by the device is higher than the set value, audible alarm will be activated on cell phone (once every 2 minutes)
- Only support the special characters in English mode, such as: " @, #, &, ~, {, }, -, =, +, /, ?, (, ) ". Dont support the special characters, such as: "%", "\", "<>".
- When this machine has a crash fault or other abnormal conditions influencing the usage, it is recommended to cut out the power and restart, or press SET key for 10 seconds, which can restore factory settings, and then please reconnect the router.

-15-

## 10 Troubleshooting

- Wi-Fi cannot be connected
  - Ensure that the antenna of camera is fixed well.
  - Ensure that camera is in range of router. Keep the distance less than 40fts between router and indoor camera, less than 65fts for outdoor camera.
  - Ensure that SSID and password of Wi-Fi contains no special characters. Modify the SSID and password of Wi-Fi with only English characters, no special characters.
  - Ensure that SSID and password are no longer than 16 characters
  - Ensure that SSID is broadcasted.
  - Ensure that the DHCP is enabled on router.
  - Ensure that Wi-Fi encryption method is WPA2-PSK/ WPA-PSK or AES.
  - Ensure that Wi-Fi signal is 2.4GHz.
  - Ensure that there is no MAC filter on router or add MAC address to router whitelst
  - We suggest rebooting the router, and the "security settings, encryption method" of WiFi password should never choose "auto-select"
  - Reset the camera to set up connection again. Press and hold SET key for 5 seconds.
- Red indicator remains, network connection is failed.
  - Ensure that the password of Wi-Fi is correct.
  - Ensure that the network connects to Internet freely.
  - Ensure that the camera is in range of Wi-Fi hotspot.
- Green indicator flashes, connection to server failed.
  - Ensure that Wi-Fi signal is strong enough and bandwidth is enough for connection. Move near to Wi-Fi hotspot or increase the bandwidth.
  - Ensure that camera is not under interferon of other 2.4GHz signal.

## 11 FCC/CE Certification Information

NOTE: This equipment has been tested and found to comply with the limits for a Class B digital device, pursuant to part 15 of the FCC Rules. These limits are designed to provide reasonable protection against harmful interference in a residential installation.

-16-

This equipment generates uses and can radiate radio frequency energy and, if not installed and used in accordance with the instructions, may cause harmful interference to radio communications. However, there is no guarantee that interference will not occur in a particular installation. If this equipment does cause harmful interference to radio or television reception, which can be determined by turning the equipment off and on, the user is encouraged to try to correct the interference by one or more of the following measures:

- Reorient or relocate the receiving antenna.
  - Increase the separation between the equipment and receiver.
  - Connect the equipment into an outlet on a circuit different from that to which the receiver is connected.
  - Consult the dealer or an experienced radio/TV technician for help
- Changes or modifications not expressly approved by the party responsible for compliance could void the user's authority to operate the equipment. This device complies with Part 15 of the FCC Rules. Operation is subject to the following two conditions:
- (1) this device may not cause harmful interference, and
  - (2) this device must accept any interference received, including interference that may cause undesired operation.
- The Maximum Permissible Exposure (MPE) level has been calculated based on a distance of d=20 cm between the device and the human body. To maintain compliance with RF exposure requirement, use product that maintain a 20cm distance between the device and human body. Hereby, we declares that this device is in compliance with the essential requirements and other relevant provisions of Directive 2014/53/EU.
- Notice: Observe the national local regulations in the location where the device is to be used. This device may be restricted for use in some or all member states of the European Union (EU).
- The operated frequency is 2.4G~2.4835G with B/G/N20/N40.  
The Max output power on 802.11b is 16.98dBm.  
The Max output power on 802.11g is 14.98dBm.  
The Max output power on 802.11n-20 is 15.12dBm.  
The Max output power on 802.11n-40 is 14.67dBm.

EU Environmental Provisions  
E-waste cannot be mixed with household garbage; corresponding local government sector or recycling stations shall be responsible for circular process.



-17-

## **SIMPLIFIED EU DECLARATION OF CONFORMITY**

Hereby, [ShenZhen Gospell Smarhome Electronic Co., Ltd.] declares that the radio equipment type [T5886HCB] is in compliance with Directive 2014/53/EU. The full text of the EU declaration of conformity is available at the following internet address:([www.goscam.com](http://www.goscam.com))

*Richie Xiao*

**Richie Xiao**