

# Operation



## Reactor 2 E-30 and E-XP2

# Proportioning Systems

333023F  
EN

Electric, Heated, Plural Component Proportioner for spraying polyurethane foam and polyurea coatings. Not for outdoor use. For professional use only. Not approved for use in explosive atmospheres or hazardous locations.



### Important Safety Instructions

Read all warnings and instructions in this manual.  
Save these instructions.

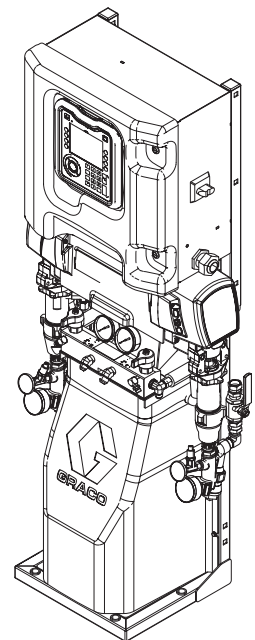





PROVEN QUALITY. LEADING TECHNOLOGY.











# Contents









Warnings .....	3	Recipes.....	34
Important Isocyanate Information.....	7	Run Mode .....	35
Models.....	9	Startup.....	41
Approvals.....	11	Fluid Circulation.....	44
Accessories.....	11	Circulation Through Reactor .....	44
Supplied Manuals .....	12	Circulation Through Gun Manifold .....	45
Related Manuals .....	12	Jog Mode.....	45
Typical Installation, without circulation.....	13	Spraying .....	46
Typical Installation, with system fluid manifold to drum circulation.....	14	Spray Adjustments.....	47
Typical Installation, with gun fluid manifold to drum circulation.....	15	Manual Hose Heat Mode.....	48
Component Identification.....	16	Shutdown.....	50
Advanced Display Module (ADM).....	18	Pressure Relief Procedure .....	52
Electrical Enclosure.....	23	Flushing.....	53
Motor Control Module (MCM).....	24	Maintenance .....	54
Temperature Control Module (TCM) Cable Connections .....	25	Preventative Maintenance Schedule .....	54
Installation.....	26	Proportioner Maintenance .....	54
Setup.....	27	Flush Inlet Strainer Screen .....	55
Grounding .....	27	Pump Lubrication System.....	56
Close gun fluid manifold valves A and B .....	27	Errors .....	57
General Equipment Guidelines .....	27	View Errors.....	57
Connect Power .....	28	Troubleshoot Errors .....	57
Supply Wet Cups With Throat Seal Liquid (TSL) .....	29	Troubleshooting.....	58
Install Fluid Temperature Sensor .....	29	Error Codes and Troubleshooting.....	58
Register and Activate the Graco InSite .....	29	USB Data.....	59
Advanced Display Module (ADM)		Download Procedure.....	59
Operation.....	30	USB Logs.....	59
Advanced Setup Screens .....	33	System Configuration Settings .....	60
System 1 .....	34	Custom Language File .....	61
System 2 .....	34	Upload Procedure.....	61
		Performance Charts.....	62
		Technical Specifications.....	65
		Graco Extended Warranty for Reactor® 2 Components .....	67

# Warnings

The following warnings are for the setup, use, grounding, maintenance, and repair of this equipment. The exclamation point symbol alerts you to a general warning and the hazard symbols refer to procedure-specific risks. When these symbols appear in the body of this manual or on warning labels, refer back to these Warnings. Product-specific hazard symbols and warnings not covered in this section may appear throughout the body of this manual where applicable.

 <b>WARNING</b>	
 	<p><b>ELECTRIC SHOCK HAZARD</b></p> <p>This equipment must be grounded. Improper grounding, setup, or usage of the system can cause electric shock.</p> <ul style="list-style-type: none"> <li>• Turn off and disconnect power at main switch before disconnecting any cables and before servicing or installing equipment.</li> <li>• Connect only to grounded power source.</li> <li>• All electrical wiring must be done by a qualified electrician and comply with all local codes and regulations.</li> <li>• Do not expose to rain. Store indoors.</li> </ul>
	<p><b>TOXIC FLUID OR FUMES</b></p> <p>Toxic fluids or fumes can cause serious injury or death if splashed in the eyes or on skin, inhaled, or swallowed.</p> <ul style="list-style-type: none"> <li>• Read MSDSs to know the specific hazards of the fluids you are using.</li> <li>• Store hazardous fluid in approved containers, and dispose of it according to applicable guidelines.</li> <li>• Always wear chemically impermeable gloves when spraying, dispensing, or cleaning equipment.</li> </ul>
	<p><b>PERSONAL PROTECTIVE EQUIPMENT</b></p> <p>Wear appropriate protective equipment when in the work area to help prevent serious injury, including eye injury, hearing loss, inhalation of toxic fumes, and burns. This protective equipment includes but is not limited to:</p> <ul style="list-style-type: none"> <li>• Protective eyewear, and hearing protection.</li> <li>• Respirators, protective clothing, and gloves as recommended by the fluid and solvent manufacturer.</li> </ul>

 <h1 style="margin: 0;">WARNING</h1>	
  	<p><b>SKIN INJECTION HAZARD</b></p> <p>High-pressure fluid from gun, hose leaks, or ruptured components will pierce skin. This may look like just a cut, but it is a serious injury that can result in amputation. <b>Get immediate surgical treatment.</b></p> <ul style="list-style-type: none"> <li>• Do not spray without tip guard and trigger guard installed.</li> <li>• Engage trigger lock when not spraying.</li> <li>• Do not point gun at anyone or at any part of the body.</li> <li>• Do not put your hand over the spray tip.</li> <li>• Do not stop or deflect leaks with your hand, body, glove, or rag.</li> <li>• Follow the <b>Pressure Relief Procedure</b> when you stop spraying and before cleaning, checking, or servicing equipment.</li> <li>• Tighten all fluid connections before operating the equipment.</li> <li>• Check hoses and couplings daily. Replace worn or damaged parts immediately.</li> </ul>
   	<p><b>FIRE AND EXPLOSION HAZARD</b></p> <p>Flammable fumes, such as solvent and paint fumes, in <b>work area</b> can ignite or explode. To help prevent fire and explosion:</p> <ul style="list-style-type: none"> <li>• Use equipment only in well ventilated area.</li> <li>• Eliminate all ignition sources; such as pilot lights, cigarettes, portable electric lamps, and plastic drop cloths (potential static arc).</li> <li>• Keep work area free of debris, including solvent, rags and gasoline.</li> <li>• Do not plug or unplug power cords, or turn power or light switches on or off when flammable fumes are present.</li> <li>• Ground all equipment in the work area. See <b>Grounding</b> instructions.</li> <li>• Use only grounded hoses.</li> <li>• Hold gun firmly to side of grounded pail when triggering into pail. Do not use pail liners unless they are antistatic or conductive.</li> <li>• <b>Stop operation immediately</b> if static sparking occurs or you feel a shock. Do not use equipment until you identify and correct the problem.</li> <li>• Keep a working fire extinguisher in the work area.</li> </ul>
  	<p><b>THERMAL EXPANSION HAZARD</b></p> <p>Fluids subjected to heat in confined spaces, including hoses, can create a rapid rise in pressure due to the thermal expansion. Over-pressurization can result in equipment rupture and serious injury.</p> <ul style="list-style-type: none"> <li>• Open a valve to relieve the fluid expansion during heating.</li> <li>• Replace hoses proactively at regular intervals based on your operating conditions.</li> </ul>

 <h1 style="margin: 0;">WARNING</h1>	
	<p><b>PRESSURIZED ALUMINUM PARTS HAZARD</b></p> <p>Use of fluids that are incompatible with aluminum in pressurized equipment can cause serious chemical reaction and equipment rupture. Failure to follow this warning can result in death, serious injury, or property damage.</p> <ul style="list-style-type: none"> <li>• Do not use 1,1,1-trichloroethane, methylene chloride, other halogenated hydrocarbon solvents or fluids containing such solvents.</li> <li>• Many other fluids may contain chemicals that can react with aluminum. Contact your material supplier for compatibility.</li> </ul>
 	<p><b>PLASTIC PARTS CLEANING SOLVENT HAZARD</b></p> <p>Many solvents can degrade plastic parts and cause them to fail, which could cause serious injury or property damage.</p> <ul style="list-style-type: none"> <li>• Use only compatible water-based solvents to clean plastic structural or pressure-containing parts.</li> <li>• See <b>Technical Data</b> in this and all other equipment instruction manuals. Read fluid and solvent manufacturer's MSDSs and recommendations.</li> </ul>
 	<p><b>EQUIPMENT MISUSE HAZARD</b></p> <p>Misuse can cause death or serious injury.</p> <ul style="list-style-type: none"> <li>• Do not operate the unit when fatigued or under the influence of drugs or alcohol.</li> <li>• Do not exceed the maximum working pressure or temperature rating of the lowest rated system component. See <b>Technical Data</b> in all equipment manuals.</li> <li>• Use fluids and solvents that are compatible with equipment wetted parts. See <b>Technical Data</b> in all equipment manuals. Read fluid and solvent manufacturer's warnings. For complete information about your material, request MSDS from distributor or retailer.</li> <li>• Do not leave the work area while equipment is energized or under pressure.</li> <li>• Turn off all equipment and follow the <b>Pressure Relief Procedure</b> when equipment is not in use.</li> <li>• Check equipment daily. Repair or replace worn or damaged parts immediately with genuine manufacturer's replacement parts only.</li> <li>• Do not alter or modify equipment. Alterations or modifications may void agency approvals and create safety hazards.</li> <li>• Make sure all equipment is rated and approved for the environment in which you are using it.</li> <li>• Use equipment only for its intended purpose. Call your distributor for information.</li> <li>• Route hoses and cables away from traffic areas, sharp edges, moving parts, and hot surfaces.</li> <li>• Do not kink or over bend hoses or use hoses to pull equipment.</li> <li>• Keep children and animals away from work area.</li> <li>• Comply with all applicable safety regulations.</li> </ul>
 	<p><b>MOVING PARTS HAZARD</b></p> <p>Moving parts can pinch, cut or amputate fingers and other body parts.</p> <ul style="list-style-type: none"> <li>• Keep clear of moving parts.</li> <li>• Do not operate equipment with protective guards or covers removed.</li> <li>• Pressurized equipment can start without warning. Before checking, moving, or servicing equipment, follow the <b>Pressure Relief Procedure</b> and disconnect all power sources.</li> </ul>



# WARNING



## BURN HAZARD

Equipment surfaces and fluid that is heated can become very hot during operation. To avoid severe burns:

- Do not touch hot fluid or equipment.

# Important Isocyanate Information

Isocyanates (ISO) are catalysts used in two component materials.

## Isocyanate Conditions

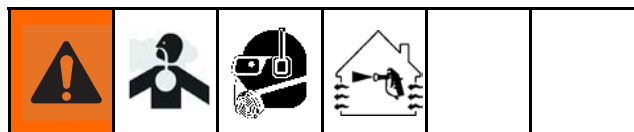

Spraying or dispensing materials containing isocyanates creates potentially harmful mists, vapors, and atomized particulates.

Read material manufacturer's warnings and material MSDS to know specific hazards and precautions related to isocyanates.

Prevent inhalation of isocyanate mists, vapors, and atomized particulates by providing sufficient ventilation in the work area. If sufficient ventilation is not available, a supplied-air respirator is required for everyone in the work area.

To prevent contact with isocyanates, appropriate personal protective equipment, including chemically impermeable gloves, boots, aprons, and goggles, is also required for everyone in the work area.

## Material Self-Ignition

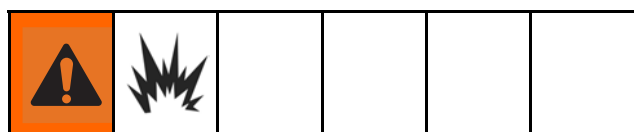

Some materials may become self-igniting if applied too thick. Read material manufacturer's warnings and material MSDS.

## Keep Components A and B Separate



Cross-contamination can result in cured material in fluid lines which could cause serious injury or damage equipment. To prevent cross-contamination:

- **Never** interchange component A and component B wetted parts.
- Never use solvent on one side if it has been contaminated from the other side.

## Moisture Sensitivity of Isocyanates

Exposure to moisture (such as humidity) will cause ISO to partially cure; forming small, hard, abrasive crystals, which become suspended in the fluid. Eventually a film will form on the surface and the ISO will begin to gel, increasing in viscosity

### NOTICE

Partially cured ISO will reduce performance and the life of all wetted parts.

- Always use a sealed container with a desiccant dryer in the vent, or a nitrogen atmosphere. **Never** store ISO in an open container.
- Keep the ISO pump wet cup or reservoir (if installed) filled with appropriate lubricant. The lubricant creates a barrier between the ISO and the atmosphere.
- Use only moisture-proof hoses compatible with ISO.
- Never use reclaimed solvents, which may contain moisture. Always keep solvent containers closed when not in use.
- Always lubricate threaded parts with an appropriate lubricant when reassembling.

## **Foam Resins with 245 fa Blowing Agents**

Some foam blowing agents will froth at temperatures above 90°F (33°C) when not under pressure, especially if agitated. To reduce frothing, minimize preheating in a circulation system.

## **Changing Materials**

### ***NOTICE***

Changing the material types used in your equipment requires special attention to avoid equipment damage and downtime.

- When changing materials, flush the equipment multiple times to ensure it is thoroughly clean.
- Always clean the fluid inlet strainers after flushing.
- Check with your material manufacturer for chemical compatibility.
- When changing between epoxies and urethanes or polyureas, disassemble and clean all fluid components and change hoses. Epoxies often have amines on the B (hardener) side. Polyureas often have amines on the B (resin) side.



# Models

## Reactor 2 E-30 and E-30 Elite

All elite systems include fluid inlet sensors, Graco InSite™, and Xtreme-Wrap 50 ft (15 m) heated hose. For part numbers, see [Accessories, page 11](#)

Model	E-30 Model						E-30 Elite Model					
	10 kW			15 kW			10 kW			15kW		
Proportioner ★	272010			272011			272110			272111		
Maximum Fluid Working Pressure psi (MPa, bar)	2000 (14, 140)			2000 (14, 140)			2000 (14, 140)			2000 (14, 140)		
Approximate Output per Cycle (A+B) gal. (liter)	0.0272 (0.1034)			0.0272 (0.1034)			0.0272 (0.1034)			0.0272 (0.1034)		
Max Flow Rate lb/min (kg/min)	30 (13.5)			30 (13.5)			30 (13.5)			30 (13.5)		
Total System Load † ◆(Watts)	17,900			23,000			17,900			23,000		
Configurable Voltage Phase◆	230 1Ø	230 3ØΔ	380 3ØY	230 1Ø	230 3ØΔ	380 3ØY	230 1Ø	230 3ØΔ	380 3ØY	230 1Ø	230 3ØΔ	380 3ØY
Full Load Peak Current*	78	50	34	100	62	35	78	50	34	100	62	35
Fusion AP Package ✖ (Gun Part No.)	AP2010 (246102)	AH2010 (246102)	AP2011 (246102)	AH2011 (246102)	AP2110 (246102)	AH2110 (246102)	AP2111 (246102)	AH2111 (246102)	AP2110 (246102)	AH2110 (246102)	AP2111 (246102)	AH2111 (246102)
Fusion CS Package ✖ (Gun Part No.)	CS2010 (CS02RD)	CH2010 (CS02RD)	CS2011 (CS02RD)	CH2011 (CS02RD)	CS2110 (CS02RD)	CH2110 (CS02RD)	CS2111 (CS02RD)	CH2111 (CS02RD)	CS2110 (CS02RD)	CH2110 (CS02RD)	CS2111 (CS02RD)	CH2111 (CS02RD)
Probler P2 Package ✖ (Gun Part No.)	P22010 (GCP2R2)	PH2010 (GCP2R2)	P22011 (GCP2R2)	PH2011 (GCP2R2)	P22110 (GCP2R2)	PH2110 (GCP2R2)	P22111 (GCP2R2)	PH2111 (GCP2R2)	P22110 (GCP2R2)	PH2110 (GCP2R2)	P22111 (GCP2R2)	PH2111 (GCP2R2)
Heated Hose 50 ft (15 m) 24K240 (scuff guard) 24Y240 (Xtreme-Wrap)	24K240 Qty: 1	24K240 Qty: 5	24K240 Qty: 1	24K240 Qty: 5	24Y240 Qty: 1	24Y240 Qty: 5	24Y240 Qty: 1	24Y240 Qty: 5	24Y240 Qty: 1	24Y240 Qty: 5	24Y240 Qty: 1	24Y240 Qty: 5
Heated Whip Hose 10 ft (3 m)	246050			246050			246050			246050		
Graco Insite™							✓			✓		
Fluid Inlet Sensors (2)							✓			✓		

\* Full load amps with all devices operating at maximum capabilities. Fuse requirements at various flow rates and mix chamber sizes may be less.

† Total system watts used by system, based on maximum heated hose length for each unit.

- E-30 and E-XP2 series: 310 ft (94.5 m) maximum heated hose length, including whip hose.

★ See [Approvals, page 11](#).

✖ Packages include gun, heated hose, and whip hose. Elite packages also include Graco InSite and fluid inlet sensors.

◆ Low line input voltage will reduce power available and heaters will not perform at full capacity.

Voltage Configurations Key	
Ø	Phase
Δ	DELTA
Y	WYE

## Reactor 2 E-XP2 and E-XP2 Elite

All elite systems include fluid inlet sensors, Graco InSite™, and Xtreme-Wrap 50 ft (15 m) heated hose. For part numbers, see [Accessories, page 11](#)

Model	E-XP2 Model			E-XP2 Elite Model		
	15 kW			15 kW		
Proportioner ★	272012			272112		
Maximum Fluid Working Pressure psi (MPa, bar)	3500 (24.1, 241)			3500 (24.1, 241)		
Approximate Output per Cycle (A+B) gal. (liter)	0.0203 (0.0771)			0.0203 (0.0771)		
Max Flow Rate gpm/min (l/min)	2 (7.6)			2 (7.6)		
Total System Load † ◆ (Watts)	23,000			23,000		
Configurable Voltage Phase ◆	230 1Ø	230 3ØΔ	230 3ØY	230 1Ø	230 3ØΔ	380 3ØY
Full Load Peak Current (amps)	100	62	35	100	62	35
Fusion AP Package ✖ (Gun Part No.)	AP2012 (246101)			AP2112 (246101)		
Probler P2 Package ✖ (Gun Part No.)	P22012 (GCP2R1)			P22112 (GCP2R1)		
Heated Hose 50 ft (15 m)	24K241 (scuff guard)			24Y241 (Xtreme-Wrap)		
Heated Whip Hose 10 ft (3 m)	246055			246055		
Graco InSite™				✓		
Fluid Inlet Sensors (2)				✓		

- \* Full load amps with all devices operating at maximum capabilities. Fuse requirements at various flow rates and mix chamber sizes may be less.
- † Total system watts used by system, based on maximum heated hose length for each unit.
  - E-30 and E-XP2 series: 310 ft (94.5 m) maximum heated hose length, including whip hose.
- ★ See [Approvals, page 11](#).

- ✖ Packages include gun, heated hose, and whip hose. Elite packages also include Graco InSite and fluid inlet sensors.
- ◆ Low line input voltage will reduce power available and heaters will not perform at full capacity.

Voltage Configurations Key	
Ø	Phase
Δ	DELTA
Y	WYE

## Approvals

Intertek approvals apply to proportioners without hoses.

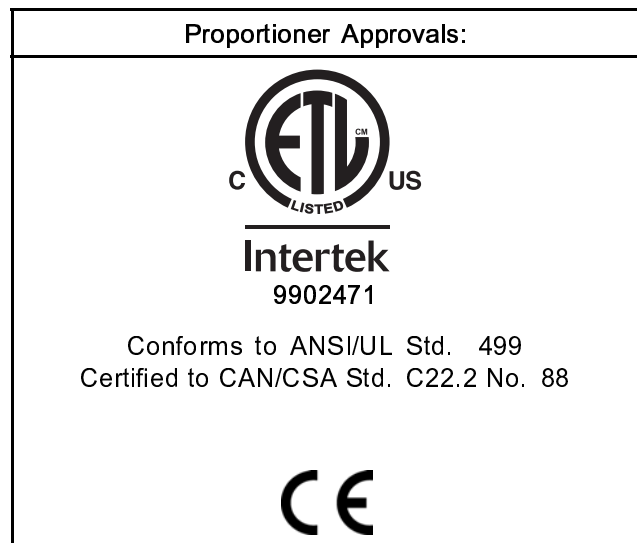

**Note**

Heated hoses provided with a system or sold individually are not approved by Intertek.

## Accessories

Kit Number	Description
24U315	Air Manifold Kit (4 outlets)
24U314	Wheel and Handle Kit
24T280	Graco InSite Kit
16X521	Graco InSite Extension cable 24.6 ft (7.5 m)
24N449	50 ft (15 m) CAN cable (for remote display module)
24K207	Fluid Temperature Sensor (FTS) with RTD
24U174	Remote Display Module Kit
15V551	ADM Protective Covers (10 pack)
15M483	Remote Display Module Protective Covers (10 pack)
24M174	Drum Level Sticks
121006	150 ft (45 m) CAN cable (for remote display module)
24N365	RTD Test Cables (to aide resistance measurements)

## Supplied Manuals

The following manuals are shipped with the Reactor 2. Refer to these manuals for detailed equipment information.

Manuals are also available at [www.graco.com](http://www.graco.com).

Manual	Description
333023	Reactor 2 E-30 and E-XP2 Operation
333091	Reactor 2 E-30 and E-XP2 Startup Quick Guide
333092	Reactor 2 E-30 and E-XP2 Shutdown Quick Guide

## Related Manuals

The following manuals are for accessories used with the Reactor.

### Component Manuals in English:

Manuals are available at [www.graco.com](http://www.graco.com).

System Manuals	
333024	Reactor 2 E-30 and E-XP2, Repair-Parts
Displacement Pump Manual	
309577	Electric Reactor Displacement Pump, Repair-Parts
Feed System Manuals	
309572	Heated Hose, Instructions-Parts
309852	Circulation and Return Tube Kit, Instructions-Parts
309815	Feed Pump Kits, Instructions-Parts
309827	Feed Pump Air Supply Kit, Instructions-Parts
Spray Gun Manuals	
309550	Fusion™ AP Gun
312666	Fusion™ CS Gun
313213	Probler® P2 Gun
Accessory Manuals	
3A1905	Feed Pump Shutdown Kit, Instructions-Parts
3A1906	Light Tower Kit, Instructions-Parts
3A1907	Remote Display Module Kit, Instructions-Parts
332735	Air Manifold Kit, Instructions-Parts
332736	Handle and Wheel Kit, Instructions-Parts
333276	Graco InSite™ Kit, Instructions-Parts

# Typical Installation, without circulation

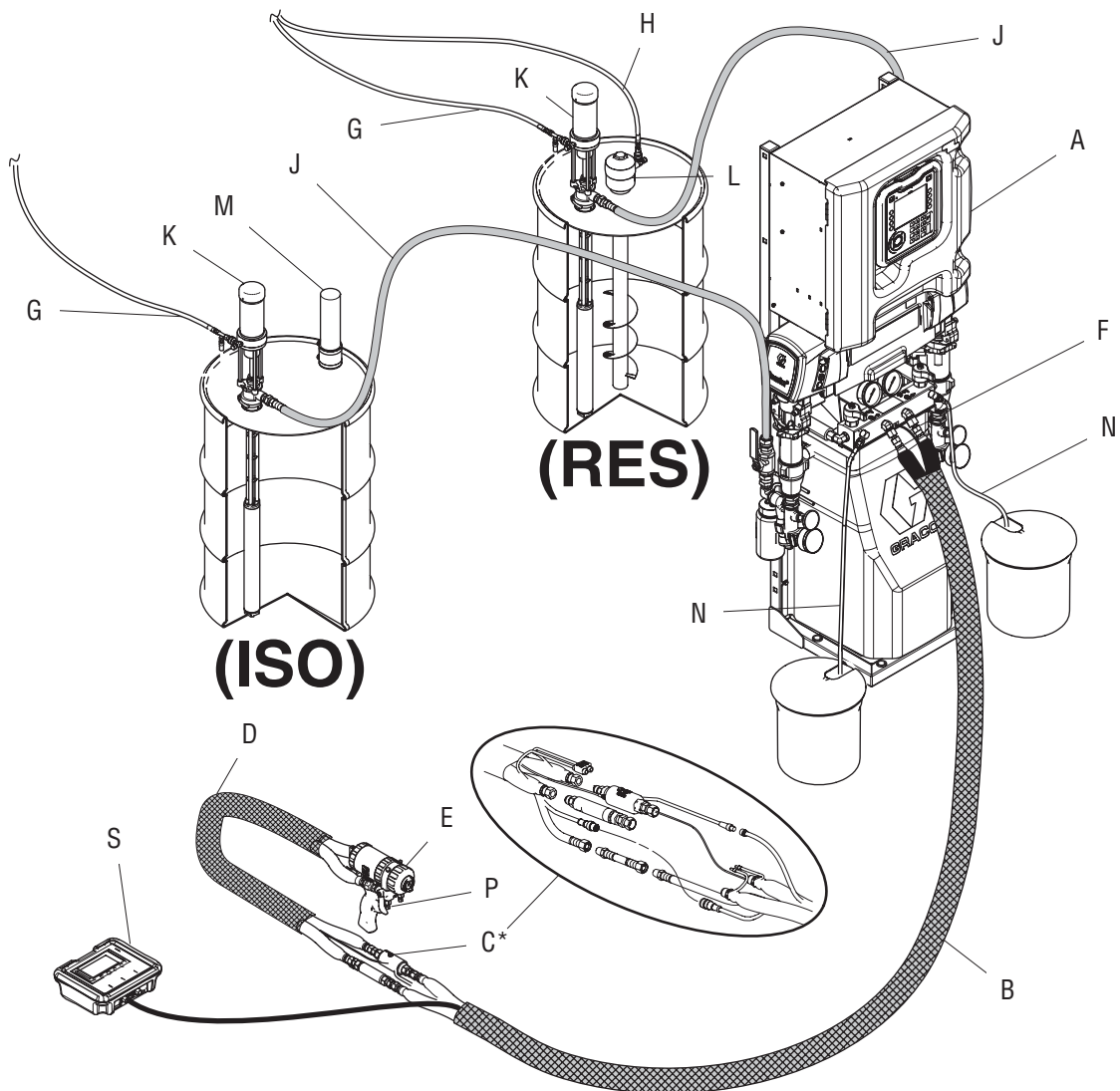

Figure 1

\* Shown exposed for clarity. Wrap with tape during operation.

- |   |                                |   |                                      |
|---|--------------------------------|---|--------------------------------------|
| A | Reactor Proportioner           | J | Fluid Supply Lines                   |
| B | Heated Hose                    | K | Feed Pumps                           |
| C | Fluid Temperature Sensor (FTS) | L | Agitator                             |
| D | Heated Whip Hose               | M | Desiccant Dryer                      |
| E | Fusion Spray Gun               | N | Bleed Lines                          |
| F | Gun Air Supply Hose            | P | Gun Fluid Manifold (part of gun)     |
| G | Feed Pump Air Supply Lines     | S | Remote Display Module Kit (optional) |
| H | Agitator Air Supply Line       |   |                                      |

# Typical Installation, with system fluid manifold to drum circulation

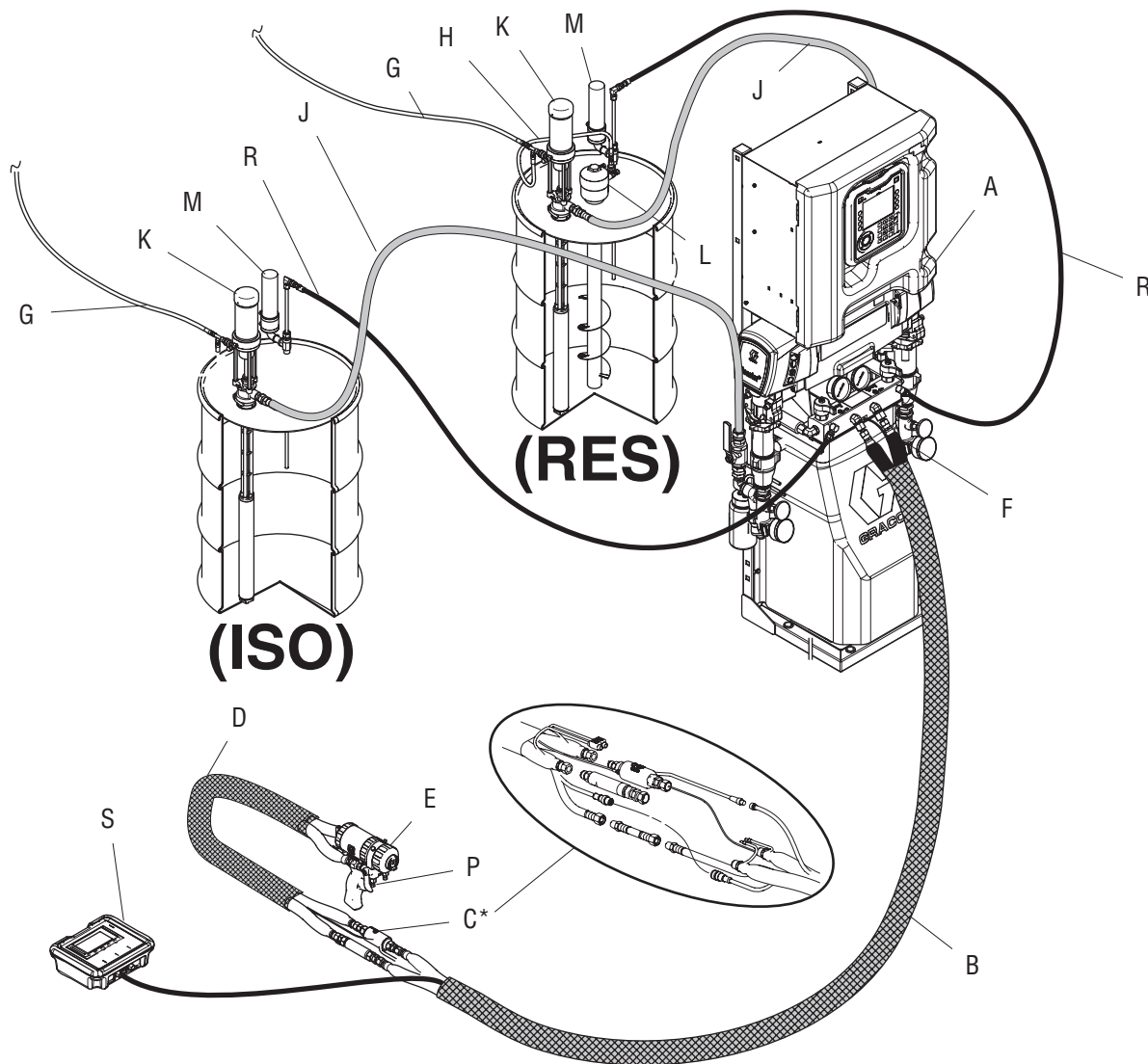

Figure 2

\* Shown exposed for clarity. Wrap with tape during operation.

- |   |                                |   |                                  |
|---|--------------------------------|---|----------------------------------|
| A | Reactor Proportioner           | J | Fluid Supply Lines               |
| B | Heated Hose                    | K | Feed Pumps                       |
| C | Fluid Temperature Sensor (FTS) | L | Agitator                         |
| D | Heated Whip Hose               | M | Desiccant Dryer                  |
| E | Fusion Spray Gun               | P | Gun Fluid Manifold (part of gun) |
| F | Gun Air Supply Hose            | R | Recirculation Lines              |
| G | Feed Pump Air Supply Lines     | S | Remote Display Module (optional) |
| H | Agitator Air Supply Line       |   |                                  |

# Typical Installation, with gun fluid manifold to drum circulation

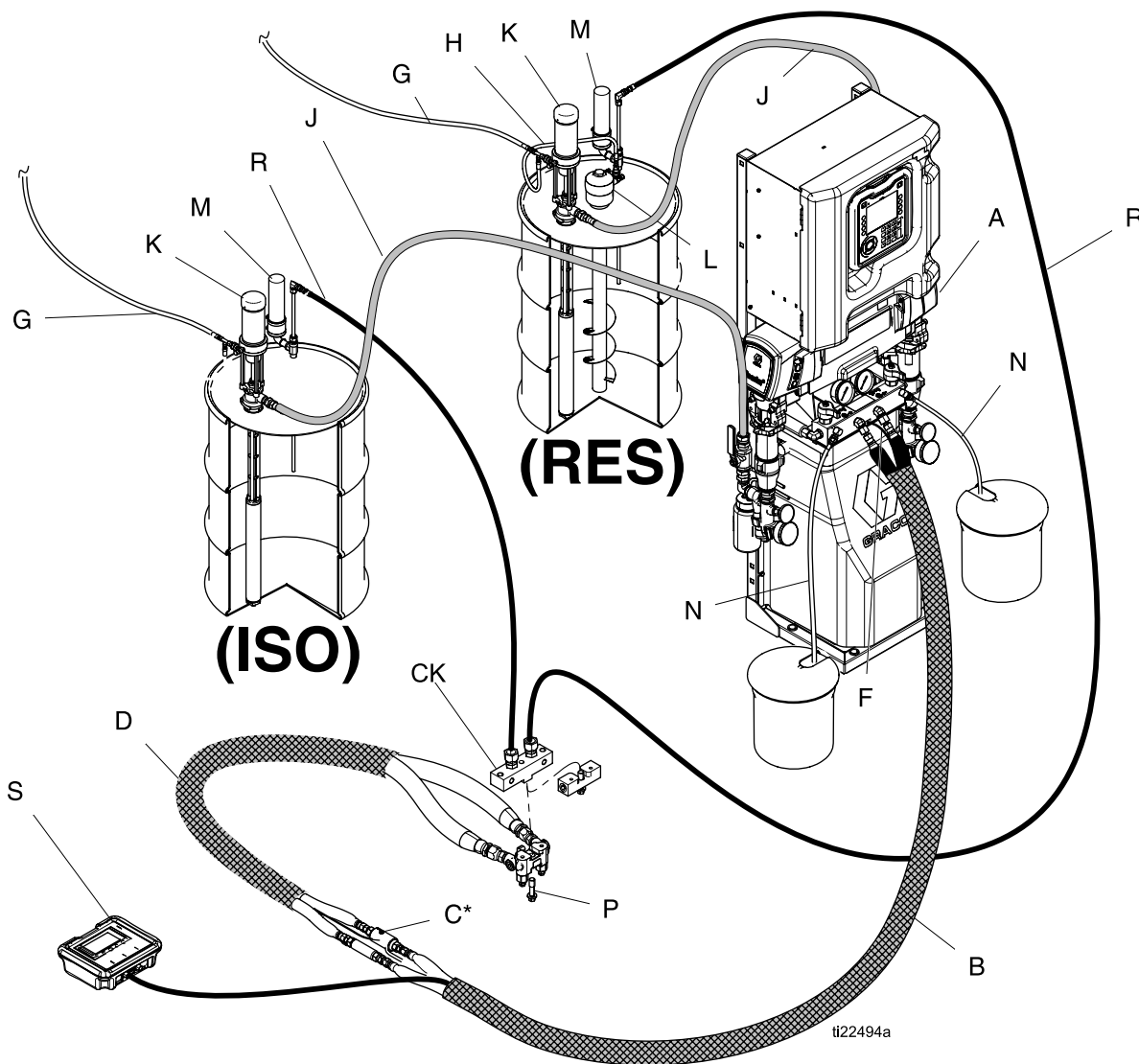
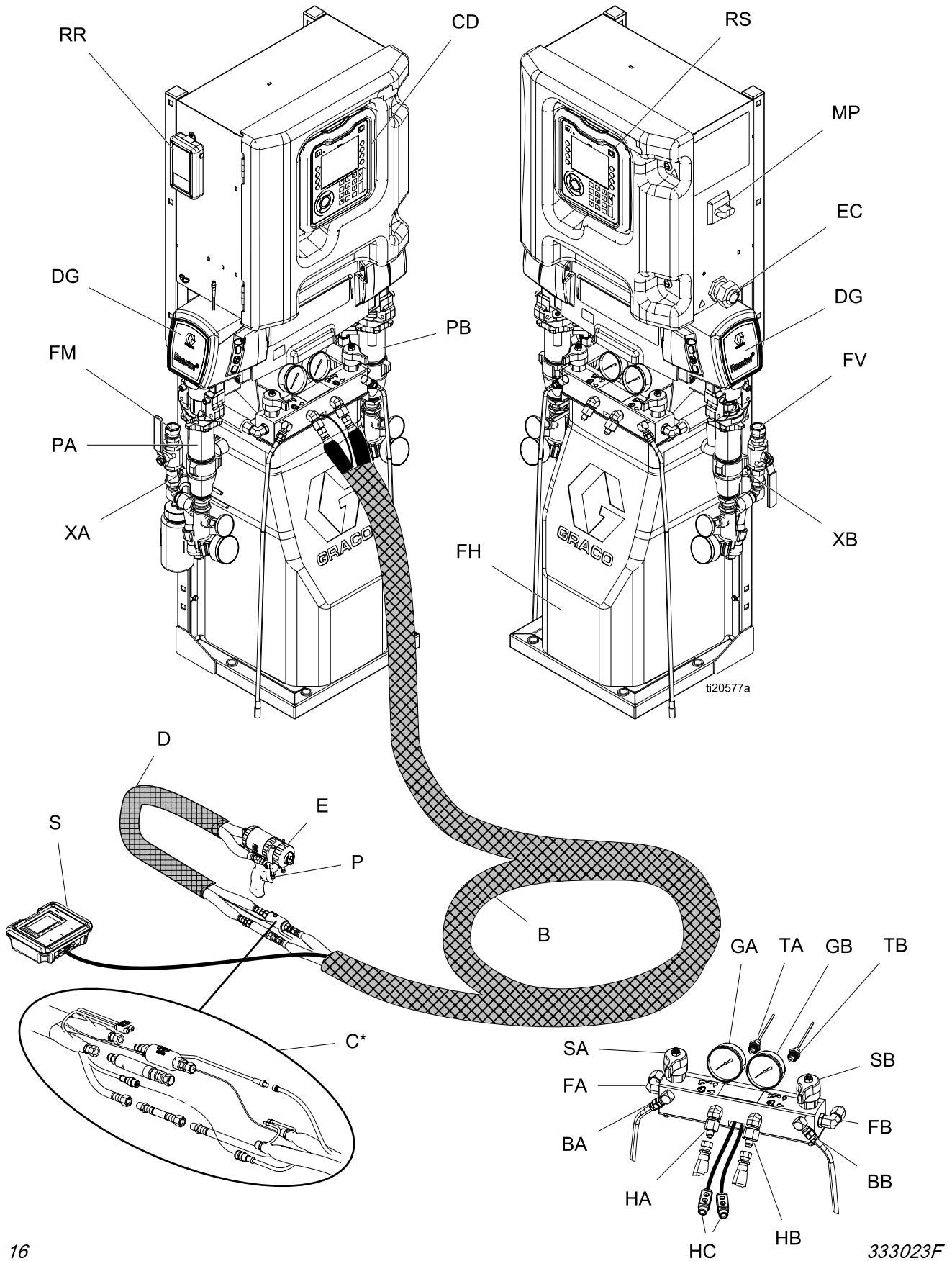

Figure 3

\* Shown exposed for clarity. Wrap with tape during operation.

- |    |                                |   |                                  |
|----|--------------------------------|---|----------------------------------|
| A  | Reactor Proportioner           | J | Fluid Supply Lines               |
| B  | Heated Hose                    | K | Feed Pumps                       |
| C  | Fluid Temperature Sensor (FTS) | L | Agitator                         |
| CK | Circulation Block (accessory)  | M | Desiccant Dryer                  |
| D  | Heated Whip Hose               | P | Gun Fluid Manifold (part of gun) |
| F  | Gun Air Supply Hose            | R | Recirculation Lines              |
| G  | Feed Pump Air Supply Lines     | S | Remote Display Module (optional) |
| H  | Agitator Air Supply Line       |   |                                  |

# Component Identification





Key

BA	ISO Side Pressure Relief Outlet	RR	Graco InSite Cellular Module (Elite models only)
BB	RES Side Pressure Relief Outlet	RS	Red Stop Button
CD	Advanced Display Module (ADM)	SA	ISO Side PRESSURE RELIEF/SPRAY Valve
DG	Drive Gear Housing	SB	RES Side PRESSURE RELIEF/SPRAY Valve
EC	Electrical Cord Strain Relief	TA	ISO Side Pressure Transducer (behind gauge GA)
EM	Electric Motor	TB	RES Side Pressure Transducer (behind gauge GB)
FA	ISO Side Fluid Manifold Inlet	XA	Fluid Inlet Sensor (ISO side, Elite models only)
FB	RES Side Fluid Manifold Inlet	XB	Fluid Inlet Sensor (RES side, Elite models only)
FH	Fluid Heaters (behind shroud)		
FM	Reactor Fluid Manifold		
FV	Fluid Inlet Valve (RES side shown)		
GA	ISO Side Pressure Gauge		
GB	RES Side Pressure Gauge		
HA	ISO Side Hose Connection		
HB	RES Side Hose Connection		
HC	Heated Hose Electrical Connectors		
MP	Main Power Switch		
PA	ISO Side Pump		
PB	RES Side Pump		

## Advanced Display Module (ADM)

The ADM display shows graphical and text information related to setup and spray operations.

### **NOTICE**







To prevent damage to the softkey buttons, do not press buttons with sharp objects such as pens, plastic cards, or fingernails.

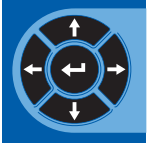

ti22631a

Figure 5 Front View

Table 1 : ADM Keys and Indicators

Key	Function
 <p>Startup/Shutdown Key and Indicator</p>	Press to startup or shutdown the system.
 <p>Stop</p>	Press to stop all proportioner processes. This is not a safety or emergency stop.
 <p>Soft Keys</p>	Press to select the specific screen or operation shown on the display directly next to each key.
 <p>Navigation Keys</p>	<ul style="list-style-type: none"> <li>• <i>Left/Right Arrows:</i> Use to move from screen to screen.</li> <li>• <i>Up/Down Arrows:</i> Use to move among fields on a screen, items on a dropdown menu, or multiple screens within a function.</li> </ul>
Numeric Keypad	Use to input values.
 <p>Cancel</p>	Use to cancel a data entry field.
 <p>Setup</p>	Press to enter or exit Setup mode.
 <p>Enter</p>	Press to choose a field to update, to make a selection, to save a selection or value, to enter a screen, or to acknowledge an event.

## Component Identification

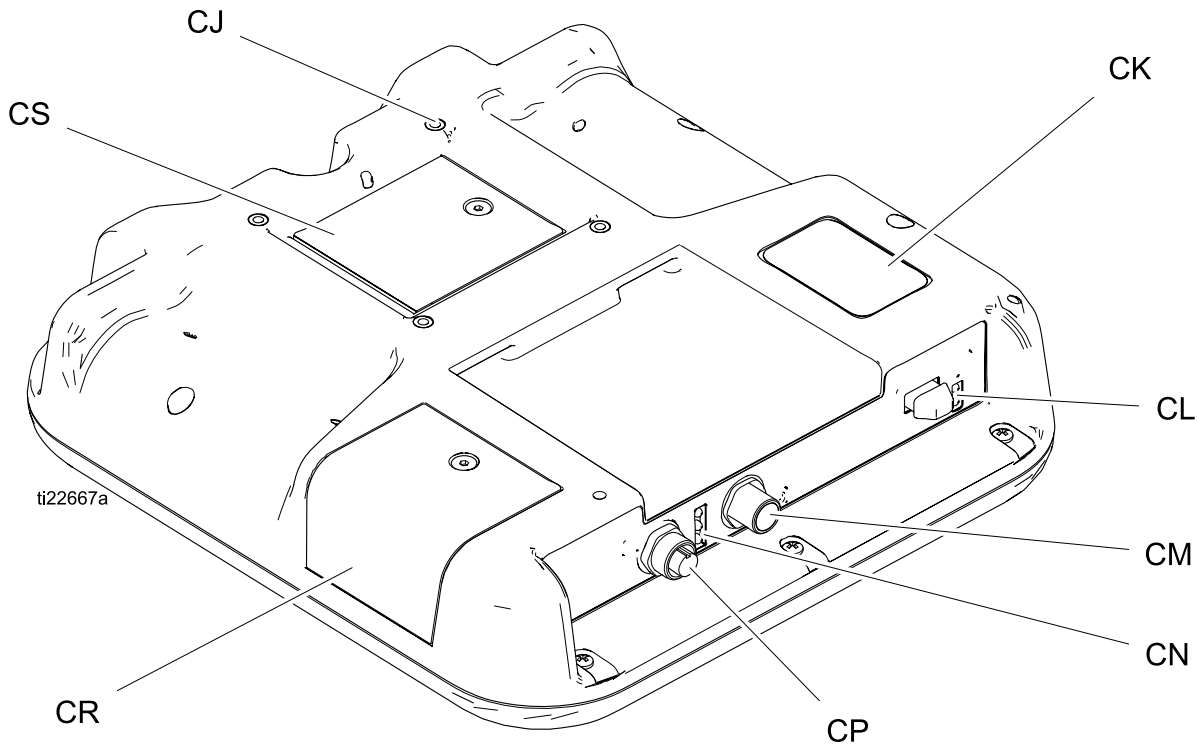



Figure 6 Back View

CJ	Flat Panel Mount (VESA 100)
CK	Model and Serial Number
CL	USB Port and Status LEDs
CM	CAN Cable Connection

CN	Module Status LEDs
CP	Accessory Cable Connection
CR	Token Access Cover
CS	Battery Access Cover

Table 2 ADM LED Status Descriptions

LED	Conditions	Description
<b>System Status</b> 	Green Solid	Run Mode, System On
	Green Flashing	Setup Mode, System On
	Yellow Solid	Run Mode, System Off
	Yellow Flashing	Setup Mode, System Off
<b>USB Status (CL)</b>	Green Flashing	Data recording in progress
	Yellow Solid	Downloading information to USB
	Green and Yellow Flashing	ADM is busy, USB cannot transfer information when in this mode
<b>ADM Status (CN)</b>	Green Solid	Power applied to module
	Yellow Solid	Active Communication
	Red Steady Flashing	Software upload from token in progress
	Red Random Flashing or Solid	Module error exists

## ADM Display Details

### Power Up Screen

The following screen appears when the ADM is powered up. It remains on while the ADM runs through initialization and establishes communication with other modules in the system.



### Menu Bar

The menu bar appears at the top of each screen. (The following image is only an example.)



#### Date and Time

The date and time are always displayed in one of the following formats. The time is always displayed as a 24-hour clock.

- DD/MM/YY HH:MM
- YY/MM/DD HH:MM
- MM/DD/YY HH:MM

#### Arrows

The left and right arrows indicate screen navigation.

#### Screen Menu

The screen menu indicates the currently active screen, which is highlighted. It also indicates the associated screens that are available by scrolling left and right.

#### System Mode

The current system mode is displayed at the lower left of the menu bar.

### Alarm/Deviation

The current system error is displayed in the middle of the menu bar. There are four possibilities:

Icon	Function
No Icon	No information or no error has occurred
	Advisory
	Deviation
	Alarm

### Status

The current system status is displayed at the lower right of the menu bar.

### Soft Keys

Icons next to the soft keys indicate which mode or action is associated with each soft key. Soft keys that do not have an icon next to them are not active in the current screen.

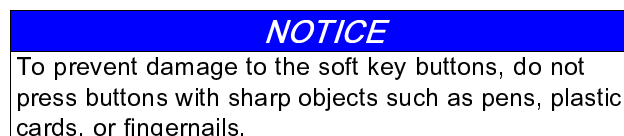

### Navigating the Screens

There are two sets of screens:

- The Run screens control spraying operations and display system status and data.
- The Setup screens control system parameters and advanced features.

Press  on any Run screen to enter the Setup screens. If the system has a password lock, the Password screen displays. If the system is not locked (password is set to 0000), System Screen 1 displays.

Press  on any Setup screen to return to the Home screen.











Press the Enter soft key  to activate the editing function on any screen.

Press the Exit soft key  to exit any screen.





















Use the other softkeys to select the function adjacent to them.

## Icons

### Icons

Icon	Function
	Component A
	Component B
	Estimated Supply Material
	Hose Temperature
	Jog Mode Speed
	Pressure
	Cycle Counter (press and hold)
	Advisory. See <a href="#">Errors, page 37</a> for more information.
	Deviation. See <a href="#">Errors, page 37</a> for more information
	Alarm. See <a href="#">Errors, page 37</a> for more information

### Softkeys

Icon	Function
	Start Proportioner
	Start and Stop Proportioner in Jog Mode
	Stop Proportioner
	Turn on or off the specified heat zone.
	Park pump
	Enter Jog Mode. See <a href="#">Jog Mode, page 45</a>
	Reset Cycle Counter (press and hold)
	Select Recipe
	Search
	Move Cursor Left One Character
	Move Cursor Right One Character
	Toggle between upper-case, lower-case, and numbers and special characters.
	Backspace
	Cancel
	Clear
	Troubleshoot Selected Error
	Increase value
	Decrease value
	Next screen
	Previous screen
	Return to first screen

## Electrical Enclosure

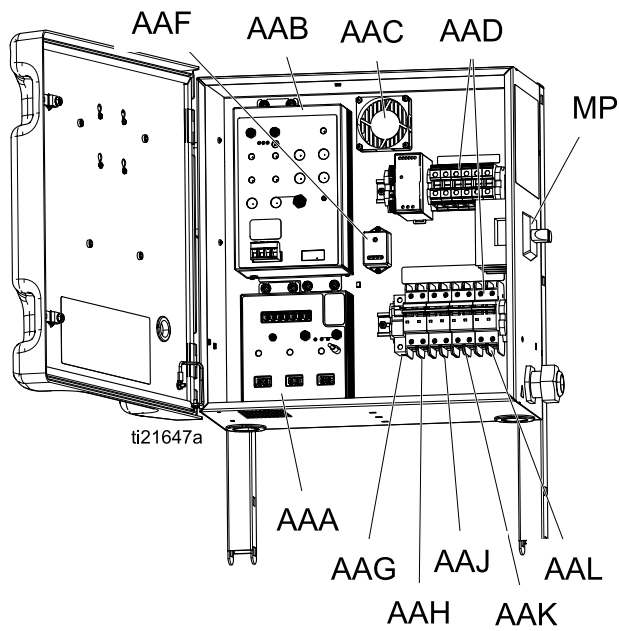

- AAA Temperature Control Module (TCM)
- AAB Motor Control Module (MCM)
- AAC Enclosure Fan
- AAD Wiring Terminal Blocks
- AAE Power Supply
- AAF Surge Protector
- AAG Hose Breaker
- AAH Motor Breaker
- AAJ A Side Heat Breaker
- AAK B Side Heat Breaker
- AAL Transformer Breaker
- MP Main Power Switch

## Motor Control Module (MCM)

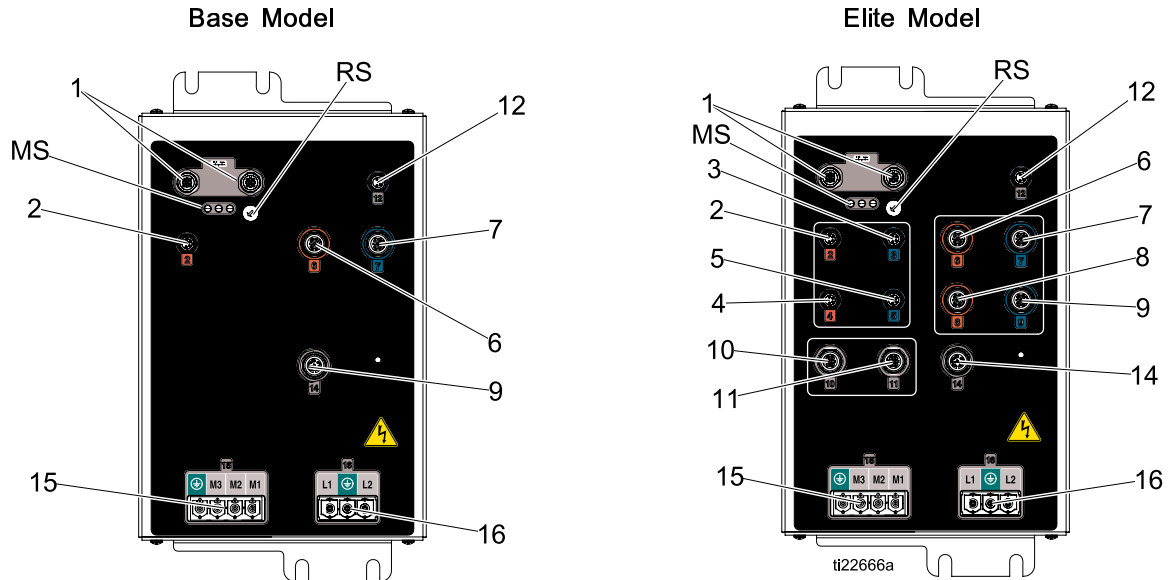

Figure 7

	Description
MS	Module Status LEDs see LED Status Table
1	CAN Communication Connections
2	Motor Temperature
3	Not used
4	Not used
5	Not used
6	A Pump Output Pressure
7	B Pump Output Pressure
8	A Fluid Inlet Sensor (Elite only)
9	B Fluid Inlet Sensor (Elite only)

10	Accessory output
11	Not used
12	Pump Cycle Counter
14	Graco Insite™
15	Motor Power Output
16	Main Power Input
*RS	Rotary Switch

**\* MCM Rotary Switch Positions**

2=E-30

3=E-XP2

Table 3 MCM Module LED (MB) Status Descriptions

LED	Conditions	Description
MCM Status	Green Solid	Power applied to module
	Yellow Solid	Active Communication
	Red Steady Flashing	Software upload from token in progress
	Red Random Flashing or Solid	Module error exists



## Temperature Control Module (TCM) Cable Connections

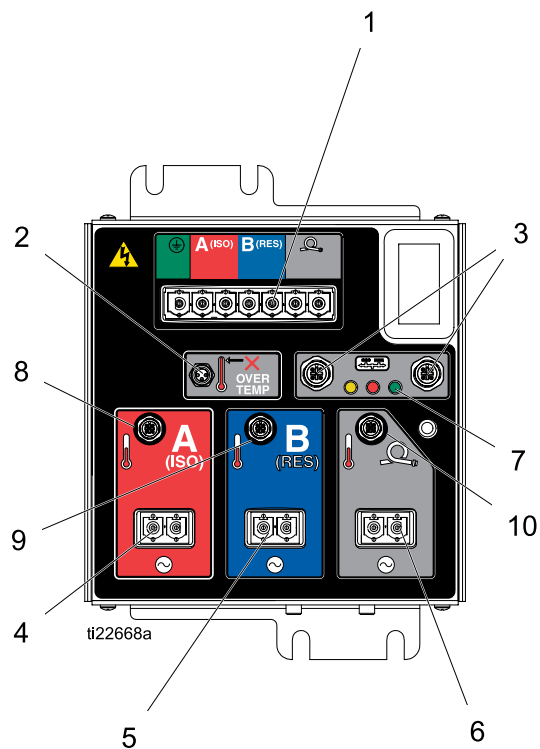

Figure 8

- 1 Power Input
- 2 Heater Overtemperature
- 3 CAN Communications Connections
- 4 Power Out (ISO)
- 5 Power Out (Res)
- 6 Power Out (Hose)
- 7 Module Status LEDs
- 8 Heater A Temperature (ISO)
- 9 Heater B Temperature (RES)
- 10 Hose Temperature

# Installation

## Setup From Shipping Configuration

1. Remove bolts (A) and nuts.
2. Swing up the electrical enclosure and reinstall bolt (A) with nut. Tighten bolt (B) and nut.
3. Position cable bundles against the frame and attach to the frame with loose wire tie (C) on each side.

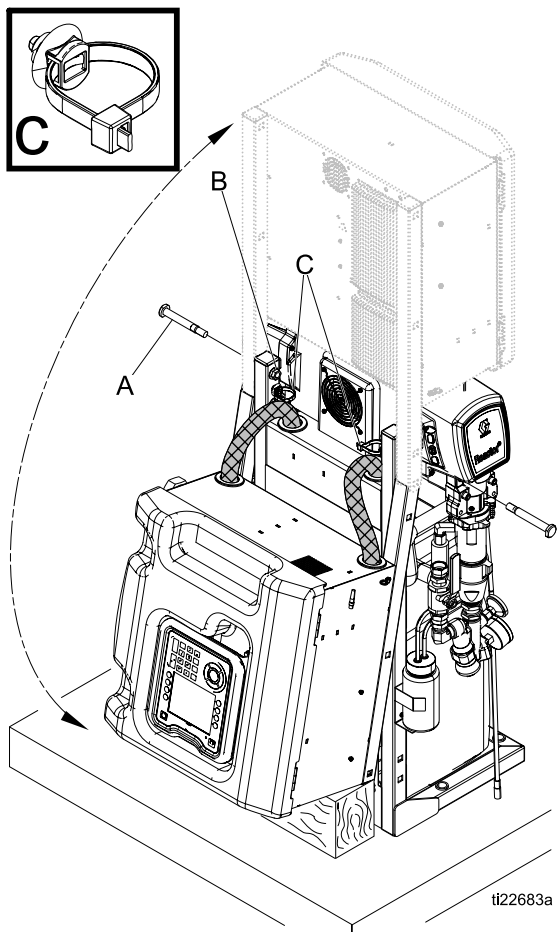

1. Use the supplied bolts to install the supplied L-brackets onto the system frame in the top-most square holes. Install brackets on both the left and right side of system frame.
2. Secure the L-brackets to the wall. If L-brackets do not line up with the wall stud spacing, bolt a piece of wood to the studs then secure L-brackets to wood.
3. Use the four holes in the base of the system frame to secure base to the floor. Bolts not supplied.

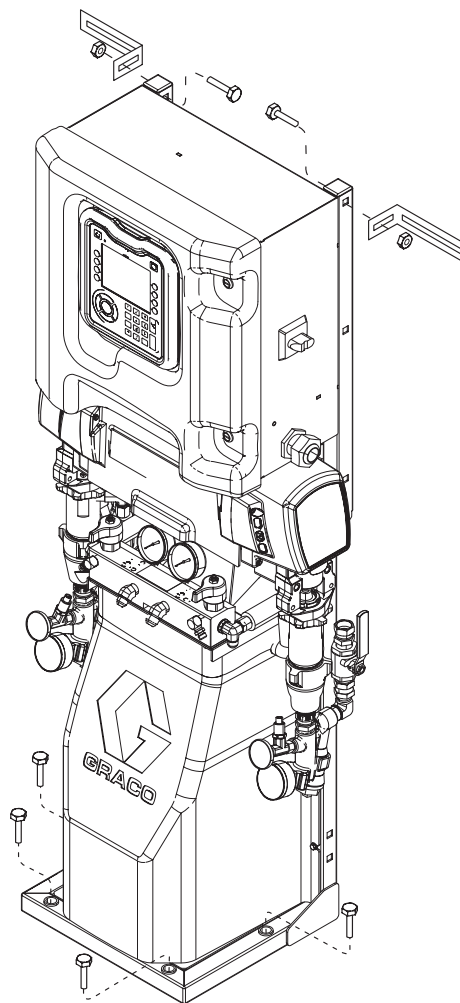

To prevent serious injury due to system tipping over, ensure Reactor is properly secured to wall.					

### Note

Mounting brackets and bolts are included in the box of loose parts, shipped with your system.

# Setup

## Grounding

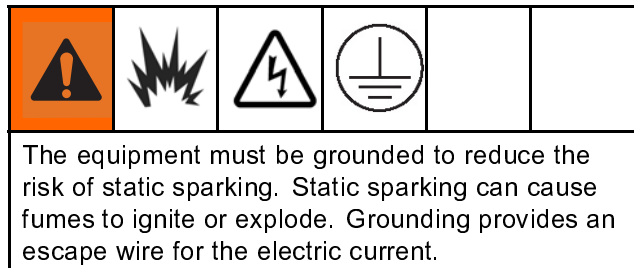

- *Reactor*: System is grounded through the power cord.
- *Spray gun*: connect whip hose ground wire to FTS. See [Install Fluid Temperature Sensor, page 29](#). Do not disconnect ground wire or spray without whip hose.
- *Fluid supply containers*: follow your local code.
- *Object being sprayed*: follow your local code.
- *Solvent pails used when flushing*: follow your local code. Use only metal pails, which are conductive, placed on a grounded surface. Do not place pail on a nonconductive surface, such as paper or cardboard, which interrupts grounding continuity.
- *To maintain grounding continuity when flushing or relieving pressure*, hold a metal part of spray gun firmly to the side of a grounded *metal* pail, then trigger gun.

## Close gun fluid manifold valves A and B

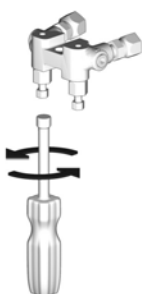

## General Equipment Guidelines

- Determine the correct size generator. Using the correct size generator and proper air compressor will enable the proportioner to run at a nearly constant RPM. Failure to do so will cause voltage fluctuations that can damage electrical equipment.

Use the following procedure to determine the correct size generator.

1. List system components that use peak load requirements in watts.
  2. Add the wattage required by the system components.
  3. Perform the following equation:  
Total watts x 1.25 = kVA (kilovolt-amperes)
  4. Select a generator size that is equal to or greater than the determined kVA.
- Use proportioner power cords that meet or exceed the requirements listed in Table 4. Failure to do so will cause voltage fluctuations that can damage electrical equipment.
  - Use an air compressor with continuous run head unloading devices. Direct online air compressors that start and stop during a job will cause voltage fluctuations that can damage electrical equipment.
  - Maintain and inspect the generator, air compressor, and other equipment per the manufacturer recommendations to avoid an unexpected shutdown. Unexpected equipment shutdown will cause voltage fluctuations that can damage electrical equipment.
  - Use a wall power supply with enough current to meet system requirements. Failure to do so will cause voltage fluctuations that can damage electrical equipment.

## Connect Power

All electrical wiring must be done by a qualified electrician and comply with all local codes and regulations.

1. Turn main power switch (MP) OFF.
2. Open electrical enclosure door.

**NOTE:** Terminal jumpers are located inside the electrical enclosure door.

3. Install supplied terminal jumpers in the positions shown in image for the power source used.
4. Route power cable through strain relief (EC) in electrical enclosure.
5. Connect incoming power wires as shown in image. Gently pull on all connections to verify they are properly secured.
6. Verify all items are connected properly as shown in image then close electrical enclosure door.

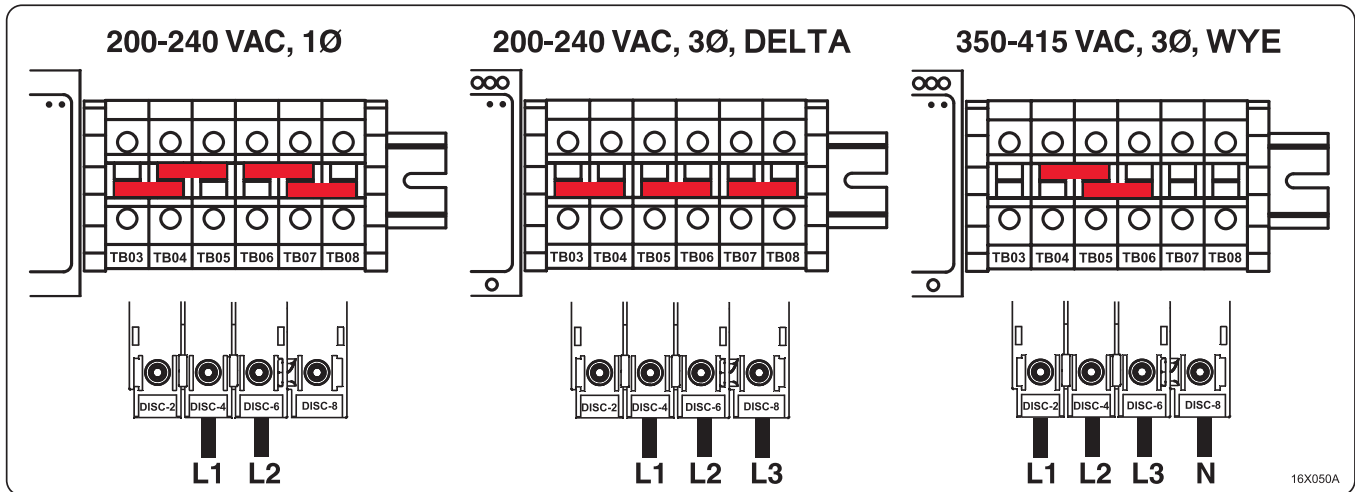

Table 4 Power Cord Requirements

Model	Input Power	Cord Specifications AWG (mm <sup>2</sup> )
E-30, 10 kW	200–240 VAC, 1 Phase	4 (21.2), 2 wire + ground
	200–240 VAC, 3 Phase, DELTA	6 (13.3), 3 wire + ground
	350–415 VAC, 3 Phase, WYE	8 (8.4), 4 wire + ground
E-30, 15 kW	200–240 VAC, 1 Phase	4 (21.2), 2 wire + ground
	200–240 VAC, 3 Phase, DELTA	6 (13.3), 3 wire + ground
	350–415 VAC, 3 Phase, WYE	8 (8.4), 4 wire + ground

Model	Input Power	Cord Specifications AWG (mm <sup>2</sup> )
E-XP2, 15 kW	200–240 VAC, 1 Phase	4 (21.2), 2 wire + ground
	200–240 VAC, 3 Phase, DELTA	6 (13.3), 3 wire + ground
	350–415 VAC, 3 Phase, WYE	8 (8.4), 4 wire + ground

## Supply Wet Cups With Throat Seal Liquid (TSL)

<p>Pump rod and connecting rod move during operation. Moving parts can cause serious injury such as pinching or amputation. Keep hands and fingers away from wet-cup during operation.</p>					

To prevent the pump from moving, turn the main power switch OFF.



- **Component A (ISO) Pump:** Keep reservoir (R) filled with Graco Throat Seal Liquid (TSL), Part 206995. Wet-cup piston circulates TSL through wet-cup, to carry away isocyanate film on displacement rod.

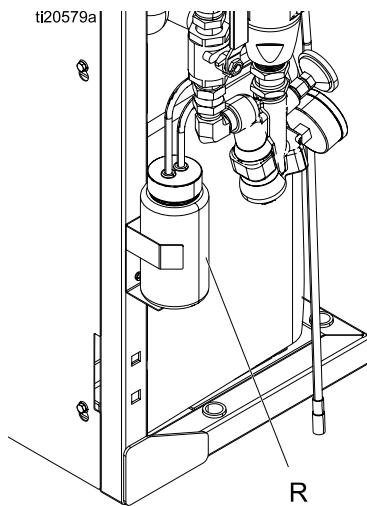

Figure 9 Component A Pump

- **Component B (Resin) Pump:** Check felt washers in packing nut/wet-cup (S) daily. Keep saturated with Graco Throat Seal Liquid (TSL), Part No. 206995, to prevent material from hardening on displacement rod. Replace felt washers when worn or contaminated with hardened material.

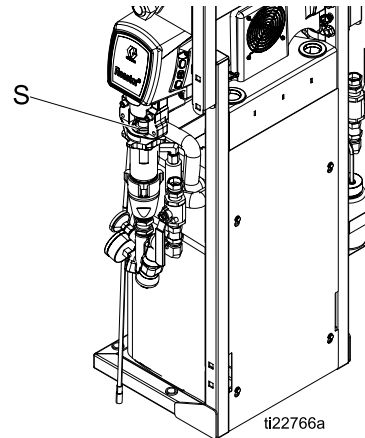

Figure 10 Component B Pump

## Install Fluid Temperature Sensor

The Fluid Temperature Sensor (FTS) is supplied. Install FTS between main hose and whip hose. See Heated Hose manual for instructions.

## Register and Activate the Graco InSite

### Note

Elite systems only.

1. Go to [www.GracolnSite.com](http://www.GracolnSite.com), then follow the instructions on the screen.
2. Find and record the 15 digit serial number from the cellular module below.

## Advanced Display Module (ADM) Operation

When main power is turned on by turning the main power switch (MP) to the ON position, the power up screen will be displayed until communication and initialization is complete.



Then the power key icon screen will display until the ADM power on/off button (A)  is pressed for the first time after system power-up.



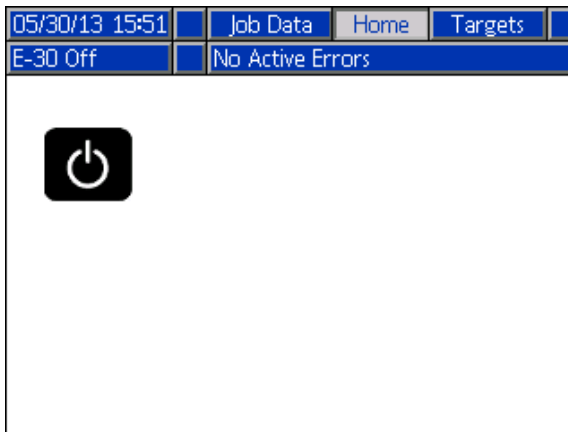

To begin using the ADM, the machine must be active. To verify the machine is active, verify that the System Status Indicator Light (B) is illuminated green, see [Advanced Display Module \(ADM\), page 18](#). If the System Status Indicator Light is not green, press the ADM Power On/Off (A) button . The System Status Indicator Light will illuminate yellow if the machine is disabled.



Perform the following tasks to fully setup your system.

1. Set pressure values for the Pressure Imbalance Alarm to activate. See [System Screen 1, page 34](#).
2. Enter, enable, or disable recipes. See [Recipes Screen, page 34](#).
3. Set general system settings. See [Advanced Screen 1 — General, page 33](#).
4. Set units of measure. See [Advanced Screen 2 — Units, page 33](#).
5. Set USB settings. See [Advanced Screen 3— USB, page 33](#).
6. Set target temperatures and pressure. See [Targets, page 36](#).
7. Set component A and component B supply levels. See [Maintenance, page 37](#).

## Setup Mode

The ADM will start in the Run screens at the Home screen. From the Run screens, press  to access the Setup screens. The system defaults with no password, entered as 0000. Enter the current password then press . Press   to navigate through the Setup Mode screens. See [Setup Screens Navigation Diagram, page 45](#).

## Set Password

Set a password to allow Setup screen access, see [Advanced Screen 1 – General, page 33](#). Enter any number from 0001 to 9999. To remove the password, enter the current password in the Advanced Screen – General screen and change the password to 0000.

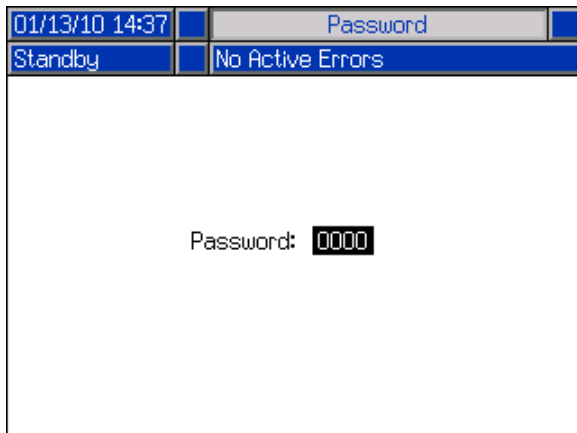

From the Setup screens, press  to return to the Run screens.



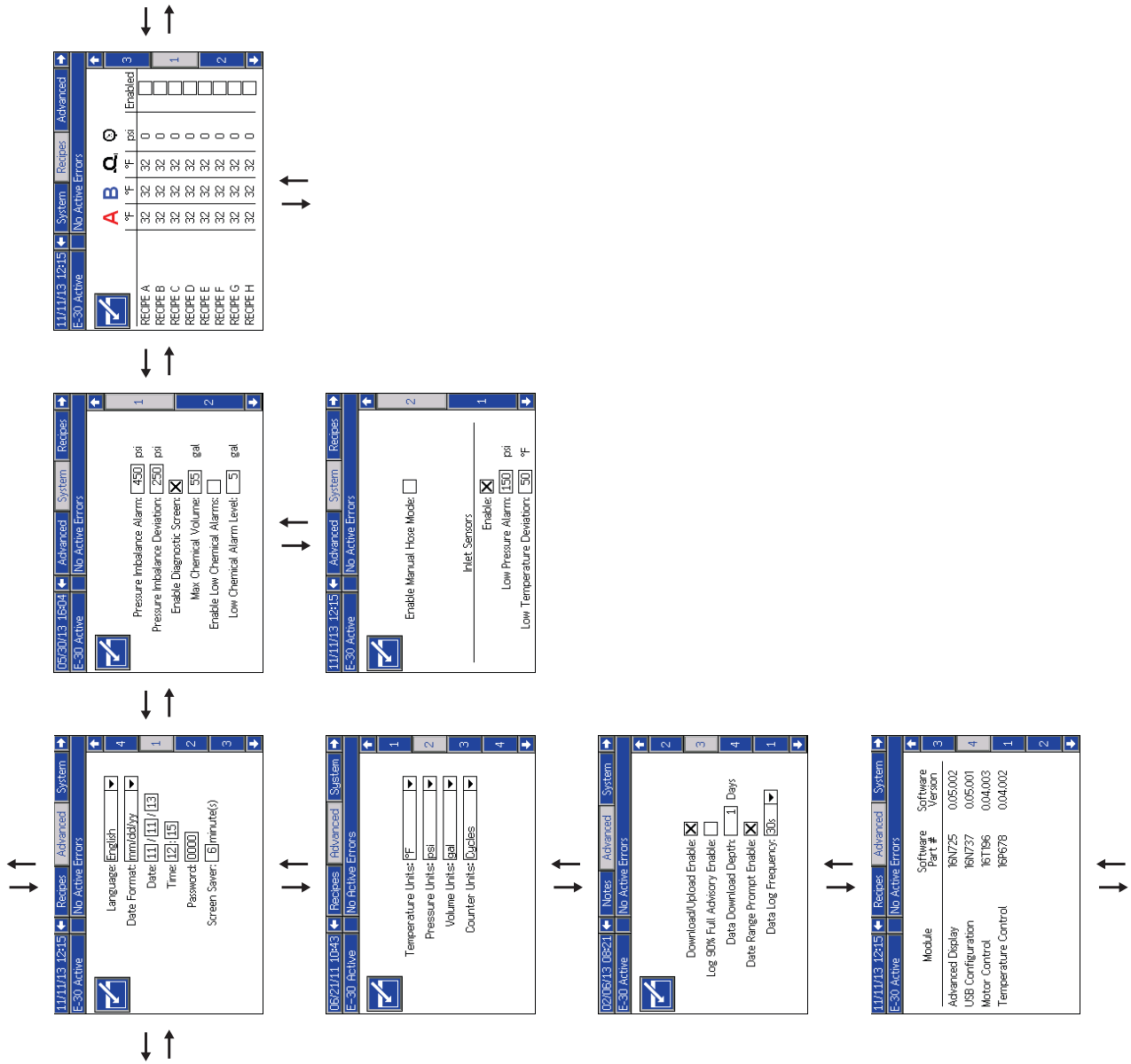

# Advanced Display Module (ADM) Operation



Setup Screens Navigation Diagram  
Figure 11



## Advanced Setup Screens

Advanced setup screens enable users to set units, adjust values, set formats, and view software information for each component. Press   to scroll through the Advanced setup screens, Once in the desired Advanced setup screen, press  to access the fields and make changes. When changes are complete press  to exit edit mode.

### Note

Users must be out of edit mode to scroll through the Advanced setup screens.

### Advanced Screen 1 — General

Use this screen to set the language, date format, current date, time, setup screens password (0000 – for none) or (0001 to 9999), and screen saver delay.

### Advanced Screen 2 — Units

Use this screen to set the temperature units, pressure units, volume units, and cycle units (pump cycles or volume).

### Advanced Screen 3 — USB

Use this screen to enable USB downloads/uploads, enable a logs 90% full advisory, enter the maximum number of days to download data, enable specifying date range of data to download, and how frequently USB logs are recorded. See .

### Advanced Screen 4— Software

This screen displays the software part number and software version for the Advanced Display Module, USB Configuration, Motor Control Module, and Temperature Control Modules.

Module	Software Part #	Software Version
Advanced Display	16N725	0.05.002
USB Configuration	16N737	0.05.001
Motor Control	16T196	0.04.003
Temperature Control	16P678	0.04.002

## System 1

Use this screen to set the activation pressure for the Pressure Imbalance Alarm and Deviation, enable or disable diagnostic screens, set the maximum and minimum drum volume, and enable drum alarms.

## System 2

Use this screen to enable Manual Hose Mode and inlet sensors, as well as setting the inlet sensor low pressure alarm and low temperature deviation. Manual Hose Mode disables the hose temperature RTD sensor so the system can operate if the sensors were to malfunction. Default settings are 10 psi (0.07 MPa, 0.7 bar) for low inlet pressure alarm and 50°F (10°C) for low inlet temperature deviation.

## Recipes

Use this screen to add recipes, view saved recipes, and enable or disable saved recipes. Enabled recipes can be selected at the Home Run Screen. 24 recipes can be displayed on the three recipe screens.

	A	B	Q	psi	Enabled
	°F	°F	°F		
RECIPE A	32	32	32	0	<input type="checkbox"/>
RECIPE B	32	32	32	0	<input type="checkbox"/>
RECIPE C	32	32	32	0	<input type="checkbox"/>
RECIPE D	32	32	32	0	<input type="checkbox"/>
RECIPE E	32	32	32	0	<input type="checkbox"/>
RECIPE F	32	32	32	0	<input type="checkbox"/>
RECIPE G	32	32	32	0	<input type="checkbox"/>
RECIPE H	32	32	32	0	<input type="checkbox"/>

### Add Recipe

1. Press and then use to select a recipe field. Press to enter a recipe name (maximum 16 characters). Press to clear the old recipe name.

2. Use to highlight the next field and use the number pad to enter a value. Press to save.

### Enable or Disable Recipes

1. Press and then use to select the recipe that needs to be enabled or disabled.
2. Use to highlight the enabled check box. Press to enable or disable the recipe.

## Run Mode

The ADM will start in the Run screens at the “Home” screen. Press to navigate through the Run Mode screens. See [Run Screens Navigation Diagram, page 44](#).

From the Run screens, press

to access the Setup screens.

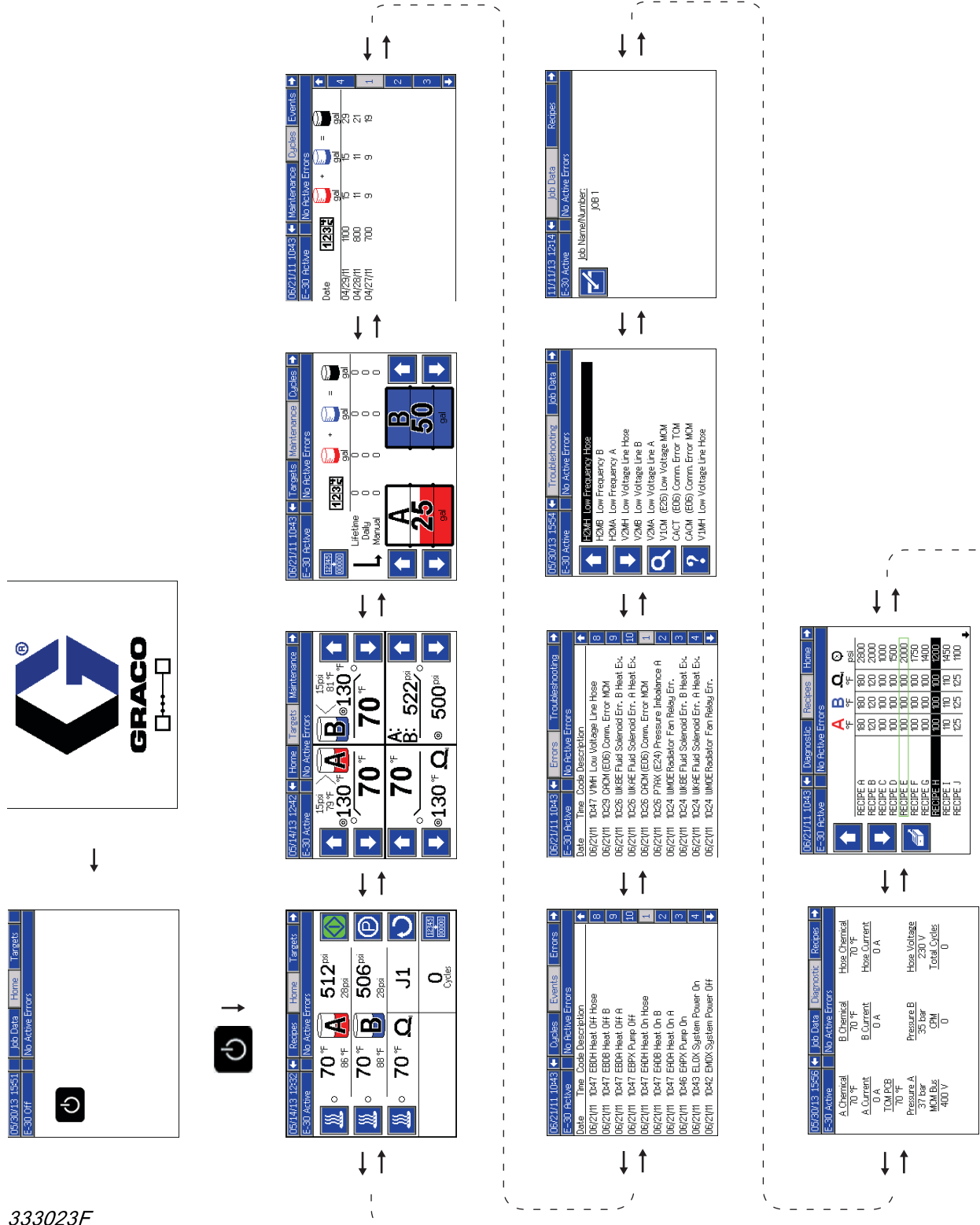

### Home — System Off

This is the home screen when the system is off. This screen displays actual temperatures, actual pressures at the fluid manifold, jog speed, coolant temperature, and number of cycles.

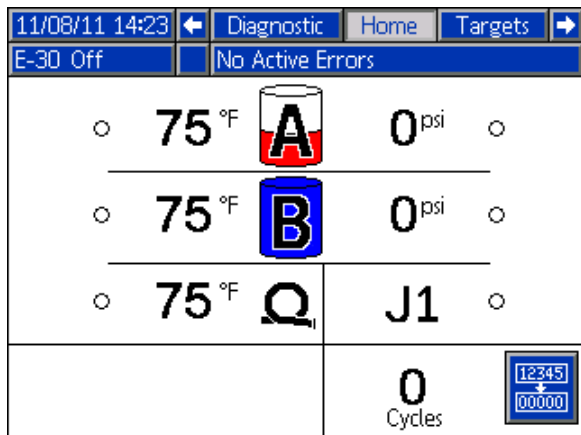

### Home — System Active

When the system is active, the home screen displays actual temperature for heat zones, actual pressures at the fluid manifold, coolant temperature, jog speed, the number of cycles, along with all associated control soft keys.

Use this screen to turn on heat zones, view coolant temperature, start the proportioner, stop the proportioner, park the component A pump, enter jog mode, and clear cycles.

**NOTE:** Screen shown displays inlet sensor temperatures and pressures. These will not be shown on models without inlet sensors.

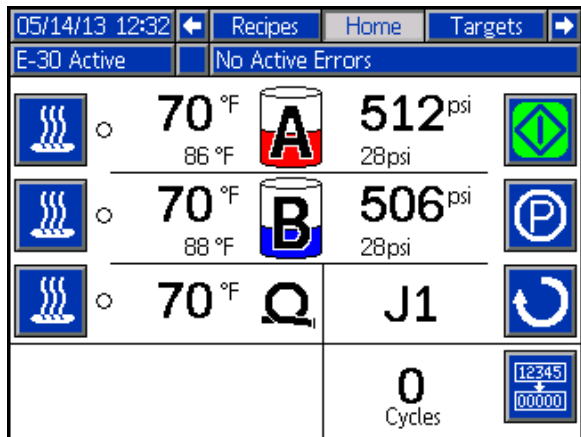

### Home — System With Error

Active errors are shown in the status bar. The error code, alarm bell, and description of the error will scroll in the status bar.

1. Press to acknowledge the error.
2. See for corrective action.



### Targets

Use this screen to define the setpoints for the A Component Temperature, B Component Temperature, heated hose temperature, and pressure.

**Maximum A and B temperature:** 190°F (88°C)

**Maximum heated hose temperature:** 10°F (5°C) above the highest A or B temperature setpoint or 180°F (82°C).

### Note

If the remote display module kit is used, these setpoints can be modified at the gun.

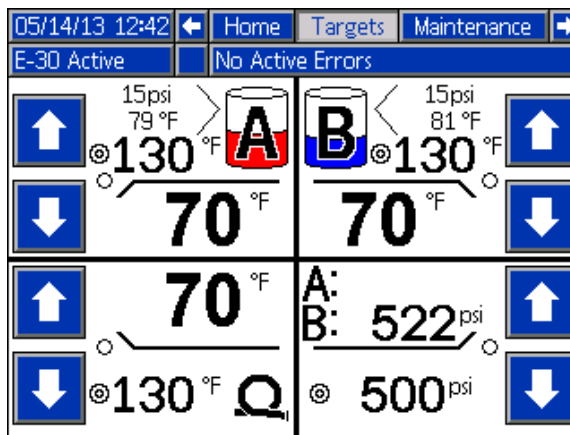

## Maintenance

Use this screen to view daily and lifetime cycles or gallons that have been pumped and gallons or liters remaining in the drums.

The lifetime value is the number of pump cycles or gallons since the first time the ADM was turned on.

The daily value automatically resets at midnight.

The manual value is the counter that can be manually reset. Press  and hold to reset manual counter.

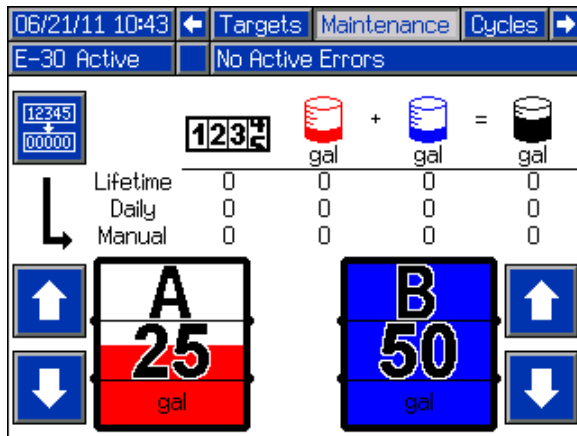

## Cycles

This screen shows daily cycles and gallons that have been sprayed for the day.

All information listed on this screen can be downloaded on a USB flash drive.

Date	Cycles	gal	gal	gal
04/29/11	1100	15	15	29
04/28/11	800	11	11	21
04/27/11	700	9	9	19

## Events

This screen shows the date, time, event code, and description of all events that have occurred on the system. There are 10 pages, each holding 10 events. The 100 most recent events are shown. See [System Events](#) for event code descriptions.

See [Error Codes and Troubleshooting, page 58](#) for error code descriptions.

All events and errors listed on this screen can be downloaded on a USB flash drive. To download logs, see [Download Procedure, page 59](#).

Date	Time	Code	Description
06/21/11	10:47	EBDH	Heat Off Hose
06/21/11	10:47	EBDB	Heat Off B
06/21/11	10:47	EBDA	Heat Off A
06/21/11	10:47	EBPX	Pump Off
06/21/11	10:47	EADH	Heat On Hose
06/21/11	10:47	EADB	Heat On B
06/21/11	10:47	EADA	Heat On A
06/21/11	10:46	EAPX	Pump On
06/21/11	10:43	ELOX	System Power On
06/21/11	10:42	EMOX	System Power Off



## Errors

This screen shows the date, time, error code, and description of all errors that have occurred on the system.

All errors listed on this screen can be downloaded on a USB flash drive.

Date	Time	Code	Description
06/21/11	10:47	V1MH	Low Voltage Line Hose
06/21/11	10:29	CACM (E06)	Comm. Error MCM
06/21/11	10:26	WKBE	Fluid Solenoid Err. B Heat Ex.
06/21/11	10:26	WKAE	Fluid Solenoid Err. A Heat Ex.
06/21/11	10:26	CACM (E06)	Comm. Error MCM
06/21/11	10:26	P7AX (E24)	Pressure Imbalance A
06/21/11	10:24	WMOE	Radiator Fan Relay Err.
06/21/11	10:24	WKBE	Fluid Solenoid Err. B Heat Ex.
06/21/11	10:24	WKAE	Fluid Solenoid Err. A Heat Ex.
06/21/11	10:24	WMOE	Radiator Fan Relay Err.

### Troubleshooting

This screen displays the last ten errors that occurred on the system. Use the up and down arrows to select an error and press  to view the QR code for the selected error. Press  to access the QR code screen for an error code that is not listed on this screen. See [Error Codes and Troubleshooting, page 58](#), for more information on error codes.

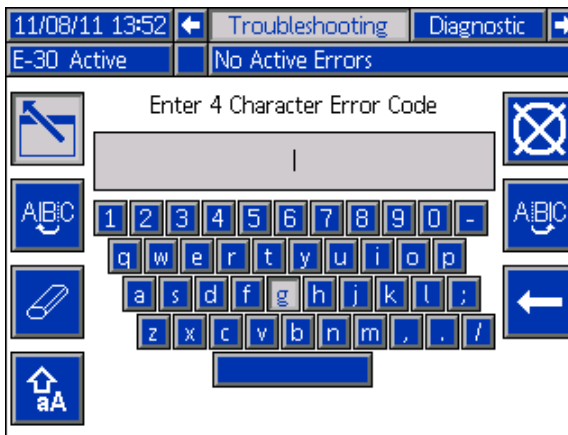
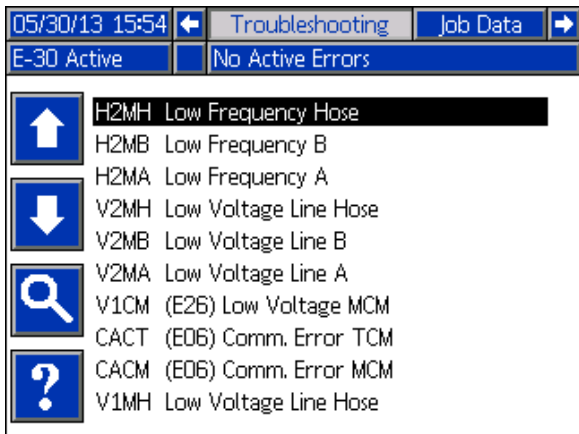

### QR Codes



To quickly view online help for a given error code, scan the displayed QR code with your smartphone. Alternately, visit <http://help.graco.com> and search for the error code to view online help for that code.

## Diagnostic

Use this screen to view information for all system components.

12/20/13 09:00			Job Data	Diagnostic	Home
E-30 Active		No Active Errors			
A Chemical	B Chemical	Hose Chemical			
70 °F	70 °F	70 °F			
A Current	B Current	Hose Current			
0 A	0 A	0 A			
TCM PCB					
70 °F					
Pressure A	Pressure B	Hose Voltage			
0 psi	0 psi	90 V			
MCM Bus	CFM	Total Cycles			
400 V	0	0			

The following information is displayed:

### Temperature

- A Chemical
- B Chemical
- Hose Chemical
- TCM PCB — temperature control module temperature

### Amps

- A Current ★(0–25 A for 10kW heater, 0–38 A for 15 kW heater)
- B Current ★(0–25 A for 10kW heater, 0–38 A for 15 kW heater)
- Hose Current ★(0–45 A typical)

### Volts

- MCM Bus★ — displays the voltage supplied to the motor controller, which is the DC voltage that has been converted from the AC voltage supplied to the system (275–400 VAC typical full range)
- Hose Voltage (90V)

### Pressure

- Pressure A — chemical
- Pressure B — chemical

### Cycles

- CPM — cycles per minute
- Total Cycles — lifetime cycles

## Note

★ Maximum values based on maximum input voltage. Values will lower with lower input voltage.

## Job Data

Use this screen to enter a job name or number.

11/11/13 12:14		Job Data	Recipes
E-30 Active		No Active Errors	
	Job Name/Number:		
	JOB 1		

## Recipes

Use this screen to select an enabled recipe. Use the up and down arrows to highlight a recipe and press to load. The currently loaded recipe is outlined by a green box.

## Note

This screen will not display if there are not any enabled recipes. To enable or disable recipes, see [Recipes Setup Screen, page 34](#).

06/21/11 10:43		Diagnostic	Recipes	Home
E-30 Active		No Active Errors		
		A	B	Q
		°F	°F	psi
	RECIPE A	180	180	2800
	RECIPE B	120	120	2000
	RECIPE C	100	100	1000
	RECIPE D	100	100	1500
	RECIPE E	100	100	2000
	RECIPE F	100	100	1750
	RECIPE G	100	100	1400
	RECIPE H	100	100	1200
	RECIPE I	110	110	1450
	RECIPE J	125	125	1100

## System Events

Use the table below to find a description for all system non-error events. All events are logged in the USB log files.

Event Code	Description
EACX	Recipe Selected
EADA	Heat On A
EADB	Heat On B
EADH	Heat On Hose
EAPX	Pump On
EARX	Jog On
EAUX	USB Drive Inserted
EB0X	ADM Red Stop Button Pressed
EBDA	Heat Off A
EBDB	Heat Off B
EBDH	Heat Off Hose
EBPX	Pump Off
EBRX	Jog Off
EBUX	USB Drive Removed
EC0X	Setup Value Changed
ECDA	A Temperature Setpoint Changed
EADB	B Temperature Setpoint Changed
ECDH	Hose Temperature Setpoint Changed
ECDP	Pressure Setpoint Changed
ECDX	Recipe Changed
EL0X	System Power On
EM0X	System Power Off
EP0X	Pump Parked
EQU1	System Settings Downloaded
EQU2	System Settings Uploaded
EQU3	Custom Language Downloaded
EQU4	Custom Language Uploaded
EQU5	Logs Downloaded
ER0X	User Counter Reset
EVUX	USB Disabled



# Startup



## NOTICE

Proper system setup, startup, and shutdown procedures are critical to electrical equipment reliability. The following procedures ensure steady voltage. Failure to follow these procedures will cause voltage fluctuations that can damage electrical equipment and void the warranty.

### 1. Check fluid inlet filter screens.

Before daily startup, ensure that the fluid inlet screens are clean. See [Flush Inlet Strainer Screen, page 55](#)

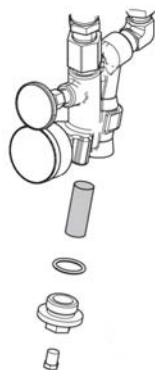

### 2. Check ISO lubrication reservoir.

Check level and condition of ISO lube daily. See [Pump Lubrication System, page 56](#).



### 3. Use A and B Drum Level Sticks (24M174) to measure the material level in each drum.. If

desired, the level can be entered and tracked in the ADM. See [Advanced Setup Screens, page 33](#).

### 4. Check generator fuel level.

## NOTICE

Running out of fuel will cause voltage fluctuations that can damage electrical equipment and void the warranty. Do not run out of fuel.

### 5. Confirm main power switch is OFF before starting generator.

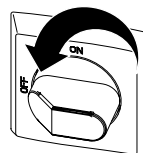

### 6. Ensure the main breaker on the generator is in the off position.

### 7. Start the generator. Allow it to reach full operating temperature.



### 8. Turn main power switch ON.

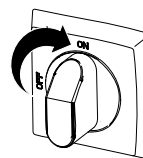

The ADM will display the following screen until communication and initialization is complete.



## Startup

9. Switch on the air compressor, air dryer, and breathing air, if included.

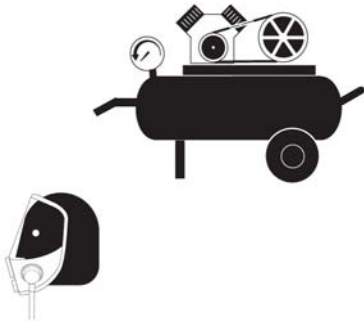



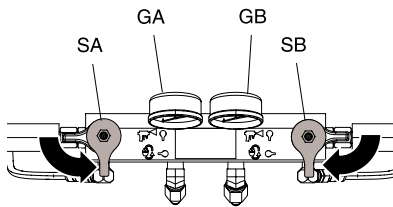

10. For first startup of new system, load fluid with feed pumps.

- Check that all **Setup** steps are complete. See [Setup, page 27](#).
- If an agitator is used, open the agitator's air inlet valve.
- If you need to circulate fluid through the system to preheat the drum supply, see [Circulation Through Reactor, page 44](#). If you need to circulate material through the heat hose to the gun manifold, see [Circulation Through Gun Manifold, page 45](#).
- Turn both **PRESSURE RELIEF/SPRAY** valves (SA, SB) to **SPRAY** .

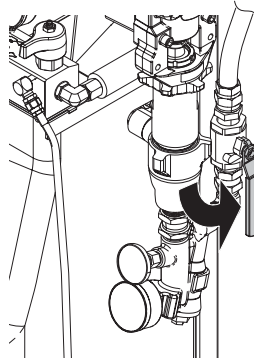

- e. Open fluid inlet valves (FV). Check for leaks.



				
<p>Cross-contamination can result in cured material in fluid lines which could cause serious injury or damage equipment. To prevent cross-contamination:</p> <ul style="list-style-type: none"> <li>• <b>Never</b> interchange component A and component B wetted parts.</li> <li>• Never use solvent on one side if it has been contaminated from the other side.</li> <li>• Always provide two grounded waste containers to keep component A and component B fluids separate.</li> </ul>				

- f. Hold gun fluid manifold over two grounded waste containers. Open fluid valves A and B until clean, air-free fluid comes from valves. Close valves.

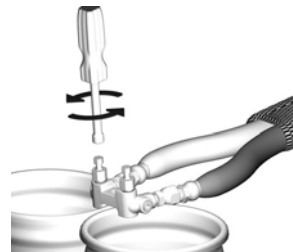

*The Fusion AP gun manifold is shown.*

11. Press  to activate ADM.







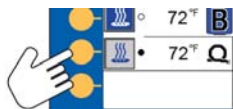

12. If necessary, setup the ADM in Setup Mode. See [Advanced Display Module \(ADM\) Operation, page 30](#).

13. Preheat the system:

- a. Press  to turn on hose heat zone.



				
<p>This equipment is used with heated fluid which can cause equipment surfaces to become very hot. To avoid severe burns:</p> <ul style="list-style-type: none"> <li>• Do not touch hot fluid or equipment.</li> <li>• Do not turn on hose heat without fluid in hoses.</li> <li>• Allow equipment to cool completely before touching it.</li> <li>• Wear gloves if fluid temperature exceeds 110°F (43°C).</li> </ul>				

				
<p>Thermal expansion can cause overpressurization, resulting in equipment rupture and serious injury, including fluid injection. Do not pressurize system when preheating hose.</p>				

- b. If you need to circulate fluid through the system to preheat the drum supply, see [Circulation Through Reactor, page 44](#). If you need to circulate material through the heat hose to the gun manifold, see [Circulation Through Gun Manifold, page 45](#).
- c. Wait for the hose to reach set point temperature.

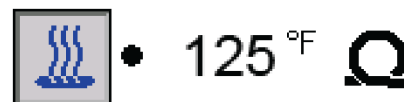

**Note**

Hose heat-up time may increase at voltages less than nominal 230 VAC when maximum hose length is used.

- d. Press  to turn on A and B heat zones.

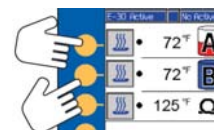

# Fluid Circulation





## Circulation Through Reactor

<b>NOTICE</b>
To prevent equipment damage, do not circulate fluid containing a blowing agent without consulting with your material supplier regarding fluid temperature limits.

**NOTE:** Optimum heat transfer is achieved at lower fluid flow rates with temperature set points at desired drum temperature. Low temperature rise deviation errors may result.

To circulate through gun manifold and preheat hose, see [Circulation Through Gun Manifold](#), page 45.



1. Follow [Startup](#), page 41.

				
To avoid injection injury and splashing, do not install shutoffs downstream of the PRESSURE RELIEF/SPRAY valve outlets (BA, BB). The valves function as overpressure relief valves when set to SPRAY  . Lines must be open so valves can automatically relieve pressure when machine is operating.				

2. See [Typical Installation, with system fluid manifold to drum circulation](#), page 14. Route circulation lines back to respective component A or B supply drum. Use hoses rated at the maximum working pressure of this equipment. See [Technical Specifications](#), page 65.

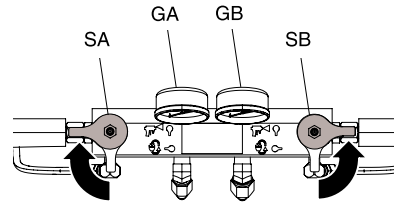
3. Set PRESSURE RELIEF/SPRAY valves (SA, SB) to PRESSURE RELIEF/CIRCULATION .



4. Set temperature targets. See [Targets](#), page 36.
5. Press  to circulate fluid in jog mode until A and B temperatures reach targets. See [Jog Mode](#), page 45 for more information about jog mode.
6. Press  to turn on the hose heat zone.
7. Turn on the A and B heat zones. Wait until the fluid inlet valve temperature gauges (FV) reach the minimum chemical temperature from the supply drums.
8. Exit jog mode.
9. Set PRESSURE RELIEF/SPRAY valves (SA, SB) to SPRAY .

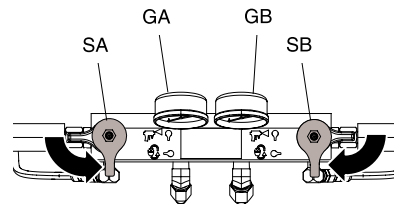

## Circulation Through Gun Manifold

### NOTICE

To prevent equipment damage, do not circulate fluid containing a blowing agent without consulting with your material supplier regarding fluid temperature limits.

**NOTE:** Optimum heat transfer is achieved at lower fluid flow rates with temperature set points at desired drum temperature. Low temperature rise deviation errors may result.

Circulating fluid through the gun manifold allows rapid preheating of the hose.

1. Install gun fluid manifold (P) on accessory circulation kit (CK). Connect high pressure circulation lines (R) to circulation manifold.

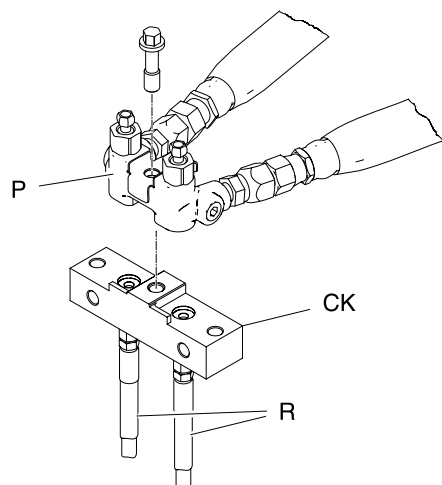

The Fusion AP gun manifold is shown.

CK	Gun	Manual
246362	Fusion AP	309818
256566	Fusion CS	313058

2. Route circulation lines back to respective component A or B supply drum. Use

hoses rated at the maximum working pressure of this equipment. See [Technical Specifications, page 65](#).

3. Follow procedures from [Startup, page 41](#).





4. Turn main power switch on
5. Set temperature targets. See [Targets, page 36](#).
6. Press  to circulate fluid in jog mode until A and B temperatures reach targets. See [Jog Mode, page 45](#) for more information about jog mode.

## Jog Mode

Jog mode has two purposes:



- It can speed fluid heating during circulation.
- It can ease system flushing and priming.



1. Turn main power switch on
2. Press circulate  to enter jog mode.
3. Press up or down   to change jog speed (J1 through J20).

### Note

Jog speeds correlate to 3-30% of motor power, but will not operate over 700 psi (4.9 MPa, 49 bar) for either A or B.

4. Press  to start motor.
5. To stop the motor and exit jog mode press  or .

# Spraying



The Fusion AP gun is shown.

1. Engage gun piston safety lock and close gun fluid inlet valves A and B.

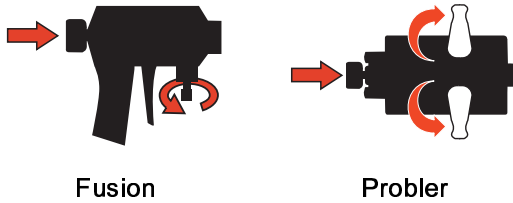

2. Attach gun fluid manifold. Connect gun air line. Open air line valve.

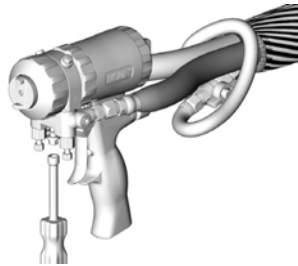

3. Adjust the gun air regulator to desired gun air pressure. Do not exceed the maximum rated air pressure.

4. Set PRESSURE RELIEF/SPRAY valves (SA, SB) to SPRAY 

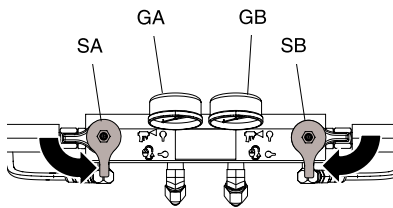

5. Verify heat zones are on and temperatures and pressures are on target, see [Home screen, page 36](#).

6. Open fluid inlet valve located at each pump inlet.

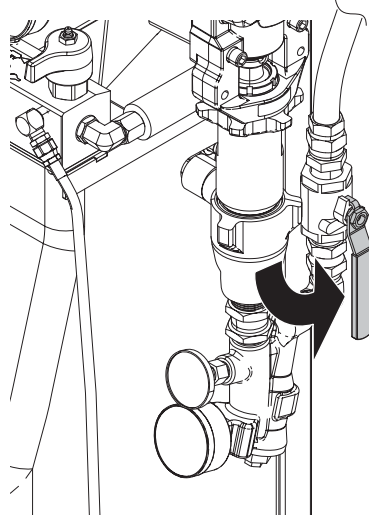

7. Press  to start motor and pumps.



8. Check fluid pressure gauges (GA, GB) to ensure proper pressure balance. If imbalanced, reduce pressure of higher component by **slightly** turning PRESSURE RELIEF/SPRAY valve for that component toward PRESSURE

RELIEF/CIRCULATION  until gauges show balanced pressures.

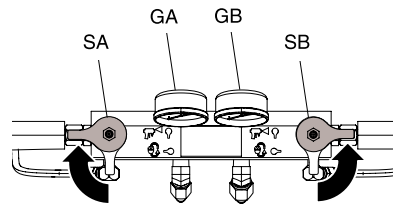

9. Open gun fluid inlet valves A and B.



Fusion

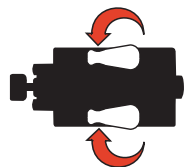

Probler

**NOTICE**

To prevent material crossover on impingement guns, **never** open fluid manifold valves or trigger gun if pressures are imbalanced.

10. Disengage gun piston safety lock.



Fusion



Probler

11. Pull gun trigger to test spray onto cardboard. If necessary, adjust pressure and temperature to get desired results.

**Spray Adjustments**

Flow rate, atomization, and amount of overspray are affected by four variables.

- **Fluid pressure setting.** Too little pressure results in an uneven pattern, coarse droplet size, low flow, and poor mixing. Too much pressure results in excessive overspray, high flow rates, difficult control, and excessive wear.
- **Fluid temperature.** Similar effects to fluid pressure setting. The A and B temperatures can be offset to help balance the fluid pressure.
- **Mix chamber size.** Choice of mix chamber is based on desired flow rate and fluid viscosity.
- **Clean-off air adjustment.** Too little clean-off air results in droplets building up on the front of the nozzle, and no pattern containment to control overspray. Too much clean-off air results in air-assisted atomization and excessive overspray.

## Manual Hose Heat Mode

If the system produces the T6DH sensor error hose alarm or the T6DT sensor error TCM alarm, use manual hose heat mode until the hose RTD cable or FTS temperature sensor can be repaired.

Do not use Manual Hose Mode for extended periods of time. The system performs best when the hose has a valid RTD and can operate in temperature control mode. If a hose RTD breaks, the first priority is to fix the RTD. Manual Hose Mode can help finish a job while waiting for repair parts.

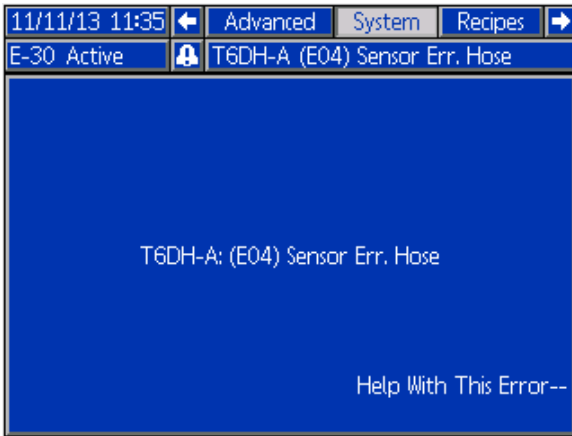

### Enable Manual Hose Mode

1. Disconnect the hose RTD sensor from the TCM.
2. Enter Setup Mode and navigate to System Screen 2.

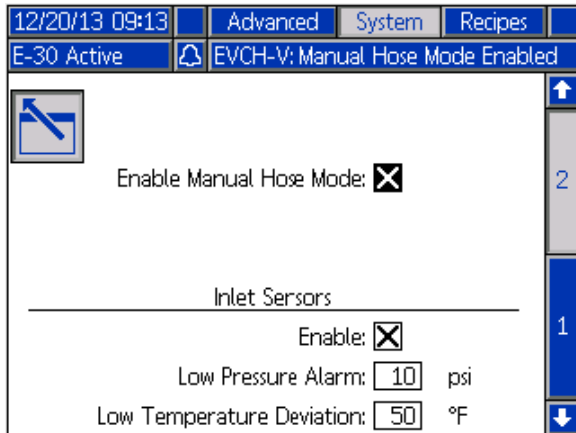

3. Select Enable Manual Hose Mode.

**Note**

When manual hose mode is enabled, the manual hose mode advisory EVCH-V will appear.

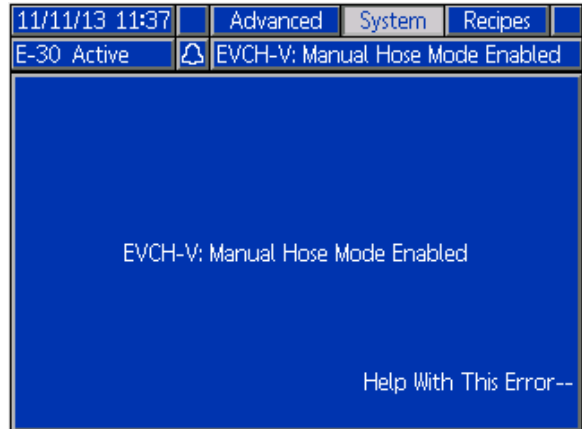

4. Enter Run Mode and navigate to the Target screen. Use the up and down arrows to set the desired hose current.

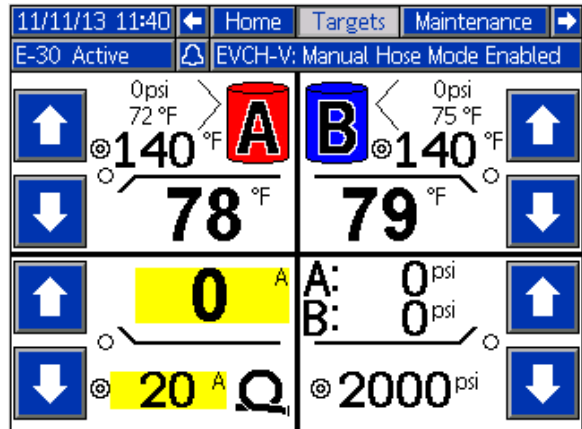

Hose Current Settings	Hose Current
Default	20A
Maximum	37A



5. Navigate back to the Run Mode Home screen. The hose now displays a current instead of a temperature.

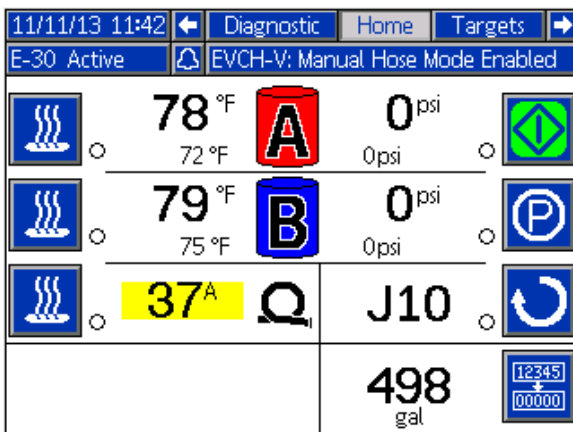

**Note**

Until the RTD sensor is repaired, the T6DH sensor error alarm will display each time the system is powered up.

**Disable Manual Hose Mode**

1. Enter Setup Mode and navigate to System 2 Screen and deselect Enable Manual Hose Mode, or repair the hose RTD cable or FTS.

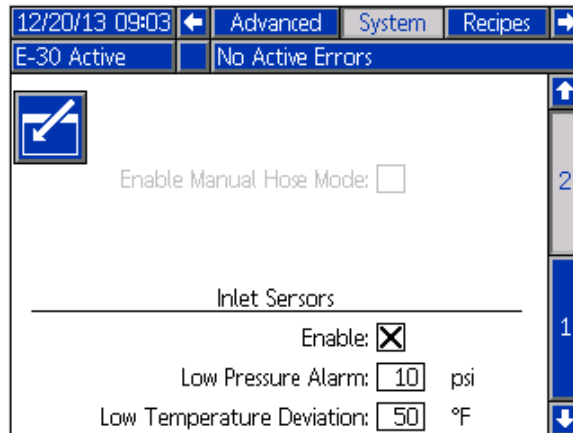

2. Manual hose mode is automatically disabled when the system detects a valid RTD sensor in the hose.

# Shutdown

**NOTICE**

Proper system setup, startup, and shutdown procedures are critical to electrical equipment reliability. The following procedures ensure steady voltage. Failure to follow these procedures will cause voltage fluctuations that can damage electrical equipment and void the warranty.

1. Press  to stop the pumps.



2. Turn off all heat zones.

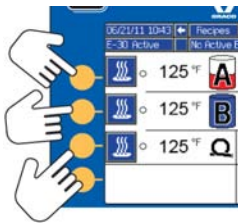

3. Relieve pressure. See [Pressure Relief Procedure, page 52](#).

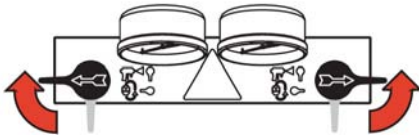

4. Press  to park the Component A Pump. The park operation is complete when green dot goes out. Verify the park operation is complete before moving to next step.

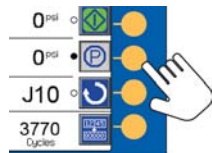

5. Press  to deactivate the system.





6. Turn off the air compressor, air dryer, and breathing air.

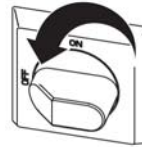

7. Turn main power switch OFF.



				
To prevent electric shock do not remove any shrouds or open the electrical enclosure door.				

8. Close all fluid supply valves.

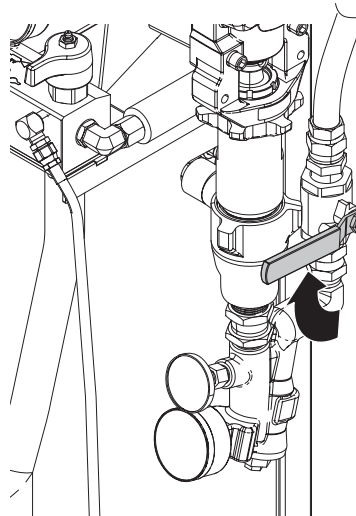

9. Set PRESSURE RELIEF/SPRAY valves (SA, SB) to SPRAY  to seal out moisture from drain line.

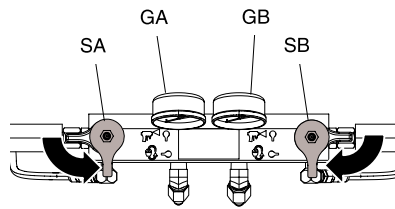

10. Engage gun piston safety lock then close fluid inlet valves A and B.

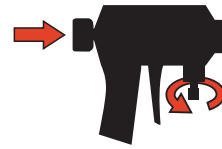

Fusion

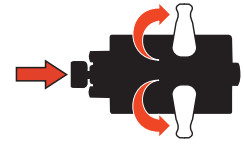

Probler

# Pressure Relief Procedure



Follow the Pressure Relief Procedure whenever you see this symbol.



This equipment stays pressurized until pressure is manually relieved. To help prevent serious injury from pressurized fluid, such as skin injection, splashing fluid and moving parts, follow the Pressure Relief Procedure when you stop spraying and before cleaning, checking, or servicing equipment.

*The Fusion AP gun is shown.*

1. Relieve pressure in gun and perform gun shutdown procedure. See gun manual.
2. Close gun fluid inlet valves A and B.

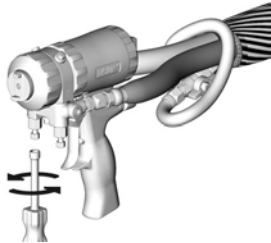

3. Shut off feed pumps and agitator, if used.

4. Route fluid to waste containers or supply tanks. Turn PRESSURE RELIEF/SPRAY valves (SA, SB) to PRESSURE RELIEF/CIRCULATION



Ensure gauges drop to 0.

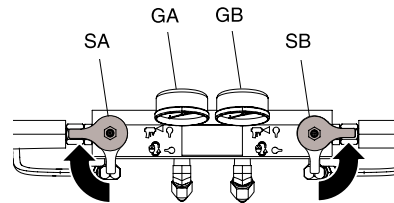

5. Engage gun piston safety lock.



6. Disconnect gun air line and remove gun fluid manifold.

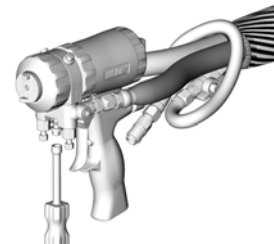

# Flushing

<p>To help prevent fire and explosion:</p> <ul style="list-style-type: none"> <li>• Flush equipment only in a well-ventilated area.</li> <li>• Do not spray flammable fluids.</li> <li>• Do not turn on heaters while flushing with flammable solvents.</li> <li>• Flush out old fluid with new fluid, or flush out old fluid with a compatible solvent before introducing new fluid.</li> <li>• Use the lowest possible pressure when flushing.</li> <li>• All wetted parts are compatible with common solvents. Use only moisture-free solvents.</li> </ul>					

To flush feed hoses, pumps, and heaters separately from heated hoses, set PRESSURE RELIEF/SPRAY valves (SA, SB) to PRESSURE

RELIEF/CIRCULATION . Flush through bleed lines (N).

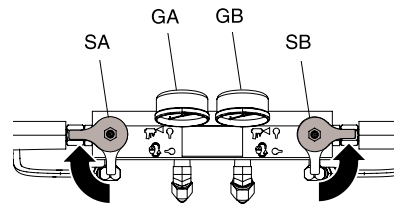

To flush entire system, circulate through gun fluid manifold (with manifold removed from gun).

To prevent moisture from reacting with isocyanate, always leave the system filled with a moisture-free plasticizer or oil. Do not use water. Never leave the system dry. See [Important Two-Component Material Information, page 7](#).

# Maintenance

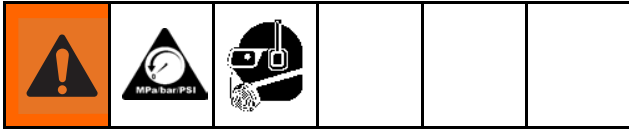

Prior to performing any maintenance procedures, follow [Pressure Relief Procedure, page 52](#).

## Preventative Maintenance Schedule

The operating conditions of your particular system determine how often maintenance is required. Establish a preventive maintenance schedule by recording when and what kind of maintenance is needed, and then determine a regular schedule for checking your system.

## Proportioner Maintenance

### Wet Cup

Check the wet cup daily. Keep it 2/3 full with Graco Throat Seal Liquid (TSL®) or compatible solvent. Do not overtighten packing nut/wet cup.

### Packing Nuts

Do not overtighten packing nut/wet cup. Throat u-cup is not adjustable.

### Fluid Inlet Strainer Screens

Inspect fluid inlet strainer screens daily, see [Flush Inlet Strainer Screen, page 55](#).

## Grease Circulation Valves

Grease circulation valves (SA and SB) with Fusion grease (117773) weekly.

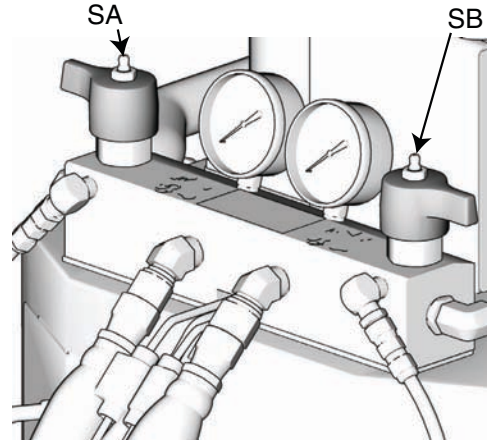

ti10955a

## ISO Lubricant Level

Inspect ISO lubricant level and condition daily. Refill or replace as needed. See [Pump Lubrication System, page 56](#).

## Moisture

To prevent crystallization, do not expose component A to moisture in air.

## Gun Mix Chamber Ports

Clean gun mix chamber ports regularly. See gun manual.

## Gun Check Valve Screens

Clean gun check valve screens regularly. See gun manual.

## Dust Protection

Use clean, dry, oil-free compressed air to prevent dust buildup on control modules, fans, and motor (under shield).

## Vent Holes

Keep vent holes on bottom of electrical cabinet open.

## Flush Inlet Strainer Screen



The inlet strainers filter out particles that can plug the pump inlet check valves. Inspect the screens daily as part of the startup routine, and clean as required.

Isocyanate can crystallize from moisture contamination or from freezing. If the chemicals used are clean and proper storage, transfer, and operating procedures are followed, there should be minimal contamination of the A-side screen.

### Note

Clean the A-side screen only during daily startup. This minimizes moisture contamination by immediately flushing out any isocyanate residue at the start of dispensing operations.

1. Close the fluid inlet valve at the pump inlet and shut off the appropriate feed pump. This prevents material from being pumped while cleaning the screen.
2. Place a container under the strainer base to catch drain off when removing the strainer plug (C).
3. Remove the screen (A) from the strainer manifold. Thoroughly flush the screen with

compatible solvent and shake it dry. Inspect the screen. No more than 25% of the mesh should be restricted. If more than 25% of the mesh is blocked, replace the screen. Inspect the gasket (B) and replace as required.

4. Ensure the pipe plug (D) is screwed into the strainer plug (C). Install the strainer plug with the screen (A) and o-ring (B) in place and tighten. Do not overtighten. Let the gasket make the seal.
5. Open the fluid inlet valve, ensure that there are no leaks, and wipe the equipment clean. Proceed with operation.

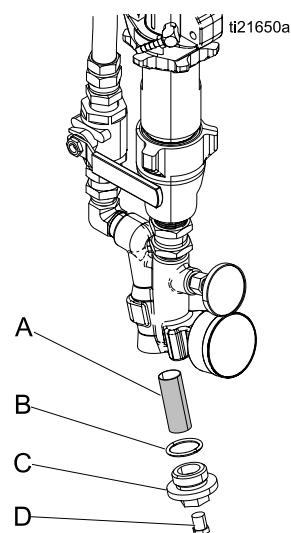

Figure 13

## Pump Lubrication System

Check the condition of the ISO pump lubricant daily. Change the lubricant if it becomes a gel, its color darkens, or it becomes diluted with isocyanate.

Gel formation is due to moisture absorption by the pump lubricant. The interval between changes depends on the environment in which the equipment is operating. The pump lubrication system minimizes exposure to moisture, but some contamination is still possible.

Lubricant discoloration is due to continual seepage of small amounts of isocyanate past the pump packings during operation. If the packings are operating properly, lubricant replacement due to discoloration should not be necessary more often than every 3 or 4 weeks.

To change pump lubricant:

1. Follow [Pressure Relief Procedure](#), page 52.
2. Lift the lubricant reservoir (R) out of the bracket and remove the container from the cap. Holding the cap over a suitable container, remove the check valve and allow the lubricant to drain. Reattach the check valve to the inlet hose.
3. Drain the reservoir and flush it with clean lubricant.
4. When the reservoir is flushed clean, fill with fresh lubricant.
5. Thread the reservoir onto the cap assembly and place it in the bracket.
6. The lubrication system is ready for operation. No priming is required.

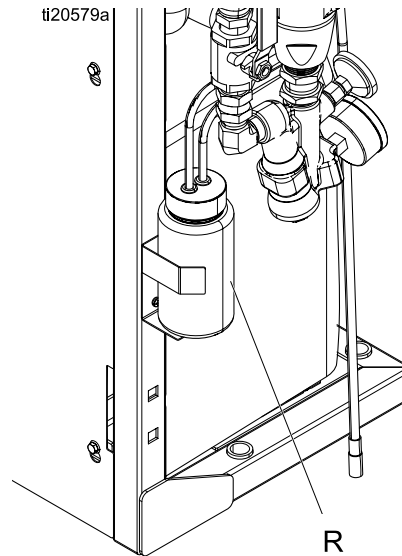

Pump Lubrication System  
Figure 14



# Errors

## View Errors

When an error occurs the error information screen displays the active error code and description.

The error code, alarm bell, and active errors will scroll in the status bar. For a list of the ten most recent errors see [Troubleshooting, page 58](#). Error codes are stored in the error log and displayed on the Error and Troubleshooting screens on the ADM.

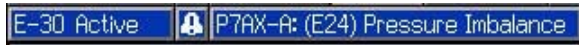

There are three types of errors that can occur. Errors are indicated on the display as well as by the light tower (optional).

Alarms are indicated by . This condition indicates a parameter critical to the process has reached a level requiring the system to stop. The alarm needs to be addressed immediately.

Deviations are indicated by . This condition indicates a parameter critical to the process has reached a level requiring attention, but not sufficient enough to stop the system at this time.

Advisories are indicated by . This condition indicates a parameter that is not immediately critical to the process. The advisory needs attention to prevent more serious issues in the future.

To diagnose the active error, see [Troubleshoot Errors, page 57](#).

## Troubleshoot Errors

To troubleshoot the error:

1. Press the soft key next to “Help With This Error” for help with the active error.

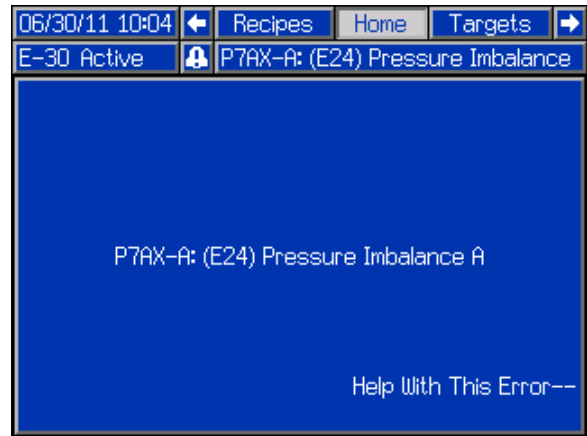

### Note

Press or to return to the previously displayed screen.

2. The QR code screen will be displayed. Scan the QR code with your smartphone to be sent directly to online troubleshooting for the active error code. Otherwise, manually navigate to <http://help.graco.com> and search for the active error.



3. If no internet connection is available, see [Error Codes and Troubleshooting, page 58](#) for causes and solutions for each error code.

# Troubleshooting

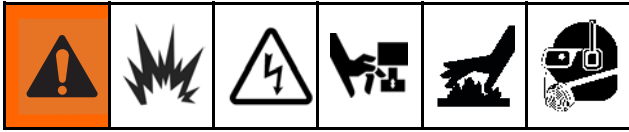

See [Errors, page 57](#) for information about errors that can occur on the system.

## Error Codes and Troubleshooting

See system repair manual or visit <http://help.graco.com> for causes and solutions to each error code.

See [Troubleshooting, page 38](#) for the ten most recent errors that have occurred on the system. See [Troubleshoot Errors, page 57](#) to diagnose errors on the ADM that have occurred on the system.

# USB Data

## Download Procedure

### Note

System configuration setting files and custom language files can be modified if the files are in the UPLOAD folder of the USB flash drive. See System Configuration Settings File, Custom Language File, and Upload Procedure sections.

1. Insert USB flash drive into USB port.
2. The menu bar and USB indicator lights indicate that the USB is downloading files. Wait for USB activity to complete.
3. Remove USB flash drive from USB port.
4. Insert USB flash drive into USB port of computer.
5. The USB flash drive window automatically opens. If it does not, open USB flash drive from within Windows® Explorer.
6. Open GRACO folder.
7. Instructions continue on next page.
8. Open the system folder. If downloading data from more than one system, there will be more than one folder. Each folder is labeled with the corresponding serial number of the ADM (The serial number is on the back of the ADM.)
9. Open DOWNLOAD folder.
10. Open DATAxxxx folder.
11. Open DATAxxxx folder labeled with the highest number. The highest number indicates the most recent data download.
12. Open log file. Log files open in Microsoft® Excel by default as long as the program is installed. However, they can also be opened in any text editor or Microsoft® Word.

### Note

All USB logs are saved in Unicode (UTF-16) format. If opening the log file in Microsoft Word, select Unicode encoding.

## USB Logs

### Note

The ADM can read/write to FAT (File Allocation Table) storage devices. NTFS, used by 32 GB or greater storage devices, is not supported.

During operation, the ADM stores system and performance related information to memory in the form of log files. The ADM maintains six log files:

- Event Log
- Job Log
- Daily Log
- System Software Log
- Blackbox Log
- Diagnostics Log

Follow [Download Procedure, page 59](#), to retrieve log files.

Each time a USB flash drive is inserted into the ADM USB port, a new folder named DATAxxxx is created. The number at the end of the folder name increases each time a USB flash drive is inserted and data is downloaded or uploaded.

### Event Log

The event log file name is 1-EVENT.CSV and is stored in the DATAxxxx folder.

The event log maintains a record of the last 49,000 events and errors. Each event record contains:

- Date of event code
- Time of event code
- Event code
- Event type
- Action taken
- Event Description

Event codes include both error codes (alarms, deviations, and advisories) and record only events.

Actions Taken includes setting and clearing event conditions by the system, and acknowledging error conditions by the user.

## Job Log

The job log file name is 2-JOB.CSV and is stored in the DATAxxxx folder.

The job log maintains a record of data points based on the USB Log Frequency defined in the Setup screens. The ADM stores the last 237,000 data points for download. See [Setup - Advanced Screen 3 — USB, page 33](#), for information on setting the Download Depth and USB Log Frequency.

- Data point date
- Data point time
- A side temperature
- B side temperature
- Hose temperature
- A side temperature setpoint
- B side temperature setpoint
- Hose temperature setpoint
- A side inlet pressure
- B side inlet pressure
- Inlet pressure setpoint
- System lifetime pump cycle counts
- Pressure, volume, and temperature units
- Job name/number

## Daily Log

The daily log file name is 3-DAILY.CSV and is stored in the DATAxxxx folder.

The daily log maintains a record of the total cycle and volume sprayed on any day that the system is powered up. The volume units will be the same units that were used in the Job Log.

The following data is stored in this file:

- Date that material was sprayed
- Time — unused column
- Total pump cycle count for day
- Total volume sprayed for day

## System Software Log

The system software file name is 4-SYSTEM.CSV and is stored in the DATAxxxx folder.

The system software log lists the following:

- Date log was created
- Time log was created
- Component name
- Software version loaded on the above component

## Blackbox Log File

The black box file name is 5-BLACKB.CSV and is stored in the DATAxxxx folder.

The Blackbox log maintains a record of how the system runs and the features that are used. This log will help Graco troubleshoot system errors.

## Diagnostics Log File

The diagnostics file name is 6-DIAGNO.CSV and is stored in the DATAxxxx folder.

The Diagnostics log maintains a record of how the system runs and the features that are used. This log will help Graco troubleshoot system errors.

## System Configuration Settings

The system configuration settings file name is SETTINGS.TXT and is stored in the DOWNLOAD folder.

A system configuration settings file automatically downloads each time a USB flash drive is inserted into the ADM. Use this file to back up system settings for future recovery or to easily replicate settings across multiple systems. Refer to the [Upload Procedure, page 61](#) for instructions on how to use this file.

## Custom Language File

The custom language file name is DISPTEXT.TXT and is stored in the DOWNLOAD folder.

A custom language file automatically downloads each time a USB flash drive is inserted into the ADM. If desired, use this file to create a user-defined set of custom language strings to be displayed within the ADM.

The system is able to display the following Unicode characters. For characters outside of this set, the system will display the Unicode replacement character, which appears as a white question mark inside of a black diamond.

- U+0020 - U+007E (Basic Latin)
- U+00A1 - U+00FF (Latin-1 Supplement)
- U+0100 - U+017F (Latin Extended-A)
- U+0386 - U+03CE (Greek)
- U+0400 - U+045F (Cyrillic)

### Create Custom Language Strings

The custom language file is a tab-delimited text file that contains two columns. The first column consists of a list of strings in the language selected at the time of download. The second column can be used to enter the custom language strings. If a custom language was previously installed, this column contains the custom strings. Otherwise the second column is blank.

Modify the second column of the custom language file as needed and the follow [Upload Procedure, page 61](#), to install the file.

The format of the custom language file is critical. The following rules must be followed in order for the installation process to succeed.

- Define a custom string for each row in the second column.

#### Note

If the custom language file is used, you must define a custom string for each entry in the DISPTEXT.TXT file. Blank second-column fields will be displayed blank on the ADM.

- The file name must be DISPTEXT.TXT.

- The file format must be a tab-delimited text file using Unicode (UTF-16) character representation.
- The file must contain only two columns, with columns separated by a single tab character.
- Do not add or remove rows to the file.
- Do not change the order of the rows.

## Upload Procedure

Use this procedure to install a system configuration file and/or a custom language file.

1. If necessary, follow the **Download Procedure** to automatically generate the proper folder structure on the USB flash drive.
2. Insert USB flash drive into USB port of computer.
3. The USB flash drive window automatically opens. If it does not, open USB flash drive from within Windows Explorer.
4. Open GRACO folder.
5. Open the system folder. If working with more than one system, there will be more than one folder within the GRACO folder. Each folder is labeled with the corresponding serial number of the ADM. (The serial number is on the back of the module.)
6. If installing the system configuration settings file, place SETTINGS.TXT file into the UPLOAD folder.
7. If installing the custom language file, place DISPTEXT.TXT file into the UPLOAD folder.
8. Remove USB flash drive from the computer.
9. Install USB flash drive into the ADM USB port.
10. The menu bar and USB indicator lights indicate that the USB is downloading files. Wait for USB activity to complete.
11. Remove USB flash drive from USB port.

#### Note

If the custom language file was installed, users can now select the new language from the Language drop-down menu in [Advanced Screen 1 — General, page 33](#).

# Performance Charts

Use these charts to help identify the proportioner that will work most efficiently with each mix chamber. Flow rates are based on a material viscosity of 60 cps.

**NOTICE**  
To prevent system damage, do not pressurize the system above the line for the gun tip size being used.

## Proportioners For Foam

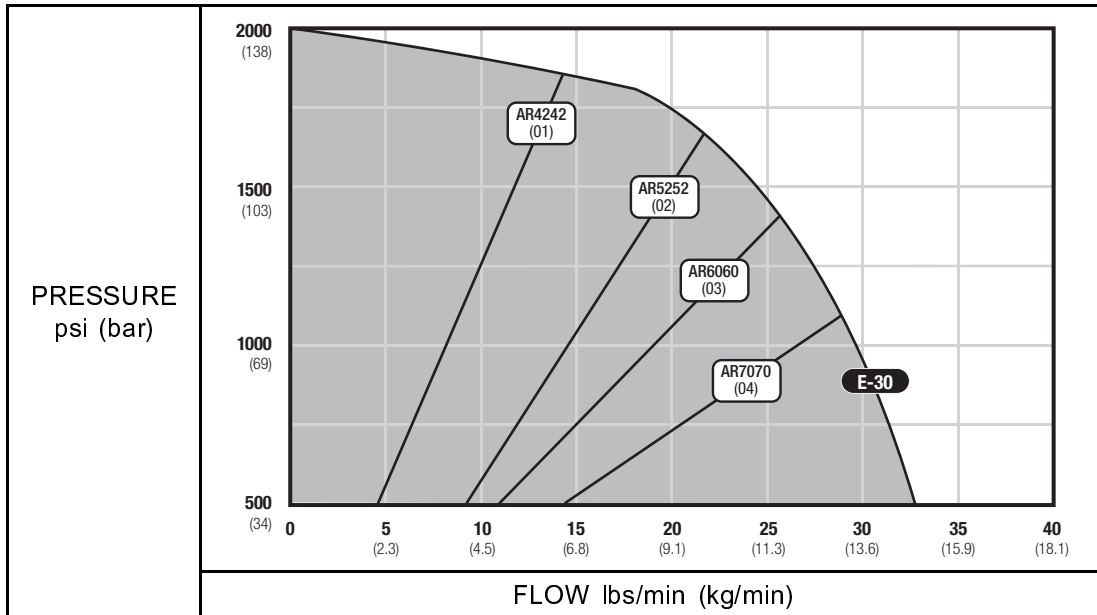

## Proportioners For Coatings

Table 5 Fusion Air Purge, Round Pattern

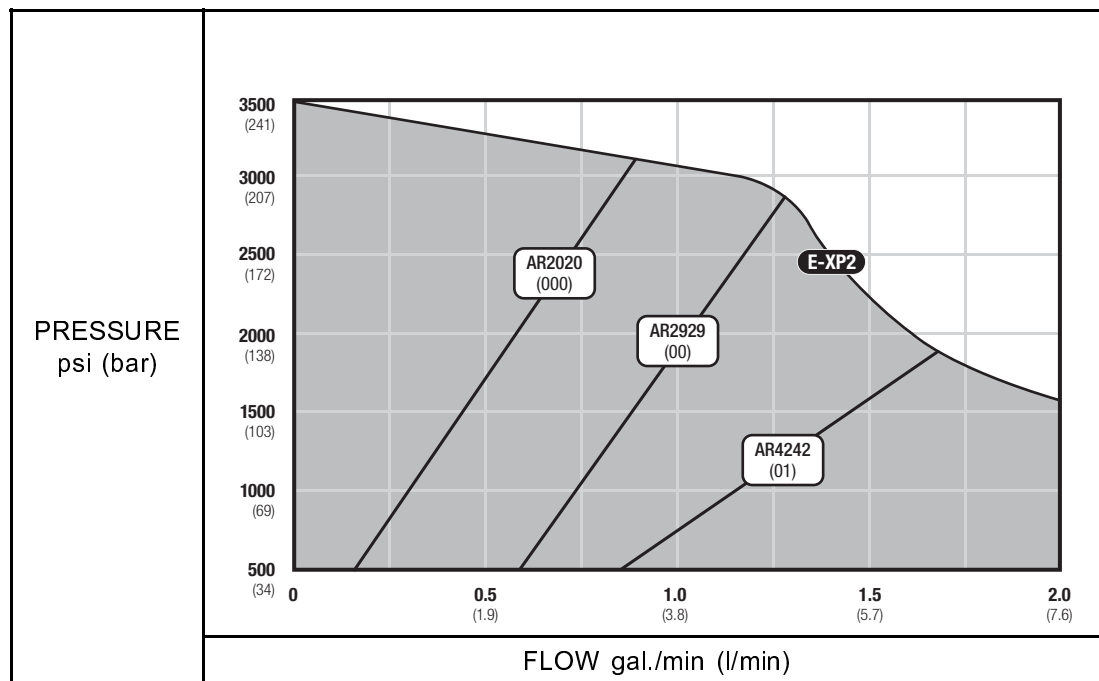
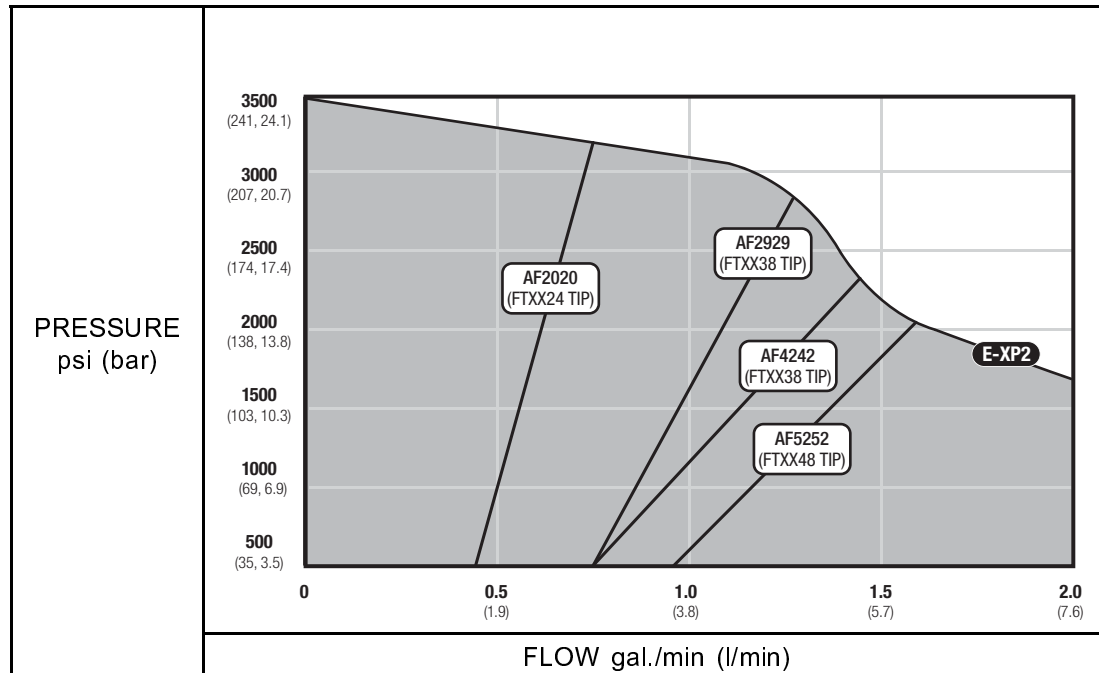

Table 6 Fusion Air Purge, Flat Pattern



Performance Charts

Table 7 Fusion Mechanical Purge, Round Pattern

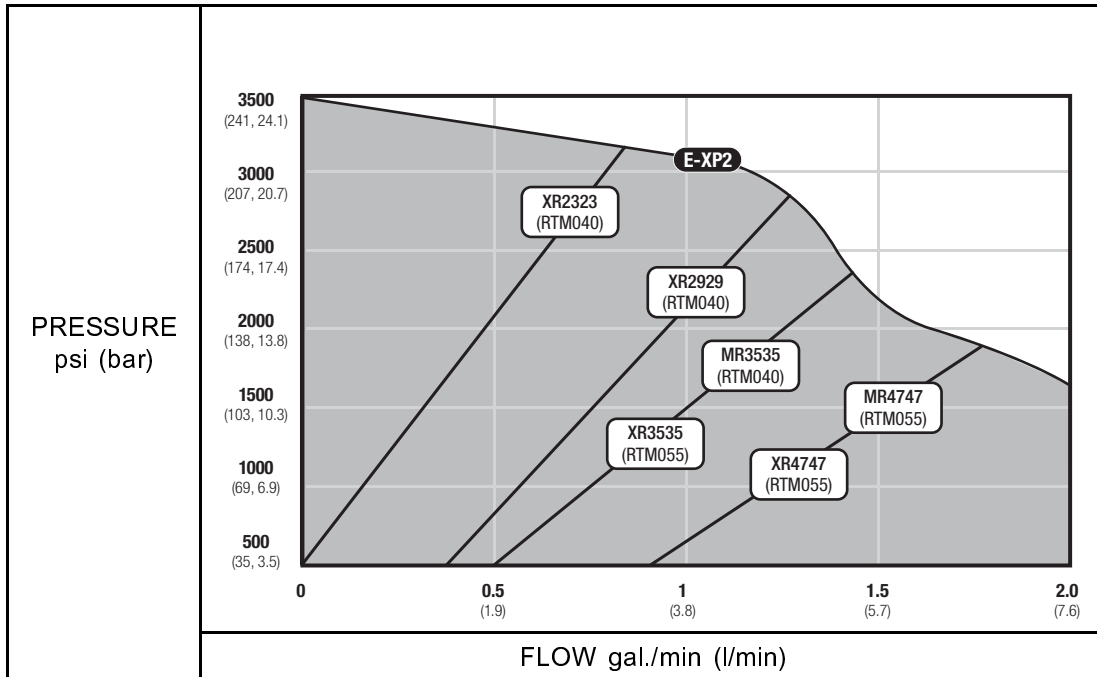
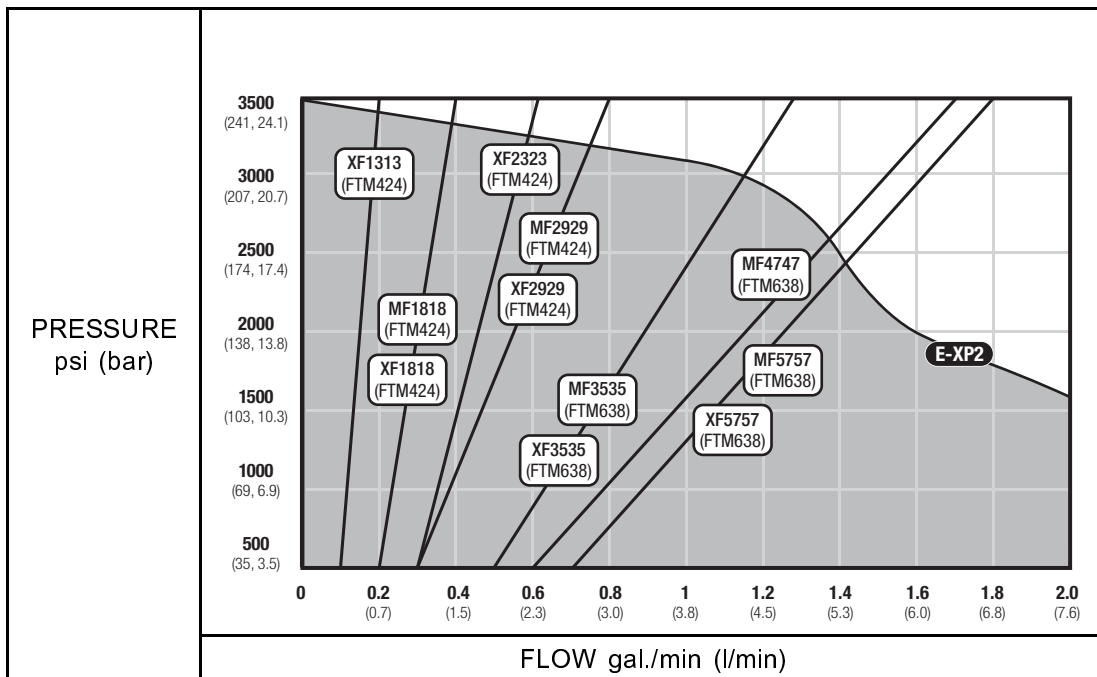

Table 8 Fusion Mechanical Purge, Flat Pattern





# Technical Specifications

Reactor 2 E-30 and E-XP2 Proportioning System		
	U.S.	Metric
<b>Maximum Fluid Working Pressure</b>		
E-30	2000 psi	14 MPa, 140 bar
E-XP2	3500 psi	24.1 MPa, 241 bar
<b>Maximum Fluid Temperature</b>		
E-30	190°F	88°C
E-XP2	190°F	88°C
<b>Maximum Flow Rate</b>		
E-30	30 lb/min	13.5 kg/min
E-XP2	2 gpm	7.6 lpm
<b>Maximum Heated Hose Length</b>		
Length	310 ft	94 m
<b>Output per Cycle</b> <i>ISO and RES</i>		
E-30	0.0272 gal.	0.1034 liter
E-XP2	0.0203 gal.	0.0771 liter
<b>Operating Ambient Temperature Range</b>		
Temperature	20° to 120°F	-7° to 49°C
<b>Line Voltage Requirement</b>		
Nominal 200–240 VAC, 1 Phase, 50/60 Hz	195–265 VAC	
Nominal 200–240 VAC, 3 phase, DELTA, 50/60 Hz	195–265 VAC	
Nominal 350–415 VAC, 3 phase, WYE, 50/60 Hz	340–455 VAC	
<b>Heater Power</b> <i>(at 230 VAC rated voltage)</i>		
E-30 10 kW	10,200 Watts	
E-30, 15 kW	15,300 Watts	
E-XP2 15 kW	15,300 Watts	

Technical Specifications

Sound Pressure		
<i>Sound Pressure measured per ISO-9614-2.</i>		
E-30 <i>Measured from 3.1 ft (1 m), at 1000 psi (7 MPa, 70 bar), 3 gpm (11.4 lpm)</i>	87.3 dBA	
E-XP2 <i>Measured from 3.1 ft (1 m), at 3000 psi (21 MPa, 207 bar), 1 gpm (3.8 lpm)</i>	79.6 dBA	
Sound Power		
E-30 <i>Measured from 3.1 ft (1 m), at 1000 psi (7 MPa, 70 bar), 3 gpm (11.4 lpm)</i>	93.7 dBA	
E-XP2 <i>Measured from 3.1 ft (1 m), at 3000 psi (21 MPa, 207 bar), 1 gpm (3.8 lpm)</i>	86.6 dBA	
Fluid Inlets		
Component A (ISO) and Component B (RES)	3/4 NPT(f) with 3/4 NPSM(f) union	
Fluid Outlets		
Component A (ISO)	#8 (1/2 in.) JIC, with #5 (5/16 in.) JIC adapter	
Component B (RES)	#10 (5/8 in.) JIC, with #6 (3/8 in.) JIC adapter	
Fluid Circulation Ports		
Size	1/4 NPSM(m)	
Maximum Pressure	250 psi	1.75 MPa, 17.5 bar
Dimensions		
Width	26.3 in.	668 mm
Height	63 in.	1600 mm
Depth	15 in.	381 mm
Weight		
E-30, 10 kW	315 lb	143 kg
E-30, 15 kW	350 lb	159 kg
E-30, 10 kW Elite	320 lb	145 kg
E-30, 15 kW Elite	355 lb	161 kg
E-XP2	345 lb	156 kg
E-XP Elite	350 lb	159 kg
Wetted Parts		
Material	Aluminum, stainless steel, zinc plated carbon steel, brass, carbide, chrome, chemically resistant o-rings, PTFE, ultra-high molecular weight polyethylene	

# Graco Extended Warranty for Reactor® 2 Components

Graco warrants all equipment referenced in this document which is manufactured by Graco and bearing its name to be free from defects in material and workmanship on the date of sale to the original purchaser for use. With the exception of any special, extended, or limited warranty published by Graco, Graco will, for a period of twelve months from the date of sale, repair or replace any part of the equipment determined by Graco to be defective. This warranty applies only when the equipment is installed, operated and maintained in accordance with Graco's written recommendations.

Graco Part Number	Description	Warranty Period
24U050	Electric Motor	36 Months or 3 Million Cycles
24U051	Electric Motor	36 Months or 3 Million Cycles
24U831	Motor Control Module	36 Months or 3 Million Cycles
24U832	Motor Control Module	36 Months or 3 Million Cycles
24U855	Heater Control Module	36 Months or 3 Million Cycles
24U854	Advanced Display Module	36 Months or 3 Million Cycles
All other Reactor 2 parts		12 Months

This warranty does not cover, and Graco shall not be liable for general wear and tear, or any malfunction, damage or wear caused by faulty installation, misapplication, abrasion, corrosion, inadequate or improper maintenance, negligence, accident, tampering, or substitution of non-Graco component parts. Nor shall Graco be liable for malfunction, damage or wear caused by the incompatibility of Graco equipment with structures, accessories, equipment or materials not supplied by Graco, or the improper design, manufacture, installation, operation or maintenance of structures, accessories, equipment or materials not supplied by Graco.

This warranty is conditioned upon the prepaid return of the equipment claimed to be defective to an authorized Graco distributor for verification of the claimed defect. If the claimed defect is verified, Graco will repair or replace free of charge any defective parts. The equipment will be returned to the original purchaser transportation prepaid. If inspection of the equipment does not disclose any defect in material or workmanship, repairs will be made at a reasonable charge, which charges may include the costs of parts, labor, and transportation.

**THIS WARRANTY IS EXCLUSIVE, AND IS IN LIEU OF ANY OTHER WARRANTIES, EXPRESS OR IMPLIED, INCLUDING BUT NOT LIMITED TO WARRANTY OF MERCHANTABILITY OR WARRANTY OF FITNESS FOR A PARTICULAR PURPOSE.**

Graco's sole obligation and buyer's sole remedy for any breach of warranty shall be as set forth above. The buyer agrees that no other remedy (including, but not limited to, incidental or consequential damages for lost profits, lost sales, injury to person or property, or any other incidental or consequential loss) shall be available. Any action for breach of warranty hereunder must be brought within the latter of two (2) years of the date of sale, or one (1) year the warranty period expires.

**GRACO MAKES NO WARRANTY, AND DISCLAIMS ALL IMPLIED WARRANTIES OF MERCHANTABILITY AND FITNESS FOR A PARTICULAR PURPOSE, IN CONNECTION WITH ACCESSORIES, EQUIPMENT, MATERIALS OR COMPONENTS SOLD BUT NOT MANUFACTURED BY GRACO.** These items sold, but not manufactured by Graco (such as electric motors, switches, hose, etc.), are subject to the warranty, if any, of their manufacturer. Graco will provide purchaser with reasonable assistance in making any claim for breach of these warranties.

In no event will Graco be liable for indirect, incidental, special or consequential damages resulting from Graco supplying equipment hereunder, or the furnishing, performance, or use of any products or other goods sold hereto, whether due to a breach of contract, breach of warranty, the negligence of Graco, or otherwise.

## FOR GRACO CANADA CUSTOMERS

The Parties acknowledge that they have required that the present document, as well as all documents, notices and legal proceedings entered into, given or instituted pursuant hereto or relating directly or indirectly hereto, be drawn up in English. Les parties reconnaissent avoir convenu que la rédaction du présente document sera en Anglais, ainsi que tous documents, avis et procédures judiciaires exécutés, donnés ou intentés, à la suite de ou en rapport, directement ou indirectement, avec les procédures concernées.

## **Graco Information**

For the latest information about Graco products, visit [www.graco.com](http://www.graco.com).

To place an order, contact your Graco Distributor or call to identify the nearest distributor.

**Phone:** 612-623-6921 or **Toll Free:** 1-800-328-0211 **Fax:** 612-378-3505

All written and visual data contained in this document reflects the latest product information available at the time of publication.

Graco reserves the right to make changes at any time without notice.

For patent information, see [www.graco.com/patents](http://www.graco.com/patents).

Original Instructions. This manual contains English. MM 333023

**Graco Headquarters:** Minneapolis

**International Offices:** Belgium, China, Japan, Korea

**GRACO INC. AND SUBSIDIARIES • P.O. BOX 1441 • MINNEAPOLIS MN 55440-1441 • USA**

Copyright 2014, Graco Inc. All Graco manufacturing locations are registered to ISO 9001.

[www.graco.com](http://www.graco.com)

Revision F, February 2015