

# Set / Reset Point Pressure Switch

3A1827B

ENG

Set and reset point pressure switch used to detect pressure changes.

Not approved for use in European explosive atmospheres.

## Models: 24K414

Equivalent: IFM Electronic GMBH PK6220

Maximum Working Pressure: 5800 psi (400 bar, 40 MPa)





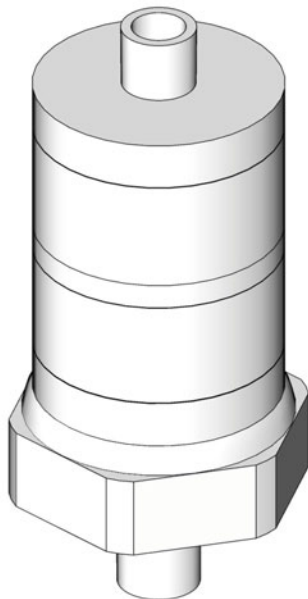

### Important Safety Instructions

Read all warnings and instructions in this manual and the instructions included with your operating system or pump. Save these instructions.



## Warnings

The following warnings are for the setup, use, grounding, maintenance, and repair of this equipment. The exclamation point symbol alerts you to a general warning and the hazard symbols refer to procedure-specific risks. When these symbols appear in the body of this manual, refer back to these Warnings. Product-specific hazard symbols and warnings not covered in this section may appear throughout the body of this manual where applicable.

 <b>WARNING</b>	
	<p><b>ELECTRIC SHOCK HAZARD</b></p> <p>This equipment must be grounded. Improper grounding, setup, or usage of the system can cause electric shock.</p> <ul style="list-style-type: none"> <li>• Turn off and disconnect power at main switch before disconnecting any cables and before servicing equipment.</li> <li>• Connect only to grounded power source.</li> <li>• All electrical wiring must be done by a qualified electrician and comply with all local codes and regulations.</li> </ul>
 	<p><b>SKIN INJECTION HAZARD</b></p> <p>High-pressure fluid from dispense device, hose leaks, or ruptured components will pierce skin. This may look like just a cut, but it is a serious injury that can result in amputation. <b>Get immediate surgical treatment.</b></p> <ul style="list-style-type: none"> <li>• Do not point dispense device at anyone or at any part of the body.</li> <li>• Do not put your hand over the fluid outlet.</li> <li>• Do not stop or deflect leaks with your hand, body, glove, or rag.</li> <li>• Follow <b>Pressure Relief Procedure</b> in this manual, when you stop dispensing and before cleaning, checking, or servicing equipment.</li> <li>• Tighten all fluid connections before operating the equipment.</li> <li>• Check hoses and couplings daily. Replace worn or damaged parts immediately.</li> </ul>

# Pressure Relief Procedure



**Relieve pressure** in the system following the procedure recommended for your operating system or pump.

## Installation

NOTICE
<ul style="list-style-type: none"> <li>Electrical ratings must not be exceeded. Overload on a switch can cause switch to fail on the first cycle.</li> <li>Never exceed pressure limits. Unit can be operated up to maximum pressure on a limited basis (i.e., set-up, testing) but continuous operation must be restricted to the designated adjustable range. Excessive cycling at maximum pressure limits could reduce sensor life.</li> </ul>

1. Disconnect power to pump.
2. Disconnect cable from switch.
3. If replacing a pressure switch on an existing installation, relieve pressure.
4. Locate unit where shock, vibration and ambient temperature fluctuations are minimal. Do not mount in ambient temperature areas exceeding 160°F (71°C).
  - Unit may be mounted in any position. However, if installation location results in frequent exposure to liquid it is recommended that the unit be mounted vertically with the pressure connection down.
5. Screw switch into manifold. Always use a wrench on pressure connection wrench flats.
6. Test unit before use.

## Adjustments

1. Rotate the top portion of switch (with the lock and unlock symbols) to align the unlock symbol with the two white arrows (FIG. 1).

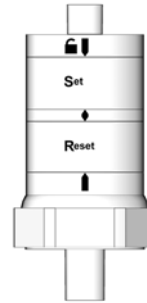

FIG. 1

2. Adjust set point to the desired pressure setting. 2500 psi (172 bar, 17.2 MPa) is the factory default setting.
3. Adjust the reset point to the desired pressure setting. 500 psi (35 bar, 3.5 MPa) is the factory default setting.
4. Rotate the top portion of the switch to align the lock symbol with the two white arrows (FIG. 2).

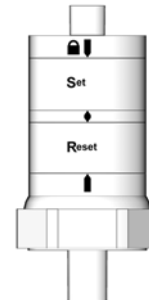

FIG. 2

5. Recheck set point and reset point and install switch according to installation instructions.

## Status LED's

Steady Green LED	Power is supplied to pressure switch.
Yellow LED turns off and on	When you reach pressure, yellow LED lights. When pressure drops below reset value, yellow LED turns off.

# Troubleshooting

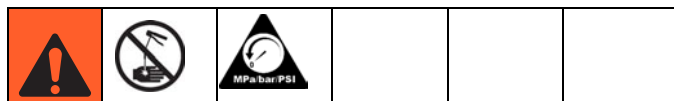

Problem	Cause	Solution
In an injector installation only, pressure switch activates before all injectors fire	Pressure switch is installed at the wrong location	Verify pressure switch is correctly installed - downstream from a bank of injectors
	Pressure switch is not set to a high enough reset point	Verify pressure switch is set sufficiently high at a level above the firing point of the injectors and within the margin for error.
Another pressure switch or pressure gauge on the system reads different than the pressure switch	Pressure switch is installed at the wrong location	Verify pressure switch is correctly installed - downstream from a bank of injectors
	Pressure switch is not set to a high enough reset point	Verify pressure switch is set sufficiently high at a level above the firing point of the injectors and within the margin for error.
After all injectors have reset, the pressure switch does not deactivate	The Reset point is set too low	Turn the reset point to a higher setting. Then verify the system is functioning correctly.
The pressure switch seems to be operating backwards	Normally Open and Normally Closed outputs not completing connection	Check the Normally Open and Normally Closed outputs and make sure the proper connection is made. Adjust connection as needed.
Power is supplied to the pressure switch but the switch is no longer sensing pressure	Grease soap has accumulated in the sensing orifice.	<ol style="list-style-type: none"> <li>1. Attempt to lower the pressure switch set point to verify the switch is not sensing any pressure.</li> <li>2. After verifying the pressure switch is not sensing pressure, remove the switch from the port.</li> <li>3. Using a non-metallic tool, clean out the sensing orifice.</li> <li>4. Reinstall the switch in the port.</li> <li>5. Retest.</li> </ol>

# Technical Data

Electrical Design	DC PNP
Output	Normally open / closed complimentary
Operating Voltage	9.6 - 32 VDC
Ambient Temperature Range	-13° to 176°F (-25° to 80°C)
Storage Temperature	-40° to 212°F (-40° to 100°C)
Current Rating	500 mA
Voltage Drop	<2.0 V
Current Consumption	<25 mA
Set Point Range	290 - 5800 psi (20 - 400 bar; 2.07 - 40 MPa)
Reset Point Range	175 - 5685 psi (12 - 392 bar; 1.2 - 39 MPa)
Switch point accuracy	< ± 2.5% Full range
Repeatability	< ± 0.5% Full range
Termination Type	1/4 NPT
Connection	M12
Display	
Power Indicator	LED green
Switching Status Indicator	LED yellow
Wetted Parts	stainless steel 316L/1.4404
Weight	3.2 oz (0.092 kg)
Enclosure	(Ingression Protection) IP67

## Dimensions

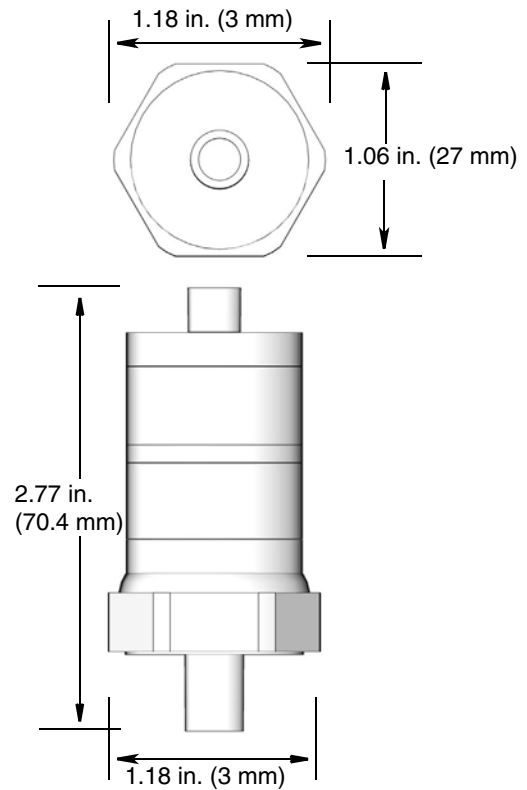

## Wiring Diagram

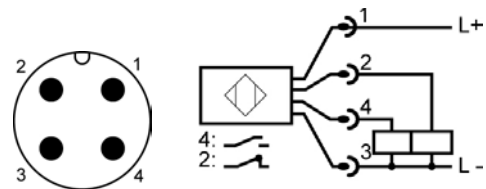

# Graco Information

**TO PLACE AN ORDER**, contact your Graco distributor or call to identify the nearest distributor.  
**Phone:** 612-623-6928 or **Toll Free:** 1-800-533-9655, **Fax:** 612-378-3590

*All written and visual data contained in this document reflects the latest product information available at the time of publication.  
 Graco reserves the right to make changes at any time without notice.*

*Original Instructions. This manual contains English. MM 3A1827*

**Graco Headquarters:** Minneapolis

**International Offices:** Belgium, China, Japan, Korea

**GRACO INC. P.O. BOX 1441 MINNEAPOLIS, MN 55440-1441**

Copyright 2011, Graco Inc. is registered to ISO 9001

www.graco.com

6/2011