



Grandstream Networks, Inc.

GXV3175 V2

IP Multimedia Phone



GXV3175 User Manual

Index

WELCOME	6
<i>GXV3175 OVERVIEW.....</i>	6
PRODUCT OVERVIEW	8
INSTALLATION	11
EQUIPMENT PACKAGING	11
<i>SAFETY COMPLIANCES.....</i>	11
<i>WARRANTY</i>	12
CONNECTING THE GXV3175 IP MULTIMEDIA PHONE.....	12
<i>WALL MOUNT.....</i>	13
<i>PHONE STAND.....</i>	13
<i>CONNECTING THE GXV3175 IP MULTIMEDIA PHONE.....</i>	14
<i>WELCOME SETUP GUIDE.....</i>	14
<i>MAKING THE FIRST CALL WITH IPVIDEOTALK SERVICE</i>	17
USING THE GXV3175 IP MULTIMEDIA PHONE.....	18
LCD.....	18
MULTIPLE SIP ACCOUNTS AND LINES.....	23
HANDSET, SPEAKER AND HEADSET MODE.....	24
MAKING A CALL.....	24
DURING CALLS	27
<i>ANSWERING CALLS</i>	27
<i>CALL FUNCTION OPTIONS.....</i>	29
<i>CALL HOLD.....</i>	30
<i>CALL TRANSFER</i>	31
<i>3-WAY CONFERENCE</i>	33
<i>VOICEMAIL (MESSAGE WAITING INDICATION)</i>	34
<i>MUTE.....</i>	34
KEYPAD INPUT	35
CALL FEATURES	36
GXV3175 WEB CONFIGURATION INTERFACE.....	37
ACCESSING THE WEB CONFIGURATION PAGES	38



DEFINITIONS	38
<i>STATUS PAGE DEFINITIONS</i>	39
<i>ADVANCED SETTINGS PAGE DEFINITIONS</i>	40
<i>MAINTENANCE PAGE DEFINITIONS</i>	42
<i>SIP ACCOUNT CONFIGURATION PAGE DEFINITIONS</i>	49
SAVING THE CONFIGURATION CHANGES.....	54
REBOOTING FROM REMOTE LOCATIONS.....	54
CUSTOMIZING THE GXV3175 IP MULTIMEDIA PHONE	55
XML GUI CUSTOMIZATION GUIDE	55
GMI GUIDE	55
SOFTWARE UPGRADE.....	56
UPGRADE VIA MENU	56
UPGRADE VIA WEB BROWSER CONFIGURATION PAGE.....	56
NO LOCAL TFTP SERVERS.....	57
RESTORE FACTORY DEFAULT SETTINGS.....	57
RESTORE TO FACTORY DEFAULT SETTINGS VIA LCD MENU	57
RESTORE TO FACTORY DEFAULT SETTINGS VIA THE WEB INTERFACE	58
EXPERIENCING THE GXV3175 MULTIMEDIA PHONE	59

TABLE OF TABLES
GXV3175 USER MANUAL

Table 1 :Key Features	8
Table 2: GXV3175 Hardware Specification	8
Table 3: GXV3175 Technical Specifications.....	8
Table 4: GXV3175 Ports and Interface	12
Table 5: LCD Icon Definition.....	21
Table 6: GXV3175 Dialpad Definition.....	23
Table 7: GXV3175 Call Function Description.....	30
Table 8: GXV3175 Keypad Definition.....	35
Table 9 :GXV3175 Call Features	36
Table 10: GXV3175 Audio/Video Codec Feature Code	36

WELCOME

Thank you for purchasing Grandstream GXV3175 IP Multimedia Phone. GXV3175 IP Multimedia Phone represents the future in personal IP multimedia communication as the ultimate desktop multimedia phone. You will experience a brand-new exploration with GXV3175's 7" touch screen color LCD, plug-and-play access to free real-time video/voice call, always-on Internet web entertainment and social networking applications.

This user manual is designed to help you configure and manage GXV3175 IP Multimedia Phone. Besides demonstrating how to install the unit with ease, this manual will explain how to fully utilize the entire phone's voice and video call features like conference call, direct IP call as well as explore all the built-in feature-rich multimedia applications such as YouTube, Google Voice, Flickr and more.

GXV3175 OVERVIEW

The GXV3175 is an ideal desktop IP multimedia phone highlighting 7" touch screen color LCD, tilt capable



1.3M CMOS camera, integrated Wifi, comprehensive auxiliary ports, feature-rich web applications with novel streamline design and modeling. It supports a high quality selection of audio codecs and is compatible with the H.264/H.263/H.263+ video codec. The advanced telephony and video features, interoperability with 3rd party SIP products and ease of use make it an innovative and unique IP multimedia device for both enterprise and consumer users.

Once the GXV3175 is plugged into the broadband Internet connection, you can begin to make video calls with impressive clarity and enjoy other features of the multimedia phone including:

- Integrated web browser for one-touch access to personalized RSS feeds of real-time online information services (news videos, stock and currency updates, weather forecasts and etc.)
- Access to thousands of Internet radio stations and popular online music networks such as Last.fm
- Access to social networking sites such as Google Voice and web photo albums like Yahoo Flickr
- Access to streaming Internet entertainment sites including YouTube and Movie Trailer
- Access to more than 6 built-in games featuring the touch screen operation
- Digital Photo Frame
- Full duplex speakerphone
- Ability to project video onto TV

CAUTION: Changes or modifications to this product not expressly approved by Grandstream, or operation of this product in any way other than as detailed by this User Manual, could void your manufacturer warranty.

- *This document is subject to change without notice. The latest electronic version of this user manual is available for downloading here:*

[GXV3175 User Manual](#)(Download)

- *Reproduction or transmittal of the entire or any part, in any form or by any means, electronic or print, for any purpose without the written permission of Grandstream Networks, Inc. is not permitted.*

PRODUCT OVERVIEW

Table 1: Key Features

Open Compatible Standards	SIP 2.0, TCP/IP/UDP, RTP/RTCP, HTTP/HTTPS, ARP/RARP, ICMP, DNS (A record and SRV), DHCP, PPPoE, TFTP, NTP.
Interfaces	2 x 10/100Mbps Ethernet Ports with integrated PoE, 2 x USB (2.0) port, 3.5mm stereo headset port, SD Card slot, built-in WiFi(b/g/n).
Extraordinary Audio Quality	Advanced DSP for audio, Silence Suppression, VAD, CNG, AEC and AGC.
Extraordinary Video Quality	Real-time video H.263/H.263+ and H.264 codec even when operating under low bandwidth (32kbps-1Mbps).
Advanced Video Features	7" resistive touch screen LCD with 800 x 480 resolution, 45 degree rotating lens (perpendicular), Advanced VGA lens, auto focus, auto exposure, zoom in and zoom out (2x optical 2x digital) , Camera Block, PIP(Picture-in-Picture) and still picture capture/store.

Application Features	<ul style="list-style-type: none"> - Traditional audio features: Caller ID, Call Waiting, Call Holding, Call Transfer, Three-way Conference, Do-Not-Disturb, Mute, Automatic dial. - Application features: Built-in Web Browser, RSS News, Weather Forecast, Internet Radio, Media Player, Picture Viewer, Games, Calculator, Alarm clock, File Manager, Youtube, Google Voice, Facebook, Twitter and etc.
----------------------	--

Table 2: GXV3175 Hardware Specification

Ethernet Port	Dual switched 10M/100M auto-sensing Ethernet ports.
LCD	800 x 480 resistive touch screen LCD.
Camera	Tilt Capable 2.0M pixel CMOS camera with privacy shutter (VGA).
Auxiliary Ports	RCA Type Stereo and Media output port, 3.5mm stereo headset port, 2 x USB port, SD card slot.
Exterior	Black ABS plastic, Flat Panel with 1 x home button, two-angle stand.
Universal Power Supply	<ul style="list-style-type: none"> Input: 100-240V AC Output: 12V DC, 1.5A US/Euro/UK/Australian style plug available.
Dimension	243.5mm x 168mm x 36mm.
Weight	1.04kg (phone with handset and stand), 1.95kg (package weight).
Operating Temperature	32° F - 104° F/0° C - 40° C.
Humidity	10%-90% Non-Condensing.
Compliance	FCC/CE/C-Tick.

Table 3: GXV3175 Technical Specifications

Lines	Three individual SIP accounts.
Protocol Support	SIP 2.0, UDP/IP, PPPoE, RTP/RTCP, SRTP by SDES, HTTP, ARP/RARP, ICMP, DNS, DHCP, NTP/SNTP, TFTP.
Display	7" resistive touch screen LCD with 800 x 480 resolution.
Network Interfaces	Dual switched 10M/100M auto-sensing Ethernet ports, 2 x USB 2.0 port, 1 x audio/video output port (to synchronize output video to TV), stereo headset jack.
Device Management	Layer 2 QoS (IEEE 802.1p/Q tagging-VLAN) and Layer 3 QoS (ToS, DiffServ, MPLS), web interface or via secure (AES encrypted) central configuration file for mass deployment, auto/manual provisioning system, remote software (TFTP/HTTP/HTTPS) upgrade for deployed devices including those behind NAT/firewall.
Provisioning	<ul style="list-style-type: none"> - Support for automatic NAT/firewall traversal and remote automatic software upgrade and security, providing end-users with "zero configuration" and true "plug-and-play" functionality. - Support for remote configuration monitoring and syslog.

	<ul style="list-style-type: none"> - Configuration through LCD, web browser or an external configuration file. - Support for IETF STUN NAT traversal and symmetric RTP, Static IP or DHCP.
Audio Features	<ul style="list-style-type: none"> - HD handset and full duplex speaker, advanced DSP. - Supports G.723.1, G.729A/B, G.711μ/A (PCMU/PCMA), G.726-32, G.722, GSM-FR, L15-256 DTMF (In-audio, RFC2833, SIP Info); Silence suppression, VAD, CNG, AGC, masking for packet loss/delay; AEC, AGC for Speaker; jitter buffer protocol.
Video Features	<ul style="list-style-type: none"> - Support for Jitter Buffer delay and packet loss concealment to enhance audio and video quality. - Support for H.263/H.263+ and H.264 real-time video codecs (WQVGA, QQVGA, QCIF, QVGA, WQVGA, CIF, VGA, 4CIF) up to 30frames/sec, which ensures high quality video transmission even under low bandwidth conditions (32kbps-1Mbps). - 7" resistive touch screen LCD with 800 x 480 resolution, 45 degree rotating lens (perpendicular), advanced VGA CMOS camera and sensor. - Anti-flickering of images, auto focus, auto exposure, zoom (2x optical 2x digital), PIP(Picture-in-Picture) , audio mute, camera block, call log, video phone book, screensaver, still picture capture/store (VGA) and visual voice message indicator.
Call Handling Features	<p>Caller ID, call waiting ID, call waiting/flash, call transfer, call holding, call forwarding, Do-Not-Disturb, three-way conference, redial, automatic dialing on off-hook, automatic answering, call records, volume control, voice message waiting indicator, downloadable custom ring tone, switchable handset/headset/speaker during call.</p>
Caller ID (Privacy)	<p>Private header support for anonymous calls.</p>
Firmware Upgrade	<ul style="list-style-type: none"> - Configuration file authentication (before accepting changes). - TFTP/HTTP/HTTPS upgrade support, allows users to specify different URLs for the server to download from.
Advanced Server Features	<p>DNS SRV support, SIP server failure transfer, message waiting indicator and custom screensaver.</p>
Security	<ul style="list-style-type: none"> - MD5 and MD5-sess DIGEST encoding and authentication. - Security protection: SIP over TLS and SRTP. - Support for TR-069. - Support for OpenVPN for increased security and control.

INSTALLATION

EQUIPMENT PACKAGING

This GXV3175 package contains:

1. One (1) GXV3175 Phone Main Case with One (1) Stylus inserted in the back
2. One (1) Handset
3. One (1) Quick Start Guide
4. One (1) Headset Dongle
5. One (1) Ethernet Cable
6. One (1) Phone Cord
7. One (1) 12V Power Adapter
8. One (1) Phone Stand
9. One (1) Wall Mount
10. One (1) TV VGA Adapter Cable

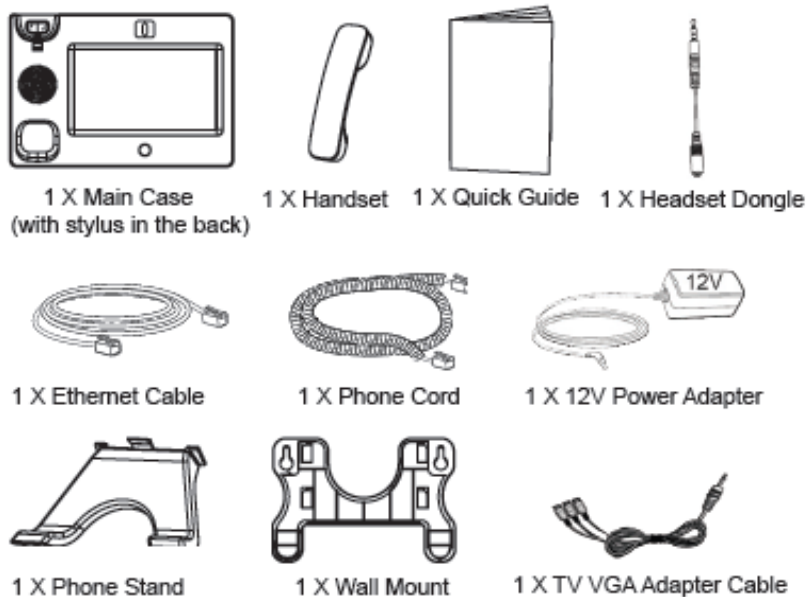

Figure 1: GXV3175 Equipment Packaging

SAFETY COMPLIANCES

GXV3175 complies with FCC/CE/C-Tick safety standards. The power adapter of GXV3175 is compliant with the UL standard. Please use the universal power adapter provided with the GXV3175 package only.

The manufacturer’s warranty does not cover damages to the phone caused by unsupported power adapters.

WARRANTY

If GXV3175 was purchased from a reseller, please contact the company the phone was purchased for replacement, repair or refund. If the phone was purchased directly from Grandstream, please contact Grandstream Sales and Service Representative for a RMA (Return Materials Authorization) number before the product is returned. Grandstream reserves the right to remedy warranty policy without prior notification.

WARNING: Use the power adapter provided with the phone. Do not use a different power adapter as this may damage the phone. This type of damage is not covered under warranty.

CONNECTING THE GXV3175 IP MULTIMEDIA PHONE

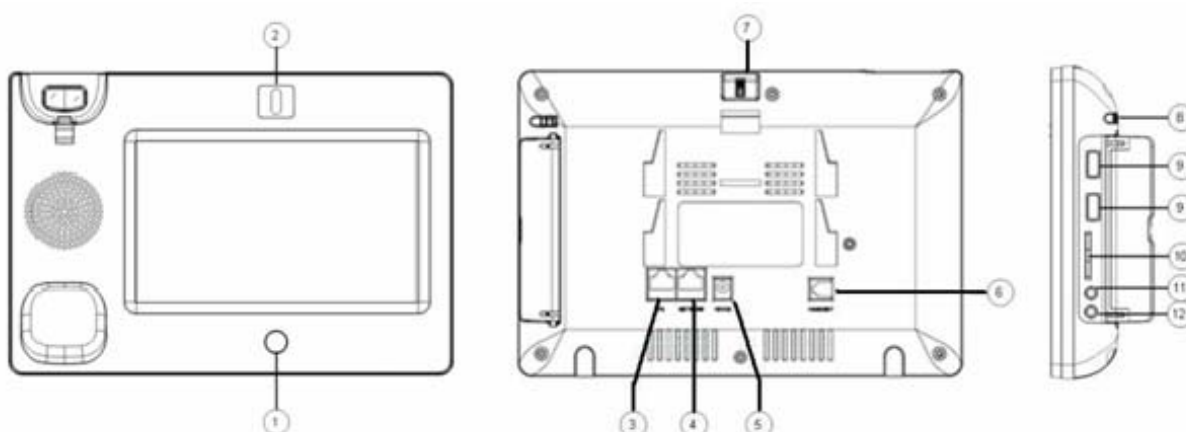

Figure 2: GXV3175 Ports and Interface

Table 4: GXV3175 Ports and Interface

Item	Name	Description
1	Home Button	Press Home button to navigate to main screen
2	Camera	1.3M pixel adjustable CMOS camera with privacy shutter
3	PC Ethernet Port	10/100Mbps RJ-45 port connecting to PC
4	Network Ethernet Port	10/100Mbps RJ-45 port connecting to Ethernet
5	Power Jack	12V DC Power connector port
6	RJ11 Jack	Phone handset connector port
7	Camera Adjust Wheel	Scroll the wheel to turn on/off the camera;

		Adjust the camera position and lens angle
8	Stylus	Stylus for touch screen (optional)
9	USB Port	USB devices may be connected via the USB port. For example, you can connect a USB flash drive to save captured pictures and plug in USB keyboard or mouse for the built-in web browser
10	SD Card Slot	SD card could be inserted in for picture/music/video files storage
11	HDMI	High-Definition Multimedia Interface
12	Headset Jack	3.5mm stereo headset connector port

WALL MOUNT

GXV3175 has two slots on the back of the phone for wall mounting convenience. (See Figure 3)

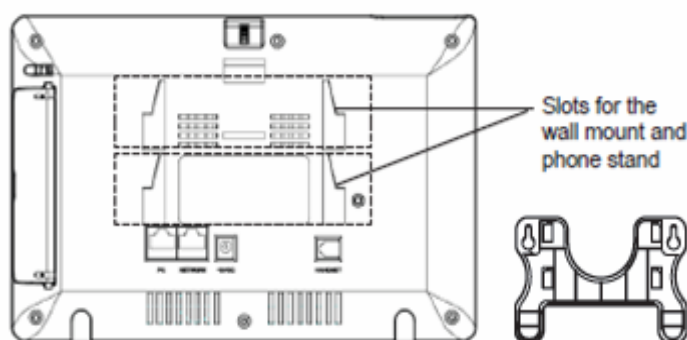

Figure 3: Wall Mount for GXV3175

PHONE STAND

GXV3175 can also be placed on the table or desk via the phone stand. (See Figure 4) There are two positions for the stand on the back of the phone with each position supporting a different angle.

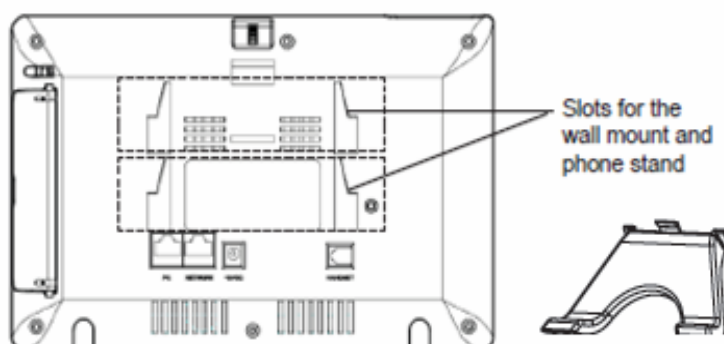

Figure 4: Phone Stand for GXV3175

CONNECTING GXV3175 IP MULTIMEDIA PHONE

CONNECTING THE PHONE:

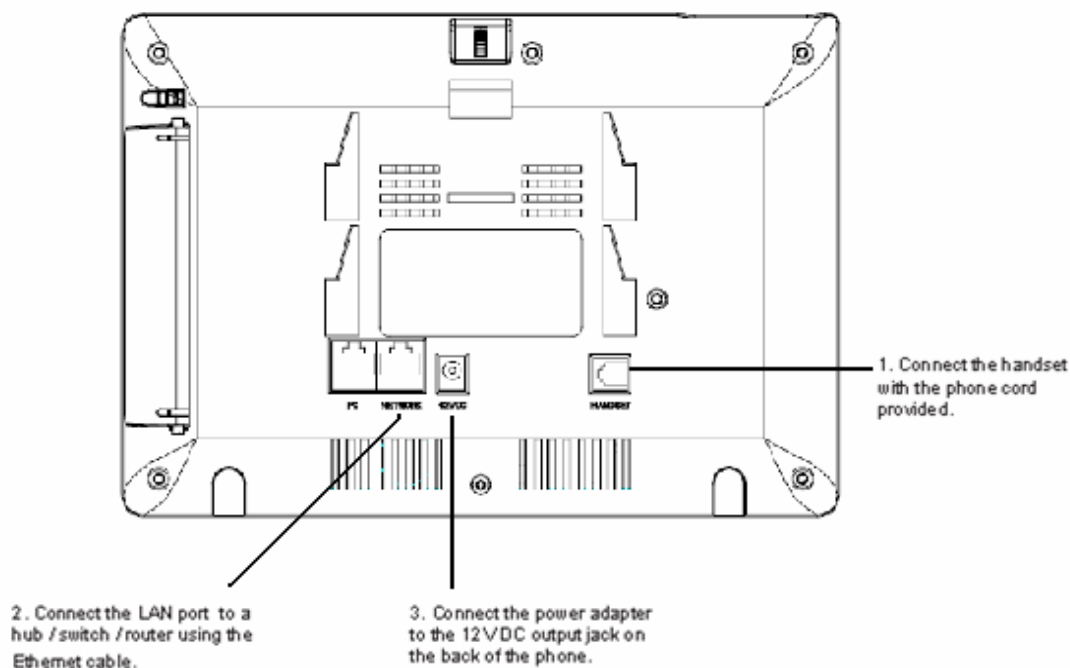

Figure 5: Connecting the GXV3175

WELCOME SETUP GUIDE

After the GXV3175 completes the touch screen collaboration a welcome screen will appear that will allow the user to access the Setup Guide. In this Setup Guide, a user can configure account information, network settings, and upgrade settings.



Figure 6: Setup Guide Welcome Screen

After hitting “Next”, the user will reach the Account Settings screen. By default, the IPVideoTalk account is set to Account 1 slot. Users may choose to remove this account by inputting their own account information, or keep this account and select “Create one more account” to create a new account. The GXV3175 allows up to 3 accounts.



Figure 7: Setup Guide Account Settings

The following screen that appears is the Network settings. Here the user can select between DHCP,

PPPoE, or Static IP.



Figure 8: Setup Guide Network Settings

After pressing “Next”, the user will be brought to the Upgrade Settings. This section allows the user to choose where the phone will send upgrade requests to as well as configuration requests. The Automatic Upgrade field allows the user to specify how often the phone should check for firmware/configuration.

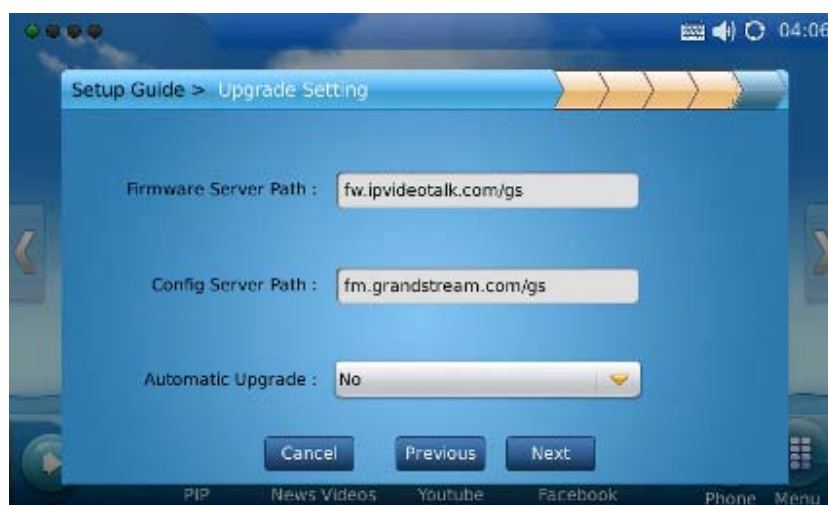

Figure 9: Setup Guide Upgrade Settings

Once completed with all the Setup Guide steps, the user will be prompted to reboot the phone so that changes can take effect immediately.

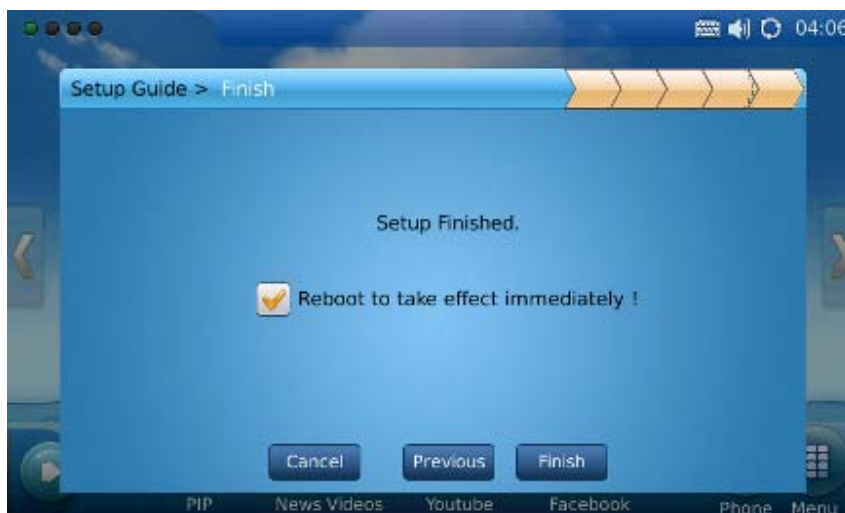

Figure 10: Quick Setup Guide Completion

MAKING THE FIRST CALL WITH IPVIDEOTALK SERVICE

GXV3175 offers users the ability to send and receive free lifetime video calling to other GXV3175/GXV3140 on the IPVideoTalk network. Once the GXV3175 is connected, video calls can be made using Grandstream's configuration peer-to-peer SIP technology and IPVideoTalk service. To place the first video call, complete the following three simple steps:

- 1) Connect the handset, network cable and power adapter to the GXV3175 using the methods described above. After the phone boots up and obtains an IP address through DHCP, it will attempt to register to the IPVideoTalk network. When the user boots the phone for the first time, Account 1 will be registered to the IPVideoTalk server with a provisioned extension number 810xxxx.
- 2) If the registration is successful, the "IPVideoTalk" text on the LCD will turn green and an assigned IPVideoTalk number (810xxxx) specific to this phone will be displayed. At this point, the phone is ready for making and receiving video calls over the IPVideoTalk network.
- 3) Tap on the account (See Figure 11) in the touch screen then the dial pad will show up for on-hook dialing. Dial the number of any other phone registered on the IPVideoTalk network and press "Video Call" or "Audio Call" button in the dial pad. If the user has purchased more GXV3175/GXV3140 IP Multimedia phones, these phones are able to establish video calls between each other and the user will immediately experience the plug and play nature of the GXV3175.



Figure 11: Select IPVideoTalk account in the marked area to make first call

USING THE GXV3175 IP MULTIMEDIA PHONE

LCD

When the phone is idle, the LCD screen will look similar to Figure 9. (The account and IP address may be different from case to case, depending on the network environment and the settings.)



Figure 12: GXV3175 LCD Idle Screen

Users could hold and drag on the center area of the main screen then slide from right to left to switch the screen to view the different desktop widgets in the four screens. In the left hand side of the status bar, there are four (4) green tabs indicating the current page of the screen.

Figure 13 shows the screen that displays weather and currency information.



Figure 13: LCD Idle screen displaying Weather and Currency Information

Move around all the way to left to switch to screen that displays News Videos and Stock information. See Figure 14.



Figure 14: LCD Idle screen displaying News Videos and Stock information

Switch again to the last screen that shows Calendar and RSS News. See figure 15.



Figure 15: LCD Idle screen displaying Calendar and RSS News

In Figure 15, on the button menu of each screen, users could select “Menu” to access the full menu, select “Phone” icon to make call, select PIP/News Videos/Youtube/Internet Radio/Browser to access the corresponding applications. If the users press  button on the left, new widgets which include Info, Weather, RSS News, Contacts and Internet Radio will be available to open and display in the main screen. (See Figure 16)



Figure 16: Open new widget in Idle screen

Users may close/configure the widget by holding the finger on the widget area until close/setting options show up on the right (Marked in Figure 17).





Figure 17: Close/Configure the widget in Idle screen

























By selecting the right hand side area of the status bar, users will be able to set the phone’s status in the popped out dropdown list. See Figure 18.



Figure 18: LCD Idle screen displaying status bar settings

Table 5: LCD Icon Definition

Type	Icon	Definition	Note
Network		Connected to the network	
		Failed to connect to the network	
Call Related		Account 1 Auto Answer	



		Account 2 Auto Answer	
		Account 3 Auto Answer	
		Account 1 Call Forward	If call forward is on: unconditional forward, forward when busy or forward on no answer.
		Account 2 Call Forward	
		Account 3 Call Forward	
Ring Volume		Ring volume, ranges from 0-9	
Phone Status		Camera disabled.	
		Do-Not-Disturb (DND)	
		Missed Call.	
Audio Output		The headset is in use and is off hook.	
		The headset is plugged in.	
		The phone is on speaker.	
		The handset is off hook.	
WiFi		WiFi signal strength, ranging from 0 to 4	
			
			
			
			
Message		Unread message	The icon is displayed at the right hand side of the status bar
		Message box is full	
Applications		Unread text message.	
		Alarm clock	
		Background running program	The icon is displayed at the center of the status bar
External devices		SD card	
		USB flash drive.	
		USB keyboard	
		USB mouse	

MULTIPLE SIP ACCOUNTS AND LINES



Figure 19: GXV3175 Dial Pad

Table 6: GXV3175 Dial Pad Definition

Item	Definition
1	Line/Account selection. Three independent SIP accounts may be configured, and the Line options can be used to choose the line/account for audio/video call.
2	Account option. Dropdown list will show all the registered account for selection.
3	Call option. Dropdown list will show three types of call: Call, Paging and IP Call for direct IP Cal.
4	Audio output. Three types of audio output are available: speaker, handset and headset.
5	Call volume. Press  to turn down or press  to turn up the volume.
6	Standard keypad.
7	Delete input number. Press to delete the input number when dialing out.
8	Contacts. Press to open contact list.
9	Call History. Press to open call history.
10	Message. Press to open message box.
11	Voice Mail. Press to access voice mail box.
12	BLF. Press to access BLF.

The GXV3175 supports up to 3 independent SIP accounts. Each account may have separate SIP servers, usernames and NAT configurations. The registered account will display in the idle screen by default. When

the phone is off-hook, users could press Line1/Line 2/Line 3 or the account option in the dial pad shown in Figure 19 to switch between different SIP accounts.

Incoming calls through the three accounts will try to use the corresponding line. If this line is busy, the green icon for the corresponding line will become red. When a call comes in and the line is busy, the next idle line will be used.

HANDSET, SPEAKER AND HEADSET MODE

The GXV3175 allows users to switch from handset to speaker or headset by pressing corresponding icons shown in Dial Pad (Table 6, Item 5). If headset is plugged in, the headset icon will be activated to select.

MAKING A CALL

There are several ways to make a call.

1. By selecting account displayed in idle screen

Users could press the account area displayed in idle screen to make a call via the selected account.

- In idle screen, select the registered account by touching the marked area in Figure.
- The dial pad will show up with the selected account.
- Dial the number and press “Audio Call” or ”Video Call” to dial out. Or press “Redial” for the last dialed number.



Figure 20: Making a call by select account displayed in idle screen

2. By “Phone” in idle screen

- In idle screen, select the “Phone” icon  in the bottom menu.
- The dial pad will show up with dial tone.
- Dial the number and press “Audio Call” or “Video Call” to dial out. Or press “Redial” for the last dialed number.

3. By taking handset off hook

Users will be able to make a call when the phone is idle or running other applications by taking the handset off hook.

- Take the handset off hook then the dial pad will show up with dial tone.
- Select line/account.
- Press “Redial” or dial the number and press “Audio Call”/“Video Call” to dial out.

4. By Call History

- Access the Phone Menu by pressing “MENU” icon in idle screen, and then select “Call history”.
- The LCD monitor will display “All” calls, “Received” calls, “Dialed” calls and “Missed calls”. Select the call history that you wish to view.
- Press  to dial the selected number. (See figure 21)



Figure 21: Dial by Call History

5. By Contacts

- Access the Phone Menu by pressing “MENU” icon in idle screen, and then select “Contacts”.

Or choose “Contacts” icon in dial pad to access contact list.

- The LCD monitor will display the contact list. Scroll to the contact to be dialed.
- Press  to call the select contact. The primary number of the contact will be dialed out.

See Figure 22.



Figure 22: Dial by Contact List

- If selecting the contact for full contact information, there will be four numbers available to dial out: Home, Work, Mobile and Fax. Press  to dial the corresponding number. See Figure 23.



Figure 23: Dial by Contact List – more contact information

6. By Contact Favorite in idle screen





In idle screen, press  and select  to open the “Contacts” widget. Users could add the contact to the favorite list. Select the contact and press  to dial out. (See Figure 24)



Figure 24: Dial by Contact Favorite in idle screen

7. By Messages

Users could access the Phone Menu by pressing “MENU” icon in idle screen, and then select “Message”. Similar to dialing by Call History, press  to dial the selected contact in message history.

DURING CALLS

ANSWERING CALLS

1. **Incoming Video Call:** When the phone rings, select “Accept Audio”, “Accept Video” or “Reject”. (See Figure 25) Users could toggle among handset/speaker/headset to answer the call and adjust the call volume by pressing the speaker icon as well.



Figure 25: Answer incoming video call

2. **Incoming Audio Call:** When an audio call is coming in, select “Accept Audio” or “Reject” in the screen shown as Figure 26.



Figure 26: Answer incoming video call

3. **Missed Call:** if the call is unanswered, a missed call message will show up in idle screen. (See Figure 27). Users could press View to access the detail of the missed call.



Figure 27: Missed Call Notification

CALL FUNCTION OPTIONS

Figure 28 shows the screen after the users answer the call. Press “Options” button  to access all the call functions.



Figure 28: Use Call Options during a video call

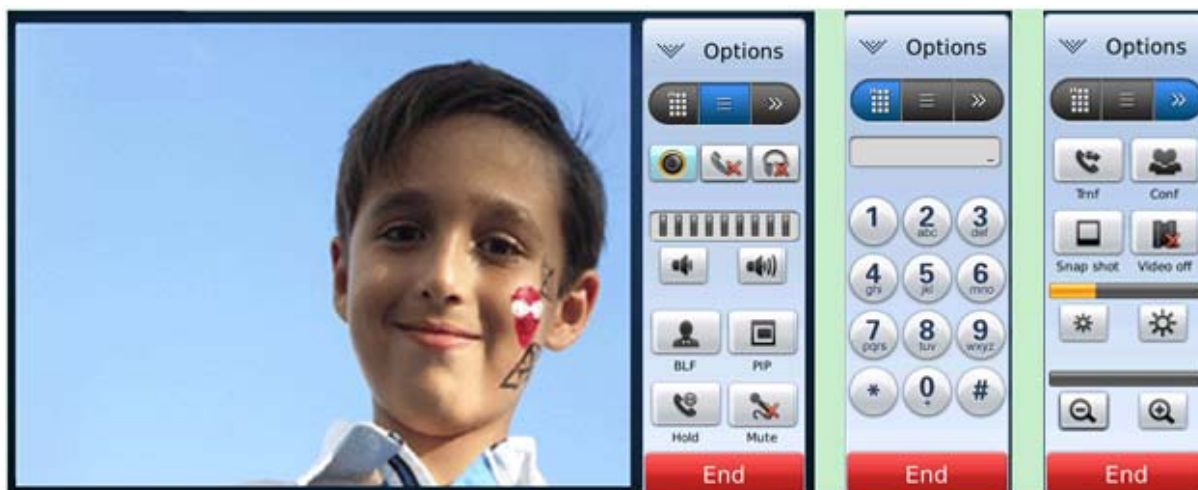







Figure 29: Call Function Options

Table 7: GXV3175 Call Function Description

OPTION MENU	FUNCTION	DESCRIPTION
	PIP	Press to switch videos between the caller and callee
	Hold	Press to hold the call
	Mute	Press to mute/unmute the call
	Volume	Press to increase or decrease volume
	Conference	Press to make 3-way conference call
	Snapshot	Press to take a snapshot of the current video. The snapshot will be automatically saved to folder "screenshot" in Tools->File Manager
	Video off	Press to switch between Video off and Video on. In the screen, the default picture will show instead of the video when video is turned off
		Turn up and turn down the video brightness
	Video zoom in and turn out	
	DTMF Dial Pad	Press the number and # or * for DTMF

CALL HOLD

1. **Call Hold:** During a call, press "Hold" button to place the call on hold. The line icon will become yellow after call hold. The following will be displayed on the screen. (See Figure 30)



Figure 30: Call Hold

2. **Call Resume:** In Figure 30, press “Unhold” button to resume to the call.
3. **Multiple Calls:** After call hold, users could select another line to make calls. If there is another call coming in, the user will be able to select “Accept” or “Reject” in the right hand side of the screen. Accept new incoming call will put the previous call on hold. To toggling between several calls, users may need to turn off the video first by tapping on “Video off” in “Option” (See Figure 29) if it is a video call. Then the following figure will show up for users to select between multiple lines. See Figure 31.

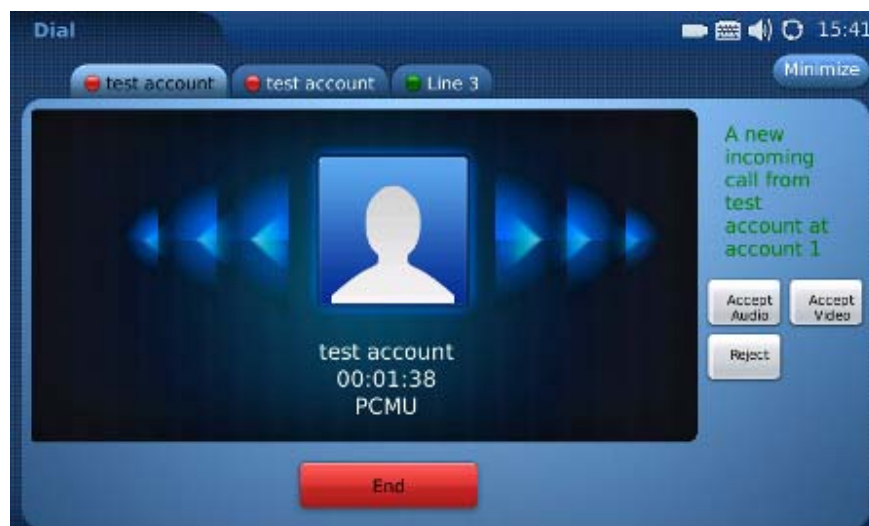

Figure 31: Multiple Calls

CALL TRANSFER

1. **Blind Transfer:** During a call, press the “Transfer” button to place the other party on hold. The

phone will display the following message: “Dial Number (Blind) OR Select Line (Attended)”. (See Figure 32). Dial the extension number and press “Send”. This will transfer the call to the other party immediately.



Figure 32: Blind Transfer

- Attended Transfer:** During a call, select another line to establish call with the third party using the same account. This will put the previous line (Line 1) on hold. Now, press the “Transfer” button and the message: “Dial Number (Blind) OR Select Line (Attended)” will show up in the screen. Then select Line 1 to finish attended transfer. (See Figure 33)



Figure 33: Attended Transfer

NOTE:

- To transfer calls across SIP domains, SIP service providers must support transfer across SIP domains.

- If users enter a wrong number and wish to cancel the transfer, just press the “Cancel” in the screen shown in Figure 32. Then the call with the first party will resume automatically.
- If the user is on a video call with the first party, the users may need to turn off the video by pressing “Video off” or pressing “Hold” to activate the screen to select another line.

3-WAY CONFERENCE

The GXV-3175 supports 3-way video conferencing. See Figure 34.



Figure 34: 3-Way Conference

1. **Initiate a Conference Call:** During a call, select another line by pressing “Line” button to call the second party using the same account. This will place the first call on hold. Once the user has established the second call, press the “Conference” button then select the line on hold by pressing the corresponding “Line” button. This would bring the three parties together in a 3 way conference.
2. **Cancel the Conference:** If after pressing the “Conference” button, a user decides not to conference anyone, press “Cancel” to cancel the conference.
3. **End the Conference:** There are two ways to end a conference: The first way is to press “END” in the conference call. The second way to end a conference is to simply hang up and terminate the call.

NOTE:

- During the conference, users can see three-way videos if it is video call.
- To activate the call options during the conference, users could simply tap on the screen then the options will show up. Press PIP button to change the layout of the video display for the three parties.
- During the three way conference, if the initiator of the conference hangs up, the conference will end. If users wish to allow the remaining two parties to stay in conversation after the initiator hangs

up, the conference initiator should set “Transfer on Conference Hangup” to “Yes” in the web configuration interface. This would allow the transfer of call to the remaining party after the initiator exits the conference.

- If the user is on a video call with the first party, the users may need to turn off the video by pressing “Video off” or pressing “Hold” to activate the screen to select another line.

VOICEMAIL (MESSAGE WAITING INDICATION)

If the blue Message Waiting Indication (MWI) LED icon is flickering in the HOME button, a new voice mail has been received and is waiting to be retrieved. To retrieve the voice mail, activate dial pad first. Then dial

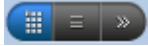
the voicemail box number or press Voice Mail button  (the button needs to be configured in web configuration interface first). The Interactive Voice Response (IVR) prompts the user through the message retrieval process. The users may need to navigate to call function option  and use the DTMF keypad for voicemail options.

NOTE: Each of the 3 accounts has its own voicemail. The Voicemail access number may be set up in the “Voicemail ID” configuration under “Accounts” in the web configuration interface.

MUTE

1. During a call, the LCD screen will display “Mute”. Select the button to mute the call.
2. After the “Mute” button is pressed, the LCD screen will display “Unmute”. When this button is pressed, the mute feature is cancelled.

KEYPAD INPUT

The build-in soft keypad in GXV3175 supports English and Chinese for text input. See Figure 35.



Figure 35: GXV3175 Soft Keypad

Table 8: GXV3175 Keypad Definition

Item	Function
1	Caps lock.
2	Hide keypad
3	Switch between English/Chinese input.
4	Switch to characters with accents
5	Delete
6	Switch between Letter/Number/Symbol

NOTE: External keyboard could also be used by plugging via USB port on the phone.

CALL FEATURES

The following table shows the codes for call features. To use the code, select the line you wish to use by

pressing the corresponding Line button and enter the feature code.

Table 9: GXV3175 Call Features

Code	Feature
*01	Select the preferred video/audio codec used for the call. Dial *01 + codec feature code + Phone/Ext. Number (See Table 8 for codec feature code)
*02	Force the video/audio codec used for the call. Dial *02 + codec feature code + Phone/Ext. Number (See Table 8 for codec feature code)
*30	Block Caller ID (for all subsequent calls)
*31	Send Caller ID (for all subsequent calls)
*50	Disable Call waiting (for all subsequent calls)
*51	Enable Call Waiting (for all subsequent calls)
*67	Block Caller ID (per call): Dial *67 + Phone/Ext. Number (no dial-tone in between).
*82	Send Caller ID (per call): Dial *82 + Phone/Ext. Number (no dial-tone in between).
*83	Send audio only: Dial *83 + Phone/Ext. Number (no dial-tone in between)
*84	Send audio and video: Dial *84 + Phone/Ext. Number (no dial-tone in between)
*70	Disable Call Waiting (per call): Dial *70 + Phone/Ext. Number (no dial-tone in between).
*71	Enable Call Waiting (per call): Dial *71 + Phone/Ext. Number (no dial-tone in between).
*72	Unconditional Call Forward: Dial *72 + Phone/Ext. Number followed by the # key. Wait for a dial-tone and then hang up (dial-tone means input is successful).
*73	Cancel Unconditional Call Forward: Dial *73 and wait for a dial-tone before hanging up.
*90	Busy Call Forward: Dial *90 + Phone/Ext. Number followed by the # key. Wait for a dial-tone and then hang up.
*91	Cancel Busy Call Forward: dial *91 and wait for a dial-tone before hanging up.
*92	Delayed Call Forward: Dial *92 + Phone/Ext. Number followed by the # key. Wait for a dial-tone and then hang up.
*93	Cancel Delayed Call Forward: Dial *93 and wait for a dial-tone before hanging up.

Table 10: GXV3175 Audio/Video Codec Feature Code

Codec	Feature Code
PCMU	7110
PCMA	7111
G723	723
G726-32	72632
G729	729
G722	722

GSM	7200
L16-256	7202
H.264	264
H.263	263
H.263+	2631998

GXV3175 WEB CONFIGURATION INTERFACE

The GXV-3175's embedded Web server responds to HTTP/HTTPS GET/POST requests. Embedded HTML pages allows users to configure the IP Multimedia Phone through a Web browser such as Microsoft's IE or Mozilla Firefox (Java Script must be enabled).



Figure 36: Web Browser Interface for GXV3175

ACCESSING THE WEB CONFIGURATION PAGES

The GXV3175 Web Configuration Interface URL is *http://Phone-IP-Address*, where the *Phone-IP Address* is the IP address displayed on the phone's LCD screen.

To access the phone's Web Configuration Menu:

- Connect the computer to the same network as the phone.
 - Make sure the phone is turned on and shows its IP-address on the LCD display.
 - Open a Web-browser on your computer.
 - Enter the phone's IP-address in the address bar of the browser.
 - Enter the administrator's login and password to access the Web Configuration Menu.
1. The computer has to be connected to the same sub-network as the phone. This is easily done by connecting the computer to the same hub or switch as the phone it is connected to. In absence of a hub/switch (or free ports on the hub/switch), please connect the computer directly to the phone using the PC-port on the phone.
 2. If the phone is properly connected to a working Internet connection, the phone will display its IP address. This address has the format: xxx.xxx.xxx.xxx, where xxx stands for a number from 0-255. Users will need this number to access the Web Configuration Menu. For example, if the phone shows 192.168.0.60, please enter "*http://192.168.0.60*" in the address bar of the browser.
 3. The default login name for the administrator is "admin". The default administrator password is set to "admin". The default login name for end-users is "user" while the default user password is set to "123".

NOTE: When changing any settings, always SUBMIT them by pressing the SAVE button on the bottom of the page. For those settings that are shown in the web user interface (UI) with a star "*" next to it, users must reboot the phone for the changes to take effect.

DEFINITIONS

This section describes the options in the Web configuration user interface. As mentioned, you can log in as an administrator or an end-user.

- **Status:** Displays the Account status, Network status, and System info of the phone.
- **Account (1~3):** To configure each of the SIP accounts.
- **Advanced Settings:** To configure General settings, Call Features, Video Settings, and Ring Tones.
- **Maintenance:** To configure Network Settings, WiFi Settings, 3G Settings, Time Settings, Web/Telnet Access, Upgrade, Syslog, Debug, Language, Network Manager, OpenVPN Settings and Device Manager.

STATUS PAGE DEFINITIONS

Status/Account Status

Account	Shows the status of the 3 accounts.
Number	Shows the extension number of the SIP account.
SIP Server	Shows the URL/IP address and port of the SIP server.
Status	Shows the status of the account.

Status/Network Status

MAC Address	The device ID, in HEX format. This is a very important ID for ISP troubleshooting.
Address Type	This field shows the type of address configured: DHCP, Static IP or PPPoE.
IP Address	This field shows the IP address of the GXV-3175.
Subnet Mask	This field shows the subnet mask of the GXV-3175.
Default Gateway	This field shows the Gateway of the GXV-3175.
DNS Server	This field shows the DNS Server of the GXV-3175.
NAT Type	This field shows the type of NAT configured.

Status/System Info

Product Model	Defines the product model: GXV3175.
Hardware Revision	Hardware version number: Main Board, Interface Board.
Part Number	This field contains the product part number.
Program Version	<ul style="list-style-type: none"> Program: This is the main firmware release number, which is always used for identifying the software (or firmware) system of the phone.
System Up Time	This field shows system up time since the last reboot.

ADVANCED SETTINGS PAGE DEFINITIONS

Advanced Settings/General Settings

Local RTP Port	This parameter defines the local RTP-RTCP port pair used to listen and transmit. It is the base RTP port for channel 0. When configured, for audio,
----------------	---

	channel 0 will use this port _value for RTP and the port_value+1 for its RTCP; channel 1 will use port_value+4 for RTP and port_value+5 for its RTCP. For video, channel 0 will use port_value+2 for RTP and port_value+3 for its RTCP; channel 1 will use port_value+6 for RTP and port_value+7 for RTCP. The default value is 5004.
Use Random Port	When set to YES, this parameter will force random generation of both the local SIP and RTP ports. This is usually necessary when multiple GXV-3175s are behind the same full cone NAT. The Default setting is YES. (This parameter must be set to NO before Direct IP Calling will work)
Keep-alive Intervals (s)	This parameter specifies how often the GXV-3175 sends a blank UDP packet to the SIP server in order to keep the “ping hole” on the NAT router to open. The default setting is 20 seconds.
STUN Server	The IP address or Domain name of the STUN server. STUN resolution results are displayed in the STATUS page of the Web UI. Only non-symmetric NAT routers work with STUN. Default STUN server: stun.ipvideotalk.com
Use NAT IP	The NAT IP address used in SIP/SDP messages. This field is blank at the default settings. This should ONLY be used if your ITSP requires it.
SSL Certificate	This defines the SSL certificate needed to access certain websites.
SSL Private Key	This defines the SSL Private key.
SSL Private key Password	This defines the SSL private key password.

Advanced Settings/Call Features

Disable Call-Waiting	The default setting is No. If set to Yes, the call waiting feature will be disabled.
Disable Call-Waiting Tone	The default setting is No. If set to Yes, the call waiting tone will be disabled.
Disable Direct IP Call	The default setting is No. If set to Yes, Direct IP calling will be disabled.
Offhook Auto Dial	Configure a User ID/extension to dial automatically when the phone is taken offhook. By default, the phone will use the first account to dial out.

Advanced Settings/Video Settings

Enable Motion Detection	The phone will exit idle/screensaver mode if motion is detected. The default setting is Yes.
Video Frame rate	The Default value is 15 frames/second. The video frame rate is adjustable based on network conditions. Increasing the frame rate will increase the amount of transferred data

	significantly therefore consuming more bandwidth. Lack of bandwidth will impair the video due to packet loss.
Video Packet Size	The Default value is 1400, range from 100 to 1400. It is recommended to use 600~800 if you have an Outbound Proxy or Media Gateway.
Video Rate Control	Frame, TMN8 or GOP. The Default setting is Frame. TMN8 is good for bandwidths larger than 384kbps
Video Frame Skipping	Skips bad video frames as they are received The Default setting is No.
I-Frame Reference Only	When enabled, all P frames will only have reference to previous I frames. This method may improve video quality when the network has heavy packet loss. It will have modest increase in bandwidth usage. The Default setting is No.
Packetization-Mode	The packetization mode (0 or 1) for the H.264 video packets. The default setting is 0.
Redundant P-frame	This setting allows the phone to send redundant P-frames of I frames. When an I frame is delayed or has packet loss, the redundant P-frames will be used instead. It may make video phone call less prone to errors and thus make the video stream more robust towards error propagation, but may increase bandwidth usage. The default setting is set to No.
Adaptive MB Intra Refresh	This parameter specifies whether Adaptive MB Intra Refresh is used or not. It may protect most important MBs (macro blocks) subjected to packet loss and to avoid error propagation. The intra-refresh rate is adapted according to the video packet loss rate. It may increase bandwidth usage. The default setting is set to No.
Video Packet Loss Rate	Specifies the video packet loss rate for the Adaptive MB Intra Refresh. Users can choose from: Less than 5%, Less than 10%, Less than 15%, Less than 20%, Less than 25%. The default setting is set to Less than 10%.

Advanced Settings/Ring Tone

Call Progress Tones: Dial Tone Ring Back Tone Busy Tone Reorder Tone Confirmation Tone Call-Waiting Tone	Using these settings, users can configure ring or tone frequencies based on parameters from the local telecom provider. By default, they are set to the North American standard. Frequencies should be configured with known values to avoid uncomfortable high pitch sounds. Syntax: f1=val,f2=val[,c=on1/off1[-on2/off2[-on3/off3]]]; (Frequencies are in Hz and cadence on and off are in 10ms)
--	--

PSTN disconnect Tone	ON is the period of ringing (“On time” in ‘ms’) while OFF is the period of silence. In order to set a continuous ring, OFF should be zero. Otherwise it will ring ON ms and a pause of OFF ms and then repeat the pattern. Up to three cadences are supported.
Default Ring Cadence	This defines the ring cadence for the phone. The default setting is: c=2000/4000;

MAINTENANCE PAGE DEFINITIONS

Maintenance/Network Settings

Address Type	This selects the type of IP address assigned: DHCP, PPPoE or Static IP.
PPPoE	When PPPoE is selected, the user needs to enter the following: PPPoE Account ID, PPPoE Password, PPPoE Service Name.
Static IP	When Static IP is selected, the user needs to enter IP address, Subnet Mask, Default Gateway, DNS Server 1 and DNS Server 2.
Alternate DNS Server	This field sets the alternate DNS server for the user.
Layer 3 QoS	This field defines the layer 3 QoS parameter. It is the value used for IP Precedence, Diff-Serv or MPLS. The Default value is 0.
Layer 2 QoS 802.1Q/VLAN Tag	This field contains the value used for layer 2 VLAN tagging. The Default value is 0.
Layer 2 QoS 802.1p Priority Value	This assigns the priority value of the Layer2 QoS packets. The Default value is 0.
802.1x Mode	This field sets 802.1x Mode. The default value is disabled. If EAD-MD5 is selected, users will be required to enter Identity and MD5 Password.
Proxy	This field sets HTTP Proxy, HTTPS Proxy, FTP Proxy or No Proxy. Using HTTP Proxy, other protocols can be applied by checking the box “Apply to Other Protocol”.

Maintenance/Wifi Settings

WiFi Functions	This parameter enables/disables the WiFi function. The default setting is set to “Disable”.
Wireless Mode	This parameter defines the wireless mode used. The GXV3175 supports 802.11b/g/n

Network Type	This parameter defines the network type of the wireless network: Ad-hoc or AP/Managed. By default, it is set to "AP or Managed".
Channel	This parameter defines the channel (1-10) for the wireless network. The default setting is set to "Auto".
ESSID	This parameter sets the ESSID for the Wireless network. Press "Scan" to scan for the available wireless network and add it. Users can also press "Add" to add the ESSID directly.
Security Mode	This parameter defines the security mode used for the wireless network. The following are supported: WEP/Shared, WEP/OPEN, WPA PSK TKIP, WPA PSK AES, WPA2 PSK TKIP, WPA2 PSK AES. The default setting is set to "Disabled". Users will need to enter the corresponding authentication password for the security mode.

Maintenance/3G Settings

3G USB Configuration File	Click Here to download Config file and Script
3G USB Connect Script	Click Here to download Config file and Script
Note:	<p>The user is required to have the config file for the modem and a script. Please make sure that the used 3G Modem is support by the GXV3175(list of supported 3G modems below)</p> <p>WCDMA</p> <ul style="list-style-type: none"> • Huawei E1750 • Huawei E180 • Sierra Wireless 306 <p>CDMA2000</p> <ul style="list-style-type: none"> • ZTE AC581 • Huawei EC1260 <p>EVDO</p> <ul style="list-style-type: none"> • Novatel Ovation MC760

Maintenance/Time Settings

NTP Server	This parameter defines the URL or IP address of the NTP (Network Time Protocol) server. The GXV3175 phone may obtain the date and time from
------------	---

	<p>the server. The default setting is ntp.ipvideotalk.com.</p>
DHCP Option 42 override NTP server	Select Yes for the user to allow DHCP Option 2 to override the NTP server if there is one on the LAN. The default setting is NO.
Time Zone	This parameter controls the date/time display according to the specified time zone.
Time Display Format	This parameter sets time display format to 12 Hour or 24 Hour
Date Display Format	This parameter sets date display format to YY-MM-DD or MM-DD-YY or DD-MM-YY.
Self-Defined Time Zone	<p>This parameter allows the users to define their own time zone.</p> <p>Syntax: std offset dst [offset], start [/time], end [/time] Default is set to: MTZ+6MDT+5,M3.2.0,M11.1.0, MTZ+6MDT+5 This indicates a time zone with 6 hours offset with 1 hour ahead which is U.S central time. If it is positive (+) if the local time zone is west of the Prime Meridian (A.K.A: International or Greenwich Meridian) and negative (-) if it is east.</p> <p>M3.2.0,M11.1.0 The 1st number indicates Month: 1,2,3.., 12 (for Jan, Feb, ..., Dec) The 2nd number indicates the nth iteration of the weekday: (1st Sunday, 3rd Tuesday...) The 3rd number indicates weekday: 0,1,2,...,6(for Sun, Mon, Tues,...,Sat) Therefore, this example is the DST which starts from the second Sunday of March to the 1st Sunday of November.</p>

Maintenance/Web and Telnet Access

Disable Telnet	The default value is No. If set to YES, the GXV3175 will not allow any telnet access to the phone.
Access Method	This defines the access method for web access: HTTP or secure HTTPS protocol.
Port	This defines the port for web access. By default, HTTP uses port 80 and HTTPS uses port 443. This field is for customizable web ports.
Admin Password	This defines the administrator password for web interface access. Only the administrator can configure the “Advanced Settings” and “Account x” pages. The password is case sensitive and the maximum password length is 25 characters.

User Password	This defines the user password for web interface access.
---------------	--

Maintenance/Upgrade

Lock Keypad for Update	The default value is NO. If set to YES, the keypad will be disabled from making any updates.
XML Config File Password	The password used for encrypting the XML configuration file using OpenSSL. This is required for the phone to decrypt the encrypted XML configuration file.
HTTP/HTTPS User Name	The user name for the HTTP server.
HTTP/HTTPS Password	The password for the HTTP server.
Upgrade Via	This field allows the user to choose the firmware upgrade method: TFTP, HTTP or HTTPS.
Firmware Server Path	Defines the server path for the firmware server. It can be different from the Configuration server which is used for provisioning.
Config Server Path	This is the server path for provisioning; it can be different from the firmware server.
Firmware File Prefix	This field enables your ITSP to lock firmware updates. If configured, only the firmware with the matching encrypted prefix will be downloaded and flashed into the phone.
Firmware File Postfix	This field enables your ITSP to lock firmware updates. If configured, only the firmware with the matching encrypted postfix will be downloaded and flashed into the phone.
Config File Prefix	This field enables your ITSP to lock configuration updates. If configured, only the configuration file with the matching encrypted prefix will be downloaded and flashed into the phone.
Config File Postfix	This field enables your ITSP to lock configuration updates. If configured, only the configuration file with the matching encrypted postfix will be downloaded and flashed into the phone.
DHCP Option 66 override Server	The Default setting is YES. If DHCP option 66 is enabled on the LAN side, the TFTP server can be redirected. Please be very careful when configuring this as the redirection could break the phone if this happens during the firmware upgrade.
DHCP Option 120 Override SIP Server	Default is "Yes". This allows device gets provisioned from the server automatically.

Automatic Upgrade	The default value is NO. Choose “YES” to enable automatic HTTP upgrade and provisioning.
Period time of upgrade checking	Specifies the time period to check for firmware upgrade. The default setting is 10080 minutes (7 days)
Hour of the day (0-23)	Defines the hour of the day to check the HTTP/TFTP server for firmware upgrades or configuration files changes.
Day of the week (0-6)	Defines the day of the week to check the HTTP/TFTP server for firmware upgrades or configuration files changes.
Automatic Upgrade Rule	Defines the rules for automatic upgrade: Always Check, when F/W suffix/prefix changes, Skip the Firmware Check.
Authenticate Conf File	Authenticate configuration file before acceptance. The Default setting is NO.
Factory Reset	Restore to factory default settings. Users can choose from: Full Reset, VoIP Data Reset, and User Data Reset. After the selection is made, press the “Reset” button to factory reset the phone. NOTE: Users can use the backup/restore functionality of the phone prior to the factory reset.

Maintenance/Syslog

Syslog Server	The URL/IP address for the syslog server.
Syslog Level	Select the level of logging for syslog. The default setting is NONE. There are 4 levels: INFO, DEBUG, ERROR and WARNING. Syslog messages are sent based on the following events: Product model/version on boot up (INFO level) NAT related info (INFO level) Sent or received SIP message (DEBUG level) SIP message summary (INFO level) Inbound and outbound calls (INFO level) Registration status change (INFO level) Negotiated codec (INFO level) Ethernet link up (INFO level) SLIC chip exception (WARNING and ERROR levels) Memory exception (ERROR level).

Maintenance/Debug

Capture Trace	Press START to start capturing a trace, and press STOP to abort the capture process.
View Trace	Press LIST to view the list of captured traces. It will show the time the trace was captured. Click on the name of the file to download and view the trace.
Enable Application Debug	When set to YES, the trace captured will contain debug messages. The default setting is NO.
Show All Version	Default is set to NO. When set to yes, all debug messages including syslog will be captured in the trace.

Maintenance/Language

Language	Selects the language setting for the phone. The current version supports English, Traditional Chinese and Simplified Chinese.
----------	---

Maintenance/Network Manager

ACS URL	Enter URL for TR-069 Auto Configuration Servers (ACS)
ACS Username	Enter ACS username
ACS Password	Enter ACS password
Periodic Inform Enable	Enable periodic inform. By default, it is disabled
Periodic Inform Interval(s)	Enter periodic inform interval(s). By default, it is set to 300s.
Connection Request Username	Enter connection request username
Connection Request Password	Enter connection request password
Connection Request Auth Mode	Select the authentication method among “No authentication”, “Basic”, or “Digest”.
Connection Request Port	Enter the connection request port

Maintenance/OpenVPN Settings

OpenVPN Enable	This enables/disables OpenVPN functionality. The default setting is No. To use OpenVPN functionality, it requires user to have access to an OpenVPN server.
OpenVPN Server Address	The URL/IP address for the OpenVPN server.
OpenVPN Server Port	The network port for the OpenVPN server. By default, it is set to 1194.

OpenVPN CA	OpenVPN CA file (ca.crt) required by the OpenVPN server for authentication purposes. Press "Upload" to upload the corresponding file to the phone.
OpenVPN Client Certificate	OpenVPN Client certificate file (*.crt) required by the OpenVPN server for authentication purposes. Press "Upload" to upload the corresponding file to the phone.
OpenVPN Client Key	The OpenVPN Client key (*.key) required by the OpenVPN server for authentication purposes. Press "Upload" to upload the corresponding file to the phone.

NOTE: To use OpenVPN functionalities, users must enable OpenVPN and configure all of the settings related to OpenVPN, including server address, port, OpenVPN CA, certificate and key. Additionally, the user must also set the SIP account to use "VPN" for the "Nat Traversal" (under Account-> Network Settings). Reboot the phone after these settings are saved for the changes to take effect. Once the phone connects to the OpenVPN server and the authentication is correct, the phone will show the VPN IP address under the Status-> Network Status, but it will still display the LAN IP on the LCD of the phone.

Maintenance/Device Manager (LCD)

Screen Saver Timeout (m)	This sets the lapsed idle time needed for the screen saver to appear. The default setting is 5 minutes.
Screen Saver Interval (s)xd	The screen saver is a picture slide show. This defines the frequency to change the picture on the screen for the screen saver. The default setting is 10 seconds.
LCD Auto Power Off Time (m)	This defines the lapsed idle time needed for the LCD to power off automatically in order to save power. The default setting is 10 minutes.

Maintenance/Device Manager (Headset)

Headset TX Gain (dB)	Transmission gain. It's a headset setting to control the voice intensity. The default setting is 0dB.
Headset RX Gain (dB)	Receive gain. It's a headset setting to control the voice intensity. The default setting is 0dB.

Maintenance/Device Manager (Camera)

Zoom mode	Select the desired camera zoom mode (Tele, optical, digital). Can adjust local video zoom either in mirror mode or during the call (on the fly) by pressing the Left or Right Arrow Key.
-----------	--

Exposure Setting	Select the desired Camera Exposure mode based on the surroundings. The default setting is set to Auto. The default setting is 8.
Color Mode	Select the desired Camera Color Mode (Color or Monochromatic). The default setting is set to Color.
White Balance	Select the desired Camera White Balance to be automatic or Fixed. The default setting is set to Auto.
Lens Correction	Correct Camera Lens noise. The default setting is set to YES. It is recommended to set this parameter to YES to reduce camera lens noise and improve video quality.
Flicker Control	Reduces flicker of image shot with a video camera caused by luminance fluctuation of an illuminating light source. Users can select 50Hz/60Hz depending on the frequency of the commercial electrical power. The default setting is set to Auto.

Maintenance/Device Manager (TV Port)

TV Output	Select the desired TV Output type (PAL or NTSC). NTSC 4:3 by default.
-----------	---

SIP ACCOUNT CONFIGURATION PAGE DEFINITIONS

The GXV3175 has three lines that can be configured to accommodate independent SIP accounts. Every SIP account has an individual configuration page.

Account/General Settings

Account Active	Select YES to enable and use the Line.
Account Name	The account name for the user that is displayed on the LCD screen.
SIP Server	The IP address of the SIP server or the given domain name of the VoIP service provider.
SIP User ID	User account information provided by the VoIP service provider; normally similar to a telephone number or an actual telephone number.
Authenticate ID	The authenticate ID for the SIP user. It can differ or be the same as the SIP user ID.
Authenticate password	The password that the GXV uses to authenticate with the ITSP (SIP) server. After it is saved, this will appear as blank for security reasons. The maximum length is 25 characters.
Voice Mail User ID	When this is configured, the user can dial to the voicemail server using the MESSAGE button. This ID is normally the feature code for Voice Mail.

Name	The Caller ID that will be displayed for the account.
Tel URI	The default setting is “Disable”. If the Video phone has an assigned PSTN number, this field should be set to “Enable”. If “User=Phone” is set, a “User=Phone” parameter will be attached to the “From header” in the SIP request to indicate the E.164 number.

Account/Network Settings

Outbound Proxy	IP address or Domain name of the Outbound Proxy, or Media Gateway, or Session Border Controller. Used by the GXV3175 for firewall or NAT penetration in different network environments. If a symmetric NAT is detected, STUN will not work and ONLY an Outbound Proxy will work.
DNS Mode	The default is set to A Record. If the user wishes to locate the server by DNS SRV, the user may select SRV or NATPTR/SRV.
NAT Traversal	<p>This setting decides whether the NAT traversal mechanism is activated. If it is set to “STUN” and STUN server is configured, the GXV3175 will route according the STUN server. In this mode, the STUN client embedded in the phone will communicate with the appointed STUN server to examine which type of Firewall/NAT setting is employed. If the type of NAT detected is Full Cone, Restricted Cone or Port-Restricted cone, the phone will try to use public IP addresses and port in all the SIP and SDP messages.</p> <p>If the “NAT Traversal” is configured to be “Keep-alive”, the phone will send an empty SDP packet (without payload data) to the SIP server once in 20 seconds to keep the NAT port open.</p> <p>If VPN is used, users should select “VPN” for NAT Traversal.</p> <p>Users could also set “Auto” or “UPnP” according to the network configuration.</p> <p>If an outbound proxy server is used, please configure this to be “NAT NO”.</p>
Proxy Require	Notifies the SIP server that the unit is behind a NAT/Firewall.

Account/SIP Settings

SIP Registration	Selects whether or not the GXV3175 will send a SIP Register message to the proxy; The default setting is YES.
Unregister On Reboot	If set to YES, the SIP user registration messages will be cleared on reboot. The default setting is YES.
Register Expiration (m)	This defines the expiration time of the registration in minutes. The default value is 50 minutes; the maximum value is 65535 minutes (approximately 45 days) and the minimum value is 5 minutes.

Wait Time Retry Registration (s)	The wait time for registration retry if registration fails. The default is set to 20 Seconds.
Local SIP Port	The local SIP port for sending and receiving data. The default settings for Account 1/2/3 are 5060/5062/5064.
Subscribe for MWI	Default is set to No. When selected, a SUBSCRIBE for Message Waiting Indication will be sent out periodically.
Session Expiration (s)	Session Expiration is the time (in seconds) at which the session is considered timed out if no successful session refresh transaction occurs beforehand. The default value is 180 seconds.
MIN-SE (s)	The minimum session expiration (in seconds). The default value is 90 seconds.
UAC Specify Refresher	As a Caller, select UAC to use the phone as the refresher, or select UAS to use the Callee or proxy server as the refresher.
UAS Specify Refresher	As a Callee, select UAC to use the caller or proxy server as the refresher, or select UAS to use the phone as the refresher.
Force INVITE	The Session Timer can be refreshed using the INVITE or UPDATE methods. Select "Yes" to use the INVITE method to refresh the session timer
Caller Request Timer	The default setting is Yes. If Yes is selected, the phone will use the session timer when it makes outbound calls if remote party supports session timer.
Callee Request Timer	If Yes is selected, the phone will use the session timer when it receives inbound calls with session timer request.
Force Timer	If Yes is selected, the timer will be activated even if the other party does not support session timers. If No is selected, the timer will be activated only if the other party supports the timer. To disable the timer, Caller Request timer, Callee request timer and Force Timer should all be set to No.
Enable 100rel	The use of the PRACK (Provisional Acknowledgment) method enables reliability to SIP provisional responses (1xx series). This is very important in order to support PSTN internetworking. To invoke a reliable provisional response, the 100rel tag is appended to the value of the required header of the initial signaling messages. The default setting is No.
SIP Transport	Selects the SIP transport method. There are three types: TCP, UDP and TLS.
Symmetric RTP	Selects whether or not symmetric RTP is supported.
Support SIP Instance ID	Selects whether or not SIP Instance ID is supported.
Validate Incoming Messages	This configuration selects whether or not the incoming messages should be validated.

SIP T1 Timeout	This configures the timeout period for SIP T1. The default setting is 0.5 Seconds.
SIP T2 Interval	This configures the time interval for SIP T2. The default setting is 4 seconds.
Remove OBP from route	The SIP Extension notifies the SIP server that it is behind a NAT/firewall.

Account/Codec Settings

Start Video Automatically	--YES: Accepts all incoming video, this is the default setting; --NO: video is disabled. --Enable/Disable during dialing: Dialing time choice to enable/disable video
DTMF	Assigns the mechanism to send DTMF. There are three supported modes: in audio (with DTMF as audio signals), through RTP and through SIP INFO.
DTMF Payload Type	Sends DTMF using RFC2833. The default is 101.
Preferred Vocoder	This products supports up to 8 different Vocoders: including G.711(a/μ)(PCMU/PCMA),GSM,G726-32,G.723.1,G.729A/B, G.722 and L16-256. When this has been configured, the system will select the preferred vocoder from the list and the same order is sent with the SDP messages. The user can change the preferred vocoder priority order by toggling with the up and down buttons. It is recommended to use the default setting "PCMU"; if other vocoders are chosen, there could be an audio transmission error.
Preferred Video Codec	Selects the preferred video codec from the available list. It is recommended to use H.264.
Enable RFC5168 support	Select YES to enable RFC5168 support. The default is set to NO.
Video Bit Rate	Rate of information content in a video stream. (Ranges from 32 – 1024 kbps)
H.264 Image Size	Select the type of H.264 compression (4CIF, VGA, WQVGA, CIF, QVGA, QCIF, QQVGA)
H.264Payload type	Selects the dynamic H.264 codec payload type (ranges from 96-127). The default setting is 99.
H.263+ Payload type	Selects the H.263+ codec payload type (ranges from 96-127). The default setting is 103.
L16-256 Payload type	Selects the L16-256 codec payload type (ranges from 96-127). The default setting is 103.
H.263 Encoder Resolution	Selects the resolution (CIF/QCIF) used for H.263 codec. The default resolution is CIF.
SRTP Mode	This is option to secure the RTP audio

Silence Suppression	This controls the G723/G729 silence suppression/VAD. If set to YES, when no audio is detected, the phone will send a small number of VAD packets (instead of audio packets). If Set to NO, this feature is disabled. The default setting is NO.
Voice Frame per TX	<p>This configures the number of voice frames transmitted per packet. (It is recommended to set this based on the Ethernet IS packet limitation – 1500 Byte or 120kb/s).</p> <p>When configuring this, it should be noted that the “ptime” value for the SDP will change with different configurations here. This value is related to the codec used and the actual frames transmitted during the in payload call.</p> <p>For example: if the codec is configured to be G.723 and “Voice Frames per TX” is set to 2. Then in the INVITE request, the “ptime” value for SDP will be 60 ms. This is because the G723 voice frame is 30 ms. Similarly, if the setting is 2 and the codec is G729 or G711 or G726, the “ptime” value for SDP in the INVITE request will be 20 ms.</p> <p>If the voice frames per TX configuration exceeds the maximum value allowed, the phone will choose the preferred codec and use the maximum value allowed.</p> <p>The maximum value is 64 frames.</p> <p>Adjusting these values will also change the jitter buffer. The phone has an algorithm for setting the jitter buffer and the jitter buffer rate is around 20-200ms.</p> <p>For end-users, it is recommended to use the default setting, as incorrect settings may influence the quality of audio.</p>
G723 Rate	This defines the encoding rate for G723 vocoder, and can be 6.3Kb/s or 5.3Kb/s. Please confirm with your service provider.
Jitter Buffer Type	Users can select either Fixed or Adaptive based on network conditions. The default is Adaptive.
Jitter Buffer Length	User can select Low, Medium, or High based on network conditions. The default is Medium.

Account/Call Settings

Dial Plan Prefix	Sets the prefix added to each dialed number.
Dial Plan	<p>Dial Plan Rules:</p> <ol style="list-style-type: none"> 1. Accepted Digits: 1,2,3,4,5,6,7,8,9,0 , * , #, A,a,B,b,C,c,D,d 2. Grammar: x - any digit from 0-9;

- a) xx+ - at least 2 digit numbers
- b) xx. - only 2 digit numbers
- c) ^ - exclude
- d) [3-5] - any digit of 3, 4, or 5
- e) [147] - any digit of 1, 4, or 7
- f) <2=011> - replace digit 2 with 011 when dialing
- g) | - the OR operand

• Example 1: {[369]11 | 1617xxxxxxx}

Allow 311, 611, and 911 or any 10 digit numbers with leading digits 1617

• Example 2: {^1900x+ | <=1617>xxxxxxx}

Block any number of leading digits 1900 or add prefix 1617 for any dialed 7 digit numbers

• Example 3: {1xxx[2-9]xxxxxx | <2=011>x+}

Allows any number with leading digit 1 followed by a 3 digit number, followed by any number between 2 and 9, followed by any 7 digit number OR Allows any length of numbers with leading digit 2, replacing the 2 with 011 when dialed.

3. Default: Outgoing – {x+}

Allow any length of numbers.

Example of a simple dial plan used in a Home/Office in the US:

{ ^1900x. | <=1617>[2-9]xxxxxx | 1[2-9]xx[2-9]xxxxxx | 011[2-9]x. | [3469]11 }

Explanation of example rule (reading from left to right):

- ^1900x. - prevents dialing any number started with 1900
- <=1617>[2-9]xxxxxx - allows dialing to local area code (617) numbers by dialing

7 numbers and 1617 area code will be added automatically

- 1[2-9]xx[2-9]xxxxxx |- allows dialing to any US/Canada Number with 11 digits

length

- 011[2-9]x. - allows international calls starting with 011
- [3469]11 - allow dialing special and emergency numbers 311, 411, 611 and 911

NOTE: In some cases where the user wishes to dial strings such as *123 to activate voice mail or other applications provided by their service provider, the * should be predefined inside the dial plan feature. An example dial plan will be: { *x+ } which allows the user to dial * followed by any length of

	numbers.
Early Dial	The default setting is NO. Use only if the proxy supports 484 response.
Refer to Use Target Contact	The default is NO. If set to YES, then for Attended Transfer, the “Refer-To” header uses the transferred target’s contact header information.
Auto Answer	The default setting is NO. If it is set to YES, the GXV3175 will play a “beep” sound and answer the phone automatically on the speaker.
Send Anonymous	If set to YES, the “From” header in the outgoing SIP messages will be set to anonymous to block the caller ID from displaying. The default setting is NO.
Anonymous Call Rejection	The default setting is NO; If set to YES, any anonymous call will be rejected (with 486 Busy message)
Call Log	Options to log calls are Log All, Log Incoming/Outgoing Only(missed calls will not be recorded), Disable All
Special Feature	Different soft switch vendors have special requirements; therefore users may need to select special features to meet these requirements. Users can choose from Standard, CBCOM, RNK, China Mobile, ZTE IMS and Mobotix depending on their need. The default setting is Standard.
Feature Key Sync	Default is “No”. This option is to synchronize DND/Call Forward features with Broadsoft . When set to “Yes”, a SUBSCRIBE will be sent out periodically to the server. Then when DND/Call Forward features Call Forward No Answer, Unconditional Call Forward and Call Forward on Busy) are configured or changed on the phone and the Broadsoft server side, those features will be synchronized on the phone side and the Broadsoft server side.
Enable Call Features	The default is set to YES. If it is set to NO, call features are disabled.
Call Forward Unconditional	Sets the number to forward to unconditionally.
Call Forward When Busy	Sets the number to forward to when busy.
Call Forward When No Answer	Sets the number to forward to when no answer.
Delayed Call Forward Wait Time (s)	The wait time before transferring the call to another extension or to voicemail; the default setting is 20 seconds.
No Key Entry Timeout (s)	Defines the time out duration on no key entry. Default setting is 4 seconds.
Ring Timeout (s)	Defines the time out duration on no answer. Default setting is 60 second.
Transfer on Conference	Defines whether or not the call is transferred to the other party if the initiator

Hangup	of the conference hangs up. Default setting is set to No.
Use # as Dial Key	Selects whether or not # is used as Send.
Account ring tone	This allows the user to configure the general ringtone used for this account. Users can choose from different ringtones from the dropdown menu. They can also upload mp3 files in Ringtone manager for their own ringtone.
Ring Tone	Users can select up to 3 distinctive ringtones to match incoming caller ID. Users can choose from different ringtones from the dropdown menu. They can also upload mp3 files in Ringtone manager for their own ringtone.

SAVING THE CONFIGURATION CHANGES

After users makes changes to the configuration, press the “Save” button in the Configuration Menu. The web browser will then display a message window to confirm the saved changes. Reboot the phone for the new settings to take effect if the settings that you have changed have a * next to it.

REBOOTING FROM REMOTE LOCATIONS

Press the “Reboot” button at the top right-hand corner of the configuration menu to reboot the phone remotely. The web browser will then display a message window to confirm with the user if they wish to reboot the phone or not. Click on “Yes” and the phone will reboot. Wait approximately 2 minutes to log in again.

CUSTOMIZING THE GXV3175 IP MULTIMEDIA PHONE

XML GUI CUSTOMIZATION GUIDE

The GXV3140 IP Multimedia Phone allows users to customize the GUI desktop layout as well as GUI configurations on the phone, offering users with flexibility and control. This includes display/hide certain applications, configure parameters on the phone with specific configuration files, control the display appearance and enable/disable some applications and much more.

For more details on the XML Based GUI Configuration on the GXV3175, please refer to:

[XML GUI Customization Guide](#)

[GXV3175 XML GUI Customization Config Tool and Examples](#)

GMI GUIDE

GMI (Grandstream Manager Interface) is a management API developed by Grandstream Networks. Designed for our IP Multimedia phones, it allows partners to develop customized applications on the phone.

GMI supports standard HTML/CSS/JavaScript, users can use these dynamic web page development languages to develop their customized application. GMI will display the application on the phone based on the web pages generated.

Additionally, GMI provides several basic API functions (packaged in JavaScript) to facilitate users calling the existing applications on the multimedia phone or to obtain the phone status etc. This allows users with basic web application programming skills to develop their customized application on the multimedia phone, without the effort of learning a new

programming language. All that is required for the user is to understand how the GMI works and how to use these simple APIs to interact with the phone.

For more details on the GXV3175 GMI Configuration, please refer to:

[GXV3175 GMI Guide](#)

[GXV3175 GMI Example 1](#)

[GXV3175 GMI Example 2](#)

SOFTWARE UPGRADE

The GXV3175 can be upgraded via TFTP/HTTP/HTTPS by configuring the URL/IP Address for the TFTP/HTTP/HTTPS server and selecting a download method. To configure a valid URL for TFTP or HTTP, the server name can be the FQDN or IP address format. Examples of valid URLs:

1. fw.ipvideotalk.com/gs
2. 72.172.83.110

There are two ways to setup a software upgrade server: Via Menu or the Web Configuration Interface.

UPGRADE VIA MENU

In “Menu”->“System Settings”->“Maintenance”, users could configure the software upgrade server through the menu in the phone. In the “Upgrade” subpage, users may then select the upgrade mode and enter the IP address or FQDN of the Firmware server and the System Config server. After making the changes, press save to apply the new settings and reboot the device for upgrading.

UPGRADE VIA WEB BROWSER CONFIGURATION PAGE

Open a web browser and enter the IP address for the GXV3175. Next, log in with the administrator username and password. Under Maintenance, select “Upgrade and provisioning”, enter the IP address or the FQDN (URL) of the upgrade server and choose to upgrade via TFTP or HTTP/HTTPS. Save the changes and reboot the unit.

At this moment, the LCD will display the progress of the software download/upgrade. Please do not disrupt or power down the unit.

NOTE: The software upgrade will last up to 5 minutes (through the LAN side) and may take longer when upgrading through the Internet (limited by the network bandwidth). Grandstream recommends downloading and upgrading the software in a controlled LAN environment.

NO LOCAL TFTP SERVERS

For users without a local TFTP server, Grandstream offers a NAT-friendly TFTP server. This enables users to download the latest software upgrades for their phone via this server. Please refer to the webpage: <http://www.grandstream.com/firmware.html>.

Alternatively, users can download a free TFTP or HTTP server and conduct a local firmware upgrade. A free windows version TFTP server is available for download from <http://support.solarwinds.net/updates/New-customerFree.cfm> or <http://tftpd32.jounin.net/>.

Instructions for local firmware upgrade:

1. Unzip the firmware files and put all of them in the root directory of the TFTP server.
2. Connect the PC running the TFTP server and the GXV3175 device to the same LAN segment.
3. Launch the TFTP server and go to the File menu -> Configure -> Security to change the TFTP server's default setting from "Receive Only" to "Transmit Only" for the firmware upgrade.
4. Start the TFTP server and configure the TFTP server in the phone's web configuration interface.
5. Configure the Firmware Server Path to the IP address of the PC.
6. Update the changes and reboot the GXV3175.

End users can also choose to download a free HTTP server from <http://httpd.apache.org/> or use Microsoft IIS web server.

RESTORE FACTORY DEFAULT SETTINGS

WARNING: Restoring the Factory Default Settings will **delete** all configuration information on the phone. Please **backup** or **print** all the settings before you restore to the factory default settings. Grandstream is not responsible for restoring lost parameters and cannot connect your device to your VoIP service provider.

There are two methods to restore the GXV3175 to the factory default settings.

RESTORE TO FACTORY DEFAULT SETTINGS VIA LCD MENU

The steps to restore the phone to factory default settings through the LCD menu are as follows:

Step 1: Select MENU to access the phone menu and select System Settings.



Step 2: Select Maintenance and navigate to Upgrade page.

Step 3: Select the Factory Reset option.

Step 4: Press “OK”. The phone will reboot and perform a factory reset.

After factory reset, users will need to do calibration before the phone’s main screen show up.

RESTORE TO FACTORY DEFAULT SETTINGS VIA THE WEB INTERFACE

Step 1: Login to the system configuration page through a web browser and select “Maintenance”. From the menu on the left, select “Upgrade”.

Step 2: At the bottom of the “Upgrade” page, click on the “Reset” button for Factory reset after selecting the degree of factory reset (Full Reset/User Data Reset/VoIP Data Reset).

Step 3: Click on OK to restore the phone to factory settings.

CE1177

FCC Warning

This device complies with part 15 of the FCC Rules. Operation is subject to the following two conditions: (1) This device may not cause harmful interference, and (2) this device must accept any interference received, including interference that may cause undesired operation. Any Changes or modifications not expressly approved by the party responsible for compliance could void the user's authority to operate the equipment.

RF

This equipment complies with FCC's and IC's RF radiation exposure limits set forth for an uncontrolled environment. The antenna(s) used for this transmitter must be installed and operated to provide a separation distance of at least 20 cm from all persons and must not be collocated or operating in conjunction with any other antenna or transmitter. Installers must ensure that 20cm separation distance will be maintained between the device (excluding its handset) and users.

15.105B

For a Class B digital device or peripheral, the instructions furnished the user shall include the following or similar statement, placed in a prominent location in the text of the manual: Note: This equipment has been tested and found to comply with the limits for a Class B digital device, pursuant to part 15 of the FCC Rules. These limits are designed to provide reasonable protection against harmful interference in a residential installation. This equipment generates, uses and can radiate radio frequency energy and, if not installed and used in accordance with the instructions, may cause harmful interference to radio communications. However, there is no guarantee that interference will not occur in a particular installation. If this equipment does cause harmful interference to radio or television reception, which can be determined by turning the equipment off and on, the user is encouraged to try to correct the interference by one or more of the following measures: —Reorient or relocate the receiving antenna. —Increase the separation between the equipment and receiver. —Connect the equipment into an outlet on a circuit different from that to which the receiver is connected. —Consult the dealer or an experienced radio/TV technician for help.

15.21 Statement:

Information to user: the user's manual or instruction manual for an intentional or unintentional radiator shall caution the user that changes or modifications not expressly approved by the party responsible for compliance could void a sample statement is below: Note: The manufacturer is not responsible for any radio or TV interference caused by unauthorized modifications to this equipment. Such modifications could void the user's authority to operate the equipment.



EXPERIENCING THE GXV3175 MULTIMEDIA PHONE

Please visit our website: <http://www.grandstream.com> to receive the most up- to-date updates on firmware releases, additional features, FAQs, documentation and news on new products.

We encourage you to browse our [product related documentation](#), [FAQs](#) and [User and Developer Forum](#) for answers to your general questions. If you have purchased our products through a Grandstream Certified Partner or Reseller, please contact them directly for immediate support.

Our technical support staff is trained and ready to answer all of your questions. Contact a [technical support member](#) or [submit a trouble ticket online](#) to receive in-depth support.

Thank you again for purchasing Grandstream GXV3175 Touchscreen IP Multimedia phone, it is sure to bring convenience and color to both your business and personal life.