



# Grandstream Networks, Inc.

---

GXV3672\_HD/GXV3672\_FHD

Outdoor Day/Night IP Camera



**TABLE OF CONTENTS**  
GXV3672\_HD/FHD User Manual

<b>WELCOME.....</b>	<b>4</b>
SAFETY COMPLIANCES.....	5
WARRANTY.....	6
<b>CONNECT YOUR GXV3672_HD/FHD.....</b>	<b>7</b>
EQUIPMENT PACKAGE CONTENTS.....	7
CONNECTING THE GXV3672_HD/FHD .....	8
<b>PRODUCT OVERVIEW .....</b>	<b>9</b>
GXV3672_HD/FHD CAMERA.....	9
GXV3672_HD/FHD SPECIFICATIONS .....	10
<b>INSTALLATION GUIDE .....</b>	<b>11</b>
MINIMUM RECOMMENDED COMPUTER SYSTEM REQUIREMENT.....	11
CONFIGURE THE GXV3672_HD/FHD VIA WEB BROWSER .....	11
GXV3672_HD/FHD HOME WEB PAGE.....	14
GXV3672_HD/FHD CONFIGURATION & LANGUAGE PAGE .....	15
<b>BASIC SETTINGS EXPLANATION .....</b>	<b>16</b>
SYSTEM SETTINGS PAGE .....	16
VIDEO & AUDIO SETTING PAGE .....	17
CMOS SETTINGS PAGE.....	19
NETWORKING SETTING PAGE .....	20
DDNS SETTINGS PAGE .....	21
SIP SETTING PAGE.....	22
STATUS PAGE.....	24
<b>ADVANCED SETTINGS EXPLANATION.....</b>	<b>25</b>
USER MANAGEMENT PAGE.....	25
MAINTENANCE PAGE.....	26
SMTP SETTING PAGE (EMAIL ALARM).....	27
FTP SETTINGS PAGE (UPLOAD ALARM).....	28
ALARM SERVER SETTINGS PAGE (UPLOAD ALARM TO SUPPORTED VMS OR HTTP SERVER) .....	29
MOTION DETECTION CONFIGURATION PAGE (SET ALARM) .....	30
SYSLOG SETTINGS PAGE (TROUBLESHOOTING) .....	32
SOFTWARE UPGRADE .....	33
SOFTWARE UPGRADE VIA TFTP, HTTP OR HTTPS.....	33
INSTRUCTIONS FOR LOCAL FIRMWARE UPGRADE USING TFTP SERVER: .....	34
CONFIGURATION FILE DOWNLOAD .....	34
<b>RESTORE FACTORY DEFAULT SETTING.....</b>	<b>35</b>
RESET FROM WEB INTERFACE.....	35
<b>IP SURVEILLANCE FAQ .....</b>	<b>36</b>

**TABLE OF FIGURES**  
GXV3672\_HD/FHD USER MANUAL

FIGURE 1: HOME PAGE OF GXV3672_HD/FHD .....	14
FIGURE 2: WEB LANGUAGE SWITCH .....	15
FIGURE 3: SYSTEM SETTINGS PAGE.....	16
FIGURE 4-1: VIDEO & AUDIO SETTINGS PAGE.....	17
FIGURE 4-2: VIDEO & AUDIO SETTINGS PAGE.....	18
FIGURE 5: CMOS SETTINGS PAGE.....	19
FIGURE 6: NETWORKING SETTING PAGE.....	20
FIGURE 7: DDNS SETTING PAGE.....	21
FIGURE 8-1: SIP SETTING PAGE.....	22
FIGURE 8-2: SIP SETTING PAGE.....	23
FIGURE 9: STATUS PAGE.....	24
FIGURE 10: USER MANAGEMENT PAGE .....	25
FIGURE 11: MAINTENANCE PAGE .....	26
FIGURE 12: SMTP SETTING PAGE .....	27
FIGURE 13: FTP SETTING PAGE.....	28
FIGURE 14: ALARM HTTP SERVER SETTING PAGE .....	29
FIGURE 15-1: MOTION DETECTION CONFIGURATION PAGE.....	30
FIGURE 15-2: MOTION DETECTION SCHEDULE CONFIGURATION PAGE .....	31
FIGURE 16: ALARM SERVER SETTING PAGE .....	32
FIGURE 17: FIRMWARE UPGRADE AND PROVISIONING .....	33
FIGURE 18: FACTORY RESET FROM WEB INTERFACE .....	35

**TABLE OF TABLES**  
GXV3672\_HD/FHD USER MANUAL

TABLE 1: GXV3672_HD/FHD TECHNICAL SPECIFICATIONS.....	10
---	----

## WELCOME

Thank you for purchasing Grandstream's GXV3672\_HD/FHD Outdoor Day/Night High Definition IP Camera, an innovative powerful weatherproof infrared next generation network camera. Its advanced ISP (Image Sensor Processor) powered with state-of-the-art auto-exposure/auto-white-balance algorithm and a high quality lens, ensures high fidelity video quality that matches digital still camera color grade in a wide range of light environments. It features cutting edge H.264 real-time video compression with excellent image clarity (720p for GXV3672HD; 1080p for GXV3672\_FHD) and color fidelity, industry leading SIP/VoIP for video streaming to smartphones and video phones, integrated PoE, IR-CUT (mechanical) for day or night mod, and advanced security protection using strong encryption. The GXV3672\_HD/FHD can be managed with GSurf\_Pro, Grandstream's intuitive FREE VMS (video management systems) software that controls up to 36 cameras (\*) simultaneously; or record video using GSNVR, Grandstream's FREE network and PC based DVR (digital video recorder) software. It is fully compliant with ONVIF standard and offers flexible HTTP API and an SDK for advanced integration.

The GXV3672\_HD/FHD Outdoor Day/Night IP camera is a new addition to the popular GXV3XXX series IP surveillance product family. It ensures ease of use, integration and deployment, with multilingual graphical user interface, provides powerful solution to professional surveillance applications in outdoor environment.

This manual will help you to learn how to operate and manage your GXV3672\_HD/FHD Outdoor Day/Night HD IP camera and make the best use of it.

### **FCC Part 15 Rules**

This device is compliant with Part 15 of the FCC Rules. Operation is subject to the following two conditions: 1. This device may not cause harmful interference.

2. This device must accept any interference received, including interference that may cause undesired operation.

### **Class B Digital Device or Peripheral**

**Note:** This device is tested and complies with the limits for a Class B digital device, pursuant to Part 15 of the FCC Rules. These limits are designed to provide reasonable protection against harmful interference in a residential installation. This equipment generates, uses, and can radiate radio frequency energy and, if not installed and used in accordance with the instructions, may cause harmful interference to radio communications. However, there is no guarantee that interference will not occur in a particular installation. If this equipment does cause harmful interference to radio or television reception, which can be determined by turning the equipment off and on, the user is encouraged to try to correct the interference by one or more of the following measures: 1. Reorient or relocate the receiving antenna. 2. Increase the separation between the equipment and receiver. 3. Connect the equipment into an outlet on a circuit different from that to which the receiver is connected. 4. Consult the dealer or an experience radio/TV technician for help.

## Safety Compliances

These instructions are intended to assist users with the operation of the GXV3672\_HD/FHD and to instruct on how to avoid dangerous situations or damage to the device.

**Warnings:** Serious injury or death may be caused if any of the warnings below are neglected.  
**Cautions:** Injury or damage to the equipment may occur if any of the following caution messages are neglected.



**Warnings** Follow these safeguards to prevent serious injury or death.



**Cautions** Follow these precautions to prevent potential injury or material damage.



### Warnings:

Input voltage should meet both the SELV (Safety Extra Low Voltage) and the Limited Power Source with DC 12V according to the IEC60950-1 standard. Please refer to the technical specifications for more details.

Do not use a third-party power adapter or power cord

When the device is installed on the wall or ceiling, make sure that it is firmly attached.



### Notice,

Make sure that the power supply voltage is correct before using the camera.

Do not drop the device or expose it to physical shock.

Do not expose the device to temperatures outside the range of -10°C to +60°C when the device is in operation.

Do not expose the device to damp/wet conditions or high electromagnetism radiation.

To avoid heat accumulation, make sure that your operating environment has proper ventilation.

Do not attempt to open, disassemble, or modify the device

A few parts (e.g. electrolytic capacitor) of the equipment shall be replaced regularly according to their average life time. The average life time varies from the differences between operating environments and usage history. Regular maintenance checks are recommended for all users. Please contact your dealer for more details.

## Warranty

If you purchased your GXV3672\_HD/FHD from a reseller, please contact the company where you purchased the device for replacement, repair or refund.

If you purchased the product directly from Grandstream, please contact your Grandstream Sales and Service Representative for a RMA (Return Materials Authorization) number before you return the product. Grandstream reserves the right to remedy warranty policy without prior notification.

### **Caution:**

*Changes or modifications to this product not expressly approved by Grandstream, or operation of this product in any way other than as detailed by this User Manual, could void your manufacturer warranty. Please do not use a different power adaptor with the GXV3672\_HD/FHD as it may cause damage to the products and void the manufacturer warranty.*

- This document is subject to change without notice. The latest electronic version of this user manual is available for download at:  
[http://www.grandstream.com/products/surveillance/gxv3672hd/documents/gxv3672hd\\_fhd\\_usermanual\\_english.pdf](http://www.grandstream.com/products/surveillance/gxv3672hd/documents/gxv3672hd_fhd_usermanual_english.pdf)

*Reproduction or transmittal of the entire or any part, in any form or by any means, electronic or print, for any purpose is not permitted without the express written permission of Grandstream Networks, Inc.*

## CONNECT YOUR GXV3672\_HD/FHD

### Equipment Package Contents

The GXV3672\_HD/FHD package contains:

- GXV3672\_HD/FHD IP Camera
- 12V DC Universal Power Adaptor
- Ethernet Cable
- Hex Key and 3 Screws and Wall Anchors
- Quick Installation Guide



1 x GXV3672\_HD



1 x 12V Power Supply



1 x Ethernet Cable



3 x Wall Anchors



3 x Screw



1 x Hex Key



1 x Quick Start Guide

## Connecting the GXV3672\_HD/FHD

### Using the Power Adapter as power supply

- Connect the RJ-45 Ethernet cable to the NETWORK port of the GXV3672\_HD/FHD
- Connect the other end of the RJ-45 cable to your network (switch or router or PC)
- Connect the power supply to the DC 12V power jack on the back of the GXV3672\_HD/FHD

### Using PoE as power supply

- Connect the RJ-45 Ethernet cable to the NETWORK port of GXV3672\_HD/FHD
- Connect the other end of the RJ-45 cable to your PoE switch.

Please refer to following connection diagram to hook up the camera.

Refer to the illustration below when following the instructions on the next page.

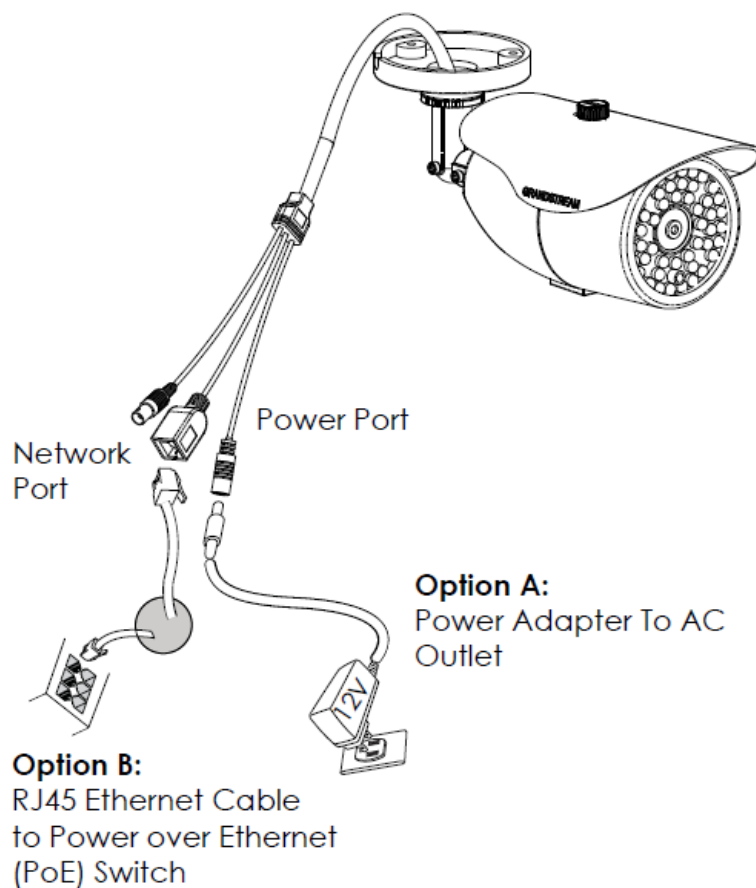

**NOTE:** Choose Option A if using the power supply; or choose Option B if using a Power over Ethernet (PoE) switch.



## PRODUCT OVERVIEW

### GXV3672\_HD/FHD Camera

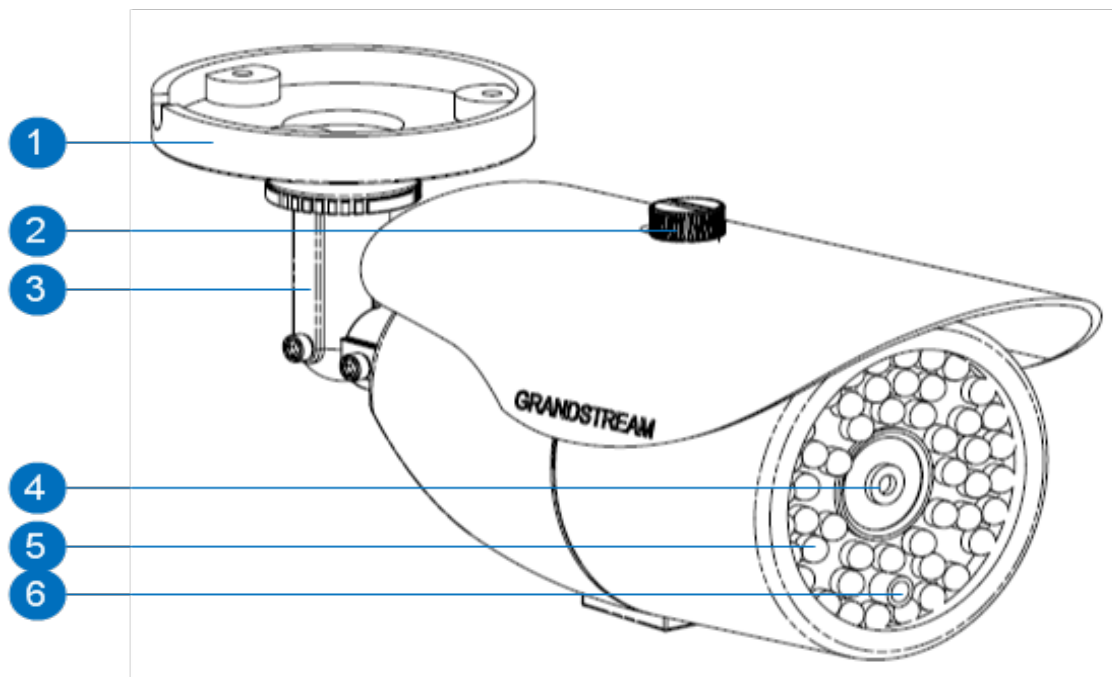

- |   |   |
|---|---|
| <ol style="list-style-type: none"> <li>1. <i>Mounting Plate</i></li> <li>2. <i>Top Shield Cover/Screw</i></li> <li>3. <i>Adjustable Wire Shield</i></li> <li>4. <i>Lens</i></li> <li>5. <i>IR Light Array</i></li> <li>6. <i>Light Sensor for IR-Cut</i></li> </ol> | <p>GXV3672_HD/FHD Mounting Plate</p> <p>Top metal cover (shielding direct light and rain, etc.)</p> <p>Adjustable cylinder for wiring shield</p> <p>1/3" CMOS (1.2M for HD/3.1M for FHD) and Lens</p> <p>Infrared Light Array</p> <p>Light Sensor for mechanical IR-Cut switching</p> |
|---|---|

## GXV3672\_HD/FHD Specifications

Table 1: GXV3672\_HD/FHD Technical Specifications

Model	GXV3672_HD_28/80	GXV3672_FHD_28/80
<b>Video Compression</b>	H.264, MJPEG	
<b>Image Sensor Resolution</b>	1/3", 1.2 Megapixel CMOS, 1280H x 960V	1/3", 3.1 Megapixel CMOS, 2048H x 1536V
<b>Image Sensor Sensitivity</b>	Day & night mode, exceptionally low noise levels and low-light sensitivity. Shutter: 1/10000 – 1/30 second	
<b>Focal Length</b>	GXV3672_HD/FHD_28: 2.8mm GXV3672_HD/FHD_80: 8 mm	
<b>Aperture</b>	GXV3672_HD/FHD_28: F2.0 GXV3672_HD/FHD_80: F1.8	
<b>Field Angle (FOV)</b>	GXV3672_HD/FHD_28: 125°(D) x 100°(H) x 73.5°(V) GXV3672_HD/FHD_80: 46°(D) x 36°(H) x 26.5°(V)	
<b>IR Cut Filter</b>	Yes, Mechanical	
<b>Day &amp; Night Mode</b>	GXV3672_HD/FHD_28: Infrared LED covering up to 10m GXV3672_HD/FHD_80: Infrared LED covering up to 30m	
<b>Minimum Illumination</b>	0.05lux; 0 lux with IR LED On	
<b>Responsivity</b>	5.48V/lux-sec (550nm)	1.9V/lux-sec (550nm)
<b>Pixel Dynamic Range</b>	Wide Dynamic Range of 120dB with SNR <sub>MAX</sub> 44dB	Wide Dynamic Range of 100dB with SNR <sub>MAX</sub> 39dB
<b>Supported Maximum Video Resolution and Frame Rate</b>	1280x960 (25fps) 1280x720 (30fps)	2048x1536 (15fps) 1920x1080 (30fps)
<b>Video Bit Rate</b>	32 Kbps ~ 8 Mbps, Multi-rate for Viewing & Recording	
<b>Audio Input</b>	Line-In, 1500 ohms, 0.1Vrms ~ 0.707Vrms	
<b>Audio Output</b>	Line-Out, 600 ohms, 0.707Vrms	
<b>Audio Compression</b>	G.711u/a, AAC	
<b>Embedded Analytics</b>	Motion Detection (up to 16 target areas)	
<b>Pre-/post-alarm Buffer</b>	8MB	3MB
<b>Snapshots</b>	Triggered upon events; Send via email/FTP	
<b>Network Protocol</b>	TCP/UDP/IP, RTP/RTCP, RTSP, DHCP, DDNS, HTTP, HTTPS, SMTP, FTP, NTP	
<b>SIP/VoIP Support</b>	Yes	
<b>Power over Ethernet (PoE)</b>	IEEE 802.3af, Class 0	
<b>External Cable Connection</b>	Network: RJ45, 10M/100M Auto-Sensing 3.5mm Line-In 3.5mm Line-Out Power Input	
<b>Dimensions (D x L)</b>	94mm (D) x 230mm (L)	
<b>Weight</b>	0.52Kg	
<b>Temperature / Humidity</b>	Operating: -20°C ~ 50°C (-4°F ~ 122°F) Humidity 10–90% RH (non-condensing) Storage: -30°C ~ 60°C (-22°F ~ 140°F)	
<b>Power Adapter</b>	Output: 12VDC/1A; Input: 100–240VAC, 50–60Hz	
<b>Casing</b>	IP66 Compliant Weather-Proof Metal Case	
<b>Compliance</b>	FCC Part 15, Subpart B Class B; EN 55022 Class B; EN 61000-3-2; EN 61000-3-3; EN 55024; EN 60950-1; C-tick AS/NZS CISPR 22	

## INSTALLATION GUIDE

### Minimum Recommended Computer System Requirement

To install GXV3672\_HD/FHD, you have to have a computer, PC recommend. The minimum recommended PC system requirement listed below:

- Windows 2000, XP, Windows Vista, Windows 7 (32bit or 64bit)
- CPU: Intel Pentium 4 or higher, 2 GHz
- RAM: 1 GB (4 GB recommended for larger systems)
- Support for DirectX 8.0 and above.

### Configure the GXV3672\_HD/FHD via Web Browser

The GXV3672\_HD/FHD has embedded Web server to respond to HTTP GET/POST requests. Embedded HTML pages allow user to configure the IP camera through Microsoft Internet Explorer (7.0 or above), Firefox or Chrome (firmware 1.0.1.75 above and Plug-in from Grandstream required).

- Download Web Control Plug-in from Grandstream website:  
[http://www.grandstream.com/products/tools/surveillance/webcontrol\\_plugin.zip](http://www.grandstream.com/products/tools/surveillance/webcontrol_plugin.zip)

### **NOTE:**

- *Apple Safari is NOT yet supported and status pending.*
- *Please temporarily disable Antivirus or Internet Security Software when download and install the Grandstream Webcontrol Plug-in for video or “GSViewerX.cab” for Microsoft Internet Explorer.*

## Connect the Camera to network with DHCP server (Recommended)

The GXV3672\_HD/FHD by default enabled as DHCP client, it will automatically get IP address from the network with DHCP server running. User can know the IP address assigned to the camera from DHCP server log or using “SearchTool” from Grandstream GSurf\_Pro free VMS software.

1. Download and install the GSurf\_Pro software from Grandstream website:  
[http://www.grandstream.com/products/tools/surveillance/gsurf\\_pro.zip](http://www.grandstream.com/products/tools/surveillance/gsurf_pro.zip)
2. Run the “Search Tool” in the pull down Menu of “Manage Tool” tag
3. Click on  button to begin device detection
4. The detected devices will appear in the Output field like below

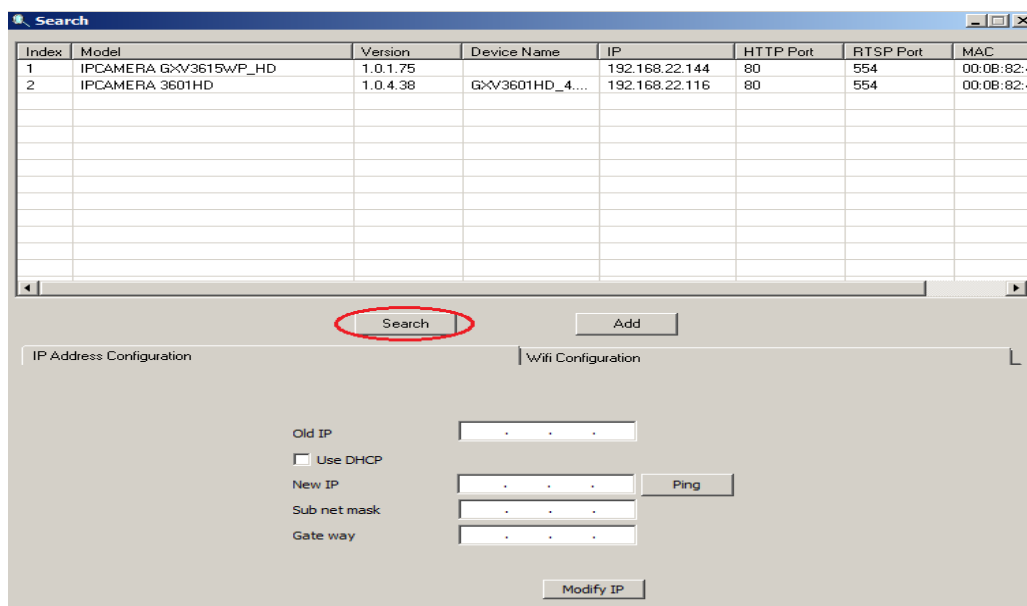

5. Double click the column of the detected camera, the browser will automatically open and link to the device IP and the web configuration page.
6. The browser will ask for plug-in or ActiveX if not installed, otherwise it will get to Home page and start to show the video captured by the camera (by default the camera enabled anonymous access)
7. Click “Configuration”, the browser will ask credentials to authorize configuration.
8. Enter the administrator user name and password to access the Web Configuration Interface, the default user name and password are both set to **admin**.
9. In step 6, IE will indicate that “This website wants to install the following add-on: GSViewerX.cab from Grandstream Networks Inc.”, allow the installation.
10. Firefox and Chrome user need to download and install the plug-in to see the video, the plug-in is here:  
[http://www.grandstream.com/products/tools/surveillance/webcontrl\\_plugin.zip](http://www.grandstream.com/products/tools/surveillance/webcontrl_plugin.zip)

### NOTE:

- Please temporarily disable Antivirus or Internet Security Software when download and install the Grandstream Plug-in for video or “GSViewerX.cab” for Microsoft Internet Explorer.

## Connect to the Camera using Static IP

If no DHCP server in the network, or the camera does not get IP from DHCP server, user can connect the camera to a computer directly, using static IP to configure the camera.

The default IP, if no DHCP server; or DHCP offer time out (3 minutes), is **192.168.1.168**

1. Connect the computer RJ-45 via an Ethernet cable directly to the IP camera GXV3672\_HD/FHD.
2. Configure the computer using Static IP: 192.168.1.XXX (1<XXX<255, but NOT 168) and configure the “Subnet mask” to “255.255.255.0”. Leave the “Default Gateway” to “Blank” like below:

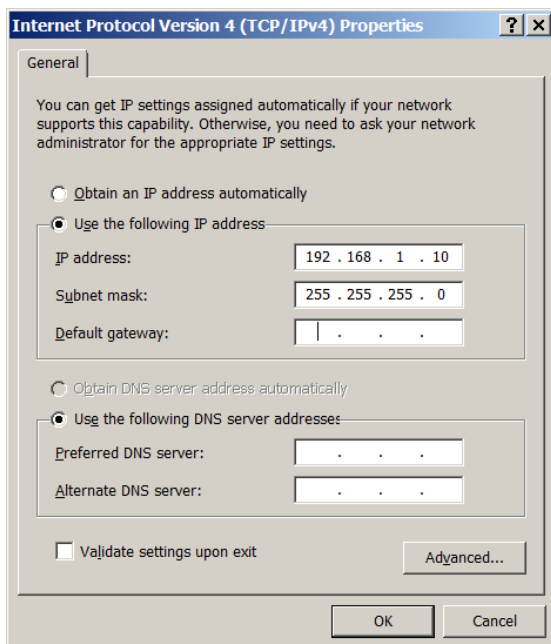

3. Power on the GXV3672\_HD/FHD.
4. Start the IE or Firefox browser when the network connection is up.
5. Enter 192.168.1.168 in the address bar of the browser.
6. The browser will ask for plug-in or ActiveX if not installed, otherwise it will get to Home page and start to show the video captured by the camera (by default the camera enabled anonymous access)
7. Click “Configuration”, the browser will ask credentials to authorize configuration.
8. Enter the administrator user name and password to access the Web Configuration Interface, the default user name and password are both set to **admin**.
9. In step 6, IE will indicate that “This website wants to install the following add-on: GSViewerX.cab from Grandstream Networks Inc.”, allow the installation.
10. Firefox, Chrome user need to download and install the plug-in to see the video, the plug-in is here: [http://www.grandstream.com/products/tools/surveillance/webcontrl\\_plugin.zip](http://www.grandstream.com/products/tools/surveillance/webcontrl_plugin.zip)

### NOTE:

- Please temporarily disable Antivirus or Internet Security Software when download and install the Grandstream Firefox plug-in for video or “GSViewerX.cab” for Microsoft Internet Explorer.

## GXV3672\_HD/FHD Home Web Page

The Home Page of GXV3672\_HD/FHD shown as Figure 1:

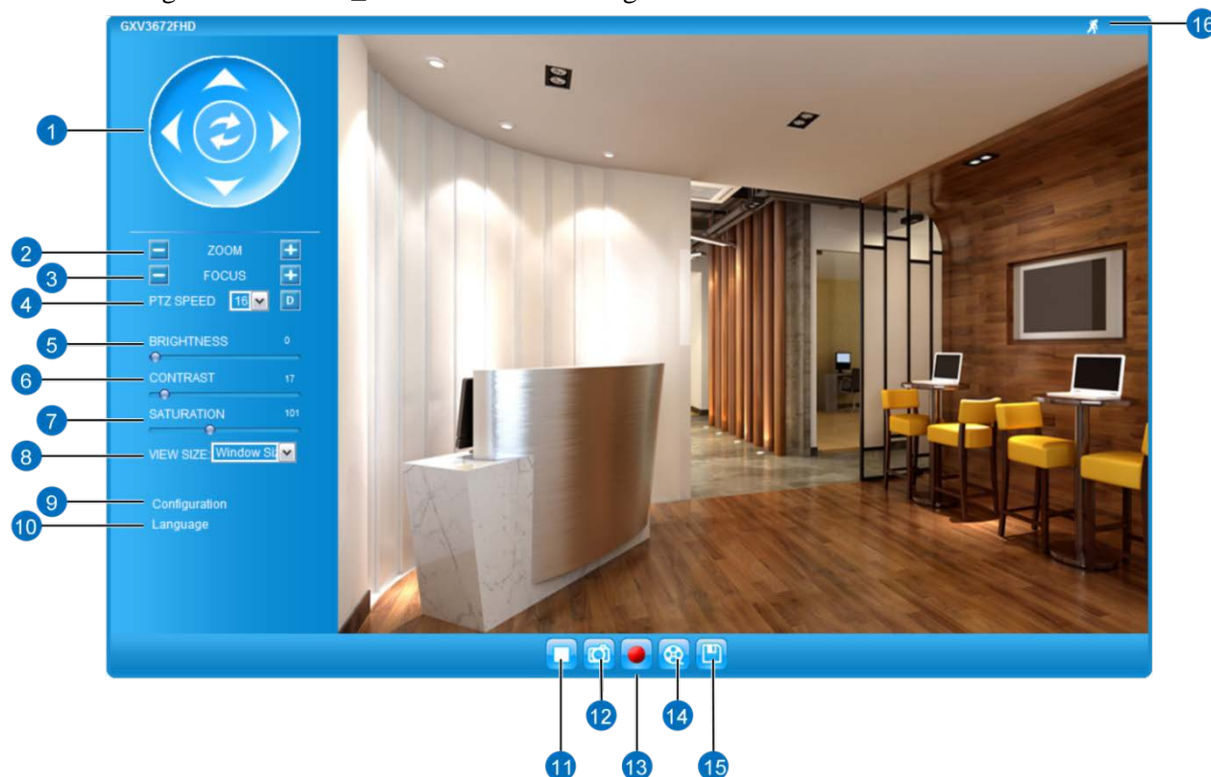

Figure 1: Home Page of GXV3672\_HD/FHD

- |   |   |
|---|---|
| <ol style="list-style-type: none"> <li>1. <b>Control Console:</b></li> <li>2. <b>ZOOM:</b></li> <li>3. <b>FOCUS:</b></li> <li>4. <b>PTZ SPEED/Default Button:</b><br/>“D”</li> <li>5. <b>BRIGHTNESS:</b></li> <li>6. <b>CONTRAST:</b></li> <li>7. <b>SATURATION:</b></li> <li>8. <b>View Size:</b></li> <li>9. <b>Configuration</b></li> <li>10. <b>Language:</b></li> <li>11. <b>Play/Stop:</b></li> <li>12. <b>Snapshot:</b></li> <li>13. <b>Record:</b></li> <li>14. <b>Playback:</b></li> <li>15. <b>Path of File Saved:</b></li> <li>16. <b>Motion Detection Alarm Indicator:</b></li> </ol> | <p>PTZ Console controller for ePTZ function.</p> <p>Zoom in or Zoom out during ePTZ operation.</p> <p>Adjust the focus of image (Not Applicable to GXV3672_HD/FHD).</p> <p>Adjust the rotate speed of the control console (Not Applicable); “Default Button” to reset the video brightness, contrast and saturation value from (auto or manual) adjusted value to factory default value.</p> <p>Adjust the image brightness (will automatic save it unless readjusted)</p> <p>Adjust the image contrast. (Same as above, auto save adjusted value)</p> <p>Adjust the image saturation. (Same as above)</p> <p>Pull down to select between “Window Size” or “Real Size” to display the embedded video stream at configured video resolution.</p> <p>Click to enter “Configuration Page” to configure the parameters of GXV3672_HD/FHD (Administration privilege required).</p> <p>Click to switch webpage language.<br/>(Current supported: Chinese, English and Russian)</p> <p>Start/Stop playing the video stream at embedded webpage.</p> <p>Click to capture and save a snapshot of current video frame displayed.<br/>Default directory: C:\Capture</p> <p>Click to Start/Stop record of current video stream into a file.<br/>Default directory: C:\Record</p> <p>Playback recorded video files</p> <p>Click to change the path of record/snapshot file saved.</p> <p>If motion detection alarm triggered, the indicator will flash in <b>red</b>.<br/>Click the indicator icon to turn off the alarm indication.</p> |
|---|---|

## GXV3672\_HD/FHD Configuration & Language Page

- When click the “Configuration” tab, web page will link to page to configure the related parameters of the GXV3672\_HD/FHD.
- There are two big categories of settings: Basic Settings and Advanced Settings. Details will be illustrated in the later Chapter.
- When click the “Language” tab, supported languages will be displayed in Figure 2. Click to select the related webpage display language.

**Figure 2: Web Language Switch**



- Currently firmware only support: English (default), Simplified Chinese and Russian.

## BASIC SETTINGS EXPLANATION

### System Settings Page

This page allow user to configure the system settings of GXV3672\_HD/FHD.

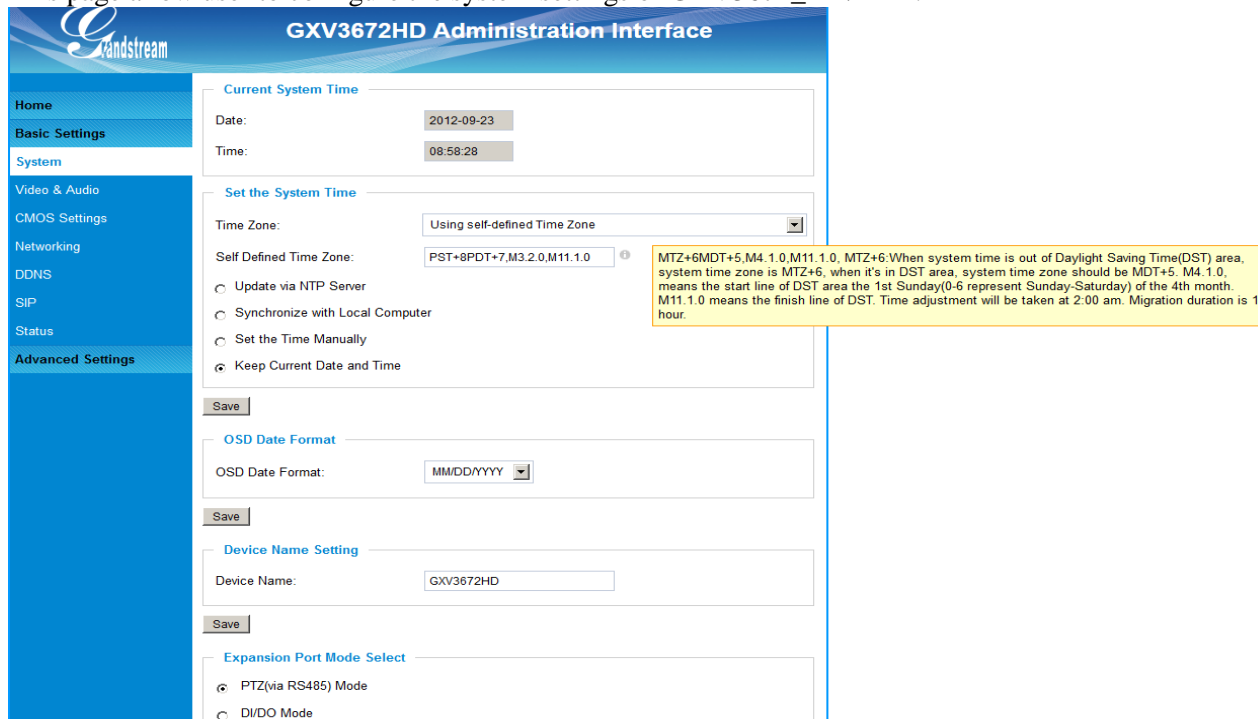

Figure 3: System Settings Page

- **Current System Time:** Display time current system is running at
- **Set the System Time:** Configure the time system is running.
  - **Time Zone:** Select from pull down menu the time zone unit located
  - **Self-Defined Time Zone:** Use the self-defined time zone for automatic daylight saving time adjustment. Format please refer to the “help over mouse”
  - **Update via NTP Server:** Synchronize time using NTP protocol with a Time Server over the Internet cloud (\*)
  - **Synchronize with Local Computer:** Synchronize time with local computer
  - **Set the Time Manually:** Manually input the time
  - **Keep Current D/T:** Select to use camera current displayed time
- **OSD Date Format:** Pull down to select date format displayed on video screen
  - **Device Name:** The name of device which will be shown in the result of “Search Tool” of GSurf\_Pro VMS program.
- **Expansion Port Mode Select:** The setting for external expansion interface module

#### NOTE:

(\*) If select this option, a valid DNS server must be preconfigured under **Basic Settings** → **Networking**

➤ **Save** button has to be clicked to save all the changes made to the device.



## Video & Audio Setting Page

This page allows user to configure the video and audio related settings.

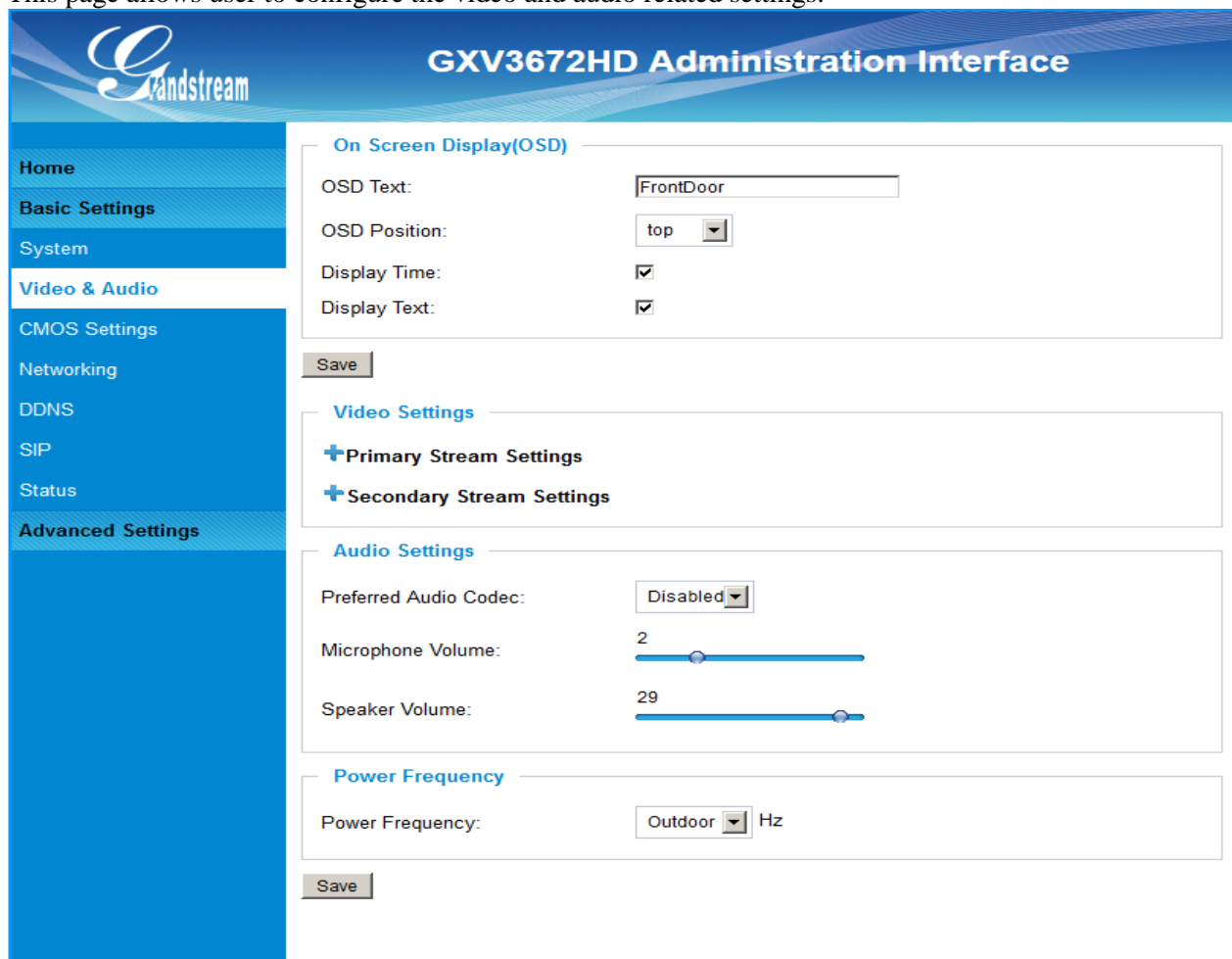

The screenshot shows the 'GXV3672HD Administration Interface' with a sidebar menu on the left containing: Home, Basic Settings, System, Video & Audio (selected), CMOS Settings, Networking, DDNS, SIP, Status, and Advanced Settings. The main content area is divided into three sections:

- On Screen Display(OSD)**: Includes fields for 'OSD Text' (FrontDoor), 'OSD Position' (top), 'Display Time' (checked), and 'Display Text' (checked). A 'Save' button is below.
- Video Settings**: Contains expandable sections for '+Primary Stream Settings' and '+Secondary Stream Settings'.
- Audio Settings**: Includes 'Preferred Audio Codec' (Disabled), 'Microphone Volume' (slider at 2), and 'Speaker Volume' (slider at 29). A 'Save' button is below.
- Power Frequency**: Includes 'Power Frequency' (Outdoor Hz) with a dropdown menu. A 'Save' button is below.

Figure 4-1: Video & Audio Settings Page

- **On Screen Display (OSD):** Display time stamp and text on the video screen.
  - OSD Text: Inputted text (to identify the camera) shown on the screen.
  - OSD Position: Show the OSD in either top or bottom position on screen.
  - Display Time: When checked, time stamp will display on video screen
  - Display Text: When checked, inputted text will display on video screen.
- **Audio Settings:** Pull down to disable due to no microphone in this camera.
  - Microphone Volume: Slide to adjust microphone gain.
  - Speaker Volume: Slide to adjust the built-in speaker volume.
- **Power Frequency:** Select correct local power frequency to avoid video flicking effect under fluorescence light condition. Default is Outdoor.

**Video Settings**

**Primary Stream Settings**

Preferred Video Codec:

Resolution:

Bit Rate:  kbps

Maximum Frame Rate:  fps

Bit Rate Control:  CBR  VBR

Image Quality:

I-frame Interval:  Frame(1-100)

**Secondary Stream Settings**

Preferred Video Codec:

Resolution:

Bit Rate:  kbps

Maximum Frame Rate:  fps

Bit Rate Control:  CBR  VBR

I-frame Interval:  Frame(1-100)

**Figure 4-2: Video & Audio Settings Page**

- **Primary Stream Settings:**
  - Preferred Video Codec: MJPEG and H.264 supported, H.264 recommended.
  - Resolution: The video resolution in pixels used in video of camera
  - Bit Rate: video bit rate used
  - Maximum Frame Rate: Maximum frame rate used. More data if big frame used
  - Bit Rate Control: Constantly bit rate, or variable bit rate
  - Image Quality: Image quality used when Variable Bit Rate used
  - I-frame Interval: I-frame interval
  
- **Secondary Stream Settings:** Pull down to select, same as Primary steam..

**NOTE:**

- *H.264 suggested if camera needs to be viewed via Internet.*
- *If MJPEG selected, reduce max. frame rate to min. value to save bandwidth and get better image*
- Grandstream IP Camera provides two video streams, user can use them with flexibility. For example, the high-resolution stream for local recording; another low or high resolution for remote monitoring; or vice versa depending application scenarios.
- *Use below link to calculate bandwidth and storage before installation*  
<http://www.grandstream.com/support/tools/bandwidth-storage-calc>

## CMOS Settings Page

This page allows user to adjust the CMOS parameters:

**Home**

**Basic Settings**

System

Video & Audio

**CMOS Settings**

Networking

DDNS

SIP

Status

**Advanced Settings**

### CMOS Parameters Configuration



Flip:

Shutter Speed: Auto ▼

IR CUT Setting: Automatic(IR sensor control) ▼

IR CUT Sensitivity: 3 ▼

Color Mode: Auto ▼

Save

**Figure 5: CMOS Settings Page**

- **Flip:** Check this will allow video flip 180° vertically in horizontal axis.
- **Shutter Speed:** Camera Shutter Speed. There are 10 options, with Auto, 1/30, 1/60, 1/125, 1/250, 1/500, 1/1000, 1/2000, 1/5000 and 1/10000
- **IR CUT Setting:** Manual or Automatic (IR Sensor or Algorithm controlled mechanical IR CUT)
- **IR CUT Sensitivity:** Sensitivity of IR CUT be triggered, 5 lever total
- **Color Mode:** Camera Color Mode. There are three options: Color; Black/White; Auto.

### NOTE:

- *Auto option recommended for Shutter Speed, IR CUT Setting and Color Mode.*

## Networking Setting Page

This page allows user to configure network related parameters:

**IP Address Configuration**

Dynamically Assigned via DHCP

Statically Configured as:

IP Address:

Subnet Mask:

Default Gateway:

**DNS Configuration**

Obtain DNS Server Address Automatically

Use the Following DNS Server Address:

Primary DNS Server:

Secondary DNS Server:

**HTTP**

HTTP Port:

**Figure 6: Networking Setting Page**

- **IP Address Configuration:** Camera IP address configuration
  - Dynamically Associated via DHCP: Default setting, DHCP server assign IP to camera.
  - Statically Configured as: Static IP address configuration
- **DNS Configuration:** DNS server IP, must be configured correctly if using static IP.
- **HTTP:** Web access TCP port, default 80.

### NOTE:

- *If camera behind SOHO router with port forwarding configuration for remote access, static IP or static DHCP has to be used to avoid IP address change after router reboot.*
- *TCP port above 5000 suggested if port forwarding HTTP remote access, due to some ISP would block port 80 inbound traffic. For example, change the default HTTP port from 80 to 8088, to make sure the port forwarding not likely be blocked.*
- *In addition to HTTP port, RTSP port also required to be configured for port forwarding, in order for remote party viewing the H.264 video.*
- *If change the default port from TCP 80 to port “A”, then RTSP port should be “2000+A”. Both TCP port “A” and “2000+A” should be configured for port forwarding in the router. For example, the HTTP port changed to 8088, the RTSP port should be 10088, both 8088 and 10088 should be configured for port forwarding in order for remote camera video access.*

## DDNS Settings Page

This page allows user to configure dynamic DNS related parameters:



Figure 7: DDNS Setting Page

- **DDNS Active:** Enable DDNS by check this field.
- **DDNS ISP Type:** Select the DDNS service provider from the pull-down menu list
- **Self-Define DDNS Address:** Input the self-defined DDNS address
- **Site Name:** DDNS site name
- **DDNS Account:** DDNS account name
- **DDNS Password:** DDNS password
- **STUN Server:** Stun server FQDN or IP. If device behind a non-symmetric router, STUN server can help to penetrate & resolve NAT issue.

## SIP Setting Page

This page allows user to configure SIP related parameters.

GXV3672\_HD/FHD can be configured as SIP endpoint to call out when alarm triggered; or allow permitted number to call in to check the video if Grandstream video IP phone is used.

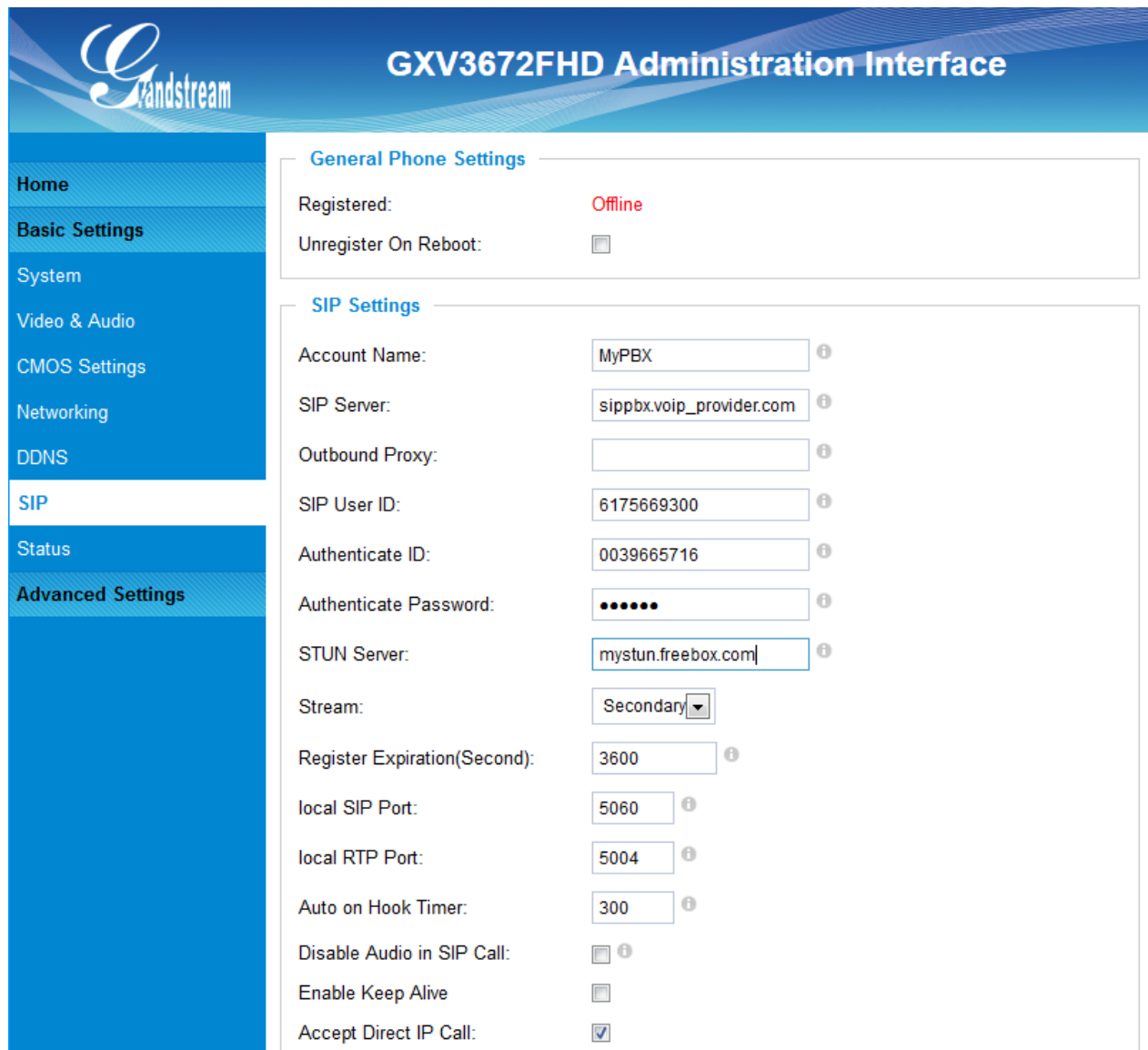

The screenshot shows the 'GXV3672FHD Administration Interface' with a sidebar menu on the left containing: Home, Basic Settings, System, Video & Audio, CMOS Settings, Networking, DDNS, SIP (highlighted), Status, and Advanced Settings. The main content area is divided into two sections:

- General Phone Settings:**
  - Registered: Offline
  - Unregister On Reboot:
- SIP Settings:**
  - Account Name: MyPBX
  - SIP Server: sippbx.voip\_provider.com
  - Outbound Proxy: (empty)
  - SIP User ID: 6175669300
  - Authenticate ID: 0039665716
  - Authenticate Password: (masked with dots)
  - STUN Server: mystun.freebox.com
  - Stream: Secondary
  - Register Expiration(Second): 3600
  - local SIP Port: 5060
  - local RTP Port: 5004
  - Auto on Hook Timer: 300
  - Disable Audio in SIP Call:
  - Enable Keep Alive:
  - Accept Direct IP Call:

Figure 8-1: SIP Setting Page

- **Registered:** SIP registration status. Display “Online” in Green, “Offline” in Red.
- **Unregistered on Reboot:** If checked and server support, reboot camera will unbind all registration in same SIP account.
- **Account Name:** SIP account name
- **SIP Server:** FQDN or IP of SIP server from VoIP service provider
- **Outbound Proxy:** IP or FQDN of Outbound proxy server, helps penetrate NAT/Firewall
- **SIP User ID:** SIP username, or telephone number from ITSP
- **Authenticate ID:** Authenticate ID used by SIP proxy

- **Authenticate Password:** Authenticate password used by SIP proxy
- **STUN Server:** STUN server used to resolve NAT if have
- **Stream:** Which stream used for SIP call.
- **Preferred Vocoder:** Audio codec used for SIP call **(NOTE)**
- **Registration Expiration:** Registration expiration time, default 3600 seconds
- **Local SIP Port:** Local SIP port, default 5060
- **Local RTP Port:** Local RTP port for media, default 5004
- **Auto on hook Timer:** Auto On Hook timer, default 300 seconds
- **Disable Audio in SIP Call:** Checked to disable audio for SIP call
- **Enable Keep Alive:** Checked to enable, help NAT resolution
- **Accept Direct IP Call:** Check to accept peer to peer IP call.

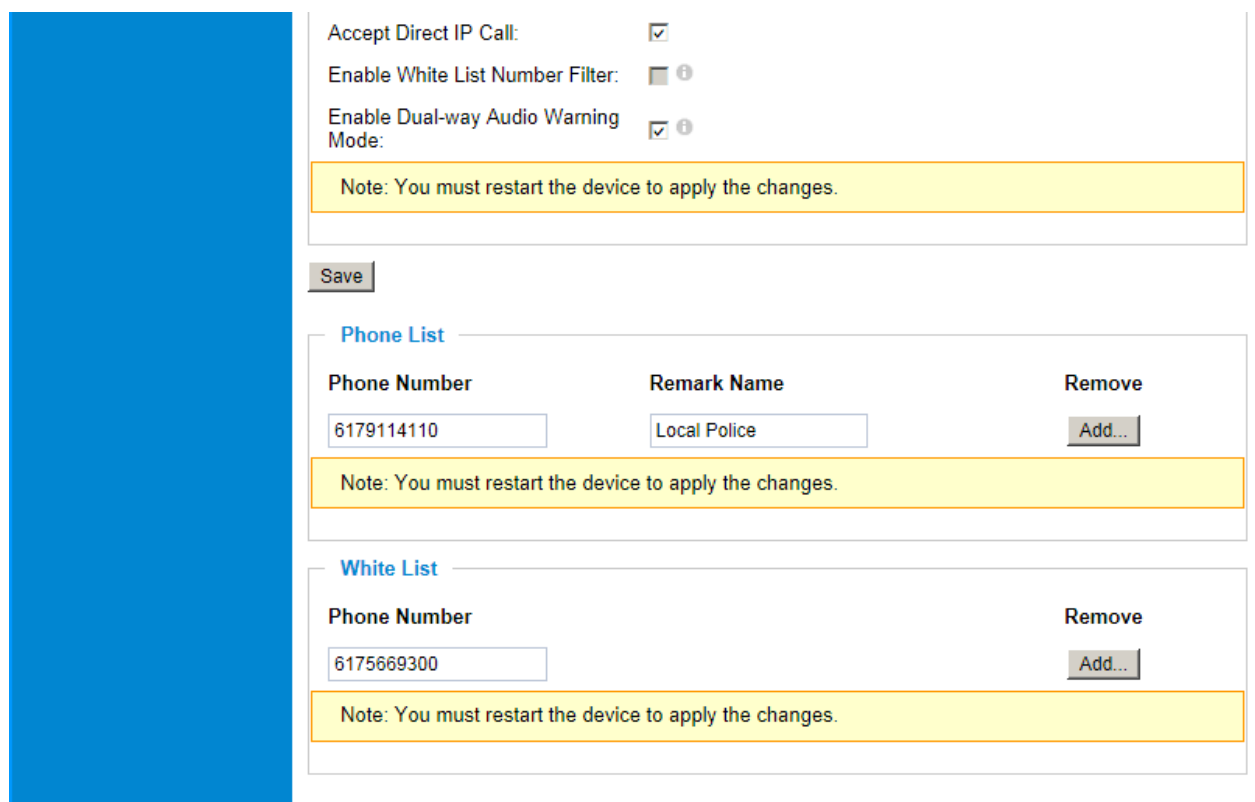

The screenshot shows the SIP Setting Page with the following configuration options:

- Accept Direct IP Call:
- Enable White List Number Filter:
- Enable Dual-way Audio Warning Mode:

Note: You must restart the device to apply the changes.

Save

**Phone List**

Phone Number	Remark Name	Remove
<input type="text" value="6179114110"/>	<input type="text" value="Local Police"/>	<input type="button" value="Add..."/>

Note: You must restart the device to apply the changes.

**White List**

Phone Number	Remove
<input type="text" value="6175669300"/>	<input type="button" value="Add..."/>

Note: You must restart the device to apply the changes.

Figure 8-2: SIP Setting Page

- **Enable White List Number Filter:** Check to allow only white list number to call in, for security
- **Enable Dual-way Audio Warning:** Check to enable two-way audio warning.
- **Phone List/Phone Number:** Callee or call receiver number when alarm call trigged.
- **White List/Phone Number:** Phone numbers allowed to call into the camera.

**NOTE:**

- Unless external microphone connected to internal module, GXV3672\_HD/FHD does NOT support Audio even the audio codec configured.

## Status Page

This page shows the GXV3672\_HD/FHD operation status:



The screenshot shows the 'GXV3672FHD Administration Interface' with a sidebar menu on the left and three main content panels on the right. The sidebar menu includes: Home, Basic Settings, System, Video & Audio, CMOS Settings, Networking, DDNS, SIP, Status, and Advanced Settings. The 'Status' menu item is highlighted. The main content area is divided into three sections: System Statistics, Network Status, and Camera Type.

System Statistics	
Product Model:	GXV3672FHD
Hardware Version:	V1.0A
Part Number:	9670004310A
Bootloader Version:	1.0.0.0
Core Version:	1.0.1.67
Base Version:	1.0.1.67
Firmware Version:	1.0.1.67
System Up Time Since:	17 minutes

Network Status	
MAC Address:	00:0B:82:27:F5:C8
LAN IP Address:	192.168.1.150
LAN Subnet Mask:	255.255.255.0
LAN Default Gateway:	192.168.1.3
DDNS Status:	Disabled
SIP Registered:	Offline

Camera Type	
Camera Type:	Aptina, AR0331 Pixels 2048*1536

Figure 9: Status Page

### NOTE:

- When SIP account registered, the status will display “Online” in Green.
- When SIP account unregistered, the status will display “Offline” in Red, as below.

SIP Registered:                      Offline



## ADVANCED SETTINGS EXPLANATION

The supports all the traditional and advanced telephony features.

### User Management Page

This page allows user to do user management:

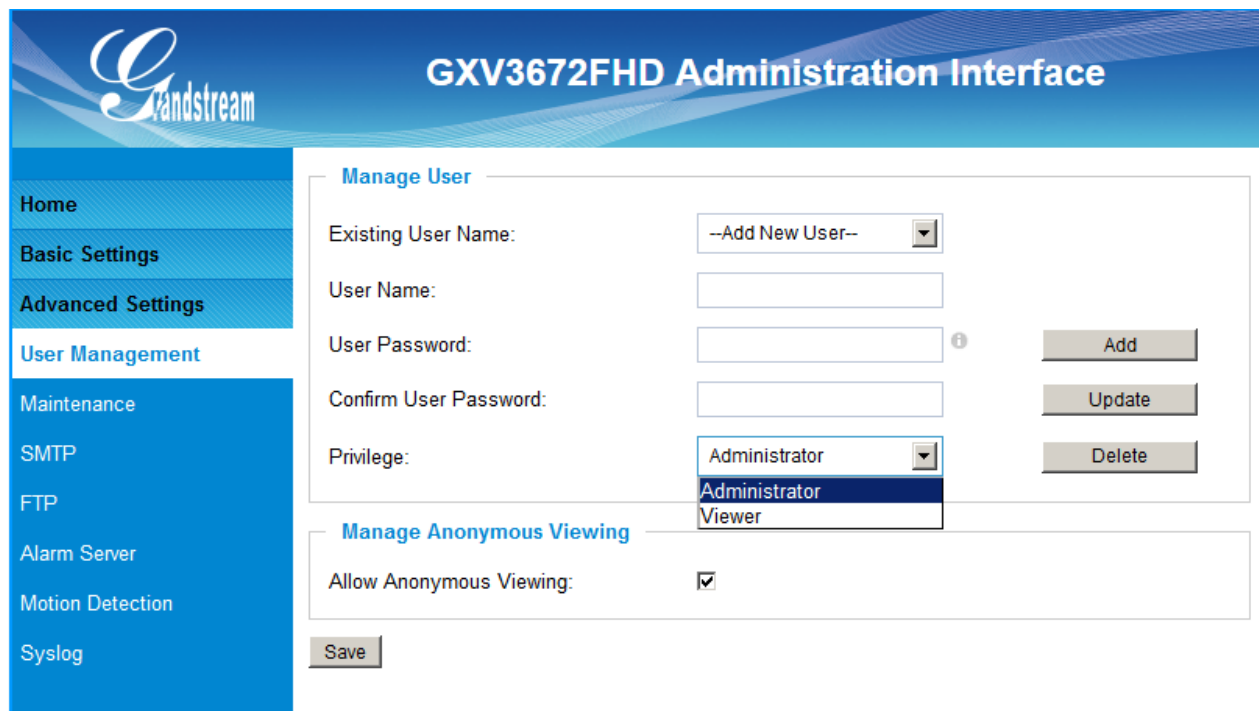



Figure 10: User Management Page

- **Existing User Name:** Allow revise existing user or add new user
- **User Name:** The name of user need to be revised
- **User Password:** New password if revise password
- **Confirm User Password:** Re-enter the new password for verification
- **Privilege:** Choose user privilege
- **Allow Anonymous Viewing:** When checked, no security enhanced. Any person can view the camera if knowing the IP or FQDN of the camera, but can NOT change anything, just view ONLY.

## Maintenance Page

This page allows user to maintain the camera:



**Figure 11: Maintenance Page**

- **Restart:** When clicked, the camera will reboot or restart
- **Restore:** When clicked, the camera will be reset to factory default, wiping out all the configurations (except IP address)

### Firmware Upgrade and Provisioning:

- **Upgrade via:** Upgrade firmware via TFTP, HTTP or HTTPS
- **Firmware Server Path:** Server path holding the firmware
- **Config Server Path:** Server path holding the configuration file (auto provisioning)
- **XML Config File Password:** Password for encrypt the XML based configuration file
- **Automatic Upgrade Interval (Minutes):** Time interval for automatic upgrade, default 10080
- **Automatic Upgrade:** Checked to enable automatic firmware upgrade and provisioning.

### NOTE:

- Only XML based automatic provisioning is supported by GXV3672\_HD/FHD.

## SMTP Setting Page (Email Alarm)

This page allows user to configure email client to send out email when alarm triggered:

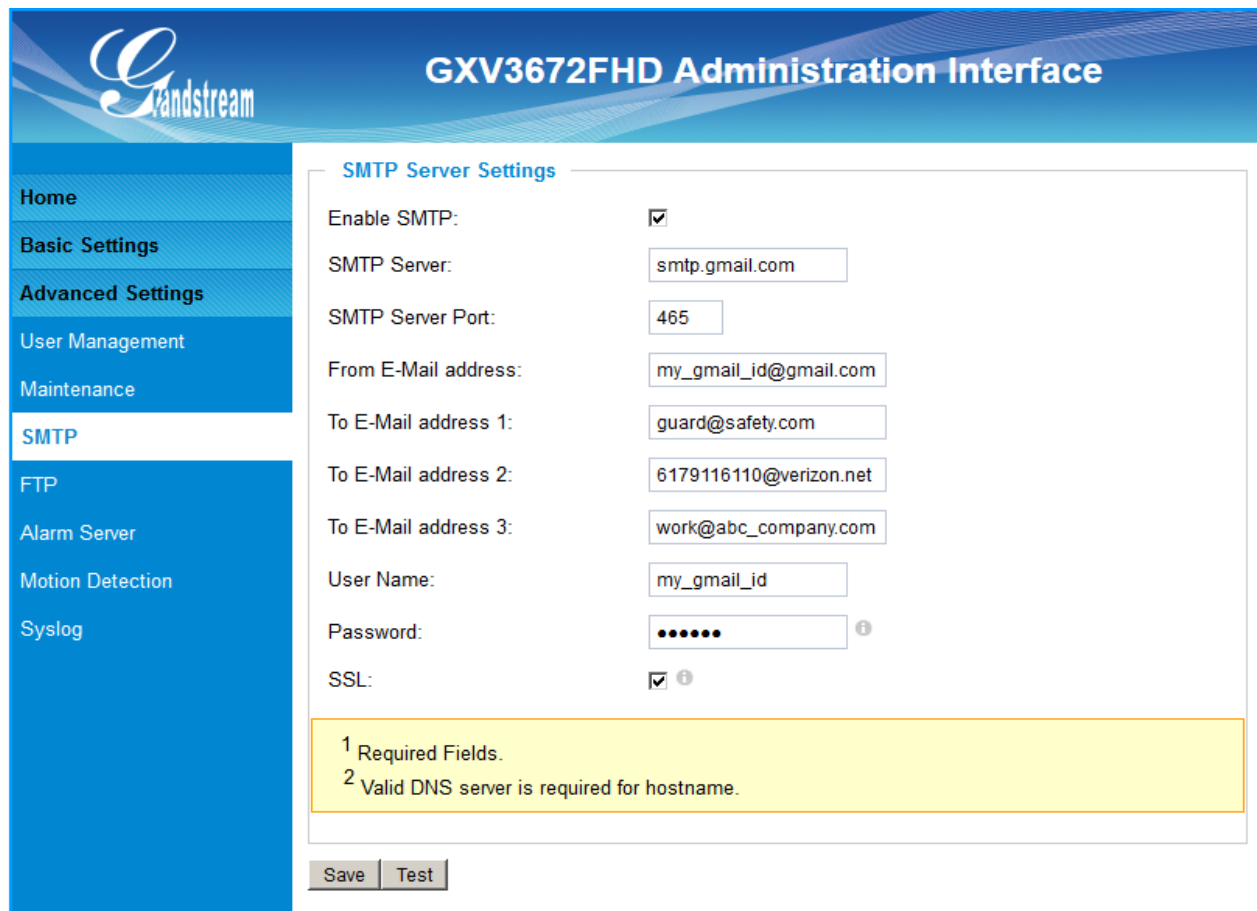

Figure 12: SMTP Setting Page

- **Enable SMTP:** When checked, email client is enabled.
- **SMTP Server:** SMTP Email Server IP or Domain Name
- **SMTP Server Port:** Port number used by server to send email
- **From Email address:** The email address of alarm email sending from, usually client email ID
- **To E-Mail address:** The email address to receive the alarmed email, total 3 included.
- **User Name:** Email client User ID
- **Password:** Email client password
- **SSL:** Check if the SMTP email server requires SSL

### NOTE:

- Click “Save” to save the email configuration information.
- Click “Test” after configuration, if setting is correct, a test email will send out and “Test successful!” yellow bar will display like below



## FTP Settings Page (Upload Alarm)

This page allows user to configure FTP parameters to upload the alarm or video recording::

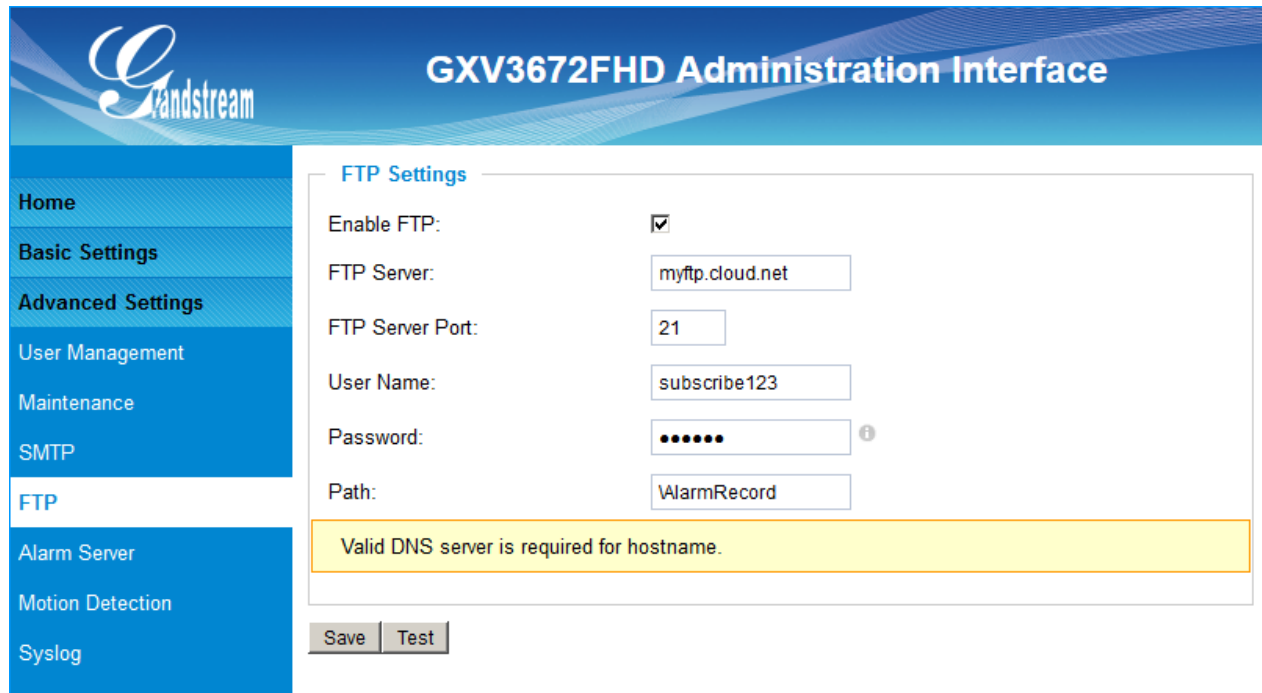

Figure 13: FTP Setting Page

- **Enable FTP:** When checked, built-in FTP client is enabled.
- **FTP Server:** IP or Domain name of FTP site or server
- **FTP Server Port:** TCP port for FTP server, default port number 21
- **User Name:** FTP server User ID
- **Password:** FTP server user password
- **Path:** Path in the server where upload files are stored.

### **NOTE:**

- Click “Save” to save the FTP configuration information.
- Click “Test” after configuration, if setting is correct, a test FTP operation will be performed and “Test successful!” yellow bar will display if the operation is successful.

## Alarm Server Settings Page (Upload Alarm to supported VMS or HTTP Server)

This page allows user to configure alarm HTTP server to upload alarms:



**Figure 14: Alarm HTTP Server Setting Page**

- **Server Name:** The name of HTTP server or VMS system
- **URL:** URL of the Server
- **User Name:** User ID from that Server
- **Password:** Password for that User ID

### **NOTE:**

- *Grandstream provide HTTP API to help 3<sup>rd</sup> party company by using HTTP server or VMS to develop further solutions for its customers.*
- *Grandstream IP Camera and DVS (include GXV3672\_HD/FHD) are ONVIF certified.*

## Motion Detection Configuration Page (Set Alarm)

This page allows user to configure motion detection to trigger alarms:

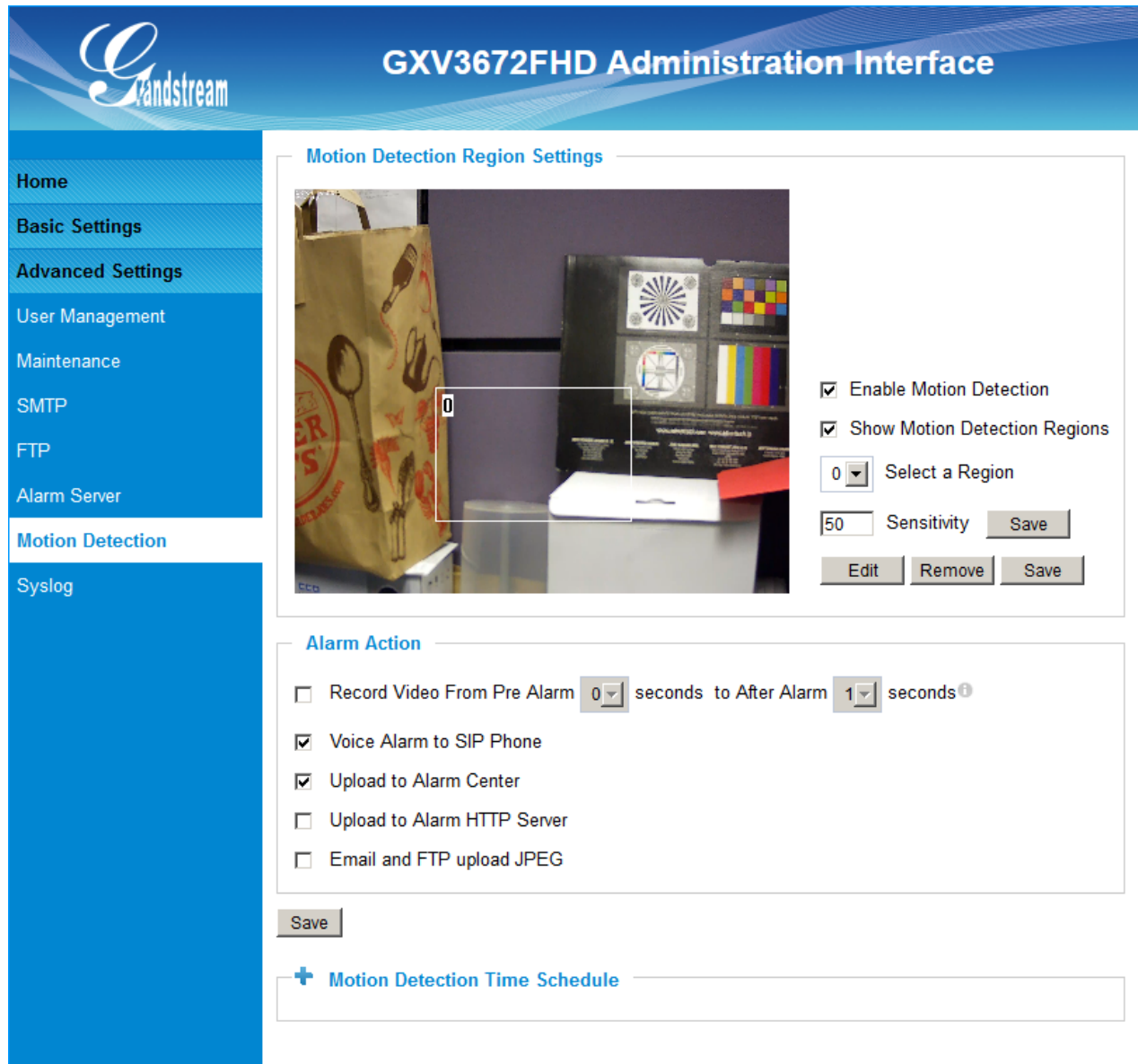

The screenshot displays the 'GXV3672FHD Administration Interface' with a left-hand navigation menu. The 'Motion Detection' section is active, showing two main configuration panels:

- Motion Detection Region Settings:** This panel includes a video feed of a room with a white rectangle overlaid on a table. To the right of the video, there are checkboxes for 'Enable Motion Detection' and 'Show Motion Detection Regions', both of which are checked. Below these is a dropdown menu for 'Select a Region' set to '0', a 'Sensitivity' input field set to '50', and buttons for 'Edit', 'Remove', and 'Save'.
- Alarm Action:** This panel contains several checkboxes: 'Record Video From Pre Alarm' (unchecked) with a dropdown set to '0' seconds, and 'After Alarm' (checked) with a dropdown set to '1' seconds. Other checked options include 'Voice Alarm to SIP Phone', 'Upload to Alarm Center', 'Upload to Alarm HTTP Server', and 'Email and FTP upload JPEG'. An unchecked 'Save' button is located below this panel.

At the bottom of the interface, there is a section for '+ Motion Detection Time Schedule' which is currently empty.

Figure 15-1: Motion Detection Configuration Page

- **Enable Motion Detection:** When checked, Motion Detection enabled.
- **Show Motion Detection Regions:** When checked, Motion Detection region with number will be displayed in White Rectangle in the screen; when “Edit” clicked, the Rectangle will become Red, as shown in Figure 16-1.
- **Select a Region:** Pull down to select and configure alarm region, altogether 16 alarm region available, from 0 to 15.
- **Sensitivity:** Select configured alarm region number, input number for sensitivity to trigger alarm, 100 is the maximum sensible value.

### Alarm Action:

- **Record Video From.....** Allow user to select how long pre/after Alarm trigger moment, the video be captured.
- **Voice Alarm to SIP Phone:** When checked, a SIP alarm phone call will be made to pre-configured number.
- **Upload to Alarm Center:** When checked, the alarm video will be transferred to Alarm Center, like Grandstream free GSurf\_Pro VMS software.
- **Upload to Alarm HTTP Server** When checked, the alarm will be sent to Alarm HTTP Server. 3<sup>rd</sup> Party Server also can be used via GS HTTP API

### NOTE:

➤ Grandstream free GSurf\_Pro VMS software can be downloaded here:

[http://www.grandstream.com/products/tools/surveillance/gsurf\\_pro.zip](http://www.grandstream.com/products/tools/surveillance/gsurf_pro.zip)

- **Email and FTP upload JPEG:** When checked, a snapshot of trigger moment will be generated and be emailed to pre-configured email account, also upload to FTP server if configured.

### Motion Detection Time Schedule:

This page allows user to configure Motion Detection Operation Schedule:

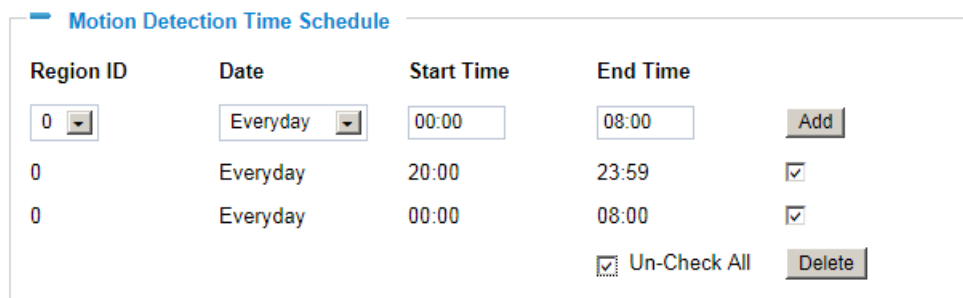

The screenshot shows a web interface titled "Motion Detection Time Schedule". It features a table with columns for "Region ID", "Date", "Start Time", and "End Time". There are three rows of data, each with a "0" in the Region ID column. The first row has "Everyday" in the Date column, "00:00" in Start Time, and "08:00" in End Time, with an "Add" button to its right. The second row has "Everyday" in the Date column, "20:00" in Start Time, and "23:59" in End Time, with a checked checkbox to its right. The third row has "Everyday" in the Date column, "00:00" in Start Time, and "08:00" in End Time, with a checked checkbox to its right. Below the table, there is a "Un-Check All" checkbox and a "Delete" button.

Region ID	Date	Start Time	End Time	
0	Everyday	00:00	08:00	Add
0	Everyday	20:00	23:59	<input checked="" type="checkbox"/>
0	Everyday	00:00	08:00	<input checked="" type="checkbox"/>

Un-Check All    Delete

Figure 15-2: Motion Detection Schedule Configuration Page

- As shown in Figure 15-2, user can configure the Motion Detection Region with related Start and Stop time to control the motion detection operation.

## Syslog Settings Page (Troubleshooting)

This page allows user to enable the Syslog to help troubleshooting problems:

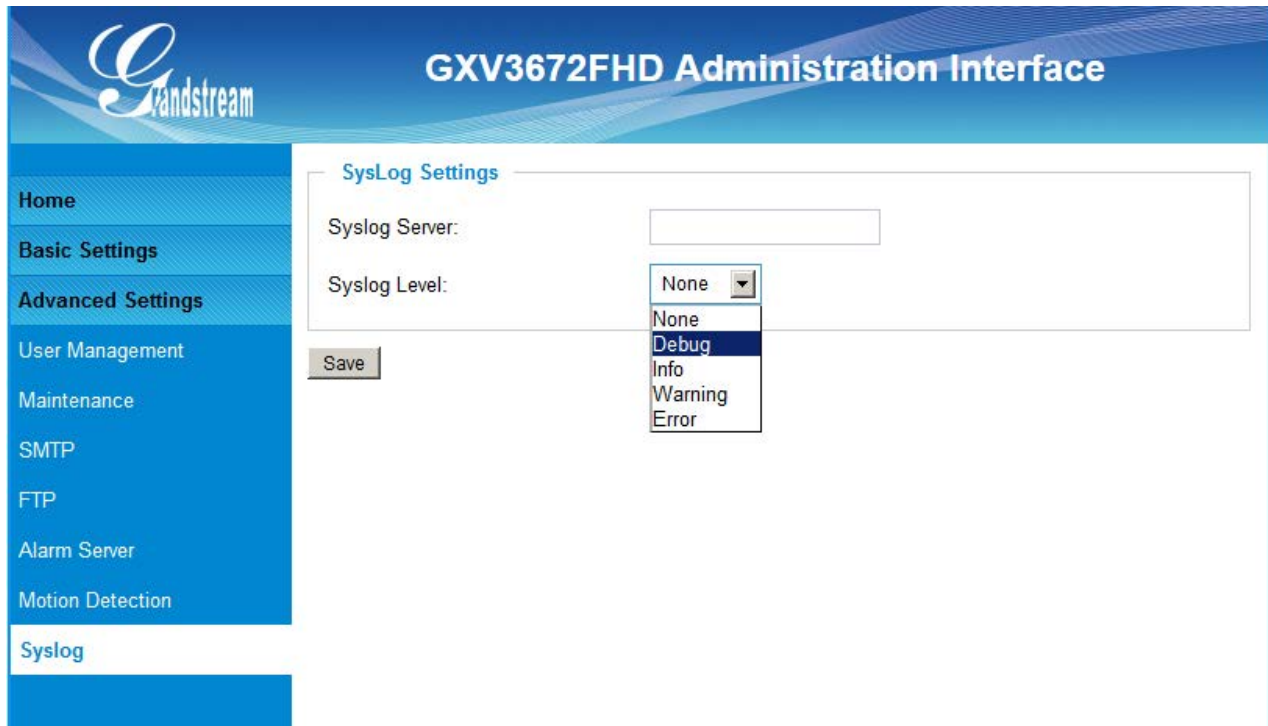

The screenshot shows the 'SysLog Settings' page in the GXV3672FHD Administration Interface. The page features a blue header with the Grandstream logo and the title 'GXV3672FHD Administration Interface'. On the left, there is a vertical navigation menu with the following items: Home, Basic Settings, Advanced Settings, User Management, Maintenance, SMTP, FTP, Alarm Server, Motion Detection, and Syslog. The main content area is titled 'SysLog Settings' and contains the following fields:

- Syslog Server:** A text input field.
- Syslog Level:** A dropdown menu with the following options: None, Debug, Info, Warning, and Error. The 'Debug' option is currently selected.
- Save:** A button to save the settings.

**Figure 16: Alarm Server Setting Page**

- **Syslog Server:** Syslog server IP or Domain Name
- **Syslog Lever:** Lever of syslog message sent to the syslog server:  
*None, Debug, Info, Warning, Error.*



## Software Upgrade

Software upgrade can be done via either TFTP, HTTP or HTTPS. The corresponding configuration settings are in the ADVANCED SETTINGS configuration page.

### Software Upgrade via TFTP, HTTP or HTTPS

This page allows user to configure firmware upgrade:

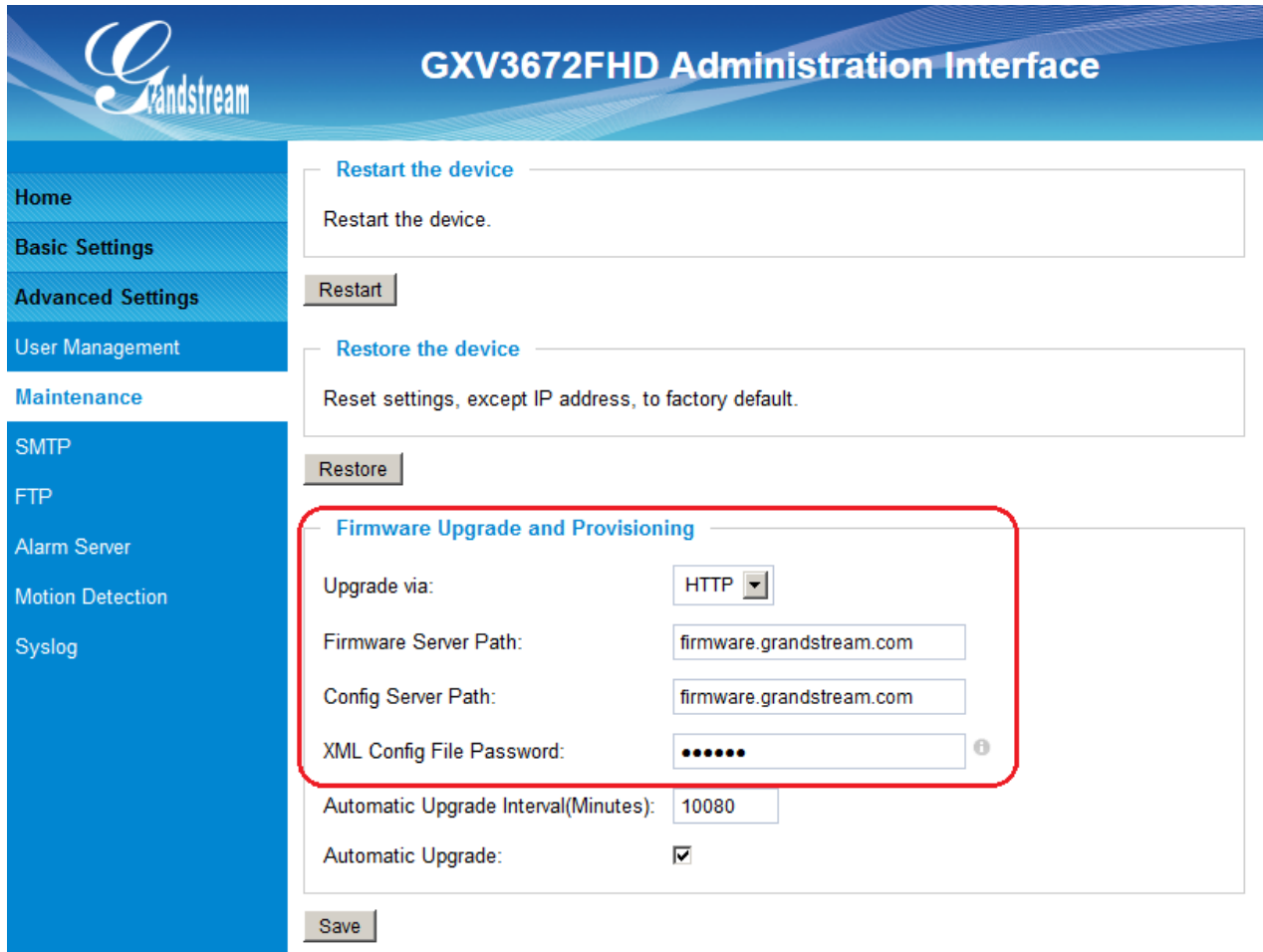

The screenshot shows the 'GXV3672FHD Administration Interface' with a sidebar menu on the left containing: Home, Basic Settings, Advanced Settings, User Management, Maintenance, SMTP, FTP, Alarm Server, Motion Detection, and Syslog. The main content area has three sections: 'Restart the device' with a 'Restart' button, 'Restore the device' with a 'Restore' button, and 'Firmware Upgrade and Provisioning' (highlighted with a red box). The 'Firmware Upgrade and Provisioning' section contains the following fields: 'Upgrade via:' with a dropdown menu set to 'HTTP'; 'Firmware Server Path:' with a text box containing 'firmware.grandstream.com'; 'Config Server Path:' with a text box containing 'firmware.grandstream.com'; 'XML Config File Password:' with a masked password field (six dots) and an information icon; 'Automatic Upgrade Interval(Minutes):' with a text box containing '10080'; and 'Automatic Upgrade:' with a checked checkbox. A 'Save' button is located at the bottom of the section.

Figure 17: Firmware Upgrade and Provisioning

#### NOTES:

- Grandstream recommends end-user use the Grandstream HTTP server. Its address can be found at <http://www.grandstream.com/support/firmware>.
- Currently the HTTP firmware server is **firmware.grandstream.com**. For large companies, we recommend to maintain their own TFTP/ HTTP/HTTPS server for upgrade and provisioning procedures.

### Instructions for local firmware upgrade using TFTP server:

1. Unzip the file and put all of them under the root directory of the TFTP server.
2. Put the PC running the TFTP server and the device in the same LAN segment.
3. Please go to File -> Configure -> Security to change the TFTP server's default setting from "Receive Only" to "Transmit Only" for the firmware upgrade.
4. Start the TFTP server, in the phone's web configuration page
5. Configure the Firmware Server Path with the IP address of the PC
6. Update the change and reboot the unit

End users can also choose to download the free HTTP server from <http://httpd.apache.org/> or use Microsoft IIS web server.

### Configuration File Download

Grandstream SIP Device can be configured via Web Interface as well as via Configuration File through TFTP or HTTP/HTTPS. "Config Server Path" is the TFTP or HTTP/HTTPS server path for configuration file. It needs to be set to a valid URL, either in FQDN or IP address format. The "Config Server Path" can be same or different from the "Firmware Server Path".

A configuration parameter is associated with each particular field in the web configuration page. A parameter consists of a Capital letter P and 1 to 3 (Could be extended to 4 in the future) digit numeric numbers. i.e., P2 is associated with "Admin Password" in the ADVANCED SETTINGS page. For a detailed parameter list, please refer to the corresponding firmware release configuration template.

When Grandstream Device boots up or reboots, it will issue request for configuration file named "cfgxxxxxxxxxxxx.xml", where "xxxxxxxxxxxx" is the MAC address of the device, i.e., "cfg000b820102ab.xml". The configuration file name should be in lower cases.

**Currently GXV3672\_HD/FHD only support XML configuration.**

## RESTORE FACTORY DEFAULT SETTING

### WARNING!

Restoring the Factory Default Setting will DELETE all configuration information of the camera. Please BACKUP or PRINT out all the settings before approach to following steps. Grandstream will not take any responsibility if you lose all the parameters of setting or cannot connect to your VoIP service provider.

### FACTORY RESET

#### Reset from Web Interface

This page allows user to configure dynamic network related parameters:

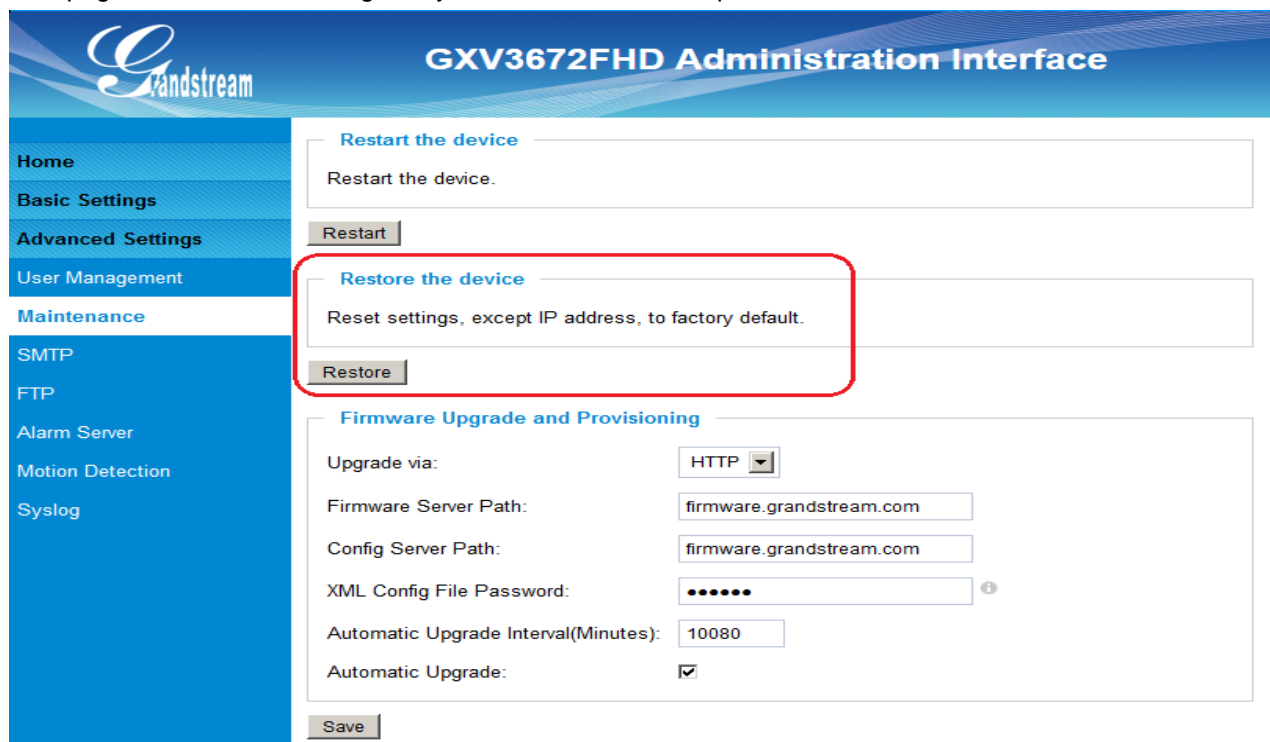

The screenshot displays the 'GXV3672FHD Administration Interface' with a left-hand navigation menu. The menu items include Home, Basic Settings, Advanced Settings, User Management, Maintenance, SMTP, FTP, Alarm Server, Motion Detection, and Syslog. The 'Maintenance' section is active, showing three main options: 'Restart the device', 'Restore the device', and 'Firmware Upgrade and Provisioning'. The 'Restore the device' option is highlighted with a red rectangular box. Below this option is a 'Restore' button. The 'Firmware Upgrade and Provisioning' section includes fields for 'Upgrade via' (set to HTTP), 'Firmware Server Path', 'Config Server Path', 'XML Config File Password', 'Automatic Upgrade Interval(Minutes)' (set to 10080), and 'Automatic Upgrade' (checked). A 'Save' button is located at the bottom of the interface.

Figure 18: Factory Reset from Web Interface

## IP SURVEILLANCE FAQ

### **1. What is the default IP address of the GXV3672HD\_FHD?**

The default IP configuration is DHCP.

### **2. Why can I not view the live video stream in Microsoft Internet Explorer?**

Please double check whether the IE add-on was installed correctly.

Once you log into the GXV 3672HD\_FHD web interface, Internet Explorer will indicate that this website wants to install the following add-on: 'GSViewer.cab' from Grandstream Networks, Inc. Please install this add-on when prompted by IE.

### **3. How do you manually uninstall the Grandstream video viewer add-on for IE?**

Please follow these steps to uninstall the add-on:

1. Delete the *GSViewerX Control* from *C:\WINDOWS\Downloaded Program Files* directory
2. Delete *GSNetClient.dll*, *GS\_Replay.exe*, *GSViewerX.ocx*, *hi\_h264dec\_w.dll*, *lik\_VoiceEngine\_dll.dll* and *GSViewerX.inf* from *C:\WINDOWS\system32*

### **4. Why can't I access the GXV3672HD\_FHD web configuration interface?**

Q 1: Is your internet service down?

A 1: Connect a PC to the internet to test the connection.

Q 2: Are the PC and the device in different subnets?

A 2: Check the subnet mask and default gateway of the device and PC.

Q 3: Is there a conflict with another IP address?

A 3: Try to change the IP address of the device.

Q 4: Has the HTTP port been changed?

A 4: Contact the administrator of the device for more information.

### **5. The GXV3672HD\_FHD web configuration page is not displayed correctly in IE8 ?**

In IE8, Compatibility View might need to be enabled for the GXV3672HD\_FHD web configuration page to load properly. To enable compatibility view, open IE8, click *Tools*, *Compatibility View Setting*, and add the GXV3672HD\_FHD web configuration pages to the Compatibility View.

**6. Why does IE indicate to install Grandstream Video Viewer add-on after a firmware upgrade? The add-on was properly installed before the firmware upgrade process.**

New firmware will often upgrade the add-on as well. To watch the live video stream, you must install the newest version of the add-on.

**7. How do you watch secondary video stream?**

Login to the home page of the GXV3672HD\_FHD web GUI, click Play to watch the video stream. To watch a secondary video stream, right click on the video, and select *Secondary Stream* on the pop-up menu. Try reinstalling the Grandstream Viewer add-on for IE if you cannot see the video stream.

**8. Why is audio missing from the recorded video when an alarm triggered?**

To confirm to outdoor standard of IP66, GXV3672HD\_FHD does NOT have microphone installed although it has the interface in its PCB board. That is the reason of no audio.

**9. What is DDNS? Is it important for IP surveillance product to have DDNS support?**

DDNS is an acronym for Dynamic Domain Name Service. It is important to choose an IP network camera that has DDNS support for dynamic IP addresses. Chances are that the network has a dynamic IP address (which changes with every log on). A DDNS service makes sure that the camera's IP address always matches up to the current server address. DDNS also allows a website to be linked to the IP camera that is constantly updated with the correct information and has a reliable feed.

**10. Why is Windows Media Player unable to play the recorded video files?**

The GXV3672HD\_FHD uses the H.264 video codec. Windows Media Player may lack the proper H.264 decoder to play the recorded video. Please download the Microsoft FFDSHOW H.264 decoder from <http://sourceforge.net/projects/ffdshow-tryout/> and install it.

**11. Alarm Triggered Events do not work with Surf\_Pro?**

Please double check the Alarm Action on your GXV3672HD\_FHD. Login to the web GUI of the GXV3672HD\_FHD, go to the Motion Detection or Alarm Events page, and make sure option Upload to Alarm Center is checked.

**12. Recommended to save the video files in different directories when using GSurf\_Pro?**

It is better to save video files in different directory to prevent accidental deletion of the recorded files you need.

**13. How to use a cell phone to watch the GXV3672HD\_FHD video stream?**

You must set the video resolution to QCIF to watch the GXV3672HD\_FHD video stream from a cell phone. Make sure to set the bit rate to 64kbps to ensure the best video quality.

**14. Why the IP address of the device NOT reset when clicking the “Restore” button?**

The GXV3672HD\_FHD could be installed in areas that are not easy to access. For example, it could be installed on the roof of a building or the ceiling of an office. This makes it difficult to reinstall the device, therefore the “Restore” function will not clear the IP address.

**15. Why can't the live video stream be viewed using a mobile phone or GSurf\_Pro after changing the HTTP Port of the device?**

Make sure that the RTSP port of the device is set to 2000 plus the HTTP Port number. For example, if the HTTP port is 88, then the RTSP port of the device that you configured on GSurf\_Pro or mobile phone should be 2088.

**16. Port forwarding**

Two ports must be forwarded on your router to watch video from a GXV3672HD\_FHD that is located on a private network from a PC in a public network. The web port (HTTP) and the RTSP port. Please make note that the RTSP port number changes according to the web port. If the web port is 80, then the RTSP port is 554. If the web port is not 80, then the RTSP port equals the web port +2000. For example, if the web port is 88, then the RTSP port will be 2088.

**17. Tested PC display adapters.**

<b>Display Adapter</b>	<b>Test Result</b>
SiS 650/651/740/661 FX/741/760 Series	Works normally
Intel® 82945R Express Chipset Family	Works normally

VIA/S3G UniChrome Pro IGP	Works normally
NVIDIA Geforce 7300GS	Works normally
SiS 661FX	Works normally
SiS Mirage Graphics	Works normally
SiS 661 Series	Works normally
Intel® G33/G31 Express	Works normally
SiS Mirage3 Graphics	Works normally
SiS 661FX/GX Mirage Graphics	Works normally
S3 Graphics ProSavageDDR(Microsoft Corporation)	Works normally
XGI Velari Z7/Z9/Z9S V1.08.12	There is some delay when playing videos.
Intel® 965 Express Chipset Family	Works normally
ATI Mobility Radeon X1300	Works normally
Intel® G45/G43 Express Chipset	Works normally
Mobile Intel 965 Express Chipset Family	Works normally
Mobile Intel® 4 Series Express Chipset Family	Works normally
Mobile Intel® 945GM Express Chipset Family	Works normally
Mobile intel® 915GM/GMS, 910GML Express Chipset Family	Works normally
Intel® G45/G43 Express Chipset	Works normally
ATI Technologies, RAGE XL PCI	This display adapter cannot display videos.