

Grandstream Networks, Inc.

126 Brookline Ave, 3rd Floor
Boston, MA 02215. USA
Tel : +1 (617) 566 - 9300
Fax: +1 (617) 249 - 1987

www.grandstream.com

GXV3674_HD/FHD_VF v2

Outdoor Day/Night Vari-focal HD IP CAMERA



Quick Installation Guide

For Warranty and RMA information, please visit
www.grandstream.com

Content

English.....	1
Español.....	9
Français.....	17
简体中文.....	25
Deutsch.....	33
Italiano.....	41
Русский.....	49
Português.....	57
Polski.....	65

PRECAUTIONS

- Do not attempt to open, disassemble, or modify the device
- Do not use a third party power adapter
- Do not expose this device to temperatures outside the range of -20 °C to +50 °C for operating or -30 °C to +60 °C for storage
- Do not expose this device to environments outside of the following humidity range: 10-90% RH (non-condensing)
- Please install camera properly for correct function

PACKAGE CONTENTS

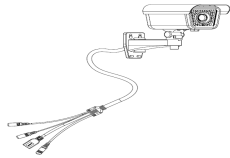

1 x GXV3674_HD/FHD_VF



1 x 12V Power Supply



1 x Ethernet Cable



4 x Wall Anchors



4 x Screws



1 x Hex Key



1 x Quick Start Guide
1 x GPL License

~1~

CONNECTING THE GXV3674_HD/FHD_VF

Refer to the illustration below when following the instructions on the next page.

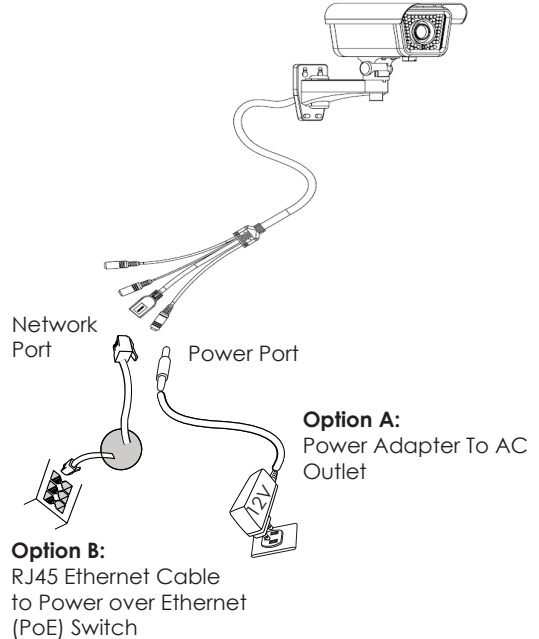

NOTE: Choose Option A if using the power supply; or choose Option B if using a Power over Ethernet (PoE) switch.

~2~

Option A

Step 1: Insert the power adapter into the 12V DC socket of the tail cable in GXV3674_HD/FHD_VF. Plug the other end of the adapter into an AC power outlet.

Step 2: Plug an RJ45 Ethernet cable into the network socket of the tail cable in GXV3674_HD/HD_VF. Plug the other end into a switch or router.

Option B

Step 1: Plug an RJ45 Ethernet cable into the network socket of the tail cable in GXV3674_HD/FHD_VF. Plug the other end into a Power over Ethernet(PoE) switch.

GXV3674_HD/FHD_VF CONFIGURATION

Configuring the GXV3674_HD/FHD_VF using Firefox, Chrome or Microsoft Internet Explorer (with related plug-in installed)

Connect the GXV3674_HD/FHD_VF to a DHCP Server Enabled Network

Step 1: Download and install GS_Search tool:

http://www.grandstream.com/products/tools/surveillance/GS_Search.zip

Step 2: Run the Grandstream GS_Search tool.

Step 3: Click on  button to start device detection.

Step 4: The detected devices will appear in the output field as below.

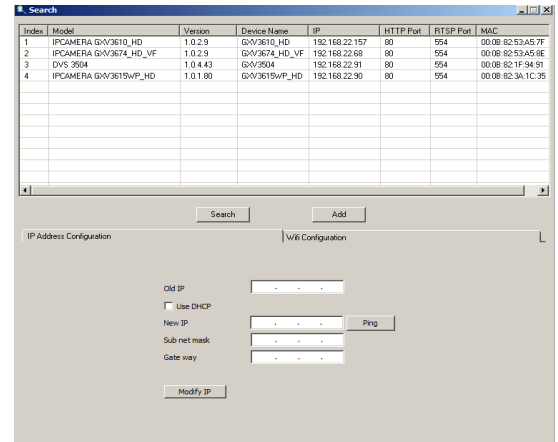

Index	Model	Version	Device Name	IP	HTTP Port	RTSP Port	MAC
1	IPCAMERA.GXV3610_HD	1.0.2.9	GXV3610_HD	192.168.22.157	80	554	00:08:82:53:A5:7F
2	IPCAMERA.GXV3674_HD_VF	1.0.2.9	GXV3674_HD_VF	192.168.22.68	80	554	00:08:82:53:A5:8E
3	DVS.3504	1.0.4.43	GXV3504	192.168.22.91	80	554	00:08:82:1F:94:91
4	IPCAMERA.GXV3615WP_HD	1.0.1.80	GXV3615WP_HD	192.168.22.90	80	554	00:08:82:3A:1C:35

Search Add

IP Address Configuration | WiFi Configuration

Old IP: [. . .]
 Use DHCP
New IP: [. . .] Ping
Sub net mask: [. . .]
Gate way: [. . .]
Modify IP

Step 5: Double click on the detected device. The default browser(MS IE in this example) will open displaying the camera's webGUI.

Step 6: A pop-up window will prompt for user name & password. The default administrator user name and password are both set to "admin" as to after the factory reset.

Step 7: Once you log into the webGUI, the device will indicate that an Active-X or video plug-in is required. Follow the displayed instruction to download and install the plug-in.

Step 8: If downloading or installing is unsuccessful due to browser setting or slow Internet connection, please download the files from the link below. Save and install the program then restart the browser. The video will now appear embedded inside the camera's web interface.

• **Plug-in:**

http://www.grandstream.com/products/tools/surveillance/webcontrl_plugin.zip

Step 9: Here is a sample screenshot with successful Active-X or Plug-in installation. Click on the play button to view the video feed.



Step 10: Click through the menu on the left hand side of the web interface for more advanced configuration parameters.

Connect GXV3674_HD/FHD_VF using Static IP

If the camera does not get response from the DHCP server or the network without DHCP server, after 3 minutes, it can be accessed by the default IP address 192.168.1.168.

- Step 1:** Use RJ-45 Ethernet cable to connect your computer network port directly to the Ethernet socket of GXV3674_HD/FHD_VF.
- Step 2:** Run the GS_Search tool as above. It will show the original IP of the GXV3674_HD/FHD_VF (default IP address 192.168.1.168).
- Step 3:** Input the NEW IP Address, Subnet Mask and Default Gateway, according to your network configuration. Please check with local system administrator for the necessary information.
- Step 4:** Click on "Modify IP". The desired IP address will be applied to GXV3674_HD/FHD_VF.

Please download the User Manual, refer to online documents and FAQ for more detailed information:

<http://www.grandstream.com/index.php/products/ip-video-surveillance/gxv3674>

<http://www.grandstream.com/support>

<http://www.grandstream.com/support/tools>

GXV3674_HD/FHD_VF v2 SPECIFICATIONS

Image Sensor Sensitivity	Day & Night Mode Shutter: 1/10000 - 1/30 second
Focal Length	2.8 ~ 12 mm
Aperture	F1.4, DC-IRIS
Field Angle (FOV)	90° ~ 28° (Horizontal Field)
IR Cut Filter	Yes. Mechanical
Day & Night Mode	Color & B/W mode IR LED covering up to 25m
Minimum Illumination	0.05 Lux 0 lux with IR LED on
Responsivity	HD: 5.48V/lux-sec (550nm) FHD: 1.9 V/lux-sec (550nm)
Maximum Video Resolution and Frame Rate	HD: 1280 x 960 (25fps) FHD: 2048 x 1536 (15fps)
Panning Range	0° - 180° (Manual)
Tilting Range	0° - 180° (Manual)

This product is covered by one or more of the U.S. patents (and any foreign patent counterparts thereto) identified at www.cmspatents.com.

PRECAUCIONES

- No abrir, desarmar o intentar modificar este equipo
- No use adaptadores de corriente distintos al suministrado
- No exponga este dispositivo a temperaturas fuera del rango de $-20\text{ }^{\circ}\text{C}$ a $+50\text{ }^{\circ}\text{C}$ en funcionamiento y desde $-30\text{ }^{\circ}\text{C}$ a $+60\text{ }^{\circ}\text{C}$ cuando están almacenadas
- No exponga este dispositivo a ambientes fuera del siguiente rango de humedad: 10-90% RH (Sin condensación)
- Por favor, instale la cámara adecuadamente para un funcionamiento correcto

CONTENIDO DEL PAQUETE

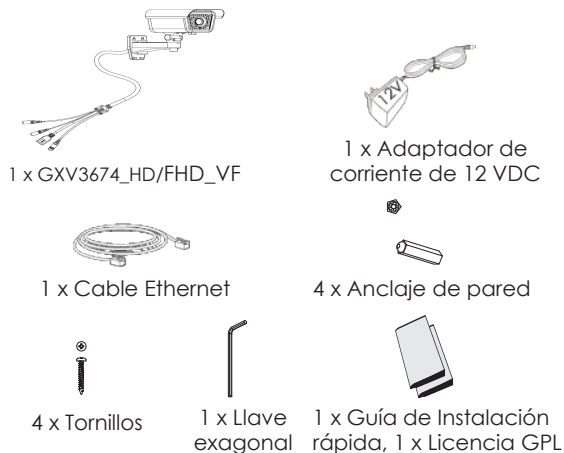

~9~

CONEXIÓN DE LA GXV3674_HD/FHD_VF

Consulte la siguiente ilustración y siga las instrucciones de la siguiente página.

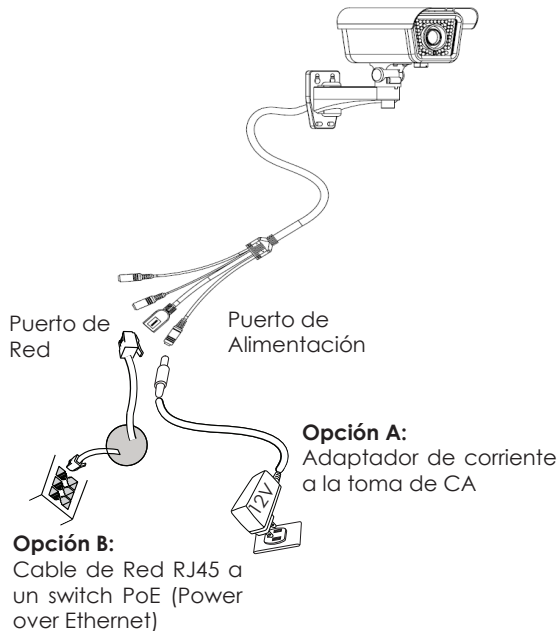

Nota: Seleccione la opción A si desea usar la fuente de poder o seleccione la Opción B si tiene un switch PoE (Power over ethernet).

~10~

Opción A:

Paso 1: Conecte el adaptador de corriente en el conector de 12 VDC que esta en la parte posterior de la GXV3674_HD/FHD_VF y conecte el otro extremo del adaptador a una toma de corriente AC.

Paso 2: Conecte un cable Ethernet RJ45 en el puerto de red que esta en la parte posterior de la GXV3674_HD/FHD_VF y conecte el otro extremo a un switch o router.

Opción B:

Paso 1: Conecte el cable de red Ethernet RJ45 al conector que esta en la parte posterior de la GXV3674_HD/FHD_VF y conecte el otro extremo al switch PoE (Power over Ethernet).

CONFIGURACION DE LA GXV3674_HD/FHD_VF

Configuración de la GXV3674_HD/FHD_VF usando Firefox, Chrome o con Microsoft Internet Explorer

Conecte la GXV3674_HD/FHD_VF a una red con un servidor DHCP activo

Paso 1: Descargue e instale la herramienta GS_Search

http://www.grandstream.com/products/tools/surveillance/GS_Search.zip

Paso 2: Ejecute la herramienta de Grandstream GS_Search.

Paso 3: Haga Click en botón  para iniciar la detección de dispositivos en la red.

Paso 4: Los dispositivos detectados se mostraran en el campo de salida como se muestra abajo.

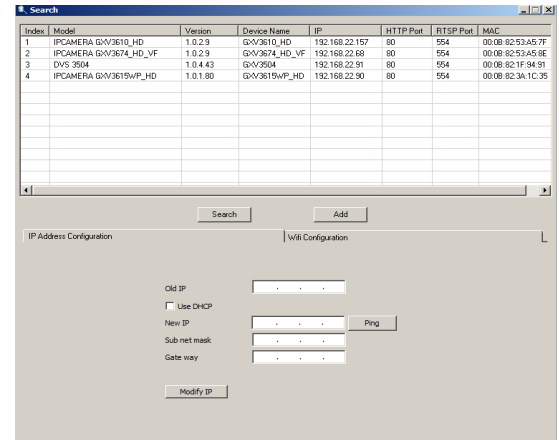

The screenshot shows the GS_Search application window. At the top, there is a table with the following data:

Index	Model	Version	Device Name	IP	HTTP Port	RTSP Port	MAC
1	IPCAMERA GXV3610_HD	1.0.2.9	GXV3610_HD	192.168.22.157	80	554	00:08:82:53:A5:7F
2	IPCAMERA GXV3674_HD_VF	1.0.2.9	GXV3674_HD_VF	192.168.22.68	80	554	00:08:82:53:A5:8E
3	DVS 3504	1.0.4.43	GXV3504	192.168.22.91	80	554	00:08:82:1F:94:91
4	IPCAMERA GXV3619WP_HD	1.0.1.80	GXV3619WP_HD	192.168.22.90	80	554	00:08:82:3A:1C:35

Below the table, there are 'Search' and 'Add' buttons. Underneath, there is an 'IP Address Configuration' section with a 'Use DHCP' checkbox and fields for 'New IP', 'Sub net mask', and 'Gate way'. A 'Ping' button is next to the 'New IP' field. At the bottom, there is a 'Modify IP' button.

Paso 5: Haga Doble click en el dispositivo defectado. El navegador por defecto (MS IE porejemplo) se abrirá mostrando la interfaz web de la cámara.

Paso 6: Una ventana emergente le pedirá el nombre de usuario y contraseña. El nombre de usuario y la contraseña por defecto es "admin" para la configuración predeterminada de fábrica.

Paso 7: Una vez que inicie sesión en la interfaz webGUI, el dispositivo indicará que un Active-X o el plug-in de vídeo es necesario. Siga las instrucciones que aparecen para la descargar e instalación del plug-in.

Paso 8: Si la descarga/instalación no es correcta debido a la configuración de su navegador o debido a una conexión lenta a Internet, descargue los archivos desde el siguiente enlace. Descargue e instale el programa y reinicie el navegador. El vídeo se mostrara ahora dentro de la interfaz web de la cámara.

• **Plug-in:**

http://www.grandstream.com/products/tools/surveillance/webcontrl_plugin.zip

Paso 9: Aquí esta una captura de pantalla con un ejemplo de una instalación exitosa del Active-X o del Plug-in. Haga clic en el botón play para reproducir el vídeo.



Paso 10: Haga clic en el menú de la parte izquierda de la interfaz web para mas parámetros de configuración avanzados.

Conecte la GXV3674_HD/FHD_VF usando IP estática

Si la cámara no recibe una respuesta desde el servidor DHCP o la red no tiene un servidor DHCP, después de 3 minutos, se puede acceder por la dirección IP predeterminada 192.168.1.168.

- Paso 1:** Use el cable de red Ethernet RJ45 para conectar el puerto de red de su computadora directamente al conector RJ45 de la GXV3674_HD/FHD_VF.
- Paso 2:** Ejecute la herramienta GS_Search como se indica anteriormente, se mostrará la IP de la GXV3674_HD/FHD_VF (La dirección IP por defecto es 192.168.1.168).
- Paso 3:** Ingrese la nueva dirección IP, máscara de red, y puerta de enlace predeterminada de acuerdo a la configuración de su red, por favor contacte al administrador de su red para la información necesaria.
- Paso 4:** Haga Click en "Modificar IP". La dirección IP deseada se aplicará en la GXV3674_HD/FHD_VF.

Por favor, descargue el Manual del usuario, consulte la documentación en línea y preguntas frecuentes para obtener información más detallada.

<http://www.grandstream.com/index.php/products/ip-video-surveillance/gxv3674>

<http://www.grandstream.com/support>

<http://www.grandstream.com/support/tools>

ESPECIFICACIONES DE LA GXV3674_HD/FHD_VF v2

Sensibilidad del sensor de imagen	Modo día y noche Obturador: 1/10000 – 1/30 segundos
Longitud Focal	2.8 ~ 12 mm
Apertura	F1.4, DC-IRIS
Ángulo de campo (FOV)	90° ~ 28° (Campo de visión horizontal)
Filtro de corte IR	Si, Mecánico
Modo día y noche	Modo a color y blanco y negro, cobertura del LED IR de hasta 25m
Iluminación mínima	0.05 Lux 0 Lux con el LED IR
Responsividad	HD: 5.48V/lux-sec (550nm) FHD: 1.9V/lux-sec (550nm)
Resolución máxima de vídeo y velocidad de cuadro	HD: 1280 x 960 (25fps) FHD: 2048 x 1536 (15fps)
Rango panorámico	0° - 180° (Manual)
Rango de inclinación	0° - 180° (Manual)

PRECAUTIONS

- Ne pas tenter d'ouvrir, de désassembler, ou de modifier le dispositif
- Ne pas utiliser un adaptateur d'alimentation tiers
- Ne pas exposer cet appareil à des températures en dehors de la plage des -20°C à +50°C en opération ou de -30°C à +60°C en stockage
- Ne pas exposer cet appareil à un environnement avec humidité en dehors de la plage de 10-90% RH (sans condensation)
- Veuillez convenablement installer la caméra pour un fonctionnement correct.

CONTENU DU PACK

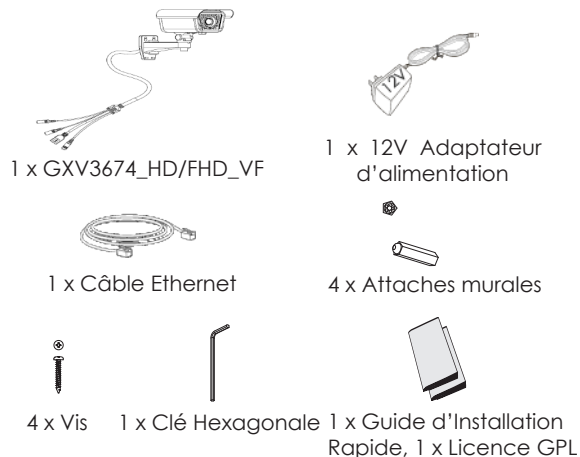

~17~

CONNEXION DU GXV3674_HD/FHD_VF

Reportez-vous à l'illustration ci-dessous en suivant les instructions sur la page suivante.

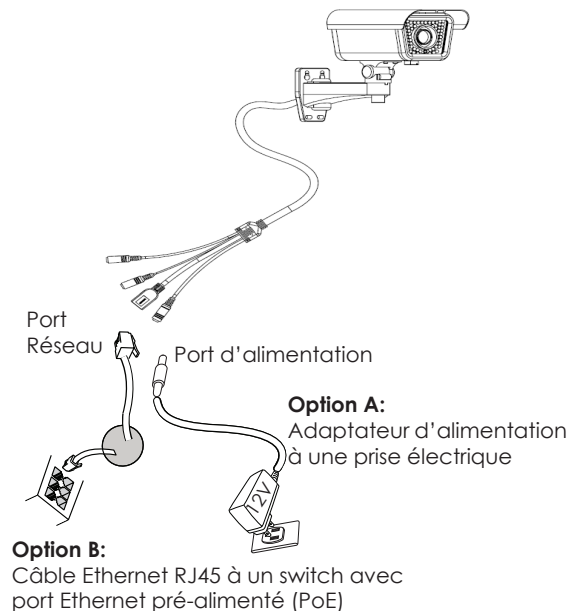

NOTE: Choisissez l'option A si vous utilisez l'alimentation, ou choisissez l'option B si vous utilisez un switch à port Ethernet pré-alimenté (PoE).

~18~

Option A

Etape 1: Insérez l'adaptateur d'alimentation dans le port 12V DC du GXV3674_HD/FHD_VF. Branchez l' autre extrémité à une prise électrique.

Etape 2: Branchez un câble Ethernet RJ45 au port réseau. Branchez l'autre extrémité à un switch ou routeur.

Option B

Etape 1: Branchez un câble Ethernet RJ45 sur le port réseau du GXV3674_HD/FHD_VF. Branchez l'autre extrémité à un switch avec port Ethernet préalimenté (PoE).

CONFIGURATION DU GXV3674_HD/FHD_VF

Configurer le GXV3674_HD/FHD_VF en utilisant le navigateur Firefox, Chrome ou Microsoft Internet Explorer (avec plugin installé)

Connecter le GXV3674_HD/FHD à un serveur DHCP

Etape 1: Téléchargez et installez l'outil GS_Search:

http://www.grandstream.com/products/tools/surveillance/GS_Search.zip

Etape 2: Exécutez l'outil Grandstream GS_Search.

Etape 3: Cliquez sur le bouton  pour lancer la détection des appareils.

Etape 4: Les appareils détectés s'afficheront dans le champ de sortie comme ci-dessous.

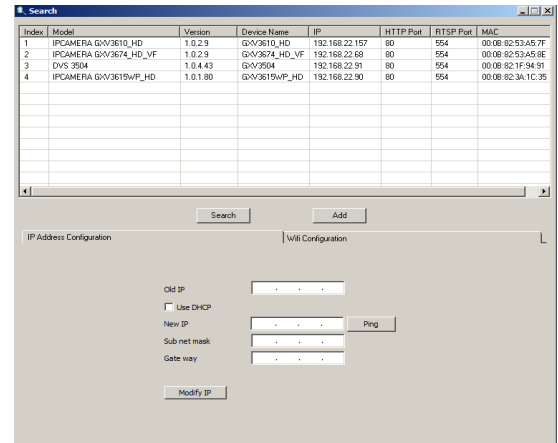

Etape 5: Double cliquez sur l'appareil détecté. Le navigateur par défaut (MS IE dans cet exemple) s'exécutera en affichant l'interface web de la caméra.

Etape 6: Une fenêtre pop-up invitant à entrer un nom d'utilisateur et un mot de passe apparaîtra. Le nom d'utilisateur et le mot de passe administrateur sont configurés initialement à "admin".

Etape 7: Une fois connecté sur l'interface WebGUI l'appareil indiquera qu'un Active-X ou plugin vidéo est requis. Suivez les instructions affichées pour télécharger et installer le plugin vidéo.

Etape 8: Si le téléchargement/installation échoue à cause des paramètres du navigateur ou de lenteur de connexion Internet, veuillez télécharger les fichiers à partir du lien suivant. Enregistrez et installez le programme puis redémarrer le navigateur. La vidéo sera maintenant affichée.

• **Plug-in:**

http://www.grandstream.com/products/tools/surveillance/webcontrl_plugin.zip

Etape 9: Voici une capture d'écran montrant une installation réussie de l'Active-X ou Plugin.



Etape10: Pour les paramètres de configuration avancés cliquez sur le menu dans la partie gauche de l'interface web.

Connecter le GXV3674_HD/FHD_VF en utilisant une adresse IP Statique

Si la caméra ne reçoit pas de réponse du serveur DHCP ou qu'il n'y pas de serveur DHCP sur le réseau, au bout de 3 minutes, vous pouvez y accéder par l'adresse IP par défaut 192.168.1.168.

Etape 1: Utilisez un câble Ethernet RJ-45 pour connecter le port réseau de votre PC directement au port réseau du GXV3674_HD/FHD_VF.

Etape 2: Exécutez l'outil GS_Search comme ci-dessus. Il affichera l'adresse IP originale du GXV3674_HD/FHD_VF (adresse IP par défaut 192.168.1.168).

Etape 3: Saisissez la NOUVELLE adresse IP, Masque du Sous-Réseau et la passerelle par défaut, suivant la configuration de votre réseau. Veuillez consulter votre administrateur système pour les informations nécessaires.

Etape 4: Cliquez sur "Modify IP". L'adresse IP souhaitée sera appliquée au GXV3674_HD/FHD_VF

Veuillez télécharger le Manuel d'Utilisateur, consultez les documents en ligne et FAQ pour des informations plus détaillées.

<http://www.grandstream.com/index.php/products/ip-video-surveillance/gxv3674>

<http://www.grandstream.com/support>

<http://www.grandstream.com/support/tools>

SPECIFICATIONS DU GXV3674_HD/FHD_VF v2

Sensibilité Capteur d'Images	Mode Jour & Nuit. Obturbateur: 1/10000 - 1/30 seconde
Distance Focale	2.8 ~ 12 mm
Ouverture	F1.4, DC-IRIS
Angles de vue (FOV)	98° ~ 28° (Champ de vision horizontal)
Filtre IR Cut	Oui, Mécanique.
Mode Jour & Nuit	Couleur & mode N/B. LED IR couvrant jusqu'à 30m
Illumination Minimum	0.05 Lux 0 Lux avec LED IR allumé
Sensibilité	HD: 5.48V/lux-sec (550nm) FHD: 1.9V/lux-sec (550nm)
Résolution Vidéo Maximum et Taux de Trames	HD: 1280 x 960 (25fps) FHD: 2048 x 1536 (15fps)
Champ de Rotation Horizontale	0° - 180° (Manuel)
Champ de Rotation Verticale	0° - 180° (Manuel)

注意事项

- 请不要打开、拆卸或修改该设备
- 请不要使用第三方的电源适配器
- 请不要在超出-20至50摄氏度环境下使用此设备；
请不要在超出-30至60摄氏度环境下保存此设备
- 请不要将GXV3674_HD/FHD_VF暴露在超出相对湿度10-90%范围外的环境下
- 请准确安装保证GXV3674_HD/FHD_VF正常工作

包装内容

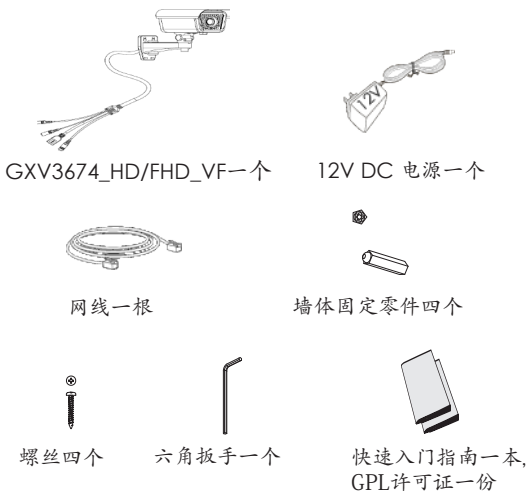

~25~

GXV3674_HD/FHD_VF 连接方法

请参照下图以及下一页的操作说明。

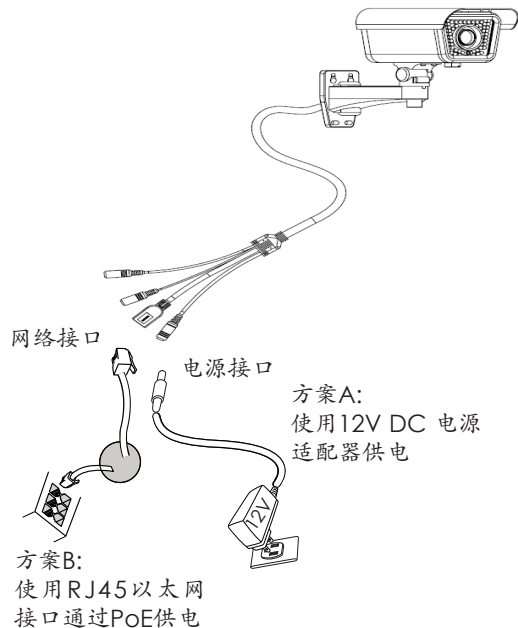

注意: 选择A方案使用电源适配器给设备供电或选择
B方案使用PoE给设备供电。

~26~

方案A

步骤 1: 将电源适配器与GXV3674_HD/FHD_VF连线上的12V DC 端口相连;

步骤 2: 将RJ45网线一端与 GXV3674_HD/FHD_VF 连线上的网络接口相连, 另一端与集线器、交换机或路由器相连。

方案B

步骤 1: 将RJ45网线一端与GXV3674_HD/FHD_VF连线上的网络接口相连, 另一端与以太网供电 (PoE) 交换机相连。

GXV3674_HD/FHD_VF配置

通过Firefox, Chrome 或Microsoft Internet Explorer 浏览器配置GXV3674_HD/FHD_VF (需安装插件)

连接GXV3674_HD/FHD_VF到DHCP服务器环境下, GXV3674_HD/FHD_VF默认通过DHCP获取IP地址

步骤 1: 通过浏览器访问地址下载并安装 GS_Search

http://www.grandstream.com/products/tools/surveillance/GS_Search.zip

步骤 2: 运行下载的 GS_Search 工具

步骤 3: 点击  按钮, 搜索该网段下的设备IP地址

步骤 4: 搜索到的设备IP地址及HTTP端口将显示在以下界面

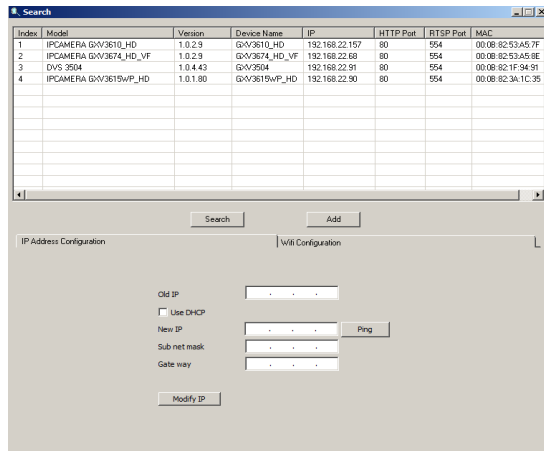

步骤 5: 双击界面上检测到的设备, 默认浏览器 (如IE浏览器) 将会打开并显示 GXV3674_HD/FHD_VF 的 Web 界面

步骤 6: 界面将会跳出输入用户名及密码的验证框出厂时默认的用户名和密码均为 admin

步骤 7: 登陆到GXV3674_HD/FHD_VF网络界面后, 浏览器将提示您安装插件。参照提示下载插件Active-X 或Video Plug-in

步骤 8: 如果由于浏览器设置或网速慢等原因无法下载安装插件, 请使用以下链接下载插件文件。保存并安装插件, 重启浏览器。此时浏览器将显示GXV3674_HD/FHD_VF Web界面中的视频

- 插件:

http://www.grandstream.com/products/tools/surveillance/webcontrl_plugin.zip

步骤 9: 插件安装成功后, 用户可以看到如下图所示的 Web 界面。点击播放按钮观看视频

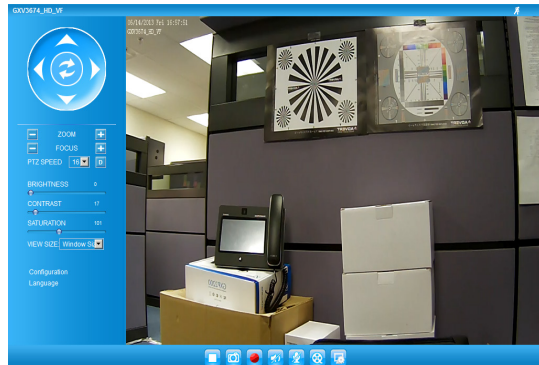

步骤 10: 点击Web界面左侧的菜单进行更多的高级配置

通过默认的静态IP地址访问

如果将GXV3674_HD/FHD_VF置于非DHCP环境下或三分钟后未从DHCP服务器得到响应，它将使用默认的静态IP地址192.168.1.168。

步骤 1: 将您的PC与GXV3674_HD/FHD_VF通过RJ45网线相连

步骤 2: 在PC上运行GS_Search工具GXV3674_HD/FHD_VF的初始IP地址将会显示：
192.168.1.168（默认初始IP地址）；

步骤 3: 请根据您的网络配置为GXV3674_HD/FHD_VF输入新IP地址，子网掩码以及默认网关地址。如有需要，请联系您的网络系统管理员获取必要信息

步骤 4: 请点击Modify IP，新的IP地址将会应用在GXV3674_HD/FHD_VF上

请下载用户手册，网站文档以及常见问题解答，取得更详细的配置说明。下载地址：

<http://www.grandstream.com/index.php/products/ip-video-surveillance/gxv3674>

<http://www.grandstream.com/support>

<http://www.grandstream.com/support/tools>

GXV3674_HD/FHD_VF v2 参数

图像传感器灵敏度	白天和夜晚模式 快门: 1/10000 - 1/30 秒
焦距	2.8 ~ 12 mm
通光孔径	F1.4, DC-IRIS
视场角 (FOV)	90° ~ 28° (水平面视场)
光圈	是, 机械
白天/夜晚模式	彩色或黑白模式 IR LED 覆盖范围至25米
最低限度照明	0.05 Lux 0 lux, 当 IR LED 开启时
响应	HD: 5.48V/lux-sec (550nm) FHD: 1.9V/lux-sec (550nm)
最高视频分辨率及帧速率	HD: 1280 x 960 (25fps) FHD: 2048 x 1536 (15fps)
水平旋转范围	0° - 180° (手动)
倾斜范围	0° - 180° (手动)

WICHTIGE HINWEISE

- Versuchen Sie nicht, das Gerät zu öffnen, zu zerlegen oder zu modifizieren.
- Verwenden Sie keine Netzteile von anderen Herstellern.
- Das Gerät darf nicht bei Temperaturen jenseits von -20 °C bis +50 °C betrieben oder gelagert werden von -30 °C bis +60 °C.
- Die Luftfeuchtigkeit muss innerhalb des folgenden Bereichs liegen: 10–90% rel. Luftfeuchtigkeit (nicht-kondensierend)
- Die Kamera muss ordnungsgemäß montiert werden, damit sie einwandfrei funktioniert.

LIEFERUMFANG



1 GXV3674_HD/FHD_VF



1 12-V-Netzteil



1 Ethernet-Kabel



4 Wandhalterungen



4 Schrauben



1 Sechskant-
schlüssel



1 Schnellstarth-andbuch,
1 GPL-Lizenz

ANSCHLIESSEN DES GXV3674_HD/FHD_VF

Orientieren Sie sich bei den Anweisungen auf der nächsten Seite an der folgenden Abbildung.

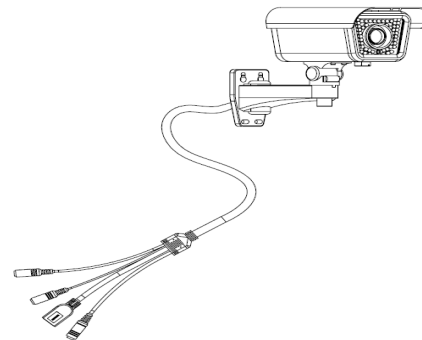

Netzwerk-
anschluss

Stromanschluss

Option A:

Netzteil an Netzsteckdose

Option B:

RJ45-Ethernet-Kabel
an PoE-Switch (Power
over Ethernet)

HINWEIS: Wählen Sie bei Verwendung einer Steckdose
Option A und bei Verwendung eines PoE-
Switches (Power over Ethernet) Option B.

Option A

Schritt 1: Stecken Sie das Netzteil in die 12-V-DC-Buchse des rückwärtigen Kabels in der GXV3674_HD/FHD_VF. Stecken Sie das andere Endedes Netzteils in die Steckdose.

Schritt 2: Stecken Sie ein RJ45-Ethernet-Kabel in die Netzwerkbuchse des rückwärtigen Kabels in der GXV3674_HD/FHD_VF. Stecken Sie das andere Ende in einen Switch oder Router.

Option B

Schritt 1: Stecken Sie ein RJ45-Ethernet-Kabel in die Netzwerkbuchse des rückwärtigen Kabels in der GXV3674_HD/FHD_VF. Stecken Sie das andere Ende in einen PoE-Switch (Power over Ethernet).

KONFIGURATION DES GXV3674_HD/FHD_VF

Konfiguration der GXV3674_HD/FHD_VF über Firefox, Chrome oder Microsoft Internet Explorer (mit installiertem Plug-In)

GXV3674_HD/FHD_VF an Netzwerk mit aktiviertem DHCP-Server anschließen

Schritt 1: Laden Sie das Tool GS_Search herunter, und installieren Sie es.

http://www.grandstream.com/products/tools/surveillance/GS_Search.zip

Schritt 2: Starten Sie das Tool GS_Search.

Schritt 3: Klicken Sie auf die Taste „  „, um die Geräteerkennung zu starten.

Schritt 4: Die erkannten Geräte werden im Ausgabefeld wie folgt angezeigt.

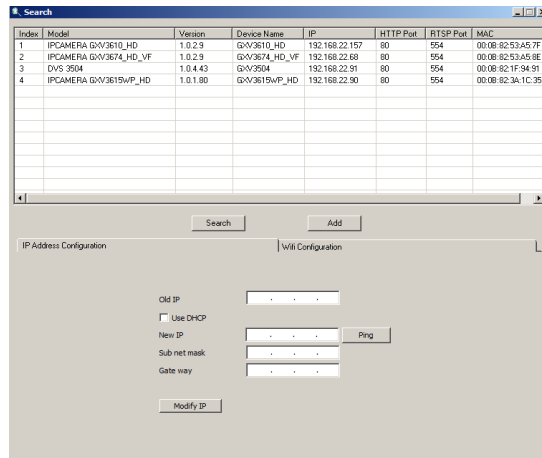

Schritt 5: Doppelklicken Sie auf das erkannte Gerät. Daraufhin öffnet sich die Web-Benutzeroberfläche der Kamera im Standard-Browser (in diesem Beispiel Internet Explorer).

Schritt 6: Sie werden in einem Popup-Fenster zur Eingabe des Benutzernamens und des Kennworts aufgefordert. Der Standard-Benutzername und das Standard-Kennwort des Administrators sind beide auf "admin" voreingestellt.

Schritt 7: Wenn Sie sich bei der Web-Benutzeroberfläche der GXV3674_HD/FHD_VF anmelden, wird Ihnen gemeldet, dass ein ActiveX-Element bzw. ein Video-Plug-In benötigt wird. Befolgen Sie die angezeigten Anweisungen zum Herunterladen und Installieren des ActiveX-Elements (Internet Explorer) bzw. des Video-Plug-Ins (Firefox, Chrome).

Schritt 8: Falls Sie das benötigte Plug-In aufgrund der Browsereinstellungen oder einer langsamen Internetverbindung nicht herunterladen bzw. installieren können, laden Sie die Dateien bitte über den folgenden Link herunter. Speichern und installieren Sie das Programm, und starten Sie dann den Browser neu. Das Video wird nun in die Web-Benutzeroberfläche der Kamera eingebettet angezeigt.

- **Plug-in:**

http://www.grandstream.com/products/tools/surveillance/webcontrl_plugin.zip

Schritt 9: Dies ist ein Beispiel-Screenshot nach erfolgreicher Installation des ActiveX-Elements bzw. des Video-Plug-Ins. Klicken Sie auf die Wiedergabe-Schaltfläche, um das Video anzusehen.

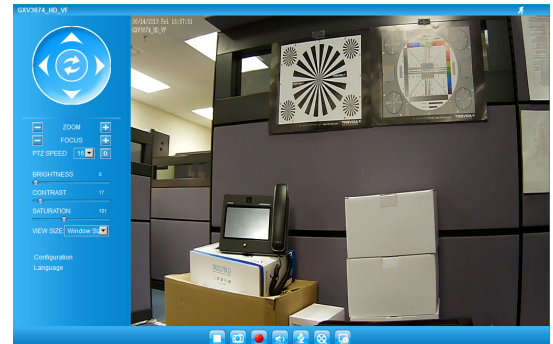

Schritt 10: Über das links in der Web-Benutzeroberfläche befindliche Menü können Sie erweiterte Konfigurationsparameter aufrufen.

GXV3674_HD/FHD_VF über eine statische IP-Adresse anschließen

Wenn die Kamera innerhalb von drei Minuten keine Antwort vom DHCP-Server oder dem Netzwerk ohne DHCP-Funktion erhält, kann sie über die Standard-IP-Adresse 192.168.1.168 angesprochen werden.

Schritt 1: Sie können den Netzwerkanschluss des Computers über ein RJ-45-Ethernet-Kabel direkt mit dem Ethernet-Anschluss der GXV3674_HD/FHD_VF verbinden.

Schritt 2: Starten Sie das Tool GS_Search wie weiter oben beschrieben. Darin wird die Original-IP-Adresse des GXV3674_HD/FHD_VF angezeigt (die Standard-IP-Adresse lautet 192.168.1.168).

Schritt 3: Geben Sie die NEUE IP-Adresse, Subnetzmaske und das Standard-Gateway entsprechend Ihrer Netzwerkkonfiguration ein. Erfragen Sie die Angaben ggf. beim zuständigen System-administrator.

Schritt 4: Klicken Sie auf „Modify IP“ (IP-Adresse ändern). Nun wird die gewünschte IP-Adresse für das GXV3674_HD/FHD_VF eingestellt.

Wenn Sie sich eingehender informieren möchten, laden Sie das Benutzerhandbuch herunter, schlagen Sie in den verfügbaren Online-Dokumenten nach, und lesen Sie die Antworten auf häufig gestellte Fragen (FAQ).

<http://www.grandstream.com/index.php/products/ip-video-surveillance/gxv3674>

<http://www.grandstream.com/support>

<http://www.grandstream.com/support/tools>

TECHNISCHE DATEN DER GXV3674_HD/FHD_VF v2

Empfindlichkeit des Bildsensors	Tages- und Nachtmodus. Blende: 1/10000 – 1/30 Sekunde
Brennweite	2.8 ~ 12 mm
Apertur	F1.4, DC-IRIS
Feldwinkel (FOV)	90° ~ 28° (horizontalen Sichtfeld)
Infrarot-Sperrfilter	ja, mechanisch
Tages- und Nachtmodus	Farb- und SW-Modus. IR-LED, Abdeckung bis zu 25 m
Mindestbeleuchtung	0.05 lux 0 lux mit aktivem IR-LED
Empfindlichkeit	HD: 5.48V/lux-sec (550nm) FHD: 1.9V/lux-sec (550nm)
Maximale Videoauflösung und -bildfrequenz	HD: 1280 x 960 (25fps) FHD: 2048 x 1536 (15fps)
Schwenkbereich	0° - 180° (manuell)
Neigungsbereich	0° - 180° (manuell)

PRECAUZIONI

- Non tentare di aprire, smontare o modificare il dispositivo
- Non utilizzare un adattatore di alimentazione di terzi
- Non esporre il dispositivo a temperature non incluse nell'intervallo da -20 °C a +50 °C per l'operatività o da -30 °C a +60 °C per l'immagazzinaggio
- Non esporre il dispositivo ad ambienti non inclusi nel seguente intervallo di umidità: 10 - 90 % di umidità relativa (senza condensa)
- Installare la videocamera per consentire il corretto funzionamento

CONTENUTO DELL'IMBALLAGGIO



~41~

COLLEGAMENTO DEL DISPOSITIVO GXV3674_HD/FHD_VF

Per le istruzioni contenute nella pagina successiva, fare riferimento all'illustrazione riportata di seguito.

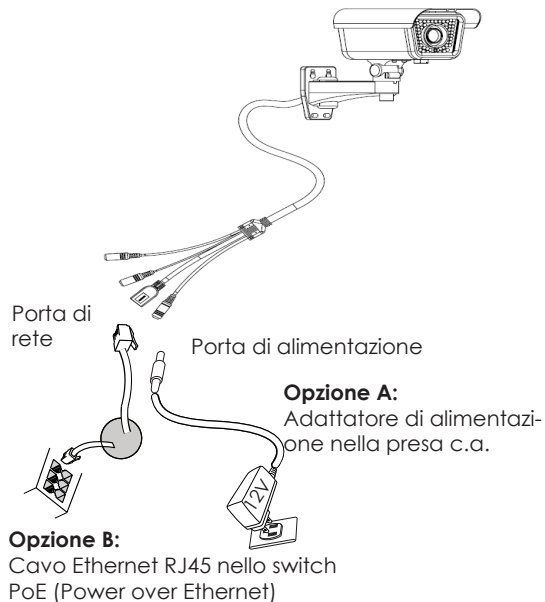

NOTA: scegliere l'opzione A se si utilizza l'alimentatore o l'opzione B se si utilizza lo switch PoE (Power over Ethernet).

~42~

Opzione A

Passo 1: inserire l'adattatore di alimentazione nella presa c.c. da 12 V del cavo di coda nel dispositivo GXV3674_HD/FHD_VF. Collegare l'altra estremità dell'adattatore alla presa di alimentazione c.a.

Passo 2: collegare un cavo Ethernet RJ45 nella presa di rete del cavo di coda nel dispositivo GXV3674_HD/FHD_VF. Collegare l'altra estremità in uno switch/hub o un router.

Opzione B

Passo 1: collegare un cavo Ethernet RJ45 nella presa di rete del cavo di coda nel dispositivo GXV3674_HD/FHD_VF. Collegare l'altra estremità in uno switch PoE.

CONFIGURAZIONE DI GXV3674_HD/FHD_VF

Configurazione di GXV3674_HD/FHD_VF mediante Firefox, Chrome o Microsoft Internet Explorer (con plug-in installato)

Collegamento di GXV3674_HD/FHD_VF a una rete abilitata per server DHCP

Passo 1: scaricare e installare lo strumento GS_Search

http://www.grandstream.com/products/tools/surveillance/GS_Search.zip

Passo 2: eseguire lo strumento Grandstream GS_Search.

Passo 3: fare clic sul pulsante di ricerca per iniziare il rilevamento del dispositivo. 

Passo 4: i dispositivi rilevati verranno visualizzati nel campo di output come indicato di seguito.

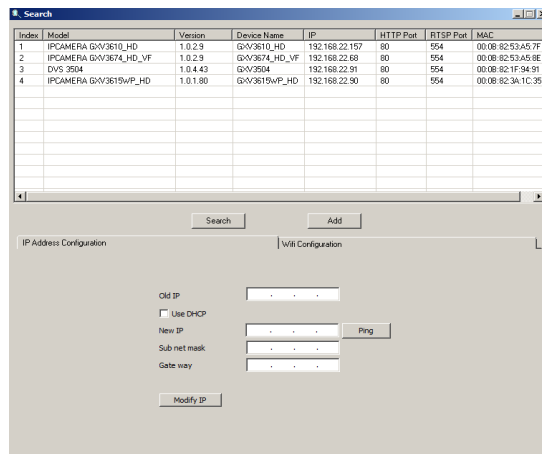

The screenshot shows the GS_Search application window. At the top, there is a table with the following data:

Index	Model	Version	Device Name	IP	HTTP Port	RTSP Port	MAC
1	IPCAMERA GXV3610_HD	1.0.2.9	GXV3610_HD	192.168.22.157	80	554	00:0B:82:53:A5:7F
2	IPCAMERA GXV3674_HD_VF	1.0.2.9	GXV3674_HD_VF	192.168.22.68	80	554	00:0B:82:53:A5:8E
3	DVS 3504	1.0.4.43	GXV3504	192.168.22.91	80	554	00:0B:82:1F:94:91
4	IPCAMERA GXV3615wP_HD	1.0.1.80	GXV3615wP_HD	192.168.22.90	80	554	00:0B:82:3A:1C:35

Below the table, there are buttons for "Search" and "Add". Underneath, there are two sections: "IP Address Configuration" and "VLAN Configuration". The "IP Address Configuration" section includes fields for "Old IP", "New IP", "Sub net mask", and "Gate way", each with a dropdown menu. There is a checkbox for "Use DHCP" and a "Ping" button. A "Modify IP" button is located at the bottom of the configuration section.

Passo 5: fare doppio clic sul dispositivo rilevato. Nel browser predefinito (Internet Explorer in questo esempio) verrà visualizzata l'interfaccia Web della videocamera.

Passo 6: in una finestra a comparsa verranno richiesti il nome utente e la password. Il nome utente e la password predefiniti dell'amministratore vengono impostati entrambi su "admin" come configurazione di fabbrica predefinita.

Passo 7: una volta eseguito l'accesso all'interfaccia Web del dispositivo GXV3674_HD/FHD_VF, verrà richiesto un plug-in video o Active-X. Seguire le istruzioni visualizzate per scaricare e installare Active-X o il plug-in video.

Passo 8: se si verifica un errore in fase di download o installazione a causa delle impostazioni del browser o della lentezza della connessione Internet, scaricare i file dal collegamento di seguito. Salvare e installare il programma, quindi riavviare il browser. Il video risulterà ora incorporato all'interfaccia Web della videocamera.

• Plug-in:

http://www.grandstream.com/products/tools/surveillance/webcontrl_plugin.zip

Passo 9: di seguito è riportata una schermata di esempio con una corretta installazione di Active-X o del plug-in. Fare clic sul pulsante di riproduzione per visualizzare la trasmissione video.



Passo 10: fare clic nel menu a sinistra dell'interfaccia Web per individuare i parametri di configurazione più avanzati.

Collegamento del dispositivo GXV3674_HD/FHD_VF mediante un IP statico

Se la videocamera non ottiene una risposta dal server DHCP o dalla rete senza un server DHCP, dopo 3 minuti è possibile accedervi dall'indirizzo IP predefinito 192.168.1.168.

Passo 1: utilizzare il cavo Ethernet RJ-45 per collegare la porta di rete del computer direttamente alla presa Ethernet del dispositivo GXV3674_HD/FHD_VF.

Passo 2: eseguire lo strumento GS_Search come indicato in precedenza. Verrà visualizzato l'IP originale del dispositivo GXV3674_HD/FHD_VF (indirizzo IP predefinito 192.168.1.168).

Passo 3: inserire il NUOVO indirizzo IP, la subnet mask e il gateway predefinito in base alla configurazione della rete. Verificare le informazioni necessarie con l'amministratore di sistema locale.

Passo 4: fare clic sull'opzione per modificare l'IP. L'indirizzo IP desiderato verrà applicato al dispositivo GXV3674_HD/FHD_VF.

Per ulteriori informazioni dettagliate, scaricare il manuale dell'utente e fare riferimento ai documenti online e alle domande frequenti.

<http://www.grandstream.com/index.php/products/ip-video-surveillance/gxv3674>

<http://www.grandstream.com/support>

<http://www.grandstream.com/support/tools>

SPECIFICHE DI GXV3674_HD/FHD_VF v2

Sensibilità del sensore immagini	modalità giorno e notte. Otturatore: 1/10000 - 1/30 secondo
Lunghezza focale	2.8 ~ 12 mm
Apertura	F1.4, DC-IRIS
Angolo di campo (FOV)	90° ~ 28° (Campo di vista orizzontale)
Filtro IR Cut	sì, meccanico
Modalità giorno e notte	modalità a colori e in B/N. LED IR fino a 25m
Illuminazione minima	0.05 Lux 0 Lux con LED IR acceso
Capacità di risposta	HD: 5.48V/lux-sec (550nm) FHD: 1.9V/lux-sec (550nm)
Risoluzione video massima e frequenza dei fotogrammi	HD: 280 x 960 (25fps) FHD: 2048 x 1536 (15fps)
Intervallo panoramica (pan)	0° - 180° (manuale)
Intervallo inclinazione (tilt)	0° - 180° (manuale)

ПРЕДВАРИТЕЛЬНЫЕ УСЛОВИЯ

- Не пытайтесь открывать, разбирать или изменять устройство
- Не используйте адаптер питания другого производителя
- Не допускается использование устройства при температурах вне диапазона от -20 °С до +50 °С при эксплуатации и от -30 °С до +60 °С при хранении
- Не допускается выставлять устройство наружу при относительной влажности вне диапазона 10-90% (без конденсата)
- Нормальная работа камеры возможна только при правильной установке

КОМПЛЕКТ ПОСТАВКИ



ПОДКЛЮЧЕНИЕ GXV3674_HD/FHD_VF

При выполнении инструкций на следующей странице см. приведенный рисунок.

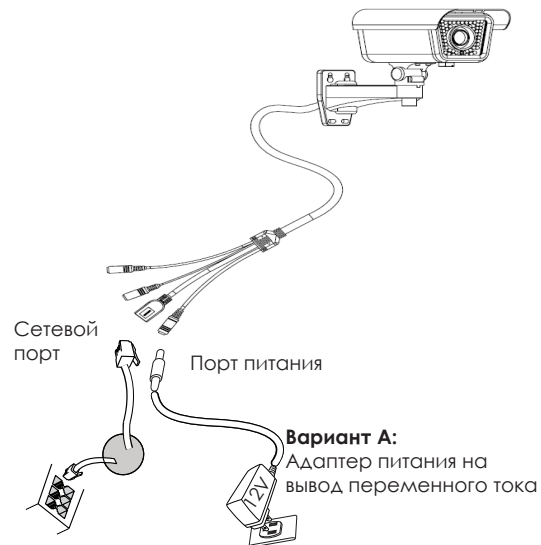

ПРИМЕЧАНИЕ: при питании от сети применяется вариант А; при питании через переключатель питания через Ethernet (PoE) применяется вариант В.

Вариант А

Шаг 1: вставьте адаптер питания в гнездо 12 В постоянного тока отвода кабеля в GXV3674_HD/FHD_VF. Вставьте другой конец адаптера в выход питания переменного тока.

Шаг 2: вставьте кабель Ethernet RJ45 в сетевое гнездо отвода кабеля в GXV3674_HD/FHD_VF. Вставьте другой конец в узел/выключатель или маршрутизатор.

Вариант В

Шаг 1: вставьте кабель Ethernet RJ45 в сетевое гнездо отвода кабеля в GXV3674_HD/FHD_VF. Вставьте другой конец в переключатель через Ethernet (PoE).

КОНФИГУРАЦИЯ GXV3674_HD/FHD_VF

Конфигурация GXV3674_HD/FHD_VF с помощью Firefox, Chrome или Microsoft Internet Explorer (с установленным подключаемым модулем)

Подключите GXV3674_HD/FHD_VF к включенной сети сервера DHCP

Шаг 1: загрузите и установите инструмент GS_Search.

http://www.grandstream.com/products/tools/surveillance/GS_Search.zip

Шаг 2: запустите инструмент Grandstream GS_Search.

Шаг 3: для запуска определения устройства щелкните кнопку “  ”.

Шаг 4: обнаруженные устройства появятся в поле вывода, как показано ниже.

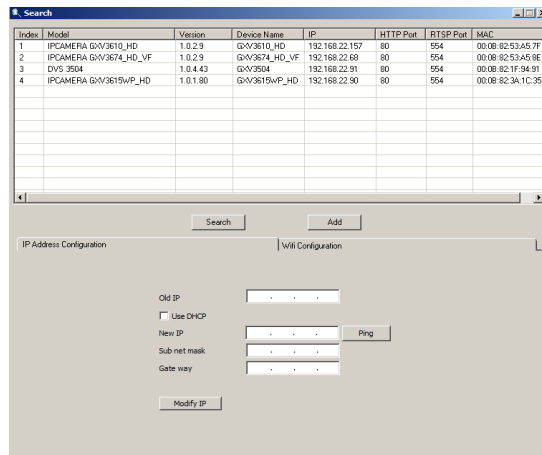

Шаг 5: дважды щелкните на обнаруженное устройство. Откроется обозреватель по умолчанию (в данном примере IE) и отобразит веб-интерфейс камеры.

Шаг 6: во всплывающем окне появится имя пользователя и пароль. Заводская конфигурация имени и пароля пользователя администратора по умолчанию установлена на "admin".

Шаг 7: при регистрации на веб-интерфейсе GXV3674_HD/FHD_VF устройство укажет, что требуется подключение Active-X или видео. Для загрузки и установки Active-X (MS IE) или подключения видео (Firefox or Chrome) следуйте появляющимся инструкциям.

Шаг 8: Если вследствие настроек обозревателя или медленного соединения с Интернетом загрузка и установка не получились, загрузите файлы из приведенной ниже ссылки. Сохраните и установите программу, после чего перезапустите обозреватель. Теперь видео появится как встроенное в веб-интерфейс камеры.

• Plug-in:

http://www.grandstream.com/products/tools/surveillance/webctrl_plugin.zip

Шаг 9: приведен образец снимка при успешной установке Active-X или подключенного модуля. Для просмотра внешнего видеосигнала щелкните кнопку "Воспроизведение".



Шаг 10: дополнительные параметры конфигурации находятся в меню с левой стороны веб-интерфейса.

Подключите GXV3674_HD/FHD_VF с помощью Static IP

Если камера не получает сигнал от сервера DHCP или от сети без сервера DHCP через 3 минуты, его можно получить по IP-адресу по умолчанию 192.168.1.168.

Шаг 1: С помощью Ethernet-кабеля RJ-45 подключите сетевой порт компьютера непосредственно к гнезду Ethernet GXV3674_HD/FHD_VF.

Шаг 2: запустите инструмент GS_Search, как указано выше. Появится оригинальный IP-адрес GXV3674_HD/FHD_VF (IP-адрес по умолчанию 192.168.1.168).

Шаг 3: введите НОВЫЙ IP-адрес, маску подсети и шлюз по умолчанию в соответствии с конфигурацией сети. Проверьте необходимую информацию у администратора локальной системы.

Шаг 4: щелкните "Изменить IP". Нужный IP-адрес будет применен для GXV3674_HD/FHD_VF.

Более подробную информацию можно получить, загрузив Руководство пользователя, а также онлайн-ую документацию и часто задаваемые вопросы.

<http://www.grandstream.com/index.php/products/ip-video-surveillance/gxv3674>

<http://www.grandstream.com/support>

<http://www.grandstream.com/support/tools>

СПЕЦИФИКАЦИИ GXV3674_HD/FHD_VF v2

Чувствительность датчика изображений	дневной и ночной режим. Затвор: 1/10000 - 1/30 секунды
Фокусная длина	2.8 ~ 12 mm
Апертура	F1.4, DC-IRIS
Зона видимости (FOV)	90° ~ 28° (Горизонтальный вид)
ИК-фильтр с ограниченной полосой пропускания	да, механический
Дневной и ночной режим	цветной и черно-белый режим. Покрывание ИК-светодиода до 25 м
Минимальное иллюминирование	0.05 люкс 0 люкс при включенном ИК-светодиоде
Чувствительность	HD: 5.48 В/люкс-сек (550 нм) FHD: 1.9 В/люкс-сек (550 нм)
Максимальное разрешение видео и частота кадров	HD: 1280 x 960 (25 кадров в секунду). FHD: 2048 x 1536 (15 кадров в секунду)
Диапазон панорамирования	0° - 180° (в ручном режиме)
Диапазон пределов наклона	0° - 180° (в ручном режиме)

PRECAUÇÕES

- Não tente abrir, desmontar ou modificar o dispositivo.
- Não use adaptador de energia de terceiros.
- Não exponha este dispositivo fora do intervalo de temperaturas de -20 ° C a 50 ° C durante a operação ou -30 ° C a 60 ° C durante o armazenamento.
- Não exponha este aparelho em ambientes fora da seguinte gama de umidade: 10-90% RH (sem condensação).
- Por favor, instalar a câmera adequadamente para uma função correta.

CONTEÚDO DO PACOTE



1 x GXV3674_HD/FHD_VF



1 x Fonte de alimentação de 12V



1 x Cabo de Ethernet



4 x Buchas de parede



1 x Guia de Instalação Rápida
1 x Licença GPL



4 x Parafusos



1 x Chave hexagonal

CONEXÃO DA GXV3674_HD/FHD_VF

De acordo com a ilustração abaixo, siga as instruções na página seguinte.

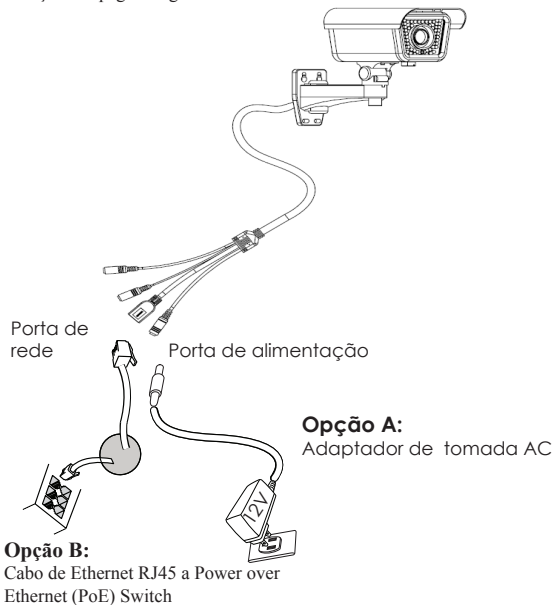

NOTA: Escolha a opção A se estiver usando a fonte de alimentação, ou escolher Opção B se estiver usando um switch Power over Ethernet (PoE).

Opção A

Passo 1: Insira o adaptador de alimentação ao conector 12 VDC na parte de trás do GXV3674_HD/FHD_VF. Ligue a outra extremidade do adaptador em uma tomada AC.

Passo 2: Conecte um cabo Ethernet RJ45 na porta de rede que está na parte de trás do GXV3674_HD/FHD_VF e conecte a outra extremidade do cabo em um switch/hub ou roteador.

Opção B

Passo 1: Ligue o conector Ethernet RJ45 que está na parte de trás do GXV3674_HD/FHD_VF e ligue a outra extremidade do cabo em um switch PoE.

CONFIGURAÇÃO DE GXV3674_HD/FHD_VF

Configurando o GXV3674_HD/FHD_VF usando Firefox, Chrome ou Microsoft Internet Explorer

Ligue a GXV3674_HD/FHD_VF em uma rede com um servidor DHCP ativo

Passo 1: Faça o download e instale a ferramenta GS_Search:

http://www.grandstream.com/products/tools/surveillance/GS_Search.zip

Passo 2: Execute a ferramenta GS_Search da Grandstream.

Passo 3: Clique no botão  para iniciar detecção de dispositivos na rede.

Passo 4: Os dispositivos detectados serão exibidos no campo de saída, conforme mostrado abaixo.

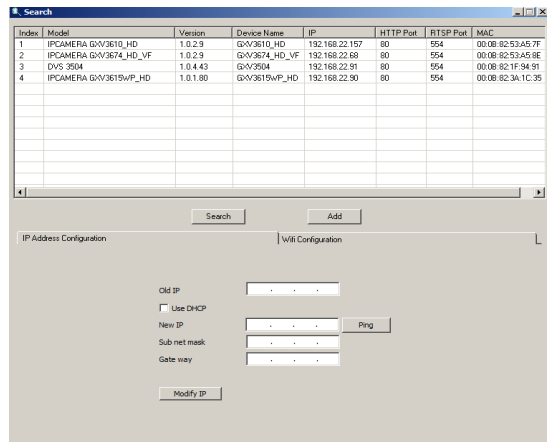

Index	Model	Version	Device Name	IP	HTTP Port	RTSP Port	MAC
1	IPCAMERA GV-V3610_HD	1.0.2.9	GV-V3610_HD	192.168.22.157	80	554	00:08:82:53:A5:7F
2	IPCAMERA GV-V3674_HD_VF	1.0.2.9	GV-V3674_HD_VF	192.168.22.68	80	554	00:08:82:53:A5:9E
3	DVS 3504	1.0.4.43	GV-V3504	192.168.22.91	80	554	00:08:82:1F:94:91
4	IPCAMERA GV-V3619WP_HD	1.0.1.80	GV-V3619WP_HD	192.168.22.90	80	554	00:08:82:3A:1C:39

Search Add

IP Address Configuration | WiFi Configuration

Old IP: [. . .]

Use DHCP

New IP: [. . .] Ping

Sub net mask: [. . .]

Gate way: [. . .]

Modify IP

Passo 5: Dê um duplo clique no dispositivo detectado. O navegador padrão (Internet Explorer, por exemplo) se abrirá, mostrando a interface web da câmara.

Passo 6: Uma janela pop-up vai solicitar o nome de usuário e senha, o nome e senha do usuário padrão é admin.

Passo 7: Após acessar a Interface Web, o dispositivo indicará que um Active-X ou plug-in de vídeo é necessário. Siga as instruções para baixar e instalar o plug-in.

Passo 8: Se o download/instalação não for bem sucedida, devido a configurações do seu navegador ou conexão de Internet lenta, faça o download dos arquivos a partir do link abaixo. Baixe e instale o programa e reinicie o navegador. O vídeo será exibido agora dentro da interface web da câmera.

• **Plug-in:**

http://www.grandstream.com/products/tools/surveillance/webcontrl_plugin.zip

Passo 9: Segue abaixo exemplo de imagem de uma instalação com sucesso do Active-X e Plug-in. Clique no botão reproduzir para ver o vídeo.

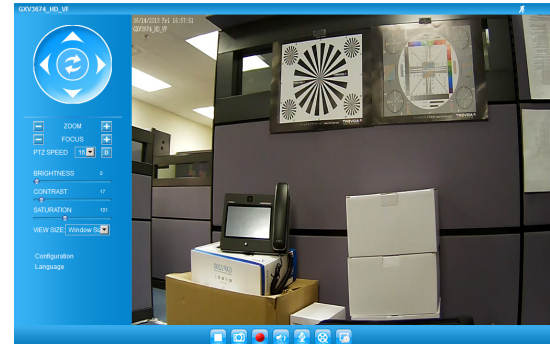

Passo 10: Clique no menu esquerdo da interface web para obter parâmetros de configuração avançada.

Conectar à GXV3674_HD/FHD_VF utilizando endereço IP estático

Se a câmara não receber uma resposta do servidor DHCP ou se a rede não possuir um servidor DHCP, após três minutos, poderá acessá-la pelo endereço IP padrão 192.168.1.168.

Passo 1: Utilize um cabo Ethernet RJ45 para conectar a porta da rede do seu computador diretamente ao conector RJ45 do GXV3674_HD/FHD_VF.

Passo 2: Execute a ferramenta GS_Search como indicado acima, mostrará o endereço IP do GXV3674_HD/FHD_VF (endereço IP padrão é 192.168.1.168).

Passo 3: Digite o novo endereço IP, máscara de sub-rede, e o gateway padrão, de acordo com a configuração de sua rede, contate seu administrador de rede para informações necessárias.

Passo 4: Clique em "Modificar IP". O endereço IP desejado será aplicado no GXV3674_HD/FHD_VF.

Para informações mais detalhadas, favor efetuar o download do Manual do Usuário, consultar a documentação on-line e FAQs.

<http://www.grandstream.com/index.php/products/ip-video-surveillance/gxv3674>

<http://www.grandstream.com/support>

<http://www.grandstream.com/support/tools>

ESPECIFICAÇÕES DA GXV3674_HD/FHD_VF v2

Sensibilidade do sensor de imagem	Modo Dia e Noite. Obturador : 1/10000 – 1/30 Segundo
Distância focal	2.8 ~ 12 mm
Abertura	F1.4, DC-IRIS
Ângulo de visão do campo (FOV)	90° ~ 28° (Campo Horizontal)
Filtro de corte IR	Sim, mecânico
Modo Dia e Noite	Cor B/W, IR LED cobrindo até 25m
Iluminação mínima	0.05 Lux 0 lux com IR LED
Resposta	HD: 5.48V/lux-sec (550nm) FHD: 1.9 V/lux-sec (550nm)
Vídeo Máximo permitido Resolução e taxa de quadros	HD: 1280 x 960 (25fps) FHD: 2048 x 1536 (15fps)
Panning Gama	0° - 180° (Manual)
Faixa de inclinação	0° - 180° (Manual)

OSTRZEŻENIA

- Nie wolno otwierać, rozbiierać oraz modyfikować urządzenia
- Nie wolno używać zasilaczy innych producentów
- Nie wystawiać sprzętu na temperatury spoza podanego zasięgu -20 °C do +50 °C dla działania i -30 °C do +60 °C dla przechowywania
- Nie wystawiać urządzenia poza dopuszczalne ramy kondensacji powietrza: 10 ~ 90% RH (Dla stanu nieskondensowanego)
- Kamera powinna zostać zainstalowana poprawnie dla dobrego działania

Zawartość kompletu

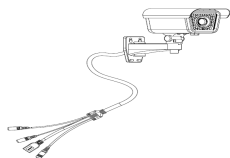

1 x GXV3674_HD/FHD_VF



1 x 12V zasilacz



1 x kabel ethernetowy



4 x kołki rozporowe



4 x śruby do 1 x Klucz ampulowy montażu



1 x Skrócona instrukcja
1 x Licencja GPL

~65~

Podłączenie GXV3674_HD/FHD_VF

Prosimy o korzystanie z ilustracji poniżej przy stosowaniu instrukcji ze strony następczej

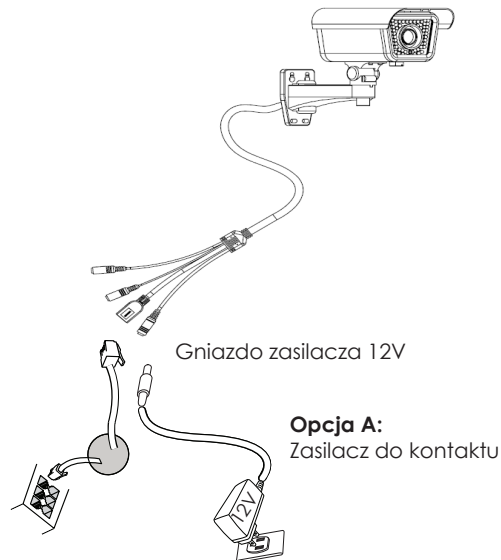

Opcja B:

Kabel ethernetowy RJ45 podłączamy do switcha z wbudowanym PoE (Power over Ethernet)

NOTE: Wybierz opcję A jeżeli używasz zasilacza, lub wybierz opcję B dla zasilania PoE.

~66~

Opcja A

Działanie 1: Podłącz zasilacz do kamery, a następnie podłącz do kontaktu.

Działanie 2: Podłącz kabel ethernetowy do kamery a następnie podłącz do routera, switcha bądź gniazda z siecią.

Opcja B

Działanie 1: Podłącz kabel ethernetowy do kamery a następnie podłącz do routera, switcha bądź gniazda z siecią.

KONFIGURACJA GXV3674_HD/FHD_VF

Konfiguracja kamery GXV3674_HD/FHD_VF przy użyciu Firefox, Chrome lub Microsoft Internet Explorer (z zainstalowanym odpowiednią wtyczką)

Podłącz kamerę do sieci z serwerem DHCP

Działanie 1: Pobierz i zainstaluj oprogramowanie GS_Search tool:

http://www.grandstream.com/products/tools/surveillance/GS_Search.zip

Działanie 2: Uruchom program GS_Search tool.

Działanie 3: Naciśnij  aby znaleźć kamery w otoczeniu sieciowym.

Działanie 4: Wykryte urządzenia zostaną wyświetlone w górnej części okna.

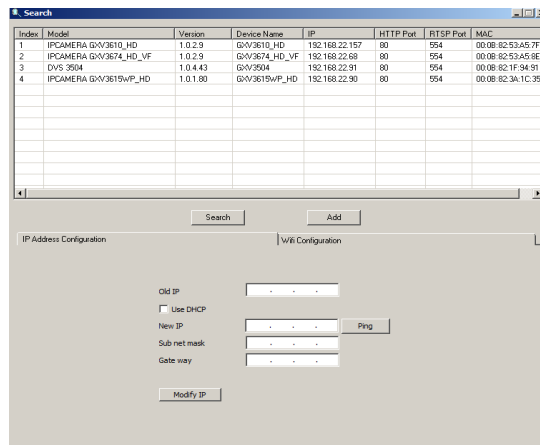

Działanie 5: Wybierz poszukiwaną kamerę, uruchomienie jej otworzy okno z interfejsem GUI kamery w domyślnej przeglądarce.

Działanie 6: Pojawi się okienko z logowaniem, domyślnym Loginem i hasłem jest "admin", podobnie jak po resecie do ustawień fabrycznych.

Działanie 7: Po zalogowaniu przeglądarka zgłosi brak wtyczki do obsługi wideo, aby ją zainstalować należy wykonać instalację wtyczki.

Działanie 8: Jeżeli z jakichś powodów ściągnięcie bądź instalacja wtyczki zakończyła się niepowodzeniem prosimy o pobranie wtyczki z linku poniżej. Po pobraniu i zainstalowaniu należy zrestartować przeglądarkę. Po tych działaniach obraz z kamery powinien się pokazać.

• WTYCZKA:

http://www.grandstream.com/products/tools/surveillance/webctrl_plugin.zip

Działanie 9: Poniżej przykładowe zrzuty ekranu z zainstalowaną wtyczką wideo. Wybranie "Play" pokaże obraz z kamery.



Działanie 10: Bardziej zaawansowane ustawienia są dostępne po lewej stronie ekranu przeglądarki.

Podłączenie kamery GXV3674_HD/FHD_VF przy użyciu statycznego adresu IP

Jeżeli kamera nie otrzyma adresu z serwera DHCP lub takiego nie ma w sieci to po 3 minutach przyjmie Statyczny adres IP 192.168.1.168.

Działanie 1: Podłącz kamerę do sieci za pomocą kabla RJ45.

Działanie 2: Uruchom program GS_Search tool jak powyżej, kamera pokaże się ze statycznym adresem (domyślnie 192.168.1.168).

Działanie 3: Wprowadź NOWY adres IP, maskę podsieci (Subnet Mask) oraz bramę wyjściową (Default Gateway) zgodnie z twoją siecią komputerową. W razie jej nieznanowości trzeba się skontaktować z lokalnym administratorem sieci komputerowej.

Działanie 4: Naciśnij "Modify IP", zapisze i wyśle to nowe ustawienia dla kamery.

Więcej informacji w instrukcji użytkownika, dokumentach na stronach lub FAQ:

<http://www.grandstream.com/index.php/products/ip-video-surveillance/gxv3674>

<http://www.grandstream.com/support>

<http://www.grandstream.com/support/tools>

SPECYFIKACJA GXV3674_HD/FHD_VF v2

Sensor obrazu Czułość	Tryb dnia i nocy Migawka: 1/10000 - 1/30 sekund
Zmienna ogniskowa	2.8 ~ 12 mm
Aperture	F1.4, DC-IRIS
Kąt widzenia (FOV)	90° ~ 28° (poziomo)
Filtr IR	Tak. Mechaniczny
Tryb Dnia i Nocy	Tryb koloru & B/W Doświetlenie do 25 metrów
Minimalne oświetlenie	0.05 Lux 0 lux z IR LED
Reakcja	HD: 5.48V/lux-sec (550nm) FHD: 1.9 V/lux-sec (550nm)
Maksymalna rozdzielczość i ilość klatek	HD: 1280 x 960 (25fps) FHD: 2048 x 1536 (15fps)
Zasięg przesuwania	0° - 180° (ręczny)
Zasięg pochylenia	0° - 180° (ręczny)

Compliance

FCC Notice

This device complies with part 15 of the FCC Rules. Operation is subject to the following two conditions: (1) This device may not cause harmful interference, and (2) this device must accept any interference received, including interference that may cause undesired operation.

This equipment has been tested and found to comply with the limits for a Class B digital device, pursuant to part 15 of the FCC Rules. These limits are designed to provide reasonable protection against harmful interference in a residential installation. This equipment generates, uses and can radiate radio frequency energy and, if not installed and used in accordance with the instructions, may cause harmful interference to radio communications. However, there is no guarantee that interference will not occur in a particular installation. If this equipment does cause harmful interference to radio or television reception, which can be determined by turning the equipment off and on, the user is encouraged to try to correct the interference by one or more of the following measures:

- Reorient or relocate the receiving antenna.
- Increase the separation between the equipment and receiver.
- Connect the equipment into an outlet on a circuit different from that to which the receiver is connected.
- Consult the dealer or an experienced radio/TV technician for help.

Any changes or modifications not expressly approved by the party responsible for compliance could void the user's authority to operate the equipment.