

COMPUTER-SYSTEM



MC-20

HoTT

Programming Manual

Table of contents

General notices

| | |
|---|----|
| Table of contents | 2 |
| Environmental protection notices | 3 |
| Safety notices | 4 |
| Safety notices and handling regulations for Lithium-Ion (LiIo) and Lithium-Polymer (LiPo) batteries | 7 |
| Foreword..... | 10 |
| Remote control set description..... | 11 |
| Technical data..... | 14 |
| General operating notices | |
| Transmitter..... | 16 |
| Opening the transmitter housing | 16 |
| Transmitter power supply..... | 16 |
| Recommended chargers..... | 17 |
| Battery operation timer in display | 18 |
| Lithium battery, CR 2032..... | 18 |
| Joystick length adjustment | 18 |
| Joystick conversions..... | 19 |
| Holder bracket for transmitter straps | 20 |
| Installing additional controls, switches, etc..... | 20 |
| Aligning the antenna..... | 20 |
| Transmitter description | |
| Front side..... | 21 |
| Face-side connectors | |
| Charger socket..... | 22 |
| DSC (Direct Servo Control)..... | 22 |
| mini-USB connector | 23 |
| Data socket | 23 |
| Card slot (data storage) | 23 |
| Headset connector | 24 |
| ext. PPM..... | 25 |
| SPI | 25 |
| Inside the transmitter..... | 26 |
| Display and key pads | 28 |
| Operating the "data terminal" | 29 |
| Shortcuts..... | 30 |
| Warnings in the display | 30 |
| Function fields in the display | 31 |

| | |
|--|----|
| Code lock | 31 |
| Secret mode | 32 |
| Display contrast..... | 32 |
| Language selection | |
| Voice update..... | 32 |
| Change of display language..... | 33 |
| Firmware update via SD card..... | 36 |
| Joystick calibration | 36 |
| Telemetry data display..... | 36 |
| Commissioning the transmitter | 42 |
| Firmware update via PC..... | 43 |
| Commissioning the receiver | 46 |
| Receiver system power supply..... | 47 |
| General charging notices | 49 |
| Firmware update | 50 |
| Installation notices | 52 |
| Term definitions | 54 |
| Assigning transmitter controls, switches and control switches | 56 |
| Digital trim | 58 |
| Winged models..... | 60 |
| Receiver layout..... | 61 |
| Helicopter models..... | 64 |
| Receiver layout..... | 65 |
| Program descriptions | |
| Loading a new memory location..... | 66 |
| »Model select« | 69 |
| »Copy / Erase« | 70 |
| Erase model | 70 |
| Copy model → Model..... | 70 |
| Export to SD card..... | 71 |
| Import from SD card..... | 72 |
| Copy flight phase..... | 72 |
| Changes | 73 |
| »Suppress codes« | 74 |
| »Suppress models«..... | 75 |
| »Basic settings, model« | |
| Winged model | 76 |
| Binding receivers..... | 77 |

| | |
|---|-----|
| Range test..... | 80 |
| Helicopter model | 84 |
| Binding receivers..... | 85 |
| Range test..... | 88 |
| »Model type«..... | 94 |
| »Helicopter type«..... | 98 |
| »Servo adjustment« | 102 |
| »Stick mode« | |
| Winged model | 104 |
| Helicopter model | 106 |
| »Control adjust« | |
| Winged model | 108 |
| Helicopter model | 112 |
| Throttle limit function | 117 |
| Idle setting..... | 117 |
| Throttle limit in combination with AR in the »Stick mode menu« | 119 |
| »Dual Rate / Expo« | |
| Winged model | 120 |
| Helicopter model | 124 |
| »Channel 1 curve« | |
| Winged model | 128 |
| Helicopter model | 131 |
| »Switch display«..... | 134 |
| »Control switch«..... | 135 |
| »Logical switches«..... | 138 |
| How do I program a flight phase?..... | 140 |
| »Phase settings« | |
| Winged model | 142 |
| Helicopter model | 146 |
| »Phase assignment« | 148 |
| »Phase trim« (winged model)..... | 150 |
| »Non-delayed channels«..... | 151 |
| »Timers (general)«..... | 152 |
| »Flight phase timers«..... | 156 |
| What is a mixer..... | 159 |
| »Wing mixers« | 160 |
| 1 aileron..... | 163 |
| 1 aileron and 1 camber flap..... | 164 |
| 2 ailerons..... | 166 |

| | |
|--|-----|
| 2/4 ailerons and 1/2/4 camber flaps | 168 |
| » Helicopter mixer « | 176 |
| Adjusting the throttle and pitch curve | 187 |
| Autorotation setting..... | 190 |
| General remarks about freely progr. mixers | 192 |
| » Free mixers « | 193 |
| Linear mixers..... | 197 |
| Exponential mixers | 199 |
| Examples..... | 201 |
| » MIX active/phase «..... | 204 |
| » Mix only Channel « | 205 |
| » Dual mixer « | 206 |
| » Swashplate mixer « | 208 |
| » Fail Safe « | 208 |
| » Teacher/pupil « | 210 |
| Connection schematic | 213 |
| Wireless HoTT system | 214 |
| » Transmitter output «..... | 218 |
| » Profi-trim « | |
| Winged model | 220 |
| Helicopter model | 222 |
| » Trim memory « | |
| Winged model | 224 |
| Helicopter model | 226 |
| » Telemetry «..... | 228 |
| Setting & dataview..... | 229 |
| Satellite mode of two receivers | 238 |
| Sensor/s | 239 |
| Selecting sensor/s | 240 |
| RF status view | 241 |
| Select voice update | 242 |
| » Channel sequence «..... | 244 |
| » Multichannel «..... | 246 |
| » Ring Limiter «..... | 250 |
| » MP3-Player « | 254 |
| » General basic settings « | 256 |
| » Servo display « | 262 |
| » Servo test « | 263 |
| » Code lock « | 264 |
| » Info display «..... | 266 |

Programming examples

| | |
|--|-----|
| Introduction..... | 268 |
| Winged model | |
| First steps..... | 270 |
| Incorporating an electric drive | 276 |
| C1 joystick switchover between | |
| Electric motor and butterfly..... | 279 |
| Electric motor and airbrake | 282 |
| Timer activation by control or switch..... | 284 |
| Parallel operating servos | 286 |
| Using flight phases | |
| Example 1 | 288 |
| Example 2 | 292 |
| 8-flap wings | 298 |
| Delta and flying wing models..... | 301 |
| F3A model | 304 |
| Helicopter model..... | 308 |

Appendix

| | |
|-----------------------------|-----|
| FCC declaration..... | 318 |
| Conformity declaration..... | 319 |
| Guarantee certificate | 320 |

Environmental protection notices

The symbol on this product, its operating instructions or packaging gives notice that this product may not be discarded as common household waste at the end of its service life. It must be turned over to a recycling collection point for electric and electronic apparatus.

The materials can be recycled according to their markings. You make an important contribution to protection of the environment by utilizing facilities for reuse, material recycling or other means of exploiting obsolete equipment.



Batteries must be removed from the unit and disposed of separately at an appropriate collection point.

Please inquire with local authorities about the responsible waste collection locations.

This manual serves only as a source of information and can be changed without prior notification. Graupner accepts no responsibility or liability for errors or inaccuracies which may be contained in the information section of this manual.

Safety notices

Be sure to pay attention!

In order to enjoy your modeling hobby for a long time, please read these instructions thoroughly and give particular attention to the safety notices. You should also register right away at <https://www.graupner.de/de/service/produktregistrierung.aspx> since this is the only way for you to automatically receive current information about your product via email.

If you are a beginner with remote controlled model aircraft, ships or cars, you should really ask an experienced model pilot for assistance.

If this remote control system changes ownership, these instructions should surely be included with remote control system.

Intended usage

This remote control system may only be used for the purpose intended by the manufacturer, i.e. for the operation of *unmanned remote controlled models*. Any other usage is not permissible.

Safety notices

SAFETY IS NO ACCIDENT
and

REMOTE CONTROLLED MODELS ARE NOT TOYS
... because even small models can cause substantial property damage and/or personal injuries if they are not handled properly - even if caused by third parties.

Technical defects of an electrical or mechanical nature can lead to unexpected startup of a motor and/or parts being hurled through the air to pose a danger of injury to you and to others.

Short circuit conditions are to be avoided absolutely! A short circuit condition may not only destroy parts of the remote control system but, depending on the circumstances and the battery energy involved, may also pose acute danger of incineration or even explosion.

All motor-driven parts, such as aircraft or ship propellers, helicopter rotors, open gearboxes etc.

represent a constant danger. Contact with these parts must be avoided. A rapidly turning aircraft propeller can, for example, sever a finger. Also pay attention that other objects do not come into contact with driven parts.

When a drive battery is connected or a motor is running: **never** get into the danger zone of driving mechanisms.

Be sure to pay attention that motors do not start up unintentionally while performing programming operations. Disconnect the fuel supply or battery terminals to motors before programming.

Protect all units from dust, dirt, moisture and other foreign parts. Never expose these units to vibrations or excessive hot or cold temperatures. Remote control operation may only be performed under "normal" outdoor temperatures, i.e. within a range of -15 °C to +55 °C.

Avoid mechanical jarring and pressure stresses. Always check units for damage to housings and cables. Do not use units which have been damaged or become wet, even after they are dry again.

Only those components and accessories which we recommend may be used. Always use original *Graupner* plug and jack connectors which are made for one another out of the same materials.

When routing cables, pay attention that they are not stressed, unduly kinked or broken. The sharp edges of adjacent parts also represent a hazard for insulated conductors.

Be sure that all plug and jack connections are firmly seated. Do not pull on the cable to disconnect a plugged connector.

No modifications whatsoever may be made to units. Modifications will void the operating permit and all insurance protection.

Installing the receiver

The receiver is to be installed with a cushion of foam

rubber to afford protection against jarring; in aircraft models behind a strong rib, for a car or ship model the location must be protected against dust and spray water.

The receiver may not be mounted in direct contact with the hull or chassis as this would allow motor vibrations and/or roadway jarring to be transferred directly to the receiver. When a receiver system is installed in a model with a combustion motor, all receiver parts should always be protected against the intrusion of exhaust gases and oil residue. Above all, this applies to the model's ON/OFF switch, which is typically built into the model's outer surface.

Position the receiver such that connecting cables to the servos and the power supply are routed with a bit of slack and that the receiver's antenna is at least 5 cm away from any large metal parts or wiring except for other receiver wires/cables. In addition to steel, this also includes carbon fiber parts, servos, electric motors, fuel pumps and all sorts of cables, etc.

Optimally the receiver should be placed at a readily accessible location that is well away from all other equipment. Under no circumstances may a servo cable be wrapped around the antenna or routed close to it.

Make sure that cables near the antenna cannot move about during flight.

Routing the receiver's antenna

The receiver and its antennas must be positioned as far away as possible from drives of any kind. If the model's hull is made of carbon fiber material, the ends of the antennas must extend outside of the hull.

The orientation of antennas is not critical. Nevertheless, a vertical (upright) installation of receiver antennas is advantageous. In the case of diversity antennas (two antennas), the second antenna should be oriented at a 90° angle to the first antenna.

Servo installation

Always mount servos with the provided rubber vibration-damper parts. Only in this manner can these parts be protected against excessively hard vibrations.

Installing control rods

Control rods must be installed such that they operate freely and smoothly. It is particularly important that all rudder levers are able to move to their full limits, i.e. not otherwise mechanically blocked.

In order to be able to stop a running motor at any time, control rods must be adjusted such that the carburetor tap is completely closed when the joystick and trim wheel are brought into their end idle position. Pay attention that no metal parts, e.g. as a result of rudder actuation, vibration, rotating parts, etc., rub against one another. Metal-to-metal contact causes electrical "noise" which can interfere with the correct operation of the receiver.

Transmitter antenna orientation

Transmission field strength is minimal in an imaginary line extending straight out from the end of the transmitter's antenna. This means that "pointing" the transmitter's antenna directly toward the model will not produce good reception but rather degrade reception.

When multiple remote controls are operating simultaneously, pilots should position themselves in a loose group. Pilots standing off to themselves not only endanger their own models but those of others as well.

However, when 2 or more pilots using 2.4 GHz remote control systems are closer than 5 m to one another this can lead to return channel overdrive which, in turn, will trigger a range warning much too early. Increase your distance between one another until the range warning ceases.

Pre-start checks

Before switching the receiver on, be sure the throttle control is at its Stop/Idle position.

Always switch the transmitter on first and then the receiver.

Always switch the receiver off first and then the transmitter.

If this sequence is not maintained, such that the receiver is still switched on when the corresponding transmitter is switched to "OFF", then the receiver may respond to other transmitters or general radio frequency noise. This can cause the model to execute uncontrolled operations that may cause personal injuries and/or property damage.

In particular, for models *equipped with a mechanical gyro*:

before switching off the receiver, disconnect the model's power supply to prevent the motor from revving up unintentionally.

The residual spin of a gyro often produces so much voltage that the receiver may falsely interpret a throttle signal! This will then cause the motor to start up unexpectedly.

Range test

Perform checks for proper operation and range before every *session*. Secure the model adequately in place and ensure that no one is in front of the model.

Perform a complete functional test on the ground and execute a complete simulated flight to exclude the possibility of system faults or problems with the model's programming. When doing this, be sure to follow the notices provided on pages 80 and 88. Never operate the transmitter in Model mode, i.e. for flying or driving, without an antenna. Be sure the antenna is firmly seated in its socket.

Operating a winged aircraft, helicopter, ship or car

Never fly over spectators or other pilots. Never endanger humans or animals. Never fly in the vicinity of high-voltage wires. Do not operate the model in the vicinity of sluice locks or where real boats or ships are operating. Do not operate a model on public streets or highways, paths or plazas, etc.

Monitoring transmitter and receiver batteries

You must stop running the model to recharge the transmitter's battery no later than when low transmitter battery voltage triggers the "**Batt must be recharged!!**" display and acoustic signal.

Check the charge in batteries routinely, particularly the receiver's battery. Do not wait until the movements of controlled mechanisms are noticeably slower. Replace expended batteries before they cause problems.

The battery manufacturer's charging instructions are always to be followed, this includes mandatory adherence to the length of charging time. Never leave batteries being charged unattended.

Never attempt to charge primary batteries (non-rechargeable batteries) because they can explode.

All secondary batteries (rechargeable batteries) must be charged before every session. To avoid short circuit conditions, first connect the charger cable's banana plugs, polarity correct, into the charger and thereafter connect the charger cable's plugs to the transmitter and receiver batteries.

Disconnect all power sources from the model when it is not to be used for an extended period of time.

Never attempt to use defective batteries, damaged batteries or mixed-type battery combinations as a single group. Do not use mixed combinations of old and new batteries or batteries of different manufacture.

Safety notices

Capacity and operating time

The rule: "capacity is reduced with every successive recharging", applies to all batteries. Internal resistance increases at low temperatures to further reduce capacity. As a consequence, the battery's ability to provide current and hold its voltage is reduced.

Frequent charging or the use of battery maintenance programs can also result in gradual loss of battery capacity. Therefore the capacity of batteries should be checked at regular intervals, not in excess of every six months, and replaced if performance is found to be significantly deficient.

Purchase only genuine *Graupner* batteries!

Interference suppression for electric motors

All conventional electric motors produce sparks between their collector and brushes. Depending on the type of motor involved, this may cause more or less interference with the functionality of the remote control system.

The electric motors of a properly built system should therefore have interference suppression features. For electric drive models it is particularly important that every one of its motors is provided with proper interference suppression. Interference filters extensively suppress such disturbances and should always be included.

Follow the respective recommendations included in the motor's operating and installation notices.

For further details about interference filters, refer to the *Graupner* RC main catalog or in Internet at www.graupner.de.

Servo interference filters for extension cables

Order no. **1040**

The servo interference filter is necessary when an extended-length servo cable is used. This filter is attached directly to the receiver output. In critical cases a second filter can be attached to the servo.

Using electronic speed controllers

Choosing the right electronic controller is largely a matter of matching controller performance to the motor to be controlled.

In order to prevent an overload or damage to the speed controller, its current rating should be at least

half of the maximum locked-rotor current draw of the motor to which it is connected.

Particular attention is appropriate for so-called "tuning motors". Because of their low-turns coils these motors can draw a multiple of their rated current in a locked-rotor condition and this can lead to the destruction of the speed controller.

Electric ignition systems

Combustion motor ignition systems also produce interference that can negatively influence remote control functionality.

Always supply power to an electric ignition system from a separate, dedicated battery.

Use only interference-suppressed spark plugs, spark caps and shielded ignition leads.

Mount the receiver sufficiently far away from ignition system components.

Static charges

A remote control system will be destroyed by the magnetic shock waves produced by a lightning strike - even if the storm is miles away. Therefore ...

... stop flying right away if a storm is approaching. Static charging via the antenna also represents a lethal hazard.

Attention

- In order to fulfill FCC HF emission requirements for mobile transmitters, a distance of at least 20 cm must be maintained between this system's antenna and other persons when this system is operating. Operation of this system at a lesser distance is therefore not recommended.
- To avoid disturbance caused by the electrical characteristics and emissions of other transmitters, keep at least a 20 cm distance from other transmitters.
- Operation of the remote control system requires a correct program setting for the given country in the

Safety notices and handling regulations for Lithium-Ion (Lilo) and Lithium-Polymer (LiPo) batteries

transmitter unit. This is necessary for compliance with diverse regulations like FCC, ETSI, CE etc. Follow the respective instructions provided for this with the transmitter and receiver.

- Prior to every flight, perform a complete functional test, range test and execute a complete simulated flight in order to exclude the possibility of system faults or problems with the model's programming.
- Never program the transmitter or receiver while the model is being operated.

Care and maintenance

Never clean the housing, antenna, etc. with cleaning agents, gasoline, water or similar means. Use only a dry, soft cloth.

Components and accessories

As manufacturer of this equipment *Graupner* GmbH & Co. KG recommends only components and accessories which have been tested and approved by *Graupner* for their suitability, functionality and safety. If this recommendation is followed, *Graupner* accepts responsibility for the product.

***Graupner* cannot accept any responsibility for the parts or accessories of other manufacturers which have not been approved and *Graupner* cannot evaluate every individual product made by other companies to assess if they are safe to use.**

Liability exclusion / damage compensation

This manual serves only as a source of information and can be changed without prior notification.

Graupner accepts no responsibility or liability for errors or inaccuracies which may be contained in this manual.

Graupner cannot monitor compliance with the assembly instructions, the operating instructions or the conditions and methods under which remote control components are installed, operated, utilized or maintained. Therefore *Graupner* accepts no form

of liability for loss, damage or costs consequential to incorrect usage or operation or which can be attributed to same.

Unless otherwise prescribed by law, the obligation of *Graupner* to provide damage compensation, regardless of legal grounds, is limited to the invoice value of the quantity of *Graupner* goods contributing directly to the damage-inducing event. This does not apply if *Graupner* is found to be subject to unlimited liability pursuant to binding legal stipulations with respect to intent or gross negligence. As applicable for all highly technical products, observance of the following safety notices and handling instructions is essential for a long service life, fault-free operation, and harmless utilization of lithium/polymer batteries. These instructions are to be safeguarded. If the unit is transferred to another user, these instructions should certainly be passed along to the new user.

General notices

- Lilo-/LiPo batteries require particularly attentive handling. This applies to charging, discharging as well as for storage and other handling. Adherence to the following special specifications is necessary:
- Incorrect handling can lead to explosions, fire, smoke and poisoning hazards. Furthermore, disregard for instructions and warnings can lead to performance losses and other defects.
- The battery's capacity is reduced by every charge/discharge cycle. Storing the battery at temperatures which are too high or too low can also lead to a gradual reduction in capacity. In model operation, battery capacity drops to about 50 ... 80% of new battery capacity after about 50 charge/discharge cycles – even though all charge/discharge rules are followed. This is due in part to the high discharge currents and inductive currents caused by motors.
- Battery packs may only be connected in series or parallel in exceptional cases as cell capacities and

charged state can differ too greatly. This is why the battery packs we deliver are selected.

Special notices for charging Lilo-/LiPo batteries from *Graupner*

- Since *Graupner* GmbH & Co. KG cannot supervise the correct charging and discharging of cells, the entire guarantee is void in cases of improper charging or discharging.
- Never leave batteries being charged unattended.
- Only approved chargers with appropriate charging cables may be used for charging Lilo-/LiPo batteries. Any manipulation to the charger or charger cables can lead to severe damage.
- The maximum charging capacity must be limited to 1.05 times the battery's capacity.
Example: 700 mAh battery = 735 mAh max. charging capacity
- Use only the outlet-charger included with the set or a specially designed charger/discharger from *Graupner* to charge and discharge Lilo-/LiPo batteries, refer to page 17 or www.graupner.de.
- Ensure the settings for the number of cells or for final charging voltage and final discharge voltage are correct. Be sure to observe the operating instructions for your charger/discharger.

Other handling notices

- The battery to be charged must be placed on a non-combustible, heat resistant, non-conducting surface during the charging process. Combustible or readily ignited objects are to be kept away from the charging configuration. Batteries may only be charged under supervision.
- Lilo-/LiPo batteries connected in series within a pack may only be charged as a group if the voltage of individual cells do not differ by more than 0.05 V. The Lilo battery included with the set, order no. **33000.1** (changes reserved), is equipped with a special safety circuit such that

"compensation" for voltage differences between individual cells, by way of an otherwise typical balancer plug connection, is not necessary.

- Under these conditions *Graupner* Lilo-/LiPo batteries can be charged with a maximum of 2C (the value 1C corresponds to the cell capacity) charging current. At a voltage of maximum 4.2 V per cell and above, charging must continue a constant voltage of 4.2 V per cell until charging current drops below 0.1 ... 0.2 A.
- Charging voltage over 4.20 V per cell must be avoided absolutely as the cell would otherwise be permanently damaged and could cause a fire. In order to prevent the over-charging of individual cells in a pack, a cut-off voltage between 4.1 V ... 4.15 V per cell should be set to increase service life.
- Never attempt to charge battery cells with the wrong polarity. Abnormal chemical reactions take place when batteries are charged with reversed polarity and the battery will be useless. This can cause breaks, smoke and flames.
- The permissible temperature range for charging and storing Lilo-/LiPo batteries is 0 ... +50 °C.
- Storage: Lilo-/LiPo cells should have a 10 ... 20% charge capacity when stored. If cell voltage drops below 3 V, then Lilo-/LiPo cells must absolutely be recharged to a capacity of 10 ... 20% of full capacity. Otherwise, further deep-discharging of the battery will make it useless during storage in a discharged state.

Special notices for discharging Lilo-/LiPo batteries from *Graupner*

- A continuous current rate of about 1C does not represent a major problem for *Graupner* Lilo-/LiPo batteries. For larger currents, please follow the catalog specifications. In any case, observe the maximum current rating for the connector system, see maximum discharge current on the battery.

- Discharging below 2.5 V per cell damages cells permanently and is therefore to be avoided absolutely. The **MC-20** HoTT transmitter switches itself off when its power supply voltage reaches its lower limit of 3.3 V. Short circuit conditions are to be avoided absolutely. Permanent short circuits lead to destruction of the battery, high temperatures and perhaps even self-ignition may follow.
- During discharge, battery temperature must not rise, in any case, to over +70 °C. Otherwise, better cooling or a lower rate of discharge must be introduced. The temperature can easily be checked with the infrared thermometer, order no. **1963**. The battery must never be discharged via the transmitter's charging socket. This socket is not suitable for this purpose.

Other handling notices

- Never short-circuit the battery. A short-circuit allows very high current to flow and this heats up the cells. This will lead to loss of electrolyte, the production of gases and perhaps even explosions. In the vicinity of, or while handling, *Graupner* Lilo-/LiPo batteries, avoid electrically conducting surfaces because of the danger of creating a short-circuit condition.
- Handling connectors:
These connectors are not as robust as for other batteries. This applies particularly to the plus pole connector. The connections can easily be broken off. Due to thermal transfer, the connector tabs may not be soldered directly.
- Cell connection:
Direct soldering on battery cells is not permitted. The heat of direct soldering can damage battery components, such as separator or isolator. Battery connections should only be made by industrial spot welding. A professional repair made by the manufacturer or distributor is necessary to

replace missing or torn-off cables.

- Replacing individual battery cells:
The replacement of battery cells may only be made by the manufacturer or distributor and never by the user himself.
- Damaged cell usage:
Damaged cells may never be used or returned to service.
- Characteristics of damaged cells include:
damaged housing packing, deformed battery cells, electrolyte or leaking electrolyte. In these cases, further use of the battery is not permissible.
- Damaged or useless cells are hazardous waste items and must be appropriately disposed.

General warning notices

- Batteries must never be put in fire or burned.
- Battery cells must not be submerged in liquids, such as water, seawater or beverages. Any contact with liquids, of whatever nature, is to be avoided.
- Individual battery cells and batteries are not toys and must therefore not get into the hands of children. Batteries/cells must be kept out of the reach of children.
- Batteries must not get into the vicinity of babies or small children. If a battery is swallowed, immediately go to a doctor or emergency medical facility.
- Batteries must not be put in a microwave oven or put under pressure. Smoke, fire and more can be the consequences.
- Never dismantle a Lilo-/LiPo battery. Dismantling a battery can cause internal short-circuits. Gas, fire, explosions and other problems can result.
- The electrolyte and electrolytic vapors in Lilo-/LiPo batteries are harmful. Absolutely avoid all direct contact with electrolytes. If electrolytes come into contact with skin, eyes or other body parts, immediately wash out or rinse out with generous amounts of fresh water then be sure to consult

a doctor.

- Batteries built into equipment must always be removed from that equipment when it is not currently in use. Always switch off equipment after it is used to prevent deep discharging. Always charge batteries before it is too late. Store batteries on a non-combustible, heat resistant, non-conducting surface! Deep-discharged Lilo-/LiPo batteries are defective and may no longer be used!

Notice for remote control set MC-20 HoTT

Order no. **32032**

This remote control set is factory equipped with a Lilo transmitter battery (changes reserved). Once the factory preset voltage limit of 3.60 V has been reached, a warning will appear in the display.

Disposal of used batteries:

Some countries have laws requiring that all used batteries be turned over to an authorized collection center.

Disposing of batteries along with common household garbage is forbidden. Old batteries can be turned into communal collection centers for disposal at no charge or they can be returned to one of our dealerships or anywhere else where batteries of that given type are sold. Used batteries we have delivered can also be sent back to us, at your cost, through the mail. Use the return address below:

Graupner GmbH & Co. KG

Service: Used batteries

Henriettenstr. 94-96

D-73230 Kirchheim unter Teck

This represents an essential contribution to environmental protection.

Caution:

Damaged batteries require among other things, special packaging, because they are very toxic!

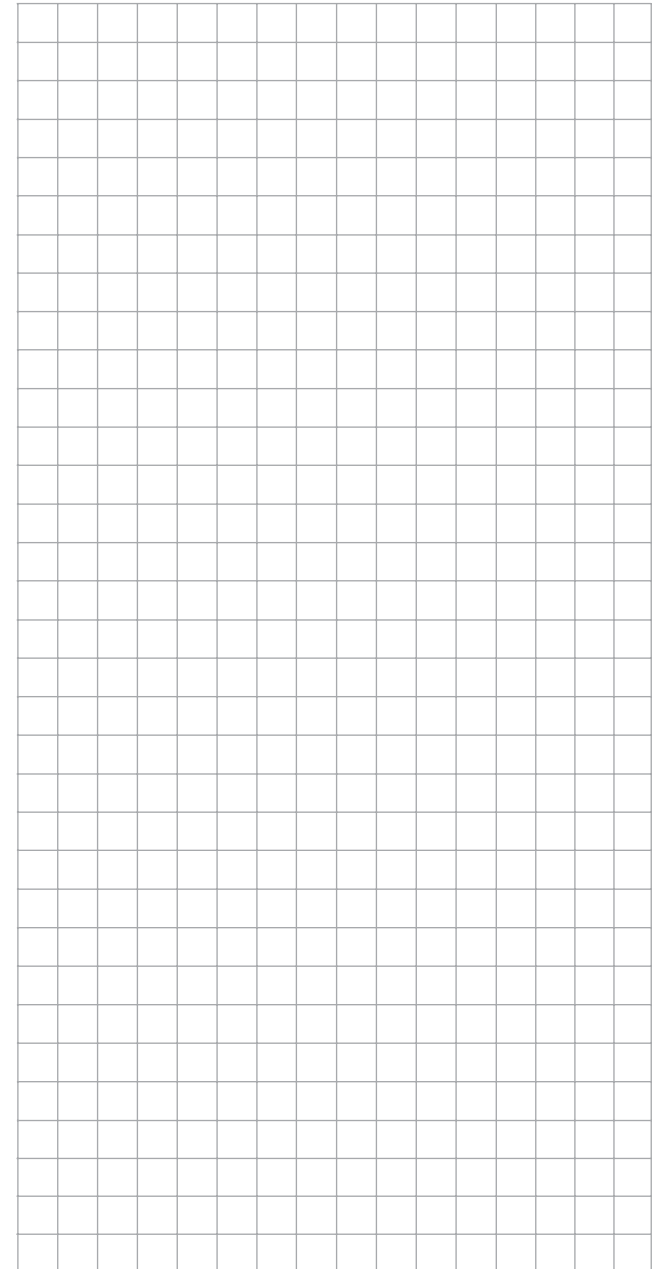

MC-20 HoTT the Newest Generation of Remote Control Technology

The technical advances across the entire spectrum of model building is an ever-present challenge to design engineers. This is why the introduction of new transmission technology in the 2.4 GHz band represents a new milestone.

The HoTT-System (**Hopping Telemetry Transmission**) developed by *Graupner* is a synthesis of know-how, engineering and testing done around the world by professional pilots.

Established *Graupner* HoTT techniques theoretically permit over 200 models to be operated at the same time. However, because of the interspersed radio-frequency utilization permitted by certification for the 2.4 GHz ISM band, this number is significantly lower in practical application. Nevertheless, in general more models can be operated simultaneously in the 2.4 GHz band than would be the case in conventional 35 or 40 MHz frequency bands. The real limiting factor is—as often before—is still likely to be the size of available operating space (i.e. airspace for aircraft). Alone the fact that it is no longer necessary to coordinate transmitting frequencies with other pilots in the vicinity (which is sometimes quite difficult in broken landscapes, such as on hillside slopes) represents an enormous boost for remote control operating security.

Bidirectional communication between transmitter and receiver, by way of a return channel built into the receiver, permits convenient access to data and programming in the HoTT receiver. For example, this makes it possible to swap receiver outputs or to divide up control functions among multiple servos (channel mapping). Servo travel and servo rotation directions in the receiver can also be matched to one another with these facilities. Telemetry data, like VARIO and GPS data, can be called up from optionally available modules.

Based on the **mc-24** *Graupner/JR* computerized remote control system, the **MC-20** HoTT remote

control system has been especially developed for experienced RC pilots. All conventional model types can be readily operated with the **MC-20** HoTT system, regardless of whether the model is a winged aircraft, helicopter, ship or land vehicle.

Complex mixed-control functions of guiding surfaces are often necessary for winged aircraft (rudder, elevators) and helicopter models (swashplate). Thanks to modern computer technology, very diverse model requirements can be programmed in the simplest conceivable manner with touch-sensitive keys (CAP Touch). Simply select the given model type from the **MC-20** HoTT program and its software will assemble all significant mixer functions and coupling functions automatically. This eliminates the need for separate modules in the transmitter to implement complex coupled functions and also makes sophisticated mechanical mixer mechanisms in the model unnecessary. For example, this makes the **MC-20** HoTT transmitter fully equipped with both software and hardware to operate the well-known NAUTIC modules on the receiver side. The "channel sequencer" is new. It permits the operation of up to three servos to be automated.

The **MC-20** HoTT system offers optimal security and reliability without having to forgo great operating convenience. The **MC-20** HoTT remote control system has 80 model memory locations. Additional flight-phase-specific settings can be stored in every model memory location. For example, such settings can be made for various parameters that can be called up to implement particular flight maneuvers at the "press of a button". Additional model memories can be stored on the SD card, which is included standard with the set. Even telemetry data can be recorded for subsequent evaluation on a PC.

Since the **MC-20** HoTT is equipped with two displays, the lower display has been optimized for comprehensible, simple operation of the software.

The graphic representation of mixer functions is particularly helpful. The upper display allows telemetry data to be called up from the receiver. Functionally-related options are clearly arranged by content in a simple organization. The clear, comprehensible program structure permits a beginner to quickly become familiar with the various functions and able to use all options pertinent to his level of expertise with remote control models.

This handbook describes every menu in detail. There are tips, many notices and programming examples to supplement the descriptions and also explanations for model specific technical terms, like transmitter control, dual rate, butterfly, and so on.

Please observe the safety notices and technical notices. Read through the instructions attentively. Before usage, test all functions by simply attaching servos to the receiver included in the set. While doing this, observe respective notes on page 68. This will help you learn the essential operating techniques and functions of the **MC-20** HoTT.

Always handle your remote controlled model with a sense of responsibility so that you do not endanger yourself or others.

The *Graupner* team wishes you much pleasure and success with your **MC-20** HoTT, the newest generation of remote control systems.

Kirchheim-Teck, December 2011

Computer System MC-20 HoTT

32 channel remote control set in 2.4 GHz-*Graupner*-HoTT technology
(Hopping Telemetry Transmission)



Technology that enthralls

The superior functional security of Graupner HoTT technology accomplished with bidirectional communications between transmitter and receiver with integrated telemetry, freely programmable voice output via headset connector, and ultra-fast response times.

Programming is simplified by a programming technique implemented with capacitive touch buttons.

High contrast, 8 line, graphic display for perfect presentation of all parameter settings. Switch on/off of blue back-lighting at will. A second, independent display for presentation of telemetry data. Storage of telemetry data on a micro SD memory card.

4096 steps of 12-bit resolution on the channel signal assures extreme control sensitivity. USB connection to read and write the model's memories as well as for making firmware updates

- Integrated *Graupner* HoTT 2.4 GHz transmission system
- Maximum interference immunity made possible by optimized frequency hopping through as many as 75 channels and wider channel spread
- Intelligent data transfer with correction function
- Over 200 systems can be used simultaneously
- The HoTT technique of bidirectional communication between sender and receiver, as well as the fastest possible transmission rate (10 ms) assures extremely short reaction times.
- 5 different languages (German, English, French, Italian and Spanish) available per software update. For the availability of a given language, refer to the download area.
- 80 model memories with storage for all model-specific programs and parameter settings
- Seven switches (two 3-way switches, three 2-way switches and two 2 pushbutton switches) as well as three digital actuators are already built-in and can be used as desired
- A function encoder with two touch-sensitive, four-way keys ("CAP Touch") permit simplified programming and precise settings
- Key-lock function to prevent unintentional operation.
- Voice and, as applicable also MP3 file, output over headset output or loudspeaker
- Simple, very fast model-independent binding
- Extremely fast rebinding, even at maximum distance
- Range: test and warning function
- Under-voltage warning
- Extremely wide receiver operating voltage range of 3.6 V to 8.4 V (functional to 2.5 V)
- Fail-safe, free channel assignment (channel mapping), mixer functions and all servo settings are simple to program

Computer System **MC-20** ~~HO~~ **HoTT**

32 channel remote control set in 2.4 GHz *Graupner*-HoTT technology (Hopping Telemetry Transmission)

- Binding of any number of receivers to the channel expansion (32 channels maximum)
- As many as four servos can be controlled simultaneously as a block in the SAME operating mode with a servo cycle time of 10 ms (digital servos only).
- Thanks to cycle time reduced down to as little as 10 ms, extremely short response times are achieved.
- Real-time telemetry evaluation in the transmitter display Additionally, telemetry data can also be selectively displayed by the SMART-BOX.

Additional HoTT features of the **MC-20**

- Super-fast response time through use of a fast main processor for data transmission.
- Micro-SD card for storage of telemetry data and for additional functions
- Obsolescence-proof through update capability over USB interface as well as via the micro-SD card
- The included Lilo battery (changes reserved) has a capacity of over 6000 mAh. This makes extremely long flight times possible and also reduces the number of charging repetitions.
- Modulation changeover per software: e.g. from "EXT. PPM" (e.g. Weatronic) to HoTT at the press of a button.
- Swashplate limiting: This function limits the swashplate's tilt angle to prevent the potential for mechanical collision in helicopter 3D operation at full-limit roll and pitch-axis
- Ring-limiter: functions similar to swashplate limitation but is used for control of up to three Voith-Schneider drives in ship models
- Channel sequencer for automating servo motion sequences of up to three servos, e.g. to automate the lowering of landing gear or to extend/retract drives in self-launching gliders
- Multi-channel function for operating *Graupner*

product line NAUTIC modules

- Digital trimming with pseudo »analog« endless pinions, effective per specific flight-phase
- Auto-trim function. The current joystick positions for trimming fixed-wing or helicopter models will be stored in trim memory at the press of a button. (Model »compensation«, activate switch and release joystick. The correction will be blended in »gently« upon return of the joystick.
- C1 changeover, brake/elec. motor: This changeover can be implemented very easily via enhanced flight phase programming. The pilot determines the joystick positions (forward/rear) at which the motor is to be switched off or the airbrakes are to be retracted.
- 16 control functions maximum
- Simplified arrangement of operating elements, such as joysticks, external switches, proportional controls and trim levers as control functions
- Protection against obsolescence is provided by virtue of a fast 32-bit operating system with modern flash memory that can be updated.
- Blue back-lighted MULTI-DATA-GRAPHIK-LCD monitor with significantly better legibility under unfavorable light conditions
- CONVENIENCE MODE SELECTOR to simplify changeovers between operating modes 1 ... 4 (e.g. throttle left/throttle right)
- Two freely programmable mixers for fixed-wing or helicopter models, each with freely selectable input and output functions; four curve mixers with innovative 8-point curve technology for easy to set and adjust curve values at up to eight points for throttle, pitch, tail or other non-linear characteristics. The arithmetic unit in the CPU employs an ingenious method of calculating polynomial approximations for truly-rounded, ideal MPC (multi-point curve) mixer curves

- Shifting curve mixer points can be done along both axes with the CAP touch pad keys
- Eight flight-phase programs can be individually adapted for each model and given a name. The switchover time is programmable separately.
- SUPER SERVO menu with a perfect overview of all servo setting data and simple parameter correction at four "levels": direction of rotation, mid-point setting, separate servo travel on both sides and separate travel limiting on both sides for 16 servos with a total of 96 setting options
- SUPER-DUAL-RATE, EXPO and EXPO/DUAL-RATE menu with 36 potential setting variants for three servo functions and six flight phases
- Practice-optimized multi-function menu for aerofoils and helicopter models. Entry of the number of aileron and flap servos automatically programs all necessary mixer functions in the multi-function "Wing mixers" menu. Differential aileron mixer, butterfly mixer, dual-flap mixer, automatic gyro set function and other special functions
- Helicopter swashplate mixer for 1, 2, 3, or 4 point steering.
- Selectable cycle time: 10 ms or 20 ms/30 ms, depending on receiver and operating mode
- A convenient timers menu with a system of eight stopwatches, alarm timer, countdown timer, laps counter and so on. Two running timers and one lap timer can be displayed at the same time in large characters.
- Stopwatch with history: In addition to the lap counter there is a "Time 1" which captures the switch-on time and a "Time 2" which records the ON and OFF times separately
- *Channel mapping* in the receiver allows free distribution of control functions.
- The travel distance and rotation direction settings

integrated into the receiver make it possible, for example, to match up *mapped* servos with one another

- The programmable fail-safe functions »Hold«, »Off« and »Move to preset positions« that are built into the receiver for every individual servo channel can be set separately
- A slot for FAT or FAT32 formatted SD and SDHC memory cards is available on the transmitter for log files and model programs

Model programs

- Transmitter operating time timer
- Flight phase switch assignments: six switches, two with a priority function. Every switch combination can be named freely. This makes the number of flight phases independent of the number of flight phase switches.
- Tail type normal, V-tail, Delta/flying-wing and 2 HR Sv 3+8 (which immediately makes two coupled elevator servos available without using free mixers or dual mixers)
- Flap count 4 AIL/4 FL: Full support of eight wing servos, even without use of free mixers
- Flight phase switching cutoff delay: the delay time can be switched off for individual channels on a flight-phase basis (e.g. for motor off in electric models or to activate/deactivate helicopter head lock).
Ten additional, user definable phase names: aside from the prescribed flight phase names, the user can also freely assign up to ten phase names of his own choice.
- Enhanced transmitter control menu: option to assign input-side mid-point setting for C1 control + trim as a transmitter control. A single input can be assigned to two switches for a true 3-way switch function.
- Wing mixers: New concept for the multi-flap menu

to simplify settings of one to eight wing servos on a flight-phase specific basis in a comprehensible manner without requiring the use of free mixers

- »Info« sub-option in the Base setup model menu
Any kind of additional information about every model can be entered here. This additional information will then appear in the newly designed model select function
- »Logical switches«: this function permits two switches to be coupled as »and« or »or« logic functions. The result can be employed as a virtual switch. Typical application: The activation of certain functions should only be possible in conjunction with other functions, e.g. wheel brake can only be activated when the landing gear is down. A number of functions which are normally independent of one another, are to be put in their base settings by way of an »Emergency switch«. This program automation can be activated by multiple switches that also select the appropriate program.
- Servo-middle setting range extended to $\pm 125\%$
- Number of flight phases: (fixed-wing: 8, helicopter: 7 + AR)
- Settable »Throttle too high« warning threshold in the helicopter menu, programmable switch-on warning
- Time-frame can only be stopped, and thus also erased, (if the timer switch is in its OFF position) by touching the center **ESC** key while the ◀▶ or ▲▼ selection keys are also being touched.
- Phase trim for all axes of fixed-wing models possible
- Hotkey for servo display: one tap on the ◀ and ▶ keys of the left CAP touch pad (touch sensitive keys) will call up the servo display directly from virtually all menus.
- Servo occupancy swap on the receiver output

- CAP TOUCH operating elements with key lock function to prevent unintentional operation.
- CAP TOUCH display change from the main menu to the telemetry main menu via **ESC**.
- Numerous telemetry displays, programming functions and evaluation functions are presented directly in the transmitter's screen
- Graphic presentation of model icons for the model type display (fixed-wing/helicopter)
- Built-in connector sockets for PC-USB interface, headset, SMART BOX, external RF module, DSC system. Prepared for teacher/pupil operation.
- Teacher/pupil system with or without cable for complete transfer; all settings are made on the teacher transmitter.
- Additional functions are planned for implementation via software update.

Computer System **MC-20 HoTT**

32 channel remote control set in 2.4 GHz *Graupner*-HoTT technology (Hopping Telemetry Transmission)

The set, order no. 33020, includes

- Microcomputer transmitter **MC-20** HoTT with built-in Lilo single cell six-pack/6000 mAh/3.7 V transmitter battery (change reserved)
- Electric outlet charger (4.2 V, 500 mA)
- *Graupner* bidirectional receiver, GR-32 Dual HoTT (order no. **33516**) for connection of up to 16 servos
- USB adapter/interface (order no. **7186.6**) including suitable USB cable for connection to a PC and an adapter cable for receiver updates
- Micro-SD card (2 GB) with an adapter for a card reader
- Sturdy aluminum transmitter case with foam cushioning (order no. **3080**)

Accessories

Order No. Description

71.26 Transmitter straps, *Graupner* HoTT

72.40 Transmitter straps, deluxe

Teacher/pupil cable for **MC-20** HoTT
see page 213

Replacement parts

Order No. Description

3080 Aluminum transmitter case, HoTT,
400x300x150 mm

33000.1 Transmitter battery, flat Lilo, single cell six-pack/6000 3.7 V TX

33002.1 Micro-SD card, 2 GB for HoTT transmitter

33032.2 Transmitter metal hanger for **MC-20**

33032.3 Hand rests for **MC-20** (2 piece)

33801 HoTT transmitter antenna

Technical data for the **MC-20** HoTT transmitter

| | |
|-------------------|---|
| Frequency band | 2.4 ... 2.4835 GHz |
| Modulation | FHSS |
| Region | EURO or FRANCE, see page 261 |
| Control functions | 16 functions, 4 of these can be trimmed |
| Temperature range | -10 ... +55 °C |
| Antenna | collapsible |
| Operating voltage | 3.2 ... 4.8 V |
| Current draw | about 500 mA |
| Range | up to about 4 000 m |
| Dimensions | about 252 x 252 x 60 mm |
| Weight | about 1,685 g with transmitter battery |

Receiver **GR-32** Dual HoTT

Graupner HoTT 2.4 GHz technology gives the dual-receiver a new Hopping Telemetry Transmission high-frequency section with state-of-the-art components and software. The dual-receiver has two complete receiver sections and additional hardware antenna diversity. Reception is always switched over to the better antenna signal and, for transmitting, the antenna last used for receiving will always be used. Thus it is assured that return channel data is transmitted via the better positioned antenna. Parameters for receiver supply voltage, receiver temperature and signal strength are transmitted without any additional sensors.

The receiver has a connector for telemetry sensors and one for sum signal input or output.

The receiver has six battery inputs to make it an excellent power source for even high-load servos.

Technical data for the **GR-32** Dual HoTT receiver Order no. **33516**

| | |
|-------------------|--|
| Operating voltage | 3.6 ... 8.4 V* |
| Current draw | about 140 mA |
| Frequency band | 2.4 ... 2.4835 GHz |
| Modulation | FHSS |
| Antenna | 2 x 2 diversity antennas, about 145 mm long, about 115 mm of this length encapsulated and about 30 mm active |
| Plug-in servos | 16 |
| Plug-in sensors | up to four sensors |
| Temperature range | about -10 ... +55 °C |
| Range | up to about 5 000 m |
| Dimensions | about 63 x 30 x 14 mm |
| Antenna length | 4 x wire 145 mm (active antennae 30 mm) |
| Weight | about 24 g |

* The specification for permissible operating voltage range applies only to the receiver. Please note in this context that receiver input voltage is applied without regulation to connected servos but the voltage range for most connectible servos (speed controls, gyros, etc.) is only 4.8 to 6 V.

Other accessories in Internet at www.graupner.de.
Contact or visit your local dealer. He will be glad to provide advice.

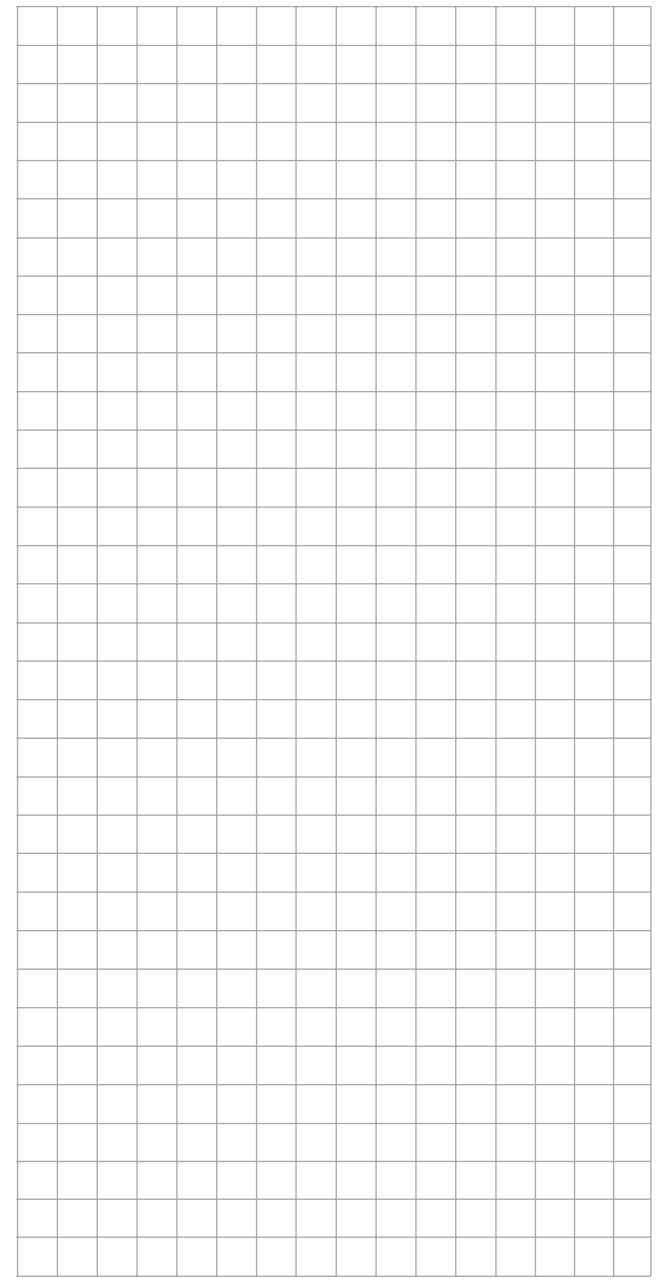
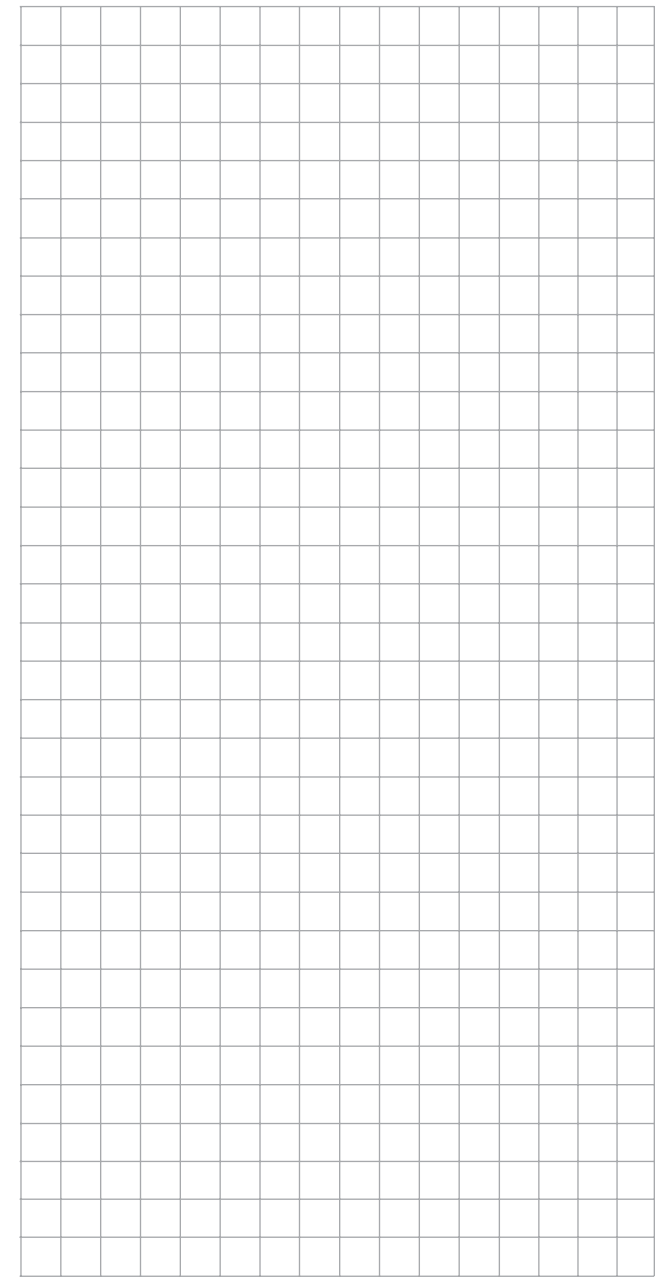
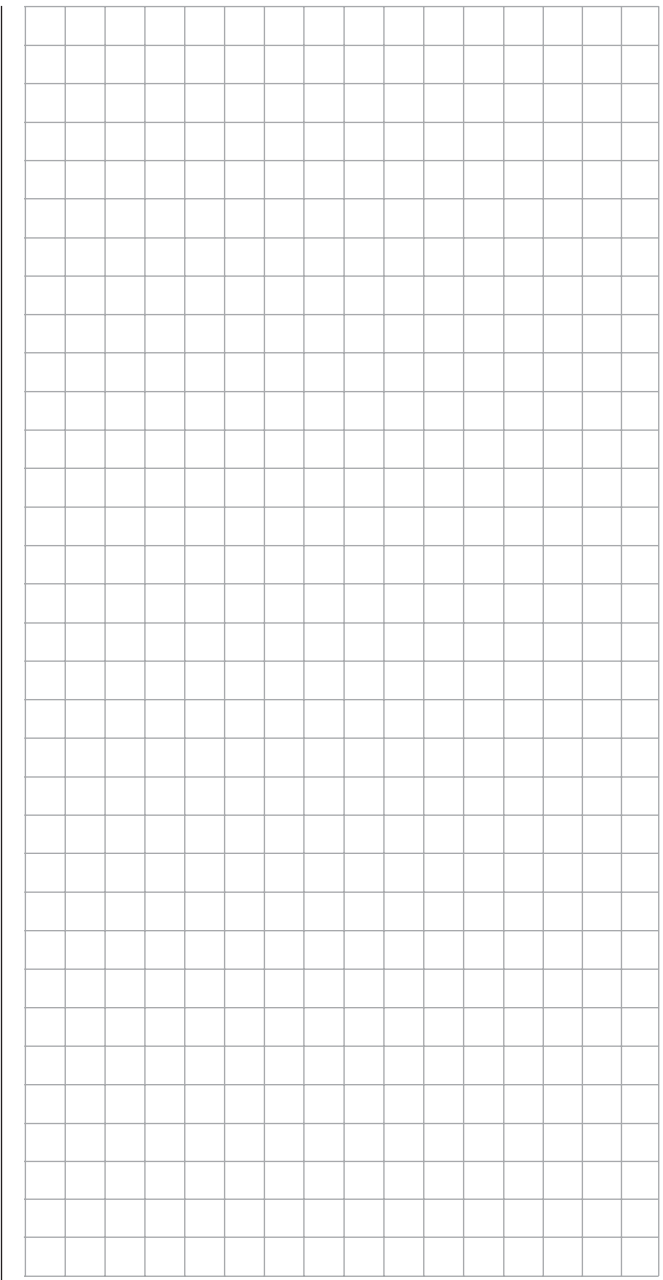

General operating notices

Transmitter

Opening the transmitter housing

Switch off the transmitter before opening it (power switch to »OFF«). Push both housing base latches in the opposite the direction of the arrow marks, toward the inside, to their limits. Now tilt the transmitter somewhat to the rear so the housing base can flip open and can be unhooked. Close the transmitter's housing base by first hooking it to the underside, flip the base closed then push both latches toward the outside. When closing the base, pay attention that no cables are pinched.

Notes:

- **Make no modifications of any kind to the circuit boards as this will void the guarantee as well as the unit's official permit.**
- **Be sure not to touch the circuit boards with any metallic objects. Do not touch contacts with your fingers.**
- **Before performing any tasks inside the transmitter, disconnect the transmitter's battery (see next page) to avoid potential short circuit damage to the transmitter's circuit boards.**



Transmitter power supply

The **MC-20** HoTT transmitter is equipped with a high-capacity, rechargeable Lilo 1s6p/6000 3.7V TX battery (order no. **33000.1**) as standard equipment. (changes reserved) **However, the standard built-in battery is not charged upon delivery of the transmitter.**

When the transmitter is used, its battery voltage should be monitored by way of the indicators provided in the LCD display. If the voltage level preset in the "Battery warning" line of the »**General basic settings**« menu, page 260, (default setting 3.60 V) is underrun, an acoustic signal will be sounded and a warning message will appear in the display.

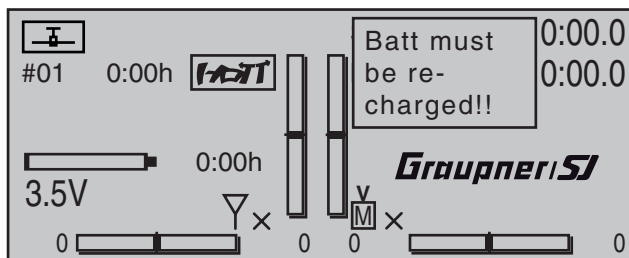

No later than now, operation must be terminated so the battery can be charged again.

Note:

Be sure the correct battery type is set in the »General basic settings« menu, page 260!
The standard setting for this is "Lith.".

Charge the transmitter battery with the plug-in charger.

The transmitter's rechargeable Lilo battery can be charged by way of the charger socket located behind a cover on the left, front side of the transmitter – as viewed from the front– with the included plug-in charger (order no. **32032.4**).

Depending on the state of discharge, the included plug-in charger (4.2V/500mA) requires up to about 15 hours to fully recharge the transmitter battery.

Never use plug-in chargers from other manufacturers or chargers intended for other battery types. Charger output voltage which is too high or possibly even different plug polarity, see further below, can cause immense damage. We recommend that this plug-in charger be appropriately labeled.

Also observe the safety notices provided on pages 4 ... 7.

The transmitter must be switched "OFF" during the entire charging procedure. Never switch on the transmitter when it is connected to the charger. Even a brief interruption to charging can cause charging voltage to rise to a level that will immediately damage the transmitter with over-voltage. Also for this reason, be sure all connectors are always plugged in securely and have good contact.



Charging with automatic chargers

To achieve quicker recharging of the single cell Lilo battery, Graupner automatic chargers can also be used. The table below shows a selection of these chargers.

Recommended chargers (accessory)

| Order No. | Designation | Input voltage | | suitable for battery types | | | | integr. balancer |
|-----------|--------------------|---------------|------|----------------------------|------|-----------|--------------|------------------|
| | | 220 V | 12 V | NiCd | NiMH | LiPo/Lilo | lead battery | |
| 6411 | Ultramat 8 | x | x | x | x | x | | |
| 6463 | Ultramat 12 plus | | x | x | x | x | x | x |
| 6464 | Ultramat 14 plus | x | x | x | x | x | x | x |
| 6466 | Ultra Trio plus 14 | x | x | x | x | x | x | x |
| 6468 | Ultramat 16S | x | x | x | x | x | x | x |
| 6469 | Ultra Trio Plus 16 | x | x | x | x | x | | x |
| 6470 | Ultramat 18 | x | x | x | x | x | x | x |
| 6475 | Ultra Duo Plus 45 | x | x | x | x | x | x | x |
| 6478 | Ultra Duo Plus 60 | x | x | x | x | x | x | x |
| 6480 | Ultra Duo Plus 80 | x | x | x | x | x | x | x |

Charger cable, order no. 3022 is additionally needed for the transmitter and charger cable, order no. 3021 is additionally needed for the receiver.

Other charger units and details about the listed chargers can be found in the Graupner RC main catalog or in Internet at www.graupner.de.

The charger socket is equipped standard with a diode to protect against reversed polarity. Original Graupner automatic chargers also detect battery voltage polarity.

Observe the configuration notices for the charger used.

First connect the charger cable's banana plugs to the charger and only then connect the cable's other end into the charging jack on the transmitter. Never allow the bare ends of the banana plugs to come into contact with one another when the other end of the cable is plugged into the transmitter.

Charging current may not exceed 1.5 A as otherwise the diode, and perhaps other components, could be damaged. If necessary, limit the current at the charger.

NC-20 HoTT charging jack polarity

The charger cables on the market from other manufacturers often have different polarities. Therefore use only an original Graupner charger cable, order no. 3022.



Removing the transmitter's battery

To remove the transmitter's battery, first unlatch the cover of the battery compartment on the rear side of the transmitter housing then remove the cover.



Take out the transmitter's battery then disconnect the transmitter battery's connector by carefully pulling on the supply line cable.

Inserting the transmitter's battery

The battery connector is protected against a reverse polarity connection by two slanted edges, see illustration. When correctly plugged in, the unconnected pin of the connector is at the bottom, as shown in the illustration. The plus pole (red lead) is in the middle and the minus pole (brown or black lead) is toward the antenna side.

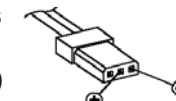

Transmitter connector polarity

Never try to force the connector onto its circuit-board socket.

Place the battery into its compartment and close the transmitter's cover.

Battery operation timer at the bottom left of the screen

This timer shows the transmitter's cumulative operating time since the transmitter's battery was last charged.

This timer is automatically reset to "0:00" when the transmitter is switched on and its battery voltage is significantly higher than when the transmitter was last used, e.g. because the battery was charged.

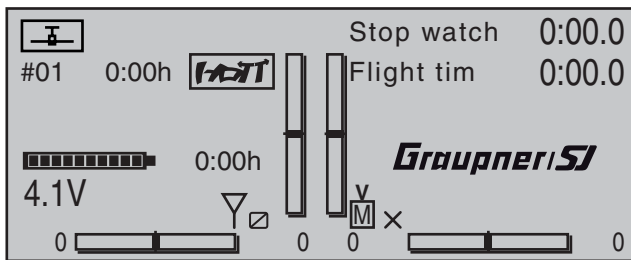

Lithium battery, CR 2032

On the side of the transmitter board opposite the transmitter battery there is a fixture containing a lithium battery, type CR 2032, which can be replaced by the user.

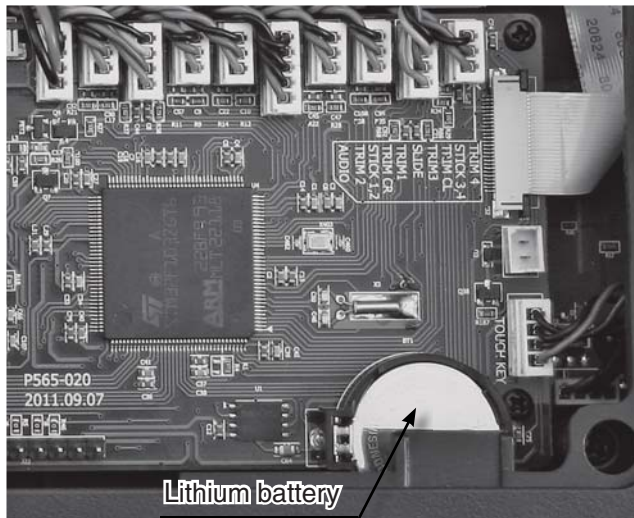

This battery maintains the date and time settings during a transmitter power supply outage, for example when the transmitter's main battery is being replaced.

Joystick length adjustment

The length of both joysticks can be continuously adjusted to adapt these transmitter controls to the pilot's preference.

Hold the lower half of the knurled grip in place then turn the upper section to release its counter-locked threads.

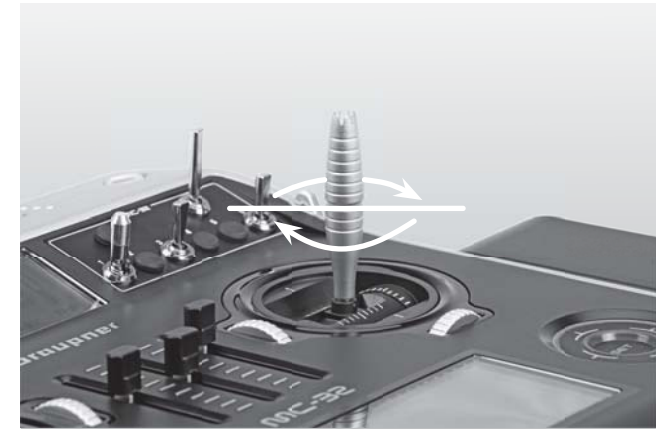

Now pull up or push down on the joystick's end to the desired length. When the length is suitable, tighten the counter-locked threads of the upper and lower sections again.

Joystick conversions

Neutralization

Both the left and the right joystick can be configured for neutralized or non-neutralized operation. Open the transmitter.

To change the joystick's factory setting, locate the screw shown in the figure below enclosed in a white circle.

Note:

The aggregate for the right joystick is a mirror image of the left joystick so the corresponding screw for the right joystick is on the right side just below the middle.

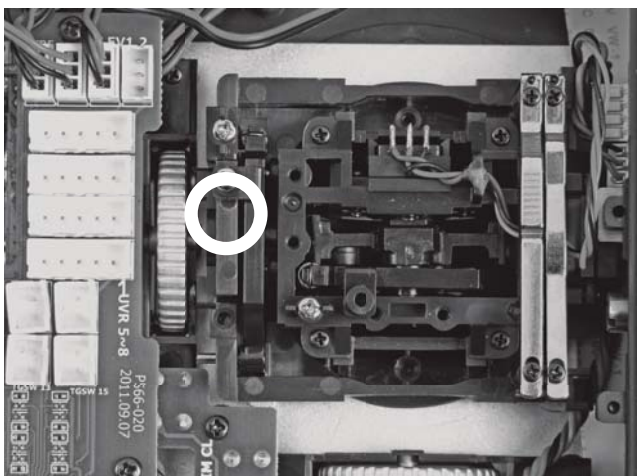

Now turn this screw down until the respective joystick is free to move from limit to limit - or turn the screw out until the joystick again completely self-restoring.

Brake spring and ratchet

The outboard screw of the two marked in the next figure adjusts the braking force and the inboard screw adjusts the strength of the ratchet for the respective joystick.

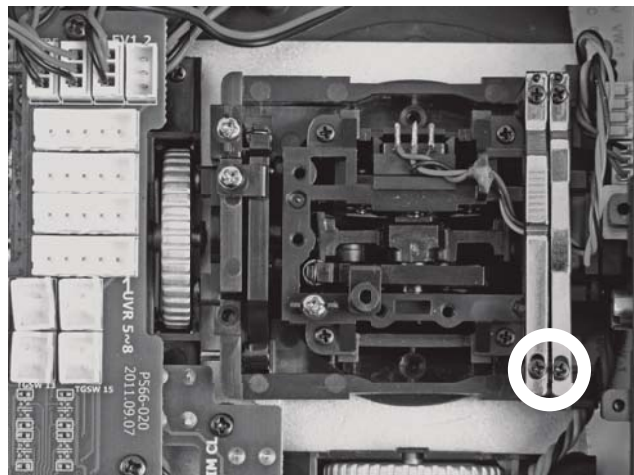

Note:

The aggregate for the right joystick is a mirror image of the left joystick so corresponding screws for the right joystick are located at the top left.

Joystick restoring force

The joystick's restoring force can also be adjusted to the pilot's preference. The adjustment is located next to the return springs, see markings in the figure below.

Spring force for the given direction of motion can be adjusted by turning the respective screw with a Phillips screwdriver.

- clockwise = stronger return,
- counter-clockwise = weaker return.

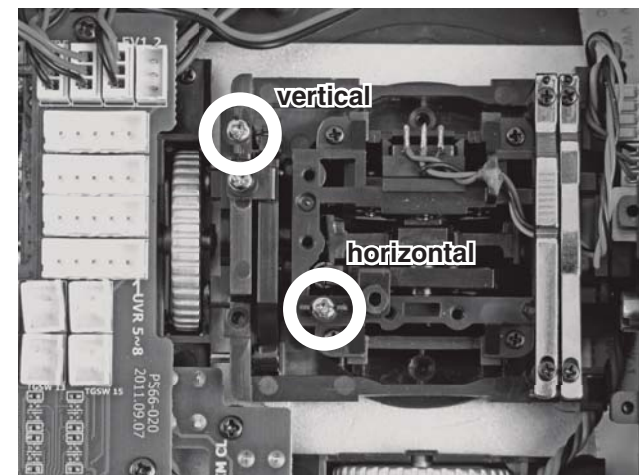

Note:

The aggregate for the right joystick is a mirror image of the left joystick so corresponding screws for the right joystick are located to the right of the middle.

Holder bracket for transmitter straps

A stable transmitter hanger for fastening neck straps is standard equipment on the **HC-20** HoTT transmitter.

To unfold the holder brackets, first press both brackets inward a bit near where they are lettered then turn them upward by 90°. The brackets will automatically lock into position.

If you have a neck strap fastened to the holder bracket with key-rings, first press lightly on the right holder bracket to release its latch so it can be folded down then do the same with the left holder bracket. Afterward, press both brackets **SIMULTANEOUSLY** into the recess.

The following straps are available as accessories:

Order no. Description

| | |
|--------------|--|
| 71.26 | Transmitter straps, <i>Graupner</i> HoTT |
| 72.40 | Transmitter straps, deluxe |



Installation of switches, switch modules and knob modules

There are a total of 20 holes in the transmitter's housing available for mounting accessory modules.

To be safe, always disconnect the transmitter battery before installation to avoid short circuit conditions. Be sure to pay attention that soldered points on the transmitter board do not come into contact with metal objects!

Unoccupied holes in the transmitter's housing are closed with blind plugs. These can easily be pulled out from the outside with one's fingernails.

Insert the accessory switch, etc. through a hole in the housing from the inside.

Accessory switches, potentiometers, etc. are fastened into place by screwing a nut onto the threaded shaft protruding through the housing and tightening it with a suitable wrench. If the control has a knob, it can be reattached after the nut is tightened down. Trim nut wrench (order no. **5733**) is well suited for tightening down these nuts.



Trim nut wrench (order no. **5733**) is well suited for tightening down switch element trim nuts.

Aligning the antenna

The removable, articulated antenna is to be screwed into the ball-joint connector then aligned by hand. The antenna exhibits very limited field strength straight out from its end, pointing it directly toward the model is wrong.

When screwing in the antenna, pay attention that the center pin in the antenna socket does not get bent or pressed back in the socket.



Transmitter description

Front side

Antenna

removable antenna, with kink and twist joint

Connector sockets

on the face side, protected by a cover, see beginning page 22

Function modules

Drum roller control: left "DG5", top "DG3", right "DG1"

Function modules

Knob control (depressible): left "DG4", right "DG2"

Option locations

for retrofitting the transmitter with switches and knob modules 8 switches included as standard equipment

Function module

rotary control: left-side "SD2", right-side "SD1"

Function modules

three sliders, "SR1", "SR2", "SR3"

Digital trim

For the fine-tuning of servo positions (travel neutralization). When turned, each click produces an increment of adjustment (position indicator in display). A press on the trim wheel will reset the trim adjustment.

left touch pad:



SET = select/confirm
touched for about 1 s: Changeover between telemetry menu and basic display

- . - = scroll in one of the four directions with every tap (◀, ▶, ▲, ▼)



simultaneous horizontal tap (◀▶)

= changeover between basic display and servo display



simultaneous vertical tap of the left (▲▼) keys + "SET" of the right touch pad = changeover to the "secret options", see page 32.

LC Display (more details available on page 28.)

Telemetry indicators: receiver parameters, standard. Other indicators dependent on the data from the optional sensors connected.

ON/OFF switch (ON/OFF with LED display)

Note:

Always switch on the transmitter then the receiver. When switching off, first switch off the receiver then the transmitter.

LED indicators

BATTERY: illuminates when voltage is sufficient

RF: illuminates during RF radiation

WARNING: blinks, for example, when "Throttle too high", "no pupil signal", "Transmitter battery voltage too low", ...

Loudspeaker

Joystick

Two joysticks for a total of four independent control functions. The length of the joysticks can be adjusted. The correlation of control functions 1 ... 4 can be set on a model type basis by way of the »Basic settings, model« and »Control adjust« menus, e.g. throttle left or right. The throttle joystick can be converted from neutralizing to non-neutralizing, see page 19.

touch sensitive keys, left and right

LC Display (more details available on page 28.)

Contrast adjustment: a simultaneous tap on (▲▼) + "SET" of the right touch pad = change to "secret options"

Warning indicators:

- for underrun of preset battery voltage threshold
- for fault function of the teacher/pupil system
- C1 joystick too far toward full throttle when transmitter is switched on
- ...

right touch pad:



SET = select/confirm

{ } = scroll or change value with every touch of one of the four direction symbols (◀, ▶, ▲, ▼)



Circle with the finger around the circumference = scroll/change values. Alternative values selection with the left touch pad (◀, ▶, ▲, ▼)

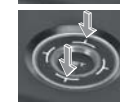

or simultaneous tap on ▲▼ or ◀▶ = **CLEAR**

Face-side connections

Charger jack

The **MC-20** HoTT transmitter's charger jack becomes accessible after turning the *left* face-side cover away.



The transmitter's rechargeable Lilo battery can be charged by way of the charger socket located behind a cover on the left, front side of the transmitter – as viewed from the front – with the included plug-in charger (order no. **32032.4**).

Maximum permissible charging current with Graupner automatic chargers: 1.5 A.

Never use plug-in chargers from other manufacturers or chargers intended for other battery types. Charger output voltage which is too high or possibly even different plug polarity, see further below, can cause immense damage.

More information about charging the transmitter's battery can be found on page 16. Observe the safety notices on pages 7 ... 9 when handling lithium batteries.

DSC / Direct Servo Control

The acronym "DSC" is a carryover which stands for the original "Direct Servo Control" function. However, in HoTT systems the "direct servo control" function is no longer available via a diagnose cable due to technical reasons.

Once the left face-side cover has been moved away, the **MC-20** HoTT transmitter's DSC socket is accessible:



The standard two-pole DSC jack in the **MC-20** HoTT transmitter is used as the teacher or pupil jack as well as an interface to flight simulators.

To ensure a proper DSC connection, please observe:

1. Make any necessary menu changes.
Refer to the section beginning on page 210 to adapt the **MC-20** HoTT transmitter to a teacher/pupil system.
2. When operating a flight simulator or when operating the **MC-20** HoTT transmitter as a *pupil* transmitter, **ALWAYS** leave the transmitter's ON/OFF switch in the "OFF" position as only in this position does the transmitter's RF module remain inactive after the DSC cable is inserted. This also reduces the transmitter's power consumption somewhat.

Only the "BATTERY" LED should remain constantly illuminated and the transmitter's basic display should show the character string "DSC" below the operating time clock. At this time, the display of

telemetry data and symbols will be suppressed.

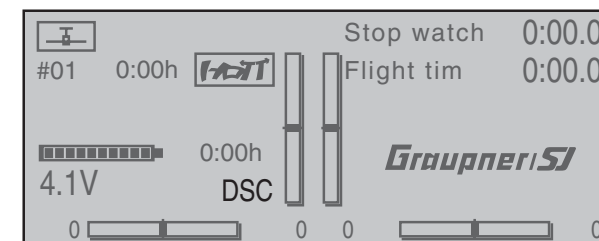

The transmitter's upper display will show the message "CANNOT RECEIVE DATA" during this time.

Thus the transmitter is ready for operation.

In contrast, the **MC-20** HoTT transmitter in teacher mode is to be switched on *prior* to plugging in the respective cable.

3. Connect the other end of the cable to the desired unit in compliance with the given operating instructions for that unit.

Important:

Pay attention that all plugs are inserted securely into their respective sockets and use only the prescribed 2-pole TRS connector plugs on the DSC-side.

4. In the line "DSC Output" in the »**Basic settings, model**«, page 81 or 88 or the line "Pre-set DSC Output" in the »**General basic settings**«, page 258, – depending on the number of functions transferred – one of the following modes can be set: PPM10, PPM16, PPM18 or PPM24. Default setting: PPM10.

Notice about flight simulators:

Because of the myriad of flight simulators available on the market, it may be necessary to have the contact layout of the audio plug or DSC module appropriately modified by Graupner Service.

Mini-USB connector

Connector jack for software updates as well as for changing date and time from a PC with a Windows XP, Vista or 7 operating system.



The USB cable, order no. **32032**, which is included with the set is to be connected to this jack. The procedure for carrying out a software update via a PC is described on page 43.

The PC software required, as well as the suitable USB driver, can be found on the download page for the given product on the Graupner website at www.graupner.de.

Once the necessary driver and software is installed on the PC, this USB connection can be used to update the transmitter or even just to set the transmitter's date and time.

To set the transmitter's date and time by way of this jack, refer to the »**Info display**« menu, beginning page 266.

Data jack

The so-called "DATA jack" is located at the right of this group of connector sockets.



This jack is intended for connection of the optional Smart-Box, order no. **33700**.

Details about the Smart-Box can be found with the given product in the *Graupner* RC main catalog or in Internet at www.graupner.de.

Card slot

micro SD and micro SDHC

The **MC-20** HoTT transmitter's card slot for type micro-SD and micro-SDHC memory cards becomes accessible once the *right* face-side cover has been turned away.



All conventional micro SD memory cards up to 2 GB and micro SDHC cards up to 32 GB storage capacity can be used. However, as a manufacturer we recommend the use of memory cards no larger than 4 GB as this is completely adequate for all normal situations.

The type of memory card to be used in the transmitter is that known in conjunction with digital cameras and cell phones. It is to be pushed into the slot, contacts up, until it latches, see photos above.

Once the memory card has been inserted, the transmitter's cover flap can be closed again.

The stylized image of a memory card will appear in the basic setup screen to indicate the presence of the inserted memory card.



Removing the memory card

Press the SC card a bit further into the card slot to

release the slot's latch then pull out the memory card.

Data acquisition / storage

The storage of data on the SD card is coupled to the flight timer. If this timer is started—when a suitable memory card is inserted in the card slot and a telemetry link to the receiver exists—data acquisition is also started. Data acquisition will stop again when the flight timer is stopped. The flight timer is started and stopped as described in the section "Timers (general)" on page 153.

While data acquisition is ongoing, the on-screen card image  will blink continuously at a slow rate.

The amount of data written on the memory card is presented as a black bar graph which grows from left to right as data fills the memory card.

After a data acquisition session is finished, there will be an (empty) folder "Models" and a "LogData" folder on the memory card. Within the "LogData" folder there will be log files in sub-folders that are designated with names in the format 0001_year-month-day.bin, 0002_year-month-day.bin, etc. If a model memory folder is still "unnamed" when the memory card is removed from the transmitter and inserted into the card slot of a PC or laptop, the respective log files can be found in a sub-folder designated "NoName". There is a PC program available on the transmitter's download web page at www.graupner.de with which the stored data can be evaluated on a compatible PC.

Importing voice files

As mentioned in section "Headsets", here at the right, the transmitter's acoustic signals as well as those signals and announcements associated with the telemetry menu can be output by way of the headset connector. These announcements are made in German language by default. These announcements are summarized in a voice packet which is stored in a transmitter-internal memory but can be replaced by a

voice packet of a different language at any time. More information about this can be found in the section »**SECRET MODE**« beginning on page 32.

Importing/exporting model memories

Any model memory can be stored to an inserted memory card or from an inserted card into the transmitter. This feature is intended to support data exchange between identical transmitters or even use as data backup. More information about this can be found in the section »**Copy / Erase**« beginning on page 71.

Note:

Some special symbols that can be used in model names are subject to specific restrictions associated with the FAT or FAT32 file system used by the memory cards and these special symbols will be replaced during the copy process with a tilde (~).

Headset connector

Once the right face-side cover has been moved away, the **MIC-20** HoTT transmitter's headset connector is accessible:

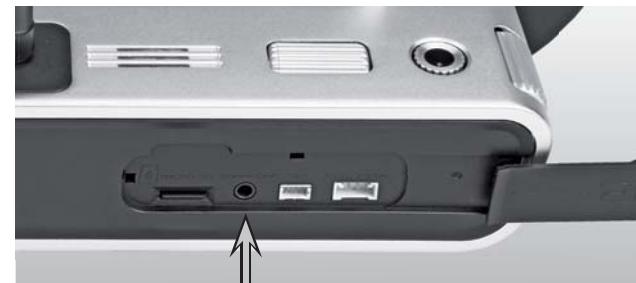

The jack is intended for connecting conventional earplugs or a headset by way of a 3.5 mm TRS plug. (not included in the set) An appropriate symbol will appear in the basic display when a headset is connected.

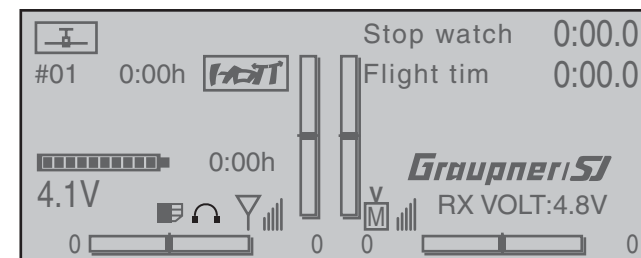

The transmitter's acoustic signals as well as those signals associated with the telemetry menu are output via this connection. These announcements are made in German language by default. More about this can be found under "Voice output" in the section »**SECRET MODE**« beginning on page 32 and »**Telemetry**« beginning on page 228.

The volume of signals and voice output sent to the headset can be adjusted individually in the lines "Voice volume", "Vario volume", and "Touch-beeps vol." of the »**General basic settings**« menu, page 259.

EXT.PPM

An external RF module, for example a WEATRONIC module, can be connected to this jack, see illustration below.

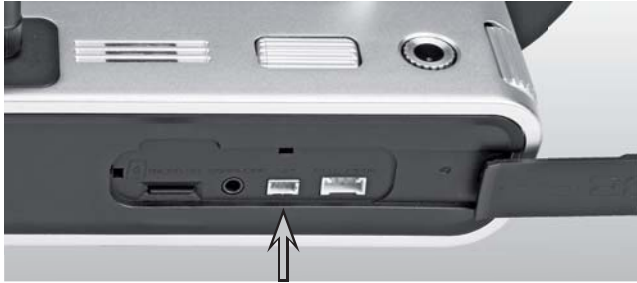

An external RF module, for example a WEATRONIC module, can be connected to this jack.
If an external RF module is attached, then switching between the external module and the internal HoTT RF module is accomplished in the "Module" line of the »**Basic settings, model**« menu, page 77 or 85, by selecting either "HoTT" or "EXT.PPM". If necessary, the signal provided on this connection can be inverted by selecting the appropriate option for the line "ext. PPM signal" in this same menu, see page 83 or 92.

Note:

The "INT PPM" socket located inside the transmitter is also suitable for this purpose. However, a connecting cable must be passed through to the outside of the transmitter housing by way of one of the module openings originally intended for a switch.

SPI

The designation "SPI" stands for an interface for future applications. This socket is currently non-functional and may not be connected.

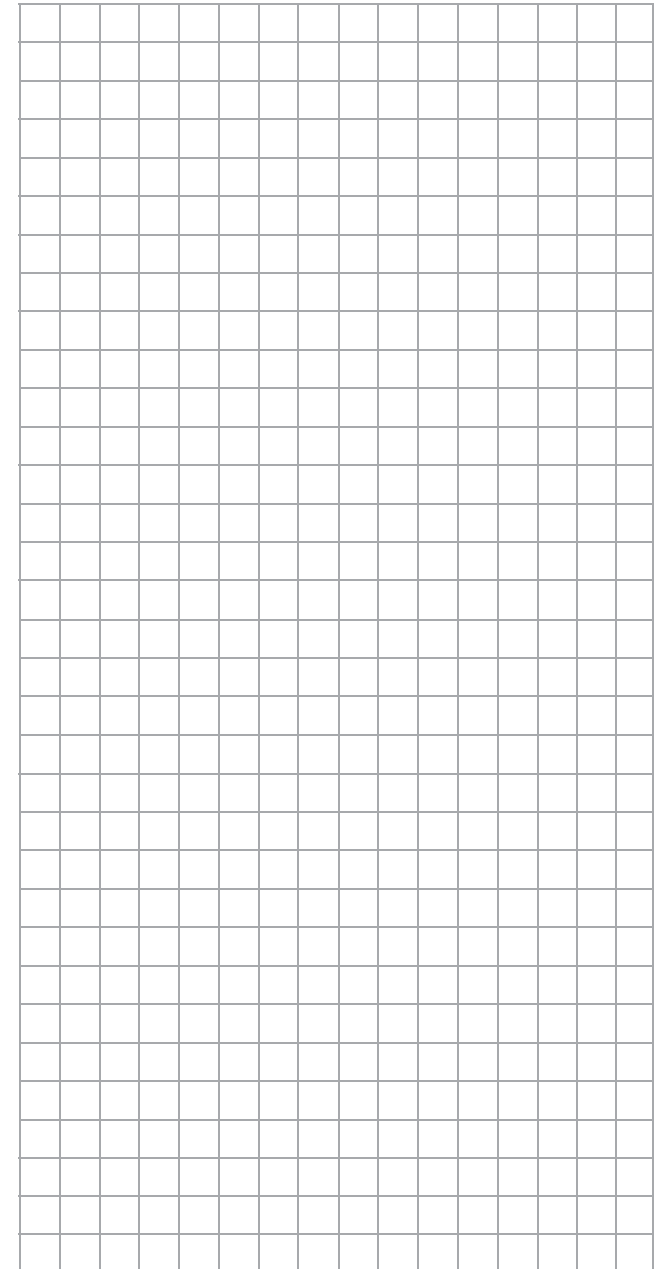
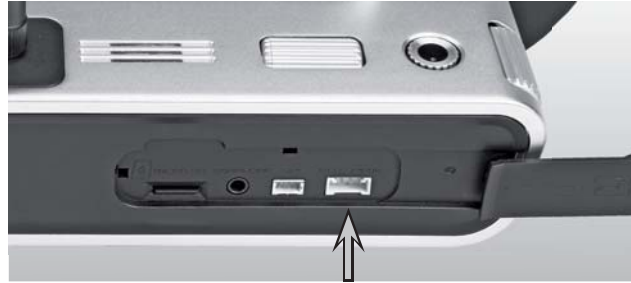

Bottom side transmitter interior

Notes:

Disconnect the transmitter battery at its connector when performing any type of work inside the transmitter. Never allow solder points to come into contact with objects as this can create short circuit conditions.

All jacks and plugs not described are to be left unconnected.

INT PPM plug-in location

One free plug-in location for connecting an additional – internal – RF module

Plug-in location

One free plug-in location for a proportional rotary control module, order no. **33001.11**

Plug-in locations

Six free plug-in locations for additional switches are standard, see page 21
These switch plug-in locations can be used in any sequence.

Transmitter battery

Observe charging rules, see page 16

Transmitter battery plug

For charging the battery and a list of suitable automatic chargers, see page 17

Plug-in locations (UVR, 5-pole)

eight free plug-in locations for future rotary control installations.

Lithium battery CR2032 (not rechargeable)

Independent backup for the transmitter's date and time settings, see »Info display« menu on page 266.



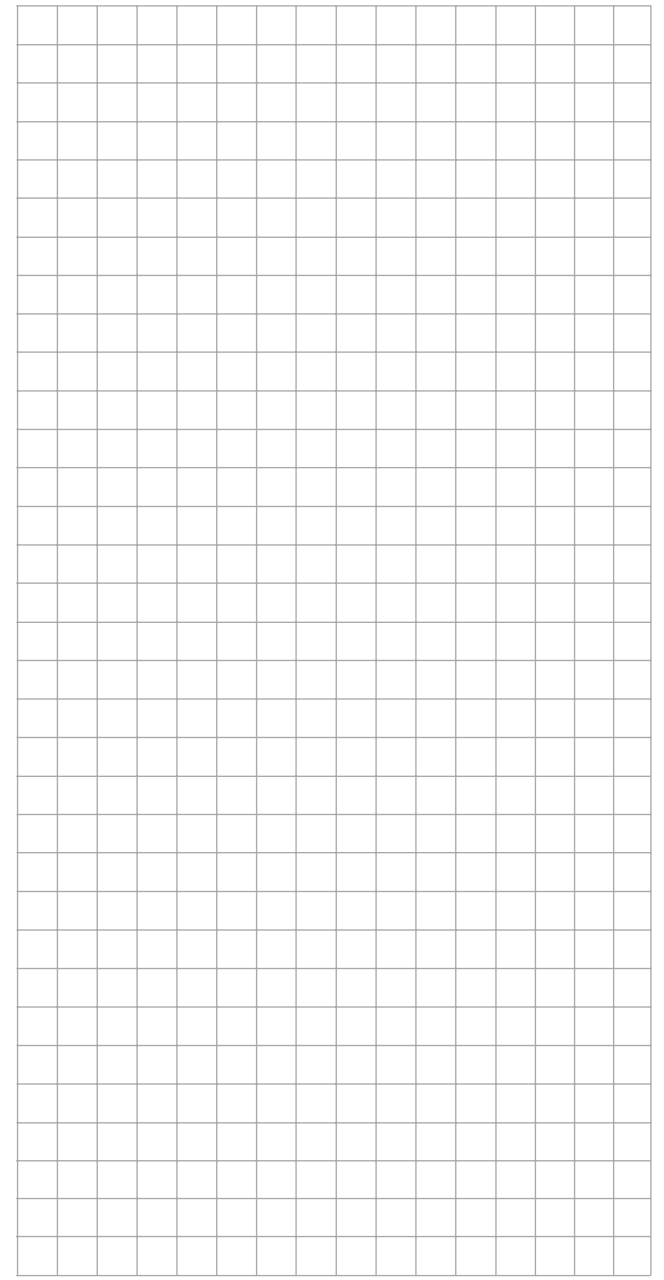
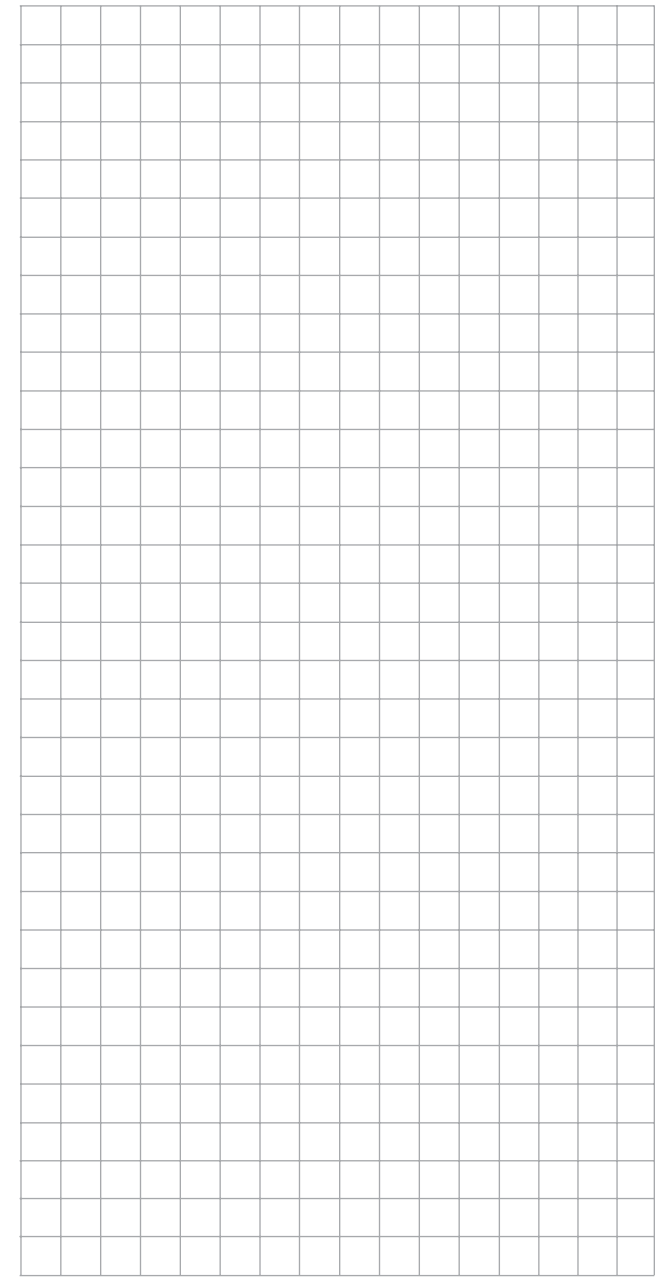
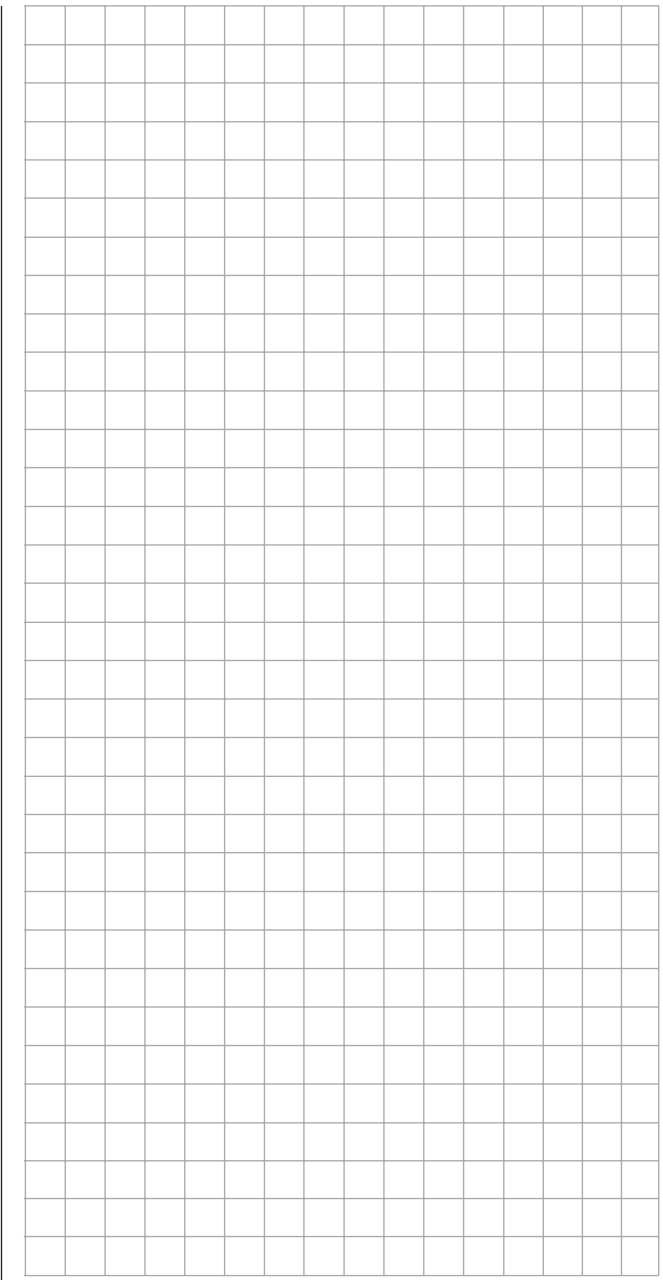

Display and keypad

left touch pad:



SET = select/confirm
 touched for about 1 s: Changeover between telemetry menu and basic display

SET = scroll one of the four directions with every tap: (◀, ▶, ▲, ▼)

simultaneous horizontal tap (◀▶) = changeover between basic display and servo display



simultaneous vertical tap of the left (▲▼) keys + "SET" of the right touch pad = changeover to the "secret options", see page 32.



simultaneous vertical tap of the left (▲▼) keys + "SET" of the right touch pad = changeover to the "secret options", see page 32.

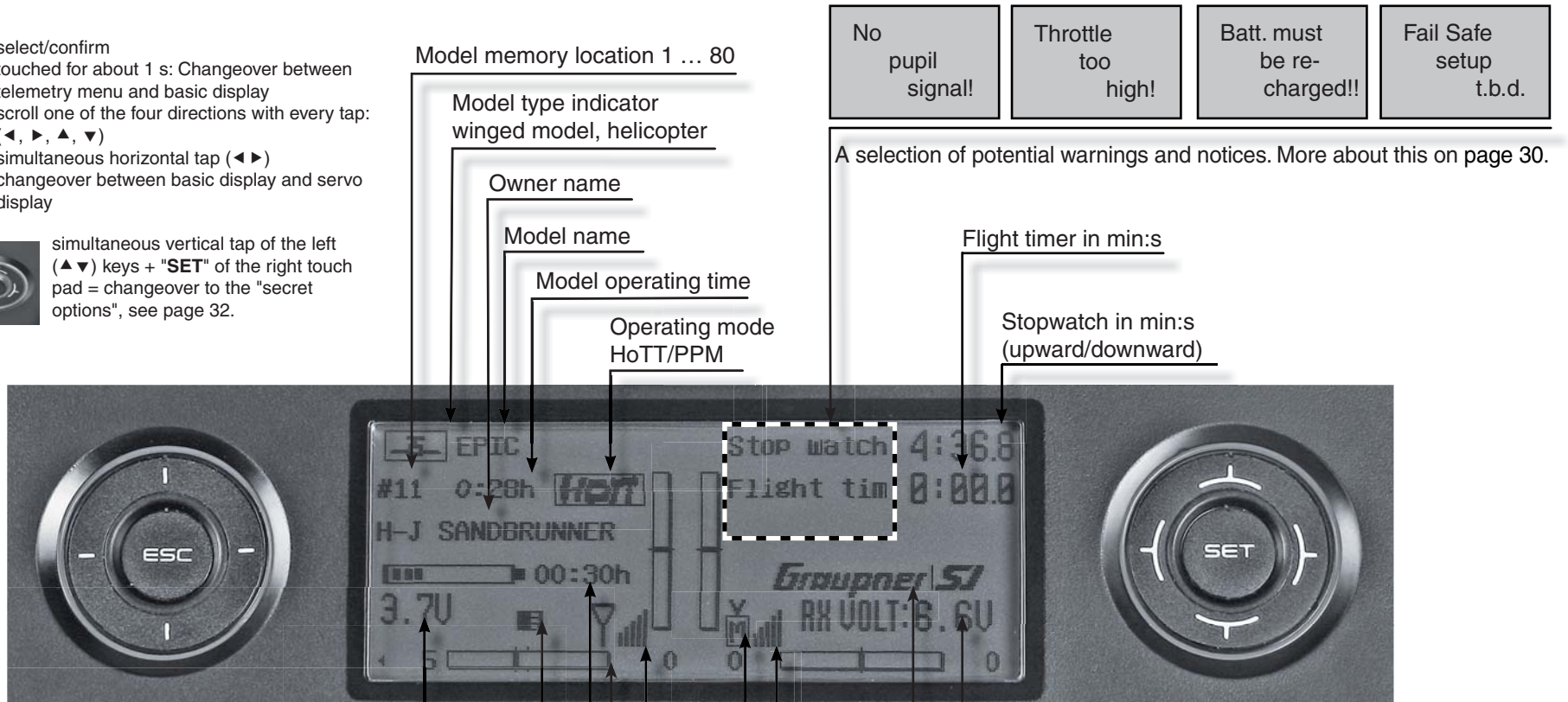

Transmitter battery voltage with dynamic bar indicator. If the lithium battery voltage underruns the 3.60 V (adjustable) threshold a warning message will appear and an acoustic warning will sound. (switchover for NiMH batteries.)

micro-SD card inserted

Transmitter operating time This will automatically be reset to zero after a charging process.

Display diagram for all four digital trim levers with numeric indicator and direction indicator

M=Model operation
 P = Pupil (pupil transmitter)

Signal strength

Graupner/SJ logo or flight phase name

Receiver battery voltage RX-SPG

right touch pad:



SET = select/confirm

◊ = scroll or change value with every touch of one of the four direction symbols (◀, ▶, ▲, ▼)

Circle with the finger around the circumference = scroll/change values. Alternative values selection with the left touch pad (◀, ▶, ▲, ▼)

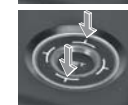

simultaneous tap on ▲▼ or ◀▶ = CLEAR







Operating the "data terminal"

Entry keys ESC and SET

Display symbols

Displayed telemetry symbols

-  the active model memory has not yet been "bound" to a HoTT receiver. More about the "Binding" process can be found on page 77 and 85.
-  Switched off on RF transmitter side
blinking antenna symbol:
The last receiver bound to the active model is inactive or out of range
-  no telemetry signal to receive
-  signal strength indicator of the connection to the model
-  signal strength indicator of the connection to the pupil transmitter in the display of the teacher transmitter for wireless teacher/pupil operation

Keys left of the display

- **ESC** key
each brief tap on the **ESC** key will cause a stepwise return in function selection or even further to the base screen. Any changes made to settings remain.
Momentarily touching the **ESC** key for about 1 s while in the base screen will open and close the Telemetry menu.
- Selection keys ◀▶ ▲▼
 1. A tap on one of these keys will scroll, appropriate for the given arrow direction, through lists, such as through the model selection list or the multi-function list or within menus through the menu's lines.
 2. A brief simultaneous tap on the ◀▶ keys will cause a switch from the transmitters base screen, as well as from almost any menu position, into the »**Servo display**« menu.

Keys to the right of the display

- **SET** key
 1. After switching the transmitter on, a brief tap on the **SET** key will cause a jump from the displayed base screen to the Multi-function menu. In the same manner, a selected menu can now be called up with the **SET** key.
 2. Within menus having settings, activate / deactivate (confirm) the given setting fields with a tap on the **SET** key.
- Selection keys ◀▶ ▲▼
 1. "Scrolling" through the Multi-function menu and menu lines within the Basic Settings menu analogous to the selection keys of the left touch pad or by "circling" over the four selection keys.
 2. Select or set parameters in setting fields after their activation with a tap on the **SET** key, whereby the ▶▲ and ◀▼ keys will have the same given function. In this case it is completely irrelevant which of these two keys are used.
 3. A brief simultaneous tap on the ▲▼ or ◀▶ keys will set a changed parameter value in the entry field back to its default value (**CLEAR**).

Notes:

- *Touching the given touch pad does not itself initiate the given action but rather the end of the touch.*
- *In the event the touch pads do not exhibit any functionality immediately after switching the transmitter off and then on again right away, this is not a fault. Just switch the transmitter off again then wait for several seconds before switching it on again.*

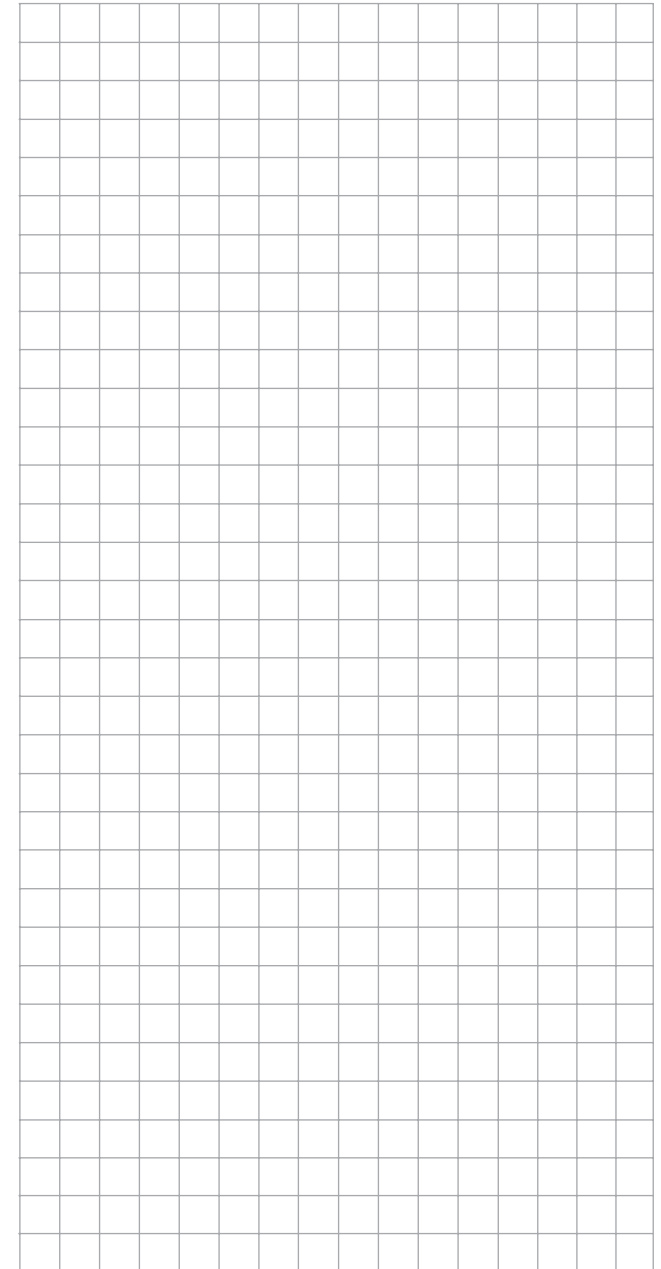

Shortcuts

The following key combinations can be used to directly call up certain menus and options:

- **CLEAR**

A brief simultaneous tap on the ▲▼ or ◀▶ keys of the right touch pad will reset a changed parameter value in the active entry field back to its default value.

- »**Servo display**«

A brief simultaneous tap on the ◀▶ keys of the left touch pad will change from the transmitter's base screen or from almost any menu position to the »**Servo display**« menu, see page 262.

- »**Telemetry**« menu

Tap the center **ESC** key of the left touch pad for about 1 s to call up the »**Telemetry**« menu from the transmitter's base screen or return to the base screen again, see text beginning on page 228.

- **Graphic display of telemetry data**

Briefly touching one of the selection keys of the left or right touch pad will cause a jump from the base screen directly to the transmitter's graphic display of telemetry data or will allow paging back and forth between individual graphic displays. A brief tap on the center **ESC** or **SET** key will cause a return back to the base screen.

- »**SECRET MODE**«

(language selection and contrast)

Touch and hold the ▲▼ selection keys of the left touch pad then momentarily touch the **SET** key of the right touch pad, see text beginning on the next double-page.

- **Entry lockout**

Entry lockout is activated and deactivated from the base screen by simultaneously touching the **ESC** and **SET** keys for about 2 s.

- **Quick-Select**

From the multi-function list, a jump can be made into a "Structure overview" by way of a brief,

simultaneous tap on the ▲▼ or ◀▶ keys of the right touch pad. Menus are arranged in clear groups in this overview.

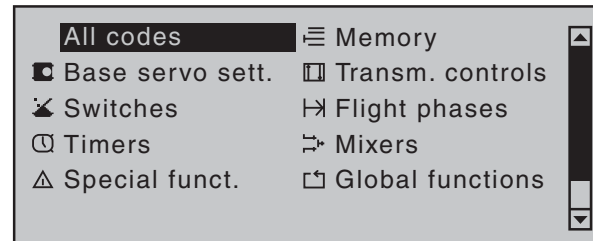

Now the desired group can be selected with the ▲▼ selection keys of the left or right touch pad ...

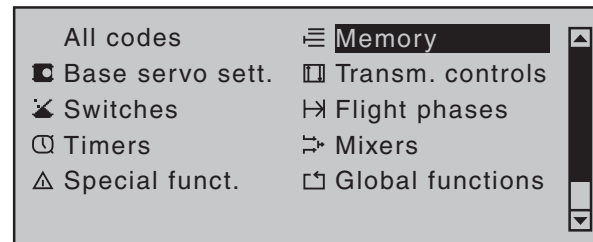

... then finally tap the center **SET** key of the right touch pad briefly. As soon as the key is released, only the respective generic term for the given menu will remain listed. For example:

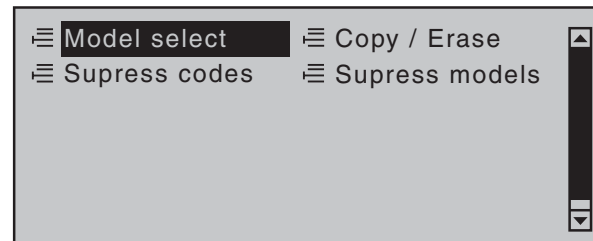

Warning notices

Warning notices

| | |
|--|--|
| BIND. N/A OK | <p>"Bind not available" A receiver has not yet been bound to the currently active model memory. A brief tap on the SET key will cause a direct jump to the appropriate option.</p> |
| CAN'T RECEIVE DATA | <p>No bound receiver in range</p> |
| Please select RF on/off? ON OFF | <p>Only for a receiver that has already been bound: Please select RF "on" or "off"?</p> |
| RF MUST BE OFF OK | <p>Prompt to switch off RF transmission (A bound receiver can only be replaced by another receiver when RF transmission is switched off.)</p> |
| TRAINER Wireless Link ACT INH | <p>Is the "wireless teacher/pupil connection" that was active when the transmitter was last used to be continued, ACT (active, i.e. continue) or switched off INH (inhibit, i.e. discontinue)?</p> |
| Batt. must be re- charged!! | <p>Operating voltage is too low</p> |

Fail Safe
setup
t.b.d.

Failsafe has not yet been activated

Throttle
too
high!

Helicopter throttle joystick
or limiter too high

No
pupil
signal

Connection between
teacher and pupil is
interrupted

SD-CARD
INSERT
OK

No SD or SDHC memory
card in the card slot or
card is not legible

- The transmitter has not been operated within the time period specified by the "Stick warning" line of the »General basic settings« menu, see page 260. The message ...

!Stick!

..., die "WARNING" LED at the right next to the on/off switch will blink and an acoustic warning will sound. If the transmitter is not operated within the next minute, the transmitter will switch itself off.

- If battery voltage is too low, a model switch is blocked for reasons of safety. An appropriate message will appear in the screen:

not possible now
voltage too low

Function fields in the display

SEL, STO, SYM, ASY, ↗, ↘

Depending on the given menu, certain function fields will appear on the bottom display line.

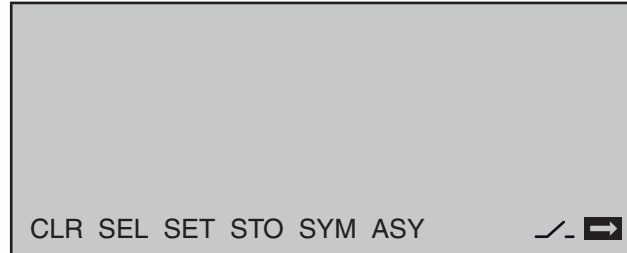

A marked function is activated with a tap on the **SET** key.

Function fields

- **CLR** (clear) erase
- **SEL** (select): selection
- **SET** (set) "set" or adjust a value
- **STO** (store): store (e.g. control position)
- **SYM** set values symmetrically
- **ASY** set values asymmetrically
- ↗ switch field symbol (assignment of all types of switches)
- ↘ within a menu, change to the second page, (menu continuation)

Entry lockout

A lockout for the touch keys, and thus protection against inadvertent use of all setting options, can be established by touching and holding the **ESC** and **SET** keys simultaneously for about two seconds while the **RC-20** HoTT transmitter is in its basic display. This lockout condition is indicated by a key symbol, located at the intersection point of the trim bars, which is displayed in reverse video.

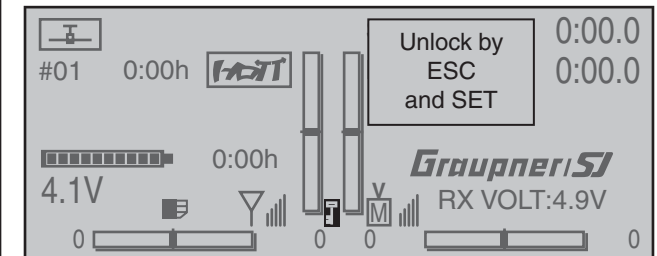

The lockout is effective immediately but controls remains operationally ready.

This lockout can be removed by again touching and holding the **ESC** and **SET** keys for about two seconds. A lockout condition is also removed the next time the transmitter is switched on.

SECRET MODE

Language selection and display contrast

The **MC-20** HoTT transmitter's »**SECRET MODE**« menu can be called up from almost any menu position by touching and holding the ▲▼ selection keys of the left touch pad and the **SET** key of the right touch pad for at least 3 seconds. This will produce the display shown below.

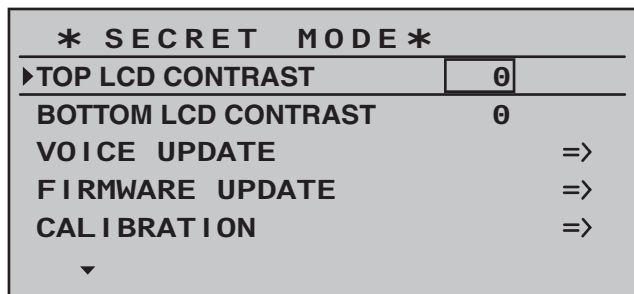

TOP / BOTTOM LCD CONTRAST

Following a tap on the center **SET** key of the right touch pad, a selected "... CONTRAST" line can be used to adjust the contrast of the given display to meet personal preference with the selection keys, as described in more detail on page 259. Another tap on the **SET** or **ESC** key will return to line selection.

The line ...

VOICE UPDATE

As mentioned in section "Headsets" on page 24, the transmitter's acoustic signals as well as those signals and announcements associated with the telemetry menu can be output by way of the headset connector. These announcements are made in German language by default. These announcements are summarized in a voice packet which is stored in a transmitter-internal memory but they can be replaced by a voice packet of a different language at any time. At the time of this manual's printing, the standard

SD card delivered with the set includes the following languages:

- German
- English
- French
- Italian
- Spanish

The given active language packet can be swapped out either with the PC program available as a download from the transmitter's web page at www.graupner.de or with the SD card, as described below. If not already done, insert the SD card or SDHC card into the transmitter as described on page 23. Once the memory card is inserted in the transmitter, switch the transmitter on *with RF switched off*.



Language change

Use the selection keys of the left or right touch pad to select the line "VOICE UPDATE" line.

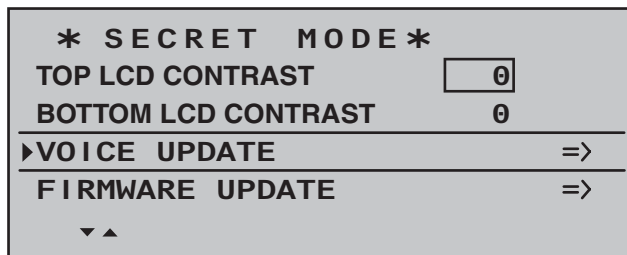

Use the center **SET** key of the right touch pad to switch to the selection page for the "VOICE UPDATE" line.

FILE LIST

- ▶ **VOICE_ENGLISH.VDF**
- VOICE_FRANCE.VDF
- VOICE_GERMAN.VDF
- VOICE_ITALIANO.VDF
- VOICE_SPAIN.VDF

Now use the ▲▼ keys of the left or right touch pad to choose the desired language, for example:

FILE LIST

- ▶ **VOICE_ENGLISH.VDF**
- VOICE_FRANCE.VDF
- VOICE_GERMAN.VDF
- VOICE_ITALIANO.VDF
- VOICE_SPAIN.VDF

Confirm the choice with another tap on the center **SET** key of the right touch pad. The selected language packet will be loaded into the transmitter's memory.

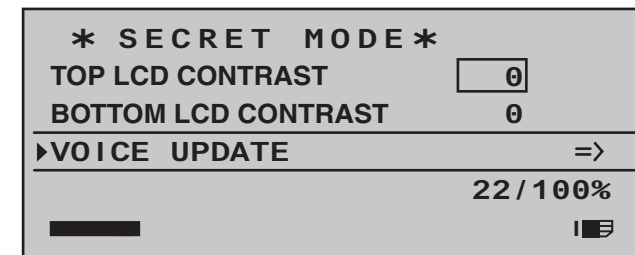

The loading process is finished as soon as the progress bar at the lower edge of the display disappears.

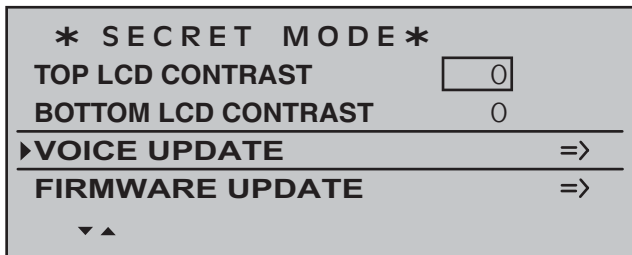

When this process is finished, switch off the transmitter. All settings stored in the transmitter remain intact after a change of language has been made.

Notes:

- If the warning ...



... appears, then the transmitter's RF radiation is still active. Jump to the »**Base setup model**« menu, select the "RF transmit" line, select its "OFF" option then repeat the procedure

- If the warning ...

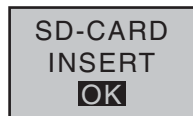

... appears then the transmitter does not detect a memory card in its card slot or the card found cannot be read.

- If the selection window is empty ...

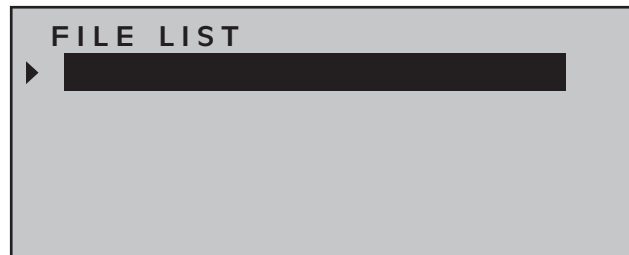

... then the transmitter could not find an appropriate file on the inserted memory card. Check the contents of the SD card's "VoiceFile" directory on a PC or laptop.

FIRMWARE UPDATE
Change display language

Important notice:

Be sure to check the charge status of your transmitter's battery or charge its battery as a precaution before every update. Also backup all occupied model memories so they can be restored if that should become necessary.

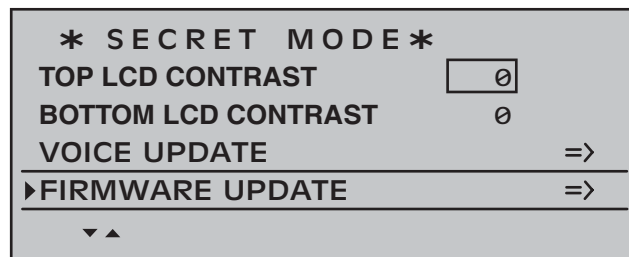

In the same manner as described above in the section "VOICE UPDATE", this menu item can be used to update or change the transmitter's firmware, including its display language. At the time of this manual's printing, the standard SD card delivered with the set includes the following languages:

- German
- English

A French, Italian and Spanish version are to be implemented at a later point in time. Appropriate updates and information can be found on the **MC-20** HoTT transmitter's product page under the Download link at www.graupner.de.

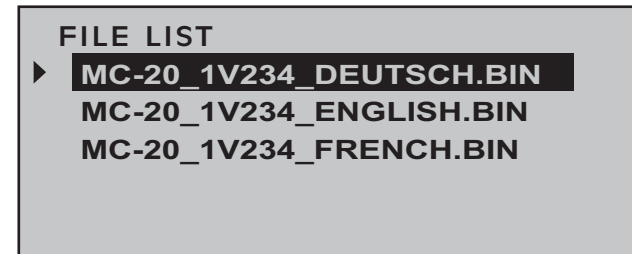

Now use the ▲▼ selection keys of the left or right touch pad to choose the desired firmware version, for example:

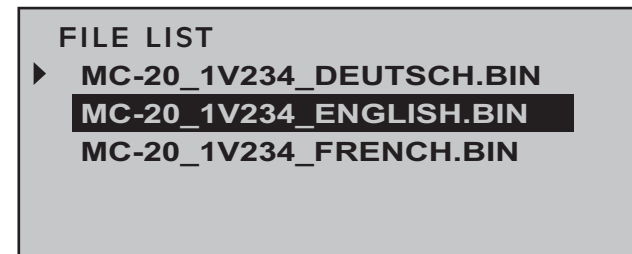

Confirm the choice with another tap on the center **SET** key of the right touch pad. The loading of firmware into the transmitter's memory will be started and following two displays, visible only very briefly, which only make reference to the firmware update ...

```

-----
* Firmware Download      *
* Prozess Start         *
* Please Wait....      *
-----

```

```

-----
* Boot Download         *
* Success!!!           *
* Please Wait....      *
-----

```

..., the message:

```

-----
* Firmware              *
* Downloading...        *
* Progress 023/275      *
-----

```

... will appear in the display. As soon as the counter to the left of the "/" character reaches the value shown on the right as the volume to be loaded, the message ...

```

-----
* Firmware Upgrade      *
* Success!!!           *
-----

```

... will appear. After a few seconds this message will be erased and the transmitter will automatically restart. The transmitter is now again operational.

Notes:

- If the warning ...



... appears then the transmitter does not detect a memory card in its card slot or the card found cannot be read.

- If the selection window is empty ...

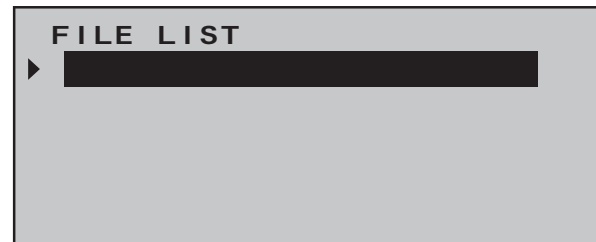

... then the transmitter could not find a suitable firmware file on the inserted memory card. Check the contents of the SD card's "Firmware" directory on a PC or laptop.

JOYSTICK CALIBRATION

If you feel the neutral position of your self-calibrating joysticks (controls 1 ... 4) are not exactly 0% of their control travel, then this can be checked and, if necessary, corrected as follows.

Jump to the »**Model select**« menu and initialize a free model memory as described on page 69. Whether the model to be initialized is a winged aircraft or a helicopter is irrelevant.

Wait for the notices which typically appear in the transmitter's base screen following a model change then jump to the »**Servo display**« menu, for example

by simultaneously touching the ◀▶ keys of the left touch pad (WITHOUT any interim changes to trim settings or other program settings).

If all four of your transmitter's joystick functions are still self-neutralizing, this display should ideally look like the one shown below.

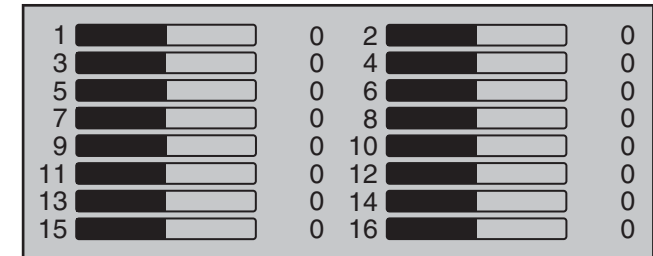

Otherwise the graph bars show current setting percentages for joystick control functions which are not self-neutralizing—typically for the "C1" throttle/brake or throttle/pitch joystick. For example, if the throttle/brake joystick is in its "quarter-throttle" position, the display would appear as shown below.

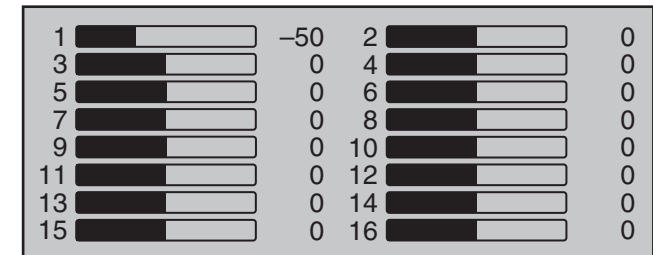

One after the other, put both joysticks into each of their four possible limit positions *without* exerting force at the limit position. In each of these eight possible limit positions, the—side dependent—indication for exactly -100% or +100% should be displayed. For example, if transmitter control 2 is at its right limit and the other three joystick functions are in their respective middle positions then the transmitter's display should look like the one shown below.

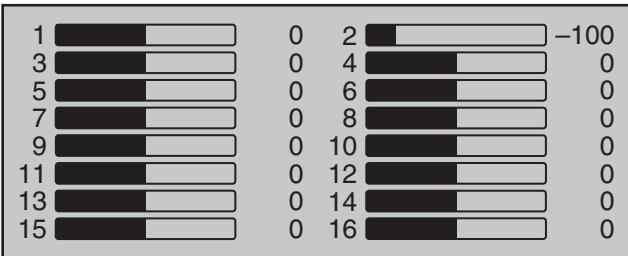

Regardless of the number of self-neutralizing joystick functions available on your transmitter, if these checks produce four 0% results and eight 100% results then your transmitter's joysticks are optimally calibrated. You can terminate this process then, if appropriate, delete the model memory just created. Otherwise jump (as described at the outset of the previous double page) to the "Stick calibration" line in the »**SECRET MODE**« menu then briefly touch the center **SET** key of the right touch pad.

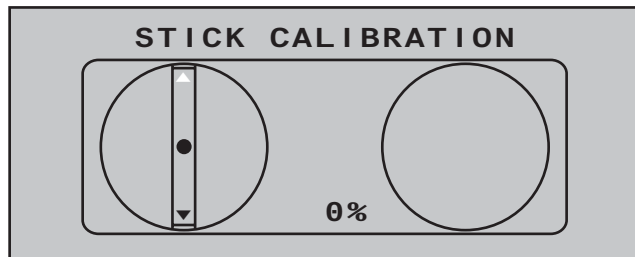

The ◀ ▶ selection keys of the right touch pad will now allow you to cyclically select the four calibrated joystick planes, e.g. the left/right plane of the right joystick.

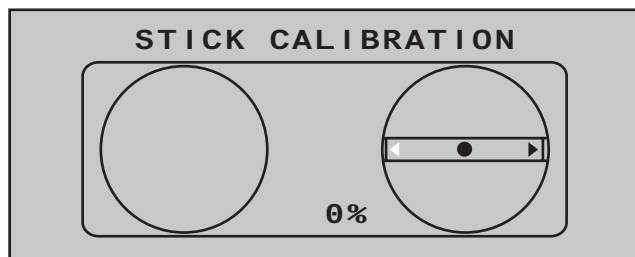

Now position the *right* joystick—without exerting extra force—to its left limit corresponding with the on-screen blinking arrow pointing to the left.

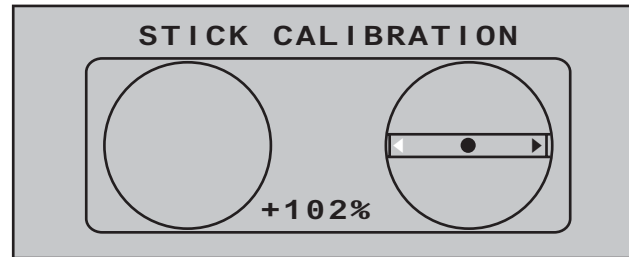

... and briefly tap the center **SET** key of the right touch pad. This concludes this example calibration of the right joystick's left limit. The circle in the middle of the stylized joystick plane will now blink as confirmation of the calibration.

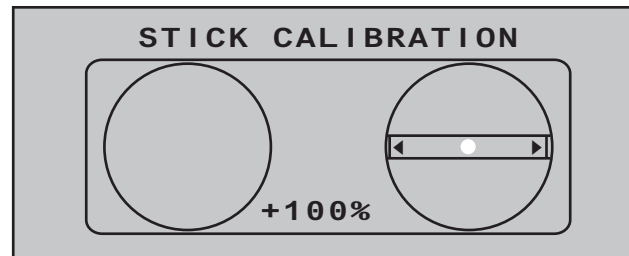

Now release the self-neutralizing joystick so it can return to its center position and then tap again on the center **SET** key to calibrate the joystick's centered position. The right triangle marker will begin to blink.

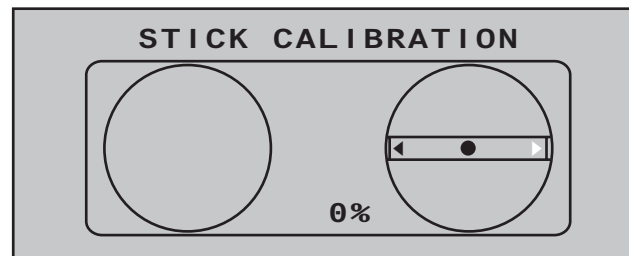

Repeat the calibration process for the *right* limit of the right joystick. The other joystick planes are calibrated analogously.

Proceed similarly to calibrate the three sliders mounted in the middle console and the two proportional rotary controls on the sides of the transmitter. The calibration options for these five proportional controls can be reached by repeatedly tapping on the ◀ or ▶ selection keys of the right touch pad until the desired calibration position is reached, e.g.:

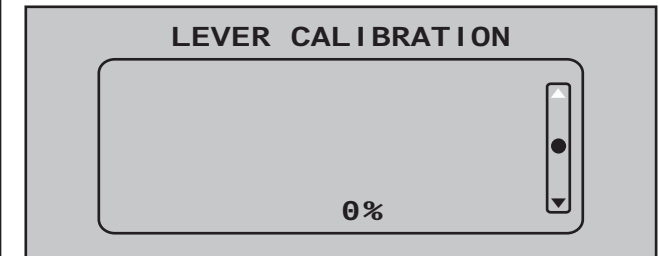

Notes:

- Correct any bad calibrations by repeating the respective process.
- Within a given joystick plane, each of the three calibration positions can be selected directly with the ▲ ▼ selection keys of the left or right touch pad.

Briefly touching the center **ESC** key of the left touch pad will terminate the process and return to the sub-menu "Stick calibration".

Telemetry data display

The **MC-20** transmitter has two independent displays; a large display for operating the transmitter and a smaller display just below the antenna socket for the graphic display of telemetry data. The telemetry display is activated automatically as soon as the transmitter receives telemetry data from the receiver via the return channel.

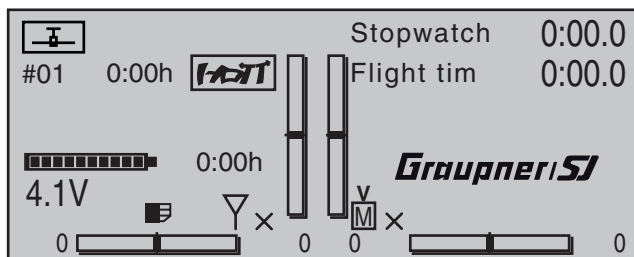

If however, at the lower edge of the base display, only "X"-as shown in the figure above—is displayed at two locations instead of "||||" then the telemetry display will show the warning ...



... which will be replaced shortly thereafter with the *Graupner/SJ* logo and the transmitter names ...



... to indicate there is no receiver with a responding telemetry connection within range. Switch on the model's receiver system or bind a receiver to the active model memory as described in detail on page 77 and 85.

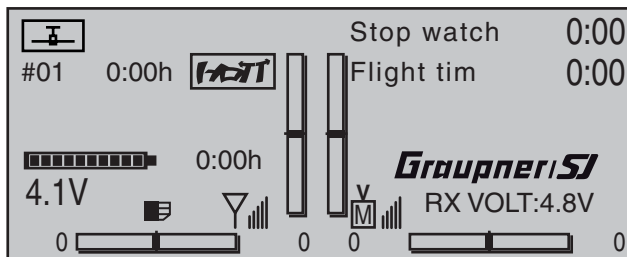

When a telemetry connection exists, the upper display will automatically present the "Receiver" screen ...

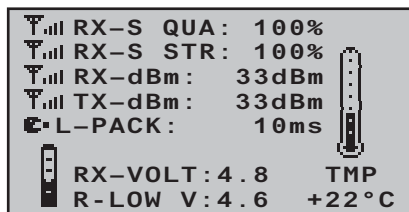

... which is described in more detail in a section by the same name on the next page.

Sensor Select

Up to four sensors can be connected, in any combination, to a telemetry-capable receiver. However, the data output by these sensors must be (as described on page 240) selected in the »SENSOR SELECT« sub-menu of the »Telemetry« menu ...

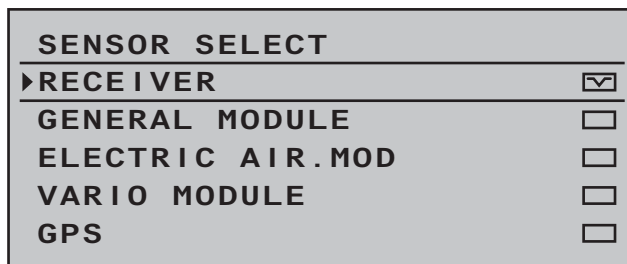

... in order to activate their display. This data from the selected sensors is then appropriately prepared for illustration by the graphic indicators as described below. Furthermore, only sensors activated in the »SETTING & DATAVIEW« sub-menu of the

»Telemetry« menu, beginning page 229, according to the instructions included with the given sensor will be responsive.

To switch between the screens for activated sensors in the »SENSOR SELECT« sub-menu of the »Telemetry« menu, tap briefly on one of the ▲▼ selection keys of the left or right touch pad ...

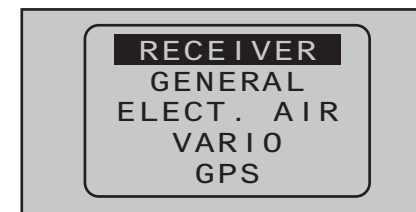

... and, after the selected screen has been displayed, use one of the ▲▼ two keys to select the line of the desired sensor. If no sensor is activated, then all display lines and sensors described in the next column, except for the "RECEIVER" line, are blended out of the display and the selection list:



The selection can be confirmed right away by activating the center **SET** key of the right touch pad or by simply waiting until, after a brief pause, the main display of the given selected sensor appears automatically.

Note:

The sequence of the below described displays is a consequence –starting from the given main display–of taps on the ► key.

More details about the following named modules can be found in the appendix and in Internet at

www.graupner.de in the web page for the given product.

RECEIVER

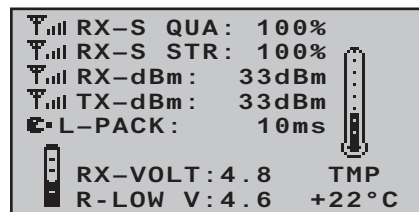

This screen presents the »RX DATAVIEW« of the Telemetry menu's »SETTING & DATAVIEW« sub-menu, see page 229, with data processed and displayed graphically.

The displayed items are as follows:

| Value | Explanation |
|----------|---|
| RX-S QUA | signal quality in % |
| RX-S ST | signal strength in % |
| RX-dBm | Reception power in dBm |
| TX-dBm | transmit power in dBm |
| V PACK | Indicates the longest time span in ms in which data packages are lost in the transmission from the transmitter to the receiver. |
| RX-VOLT | current operating voltage of the receiver's power supply in volts |
| M-RX V | Lowest receiver operating voltage since last startup, in volts |
| TMP | the thermometer depicts the receiver's current operating temperature |

GENERAL MODULE

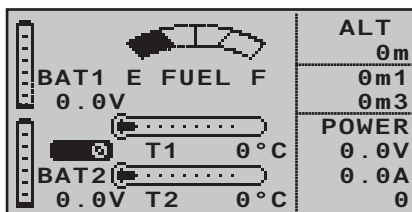
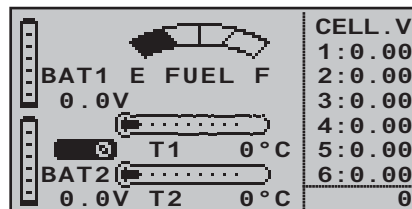
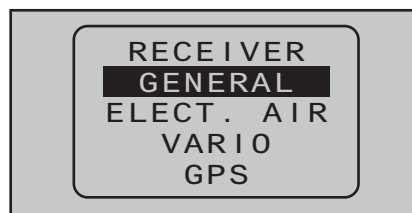

If attached to the receiver, this screen will display the data acquired by a General-Engine module, order no. **33610**, or a General-Air module, order no. **33611**. More details about these modules can be found in the appendix or in Internet at www.graupner.de in the web page for the given product.

Depending on how this module is equipped with sensors, this screen can permanently display the data shown in the table below.

The current voltage of up to two batteries (BAT1 and BAT2), the measurement results of up to two temperature sensors (T1 and T2) and a fill level gage for the fuel tank.

An alternating display along the screen's right edge will display a list of current cell voltages for a LiPo battery with up to six cells or operational data (current

altitude with respect to the starting location, ascent/decent m/1 s and m/3 s, current current being drawn in amperes and current voltage of the battery connected to the sensor).

The displayed items are as follows:

| Value | Explanation |
|-------------|------------------------------------|
| BAT1 / BAT2 | battery 1 or 2 |
| FUEL | fuel level / tank gage |
| E / F | empty / full |
| T1 / T2 | temperature of sensor 1 or 2 |
| CELL V | cell voltage of cells 1 ... max. 6 |
| ALT | current altitude |
| 0m1 | m/1 s ascent/decent rate |
| 0m3 | m/3 s ascent/decent rate |
| A | current draw i amperes |
| V | battery voltage |

Battery and load indicators

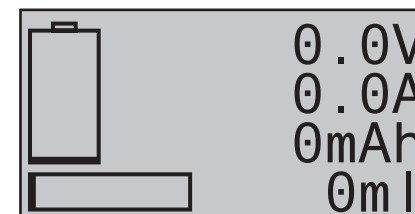

This display depicts current voltage, current current draw and, if attached, the expended capacity of "Batt 1" connected to the General-Engine module (order no. **33610**) or General-Air (order no. **33611**) module as well as the fuel consumed in ml.

SENSOR 1

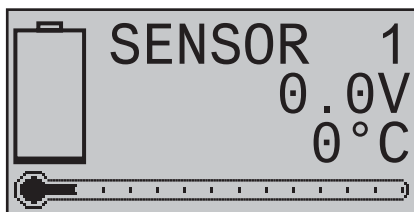

If attached, this display depicts currently measured voltage and temperature from a temperature/voltage sensor, order no. **33612** or **33613**, connected to "T(EMP)1" of the General-Engine module (order no. **33610**) or the General-Air module (order no. **33611**).

SENSOR 2

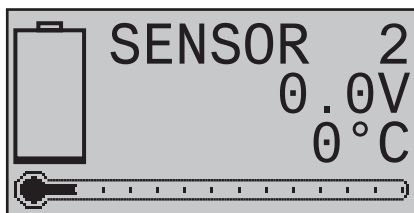

If attached, this display depicts currently measured voltage and temperature from a temperature/voltage sensor, order no. **33612** or **33613**, connected to "T(EMP)2" of the General-Engine module (order no. **33610**) or the General-Air module (order no. **33611**).

Rotary speed sensor

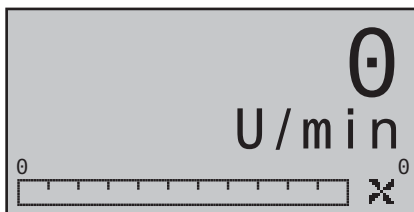

If attached, this display depicts the measured rotary speed of a speed sensor (order no. **33615**

or **33616**) attached to a General-Engine module (order no. **33610**) or a General-Air module (order no. **33611**).

Note:

The appropriate blade count must first be set in the module's telemetry menu before the correct speed can be displayed.

Vario



If attached, this display will depict the altitude (in m) relative to location, starting location as well as the current rate of ascent/descent (in m/s) data originating from a Vario integrated into a General-Engine module (order no. **33610**) or General-Air module (order no. **33611**).

ELECTRIC AIR MODULE

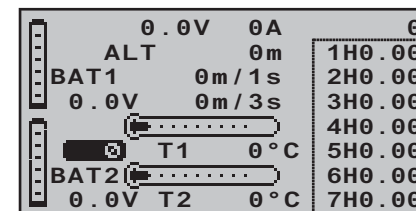
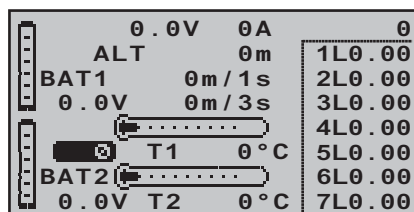
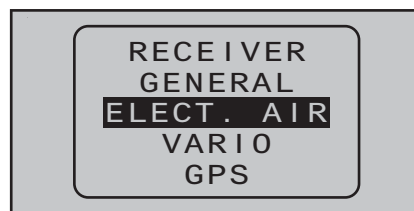

If attached to the receiver, this display will depict the data acquired by an Electric-Air module, order no. **33620**. More details about this module can be found in the appendix or in Internet at www.graupner.de in the web page for the given product.

Depending on how this module is equipped with sensors, this screen can permanently display the data shown in the adjacent table.

The current voltage of up to two batteries (BAT1 and BAT2), up to two temperature measurements (T1 and T2), current altitude with respect to the starting location, the model's ascent/decent rate in m/1 s and m/3 s and, in the middle of the screen, the current draw currently being taken from a power source.

Along the right edge of the screen is a table of alternating values for cell voltages at balancer connections (L) or voltages for up to 7 attached battery cell packs (H).

The displayed items are as follows:

| Value | Explanation |
|-------------|------------------------------|
| V | current voltage |
| A | current current |
| BAT1 / BAT2 | battery 1 or 2 |
| ALT | current altitude |
| m/1 s | m/1 s ascent/decent rate |
| m/3 s | m/3 s ascent/decent rate |
| T1 / T2 | temperature of sensor 1 or 2 |

L or H
 cell voltage of cells 1 ... max. 14
 L = balancer connection 1
 H = balancer connection 2

AKKU 1

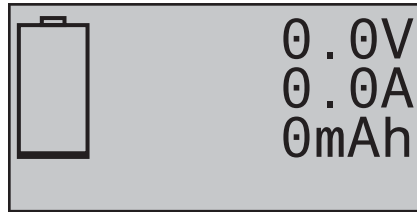

This display depicts current voltage, current current draw and, if attached, the expended capacity of "Batt 1" connected to the Electric-Air module (order no. 33620).

SENSOR 1

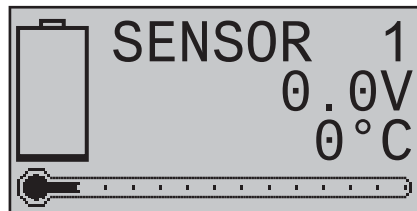

If attached, this display depicts currently measured voltage and temperature from a temperature/voltage sensor (order no. 33612 or 33613) connected to "T(EMP)1" of the Electric-Air module (order no. 33620).

SENSOR 2

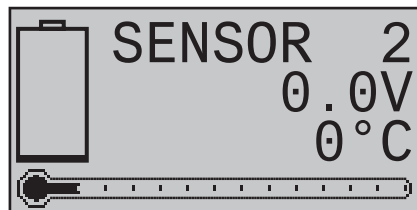

If attached, this display depicts currently measured voltage and temperature from a temperature/voltage sensor (order no. 33612 or 33613) connected to "T(EMP)2" of the Electric-Air module (order no. 33620).

Vario

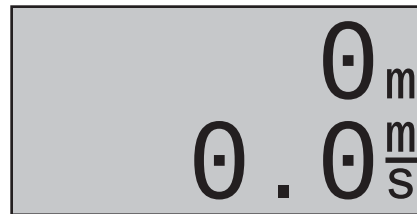

If attached, this display will depict the altitude (in m) relative to location, starting location as well as the current rate of ascent/descent (in m/s) data originating from a Vario integrated into a Electric-Air module (order no. 33620).

VARIO

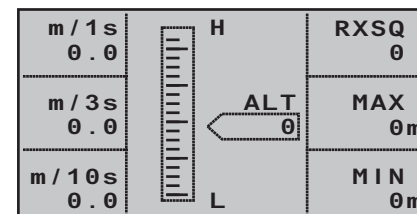
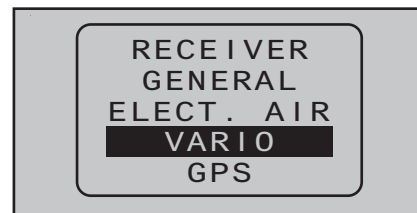

If attached to the receiver, this display will depict the data acquired by a Vario module, order no. 33601. The displayed items are as follows:

| Value | Explanation |
|--------|--|
| ALT | current altitude |
| RXSQ | Signal strength of the signal received by the receiver in%, see page 230. |
| MAX | the preset maximum altitude limit relative to starting location at which, when exceeded, will cause an audible warning to be sounded |
| MIN | the preset minimum altitude limit relative to the starting location at which, when underrun, will cause an audible warning to be sounded |
| m/1 s | m/1 s ascent/decent rate |
| m/3 s | m/3 s ascent/decent rate |
| m/10 s | m/10 s ascent/decent rate |

Vario



If attached, this display will depict altitude relative to location or starting location (in m) as well as the current rate of ascent/descent (in m/s) from data acquired by a Vario module (order no. 33601).

GPS

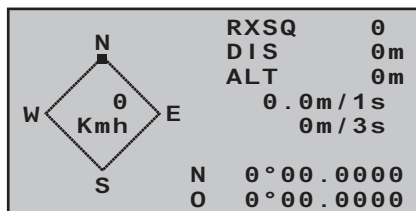

If attached to the receiver, this display will depict the data from a GPS module with integrated Vario, Order No. **33600**.

Aside from the model's current position and speed, the center section of this screen will also display current altitude with respect to the starting location as well as the model's current ascent/decent rate in m/1 s, m/3 s and m/10 s, current reception quality and the model's distance from its starting location.

The displayed items are as follows:

| Value | Explanation |
|---------|---|
| W/N/O/S | west / north / east / south |
| Kmh | speed |
| RXSQ | return channel signal strength |
| DIS | distance |
| ALT | current altitude with respect to starting |
| m/1 s | m/1 s ascent/decent rate |
| m/3 s | m/3 s ascent/decent rate |
| m/10 s | m/10 s ascent/decent rate |

GPS

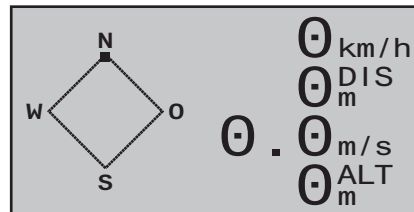

If attached to the receiver, this display will depict the data from a GPS module with integrated Vario, Order No. **33600**.

The displayed items are as follows:

| Value | Explanation |
|-------|---|
| km/h | speed |
| DIS | horizontal distance in m |
| m/s | ascent/decent rate in m/s |
| ALT | altitude relative to starting location in m |

Vario



If attached, this display will depict the altitude (in m) relative to location, starting location as well as the current rate of ascent/descent (in m/s) from data originating from the Vario integrated into the GPS-/Vario module (order no. **33600**).

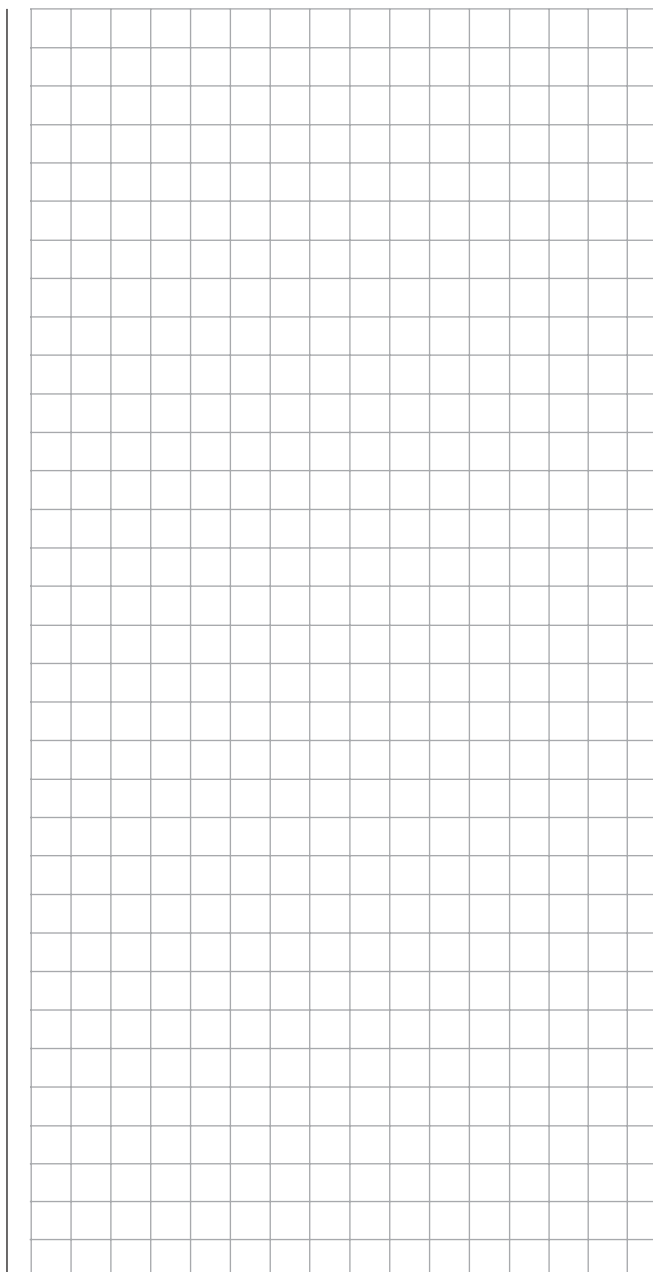

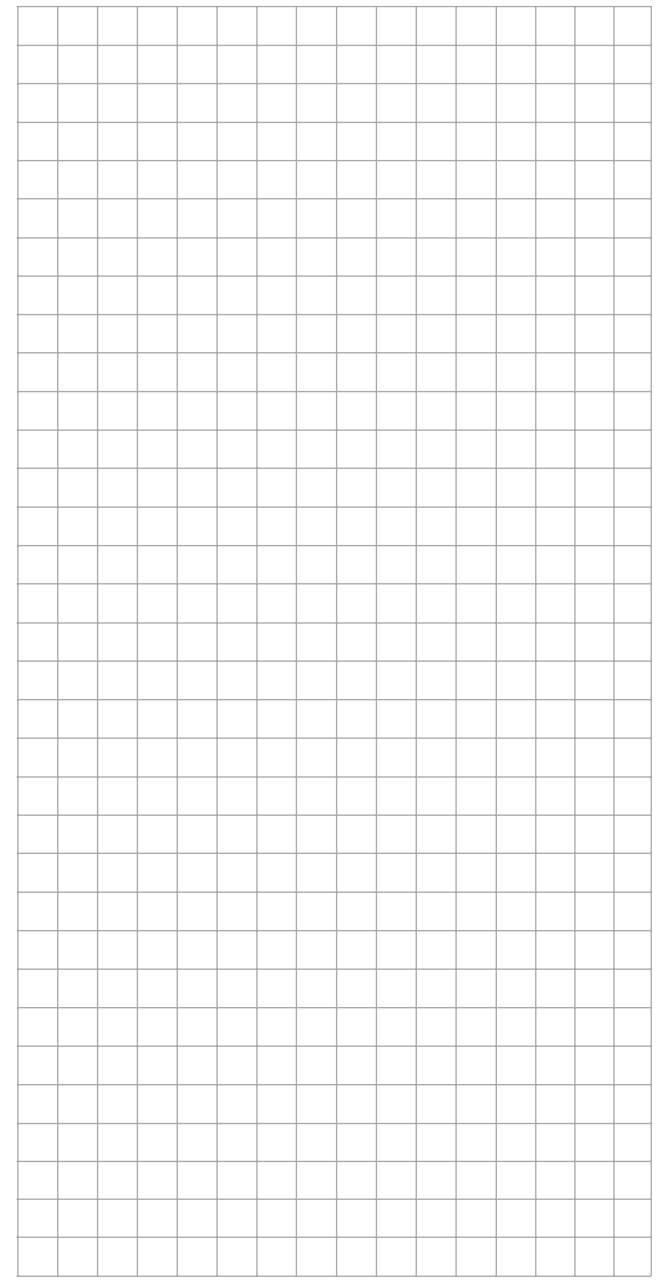
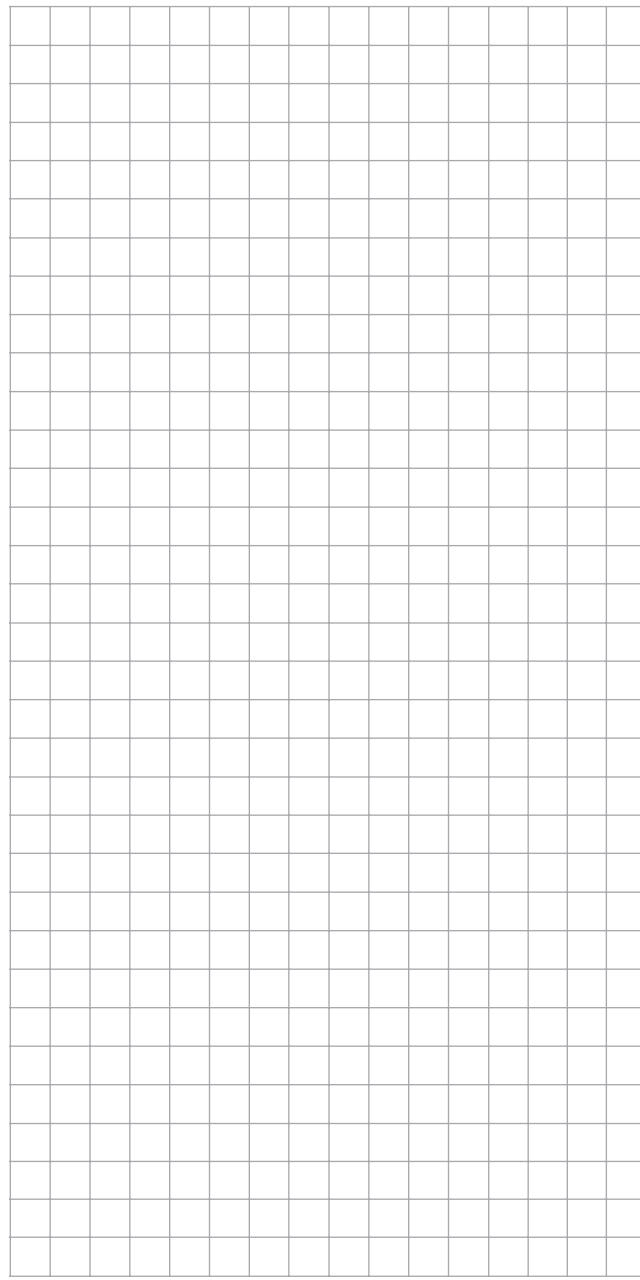
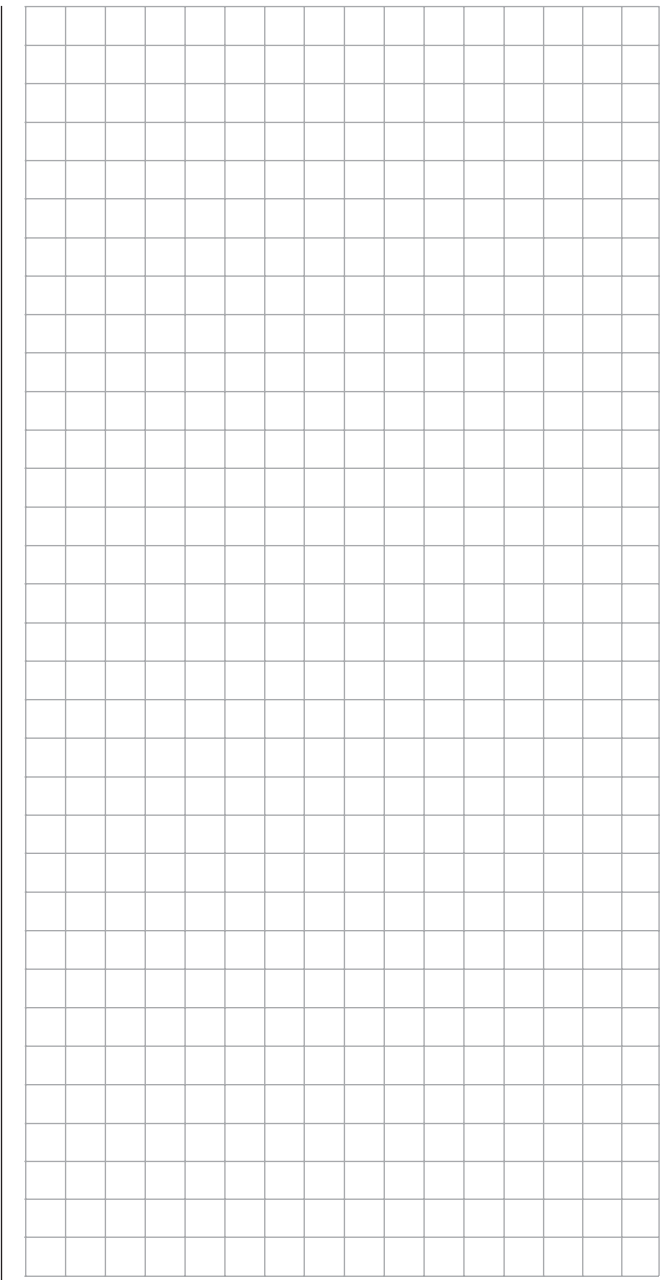

Commissioning the transmitter

Preliminary remarks about the **MC-20** HoTT transmitter

Preliminary remarks

The *Graupner* HoTT system theoretically permits simultaneous operation of more than 200 models. However, because of the interspersed radio-frequency utilization permitted by certification for the 2.4 GHz ISM band, this number is significantly lower in practical application. Nevertheless, in general more models can be operated simultaneously in the 2.4 GHz band than would be the case in conventional 35 or 40 MHz frequency bands. The real limiting factor is—as often before— is still likely to be the size of available operating space (i.e. airspace for aircraft). Alone the fact that it is no longer necessary to coordinate transmitting frequencies with other pilots in the vicinity (which is sometimes quite difficult in broken landscapes, such as on hillside slopes) represents an enormous boost for remote control operating security.

Battery charged?

Since the transmitter is delivered with an empty (not charged) battery, the battery must first be charged according to the charging instructions on page 16. Otherwise a warning tone will be sounded and an appropriate message will be blended into the basic display if the low voltage threshold set in the "Battery warning" line of the »General basic settings« menu (see page 260) is underrun.

Batt. must be re-charged!!

Transmitter startup

After being switched on, the message shown below will appear in the transmitter's screen for about two seconds.

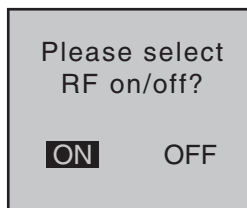

Within this brief period there is an opportunity to switch RF transmission off by using the ▲ or ► key of the right touch pad to shift the position of the field shown in inverse video to the right so that **ON** is in standard video and **OFF** is presented in inverse video.

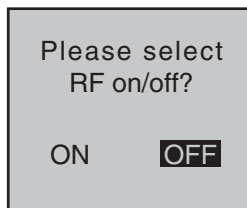

Now switch the RF module off by tapping on the center **SET** key of the right touch pad. The telemetry display just below the antenna socket will then briefly show the message ...



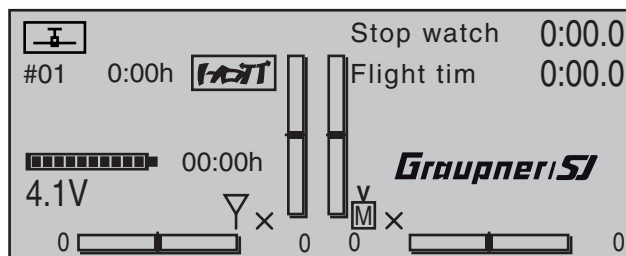

... and in parallel to this, the transmitter's basic display will appear similar to that shown below:



The symbol combination  means that the currently active model memory has already "bonded" with a

Graupner-HoTT receiver but there is no connection to that receiver at the moment. (In this example, RF transmission has been switched off.)

If, however, the transmitter is switched on *without* switching RF transmission off, the symbolic antenna mast will blink. At the same time, an acoustic warning will sound until a connection is established with the respective receiver. As soon as the connection is established, the "X" at the base of the symbolic antenna will be replaced with a field strength indicator, for example , and the visual and acoustic warnings will cease.

If a telemetry connection has also been established for the incoming signal, that is output by the receiver in the model, then the right side of this same screen line will display a similar indication of signal strength for this reception of the receiver's transmitted signal (M ) as well as the current voltage of the receiver's power supply.

On the other hand, if the symbol combination  appears in the display and the front display shows the message "Can't receive data" then the currently active model memory is not "bonded" to any receiver at the moment.

Under-voltage warning

If the transmitter's voltage drops below a certain value set in the »General basic settings« menu (page 260), 4.7 V by default, there will be visual and acoustic under-voltage warnings issued.

Important notices:

- **The transmitter in the set is already preset, as delivered, with default values which are correct for operation in most European countries (except France).**
If the remote control system is to be operated in France then the transmitter's "Region" setting MUST be changed over to "FRANCE" mode, see page 261. IN NO CASE may the

Transmitter firmware updates

Universal/EUROPE mode be used IN FRANCE.

- **As many as 16 servos can be attached to the standard receiver included with the 01C-20 HoTT 2.4 Set. The specific receiver included in the set has already been bound to the set's transmitter at the factory.**
In order to achieve the greatest possible flexibility but still preclude unnecessary inadvertent operator errors, control channels 5 ... 16 have not been assigned to any controls. This means that servos connected by way of these channels will remain in their middle positions until an operator element has been assigned. Practically all mixers are initially inactive for this same reason. More about this can be found on page 108 (winged aircraft) or 112 (helicopter models).
- **The fundamental procedure for initial programming of a new model memory location can be found on page ?? and the programming examples that begin on page 268.**
- **When the remote control system is switched on, being bonded or when making settings, that the transmitter's antenna is always far enough away from the receiver's antennas. If the transmitter's antenna is brought too close to the receiver's antennas this will cause receiver over-modulation and its red LED will illuminate. At the same time the return channel will drop out and, as a consequence, the field strength indicator in the transmitter's screen will be replaced by an "x" and the receiver's current battery voltage display will show 0.0 V. The remote control is then in Fail-Save mode, see page 208, i.e. servos will remain in their current positions until a new, valid signal can be received. In such a case, increase the distance (between the transmitter and the model containing the receiver) until the indicators are again "normal".**

Transmitter firmware updates are carried out either as described under "FIRMWARE UPDATE / Change display language" in the section »**Secret mode**« on page 33 or as described below with the help of a PC running a Windows XP, Vista or 7 operating system. This second method connects the transmitter to the PC via its 5-pole mini-USB interface connector, located behind the transmitter's left front cover –as viewed from the front– and, if this method is chosen, it is done at one's own risk. Current software and information is available in Internet at www.graupner.de under the Download link for the given product.

Note:

You will automatically be notified of new updates per email after registering your transmitter at <https://www.graupner.de/de/service/produktregistrierung>.

The aforementioned "given product page" is most easily reached by entering "www.graupner.de" into your Internet browser's address line then pressing the ENTER key on your PC or laptop keyboard.

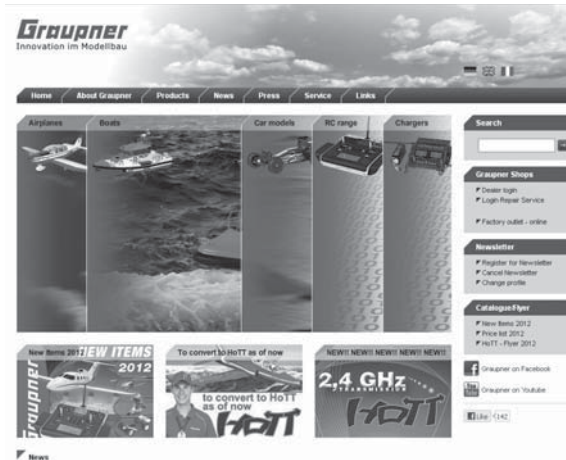

On the so-called "homepage" for *Graupner*, click on one of the "flags" to switch the website to a language of your choice, e.g. the British flag for English. Afterwards locate the entry field with the title "Search".

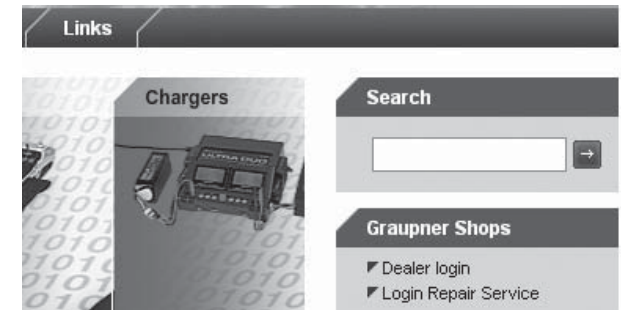

Place the cursor in this field with a mouse click then enter a search keyword, e.g. the article number printed on the type plate located on the rear side of the transmitter.



Another press of the ENTER key on the PC or laptop will open the sought page:



Now use your Internet browser's vertical scroll bar to move down the page a bit until the tabs "Characteristics", "Spare parts", "Accessories" and "Downloads" appear. Because the "Downloads" tab is still missing on the **MC-20** HoTT transmitter's page at the time of this manual's printing:



Now search here for the necessary file/s and start the download with a double-click on the "Download" control button beneath the selected file.



Store the file on your computer in a directory of your choice.

Updating MC-20 HoTT software

The USB interface cable, order no. **7168.6** (included with the set), will be needed to update the transmitter's software via the transmitter's face-side USB interface connector. This cable's connector is to be directly plugged into the 5-pole mini-USB connector socket on the rear side of the transmitter.

Note:

Be sure to check the charge status of your transmitter's battery or charge its battery as a precaution before every update. Also backup all occupied model memories so they can be restored if that should become necessary.

1. Installing drivers

Install the required driver software, included in the "USB Drivers" folder of the program packet, onto your PC or laptop so your computer can handle the transmitter's integrated USB interface.

Start driver installation with a double-click on the respective file and follow the on-screen instructions. Once this software has been successfully installed, the computer must be re-started. Drivers only need to be installed once.

2. Installing the software up-loader

Unpack the file "Firmware_Upgrade_grStudio_Ver-XX.zip" in a suitable directory then execute the "Firmware_Upgrade_grStudio_Ver-XX.exe" program file with a double-click on its filename. Follow the instructions provided by the installation wizard.

3. Establishing a transmitter-to-PC connection

With the transmitter switched off, connect the USB cable by way of its 5-pole mini-USB socket to

the rear side of the transmitter.

4. Updating MC-20 HoTT transmitter software

Start the "Firmware_Upgrade_grStudio_Ver-X.X" program from the directory where it is located.

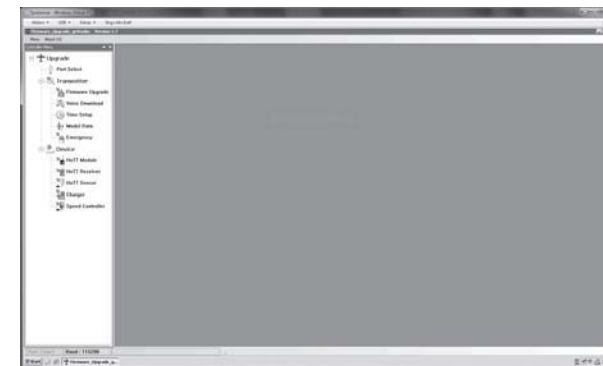

Use the selection sequence "Menu", "Port Setup" or open the "Controller Menu" and click on "Port select".

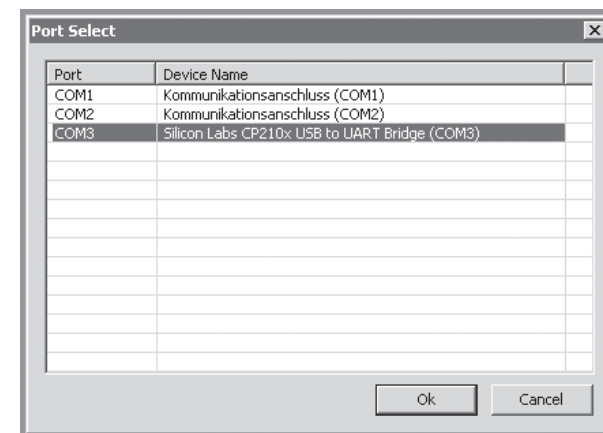

Now in the "Port select" window, select the COM port connected to the USB interface. The correct port can be recognized by its designation "Silicon Labs CP210x USB to UART Bridge" in the "Device Name" column. In the above example this would

be the "COM 3" port.

Now call up menu option "Firmware Upgrade" from "Menu" or open the "Controller Menu" and click on "Firmware Upgrade".



Click on the button labeled "File Browse" and select the desired firmware update file with a ".bin" filename extension from the "Open file" window. Firmware files are product-specifically coded, i.e. if you should accidentally select a file which does not correspond to the product (e.g. receiver update file instead of a transmitter update file), the "Product code error" popup window will appear and the block the update process from starting. Now switch on the transmitter then start the transmitter update by clicking on the "Download Start" button.

After a brief period a warning will appear stating that the transmitter's RF transmission will now be interrupted and that, because of this, any receiver system currently in operation should be switched off. Switch off your receiver system if it is switched on then click on "Yes".



This will start the actual update process. A progress bar will begin to operate above a sequence of running text lines.



Do not terminate the update process before the progress bar has reached its right end and the "Firmware Download Success" message appears.



Click on "OK". Subsequently switch off the transmitter and disconnect the USB cable between the transmitter and the PC or Laptop. If the progress bar hangs up without showing any further progress, close the program and repeat the update process. Be sure to watch for any error messages that may appear.

Receiver initialization

Preliminary remarks about the GR-32 DUAL receiver

Receiver system

The **MC-20** HoTT remote control set includes a type GR-32 DUAL, 2.4 GHz bidirectional receiver for connecting up to 16 servos.

After switching on this HoTT receiver, should "its" transmitter not be within range or switched off, then the receiver's red LED will illuminate continuously for about 1 s then begin to blink slowly. This indicates the receiver has not (yet) established a link to a *Graupner* HoTT transmitter. If a link has been established, the green LED will illuminate continuously and the red LED will extinguish.

In order to establish a link to the transmitter, the *Graupner* HoTT receiver must first be "bound" to "its" particular model memory in "its" *Graupner* HoTT transmitter. This procedure is known as "binding". This "binding" linkage is only necessary once for each receiver/model memory combination. Refer to pages 77 or 85. The "binding" procedure has been done at the factory for model memory 1 of the units delivered together as a set so this "binding" procedure will only be necessary to link additional receivers or if a memory location change becomes necessary (and – e.g. after a change of transmitter – can be repeated anytime).

On-board voltage display

The current voltage of the receiver's power supply will be shown in the right side of the transmitter's screen if a telemetry link exists between the receiver and transmitter.

Temperature warning

Should the receiver's temperature sink below an adjustable threshold (default value -10 °C) or rise above an adjustable threshold (default value +55 °C), an acoustic warning will be issued by the transmitter in the form of a uniform beep of about 1 s duration. The aforementioned threshold limits are stored and adjusted in the receiver.

Servo connections and polarity

Graupner HoTT receiver servo connections are numbered. The connectors used are keyed against polarity reversal. Pay attention to the small side chamfers when plugging in these connectors. Never use force.

The four outer, vertical connectors, designated with "B + -" are intended for battery connections.

Do not reverse the polarity of this connection. Reversed polarity could destroy the receiver and devices attached to it.

The supply voltage is bussed across (i.e. common for) all numbered connections. The function of every individual channel is determined by the transmitter used, not by the receiver. It is not only the throttle servo connection which is different for every manufacturer and model type. For example, in *Graupner* remote control systems the throttle servo is on channel 1 for winged aircraft and on channel 6 for helicopter models.

Concluding notices:

- *The significantly greater servo resolution characteristic of the HoTT system produces a noticeably firmer response behavior in comparison to previous technology. Please take the time to familiarize yourself with this sensitive behavior.*
- *If you have a speed controller with integrated BEC* arranged in parallel with the receiver battery, its positive pole (red cable) may be removed from the 3-pole connector. Be sure to look for notices about this in the instructions for the speed controller used.*

With a small screwdriver, carefully lift up the the connector's center latch (1) just a bit then pull out the red lead (2) and tape it up with insulation tape to prevent possible short circuits (3).

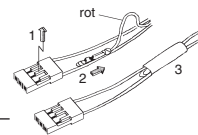

* Battery Elimination Circuit

Follow the installation instructions on page 52 for the receiver, the receiver antenna and for mounting the servo.

Reset

To execute a reset of the receiver, press and hold the **SET** button on the receiver's top-side while switching the power supply on.

If a receiver reset is done while the transmitter is switched off or on a receiver which is not bound, the receiver's LED will slowly blink red for about 2 or 3 seconds. Now release the button again. The binding process can now be initiated right away on the transmitter-side.

If reset is done on a bound receiver and the corresponding model memory is active in the powered on transmitter, the LED will illuminate in green after 2 or 3 seconds as an indication that the transmitter/receiver system is again ready for operation. Now release the button again.

Please note the following:

A receiver RESET will cause ALL receiver settings, except for binding information, to return to their factory settings.

Therefore if a RESET is triggered unintentionally, any custom settings that had been present in the receiver before the reset will have to be established again by way of the Telemetry menu.

A deliberate RESET is recommended, especially if a receiver is to be "transferred" into another model. This is a rather simple method to eliminate settings which are no longer applicable.

Receiver power supply

Receiver power supply

Among other aspects, the safe operation of a model depends on a reliable power supply. In the event that, despite smooth operating rods, fully charged battery, battery leads with adequate cross-section, minimum contact resistances at connectors, etc., the transmitter indicates repeated receiver voltage collapses or is receiver voltage is generally too low; please give attention to the following notices.

Give primary attention to fully charged batteries when model operation is to be started. Be sure that the contact surfaces of connectors and switches really are low resistance. If necessary, measure the voltage drop across installed switch cables when they are under load because even new heavy-duty switches can cause a voltage drop of up to 0.2 V. This value can increase in contacts by factors as a consequence of aging and oxidation. The constant vibrations and jarring also takes its toll on contacts to produce a creeping increase of contact resistance.

Servos present another possible problem source. Even rather small servos like a *Graupner/JR DS-281* can draw up to 0.75 A of current when it is blocks under load. Just four of these servos in a "foam" model can therefore load down the on-board power supply by as much as 3 A ...

Therefore you should choose a power supply which will not break down under greater loads but rather always deliver sufficient voltage. To "calculate" necessary battery capacity you should always figure on at least 350 mAh for every analog servo and at least 500 mAh for every digital servo.

For example, from this point of view a battery with 1400 mAh would be the absolute minimum to power a receiver system with a total of 4 analog servos. But be sure to also consider the receiver itself into the calculation because its bidirectional functionality will draw about 70 mA of current too.

In any case, it is recommended that several of the six

available connections designated "- +/B" be used for the supply of power. (These connections are ONLY intended for battery connections.)

Connect the power supply preferably by way of the socket/s which are close to connectors of attached servos. Where only high-power servos are connected, it may be necessary to use all receiver battery connections to connect as many as three PRX receiver power supplies (depending on battery power). Even where only two batteries are used via 1 PRX it is preferable to use the receiver connections closest to the servos which draw the most current. The figure below shows an example of a stabilized receiver power supply (PRX-5A, order no. **4136**) for the connection of two batteries. As an alternative solution, a switch could be inserted with power supply cables to two receiver connectors. Such a double connection not only reduces the risks associated with a cable break but also ensures a more uniform supply of power to attached servos.

If a separate battery is connected to each receiver battery connection, be absolutely sure the batteries have the same voltage and power rating. Never connect different battery types or batteries charged to significantly different levels to the receiver. This can lead to effects similar to short circuit conditions. In such cases, insert voltage stabilizers, such as the PRX-5A receiver power supply, between the batteries and the receiver.

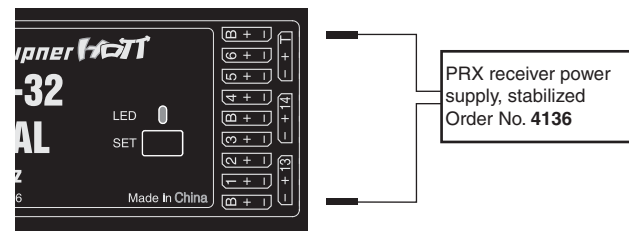

For reasons of safety, do not use battery boxes or dry cell batteries.

The voltage of the on-board power supply will be displayed at the bottom right of the transmitter's screen while the model is in operation.

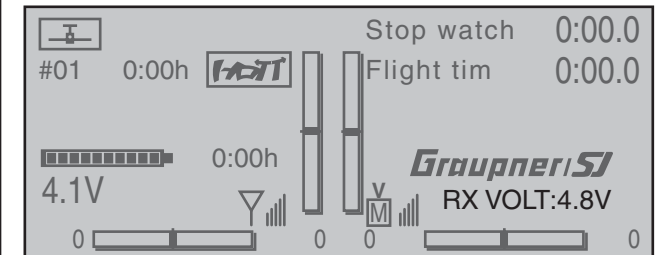

If the adjustable warning threshold (default value 3.60 V) set in the Telemetry menu, see page 260, is underrun, a visual and an acoustic under-voltage warning will be issued.

Despite this feature, be sure to check the condition of the battery at regular intervals. Do not wait for the warning to be issued before recharging the battery.

Note:

An overview of available batteries, chargers and current source test instruments can be found in the Graupner RC main catalog or in Internet at www.graupner.de. A selection of suitable Compter chargers are listed in the table on page 17.

Receiver system power supply

NiMH 4-cell battery packs

In compliance with the aforementioned conditions, your *Graupner* HoTT receiver system can be readily operated with traditional 4-cell battery packs as long as the packs have adequate capacity and voltage level.

NiMH 5-cell battery packs

Five-cell battery packs offer a greater voltage tolerance than do 4-cell packs.

However, be aware that not every servo available on the market is able to tolerate the voltage level output by a 5-cell pack over the long term, this is particularly true when the battery pack is freshly charged. Some of these servos react to this with a noticeable "grinding" sound.

Therefore pay attention to the specifications of the servos you use before making a choice for a 5-cell battery pack..

LiFe 6.6 V batteries with 2 cells

From a contemporary perspective, these new cells are the very best choice.

LiFe cells are also available in hard plastic casings to protect them from mechanical damage. Like LiPo cells, LiFe cells can be quick charged in suitable chargers and they are comparatively robust.

This type of secondary cell battery is also rated for a significantly greater number of charge/discharge cycles than, for example, LiPo batteries. The nominal 6.6 V output of a 2-cell LiFe battery pack does not present a problem for either *Graupner* HoTT receivers nor for those servos, speed controllers, gyros and other devices which have been specifically approved for operation in this—higher—voltage range.

Please note however that practically all servos, speed controllers, gyros and other devices built in the past and most such devices currently still offered on the market have only a permissible voltage range of 4.8 to 6 V. Use of these batteries in conjunction with these devices demand use of

a stabilized voltage regulator, e.g. the PRX, Order No. **4136**, see appendix. Otherwise there is danger that attached devices will incur damage within a short period of time.

LiPo 2-cell packs

For a given capacity, LiPo batteries are lighter than, for example, NiMH batteries. LiPo batteries are also available in hard plastic casings to protect them from mechanical damage.

The comparatively high nominal voltage, 7.4 V, for a 2-cell LiPo pack does not present a problem for either *Graupner* HoTT receivers nor for those servos, speed controllers, gyros and other devices which have been specifically approved for operation in this—higher—voltage range. **Please note however that practically all servos, speed controllers, gyros and other devices built in the past and most such devices currently still offered on the market have only a permissible voltage range of 4.8 to 6 V.** Use of these batteries in conjunction with these devices demand use of a stabilized voltage regulator, e.g. the PRX, Order No. **4136**, see appendix. Otherwise there is danger that attached devices will incur damage within a short period of time.

Charging the receiver battery

Charger cable, order no. **3021**, can be plugged directly onto the receiver's battery for charging. If the battery in the model is connected by way of an order no. **3046, 3934, 3934.1** or **3934.3** power supply cable, then charging can be accomplished via the charging jack or special charging connector integrated into the switch. The switch in the power supply cable must be in its "OFF" position for charging.

Receiver battery connection polarity

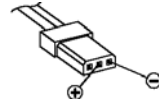

General charging notices

- The charging instructions for the charger as well as for the battery from its manufacturer to be observed.
- Pay attention to the maximum permissible charging current specified by the battery's manufacturer. In order to prevent damage to the transmitter, charging current should never exceed 1 A. If necessary, limit the current at the charger.
- If the transmitter battery is nevertheless to be charged at a current rate in excess of 1 A, then it is imperative that this is done outside the transmitter. Otherwise there is a risk of damage to the transmitter's board due to overloading its printed circuit paths and/or overheating of the battery.
- If an automatic charger is to be used for charging, perform several test charging procedures to ensure the flawless functionality of its automatic shut-off. This applies particularly if you want to charge the standard installed NiMH battery with an automatic charger unit intended for NiCd batteries Monitor the charger's shut-off behavior if it has that option.
- Do not execute a battery discharge or battery maintenance program through the charger jack. The charger jack is not suitable for this purpose.
- Always connect the charger cable to the charger first and then to the receiver or transmitter battery. This avoids the possibility of shorting the bare banana plug ends together.
- If the battery heats up significantly, check the battery's condition, replace the battery or reduce the charging current.
- **Never leave a charging battery unattended.**
- **Follow the safety notices and handling instructions provided on page 7.**

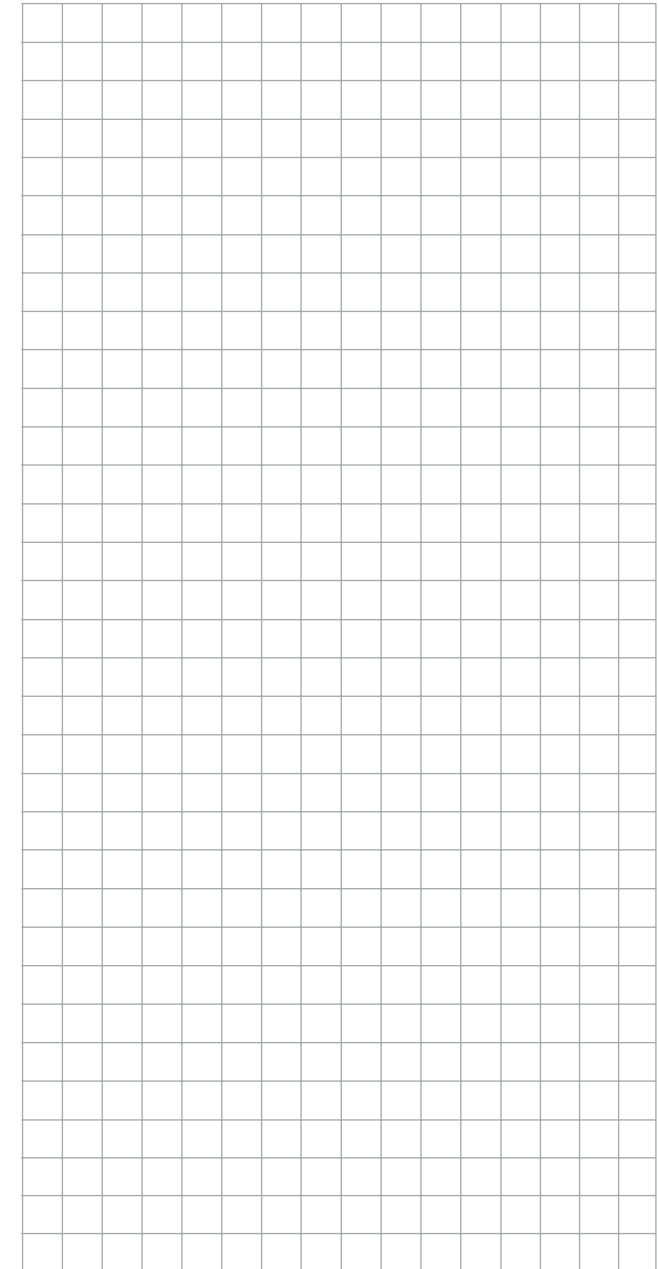
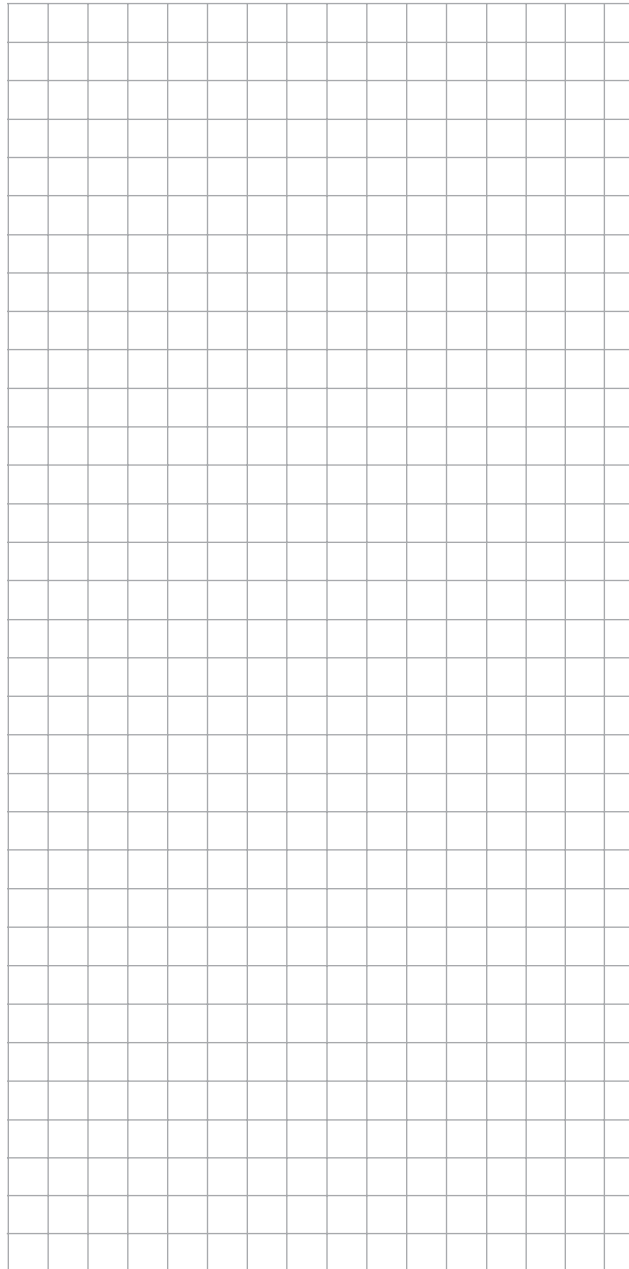

Receiver firmware updates

Receiver firmware updates are made by way of the connector located on the side of the receiver and the help of a PC running under Windows XP, Vista or Windows 7. The optional USB interface cable needed for this is order no. **7168.6** along with adapter cable, order no. **7168.6A**. The programs and files also needed can be found in Internet on the Graupner website at www.graupner.de under the downloads for the particular product.

Note:

After registering your receiver at <https://www.graupner.de/de/service/produktregistrierung>, you will automatically receive notification of future updates per email.

Updating receiver firmware

Note:

Before any update procedure, be sure to check the charged status of the receiver's battery. If necessary, charge the battery before beginning with an update.

1. Installing drivers

If not already done, install the required driver software for the USB interface, order no. **7168.6**, as described on page 43.

2. Establishing a receiver / PC connection

Connect the USB interface cable, order no. **7168.6**, via the adapter cable, order no. **7168.6A**, with the "- + T" connector on the receiver. These connectors are protected against polarity reversal so pay attention to the small chamfers on the sides of connectors. Do not use brute force, these connectors should latch in rather easily.

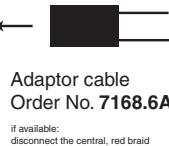
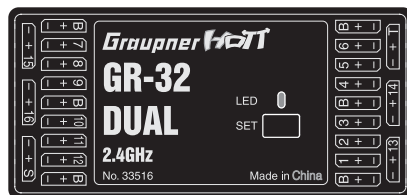

If available, disconnect the central, red braided

Caution:

If the adapter cable is still has wires for all three poles, cut the red insulated wire for the middle connector pin of the adapter cable, Order No. 7168.6A.

Afterward, connect the USB interface with the included USB cable to the PC or laptop (PC USB/mini-USB interface connector). A red LED on the interface board should illuminate for a few seconds even though the connection is made correctly.

If not already off, now switch the receiver off.

3. Firmware update utility program

On the PC, start the "Graupner_Firmware_Update_Utility_VerX.XX.exe" program with a double-click. This program is located among the files in the "Firmware-Updater" folder. (At the time of printing for this manual, this program's current version is 1.18 and it can be started without first being installed.)

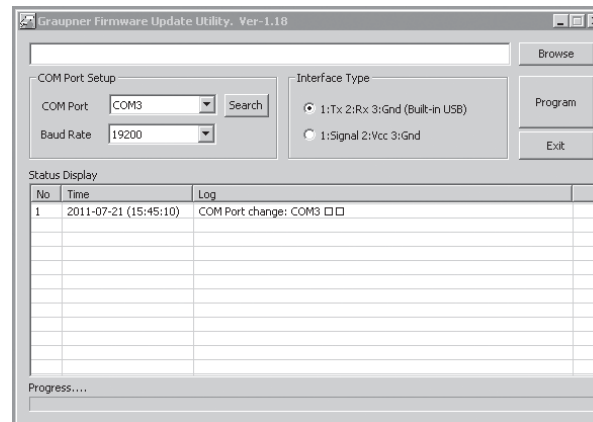

In the "COM Port Setup" group box, select the COM port to which the USB interface is connected. If you are not sure which selection is correct, press the "Search" control, choose the connection labeled "Silicon Labs CP210x USB to UART Bridge" from

the popup window and then activate "OK". The "Baud Rate" setting should be "19200". Afterwards, click on the "Signal 2:Vcc3:Gnd" radio button in the "Interface Type" group box.

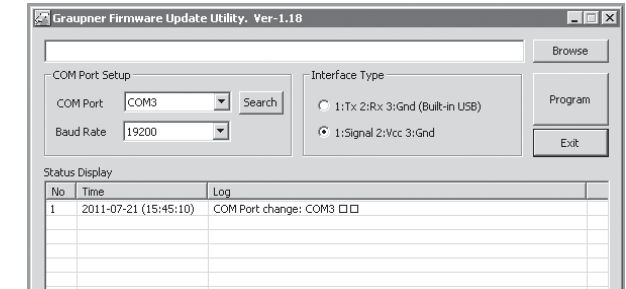

Now click on the control labeled "Browse" that is located at the top right corner of the window. From the "Open file" window which appears, select the appropriate firmware update file for your receiver. Such files always have the ".bin" filename extension. Typically this file can be found in the folder whose name is prefixed with the order number of the receiver to be updated. This folder should contain the ZIP file that was downloaded and unpacked. Its filename should also be prefixed with the order number of the receiver to be updated. For the standard GR-32 DUAL receiver included in this set, the directory would be designated "33516_16CH_RX". The filename will appear in the corresponding window.

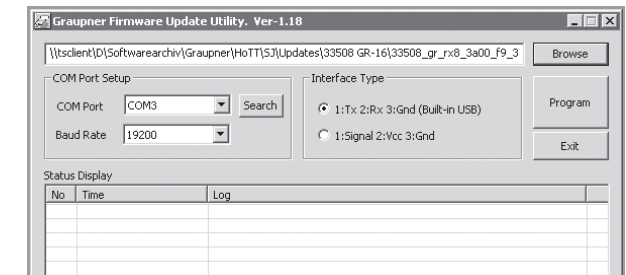

Firmware files are product-specifically coded, i.e. if a wrong file is accidentally selected which does

not correspond to the product (e.g. a transmitter update file instead of a receiver update file), the "Product code error" popup window will appear and the update process will not start.

Activate the control labeled "Program". Wait for the progress bar to start. Depending on the speed of the computer being used, this may take several seconds. Now switch on the receiver while holding its **SET** button down. After a few seconds the "Found target device ..." message will appear in the status display. Now you can release the receiver's button. The actual firmware update will begin autonomously after this message has appeared.

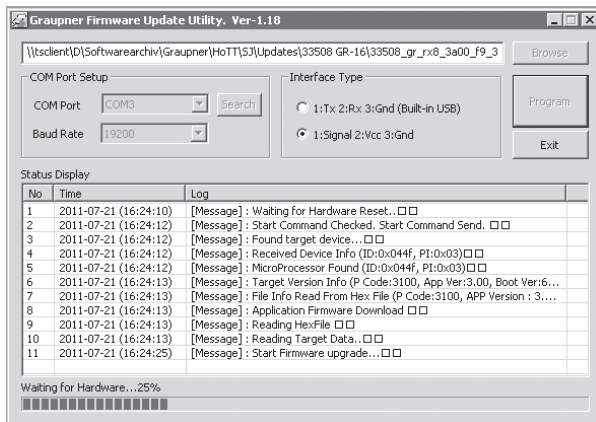

However, if the receiver is not detected, the "Target device ID not found" popup window will appear. If this process terminates before reaching the 100% mark, switch off your receiver's power supply then try to start the update process all over again. Do this by performing the above steps again. The status display and progress bar will show you the progress of the firmware update. The update is concluded when the text "Complete ... 100%" or "Complete!!" appears in the bottom line of the status display.

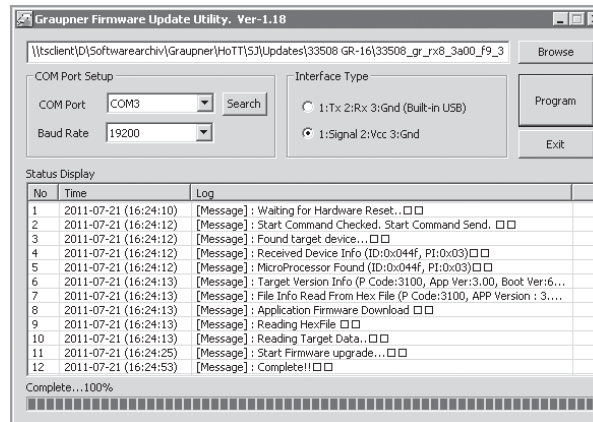

Both LEDs on the receiver will illuminate during the update process. Upon successful conclusion of the update process, the green LED will extinguish and the red LED will begin to blink. Switch the receiver off and remove the interface cable. Repeat this procedure for any other receivers present.

4. Receiver initialization

Following a successful update process you **MUST** perform a receiver initialization procedure before using the receiver again. This is necessary for reasons of safety.

Do this by pressing and holding the receiver's **SET** button then switching the receiver's power supply on. Now release the **SET** button again. When you subsequently switch the receiver on again, the receiver's green LED will illuminate continuously for about 2 or 3 seconds. Except for binding information, all other settings that may have been programmed into the receiver will now be reset to factory defaults and will have to be re-entered again if they are needed.

Installation notices

Receiver installation

Regardless of which *Graupner* receiver system you use, the procedure is always the same.

Please pay attention that the receiver's antennas must be mounted at least 5 cm away from all large metal parts or any wiring that is not directly routed out of the receiver itself. In addition to steel parts, this also includes carbon fiber parts, servos, fuel pumps and all kinds of cables etc. Optimally the receiver should be placed at a readily accessible location that is well away from all other equipment. Under no circumstances may servo cables be wrapped around the antennas or routed close to it.

Please note that cables are subject to the acceleration forces which occur during flight and these forces may cause such cables, to shift in position. Therefore be sure the cables in the vicinity of the antennas are not able to move. Such moving cables can cause reception disturbances.

Tests have shown that vertical (upright) antennas provide the best results during wide-range flights. In the case of diversity antennas (two antennas), the second antenna should be oriented at a 90° angle to the first antenna.

The connectors designated "B + -" on the GR-32 DUAL HoTT receiver are intended for battery connections. The power supply is bussed across all numbered connections so it can be attached at any of these 16 connectors. However, due to additional voltage losses associated with the traverse connectors, connections 13 through 16 should not be used for connecting the receiver's battery.

The function of every individual channel is determined by the transmitter used, not by the receiver. However, channel assignments can be changed in the receiver by programming done in the »**Telemetry**« menu.

Nevertheless, it is recommended this be done on the transmitter side via the "Transmitter output" option, see page 218.

Several notices and suggestions for installing remote control components into a model are provided below.

1. Wrap the receiver in a foam rubber pad that is at least 6 mm thick. Attach the foam rubber to the receiver with rubber bands so it will be protected against vibration and/or the jars of a hard landing.
2. All switches must be installed such that they are not affected by exhaust gases or vibration. The switch knob must be freely accessible over its entire range of movement.
3. Mount servos on rubber bushes/spacers with hollow brass bearings to protect them from vibration. Do not tighten the fastening screws down too tight as this would negate the vibration protection to be provided by the rubber bush/spacer. Only when servo fastening screws are properly tightened will this arrangement provide security and vibration protection for your servos. The figure below shows how a servo is mounted properly. The brass bearings are to be pushed into the rubber bushes/spacers from below.

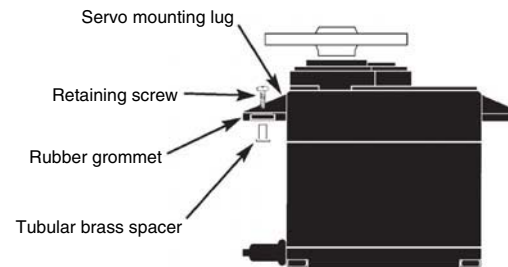

4. Servo arms must be free to move throughout their entire range of motion. Pay attention that there are no objects which could hinder servo arm motion.

The sequence in which servos are connected to the receiver depends on the type of model. Follow the connection layouts provided for this on pages 61 and 65. Also observe the safety notices provided on pages 4 ... 9.

In order to prevent uncontrolled movements of servos connected to the receiver during startup

**always first switch on the transmitter
and then the receiver**

and when finished with operation

**first switch off the receiver
and then the transmitter.**

When programming the transmitter, be sure that electric motors cannot start running without control or that a combustion motor equipped with automatic starting cannot start up unintentionally. To be safe, disconnect the receiver's drive battery or, in the case of a combustion motor, disconnect the fuel supply.

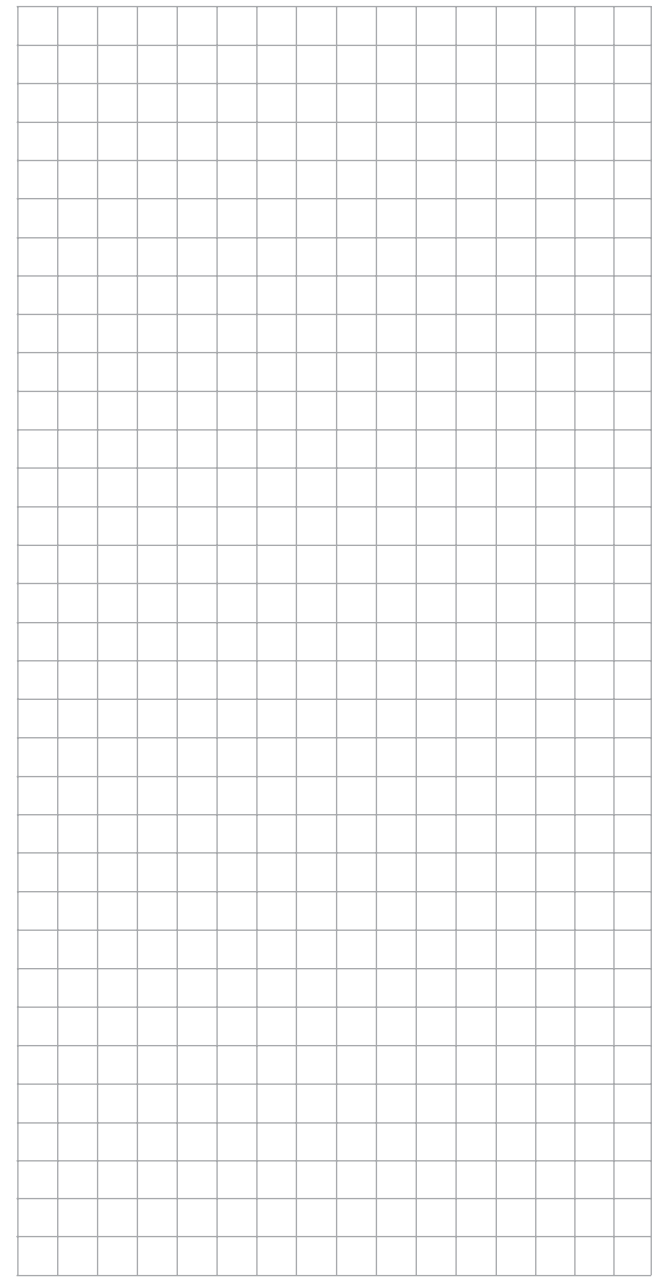
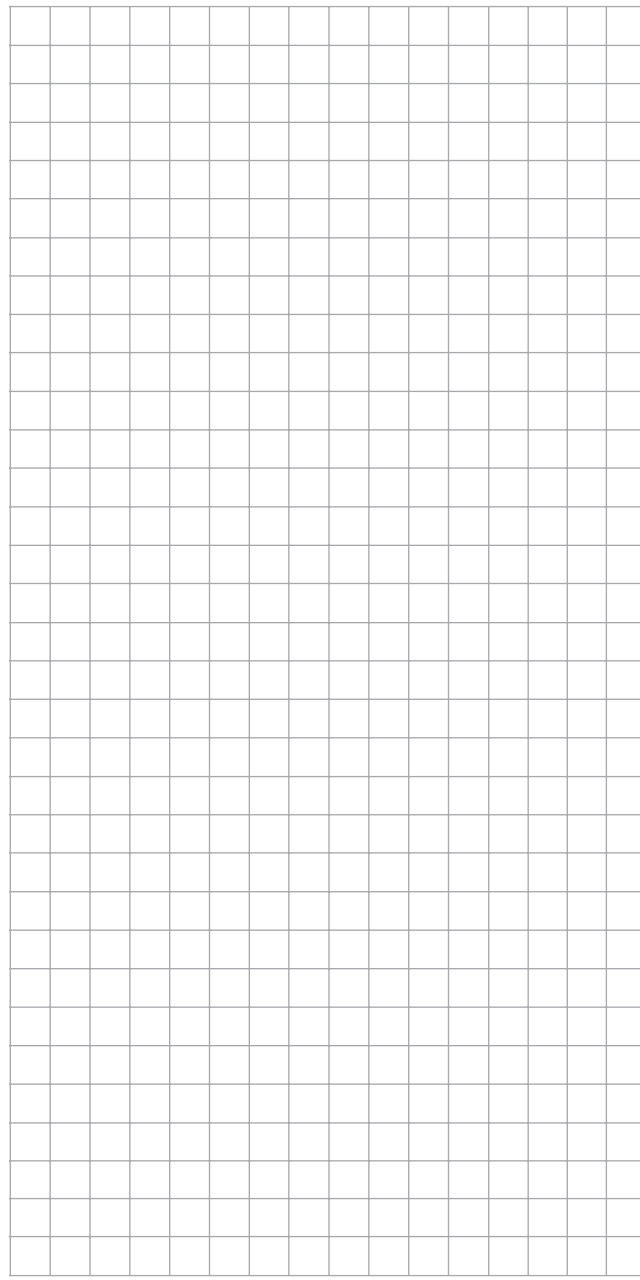
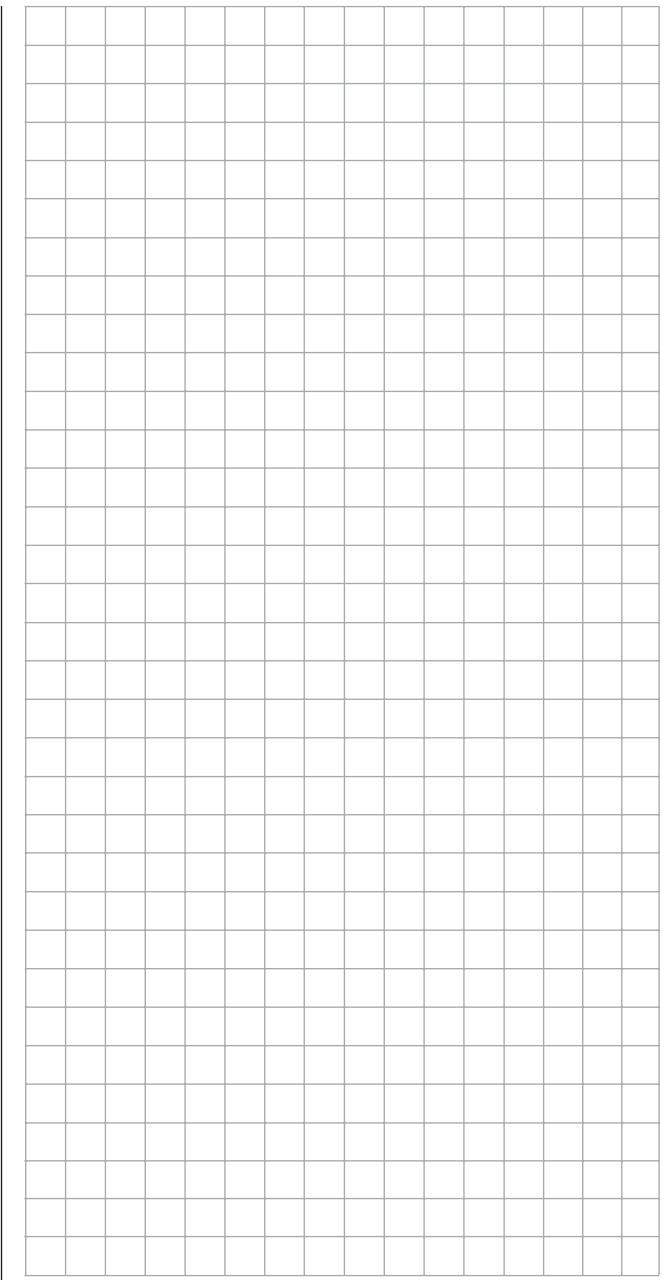

Term definitions

Control function, control, function input, control channel, mixer, switch, control switch, fixed switch

To make use of this **MLC-20** HoTT manual easier, a number of the terms used repeatedly throughout this manual have been defined below.

Control function

A "control function" is to be perceived –initially independent of its signal path—as a signal intended to affect a given control function. For example, this could be for throttle, rudder or aileron in a winged aircraft or pitch, roll or crow for a helicopter.

A control function signal can be applied directly over a single control channel or also through a mixer and then applied over multiple control channels. A typical example of multiple control channels is separately operated aileron servos or the use of two roll or crow servos in helicopters. The control function explicitly includes the influence of the control's mechanical travel on the respective servo. This can not only be spread or compressed by software but even the travel characteristic can be modified from linear to extremely exponential.

Control

"Controls" include all operating elements on the transmitter, which are directly activated by the pilot, that impose an effect on servos, speed controllers etc. connected to the receiver. This includes:

- both *joysticks* for control functions 1 through 4, whereby these four functions can be freely swapped around for both model types ("winged aircraft" and "helicopters") by way of software "Mode" settings, e.g. throttle left or right. The joystick function for throttle/airbrake control is often also referred to as the C1 control (channel 1).
- both proportional controls located on the transmitter's sides, which are, for example, given the designations SD1 (right-side "rotary slider") and SD2 (left-side "rotary slider") in the »**Control adjust**« menu, page 108 and 112.

- the three proportional sliders in the middle console designated SR1 ... 3, for example as shown in the »**Control adjust**« menu, page 108 and 112,
- all five proportional rotary controls on the transmitter's front side, which are, for example, given the designations DR1 ... 5 in the »**Control adjust**« menu, page 108 and 112,
- the switches present, if they are assigned to a control channel in the »**Control adjust**« menu.

The proportional operating elements produce a direct effect on servos which is commensurate with the control's position whereas switch modules can only effect a two or three increment change.

Just which of these controls and switches operate which of the servos 5 ... 16 (max.) is freely programmable.

Important notice:

Inputs 5 ... 15 for helicopters and 5 ... 16 for winged aircraft are generally "free", i.e. not assigned, in the transmitter's basic programming.

Function input

This is an imaginary point in the signal path and must not be considered the same as the point on the circuit board where the transmitter control is connected. The choice of "**Stick mode**" and settings in the »**Control adjust**« menu have their effect "downstream" of these imaginary connection points. Thus differences between the physical control's number and the number of the downstream control channel can indeed emerge.

Control channel

From the point at which a signal contains all control information necessary for a particular servo—whether directly from the physical control or indirectly by way of a mixer—the term "control channel" is used. This signal is only yet to be influenced by settings made in the menus »**Servo adjustment**« and »**Transmitter output**« before it leaves the transmitter's RF module.

Once it arrives at the receiver, this signal may still be modified by settings made in the telemetry menu before finally being applied as a control quantity for the respective servo.

Mixer

The transmitter's software contains a variety of mixer functions. These can be used to apply one control function to multiple servos or, conversely, to apply multiple control functions to a single servo. Please look over the numerous mixer functions in the text beginning on page 159 of this manual.

Switches

The four standard toggle switches, the two 3-way switches and both push-button switches can also be incorporated into control programming. However, these switches are generally intended for switching program options, e.g. to start and stop timers, to switch mixers on and off, or as a teacher/pupil switchover, etc. Each of these switches can be assigned any number of functions.

Appropriate examples are detailed in the manual.

Control switches

Since it is very practical to have some functions automatically switched on or off for a certain control's position (e.g. switch on/off of a stopwatch for acquisition of model run time, automatic extension of spoilers and other possibilities), eight control switches have been integrated into **MLC-20** HoTT software. These software switches, designated "C1 ... C8", are merely defined by virtue of their contact state along the physical control's course of travel by the touch of a key. The switching action can be correlated to the physical control's travel direction by software. Of course control switches can also be freely combined with the aforementioned physical switches to solve even more complex problems.

There is a series of instructive examples which make

this programming child's play. Learn about this by taking advantage of the programming examples beginning on page 268.

Logical switches

These functions permit two switches, control switches and/or logical switches or any combination of these to be combined with one another to create logical "AND" and "OR" functionality. A total of 8 logical switches, "L1 ... L8" can be programmed, see page 138.

Fixed switches FXI and FXO

This type of switch turns a function, e.g. a timer, permanently on (closed fixed switch) or off (open fixed switch) or they can provide a fixed input signal for a control function, e.g. FXI = + 100% and FXO = -100%. For example, in flight phase programming, these fixed switches can be used to switch a servo or speed controller between two settings.

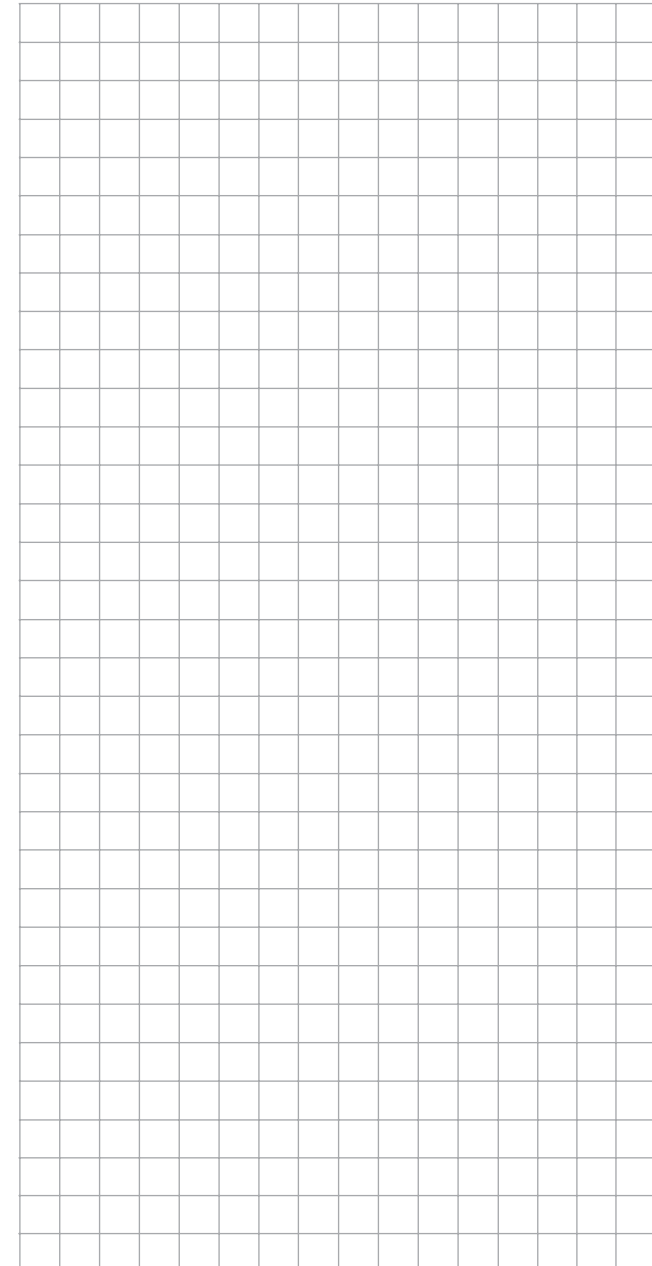
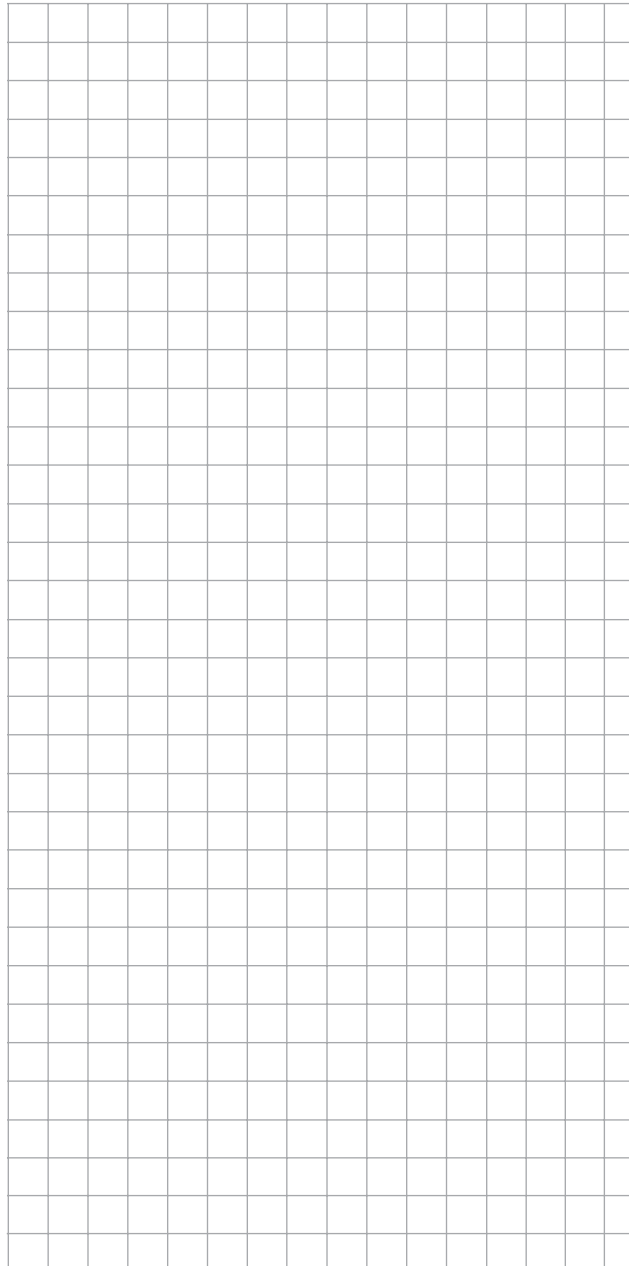

Physical control, switch and control switch assignments

Principle procedure

Maximum flexibility is offered by the **MFC-20** Hott system when it comes to assigning standard equipment operating elements to certain functions. Since the assignment of controls and switches is done in the same way, even though different menus may be involved, it is appropriate at this point to explain the fundamental programming technique so that users can concentrate on the particular contents when reading the detailed menu descriptions.

Physical control and switch assignments

The third column of the »**Control adjust**« menu can be used to assign transmitter inputs 5 ... 16 to operate servos, both in any given joystick direction (C1 ... C4) as well as to assign any present control or switch. After tapping on the center **SET** key of the right touch pad, the window shown below will appear in the display.

Gewünschten Schalter
oder Geber betätigen

Now simply move the desired control or switch.

Notes:

The control will only be recognized beyond a certain amount of travel. Therefore these controls can be moved back and forth until the correct assignment is shown in the display. If adjustment travel is insufficient, activate the control in the other direction.

On the other hand, if the »**Control switch**« menu, page 135, is used to assign a control, the message shown below will appear:

Move desired
control adj.

Important notice:

Controls to be assigned MUST be pre-assigned in the »Control adjust« menu to one of the inputs 5 through 16!

Switch assignment

Wherever programming permits a switch to be assigned, a switch symbol will appear in the screen's bottom display line.



Use the selection keys in the left or right touch pad to select the appropriate column.

How to assign a switch

1. Briefly touch the **SET** key of the right touch pad. The message shown below will appear in the screen.

Move desired switch
to ON position
(ext. switch: ENTER)

2. Now it is only necessary to put the selected switch into the desired "ON" position or, as described at the right in "Assignment of external switches", to select a switch from the list of "External switches". This concludes the assignment. The switch symbol to the right of the switch's number indicates the current state of the particular switch.

Changing switch action

If the activation of a switch is to result in the opposite action, put the switch or joystick in the desired OFF position, again activate the switch assignment and reassign the switch again so it will respond with the desired action.

Clear switch

A switch which has been assigned as described under point 1 can be cleared with a brief simultaneous tap on the ▲▼ or ◀▶ key combination in the right key pad (**CLEAR**).

Assignment from the "external switch" list

Those menus in which the message ...

Move desired switch
to ON position
(ext. switch: ENTER)

... appears permit the assignment of switches belonging to the so-called "external switches".

Do this by confirming the message text with the **SET** key. A new window will appear with a list of the eight control switches "C1 ... C8", followed by two so-called "FX" fixed switches and the eight inverted switches "L1 ... L8".

M Control/Logic/fix switch
to C1 C2 C3 C4 C5 C6
(e C7 C8 FX FXi L1 L2

Use the selection keys in the left or right key pad to select the desired switch then assign it with a brief tap on the center **SET** key of the right touch pad.

Notes:

- *Switching for some special functions may be better implemented from a certain freely programmable control position rather than switching them manually with a normal switch. To this end, there are a total of 8 so-called "control switches", C1 ... C8, available whose switching direction can be established, even inverted, in the »Control switch« menu, page 135.*
- *Two switches and/or also control switches can be combined with one another to form the logical "AND" or "OR" functions via the »Logical switch« menu, see page 138. A total of 8 logical switches "L1 ... L8" (as well as another 8 inverted logical switches with inverted switching direction) are available. The result of a logical switch function can also be used as an input for another logical switch function. Refer to the appropriate menu for more details about this.*

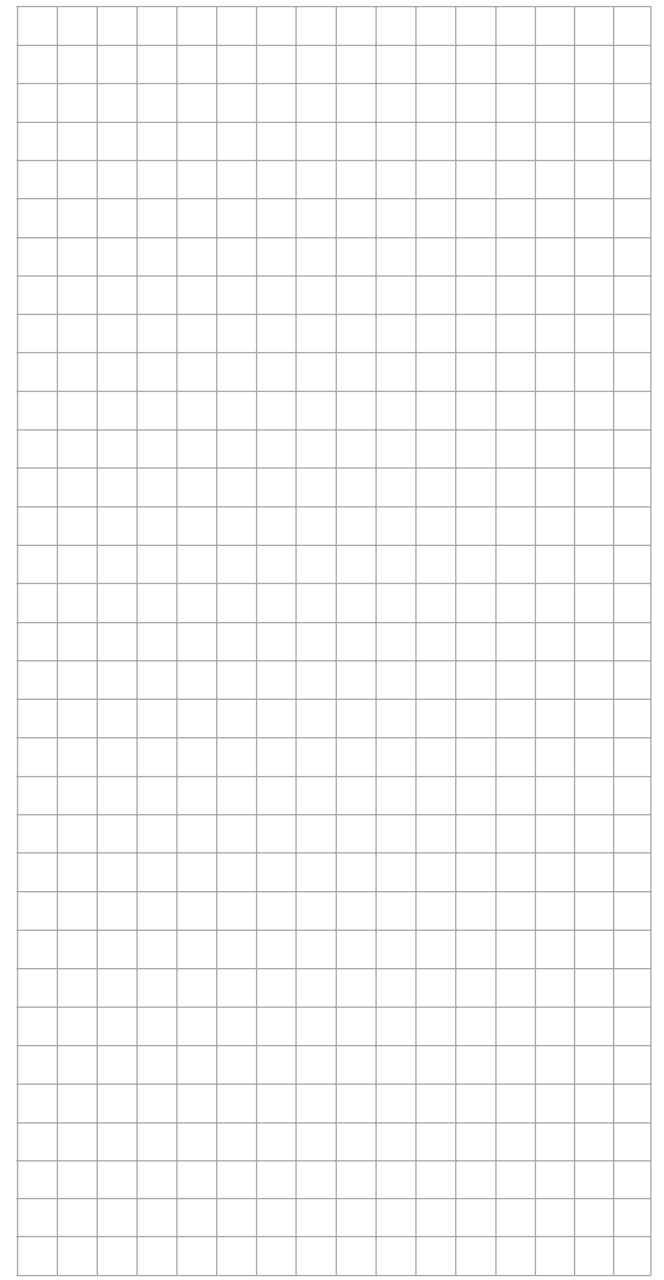
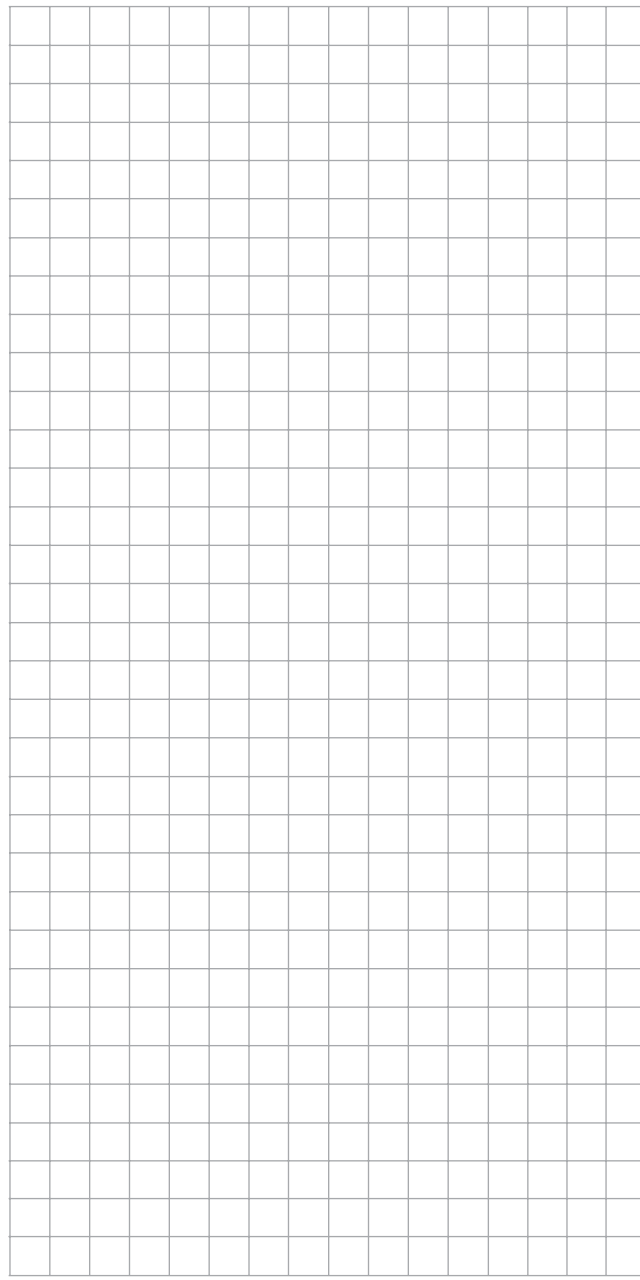
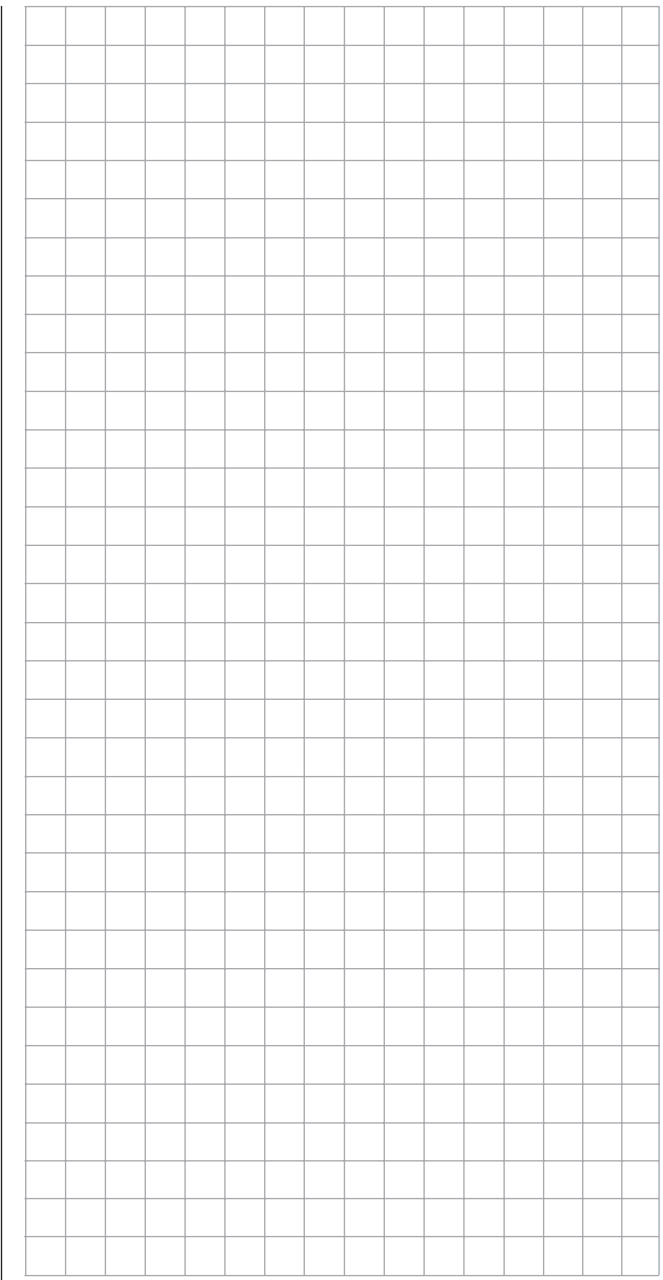

Winged models

Convenient support is provided for up to four aileron servos and four flap servos on normal models or, for V tail and flying wing/delta models, up to two aileron/elevator servos plus four flap servos.

The majority of motorized and glider models belong to the tail unit type "normal" and are equipped with one servo each for elevator, rudder and ailerons in addition to a motor throttle or electronic speed controller (or for brake flaps in the case of a glider model). Beyond this, tail unit type "2 HR Sv 3+8" permits the connection of two elevator servos to receiver outputs 3 and 8.

"V-tail" is to be selected from the »Model type« menu if the model has a V-tail instead of a "normal" tail.

This V-tail option provides coupled control functions for elevator and rudder such that both tail flaps—each controlled by a separate servo—are able to handle both elevator and rudder functionality.

For delta and flying wing aircraft models, aileron and elevator functionality is affected by way of a common rudder flap on the trailing edge of each side (right and left) of the wing. The program contains appropriate mixer functions for both servos.

If ailerons, and conditionally the flaps, are each actuated with two separate servos then settings can be made for differentiated control of all aileron and flap pairs in the »Wing mixers« menu, i.e. settings

for downward rudder throw independent of upward throw. And finally, the positioning of flaps can also be controlled by one or even more of the three proportional sliders or the seven proportional rotary controls.

Alternatively, there is a phase-dependent trim function available for flaps, ailerons and elevators in the »Phase trim« menu.

Up to 8 flight phases can be programmed into each of the 80 model memory locations.

Except for C1 trim, digital trim will be stored on a flight-phase basis. C1 trim permits easy location of a carburetor idle setting.

Two timers are always available for flight operation. The transmitter operating time expired since the last battery charge is also displayed.

All transmitter controls and switches can be assigned in the »Control adjust« menu to inputs 5 ... 16 with almost no restrictions.

The "Dual Rate" and "Exponential" functions for ailerons, rudder and elevators are separately programmable and each are convertible between the two variations on a specific flight-phase basis.

In addition to 8 freely allocatable linear mixers, 4 curve mixers (»Free mixers« menu) and 4 dual mixers (»Dual mixer« menu) there are also flight-phase dependent 8-point curves available to control channel

1 (throttle/brake), see »Channel 1 curve« menu).

Depending on the number of wing servos, fixed-definition mix and coupling functions can be selected from a list in the »Wing mixers« menu.

- Multi-flap menu: control of flaps as ailerons, the influence aileron trim on flaps controlled as ailerons, flap differentiation, flap function throw magnitude for all aileron and flap pairs, ailerons controlled as flaps, elevator mixer → flaps
- Brake settings: butterfly, differential reduction, elevator curves
- aileron → rudder mixer
- flaps → elevator mixer

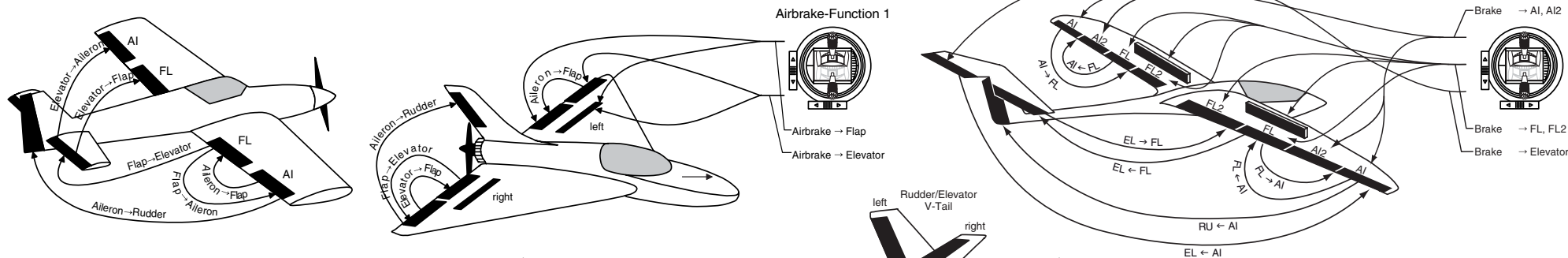

Installation notices

Servos **MUST** be connected to the receiver in the sequence illustrated here.

Outputs which are not used are simply left empty. Also be sure to follow the notices on the next pages.

Winged aircraft with and without motor having up to 2 aileron servos and up to 4 flap servos ...

... and tail plane type "normal" or "2 elevator servos"

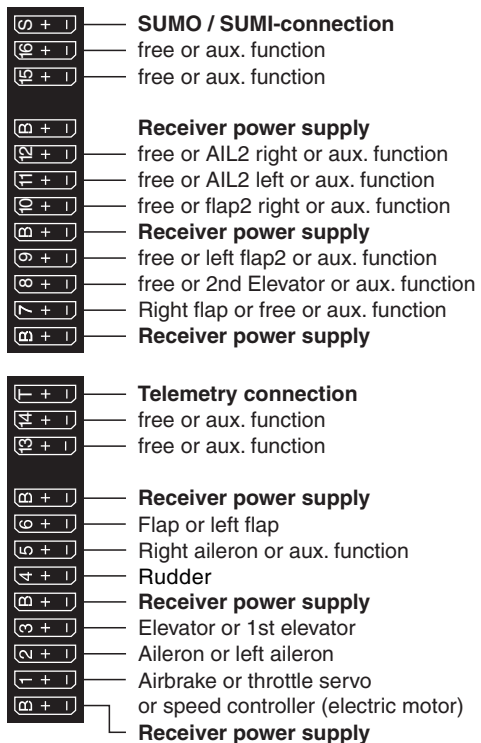

... and tail plane type "V tail unit"

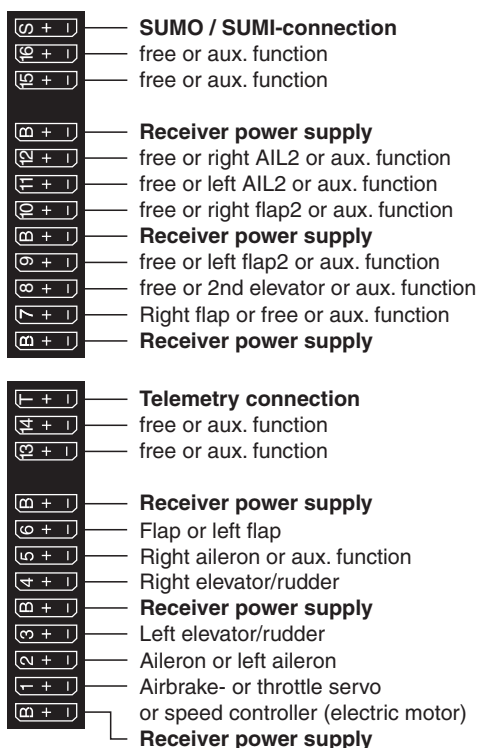

Delta/flying wing aircraft models with and without motor having up to two aileron/elevator servos and up to 2 flap/elevator servos

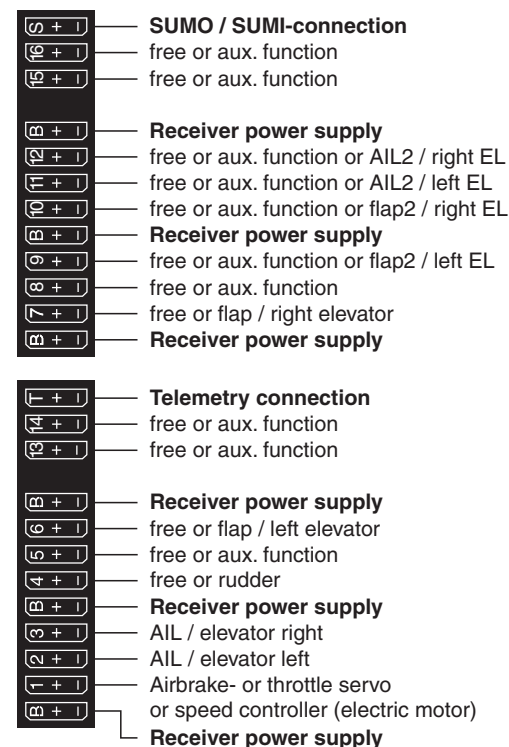

Because of orientation differences for installed servos and their rudder linkages, the actuating direction of some servos may be initially backward. The table below provides remedies.

| Model type | Servo direction wrong | Remedy |
|--------------------|-------------------------------------|--|
| V tail | Rudder and elevator reversed | Reverse polarity of servos 3 & 4 in the » Servo adjustment « menu |
| | Rudder correct, elevators reversed | Swap servos 3 & 4 on the receiver |
| | Elevators correct, rudder reversed | Reverse polarity of servos 3 & 4 in the » Servo adjustment « menu AND swap them on the receiver |
| Delta, flying wing | Elevator and aileron reversed | Reverse the polarity of servos 2 & 3 in the » Servo adjustment « menu |
| | Elevator correct, aileron reversed | Reverse polarity of servos 2 & 3 in the » Servo adjustment « menu AND swap them on the receiver |
| | Aileron correct, elevators reversed | Swap servos 2 & 3 on the receiver |

All "program descriptions" for menus relevant to a winged aircraft model are marked with a winged aircraft symbol ...



... so only these menus need to be dealt with to program a winged aircraft model.

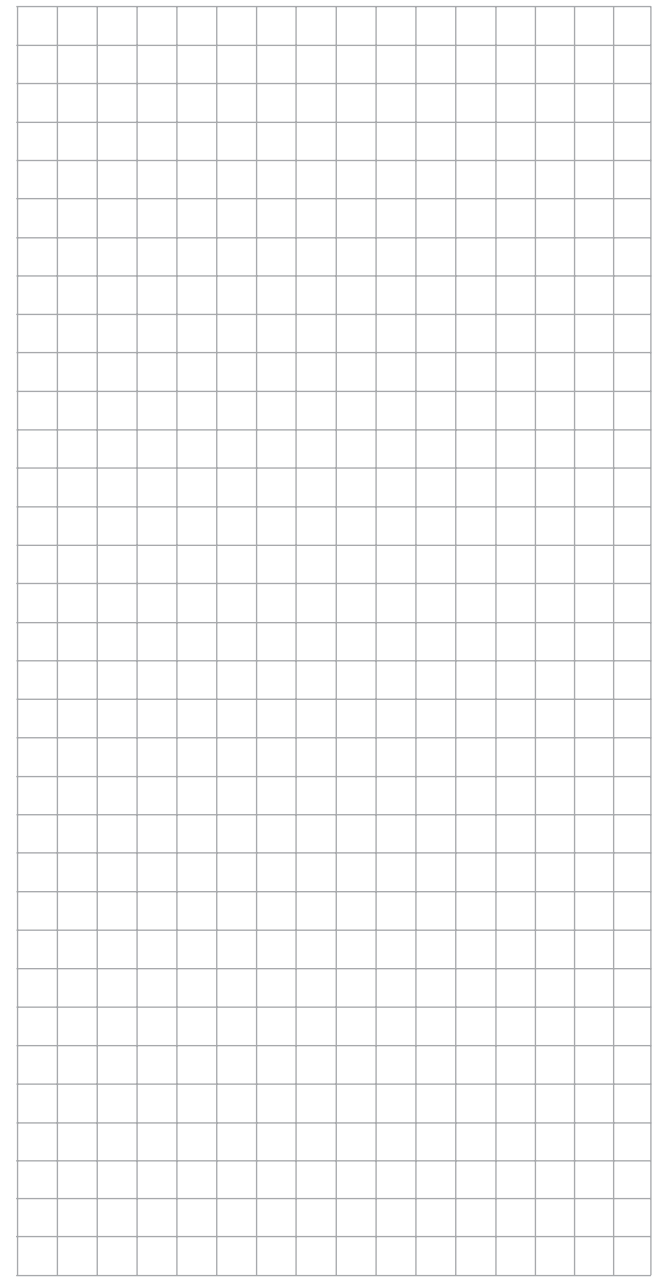
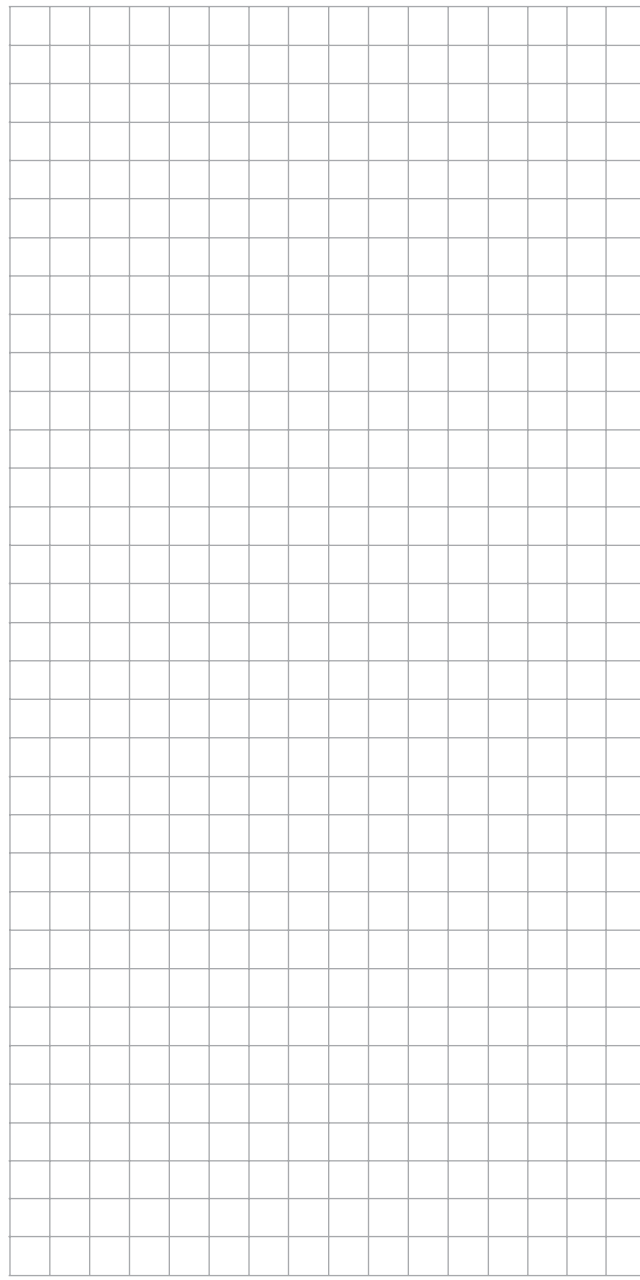
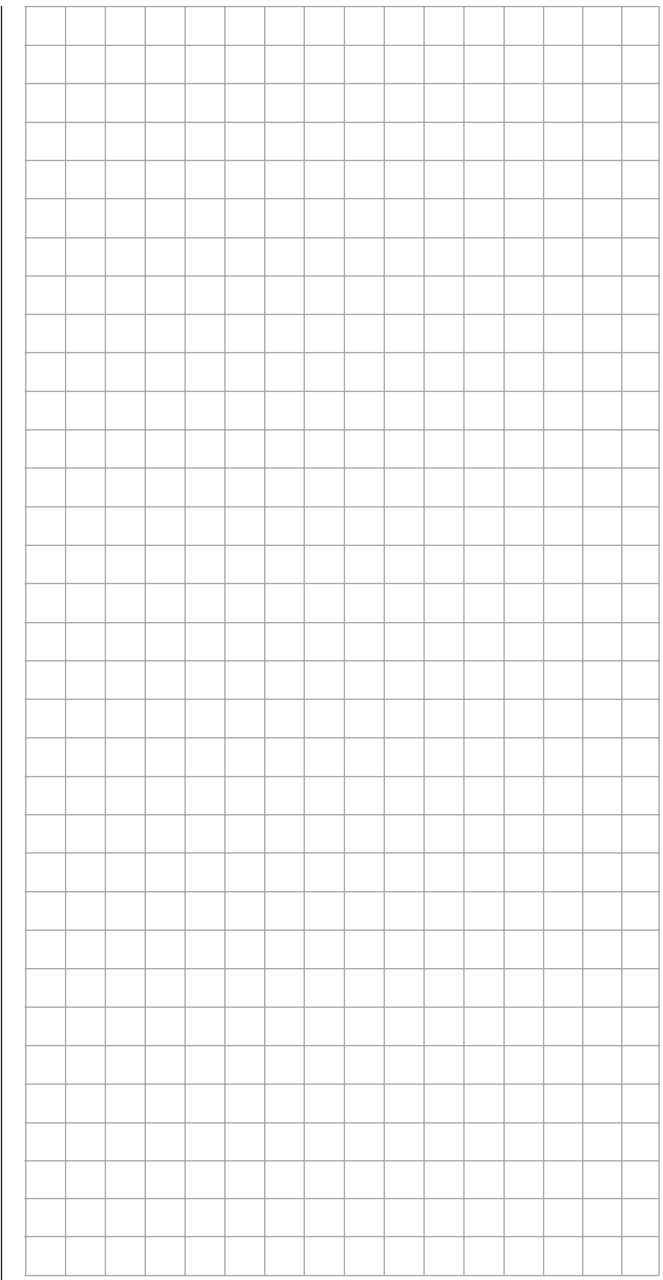

✈️ Helicopter models

The advanced developments incorporated into the transmitter as well as those now in helicopter models and their components like gyros, speed regulators, rotor blades, etc. make it possible to master a helicopter even in 3D acrobatic flight. On the other hand, a beginner needs only a few settings to get started with hovered flight training then, step-by-step, take advantage of **MC-20** HoTT features with increasing expertise.

The **MC-20** HoTT program can operate all conventional helicopters having 1 ... 4 servos for pitch control.

Seven flight phases plus autorotation are available within a model memory, see menus **»Control adjust«**, **»Phase settings«** and **»Phase assignment«**.

As with winged aircraft, here too, in addition to the basic screen's standard timers there are additional timers as well as a lap counter with flight-phase-dependent stopwatch functionality which are available for selection (menus **»Timers (general)«** and **»Fl. phase timers«**).

Except for pitch/throttle trimming, digital trimming can be stored as "global" for all flight phases or as "flight phase specific". C1 trim permits easy location of an idle setting.

The control assignments for inputs 5 ... 16 is made separately for each flight phase (**»Control adjust«** menu).

A flight phase copy function is helpful during flight trials (**»Copy / Erase«** menu).

"Dual Rate" and "Exponential" functions can be coupled for roll, nick and tail rotor and programmable in two variations in every flight phase.

There are 8 freely assignable linear mixers. There are also 4 curve mixers that can be programmed and these can also be switched on or off, depending on the flight phase, in the **»MIX active/phase«** menu. Beyond this, there are also 4 dual mixers available.

The **»Helicopter mixer«** menu provides flight-phase-dependent 8-point curves for the non-linear characteristics pitch, throttle and tail rotor mixer as well as two independent swashplate mixers each for roll and nick. Independent of this, the control curve of the channel 1 joystick can be defined with up to a total of 8 points in every flight phase. The beginner will initially only adapt the hover flight point to the control middle for the non-linear characteristics.

Pre-programmed mixers in the **»Helicopter mixer«** menu:

1. Pitch curve (8-point curve)
2. C1 → throttle (8-point curve)
3. Channel 1 → tail rotor (8-point curve)
4. Tail rotor → throttle
5. Roll → throttle
6. Roll → tail rotor
7. Pitch-axis → throttle
8. Pitch-axis → tail rotor
9. Gyro suppression
10. Swashplate rotation
11. Swashplate limiter

The "Throttle limit" function (input T116 in the **»Control adjust«** menu) allows the motor to be started in any flight phase. The right-side proportional rotary slider is assigned to input "T116" by default. This "throttle limiter" establishes—depending on its given position—the maximum possible throttle servo position. This makes it possible for the motor to be controlled in the idle range, if necessary even by the proportional regulator. The throttle curves become effective only when the proportional regulator is pushed toward the full throttle direction.

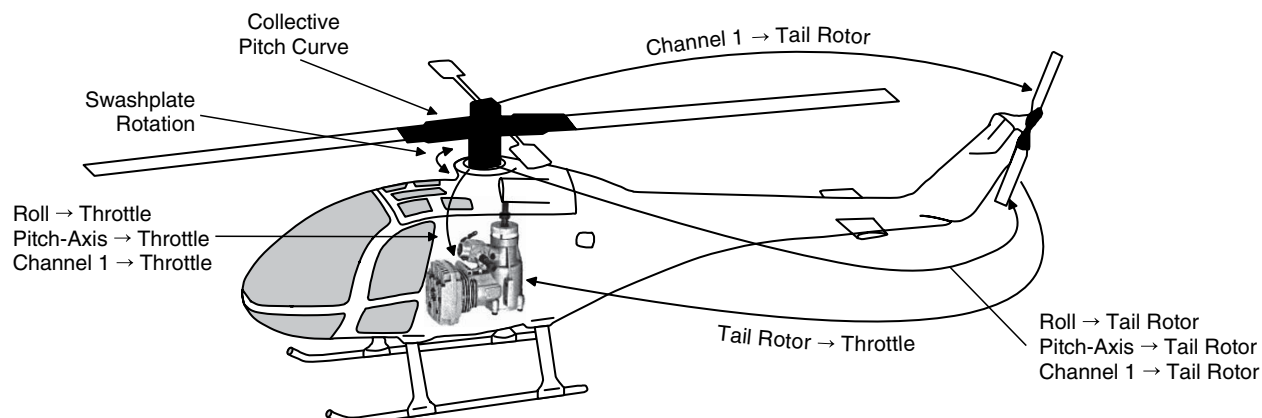

Notice for those transitioning from older Graupner systems:

In comparison to previous receiver layouts, servo connector 1 (pitch servo) and servo connector 6 (throttle servo) have exchanged places. Servos **must** be connected to receiver outputs as illustrated at the right in the bottom figure. Outputs which are not used are simply left empty. More details about respective swashplate types can be found on page 98 in the »Helicopter type« menu.

Installation notices

Servos MUST be connected to the receiver in the sequence illustrated here.

Outputs which are not used are simply left empty.

Also be sure to follow the notices on the next pages.

Note:

A speed control is also to be connected to receiver output "6" in order to take full advantage of the throttle limiter's convenience and safety features, see text beginning on page 117. See page 181 about this.

Receiver allocation for helicopter models with 1 to 3 swashplate servos

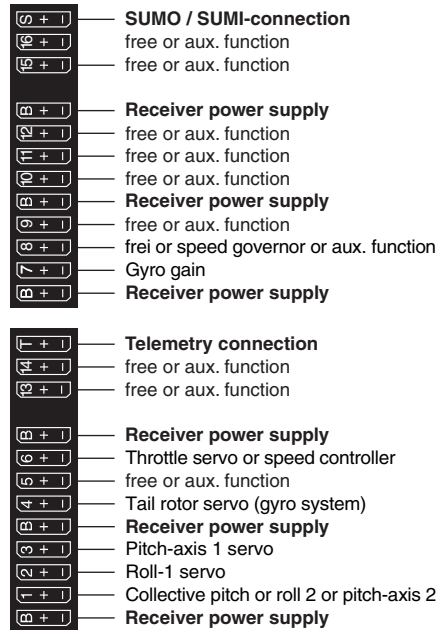

Receiver allocation for helicopter models with 4 swashplate servos

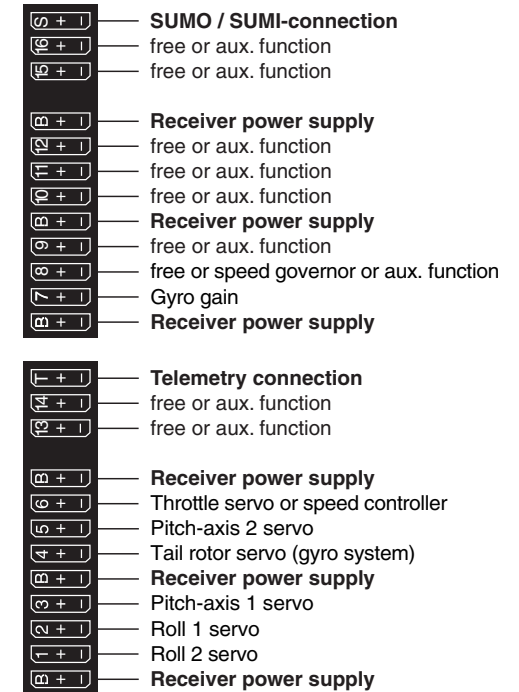

All menus relevant to helicopter models are marked in the "program descriptions" section with a helicopter symbol ...



... so only these menus need to be dealt with to program a helicopter model.

Detail program description

Loading a new memory location

Anyone who has worked through to this part of the manual has certainly already tried out a bit of programming. Nevertheless a detailed description of every menu should not be left out.

This section begins with the loading of a "free" memory location, a procedure which would be performed if a new model was being "programmed".

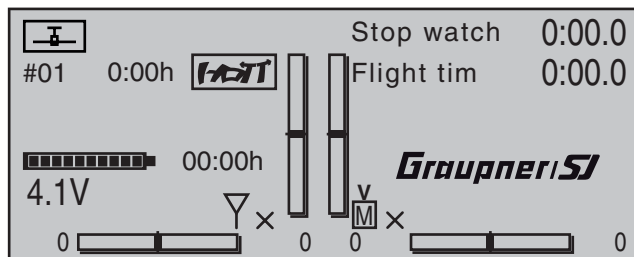

From the basic display, a jump to the "Multi-function list" is made with a tap on the center **SET** key of the right touch pad. (The center **ESC** key of the left touch pad will cause a jump back to the basic display.) By default, when the multi-function list is called for the first time after switching on the transmitter, the »**Model select**« menu option will be active and displayed in inverse video. Otherwise use the ▲▼ or ◀▶ selection keys of the left or right touch pad to select the »**Model select**« menu option, whereby the upper of the two following figures shows a selection list for a fixed-wing model and the lower shows the selection list for a helicopter model.

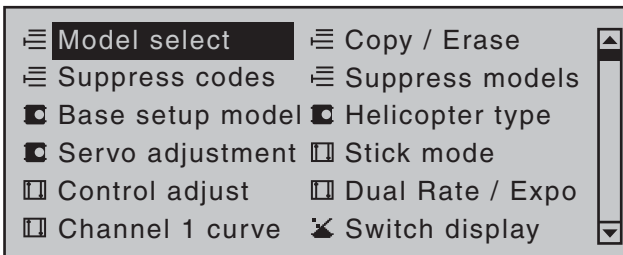
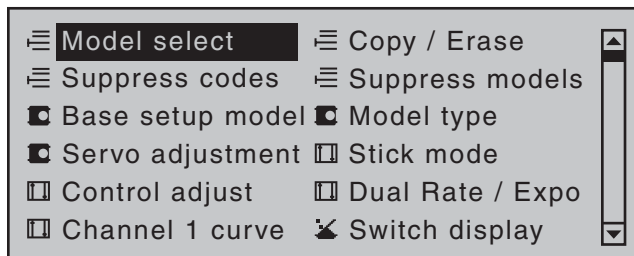

Tap briefly on the center **SET** key of the right touch pad to open this menu option:



In the transmitter's delivered state, the first model memory is initialized to the "**fixed-wing model**" type and the receiver in the delivery is "bound" to this model. The time display located near the line's middle indicates the overall operating time of the respective model memory.

The remaining memory locations, marked with "***free***", are still unoccupied and therefore also "non-bound". If you wish to program a fixed-wing model then, after leaving the »**Model select**« menu with a tap on the center **ESC** key of the left touch pad, programming of the model can begin right away ... or now use the ▲ or ▼ keys of the left or right touch pad to select one of the free memory locations ...



... and then tap on the center **SET** key of the right touch pad to confirm the choice.

Afterward you will be prompted to select the basic model type, i.e. either "winged model" or "helicopter model".

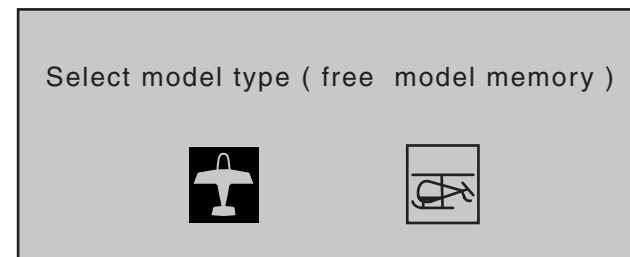

Use the ◀ or ▶ keys of the left or right touch pad to select the basic model type then tap on the center **SET** key of the right touch pad. This initializes the selected model memory with the selected model type and the display will return to the base screen. The memory location is now accordingly occupied. However, if you wish to begin with a **helicopter**, select one of the memory locations marked "***free***" with the ▲ or ▼ keys of the left or right touch pad then confirm the selection with a brief tap on the center **SET** key of the right touch pad. You will be now be prompted to specify the basic model type, in this case the "helicopter model". Select the appropriate symbol with the ◀ or ▶ keys of the left or right touch pad then again tap briefly on the center **SET** key of the right touch pad to confirm the choice. This initializes the selected model memory with the

selected model type and you can now program your model into this model memory.

Changing over to another model type is still possible if you first erase this memory location (»**Copy / Erase**« menu, page 70).

Notes:

- If, from the base screen, the currently active model memory is to be erased then immediately after the erase action one of the two model types, "Winged" or "Heli" must be defined. You cannot avoid this selection even if you switch the transmitter off. When the transmitter is switched on again the undesired occupation of the that model memory will have to be erased from another memory location. If a non-active memory location is erased, it will subsequently be marked as "***free***" in the "Model select" menu.
- After the selected model memory is initialized with the desired model type, the display will switch to the base screen of the freshly occupied model memory. At this time the warning ...



... will appear for several seconds as notification that a binding connection to a receiver is "not available". A brief tap on the center **SET** key of the right touch pad will cause a direct jump to the appropriate option.

| | | | | | | |
|-----------------------|------|------|-----|-----|-----|--|
| BASIC SETTINGS, MODEL | | | | | | |
| Model name | < | > | | | | |
| Info | < | > | | | | |
| Stick mode | | | 1 | | | |
| ▶ Module | HoTT | bind | n/a | n/a | n/a | |
| ▼ ▲ | SEL | BD1 | BD2 | BD3 | BD4 | |

Further details about binding a receiver can be found on page 77 or 85.

- At the right and above the aforementioned "BIND. N/A" warning message, the warning ...



... will appear (also for just a few seconds) to indicate that no no failsafe settings have yet been made. More about this can be found on page 208.

- If the screen should display the warning ...

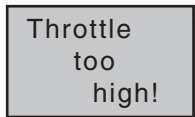

... then move the throttle joystick, or the limiter for a helicopter, (by default this is rotary slider SD1) into its idle position.

Whether or not this warning appears also depends on the settings selected for the "Motor on C1" and "Pitch min." options in the »**Model type**« menu, see page 94, or »**Helicopter type**« menu, see page 98. For winged aircraft models, select "None" to deactivate this message if you have no motor to enter.

- If the transmitter already has occupied model memories then sub-menus of the »**Copy / Erase**« menu will display a pictograph of the selected model type at the respective memory location followed by a blank line or the model name which was entered in the »**Basic settings, model**« menu, page 76 or 84. To the right of this will be as display of the model operating time and, if present, "Info" about the model.
- If battery voltage is too low, the model switchover cannot be made due to reasons of safety. An

appropriate message will appear in the screen:

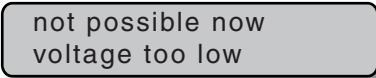

As a basic principle, there are four different ways to assign the four control functions, aileron, elevator, rudder and throttle or brake flaps for winged models as well as rolling, pitching, tail rotor and throttle/pitch for helicopter models, to the two joysticks. Just which of these methods is used depends on the preferences of the individual model pilot. This function is set for the currently active model memory in the "Stick mode" line of the »**Basic settings, model**« menu, page 76 or 84.

| | | | | | |
|----------------------|------|------|-----|-----|-----|
| BASIC SETTINGS MODEL | | | | | |
| Model name | < | > | | | |
| Info | < | > | | | |
| ▶ Stick mode | | | 1 | | |
| Module | HoTT | bind | n/a | n/a | n/a |
| ▼ ▲ | | | SEL | | |

If this setting is desired as a default for future models, the setting can also be entered into the »**General basic settings**« menu, page 258:

| | | | |
|------------------------|---|---|-------|
| GENERAL BASIC SETTINGS | | | |
| Owners name | < | > | |
| ▶ Pre-set stick mode | | | 1 |
| Pre-set modulation | | | HoTT |
| Pre-set DSC Output | | | PPM10 |
| ▼ ▲ | | | SEL |

It should be noted here once again that, in the interest of greatest flexibility in combination with the prevention of unintentional operating errors, no controls are preassigned to control channels 5 ... 16 by default. **This means that, in the system's delivered state,**

only servos attached to receiver outputs 1 ... 4 can typically be operated by the two joysticks and that any servos attached to receiver connectors 5 ... 16 (max) will remain in their middle positions. A newly initialized helicopter model is also able to more-or-less move servo 6—depending on the position of the right-side proportional rotary slider, which is the default throttle limiter control. With either model type, this situation will only change after appropriate assignments have been made in the »**Control adjust**« menu.

On the other hand, if a newly initialized model memory is to be put into operation then it **MUST** first be appropriately "connected" with one or more receivers before the servos attached to the receiver/s can be operated. More about this can be found in the section "Binding" on page 77 or 85.

A fundamental description of programming steps for a winged aircraft model can be found in the programming examples section beginning on 268, or for helicopter models beginning on page 308.

The menu descriptions below are arranged in the sequence individual menus are listed in the multi-function list.

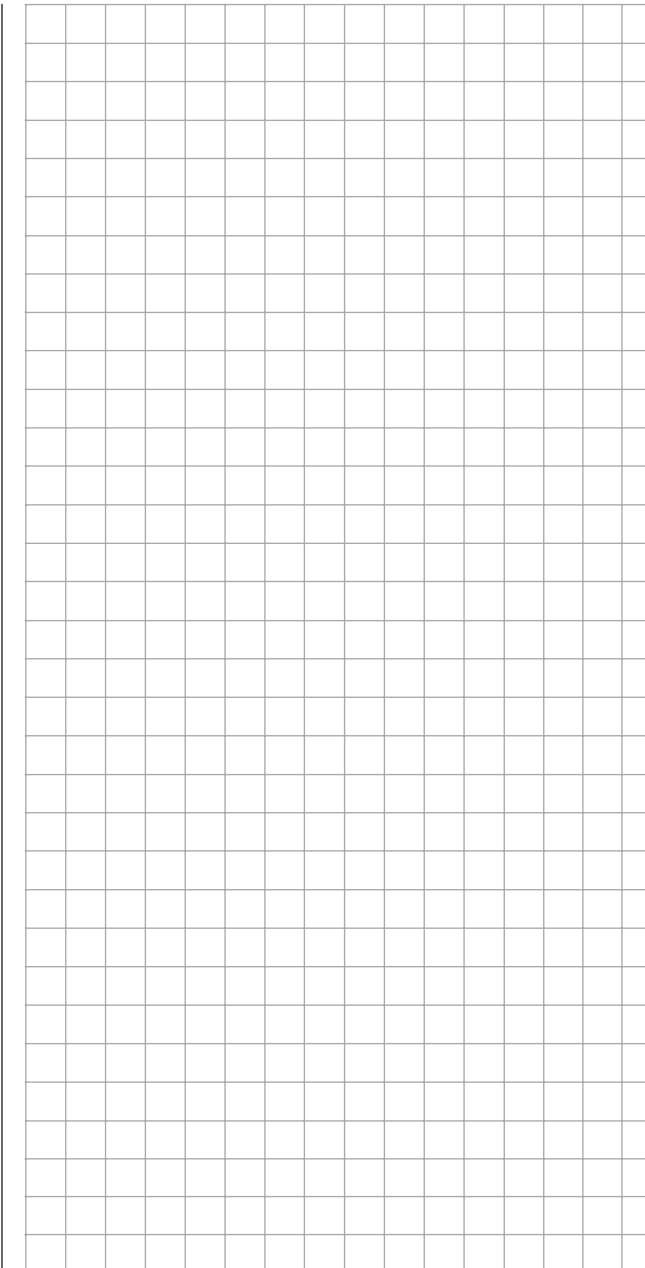
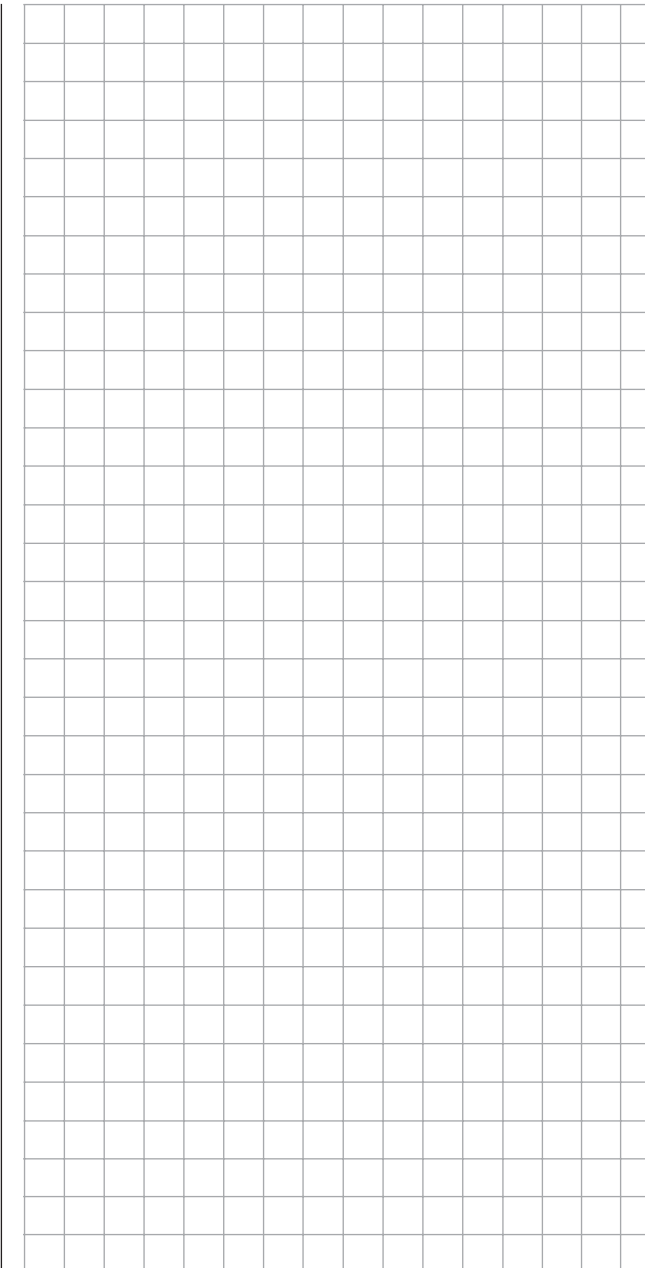

Model select

Call up model 1 ... 80

The basic operation of the transmitters keys was explained on pages 28 and 29 and, on the previous double-page, explanations were provided for navigating to the multifunction list and about how to make allocations for a new model memory. At this point we now wish to begin with the "normal" description of individual menu items in the sequence they are arranged in the transmitter. Therefore we will begin with the menu ...

Model select

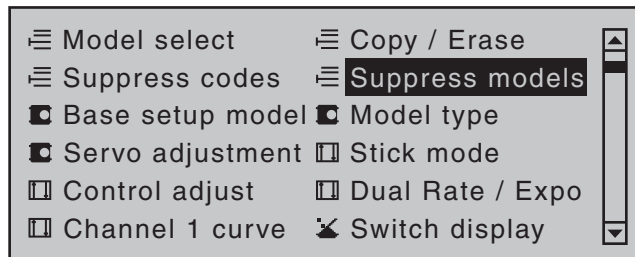
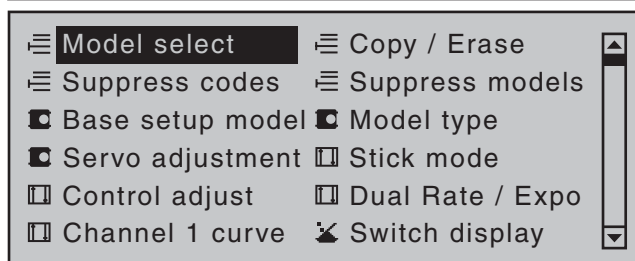

As many as 80 complete model settings, including digital trim values for the trim wheel, can be stored. Trimming is stored automatically such that a switchover from one model to another does not cause a loss of current trim settings. To the right of the model number, each occupied model memory line in this display shows a pictograph of the model type as well as the model's name entered for the model in its »**Basic settings, model**« menu, page 76 or 84. The code, if present, for the receiver "bound" to the model memory location will appear after the model number. Select the »**Model select**« menu with the selection

keys of the left or right touch pad then briefly tap on the **SET** key of the right touch pad.

Attention!
Switch-OFF
the Receiver first!

If this message appears, there is a telemetry connection to an operationally ready receiver system. Switch that receiver system off.

| | | | |
|----|--------------|--------------|-----------|
| 01 | Graubele | 1234g/080811 | 01:23hR16 |
| 02 | Ultimate | Test | 00:44hR12 |
| 03 | Starlet | trim needed | 00:33hR08 |
| 04 | BELL47G | | 00:22hR08 |
| 05 | *** free *** | | |
| 06 | *** free *** | | |

Now, with the ▲▼ selection keys of the left or right touch pad, select the desired model memory from the list and activate it with a tap on the **SET** key. A tap on the **ESC** key will cause a return to the previous menu page without activating a model change.

Notes:

- If, after a model change, the "Throttle too high" warning appears, the throttle/pitch joystick (C1) or the throttle limiter—by default, the right-side proportional rotary slider—is too far in the full throttle direction.
- If a model change causes the message ...

BIND. N/A
OK

... to appear then binding settings should be checked.

- If a model change causes the message ...

Fail Safe
setup
t.b.d.

... to appear then respective failsafe settings should be checked.

- If battery voltage is too low, the model switchover cannot be made due to reasons of safety. An appropriate message will appear in the screen:

not possible now
voltage too low

Copy / Erase

Erase or copy model → model, copy from or to SD card, copy flight phases, store/cancel changes

Use the ▲▼ selection keys of the left or right touch pad to select the »Copy / Erase« menu ...

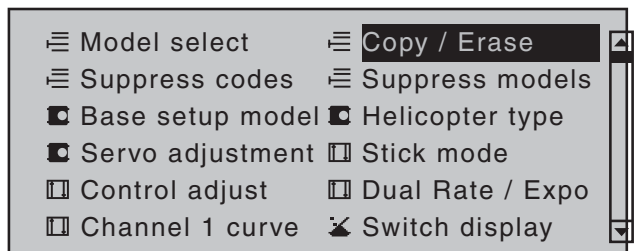
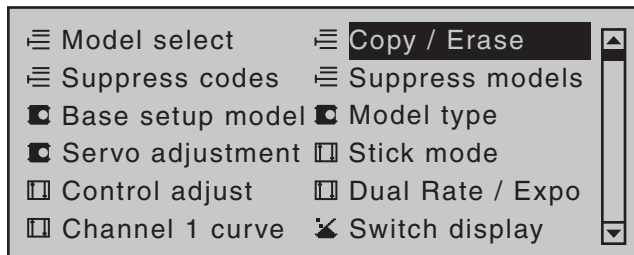

... then briefly tap the center **SET** key of the right touch pad.

Erase model

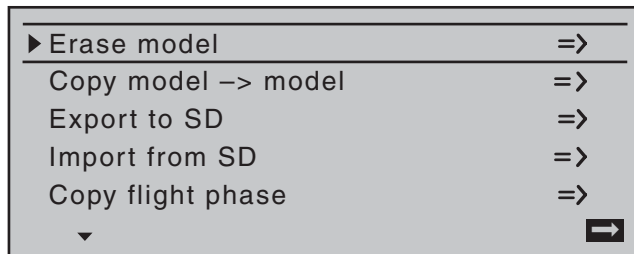

Select the "Erase model" sub-menu with the ▲▼ selection keys of the left or right touch pad then briefly tap on the **SET** key.

Choose the model to be erased with the ▲▼ selection keys of the left or right touch pad ...

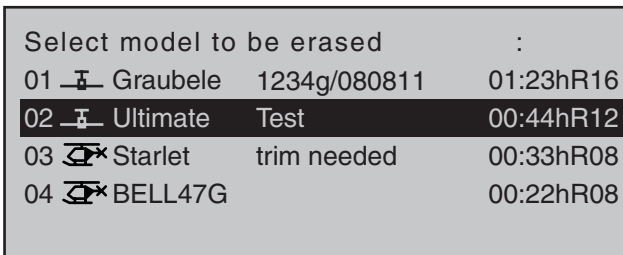

... whereby another tap on the **SET** key will cause the confirmation request ...

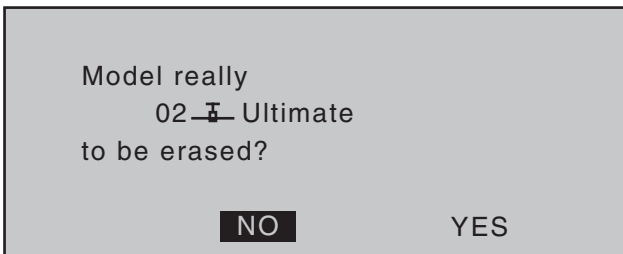

... to appear. A **NO** response will cause the process to be canceled and a return to the previous screen. Selecting the **YES** response with the ▶ selection key of the left or right touch pad followed by confirmation of the selection with a brief tap on the **SET** key will erase the selected model memory.

Caution:

This erase process cannot be undone. All data in the selected model memory will be erased completely.

Note:

*If the currently active model memory is to be erased, a model type "Winged" or "Heli" must be defined immediately after the erase process. If, however, an inactive memory location is erased, it will subsequently appear in "Model select" list as "***free***".*

Copy model → model

Select the »Copy model → model« sub-menu with the ▲▼ selection keys of the left or right touch pad then tap the **SET** key.

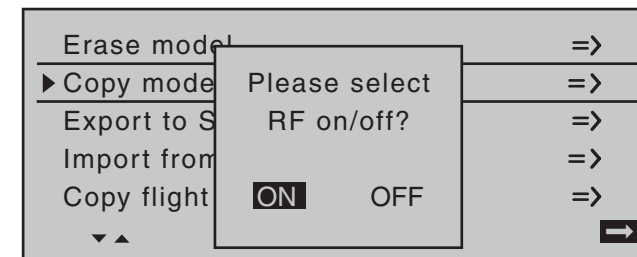

If the message shown above should appear, the transmitter's RF module is still active. Switch the RF module off as described on page 80 then also, if a receiver system is currently switched on, switch off that receiver too. This is to be done for reasons of safety.

Choose the model to be copied with the ▲▼ selection keys of the left or right touch pad ...

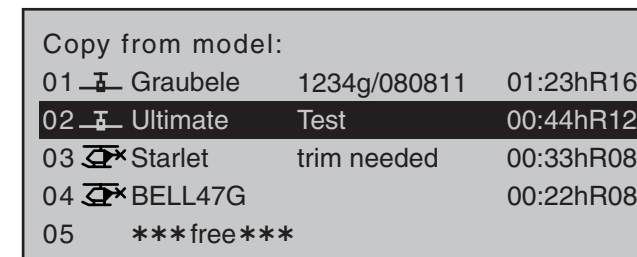

... then, following the change into the "Copy to model" window caused by another tap on the **SET** key of the right touch pad, the destination memory can be selected with the ▲▼ selection keys of the left or right touch pad. Yet another tap on the **SET** key will then confirm the copy process or a tap on **ESC** key will cause the copy to be canceled. A memory location which is already occupied can be overwritten.

| Copy | to model: | | |
|------|------------|--------------|-----------|
| 01 | Graubele | 1234g/080811 | 01:23hR16 |
| 02 | Ultimate | Test | 00:44hR12 |
| 03 | Starlet | trim needed | 00:33hR08 |
| 04 | BELL47G | | 00:22hR08 |
| 05 | ***free*** | | |

After confirming the selected model memory with a tap on the **SET** key, a confirmation request will appear:

Model really
02 Ultimate → 05 ***free***
to be copied?

NO YES

A **NO** response will cancel the process and return the screen to the originating screen. If the **YES** response is selected and confirmed with a tap on the **SET** key then the selected source model will be copied into the selected model memory destination.

Note:

In addition to model data, binding data is also copied by this process. This means that a receiver system which was/is bound to the original model memory can also be operated by its copy without establishing the bond again.

Exporting to SD card

Use the **▲▼** selection keys of the left or right touch pad to select the »Export to SD« sub-menu then tap on the **SET** key.

| | | |
|---------------|--|----|
| Erase model | | => |
| Copy mode | | => |
| ▶ Export to S | | => |
| Import from | | => |
| Copy flight | | => |
| ▼ ▲ | | ➔ |

Please select
RF on/off?
ON OFF

If the message shown above should appear, the transmitter's RF module is still active. Switch the RF module off as described on page 80 then also, if a receiver system is currently switched on, switch off that receiver too. This is to be done for reasons of safety. Choose the model to be exported with the **▲▼** selection keys of the left or right touch pad ...

export to SD-Card:

| | | | |
|----|------------|--------------|-----------|
| 01 | Graubele | 1234g/080811 | 01:23hR16 |
| 02 | Ultimate | Test | 00:44hR12 |
| 03 | Starlet | trim needed | 00:33hR08 |
| 04 | BELL47G | | 00:22hR08 |
| 05 | ***free*** | | |

After confirming the selected model memory with a tap on the **SET** key, a confirmation request will appear:

Model really
02 Ultimate
export?

NO YES

A **NO** response will cancel the process and return the screen to the originating screen. If the **YES** response is selected then confirmed with a tap on the **SET** key, the selected model will be copied to the SD card.

Notes:

- Should the notice ...



... appears instead of a screen for model selection, there is no SD card in the transmitter's card slot, see page 23.

- In addition to model data, binding data is also copied by this process. This means that a receiver system which was/is bound to the original model memory can also be operated in the SAME transmitter by its copy without establishing the bond again.
- An exported fixed-wing model will be stored on the memory card in the \\Models\mc-20 folder with a filename format of "aModelname.mdl" and a helicopter model with a filename format of "hModelname.mdl". On the other hand, if a "nameless" model is exported, its data will be stored on the memory card under "ahNoName.mdl" or "hNoName.mdl", as appropriate.
- Some special characters that can be used in model names are subject to specific restrictions associated with the FAT or FAT32 file system used by the memory cards and these special characters will be replaced during the copy process with a tilde (~).
- A model file already on the memory having the same name as the file to be copied will be overwritten without warning.

Importing from SD card

Use the ▲▼ selection keys of the left or right touch pad to select the »Import from SD« sub-menu then tap on the **SET** key.

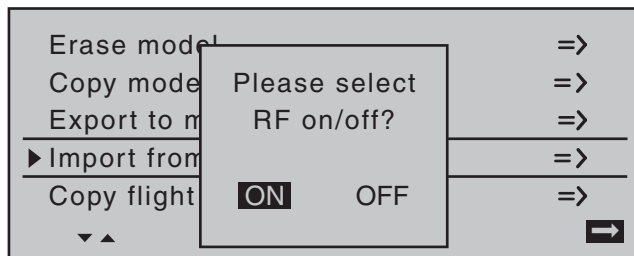

If the message shown above should appear, the transmitter's RF module is still active. Switch the RF module off as described on page 80 then also, if a receiver system is currently switched on, switch off that receiver too. This is to be done for reasons of safety. Select the model to be imported from the SD memory card with the ▲▼ selection keys of the left or right touch pad.

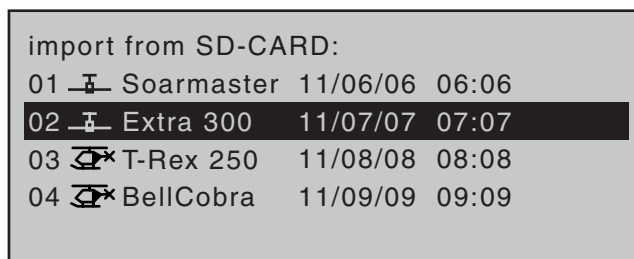

Note:

The export date posted at the right end of each model name line is represented in the format "year/month/day".

After another tap on the **SET** key of the right touch pad, the "import from SD-CARD" window will appear. Now the destination memory location can be selected with the ▲▼ selection keys of the left or right touch

pad then confirmed with a tap on the **SET** key, or the process can be canceled with a tap on the **ESC** key. A memory location which is already occupied can be overwritten.

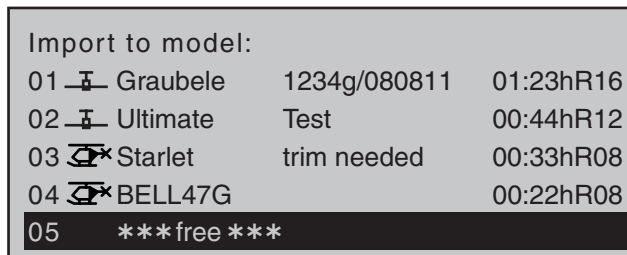

After confirming the selected model memory with a tap on the **SET** key, a confirmation request will appear:

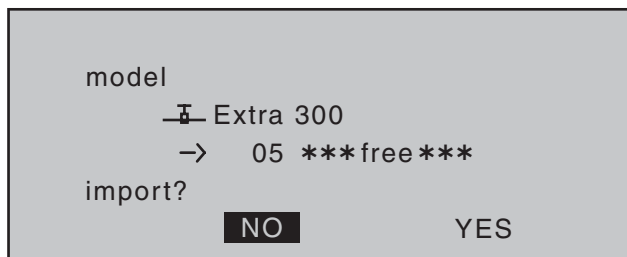

A **NO** response will cancel the process and return the screen to the originating screen. If the **YES** response is selected and confirmed with a tap on the **SET** key then the selected source model will be imported into the selected destination model memory.

Notes:

- If the message ...

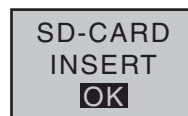

... appears instead of a screen for model selection, there is no SD card in the transmitter's

card slot, see page 23.

- In addition to model data, binding data is also imported by this process. This means that a receiver system which was/is bound to the original model memory can also be operated in the SAME transmitter by its copy without establishing the bond again.

Copy flight phase

Select the »Copy flight phase« sub-menu with the ▲▼ selection keys of the left or right touch pad then tap on the **SET** key.

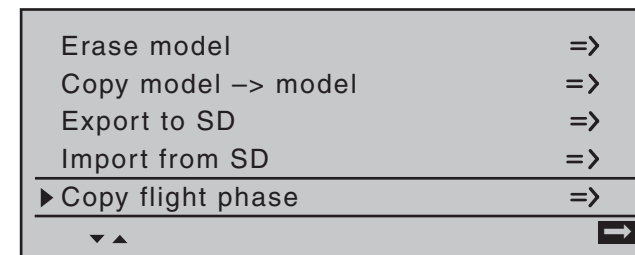

In the "Copy flight phase" sub-menu ...

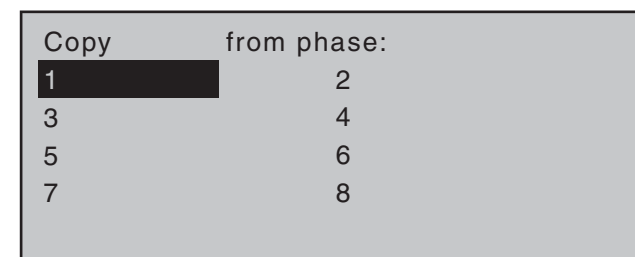

... the flight phase to be copied (1 ... 8 for fixed-wing models or 1 ... 7 for helicopter models) is selected with the selection keys of the left or right touch pad then confirmed with a brief tap on the **SET** key of the right touch pad. In the next window to appear ...

| Copy | to phase: |
|------|-----------|
| 1 | 2 |
| 3 | 4 |
| 5 | 6 |
| 7 | 8 |

... a destination must be selected and it must be confirmed too. Another confirmation request will follow:

Phase to:
 1 normal → 2 Thermik
 to be copied?

NO YES

A **NO** response will cancel the process and return the screen to the originating screen. If the ► **YES** response is selected and confirmed with a tap on the **SET** key then the selected source model will be imported into the selected destination model memory.

Storing changes permanently Undoing changes

These two sub-menus permit programming changes to be backed up immediately or to be undone (restored) to the state when the model was called up or the state of the last backup.

| | |
|----------------|----|
| Export to SD | => |
| Import from SD | => |
| Copy flight | => |
| Store change | => |
| ► Undo change | => |

Please select
RF on/off?
 ON OFF

If the message shown above should appear, the transmitter's RF module is still active. Switch the RF module off as described on page 80 then also, if a receiver system is currently switched on, switch off that receiver too. This is to be done for reasons of safety. Data is only backed up by "Store change" or a switch from one model to another in the »**Model select**« menu. Switching the transmitter on or off will *not* store the permanently. To store changes permanently, select the appropriate line then briefly tap on the center **SET** key of the right touch pad. The confirmation request shown below will appear:

Programming changes to be
store permanently?

NO YES

A **NO** response will cancel the process and return the screen to the originating screen. If the ► **YES** response is selected and confirmed with a tap on

the **SET** key then the changes made since the last backup or model change will be stored permanently.

If, however, the changes made since the last backup or model change are to be canceled, then select the line "Undo change". Following a brief tap on the center **SET** key of the right touch pad, the confirmation request shown below will appear:

Programming changes to be
reset to original?

NO YES

A **NO** response will cancel the process and return the screen to the originating screen. If the ► **YES** response is selected and confirmed with a tap on the **SET** key then the changes made since the last backup or model change will be stored permanently.

Note:

When the transmitter is switched off, any changes made will not be lost but they are not permanently stored either. This means that a subsequent "cancel changes" would reset memory to the state of the last "permanent backup" (or model change).

Suppress menus

Suppression of menus in the multifunction list

Use the ▲▼ selection keys of the left or right touch pad to select the »**Suppress codes**« menu ...

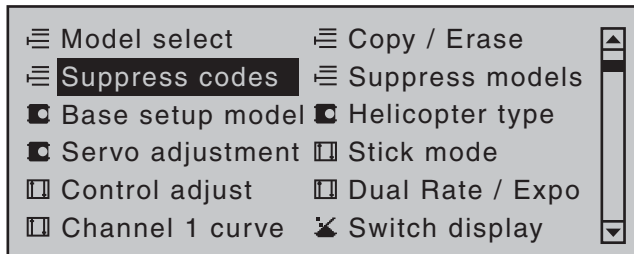
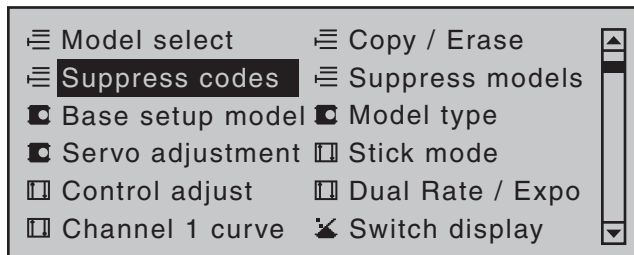

... then briefly tap the center **SET** key of the right touch pad.

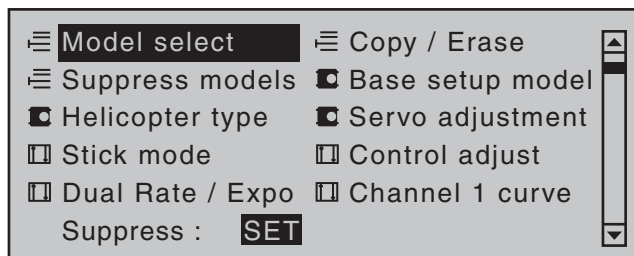
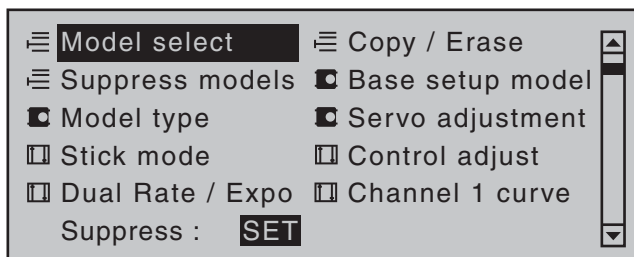

In the menu which then appears, menu items which are no longer needed or those which should not be changed, can be blocked from appearing in the multifunction list.

The option to be suppressed/displayed is selected with the selection keys of the left or right touch pad then its status is switched over with a tap on the center **SET** key of the right touch pad.

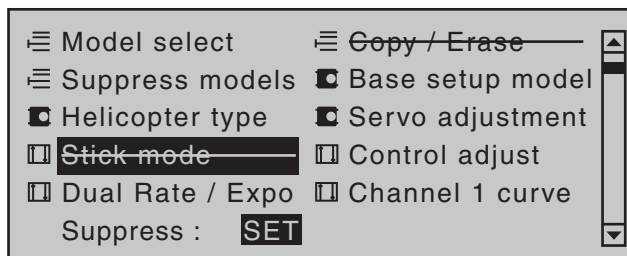
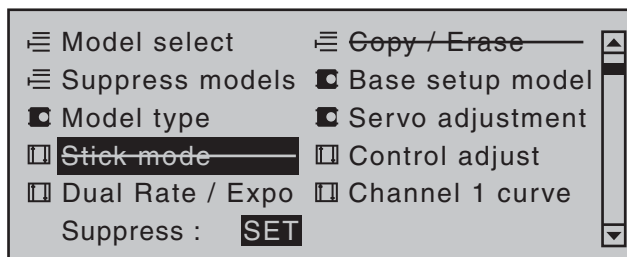

This can reduce the multi-function list considerably, in some cases to only a few menus, thus substantially improving clarity of the multi-function list. Options are not deactivated by being suppressed. They will simply no longer appear in the list. This also blocks direct access to these functions.

Tip:

If you wish to forgo access-blockage to the multi-function list altogether, suppress the »Code lock« menu in the multi-function list by way of this menu as a precautionary measure. It is then not so easy for an unauthorized person to lock up the transmitter.

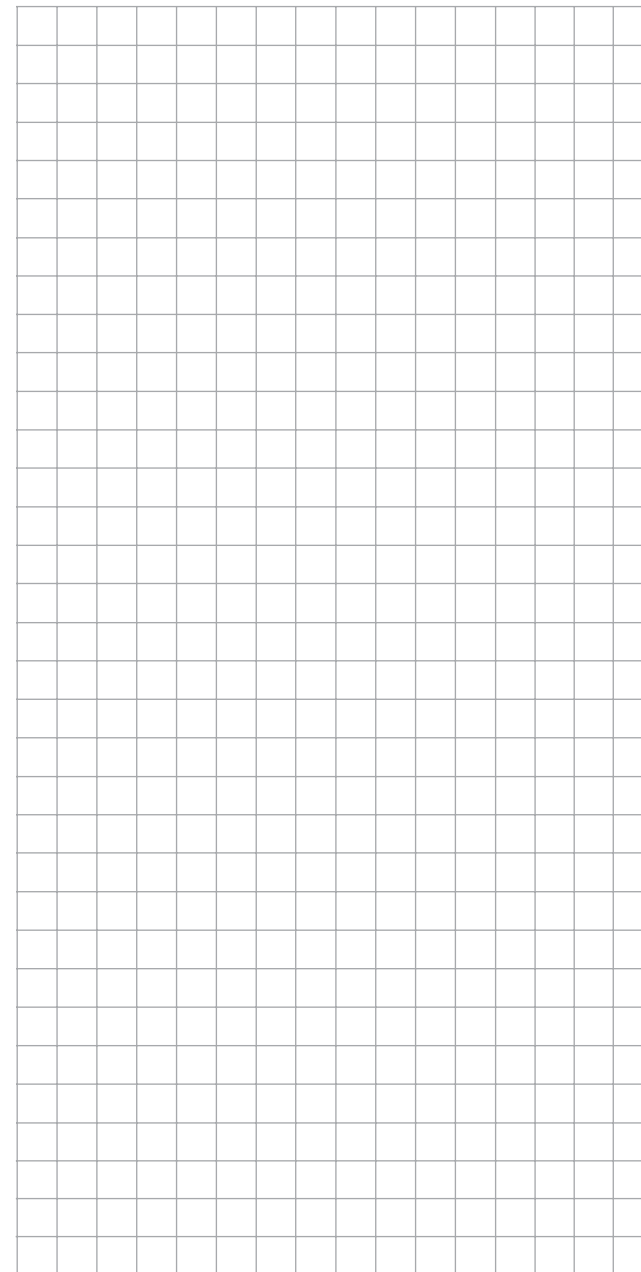

Suppress models

Suppression of model memory locations

Use the ▲▼ selection keys of the left or right touch pad to select the »**Suppress models**« menu ...

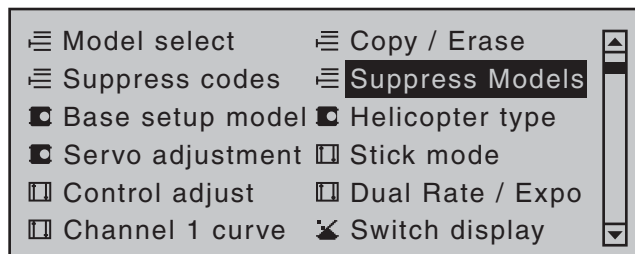
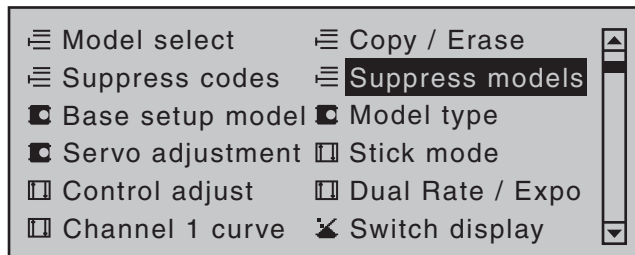

... then briefly tap the center **SET** key of the right touch pad.

Model memories which are rarely needed or to which access is to be blocked for other reasons can be hidden from the model selection list. This also clarifies the overview layout for model selection.

The model to be suppressed/displayed is selected with the selection keys of the left or right touch pad then its status is switched over with a tap on the center **SET** key of the right touch pad.

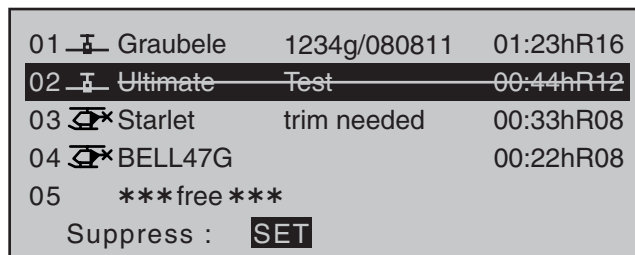

A model memory which is "stricken through" will no longer appear in the »**Model select**« menu.

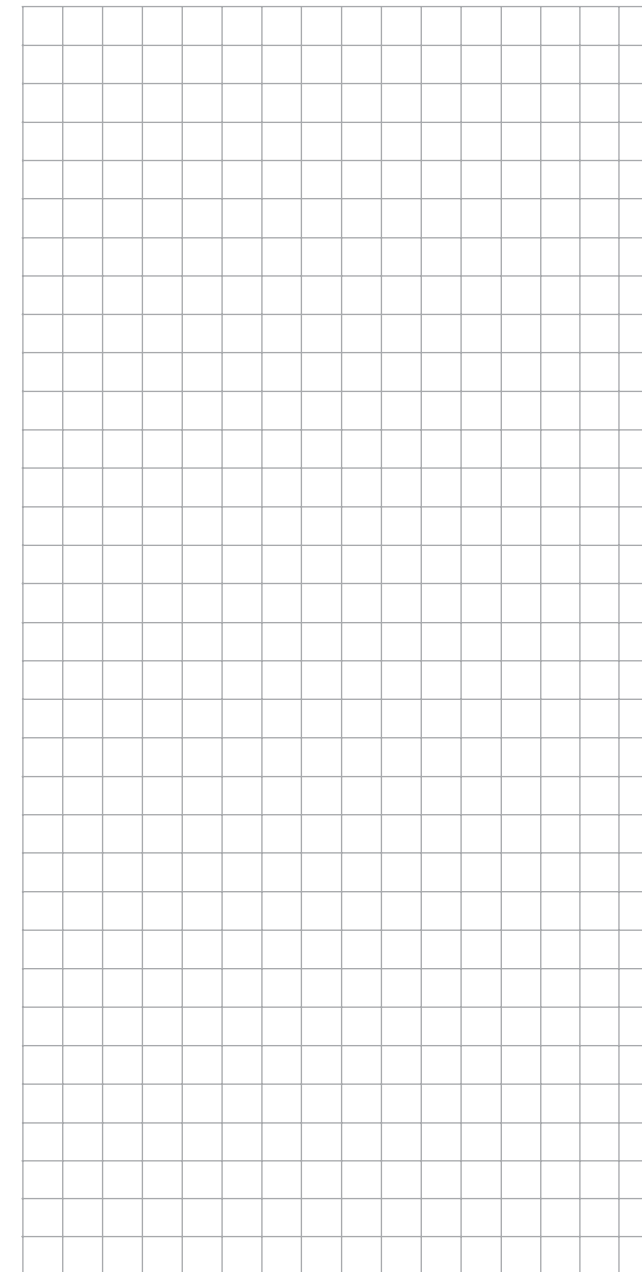
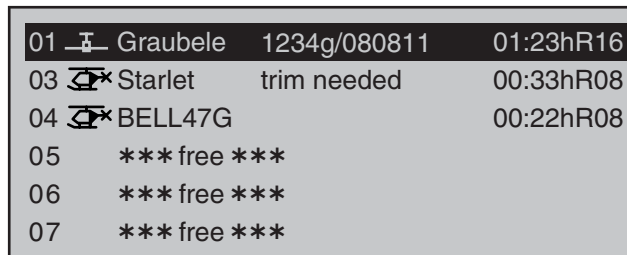

Base setup model

Model-specific base settings for winged aircraft models

Before programming specific parameters, there are some basic settings to be made which effect the currently active model memory.

Use the selection keys of the left or right touch pad to select the »**Basic settings, model**« menu ...

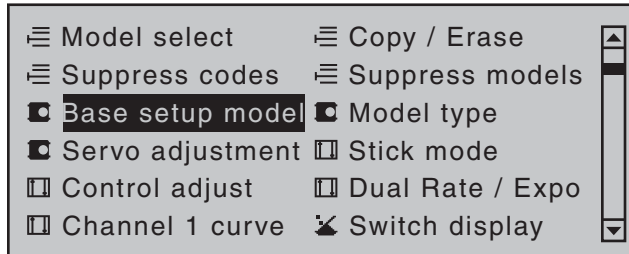

... then tap the center **SET** key of the right touch pad.

Model name

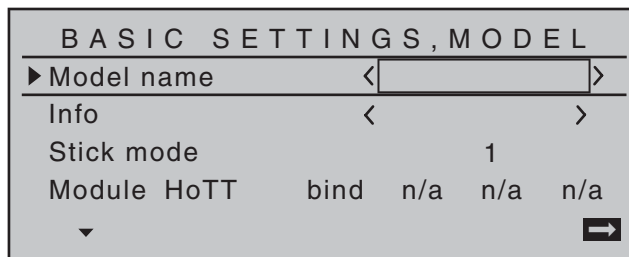

Change to the next screen page with a brief tap on the **SET** key of the right touch pad. This will open a screen of characters for entry of the model's name. A maximum of 13 characters can be used to specify a model name.

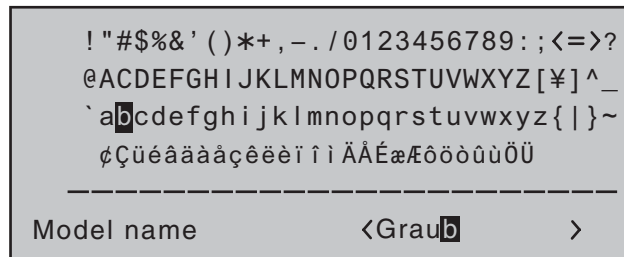

Now the desired characters can be selected with the selection keys of the left touch pad. Move to the next position to select the next character with a tap on the ► selection key of the right touch pad or its center **SET** key. A simultaneous tap on the ▲▼ or ◀▶ keys of the right touch pad (**CLEAR**) will place a space character at the current position.

Positioning to any character position within the entry field can be done with the ◀▶ keys of the right touch pad. A return to the previous menu screen is accomplished with a tap on the center **ESC** key of the left touch pad.

A model name entered in this manner will appear in the base screen of the »**Model select**« menu and in the sub-menus of the »**Copy / Erase**« menu item.

Info

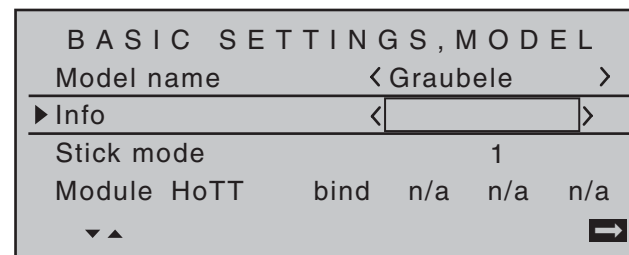

Every model can be given a supplementary note of up to 12 characters (maximum) by following the same procedure as already described for creating a "Model name". This info note will appear as a supplement in the »**Model select**« menu and in the sub-menus of the »**Copy / Erase**« menu item.

Stick mode

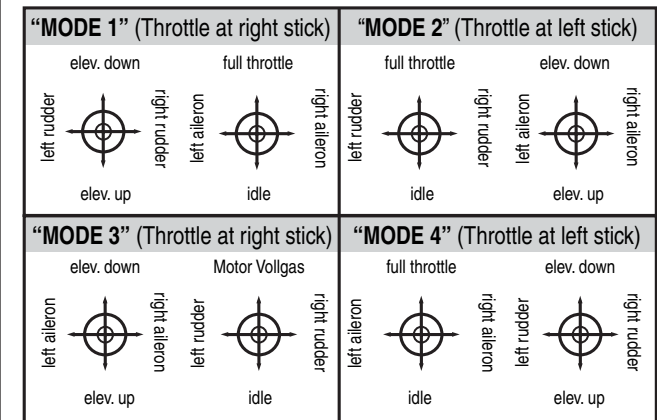

There are four fundamental options for assigning the four control functions (aileron, elevator, rudder and throttle/brake flap) for a winged aircraft model to the two joysticks. Just which of these options is chosen depends on the individual preferences of the individual model pilot.

Use the ▲▼ selection keys of the left or right touch pad to select the "Stick mode" line. The option field will be framed.

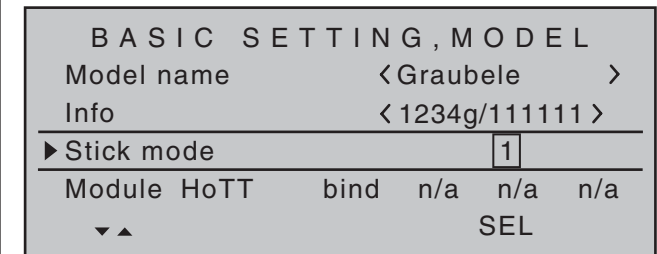

Tap on the **SET** key. The currently displayed stick mode will be displayed in inverse video. Now use the selection keys of the right touch pad to select from among options 1 through 4.

A simultaneous tap on the ▲▼ or ◀▶ keys of the right touch pad (**CLEAR**) will reset the display to stick mode "1".

Another tap on the **SET** key will again deactivate option selection so a change to another line can be affected.

Module

| | | | | | |
|-----------------------|------------------|-----|-----|-----|-----|
| BASIC SETTING , MODEL | | | | | |
| Model name | < Graubele > | | | | |
| Info | < 1234g/111111 > | | | | |
| Stick mode | 1 | | | | |
| ▶ Module HoTT | bind | n/a | n/a | n/a | |
| ▼ ▲ | SEL | BD1 | BD2 | BD3 | BD4 |

The **MC-20** transmitter has a HoTT RF module as standard equipment. In addition to the built-in module, there is a connector for an external RF module behind one of the two front cover flaps (see page 25) and a switchover to an external module connected there can be affected per software. To do this, use the selection keys of the left or right touch pad to move the marker frame left to the "Module" selection field above the "SEL" column label.

HoTT

Graupner HoTT receivers must be "instructed" to communicate exclusively with a certain model (memory) in a *Graupner* HoTT transmitter. This procedure is known as "binding" and must only be done *once* for every new receiver/model-memory-location combination (and can be repeated anytime).

Important notices:

- **During the binding procedure be sure the transmitter's antenna is always far enough away from the receiver's antenna. To be on the safe side, keep them at least one meter apart. Otherwise there is a risk of a faulty connection to the return channel and malfunctions will result.**
- **When binding additional receivers, note that any other –switched on–receivers already bound**

to the transmitter will fall into Fail-safe mode during the transmitter-side "binding" period.

"Binding" multiple receivers per model

Multiple receivers per model can be bound if desired, whereby respective **MC-20** HoTT programs offer the potential for managing up to four receivers directly and for dividing up the transmitter's 16 control channels (max) in any arrangement among these receivers under menu control. Refer to additional details further down in this section. First bind the receivers individually as described below.

However, in subsequent operation only one of these receivers will establish a telemetry bond to the transmitter; the one which was activated in the "TELEMETRY RCV" line of the »Telemetry« menu.

| | |
|--------------------|---------|
| TELEMETRY | |
| ▶ TELEMETRY RCV | BIND. 1 |
| SETTING & DATAVIEW | |
| SENSOR SELECT | |
| RF STATUS VIEW | |
| VOICE TRIGGER | |

Any telemetry sensors which may be built into the model should therefore be connected to this receiver because the transmitter only receives and evaluates data from the return channel of the receiver *activated on this line*. The second, and all other receivers, operate in parallel but are fully independent in slave mode.

"Binding" transmitter and receiver

Use the ▲▼ selection keys of the left or right touch pad to move into the "Module" line. The marker frame will be positioned by default to the column for the next free binding channel. In the example shown in the figure below, the marker frame is positioned above the column label "BD2" because the binding channel in the column labeled "BD1" is already in use by default for the receiver which was delivered with the set.

| | | | | | |
|-----------------------|------------------|-----|-----|-----|-----|
| BASIC SETTING , MODEL | | | | | |
| Model name | < Graubele > | | | | |
| Info | < 1234g/111111 > | | | | |
| Stick mode | 1 | | | | |
| ▶ Module HoTT | bind | n/a | n/a | n/a | |
| ▼ ▲ | SEL | BD1 | BD2 | BD3 | BD4 |

If not already off, now switch the receiver on. The red LED on the receiver will blink.

Press and hold the **SET** button on the receiver while the LED continues to blink red for about 3 seconds then, after about another 3 seconds, begins to blink red/green. The **SET** button on the receiver can now be released. As long as this LED blinks red/green, the receiver is in bind mode.

Now, within this 3 second period, start the so-called "receiver binding" process for the receiver to the currently active model memory with a brief tap on the center **SET** key of the right touch pad. At this time, the screen's display will blend in a message window for the duration of the "binding" process.

| | | | | | |
|-----------------------|------------------------|-----|-----|-----|-----|
| BASIC SETTING , MODEL | | | | | |
| Model name | < Graubele > | | | | |
| Info | FINDING... 4g/111111 > | | | | |
| Stick mode | 1 | | | | |
| ▶ Module HoTT | bind | n/a | n/a | n/a | |
| ▼ ▲ | SEL | BD1 | BD2 | BD3 | BD4 |

If the receiver's LED, again blinking red, changes within about 10 seconds to continuous illumination in green, the binding process has been successfully completed. Your model-memory to receiver combination is now operationally ready. At this time the screen will now display " bind " (bound) instead of "n/a" (not attached).

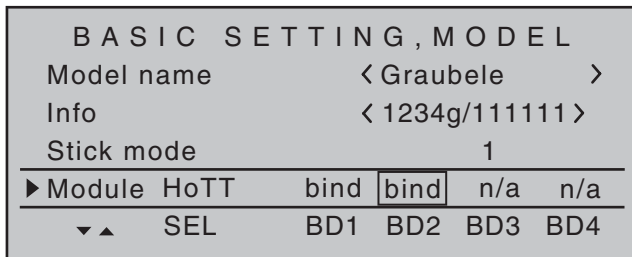

On the other hand, should the LED on the receiver blink red for longer than about 10 seconds, the binding process has failed. In this case the screen will continue to show the status as "n/a". If this should happen, try changing the position of antennas then repeat the entire procedure.

Binding other receivers

The binding channel you have chosen is already bound (as indicated by the "bind" status). with another binding channel. After initiating the RF bind process, instead of displaying "BINDING", the message shown below appears.



Drop down two lines in the screen and switch off the RF module as described on the page in section "RF module". Afterward, return again to the "Module" line and restart the binding process as described above. Alternatively, the transmitter can be switched off briefly then, after switching it back on again, respond to the message window that appears ...

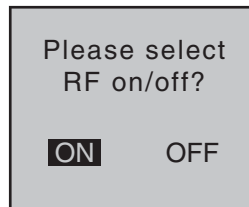

... with "OFF" ...

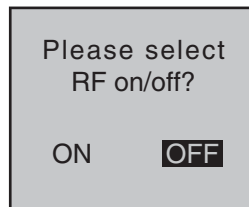

... then confirm the selection with a brief tap on the center **SET** key of the right touch pad. From the base screen jump again into the "Module" line of the »Basic settings, model« menu and restart the binding process.

Dissolving a bond

Proceed as described above to initiate the binding process but WITHOUT first putting a receiver in binding readiness.

EXT. PPM

Important notice:

With the activation of the value field in the context of the following described changeover, any existing bonds to HoTT receivers which may be effective for the currently active model memory will be lost.

Activate the first value field in the "Module" line with a tap on the center **SET** key of the right touch pad then use the selection keys to choose "EXT. PPM" instead of "HoTT". In parallel with the selection of "EXT. PPM", the other four value fields will be replaced by the type of modulation pre-selected in the line »DSC Output«, see page 81.

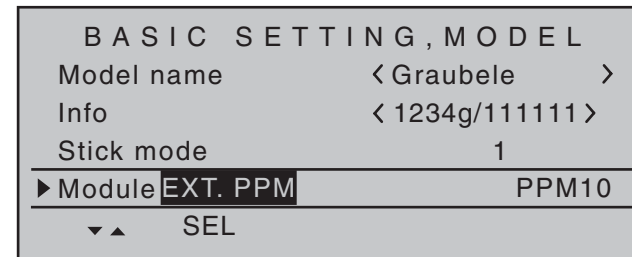

This change also suppresses the lines for the options (described below): »HoTT«, »Rcv Ch Map«, »RF module« and »RF range test« and, in the basic display, "PPM" will be displayed instead of "HoTT".

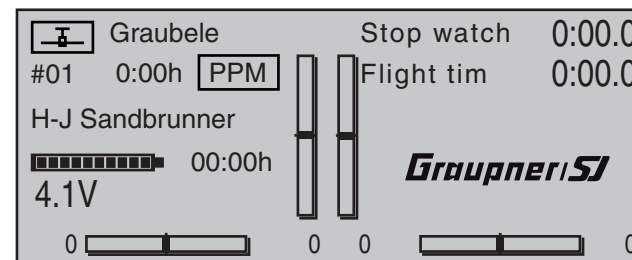

Receiver channel mapping

As long as there is at least one "bound" receiver in the "Module" line, the next line down will be the "Rcv Ch map" line.

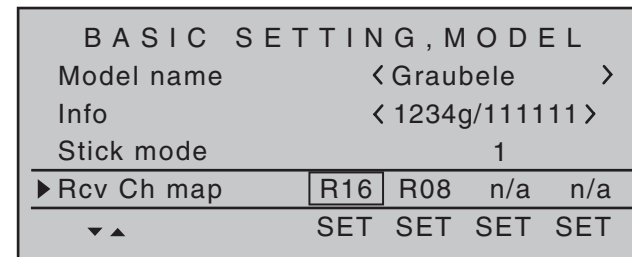

As mentioned in the introduction to the "Binding receivers" section, this menu item of the **MC-20** HoTT offers both the opportunity to freely divide up the transmitter's control channels *within a receiver* as well as the opportunity to distribute the transmitter's 16

control channels across *as many as four receivers*. This redistribution is subsequently referred to as "mapping" or "channel mapping" (channel correlation). Select the receiver to be "mapped" with the selection keys of the left or right touch pad then tap briefly on the center **SET** key of the right touch pad.

Channel mapping within a receiver

Analogous to the channel correlation function in the »Telemetry« menu on page 232, described as "Channel Mapping", it is very simple to use this menu item to freely assign the transmitter's control channels present on the receiver's inputs to any specific receiver outputs (servo connections) for the bound receiver designated by the column labeled BD1.

| RECEIVER CHANNEL MAP BIND1 | | | |
|----------------------------|---|----|----------------|
| ► Rx Input Ch | 1 | -> | Rx Output Ch 1 |
| Rx Input Ch | 2 | -> | Rx Output Ch 2 |
| Rx Input Ch | 3 | -> | Rx Output Ch 3 |
| Rx Input Ch | 4 | -> | Rx Output Ch 4 |
| ▼ | | | |

After selection of the desired *output* with the selection keys of the left or right touch pad, the appropriate value field will be framed. Briefly tap on the center **SET** key of the right touch pad. The current setting will be displayed in inverse video. Now use the selection keys of the right touch pad to select the desired input channel's respective transmitter output, see page 218.

Note:

The number of lines available in the list (outputs) corresponds to the maximum number of servos which can be attached to the given receiver.

BUT CAUTION: If, for example, "2AIL" has been specified in the "Aileron/camber flaps" line of the »Model type« menu then the transmitter will have allocated *control function 2 (ailerons) to control*

channels 2 & 5 for the left and right ailerons. The corresponding *receiver inputs* to be assigned in this case would be channels 2 & 5, refer to the example below.

Examples:

- You would like to control each aileron of a large model with two or more servos.

Assign each of the appropriate outputs (servo connections) to one and the same input (control channel). In this case, depending on left or right wing, as the respective input to one of the two default aileron control channels (2 or 5).

- You would like to control the rudder of a large model with two or more servos.

Assign each of the appropriate outputs (servo connections) to one and the same input (control channel). In this case, the default rudder channel (4), see figure bottom right.

Important notice:

*The **MLC-20** HoTT transmitter's »Tx. output swap« option permits the transmitter's 16 control functions to be freely swapped in a similar manner or even permits multiple outputs to be assigned to the same control function. To keep controls manageable, however, we strongly recommend using only one of the options at a time.*

Channel assignment on other receivers

As already mentioned, the "Rcv Ch map" menu option can be used to freely distribute the **MLC-20** HoTT transmitter's 16 control channels across *up to four receivers*, whereby the numbering of outputs (servo connections) as well as the maximum number of available lines (outputs) will correspond to the maximum number of servo connections available on the given receiver.

| RECEIVER CHANNEL MAP BIND2 | | | |
|----------------------------|----|----|----------------|
| ► Rx Input Ch | 16 | -> | Rx Output Ch 1 |
| Rx Input Ch | 16 | -> | Rx Output Ch 2 |
| Rx Input Ch | 16 | -> | Rx Output Ch 3 |
| Rx Input Ch | 16 | -> | Rx Output Ch 4 |
| ▼ | | | |

After selection of the desired *output* with the selection keys of the left or right touch pad, the respective input field will be framed. Tap the center **SET** key of the right touch pad. The current setting will be displayed in inverse video. Now select the desired input channel with the selection keys of the right touch pad. For example, suitable to the above rudder example.

| RECEIVER CHANNEL MAP BIND2 | | | |
|----------------------------|---|----|----------------|
| ► Rx Input Ch | 4 | -> | Rx Output Ch 1 |
| Rx Input Ch | 4 | -> | Rx Output Ch 2 |
| Rx Input Ch | 4 | -> | Rx Output Ch 3 |
| Rx Input Ch | 4 | -> | Rx Output Ch 4 |
| ▼ | | | |

Note:

The number of lines available in the list (outputs) corresponds to the maximum number of servos which can be attached to the given receiver.

RF transmit

This menu line provides an option for manually switching the transmitter's RF transmission on and off to specific models while the transmitter is in operation. For example, to save power while a model is being programmed. **If this line option was set to OFF, it will be canceled (i.e. set to ON) the next time the transmitter is switched on.**

If necessary, use the ▲▼ selection keys of the left or right touch pad to move into the " RF transmit " line

then activate the option with a brief tap on the center **SET** button of the right touch pad.

| BASIC SETTING, MODEL | | | | |
|----------------------|------|------|-----|-----|
| Stick mode | | | | 1 |
| Module HoTT | bind | bind | n/a | n/a |
| Rcv Ch Map | R16 | R08 | n/a | n/a |
| ▶ RF transmit | | | | on |
| ▼ ▲ | SEL | | | |

The right selection keys can now be used to choose between **OFF** and **ON**. Another tap on the center **SET** key of the right touch pad will conclude the entry.

Range test

The built-in range test reduces transmission power to an extent that a functional test can be carried out even within a distance of less than 100 m.

Perform a range test on the *Graupner* HoTT system according to the following instructions. If necessary, have someone assist you in carrying out the range test.

1. Preferably, the receiver already bound to the transmitter should be installed into the model in its intended position.
2. Switch remote control on and wait for the green LED to light up on the receiver/s. Now servo movements can be observed.
3. Place the model on a level surface (pavement, low-cut grass or bare ground) such that receiver antennas are at least 15 cm above ground level. It may be necessary to put something under the model to raise it up enough for this.
4. Hold the transmitter at hip level and at some distance from one's body. Do not point the antenna directly at the model but rather turn and/or kink the antenna's end so that it is oriented vertically during the test.

5. If necessary, use the ▲▼ selection keys of the left or right touch pad to reach the "RF range test" line in the menu then start range test mode with a tap on the center **SET** key of the right touch pad.

| BASIC SETTING, MODEL | | | | |
|----------------------|------|------|-----|-----|
| Module HoTT | bind | bind | n/a | n/a |
| Rcv Ch Map | R16 | R08 | n/a | n/a |
| RF transmit | | | | on |
| ▶ RF range test | | | | 99s |
| ▼ ▲ | SEL | | | |

When the range test has been initiated, the transmitter's transmission power will be significantly reduced and the LED just to the right of the main switch on the transmitter, marked RF, will begin to blink; this will also be accompanied by acoustic tones. At the same time, the timer in the transmitter's display will start counting down and every 5 seconds a two-frequency tone will sound. Five seconds prior to the end of the range test a three-frequency tone will sound once every second. After expiration of the range test's 99th second the transmitter will again be switched to full output power and the LED just to the right of the main switch on the transmitter will again illuminate constantly.

6. Move away from the model while manipulating the joysticks during this timespan. If you notice an interruption anytime while still within a distance of about 50 m, try to reproduce this malfunction.
7. If there is a motor in the model, it may be necessary to switch it on to further check noise immunity.
8. Continue moving away from the model until perfect control is no longer possible.
9. Wait at this distance for the remainder of the test period with the still-operationally-ready model to expire. After the range test is ended it should

again respond correctly to all RC controls. If this is not 100% the case, do not use the system. Contact your area's *Graupner* GmbH & Co. KG service partner.

10. Perform the range test before each flight and, in doing so, simulate all servo movements which also take place during flight. The range must always be at 50 m on the ground in order to assure safe model operation.

Caution:

Never start the range test on the transmitter during normal operation of the model.

DSC output

If necessary, use the ▲▼ selection keys of the left or right touch pad to switch to the "DSC Output" line then, with a brief tap on the center **SET** key of the right touch pad, activate the value window:

| BASIC SETTING, MODEL | | | | |
|----------------------|-----|-----|-----|-------|
| Rcv Ch Map | R16 | R08 | n/a | n/a |
| RF transmit | | | | on |
| RF range test | | | | 99s |
| ▶ DSC Output | | | | PPM10 |
| ▼ ▲ | SEL | | | |

Now you can use the right selection keys to choose between four types of modulation "PPM10", "PPM16", "PPM18" and "PPM24". Touch the center **SET** key of the right touch pad again to complete the entry.

This choice primarily influences the maximum number of control channels which can be attached to the DSC (direct servo control) socket, and thus also available to a flight simulator or teacher/pupil system. By selecting "PPM10" this will be control channels 1 ... 5, for "PPM16" channels 1 ... 8, for "PPM18" channels 1 ... 9 and for "PPM24" channels 1 ... 12.

Motor cutoff (Thr. CutOff)

Note:

This menu line is suppressed if "None" or "None/inv" is selected for the "Motor on C1" line.

Depending on the "idle forward or back" choice made in the "Motor on C1" line of the »**Model type**« menu, this motor "cut off" option can be coupled to a switch for throttling down a speed controller or to move a servo on the carburetor of a motor to the OFF position. This option not only replaces the "Cut-off trim" function known from other *Graupner mc* and *mx* transmitters but also serves as an Emergency-OFF function at the same time, which was not possible with the "Cut-off trim" function.

This motor OFF position (Thr. CutOff) is specified in the left column field over the column label **SEL** and its value is to be established through trial and error.

A speed controller or throttle servo will only take on this preset position when a certain servo position or threshold is underrun and a switch is activated. This is done by setting the desired servo position (threshold value) into the middle column field, directly over the column label **STO**, then selecting the appropriate

ON/OFF switch function in the right column.

- If the percentage value specified for the middle column is *greater* than the current servo position, i.e. the current servo position lies *below* the threshold, the switchover will occur as soon as the switch is put into its ON position.
- If the percentage value specified for the middle column is *less* than the current servo position, i.e. the current servo position is *above* the threshold, the speed controller will initially reduce motor speed or close the carburetor's throttle servo only to the extent dictated by the value in the left column as soon as the servo's position once *underruns* the threshold (max. +150%) after the

switch is changed over to its ON position.

The speed controller or throttle servo will remain in this cut-off position only until the selected switch is again changed over followed by a one-time throttle servo or speed controller movement beyond the preset threshold with the throttle/brake joystick control.

The factory setting for the left column is -100% for the throttle servo "cut-off" position and a threshold of +150% servo position setting in the middle column.

| BASIC SETTING , MODEL | | | |
|-----------------------|-------|-------|-----|
| RF transmit | on | | |
| RF range test | 99s | | |
| DSC Output | PPM10 | | |
| ▶ Thr. CutOff | -100% | +150% | --- |
| ▼ ▲ | SEL | STO | ↘ |

Programming procedure

To change the throttle servo's preset "cut-off" position, tap on the center **SET** key of the right touch pad. The current setting will be displayed in inverse video. Now use the selection keys of the left or right touch pad to set a value at which the motor is reliably "off". If a combustion motor is involved, be sure the throttle servo does not perform mechanical runout, e.g. -125%.

| BASIC SETTING , MODEL | | | |
|-----------------------|-------|-------|-----|
| RF transmit | on | | |
| RF range test | 99s | | |
| DSC Output | PPM10 | | |
| ▶ Thr. CutOff | -125% | +150% | --- |
| ▼ ▲ | SEL | STO | ↘ |

The –upper– preset value in the middle column ensures the motor can be stopped, throughout the

maximum possible positioning range of the servo or speed controller, alone by the switch to be assigned in the right column.

However, if you wish to set a lower threshold, by which an underrun will cause the throttle servo or speed controller with closed switch to switch into the cut-off position, reduce the preset servo travel from +150% by placing the throttle servo or speed controller into the desired position with the throttle/brake joystick then touch the center **SET** key of the right touch pad.

| BASIC SETTING , MODEL | | | |
|-----------------------|-------|-------|-----|
| RF transmit | on | | |
| RF range test | 99s | | |
| DSC Output | PPM10 | | |
| ▶ Thr. CutOff | -125% | +150% | --- |
| ▼ ▲ | SEL | STO | ↘ |

Finally, use the column at the right to specify a switch with which you can cut off the motor directly (emergency) or which will be activated by the threshold.

| BASIC SETTING , MODEL | | | |
|-----------------------|-------|-------|----|
| RF transmit | on | | |
| RF range test | 99s | | |
| DSC Output | PPM10 | | |
| ▶ Thr. CutOff | -125% | +100% | 8↓ |
| ▼ ▲ | SEL | STO | ↘ |

Notes:

- Be sure the throttle servo does not run out mechanically when the cut-off function is activated.
- A threshold over +100% is reached by temporarily increasing the travel for servo 1 in the »**Servo adjustment**« menu to over 100% then, after storing the threshold, change servo travel back to

the original value.

Power-on warning

| BASIC SETTING, MODEL | | | |
|----------------------|-------|-------|----|
| RF range test | | 99s | |
| DSC Output | | PPM10 | |
| Motor Stop | -125% | +100% | 8↓ |
| ▶ Thr. CutOff | | ---- | |
| ▼ ▲ | | / - | |

When a switch, a control switch or a logical switch is assigned in this line as described in the section "Assigning transmitter controls, switches and control switches" on page 56, the respective switch or control position will be polled and an appropriate warning will be blended into the basic display under some conditions. In combination with logical switches, almost any switch setting can be called up for transmitter switch on.

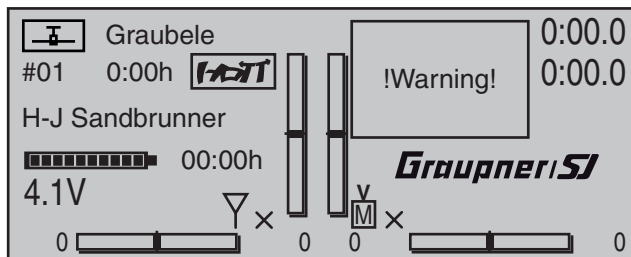

Auto trim

| BASIC SETTING, MODEL | | | |
|----------------------|-------|-------|----|
| DSC Output | | PPM10 | |
| Thr. CutOff | -125% | +100% | 8↓ |
| Power on warning | | L1↓ | |
| ▶ Auto trim | | ---- | |
| ▼ ▲ | | / - | |

The "Auto trim" option makes it possible to trim a model quickly and without complications, e.g. in the context of a first-flight or even after (major) repairs, etc. Typically such test flights are initially flown with joysticks counter operated until the desired state of flight is achieved. This generally involves working the trim controls during the flight to "unburden" the joysticks. This is exactly what the "Auto trim" function is for. After the desired flight attitude has been achieved via control functions 2 ... 4 (aileron, elevator and rudder), the switch assigned to "Auto trim"—ideally one of the standard-equipment momentary switches in the switch panels—is to be activated ONCE. At the instant the switch is activated, the joystick offsets from their neutral positions will be determined and adopted as trim values. However, this does not take place instantaneously but rather within about 1 second. During this period after the switch has been activated, the joysticks should be returned to their normal positions.

Notes:

- Due to the complex interaction inherent to multi-flap models, the Auto trim function for ailerons is deactivated if "2AIL 2FL" and "2AIL 4FL" or "4AIL 2FL" and "4AIL 4FL" is selected in the "Aileron/camber flaps" line of the »Model type« menu.
- Be sure that during the switch assignment, the joysticks for aileron, elevator and rudder are in

their neutral positions as otherwise their offsets from neutral will be adopted right away in trim memory as the trim value.

- Since EVERY activation of the Auto trim switch has a cumulative effect, after concluding an "auto trim" flight, the assigned auto trim switch should be deactivated for reasons of safety. Otherwise there is a residual danger that the "Auto trim" function could be activated accidentally.

ext. PPM signal

| BASIC SETTING, MODEL | | | |
|----------------------|-------|--------|----|
| Thr. CutOff | -125% | +100% | 8↓ |
| Power on warning | | L1↓ | |
| Auto trim | | ---- | |
| ▶ ext. PPM signal | | normal | |
| ▼ ▲ | | SEL | |

Some RF modules which can be connected to the external (page 25) or internal (page 26) connectors for other RF modules require an inverted input signal. Be sure to follow the respective module's installation instructions for this.

The choice of "inverted" instead of the default preset "normal" allows for appropriate adaptation of the provided PPM signal.

A simultaneous tap on the ▲▼ or ◀▶ keys of the right touch pad (**CLEAR**) will reset the display to "normal".

Auto timer reset

| | |
|----------------------|--------|
| BASIC SETTING, MODEL | |
| Power on warning | L1↓ |
| Auto trim | --- |
| ext. PPM signal | normal |
| ▶ Auto timer reset | yes |
| ▲ | SEL |

The "yes/no" setting made in this line determines whether or not all of the transmitter's timers (except for "Model time" and "Transmitter operating time") are automatically reset to their given starting values when the transmitter is switched on.

A simultaneous tap on the ▲▼ or ◀▶ keys of the right touch pad (**CLEAR**) will reset the display to "yes".

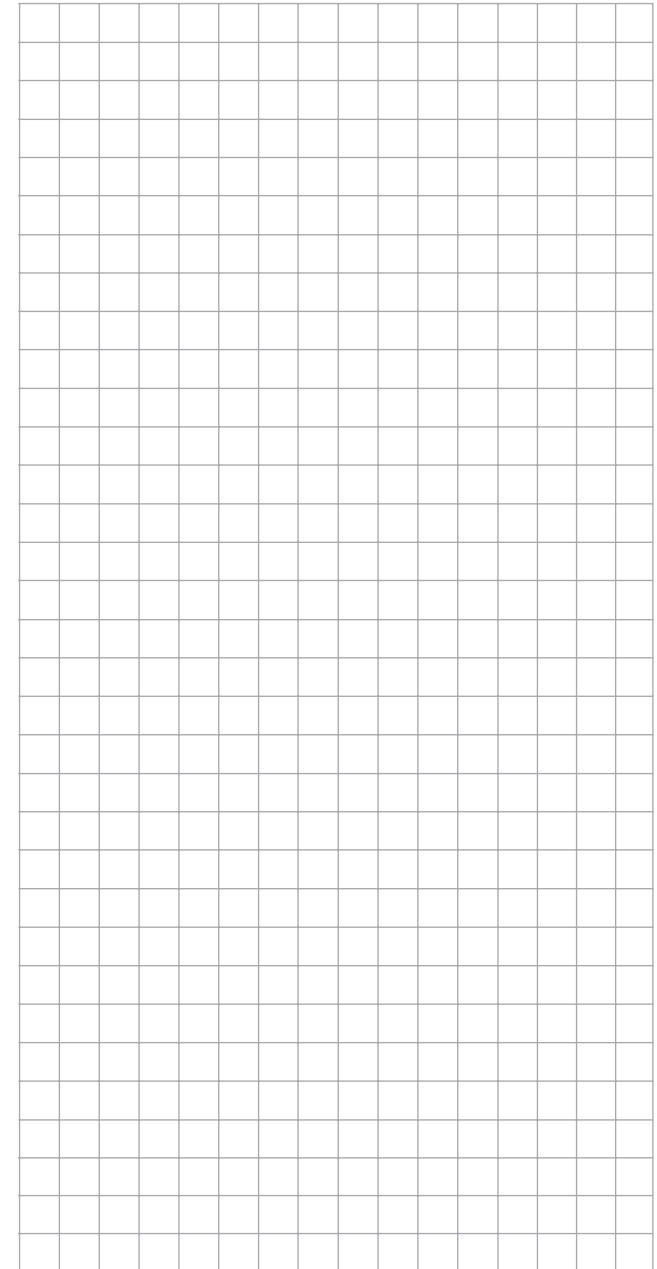
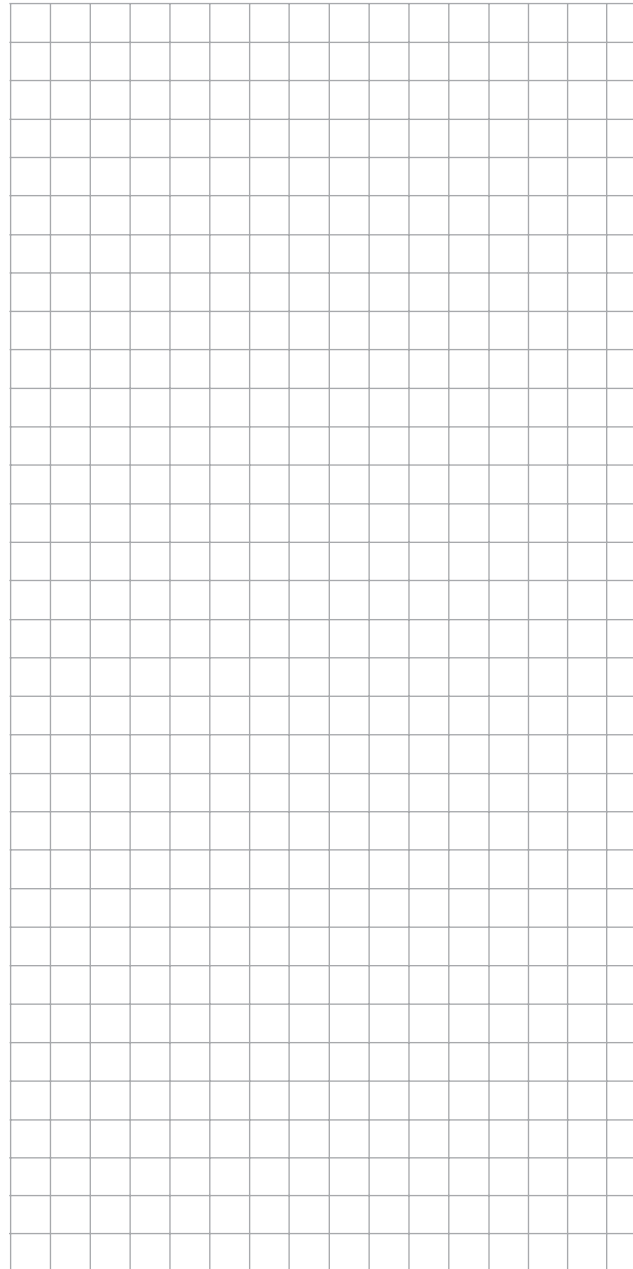

✂ Base setup model

Model-specific base settings for helicopter models

Before programming specific parameters, there are some basic settings to be made which effect the currently active model memory.

Use the selection keys of the left or right touch pad to select the »**Basic settings, model**« menu ...

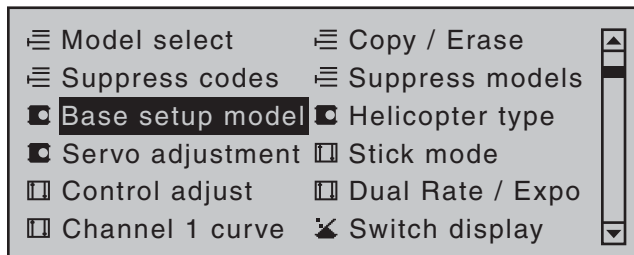

... then tap the center **SET** key of the right touch pad.

Model name

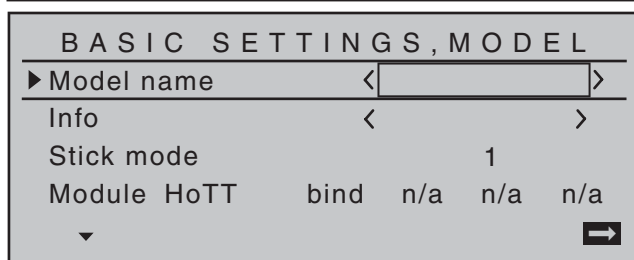

Change to the next screen page with a brief tap on the **SET** key of the right touch pad. This will open a screen of characters for entry of the model's name. A maximum of 13 characters can be used to specify a model name.

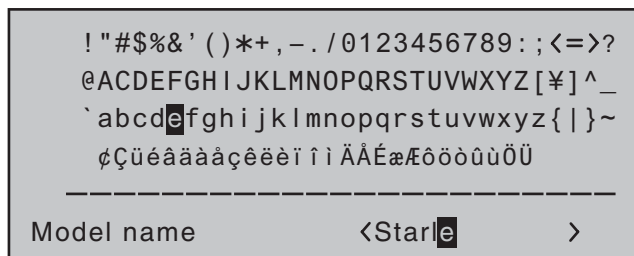

Now the desired characters can be selected with the selection keys of the left touch pad. Move to the next position to select the next character with a tap on the ► of the right touch pad or its center **SET** key. A simultaneous tap on the ▲▼ or ◀▶ keys of the right touch pad (**CLEAR**) will place a space character at the current position.

Positioning to any character position within the entry field can be done with the ◀▶ keys of the right touch pad.

A return to the previous menu screen is accomplished with a tap on the center **ESC** key of the left touch pad.

A model name entered in this manner will appear in the base screen of the »**Model select**« menu and in the sub-menus of the »**Copy / Erase**« menu item.

Info

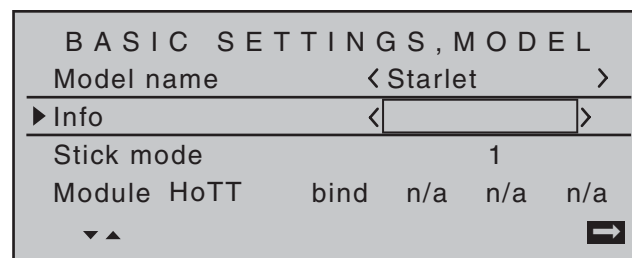

Every model can be given a supplementary note of up to 12 characters (maximum) by following the same procedure as already described for creating a "Model name". This info note will appear as a supplement in the »**Model select**« menu and in the sub-menus of the »**Copy / Erase**« menu item.

Stick mode

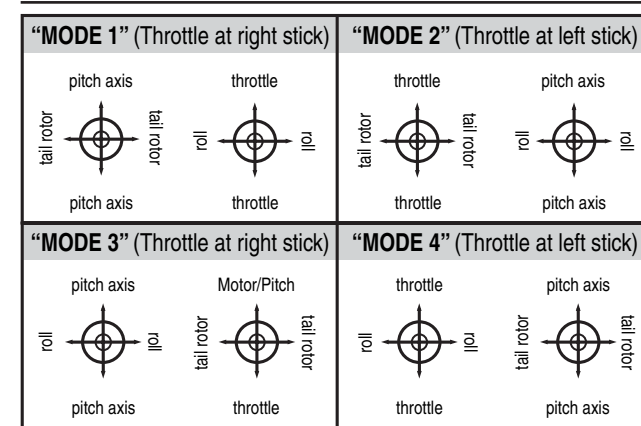

Basically there are four different ways to assign the four helicopter control functions, roll, nick, tail rotor and throttle/pitch to the two joysticks. Just which of these is used depends on the preferences of the individual model pilot.

Use the ▲▼ selection keys of the left or right touch pad to select the "Stick mode" line. The option field will be framed.

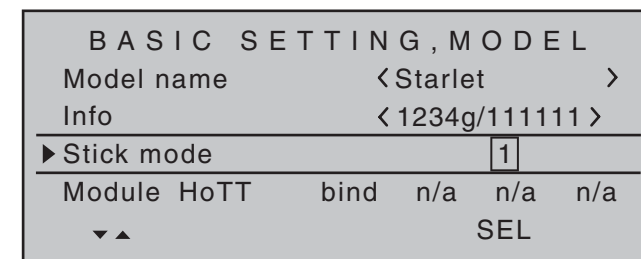

Tap on the **SET** key. The currently displayed stick mode will be displayed in inverse video. Now use the selection keys of the right touch pad to select from among options 1 through 4.

A simultaneous tap on the ▲▼ or ◀▶ keys of the **right touch pad (CLEAR)** will reset the display to stick mode "1".

Another tap on the **SET** key will again deactivate option selection so a change to another line can be affected.

Module

| | | | | | |
|----------------------|------------------|-----|-----|-----|--|
| BASIC SETTING, MODEL | | | | | |
| Model name | < Starlet | | > | | |
| Info | < 1234g/111111 > | | | | |
| Stick mode | 1 | | | | |
| ▶ Module HoTT | bind | n/a | n/a | n/a | |
| ▼ ▲ SEL | BD1 | BD2 | BD3 | BD4 | |

The **MC-20** transmitter has a HoTT RF module as standard equipment. In addition to the built-in module, there is a connector for an external RF module behind one of the two front cover flaps (see page 25) and a switchover to an external module connected there can be affected per software. To do this, use the selection keys of the left or right touch pad to move the marker frame left to the "Module" selection field above the "SEL" column label.

HoTT system

Graupner HoTT receivers must be "instructed" to communicate exclusively with a certain model (memory) in a *Graupner* HoTT transmitter. This procedure is known as "binding" and must only be done *once* for every new receiver/model-memory-location combination (and can be repeated anytime).

Important notices:

- **During the binding procedure be sure the transmitter's antenna is always far enough away from the receiver's antenna. To be on the safe side, keep them at least one meter apart. Otherwise there is a risk of a faulty connection to the return channel and malfunctions will result.**

- **When binding additional receivers, note that any other –switched on–receivers already bound to the transmitter will fall into Fail-safe mode during the transmitter-side "binding" period.**

"Binding" multiple receivers per model

Multiple receivers per model can be bound if desired, whereby respective **MC-20** HoTT programs offer the potential for managing up to four receivers directly and for dividing up the transmitter's 16 control channels (max) in any arrangement among these receivers under menu control. Refer to additional details further down in this section. First bind the receivers individually as described below.

However, in subsequent operation only one of these receivers will establish a telemetry bond to the transmitter; the one which was activated in the "TELEMETRY RCV" line of the »Telemetry« menu, for example:

| | |
|--------------------|---------|
| TELEMETRY | |
| ▶ TELEMETRY RCV | BIND. 1 |
| SETTING & DATAVIEW | |
| SENSOR SELECT | |
| RF STATUS VIEW | |
| VOICE TRIGGER | |

Any telemetry sensors which may be built into the model should therefore be connected to this receiver because the transmitter only receives and evaluates data from the return channel of the receiver *activated on this line*. The second, and all other receivers, operate in parallel but are fully independent in slave mode.

"Binding" transmitter and receiver

Use the ▲▼ selection keys of the left or right touch pad to move into the "Module" line. The marker frame will be positioned by default to the column for the next free binding channel. In the example shown in the

figure below, the marker frame is positioned above the column label "BD2" because the binding channel in the column labeled "BD1" is already in use by default for the receiver which was delivered with the set.

| | | | | | |
|----------------------|------------------|-----|-----|-----|--|
| BASIC SETTING, MODEL | | | | | |
| Model name | < Starlet | | > | | |
| Info | < 1234g/111111 > | | | | |
| Stick mode | 1 | | | | |
| ▶ Module HoTT | bind | n/a | n/a | n/a | |
| ▼ ▲ SEL | BD1 | BD2 | BD3 | BD4 | |

If not already off, now switch the receiver on. The red LED on the receiver will blink.

Press and hold the **SET** button on the receiver while the LED continues to blink red for about 3 seconds then, after about another 3 seconds, begins to blink red/green. The **SET** button on the receiver can now be released. As long as this LED blinks red/green, the receiver is in bind mode.

Now, within this 3 second period, start the so-called "receiver binding" process for the receiver to the currently active model memory with a brief tap on the center **SET** key of the right touch pad. At this time, the screen's display will blend in a message window for the duration of the "binding" process.

| | | | | | |
|----------------------|------------------------|-----|-----|-----|--|
| BASIC SETTING, MODEL | | | | | |
| Model name | < Starlet | | > | | |
| Info | FINDING... 4g/111111 > | | | | |
| Stick mode | 1 | | | | |
| ▶ Module HoTT | bind | n/a | n/a | n/a | |
| ▼ ▲ SEL | BD1 | BD2 | BD3 | BD4 | |

If the receiver's LED, again blinking red, changes within about 10 seconds to continuous illumination in green, the binding process has been successfully

completed. Your model-memory to receiver combination is now operationally ready. At this time the screen will now display "bind" (bound) instead of "n/a" (not attached).

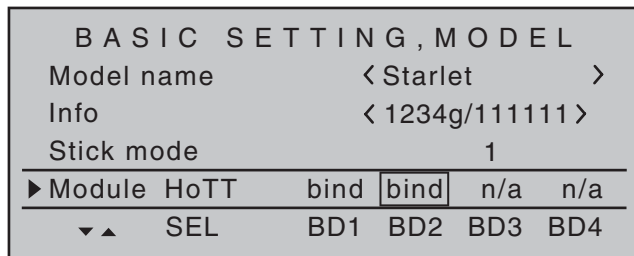

On the other hand, should the LED on the receiver blink red for longer than about 10 seconds, the binding process has failed. In this case the screen will continue to show the status as "n/a". If this should happen, try changing the position of antennas then repeat the entire procedure.

Binding other receivers

The binding channel you have chosen is already bound (as indicated by the "bind" status). with another binding channel. If, after initiating the RF bind process, the message shown below appears in the screen instead of displaying "BINDING"



Drop down two lines in the screen and switch off the RF module, as described several columns further below in the section "RF module". Afterward, return again to the "Module" line and restart the binding process as described on the previous page.

Alternatively you can briefly switch off the transmitter then, after switching it back on again, respond to the message window that appears ...

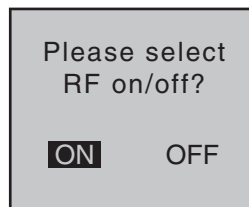

... with "OFF" ...

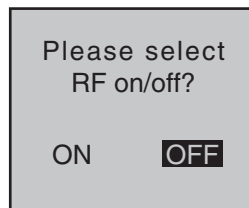

... then confirm the selection with a brief tap on the center **SET** key of the right touch pad. From the base screen jump again into the "Module" line of the »Basic settings, model« menu and restart the binding process.

Dissolving a bond

Proceed as described above to initiate the binding process but WITHOUT first putting a receiver in binding readiness.

EXT. PPM

Important notice:

With the activation of the value field in the context of the following described changeover, any existing bonds to HoTT receivers which may be effective for the currently active model memory will be lost.

Activate the first value field in the "Module" line with a tap on the center **SET** key of the right touch pad then use the selection keys to choose "EXT. PPM" instead

of "HoTT". In parallel with the selection of "EXT. PPM", the other four value fields will be replaced by the type of modulation pre-selected in the line »DSC Output«, see page 88.

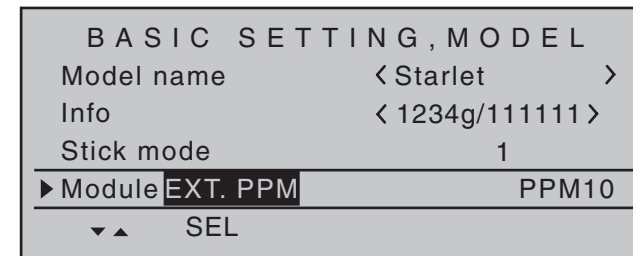

This change also suppresses the lines for the options (described below): »HoTT«, »Rcv Ch Map«, »RF module« and »RF range test« and, in the basic display, "PPM" will be displayed instead of "HoTT".

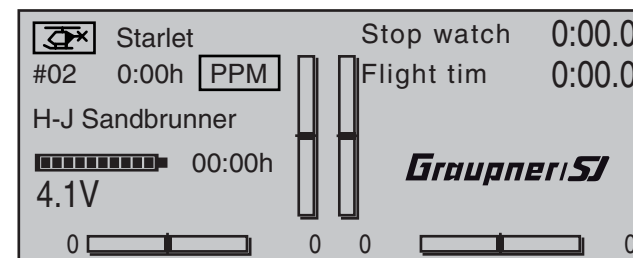

Receiver channel mapping

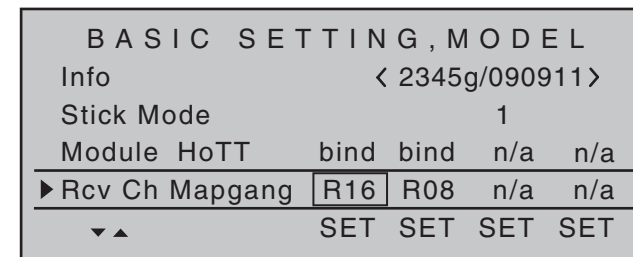

As mentioned in the introduction to the "Binding receivers" section, this menu item of the **MC-20** HoTT offers both the opportunity to freely divide up the transmitter's control channels *within a receiver* as well

as the opportunity to distribute the transmitter's 16 control channels across *as many as four receivers*. This redistribution is subsequently referred to as "mapping" or "channel mapping" (channel correlation). Select the receiver to be "mapped" with the selection keys of the left or right touch pad then tap briefly on the center **SET** key of the right touch pad.

Channel mapping within a receiver

Analogous to the channel correlation function in the »Telemetry« menu on page 232, described as "Channel Mapping", it is very simple to use this menu item to freely assign the transmitter's control channels present on the receiver's inputs to any specific receiver outputs (servo connections) for the bound receiver designated by the column labeled BD1.

| RECEIVER CHANNEL MAP BIND1 | | | |
|----------------------------|---|----|----------------|
| ► Rx Input Ch | 1 | -> | Rx Output Ch 1 |
| Rx Input Ch | 2 | -> | Rx Output Ch 2 |
| Rx Input Ch | 3 | -> | Rx Output Ch 3 |
| Rx Input Ch | 4 | -> | Rx Output Ch 4 |
| ▼ | | | |

After selection of the desired *output* with the selection keys of the left or right touch pad, the respective input field will be framed. Briefly tap the center **SET** key of the right touch pad: The current setting will be displayed in inverse video. Now use the selection keys of the right touch pad to select the desired input channel's respective transmitter output, see page 218.

Note:

The number of lines available in the list (outputs) corresponds to the maximum number of servos which can be attached to the given receiver.

BUT CAUTION: If you wish to operate two servos with one control function, for example such as transmitter control function 2 (roll) which is divided up into control channels 1 & 2 for left and right roll

servos for the "3Sv(2Roll)" option in the »Heli type« menu; then "map" the corresponding transmitter outputs, in this case for channels 1 & 2 (= inputs to the receiver) accordingly.

Important notice:

*The **MLC-20** HoTT transmitter's »Tx. output swap« option permits the transmitter's 16 control functions to be freely swapped in a similar manner or even permits multiple outputs to be assigned to the same control function. To keep controls manageable, however, we strongly recommend using only one of the options at a time.*

Channel assignment on other receivers

As already mentioned, the "Rcv Ch map" menu option can be used to freely distribute the **MLC-20** HoTT transmitter's 16 control channels across *up to four receivers*, whereby the numbering of outputs (servo connections) as well as the maximum number of available lines (outputs) will correspond to the maximum number of servo connections available on the given receiver.

| RECEIVER CHANNEL MAP BIND2 | | | |
|----------------------------|----|----|----------------|
| ► Rx Input Ch | 16 | -> | Rx Output Ch 1 |
| Rx Input Ch | 16 | -> | Rx Output Ch 2 |
| Rx Input Ch | 16 | -> | Rx Output Ch 3 |
| Rx Input Ch | 16 | -> | Rx Output Ch 4 |
| ▼ | | | |

After selection of the desired *output* with the selection keys of the left or right touch pad, the respective input field will be framed. Tap the center **SET** key of the right touch pad. The current setting will be displayed in inverse video. Now select the desired input channel with the selection keys of the right touch pad. For example, appropriate for the above example with roll servos:

| RECEIVER CHANNEL MAP BIND2 | | | |
|----------------------------|----|----|----------------|
| ► Rx Input Ch | 1 | -> | Rx Output Ch 1 |
| Rx Input Ch | 2 | -> | Rx Output Ch 2 |
| Rx Input Ch | 16 | -> | Rx Output Ch 3 |
| Rx Input Ch | 16 | -> | Rx Output Ch 4 |
| ▼ | | | |

Note:

The number of lines available in the list (outputs) corresponds to the maximum number of servos which can be attached to the given receiver.

RF transmit

This menu line provides an option for manually switching the transmitter's RF transmission on and off to specific models while the transmitter is in operation. For example, to save power while a model is being programmed. **If this line option was set to OFF, it will be canceled (i.e. set to ON) the next time the transmitter is switched on.**

If necessary, use the ▲▼ selection keys of the left or right touch pad to switch to the "RF module" line then, with a brief tap on the center **SET** key of the right touch pad, activate the value window:

| BASIC SETTING, MODEL | | | | |
|----------------------|------|------|-----|-----|
| Stick mode | | | | 1 |
| Module HoTT | bind | bind | n/a | n/a |
| Rcv Ch Map | R16 | R08 | n/a | n/a |
| ► RF transmit | | | | on |
| ▼ ▲ | | | | SEL |

The right selection keys can now be used to choose between **OFF** and **ON**. Another tap on the center **SET** key of the right touch pad will conclude the entry.

Range test

The built-in range test reduces transmission power to an extent that a functional test can be carried out even within a distance of less than 100 m.

Perform a range test on the *Graupner* HoTT system according to the following instructions. If necessary, have someone assist you in carrying out the range test.

1. Preferably, the receiver already bound to the transmitter should be installed into the model in its intended position.
2. Switch remote control on and wait for the green LED to light up on the receiver/s. Now servo movements can be observed.
3. Place the model on a level surface (pavement, low-cut grass or bare ground) such that receiver antennas are at least 15 cm above ground level. It may be necessary to put something under the model to raise it up enough for this.
4. Hold the transmitter at hip level and at some distance from one's body. Do not point the antenna directly at the model but rather turn and/or kink the antenna's end so that it is oriented vertically during the test.
5. If necessary, use the ▲▼ selection keys of the left or right touch pad to reach the "RF range test" line in the menu then start range test mode with a tap on the center **SET** key of the right touch pad.

| BASIC SETTING, MODEL | | | | |
|----------------------|------|------|-----|-----|
| Module HoTT | bind | bind | n/a | n/a |
| Rcv Ch Map | R16 | R08 | n/a | n/a |
| RF transmit | | | on | |
| ▶ RF range test | | | 99s | |
| ▼ ▲ | | | SEL | |

When the range test has been initiated, the transmitter's transmission power will be significantly reduced and the LED just to the right

of the main switch on the transmitter, marked RF, will begin to blink; this will also be accompanied by acoustic tones. At the same time, the timer in the transmitter's display will start counting down and every 5 seconds a two-frequency tone will sound.

Five seconds prior to the end of the range test a three-frequency tone will sound once every second. After expiration of the range test's 99th second the transmitter will again be switched to full output power and the LED just to the right of the main switch on the transmitter will again illuminate constantly.

6. Move away from the model while manipulating the joysticks during this timespan. If you notice an interruption anytime while still within a distance of about 50 m, try to reproduce this malfunction.
7. If there is a motor in the model, it may be necessary to switch it on to further check noise immunity.
8. Continue moving away from the model until perfect control is no longer possible.
9. Wait at this distance for the remainder of the test period with the still-operationally-ready model to expire. After the range test is ended it should again respond correctly to all RC controls. If this is not 100% the case, do not use the system. Contact your area's *Graupner* GmbH & Co. KG service partner.
10. Perform the range test before each flight and, in doing so, simulate all servo movements which also take place during flight. The range must always be at 50 m on the ground in order to assure safe model operation.

Caution:

Never start the range test on the transmitter during normal operation of the model.

DSC output

If necessary, use the ▲▼ selection keys of the left or right touch pad to switch to the "DSC Output" line then, with a tap on the center **SET** key of the right touch pad, activate the value window:

| BASIC SETTING, MODEL | | | |
|----------------------|-----|-----|---------|
| Rcv Ch Map | R16 | R08 | n/a n/a |
| RF transmit | | | on |
| RF range test | | | 99s |
| ▶ DSC Output | | | PPM10 |
| ▼ ▲ | | | SEL |

Now you can use the right selection keys to choose between four types of modulation "PPM10", "PPM16", "PPM18" and "PPM24". Touch the center **SET** key of the right touch pad again to complete the entry.

This choice primarily influences the maximum number of control channels which can be attached to the DSC (direct servo control) socket, and thus also available to a flight simulator or teacher/pupil system. By selecting "PPM10" this will be control channels 1 ... 5, for "PPM16" channels 1 ... 8, for "PPM18" channels 1 ... 9 and for "PPM24" channels 1 ... 12.

Autorotation

Autorotation is that state of descending flight in which the pitch of main rotor blades are set such that the rotor's speed matches the natural forces of air flowing through, like a windmill. This built-up energy can be used for "recovery" lift to brake a descent by appropriate blade pitch adjustment.

Autorotation is a means by which real and model helicopters are able to land safely in emergency situations, e.g. in the event of a motor failure. However, the prerequisite for this is a well-trained pilot familiar with the helicopter's characteristics. Quick reaction and good perceptiveness are necessary because the rotor's inertia can only be used once to generate recovery lift.

When this technique is evaluated during competitions, the motor must be switched off for autorotation. On the other hand, for training mode it is advantageous to keep the motor at idle for autorotation.

The Autorotation switch causes a switchover to the autorotation flight phase in which control of "throttle" and "pitch" are separate and all mixers which have an effect on the throttle servo are switched off.

Corresponding parameter settings are made in the »**Helicopter mixer**« (see text beginning page 176); refer also to the "Principle of the Auto. C1 Pos." topic which follows.

The "Autorotation" name is permanently assigned to phase 1 and it is included in the base screen of all flight phase dependent menus. This name can NOT be changed. It is only possible to assign a switch to this option at the right of this display, as described on page 56. **If a switch is assigned, it will have absolute priority over all other flight-phase switches.**

| BASIC SETTING, MODEL | |
|----------------------|-------|
| RF transmit | on |
| RF range test | 99s |
| DSC Output | PPM10 |
| ▶ Autorotation | --- |
| ▼ ▲ | ↗ |

More about flight-phase programming can be found in the text beginning on page 176 in the »**Helicopter mixer**« section.

Autorotation C1 position

The autorotation flight-phase can alternatively be activated by a threshold point for the C1 throttle/pitch joystick. To do this, use the ▲ ▼ selection keys of the left or right touch pad to move into the "Autorot. C1-Pos." line.

As soon as this display line has been selected, its

value field, located above the column label **STO** will be framed.

| BASIC SETTING, MODEL | |
|----------------------|-------|
| RF range test | 99s |
| DSC Output | PPM10 |
| Autorotation | --- |
| ▶ Autorot. C1-Pos. | 0% |
| ▼ ▲ | STO ↗ |

Move the C1 joystick into the desired threshold switchover position then tap the center **SET** key of the right touch pad. The current value will be displayed, e.g.:

| BASIC SETTING, MODEL | |
|----------------------|-------|
| RF range test | 99s |
| DSC Output | PPM10 |
| Autorotation | --- |
| ▶ Autorot. C1-Pos. | -55% |
| ▼ ▲ | STO ↗ |

After this has been done, use the selection keys to move into the column above the switch symbol then assign a switch to this field, as described on page 56 in section "Switches, controls and control switches". Preferably one of the two self-restoring switches

| BASIC SETTING, MODEL | |
|----------------------|---------|
| RF range test | 99s |
| DSC Output | PPM10 |
| Autorotation | --- |
| ▶ Autorot. C1-Pos. | -55% 4I |
| ▼ ▲ | STO ↗ |

Once this activation switch is closed, the first occurrence of a threshold underrun will cause the program to switch over to "Autorotation" and then

remain independent of C1 position in this flight phase until the activating switch, in this example switch 4, is again "OFF".

"Autorot. C1-Pos." has precedence over all other flight-phase switches.

Corresponding parameter settings for ...

- pitch servos
- throttle servo
- tail rotor servo
- swashplate rotation, if available
- gyro setting

... are made in the »**Helicopter mixer**« menu, page 176.

Cut-off

Within the framework of autorotation settings for the **MC-20** HoTT transmitter's helicopter program, there are parameters for an emergency "Thr. CutOff" of the throttle servo or motor actuator, refer to the programming proposal on page 314. However, this option is not available if an idle position is specified in the "Throttle position AR" line of the »**Helicopter mixer**« menu instead of an (emergency) OFF position; for example, to avoid restarting the motor after every landing during autorotation practice.

This option not only replaces the "Cut-off trim" function known from other *Graupner mc* and *mx* transmitters but also serves as an Emergency-OFF function at the same time, which was not possible with the "Cut-off trim" function.

Depending on the "forw./rear" choice made for the "Pitch min" line of the »**Helicopter type**« menu, this "Thr. CutOff" option can be coupled to a switch for throttling down a speed controller or a carburetor servo to the motor OFF (or idle) position.

This cut-off (or idle) position is specified in the left column's field, above the **SEL** column label, and its value is to be established through trial and error.

A speed controller or throttle servo will only take on this preset position when a certain servo position or threshold is underrun and a switch is activated. This is done by setting the desired servo position (threshold value) into the middle column field, directly over the column label **STO**, then selecting the appropriate ON/OFF switch function in the right column.

- If the percentage value specified for the middle column is *greater* than the current servo position, i.e. the current servo position lies *below* the threshold, the switchover will occur as soon as the switch is put into its ON position.
- If the percentage value specified for the middle column is *less* than the current servo position, i.e. the current servo position is *above* the threshold, the speed controller will initially reduce motor speed or close the carburetor's throttle servo only to the extent dictated by the value in the left column as soon as the servo's position once *underruns* the threshold (max. +150%) after the switch is changed over to its ON position.
The speed controller or throttle servo will remain in this cut-off position only until the selected switch is again changed over followed by a one-time throttle servo or speed controller movement beyond the preset threshold with the throttle/brake joystick control.

The factory setting for the left column is -100% for the throttle servo "cut-off" position and a threshold of +150% servo position setting in the middle column.

| | | | |
|-----------------------|-------|-------|-----|
| BASIC SETTING , MODEL | | | |
| DSC Output | PPM10 | | |
| Autorotation | --- | | |
| Autorot. C1-Pos. | 0% | --- | |
| ▶ Thr. CutOff | -100% | +150% | --- |
| ▼ ▲ | SEL | STO | ↙ - |

Programming procedure

To change the throttle servo's preset "cut-off" position, tap on the center **SET** key of the right touch pad. The current setting will be displayed in inverse video. Now use the selection keys of the left or right touch pad to set a value at which the motor is reliably "off" without a startup of the throttle servo. For example -125%:

| | | | |
|-----------------------|-------|-------|-----|
| BASIC SETTING , MODEL | | | |
| DSC Output | PPM10 | | |
| Autorotation | --- | | |
| Autorot. C1-Pos. | 0% | --- | |
| ▶ Thr. CutOff | -125% | +150% | --- |
| ▼ ▲ | SEL | STO | ↙ - |

The –upper–preset value in the middle column ensures the motor can be stopped, throughout the maximum possible positioning range of the servo or speed controller, alone by the switch to be assigned in the right column.

However, if a lower threshold is preferred, at which an underrun will cause the throttle servo or speed controller with closed switch to enter the throttle cut-off position for a closed switch condition –by default the right-side proportional rotary slider –put the throttle/pitch joystick into the desired position then tap on the center **SET** key of the right touch pad.

| | | | |
|-----------------------|-------|-------|-----|
| BASIC SETTING , MODEL | | | |
| DSC Output | PPM10 | | |
| Autorotation | --- | | |
| Autorot. C1-Pos. | 0% | --- | |
| ▶ Thr. CutOff | -125% | +150% | --- |
| ▼ ▲ | SEL | STO | ↙ - |

Finally, use the column at the right to specify a switch with which you can cut off the motor directly (emergency) or which will be activated by the threshold.

| | | | |
|-----------------------|-------|-------|-----|
| BASIC SETTING , MODEL | | | |
| DSC Output | PPM10 | | |
| Autorotation | --- | | |
| Autorot. C1-Pos. | 0% | --- | |
| ▶ Thr. CutOff | -125% | +100% | 8↓ |
| ▼ ▲ | SEL | STO | ↙ - |

Notes:

- *Be sure the throttle servo does not run out mechanically when the cut-off function is activated.*
- *A threshold over +100% is reached by temporarily increasing the travel for servo 1 in the »Servo adjustment« menu to over 100% then, after storing the threshold, change servo travel back to the original value.*

Marking

| BASIC SETTING, MODEL | | | |
|----------------------|-------|-------|----|
| Autorotation | | --- | |
| Autorot. C1-Pos. | 0% | --- | |
| Thr. CutOff | -125% | +100% | 8↓ |
| ▶ Marker key | | --- | |
| ▼ ▲ | | / - | |

When activated, the "Marker key" will place a marker in the "Pitch" curve, as well as in the "Channel 1 → Throttle" and "Channel 1 → Tail rotor" mixer curves of the »**Helicopter mixer**« menu, to mark the current pitch joystick position of the pitch joystick and it takes on the form of a vertical dashed line. This marker is helpful for setting curve points at the right places during flight testing, e.g. the hovering point

One of the two standard momentary contact switches mounted into the switch panels should be the preferred choice of switch assignment.

Example:

The hovering point is to be placed at the midpoint of the throttle/pitch joystick for the «Hover» flight phase but it is found to be still located above control middle during flight testing. Press the switch in this position and, after the landing, examine, for example, the Pitch curve in the »**Helicopter mixer**« menu, page 176.

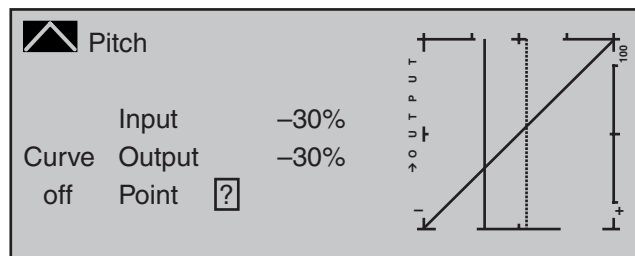

The continuous vertical line shows the joystick's

current position. Its position in this example lies at -30% (= input) of control travel and, because of its (still) linear control curve, produces an output signal which is also -30% (= output).

On the other hand, the dashed vertical line represents the joystick position at which the marker switch was pushed.

Move the joystick to this marker line to read the input and output values for the found hovering point. The marker points of the other two mixer curves are read similarly. Now these three curves can be alternately modified as necessary in order to correct the hovering point. Curve point "1" in this simple example can be raised at the curve's midpoint to the output value that was determined to be the hovering point in the Pitch graph.

Power-on warning

| BASIC SETTING, MODEL | | | |
|----------------------|-------|-------|----|
| Autorot. C1-Pos. | 0% | --- | |
| Thr. CutOff | -125% | +100% | 8↓ |
| Marker key | | --- | |
| ▶ Power on warning | | --- | |
| ▼ ▲ | | / - | |

When a switch, a control switch or a logical switch is assigned in this line, as described on page 56 in the section "Assigning transmitter controls, switches and control switches", the respective switch or control position will be polled when the transmitter is switched on and an appropriate warning will be blended into the basic display under some conditions. In combination with logical switches, almost any switch setting can be called up for transmitter switch on.

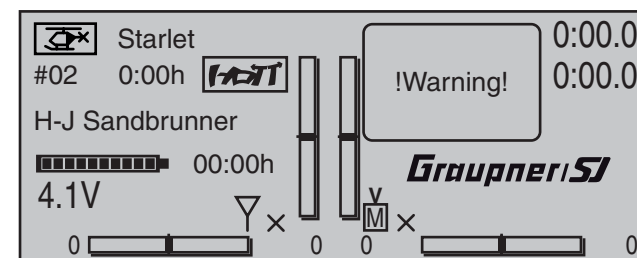

Auto trim

| BASIC SETTING, MODEL | | | |
|----------------------|-------|-------|----|
| Thr. CutOff | -125% | +100% | 8↓ |
| Marker key | | --- | |
| Power on warning | | --- | |
| ▶ Auto trim | | --- | |
| ▼ ▲ | | / - | |

The "Auto trim" option makes it possible to trim a model quickly and without complications, e.g. in the context of a first-flight or even after (major) repairs, etc. Typically such test flights are initially flown with joysticks counter operated until the desired state of flight is achieved. This generally involves working the trim controls during the flight to "unburden" the joysticks.

This is exactly what the "Auto trim" function is for. After the desired flight attitude has been achieved via control functions 2 ... 4 (aileron, elevator and rudder), the switch assigned to "Auto trim"—ideally one of the standard-equipment momentary switches in the switch panels—is to be activated ONCE. At the instant the switch is activated, the joystick offsets from their neutral positions will be determined and adopted as trim values. However, this does not take place instantaneously but rather within about 1 second. During this period after the switch has been activated, the joysticks should be returned to their normal positions.

Notes:

- Be sure that during the switch assignment, the joysticks for aileron, elevator and rudder are in their neutral positions as otherwise their offsets from neutral will be adopted right away in trim memory as the trim value.
- Since EVERY activation of the Auto trim switch has a cumulative effect, after concluding an "auto trim" flight, the assigned auto trim switch should be deactivated for reasons of safety. Otherwise there is a residual danger that the "Auto trim" function could be activated accidentally.

ext. PPM signal

| | |
|-----------------------|--------|
| BASIC SETTING , MODEL | |
| Marker key | ---- |
| Power on warning | ---- |
| Auto trim | ---- |
| ▶ ext. PPM signal | normal |
| ▼ ▲ | SEL |

Some RF modules which can be connected to the external (page 25) or internal (page 26) connectors for other RF modules require an inverted input signal. Be sure to follow the respective module's installation instructions for this.

The choice of "inverted" instead of the default preset "normal" allows for appropriate adaptation of the provided PPM signal.

A simultaneous tap on the ▲▼ or ◀▶ keys of the right touch pad (**CLEAR**) will reset the display to "normal".

Auto timer reset

| | |
|-----------------------|--------|
| BASIC SETTING , MODEL | |
| Power on warning | ---- |
| Auto trim | ---- |
| ext. PPM signal | normal |
| ▶ Auto timer reset | yes |
| ▲ | SEL |

The "yes/no" setting made in this line determines whether or not all of the transmitter's timers (except for "Model time" and "Transmitter operating time") are automatically reset to their given starting values when the transmitter is switched on.

A simultaneous tap on the ▲▼ or ◀▶ keys of the right touch pad (**CLEAR**) will reset the display to "yes".

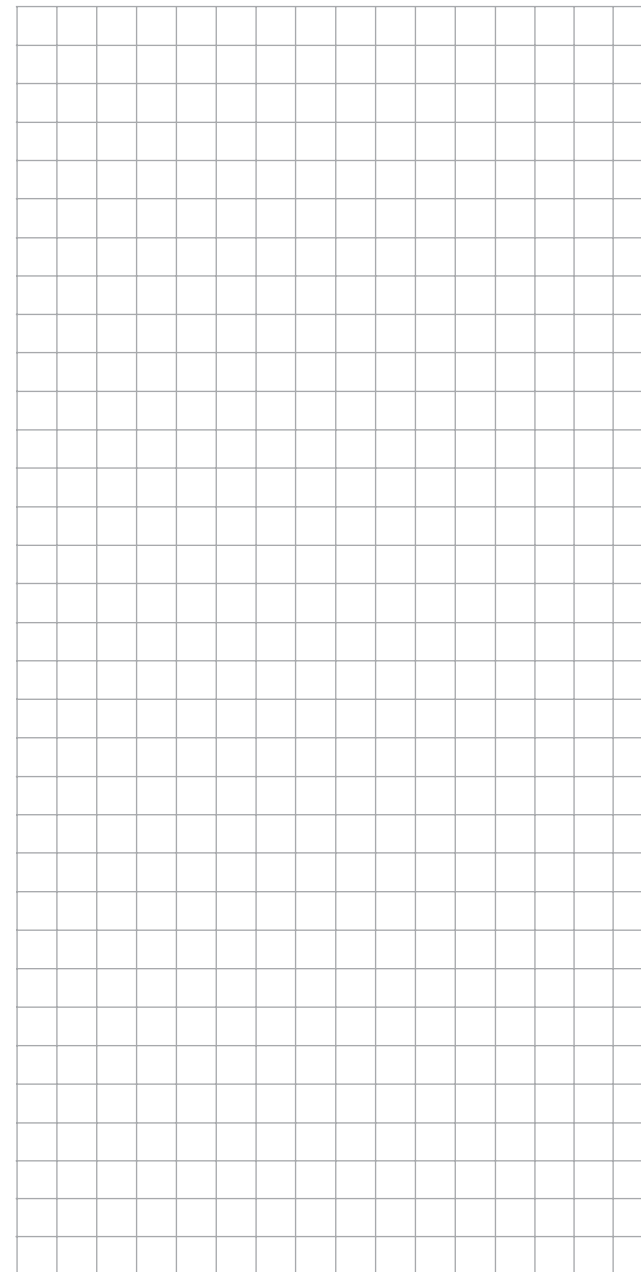

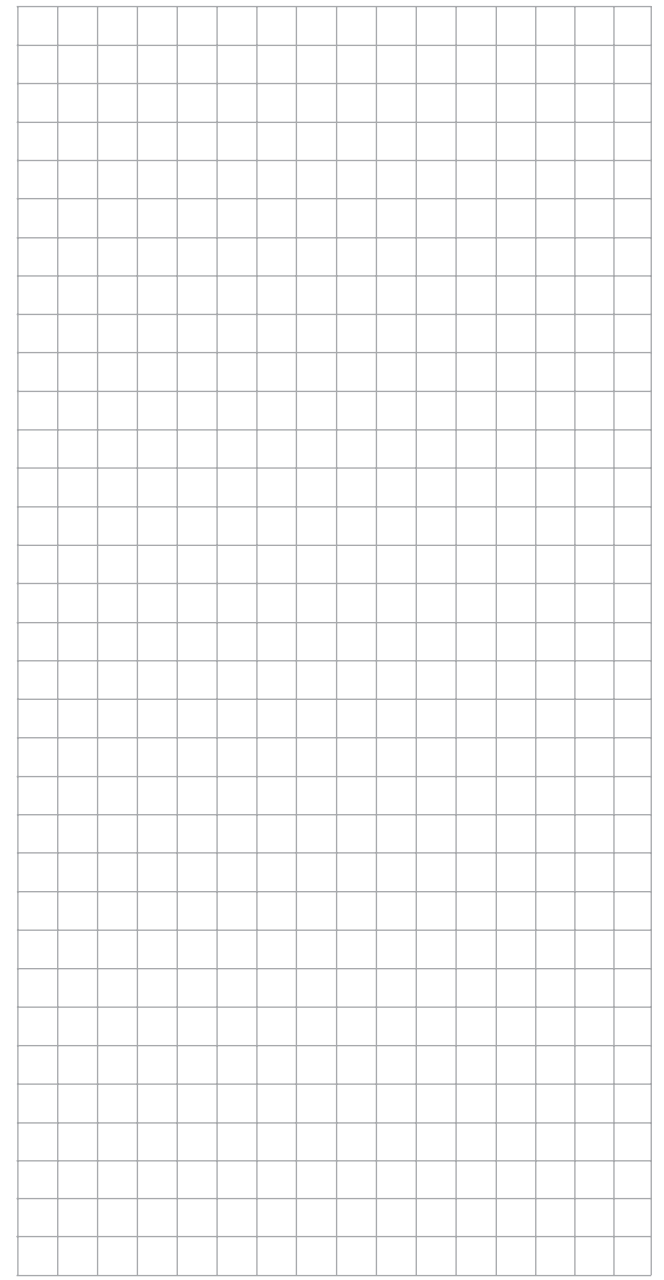
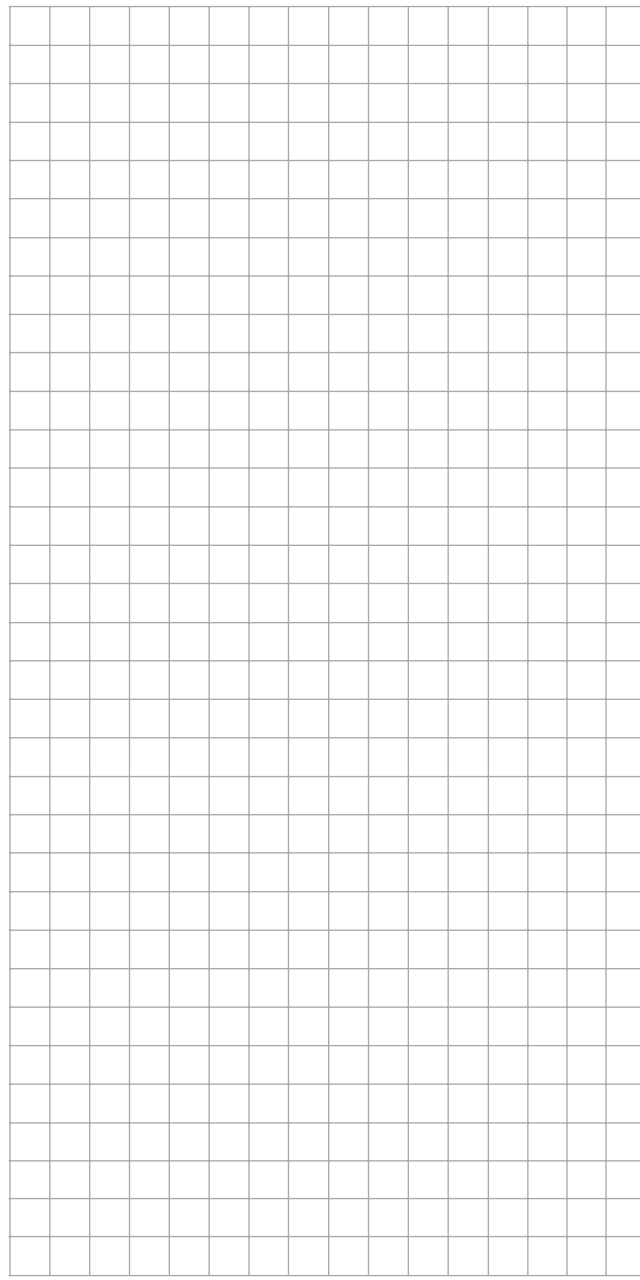
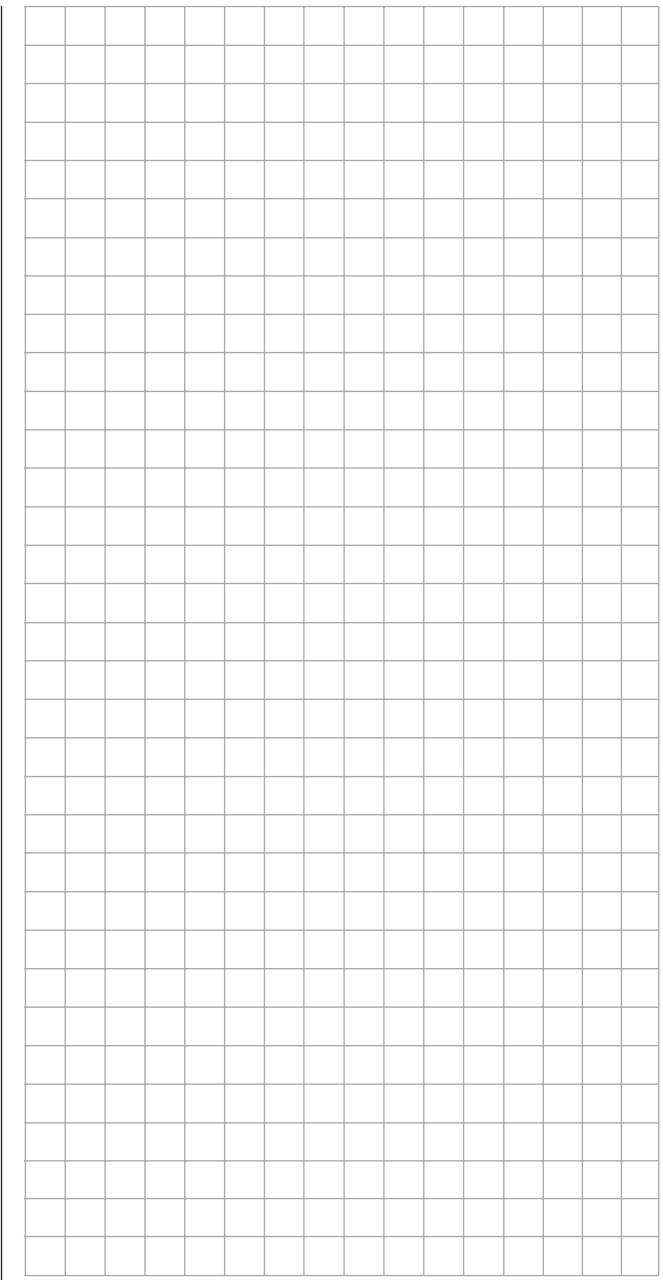

Model type

Establishing winged aircraft model type

This "Model type" menu is used to establish the type of model to be programmed. This also activates all characteristic mixers, coupling functions, etc. in preparation for subsequent programming of the specified model type.

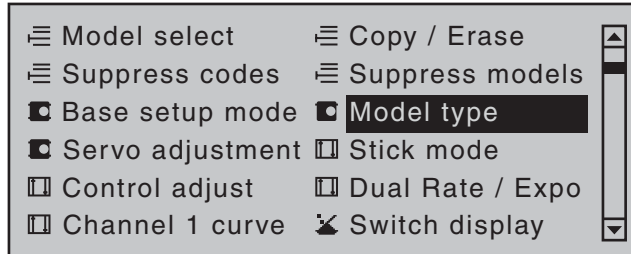

Briefly tap the center **SET** key of the right touch pad:

Motor at C1

After selecting the "Motor at C1" line with the ▲▼ selection keys of the left and right touch pad, the corresponding entry field will be framed.

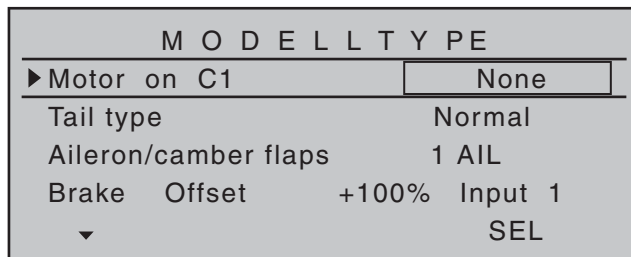

Briefly tap the center **SET** key of the right touch pad: The current setting will be displayed in inverse video. Now use the selection keys of the right touch pad to select from among the following four options:

- "none" For operation of a model without a propulsion.
The warning "Throttle too high", see page 30, is *deactivated* and the "Brake settings" sub-menu of the »**Wing mixers**« (beginning page 172) is available without any restrictions.

"Thr. min. rear": The idle position for the throttle/brake flaps joystick (C1) is to the rear, i.e. toward the pilot.
The warning "Throttle too high", see page 30, as well as the "Thr. CutOff" option in the »**Basic settings, model**« menu, see page 81, are *activated* and the "Brake settings" sub-menu of the »**Wing mixers**« menu, beginning page 172, will be available if the entry in the "Motor" column of the »**Phase settings**« menu, page 142, for the currently active flight phase is "none".

"Thr. min. fwd.": The idle position for the throttle/brake flaps control stick (C1) is at the front, i.e. away from the pilot.
The warning "Throttle too high", see page 30, as well as the "Thr. CutOff" option in the »**Basic settings, model**« menu, see page 90, are *activated* and the "Brake settings" sub-menu of the »**Wing mixers**« menu, beginning page 172, will be available if the entry in the "Motor" column of the »**Phase settings**« menu, page 142, for the currently active flight phase is "none".

Notes:

- **Be sure to pay attention during the programming procedures that motors do not start up unintentionally. Disconnect the fuel supply or battery terminals to motors before programming.**
- *C1 trimming will operate according to the choice made between "normal" or only "back" or "fwd.", that is, either over the control's entire travel path or only in the respective idle direction.*

Tail type

After selecting the »Tail type« line with the ▲▼ selection keys of the left or right touch pad, the corresponding entry field will be framed.

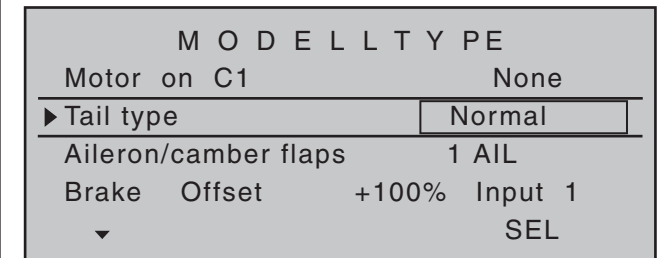

Briefly tap the center **SET** key of the right touch pad: The current setting will be displayed in inverse video. Now select the type appropriate for the model with the selection keys of the right touch pad.

- "normal": Elevators and rudder are each operated by a single servo.
- "V-tail": Elevator and rudder control is affected by way of two separate, articulated, V-shaped rudders. The coupling function for rudder and elevator control will be automatically taken over by the program. The relationship of rudder-to-elevator proportion is set in the »**Dual Rate / Expo**« menu, page 120, and servo travel in the »**Servo adjustment**« menu, page 102.

If, beyond this, there is a desire to also make differentiation for rudder throw then the V-tail should be alternatively controlled via the »**Dual mixer**« menu, page 206. In this case however, the tail type entry specified here *must* be "normal".

"ELEVON": Aileron and elevator control is operated by one or two servos

per wing half. However, elevator trimming is also affected by selecting the "2AIL 2FL" option—see below—but only on servos 2 & 3.

"2ELSV3+8":

This option is intended for models with two elevator servos. The servo connected to output 8 will operate in parallel with servo 3 to actuate elevators. Elevator trim affects both servos.

Note on "2ELSV3+8":

One control, which assigns input 8 by way of the »Control adjust« menu, is then disconnected from servo "8" by software for reasons of safety i.e. it is made ineffective.

Aileron/camber flaps

After selecting the »Aileron/camber flaps« line with the ▲▼ selection keys of the left or right touch pad, the corresponding entry field will be framed.

| M O D E L L T Y P E | | | |
|------------------------|--------|-------|---------|
| Motor on C1 | None | | |
| Tail type | Normal | | |
| ▶ Aileron/camber flaps | 1 AIL | | |
| Brake | Offset | +100% | Input 1 |
| ▼ | SEL | | |

Briefly tap the center **SET** key of the right touch pad: The current setting will be displayed in inverse video. Now use the selection keys of the right touch pad to select the number of wing servos to be programmed for the model.

| Available | Control channel used |
|-----------|----------------------|
| 1AIL | 2 |
| 1AIL 1FL | 2 6 |

| | |
|----------|----------------------------------|
| 2AIL | 2 & 5 |
| 2AIL 1FL | 2 & 5 6 |
| 2AIL 2FL | 2 & 5 6 & 7 |
| 2AIL 4FL | 2 & 5 6 & 7 / 9 & 10 |
| 4QR 2WK | 2 & 5 / 11 & 12 6 & 7 |
| 4AIL 4FL | 2 & 5 / 11 & 12 6 & 7 / 9 & 10 |

Depending on the option selected here, the given mixers needed and their settings will be activated in the »Wing mixers« menu, beginning page 172.

Tips:

- Settings for all wing flap pairs (AI and AI2, FL and FL2) can be trimmed on a flight-phase basis in both the »Phase trim« menu as well as in the **Wing mixers**« menu, page 172.
- The functionality of all wing flap pairs (AI and AI2, FL and FL2) can also be operated by way of the "Throttle/brake-flap joystick" if this stick has not been assigned to other use, e.g. for certain brake settings, see »Wing mixers« menu, page 172. To configure this it is only necessary to assign "Control 1" to input 6 in the »Control adjust« menu, page 108. (If it is preferable to operate flaps with switches, one of the transmitter's two or three position switches are good for this purpose.)

Brake Offset

This function not only has potential for gliders and electric models but also for models with combustion motors and landing flaps.

The mixers described in the »Brake settings« line of the »Wing mixers« menu can be operated by the C1 joystick ("input 1") or another transmitter operating element which has been assigned to input 7, 8 or 9 in the »Control adjust« menu. In this latter case, retain the "GL" default setting for the "Type" column in the »Control adjust« menu so the selected control can operate independent of flight phase.

In the majority of cases the default setting for "input 1" will remain as it is and the brake will be operated by way of the non-neutralizing C1 joystick. However, use of input 7, 8 or 9 makes it possible to operate the brake in an alternative manner, even by way of a supplementary control, if the C1 stick is to be used for something else.

The neutral point (offset) can be set to any desired position. This is done by placing the control for input 1, 7, 8 or 9 into the position at which the landing flaps are to be retracted, i.e. closed, then setting this "Offset" point in the column above the column label **STO**.

The selection of this offset point in this context determines not only the control position at which the brake system is to be retracted, i.e. closed, but also also the activation direction of the C1 joystick for extending the brake system.

- Brake offset values with a "+" prefix will cause flaps affected by the "Brake settings" option of the »Wing mixers« menu to be extended when the C1 joystick is moved *from front to rear*, in the direction of the pilot.
- Brake offset values with a "-" prefix will cause flaps affected by the "Brake settings" option of the »Wing mixers« menu to be extended when the C1 joystick is moved *from rear to front*, in the direction away from the pilot.

If the offset point is not set at the far end of control element travel, the remainder of travel to the end point will be "free travel", i.e. this "free travel" will no longer influence any mixer available for "Brake settings" in the »Wing mixers« menu. This idle path ensures that all brake settings remain at "neutral", even with minor deviations from the limit of the brake flap control. At the same time, the effective control path is automatically spread to 100%.

| | | | |
|----------------------|--------|------|---------|
| M O D E L L T Y P E | | | |
| Motor on C1 | | | None |
| Tail type | | | Normal |
| Aileron/camber flaps | | | 1 AIL |
| ▶ Brake | Offset | +90% | Input 1 |
| ▼ | | | SEL |

Tip:

Preferably, the servo intended for operating any airbrake flaps that may be on the model should be connected to the receiver output operated by the brake input channel, e.g. connect airbrake servo onto (free) receiver output 8 if input 8 has been chosen for the "brake", etc. A second airbrake servo is most conveniently operated by way of a free mixer.

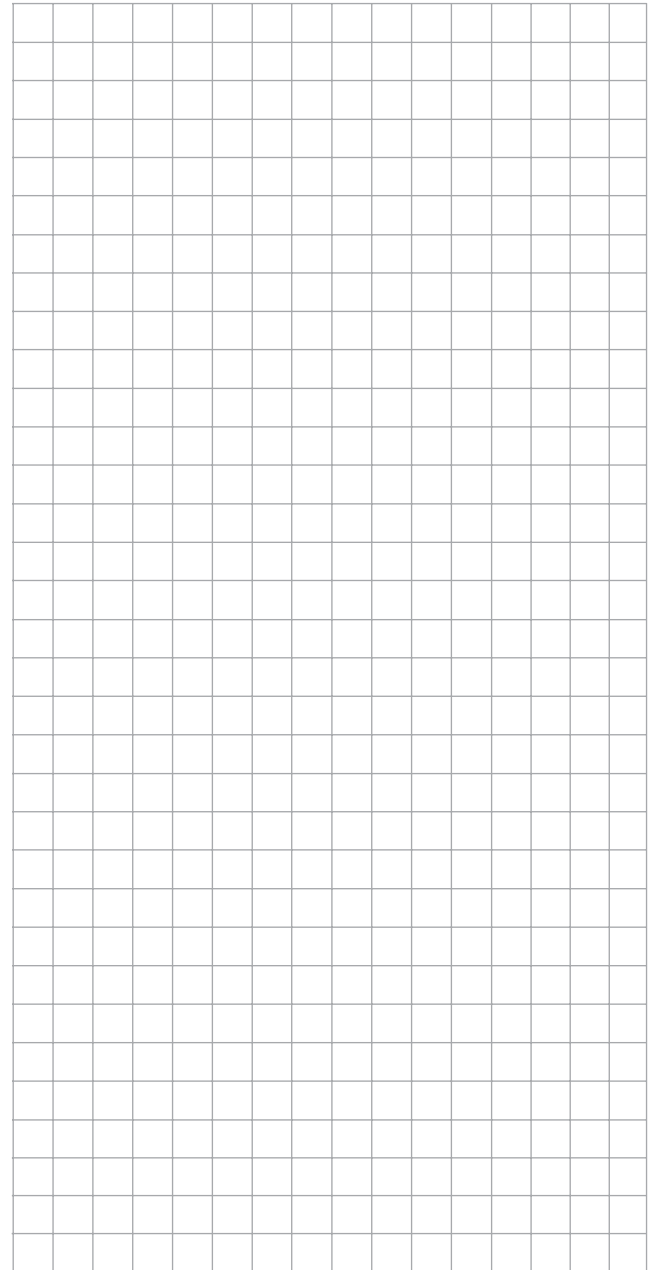
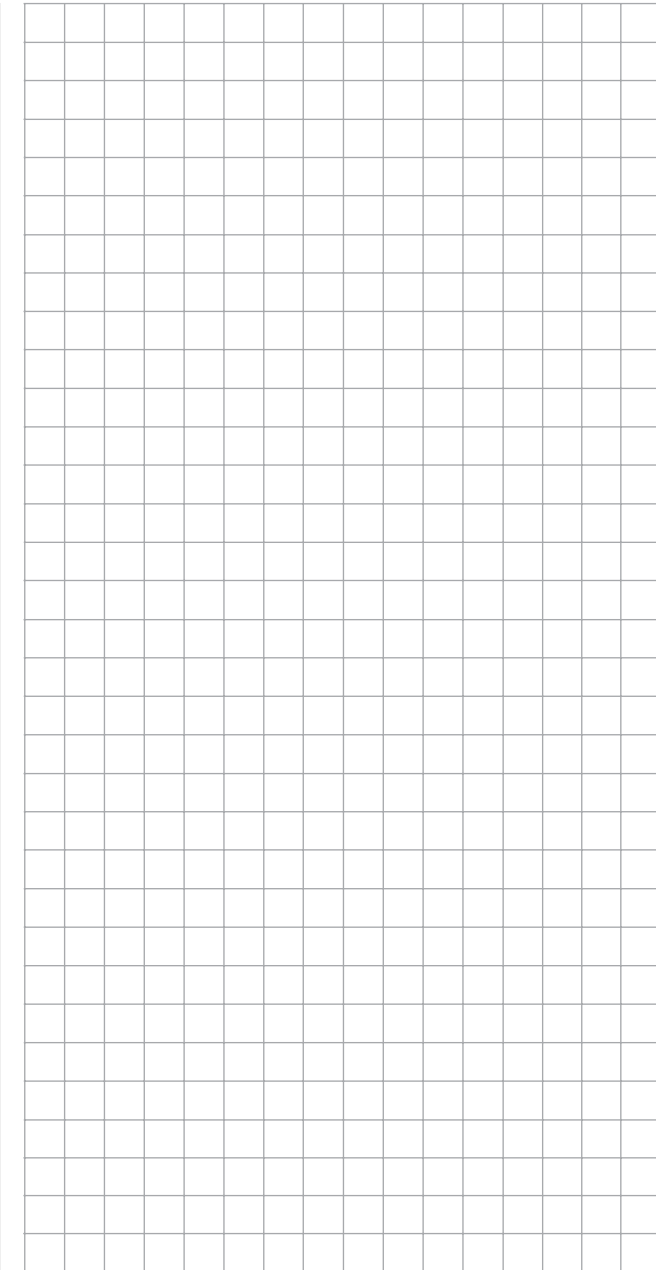

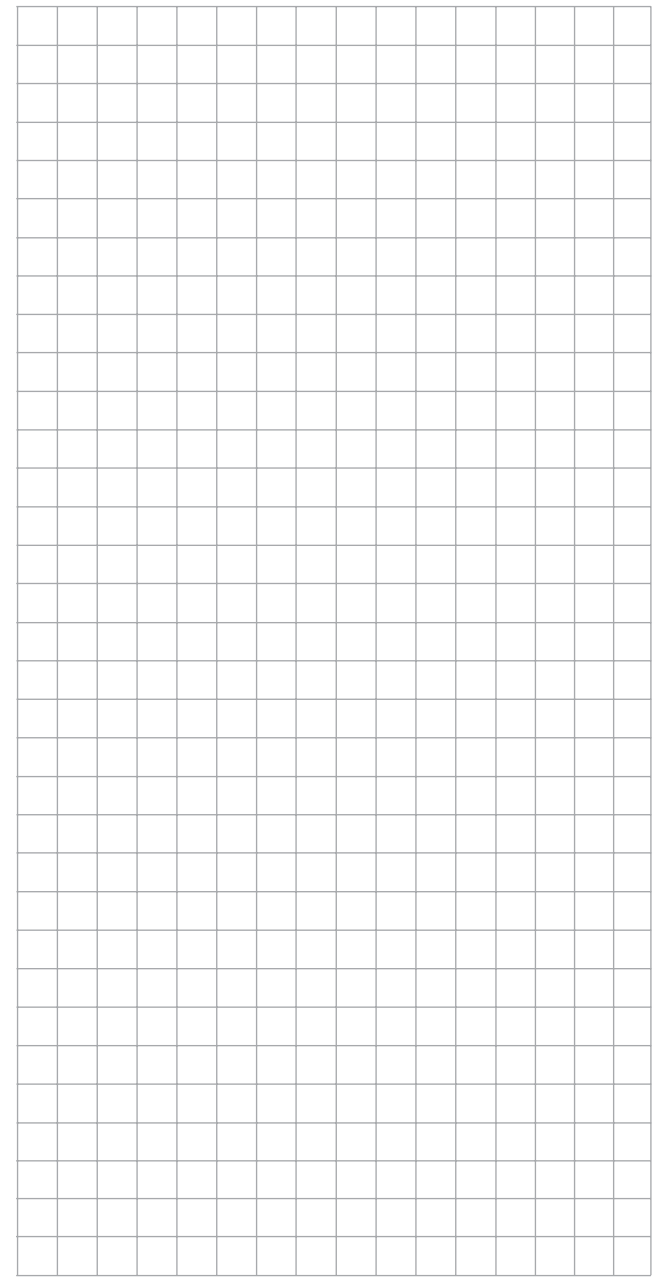
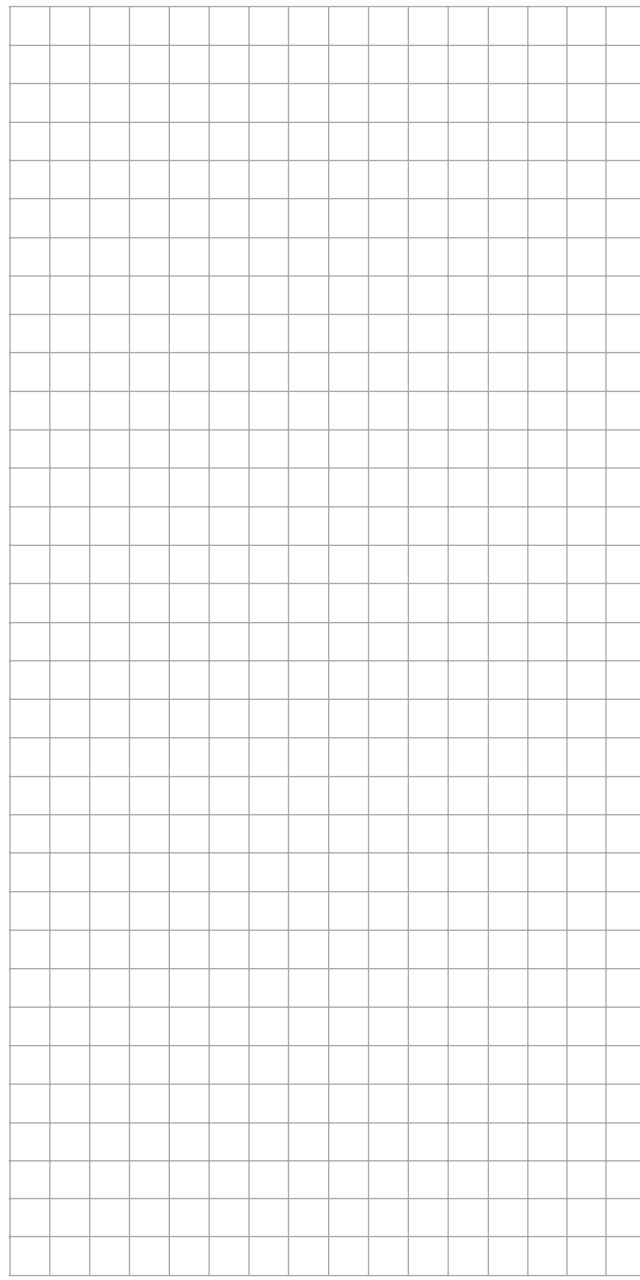
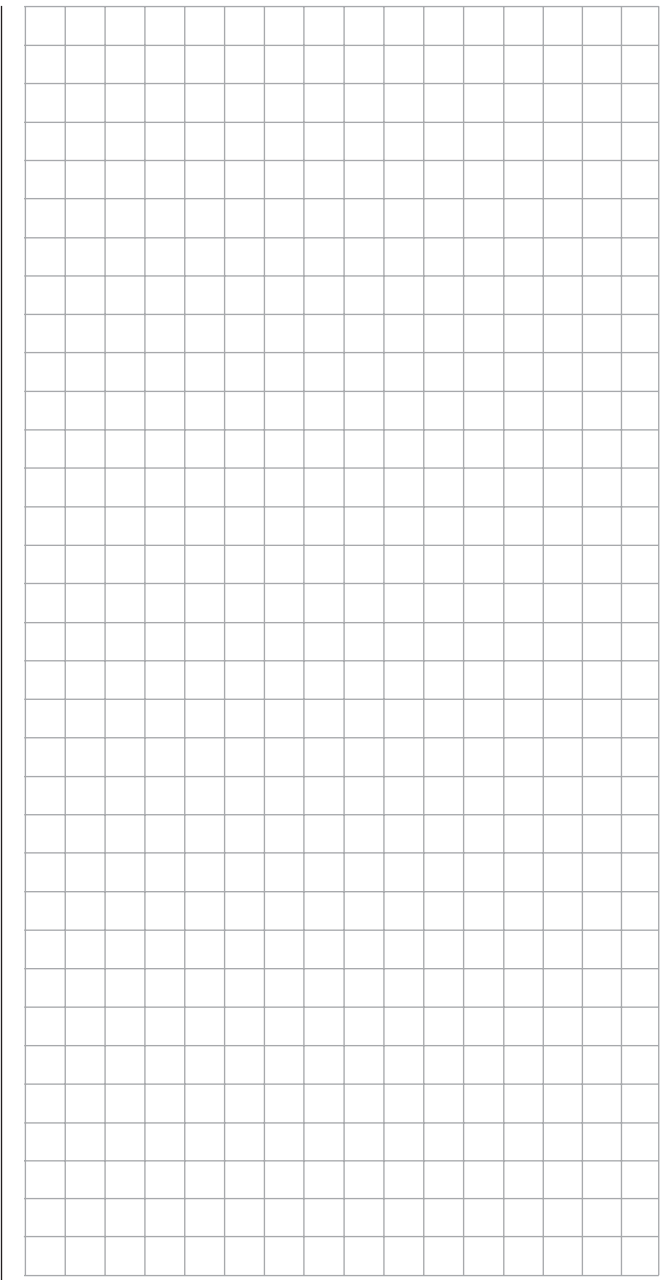

✂ Helicopter type

Establishing helicopter model type

This "Model type" menu is used to establish the type of model to be programmed. This also activates all characteristic mixers, coupling functions, etc. in preparation for subsequent programming of the specified model type.

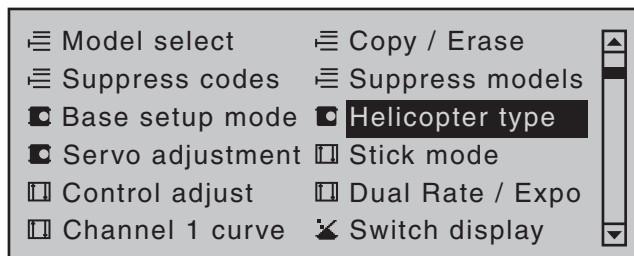

Briefly tap the center **SET** key of the right touch pad:

Swashplate type

Control of the swashplate will require an appropriate program variant which corresponds to the number of servos operating pitch control.

In the meantime this selection is also influenced by the type of control exercised on swashplate servos. Since Flybar systems generally do not require transmitter-side swashplate mixers, when such a system is in use, "1 Servo" is generally to be selected as the swashplate type, regardless of the actual number of swashplate servos present. **In this context, be sure the Flybar system complies with the included adjustment instructions as otherwise there is a risk the helicopter will not fly.**

After selecting the »Swashplate type« line with the ▲ ▼ selection keys of the left or right touch pad, the entry field will be framed.

| HELTYPE | |
|--------------------|---------|
| ▶ Swashplate type | 1 Servo |
| Linearis. swashpl. | no |
| Rotor direction | right |
| Pitch min. | rear |
| ▼ | SEL |

Briefly tap the center **SET** key of the right touch pad. The current setting for number of pitch servos will be displayed in inverse video. Now choose the variant needed with the selection keys of the right touch pad.

"1 Servo": A Flybar system is in use or the swashplate is tipped with one servo each for roll and pitch-axis. Pitch control will be affected by *one* separate servo.

(Since helicopter models, like Flybar systems, which are operated with only 1 pitch servo, neither need any of the three swashplate servos for pitch, pitch-axis and roll NOR the transmitter's mixer functions for pitch, pitch-axis and roll, the »Swashplate mixer« menu option will be suppressed in the Multi-function menu.)

"2 Servo": Two roll servos will displace the swashplate axially to affect pitch control; nick control will be decoupled by a mechanical compensation rocker.

"3Sv(2Roll)": Symmetric three-point control of the swashplate with three, radially offset articulation points, each offset by 120°, connected to one pitch-axis servo (front or rear) and two roll servos (left and right). All three servos push the swashplate axially to affect pitch control.

"3Sv (140°)": Asymmetrical three-point control of the swashplate is affected at three articulation points connected to one nick servo (rear) and two roll servos (front left and right). All three servos push the swashplate axially to affect pitch control.

"3Sv (2Nick)": Symmetric three-point control as described above but radially offset by 90°, one lateral roll servo and two pitch-axis servos, front and rear.

"4Sv (90°)": Four-point swashplate control affected by two roll servos and two nick servos.

Simultaneous tap on the ▲ ▼ or ◀ ▶ keys of the right touch pad (**CLEAR**) will reset the option back to "1 Servo".

Swashplate type: 1 Servo

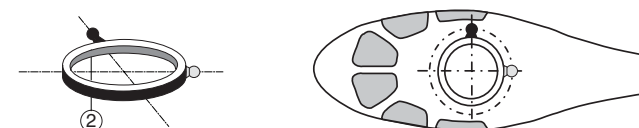

Swashplate type: 2 Servos

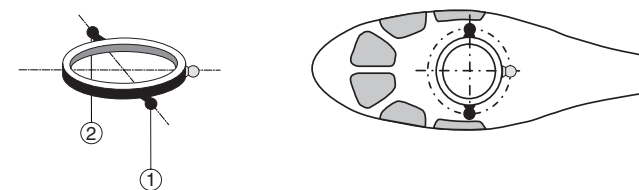

Swashplate type: 3 Servos (2 Roll)

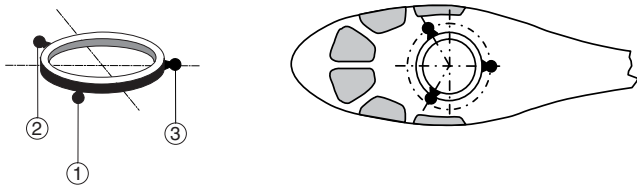

Swashplate type: 3 Servos (140°)

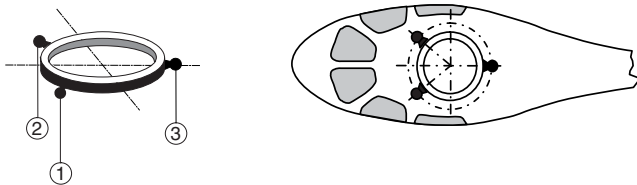

Swashplate type: 3 Servos (2 Nick)

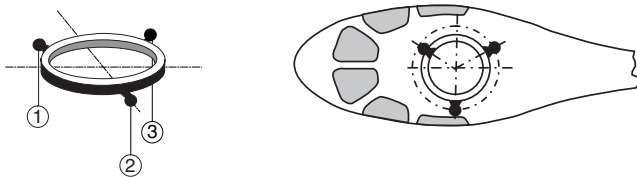

Swashplate type: 4 Servos (90°) 2 Nick / 2 Roll

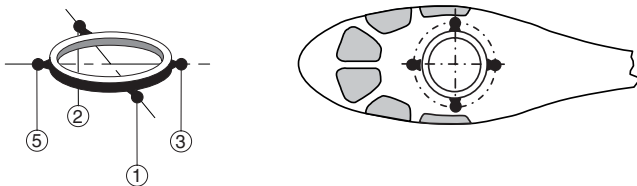

Note:

Except for the "1 Servo" choice, swashplate mixer proportions must also be set in the »Swashplate mixer« menu, page 208.

Swashplate linearization

After selecting the »Linearis. swashpl.« line with the ▲▼ selection keys of the left or right touch pad, the entry field will be framed.

| HELTYPE | |
|----------------------|---------|
| Swashplate type | 1 Servo |
| ► Linearis. swashpl. | no |
| Rotor direction | right |
| Pitch min. | rear |
| ▼ | SEL |

The "yes" entry will prevent undesired side effects such as pitch change due to a roll function or tension between swashplate servo rods.

This type of tension can arise when effected servos strain for different displacement positions due to travel which deviates from one another.

Linearizing will require a bit of familiarization on the part of the pilot because, in order to linearize the entire rotation travel of the servo arm, servo travel is reduced in small control movements—similar to a pronounced exponential setting.

Rotor direction

After selecting the »Rotor direction« line with the ▲▼ selection keys of the left or right touch pad, the entry field will be framed.

| HELTYPE | |
|--------------------|---------|
| Swashplate type | 1 Servo |
| Linearis. swashpl. | no |
| ► Rotor direction | right |
| Pitch min. | rear |
| ▼ | SEL |

After a tap on the center **SET** key, the main rotor's direction of rotation is entered in the »Rotor direction«

line with the selection keys of the right touch pad:

"right": The main rotor turns clockwise when viewed from above.

"left": The main rotor turns counter-clockwise when viewed from above.

A simultaneous tap on the ▲▼ or ◀▶ keys of the right touch pad (**CLEAR**) will set the option to "right".

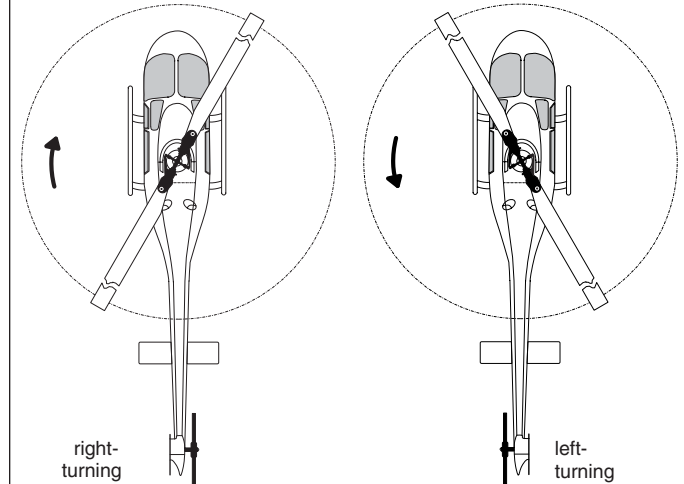

This entry is necessary for the correct orientation of torque and power compensation mixer settings made in the »Helicopter mixer« menu:

- Pitch,
- Channel 1 → Throttle,
- Channel 1 → Tail rot.,
- Tail rotor → Throttle
- Roll → Throttle
- Roll → Tail rot.
- Pitch → Throttle,
- Pitch-axis → Throttle
- Pitch-axis → Tail rotor

Pitch min

After selecting the »Pitch min.« (pitch minimum) line with the ▲▼ selection keys of the left or right touch pad, the entry field will be framed.

| HELTYPE | |
|--------------------|---------|
| Swashplate type | 1 Servo |
| Linearis. swashpl. | no |
| Rotor direction | right |
| ► Pitch min. | rear |
| ▼ | SEL |

The »Pitch min.« line is used to adapt the actuation direction of the throttle/pitch joystick to personal control preferences. All other helicopter program options which involve throttle and pitch functions, e.g. throttle curve, idle trimming, tail rotor mixer, etc., are dependent on this setting.

Tap the center **SET** key of the right touch pad. The operating direction of the throttle/pitch joystick will be displayed in inverse video. Now choose the variant needed with the selection keys of the right touch pad.

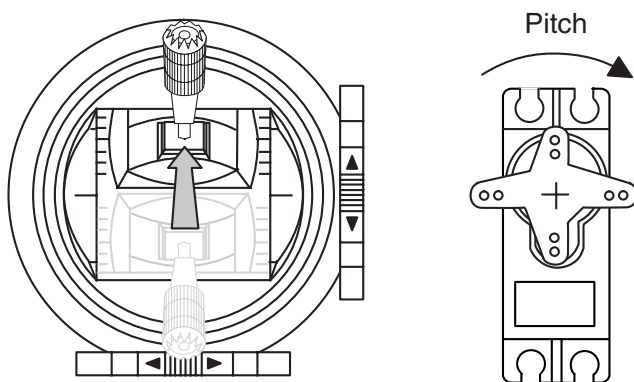

These mean:

"fwd.": minimum pitch setting when the pitch joystick (C1) is "forward", i.e. away from the pilot.

"rear": minimum pitch setting when the pitch joystick (C1) is "back", i.e. toward the pilot.

A simultaneous tap on the ▲▼ or ◀▶ keys of the right touch pad (**CLEAR**) will set this option to "rear".

Notes:

- C1 trimming affects only the throttle servo.
- The so-called "throttle limit" is set by default, see text beginning page 117, by way of input "GL16" in the »**Control adjust**« menu with which the throttle servo can be limited, independent of the pitch servo, in the full throttle direction.
- Since a given user's models will typically be operated with the same pitch-min direction, this specification can be conveniently preselected in the "transmitter-specific" »**General basic settings**« menu, page 259. This specification will then be adopted automatically when a new model memory is created in the »**Helicopter type**« menu but, if desired, can be adapted on a model-specific basis as described.

Expo throttle limit

After selecting the »Expo throttle lim.« line with the ▲▼ selection keys of the left or right touch pad, the entry field will be framed.

| HELTYPE | |
|----------------------|-------|
| Linearis. swashpl. | no |
| Rotor direction | right |
| Pitch min. | rear |
| ► Expo throttle lim. | 0% |
| ▼ ▲ | SEL |

The "Throttle limit" function described in the »**Control adjust**« menu, see page 117, can be assigned an exponential characteristic curve.

A pitch progression rate between -100% and +100% can be set with the selection keys.

For example, it is practical to have the throttle limit –by default, the right-side proportional rotary slider –also regulate the idle setting. Further details about the throttle limit can be found in the text for the »**Control adjust**« menu beginning page 112.

An example of two exponential throttle limit curve characteristics for 100% servo travel.

continuous line:
negative exponential values;
dashed line:
positive exponential values

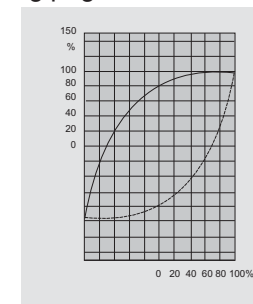

Throttle limit warning

| HELTYPE | |
|----------------------|-------|
| Rotor direction | right |
| Pitch min. | rear |
| Expo throttle lim. | 0% |
| ► Thr. limit warning | -70% |
| ▲ | SEL |

If the carburetor is open too far when the transmitter is switched on, an acoustic warning will be sounded and a warning will be presented in the display.

Throttle
too
high!

The »Thr. limit warning« option permits the setting of a variable for the critical position of the throttle servo between 0% and -100%, above which the warning will be issued. The reference point for this option is the "fwd." or "rear" Pitch min. joystick position set in this menu.

A default value of -70% control travel is provided.
A simultaneous tap on the ▲▼ or ◀▶ keys of the right touch pad (**CLEAR**) will reset a changed value back to the default value.

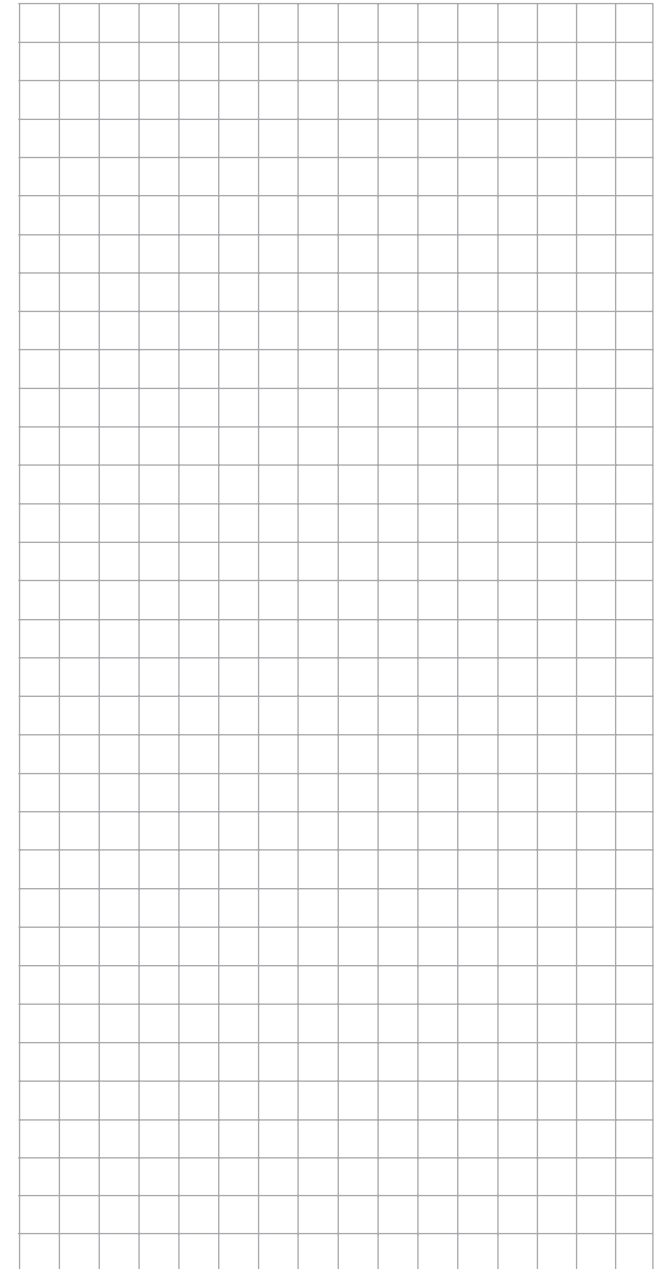
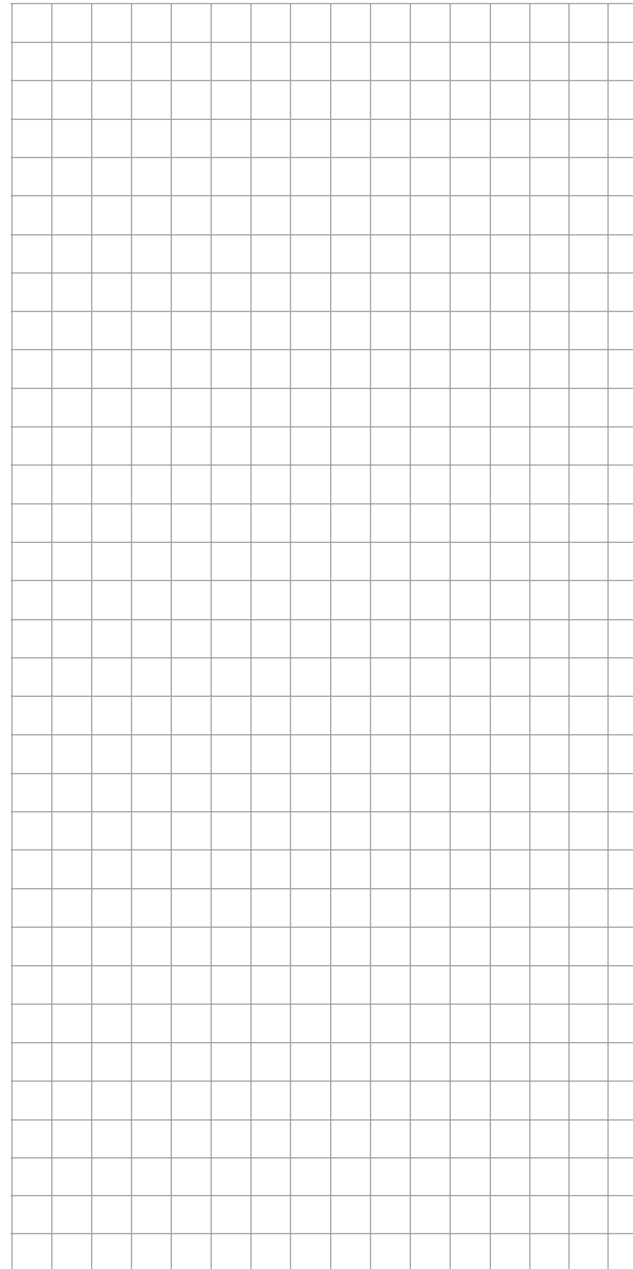

Servo adjustment

Servo direction, midpoint, travel and limit

This menu is used to set the direction, neutralization, travel and limit parameters for a given selected servo exclusively.

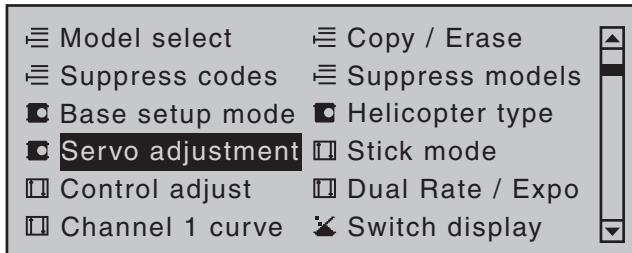
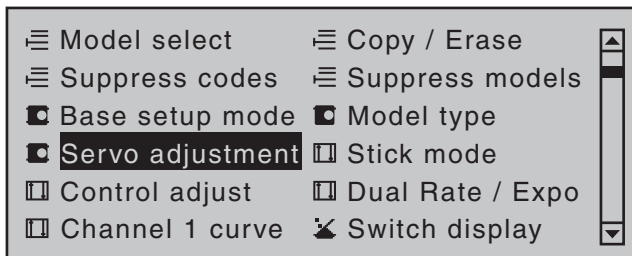

Briefly tap the center **SET** key of the right touch pad:

| | | | | | |
|--------------|-------|----------|------|---------|------|
| ▶ Servo 1 => | 0% | 100% | 100% | 150% | 150% |
| Servo 2 => | 0% | 100% | 100% | 150% | 150% |
| Servo 3 => | 0% | 100% | 100% | 150% | 150% |
| Servo 4 => | 0% | 100% | 100% | 150% | 150% |
| Servo 5 => | 0% | 100% | 100% | 150% | 150% |
| ▼ Rev | cent. | - travel | + | - limit | + |

Begin setting servo parameters in the left column.

Basic procedure:

1. Select the desired servo, 1 ... 16, with the ▲▼ selection keys of the left or right touch pad.
2. If necessary, use the ◀▶ selection keys of the left or right touch pad to reach the desired column then, if desired, move the respective control out of its midpoint to make an asymmetric setting.

3. Briefly tap the center **SET** key of the right touch pad. The corresponding input field is shown highlighted.
4. Use the selection keys of the right touch pad to set the desired value.
5. Briefly tap the center **SET** key of the right touch pad to complete data entry.
6. A simultaneous tap on the ▲▼ or ◀▶ keys of the right touch pad (**CLEAR**) will any setting made back to its respective default value.

Important:

Servo designation numerals are based on the respective receiver outputs to which they are connected, provided that no swapping of transmitter and/or receiver outputs has been specified. This means that even a change of stick mode will not effect the numbering of servos.

Column 2 "rev"

The direction in which a servo turns is adapted to the practical reality of the given model so that the assembly of control rods and joints do not need to accommodate a specific servo rotation direction. Rotation direction is symbolized by the "=>" and "<=" character combinations. Servo rotation direction must be specified before making settings for the options which follow below.

A simultaneous tap on the ▲▼ or ◀▶ keys of the right touch pad (**CLEAR**) will reset rotation direction back to "=>".

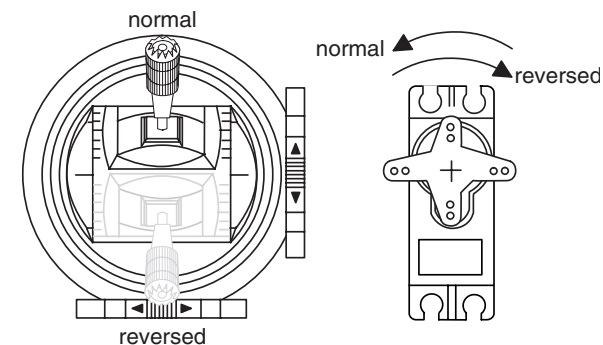

Column 3 "cent."

The servo midpoint (center) setting is intended for adapting a non-standard servo (a servo whose midpoint position does not correspond to a pulse length of 1.5 ms, i.e. 1500 μs), as well as for minor adjustments, e.g. for the fine tuning of the neutral position of model rudders.

Independent of trim wheels and any mixer settings, the neutral point can be shifted in a range of -125 bis +125% within a maximum servo travel of ± 150%. Independent of all other trim and mixer settings, this setting is always based directly on the respective servo.

Note that extreme offsets of the neutral point can lead to one-sided restrictions of servo travel because overall travel is limited by both electronic and mechanical aspects to a maximum of ±150%.

A simultaneous tap on the ▲▼ or ◀▶ keys of the right touch pad (**CLEAR**) will reset the entry field value displayed in inverse video back to "0%".

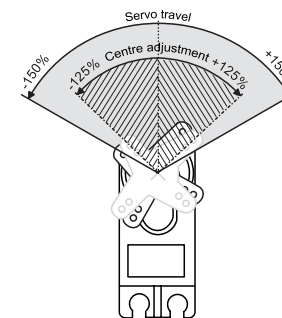

Column 4, "-travel+"

| | | | | | |
|--------------|-----|-------|----------|------|-----------|
| ▶ Servo 1 => | 0% | 100% | 100% | 150% | 150% |
| Servo 2 => | 0% | 100% | 100% | 150% | 150% |
| Servo 3 => | 0% | 100% | 100% | 150% | 150% |
| Servo 4 => | 0% | 100% | 100% | 150% | 150% |
| Servo 5 => | 0% | 100% | 100% | 150% | 150% |
| ▼ | Rev | cent. | - travel | + | - limit + |

This column is used to set servo travel symmetrically or asymmetrically for each side. The setting range is 0 ... 150% of normal servo travel. The values set are based on the settings that have been made for the "midpoint" column.

To create a *symmetric* travel path, i.e. control-side independent travel, the respective control (joystick, proportional control or switch) is to be put into a position which covers travel to *both sides* of the marked frame.

Note:

It may be necessary to first assign a control attached to one of the control channels 5 ... 16. If necessary, this is to be done in the »Control adjust« menu, see page 108 or 112.

To set *asymmetric* travel, the respective control (joystick, proportional control or switch) is to be moved to the side on which the marked frame only includes the value to be changed.

The value setting is activated with a brief tap on the center **SET** key of the right touch pad. The value field is shown highlighted. Values can be changed with the selection keys of the right touch pad. Complete the entry with a tap on the center **SET** key of the right touch pad.

A simultaneous tap on the ▲▼ or ◀▶ keys of the right touch pad (**CLEAR**) will reset the changed parameter displayed in inverse video back to "100%".

Important:

In contrast to settings made with the »Control adjust« menu, all settings made in this menu affect exclusively the respective servo, independent of how the control signal for this servo is produced, i.e. directly by a joystick or by way of any mixer functions.

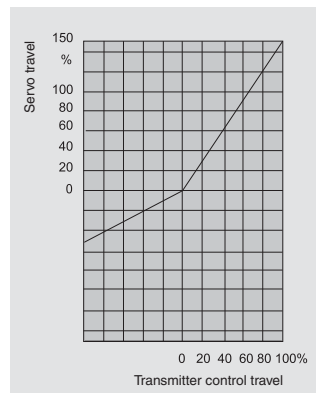

The adjacent figure shows and example of a side-dependent servo setting, -50% and +150%.

Column 5 "-limit+"

The "- limit +" column is reached by moving the marker frame, with the ▶ selection keys of the left or right touch pad, to the right beyond the "- travel +" column.

| | | | | | |
|--------------|-----|-------|----------|------|-----------|
| ▶ Servo 1 => | 0% | 100% | 100% | 150% | 150% |
| Servo 2 => | 0% | 100% | 100% | 150% | 150% |
| Servo 3 => | 0% | 100% | 100% | 150% | 150% |
| Servo 4 => | 0% | 100% | 100% | 150% | 150% |
| Servo 5 => | 0% | 100% | 100% | 150% | 150% |
| ▼ | Rev | cent. | - travel | + | - limit + |

To create a *symmetric* limit, i.e. control-side independent limit, the respective control (joystick, proportional control or switch) is to be put into a position such that the marker frame covers *both sides* of the travel setting.

To set *asymmetric* travel, the respective control

(joystick, proportional control or switch) is to be moved to the side where it is to be set such that the marker frame only includes the value to be changed. A simultaneous tap on the ▲▼ or ◀▶ keys of the right touch pad (**CLEAR**) will reset the entry field value displayed in inverse video back to "0%".

Example:

A servo is controlled separately by two controls over a mixer and but, for model-specific reasons, must only be operated over a servo travel path of 100% because, for example, the rudder would mechanically collide with the elevator if moved more than 100%.

As long as only one control is used at a time, this is no problem. But this does become a problem when the signals are summed by the simultaneous use of both controls (e.g. aileron and rudder) to total travel in excess of 100%. The linkage and servos could be strained excessively ...

To prevent this, the travel should certainly be limited by way of an individual travel limit. In the case of the rudder used in the example, this would be a value slightly less than 100%—because it is assumed the rudder would collide at 100%.

Joystick setting

Setting stick mode 1 through 4

Both joysticks are equipped for digital trimming. When turning trim wheels, every "click" will shift the joystick's neutral position by a certain value.

The current position is shown on the screen and the adjustment is also made "audible" with acoustic tones. This makes finding the mid-point during flight easy, without looking at the screen. If the mid-point is overrun, a brief motion pause will be inserted.

Current trim values are automatically stored when a model memory change is made.

Furthermore—except for global control function trimming of the throttle/brake joystick, commonly referred to as control function "C1" (channel 1)—digital trimming is effective within a model memory location selectively as either a global parameter (i.e. consistent in all flight phases) or as a flight-phase specific parameter. This specification as "global" or "phase" is made in the »Stick mode« menu described here, whereas software-side C1 trimming is generally set to "global", i.e. independent of flight phases.

This setting is visualized in the base screen by a "shadow" on trim bars:

- shadow present = global,
- no shadow = flight phase dependent.

In two corresponding figures below, elevator trim—shown in the middle text column with its default setting "global"—then in the right column set to flight "Phase" specific.

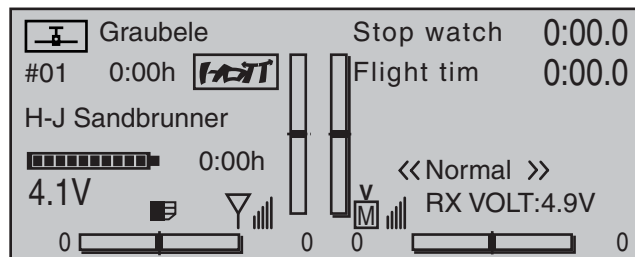

Use the selection keys on the left or right touch pad to scroll to the »Stick mode« option in the multi-function menu:

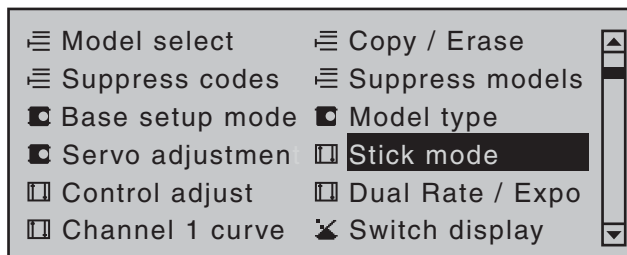

Open this menu option with a tap on the center **SET** key of the right touch pad.

| | | | |
|-------------|--------|----------|-----------|
| ▶ Channel 1 | global | 4 | 0.0s 0.0s |
| Aileron | global | 4 | 0.0s 0.0s |
| Elevator | global | 4 | 0.0s 0.0s |
| Rudder | global | 4 | 0.0s 0.0s |
| | Trim | Tr. step | – time + |

This menu, adapted for winged models, permits the four digital trim wheels to be set and their trim effects to be assigned, selectively, as a "deceleration" factor to control functions 1 through 4.

The desired line can be reached by using the selection keys of the left or right touch pad. Once the appropriate function field has been selected and then the center **SET** key of the right touch pad is touched briefly, the field will appear in inverse video and the desired setting can be made with the selection keys of the right touch pad.

Trim

Except for "Channel 1", this column can be used to switchover trim effect from "GL(lobal)" to "PH(ase)" and vice versa.

| | | | |
|------------|--------|----------|-----------|
| Channel 1 | global | 4 | 0.0s 0.0s |
| Aileron | global | 4 | 0.0s 0.0s |
| ▶ Elevator | Phase | 4 | 0.0s 0.0s |
| Rudder | global | 4 | 0.0s 0.0s |
| | Trim | Tr. step | – time + |

"Global": The position of the respective trim wheel is effective "globally" for all flight-phases programmed for the given model, page 140.

"Phase": The position of the respective trim wheel is effective on a phase-specific basis and will be automatically stored upon change of flight phase so that the setting is again available following a return to this flight phase.

A simultaneous tap on the ▲▼ or ◀▶ keys of the right touch pad (**CLEAR**) will reset the option back to "Global".

Trim steps

The four digital trim wheels shift the neutral point of the respective joystick in the given direction by one adjustable increment, as set here, for each "click". This is where the increment size (step) can be adjusted for a given direction, whereby maximum trim travel, independent of the selected number of trim steps, is always about ±30% of control travel.

After selecting the "Tr. step" column (trim steps) and the desired trim control with the ▲▼ selection keys of the left or right touch pad, the corresponding entry field will be framed.

| | | | |
|------------|--------|----------|-----------|
| Channel 1 | global | 4 | 0.0s 0.0s |
| Aileron | global | 4 | 0.0s 0.0s |
| ▶ Elevator | Phase | 4 | 0.0s 0.0s |
| Rudder | global | 4 | 0.0s 0.0s |
| | Trim | Tr. step | - time + |
| ▼ | | | |

Briefly tap the center **SET** key of the right touch pad. The current setting will be displayed in inverse video. Now select the desired value, between 1 and 10, with the selection keys of the right touch pad. For example:

| | | | |
|------------|--------|----------|-----------|
| Channel 1 | global | 4 | 0.0s 0.0s |
| Aileron | global | 4 | 0.0s 0.0s |
| ▶ Elevator | Phase | 8 | 0.0s 0.0s |
| Rudder | global | 4 | 0.0s 0.0s |
| | Trim | Tr. step | - time + |
| ▼ | | | |

A simultaneous tap on the ▲▼ or ◀▶ keys of the right touch pad (**CLEAR**) will reset any change made to the active field back to "4".

Time

The rate of control signal change with respect to the speed of joystick motion can be influenced by the entries made in the "- time +" column. Each joystick movement direction, i.e. joystick control channels 1 through 4, can be set individually. This means that respective servos will then follow rapid control position changes only at an accordingly delayed rate. This time delay has a direct effect on the control function and therefore also any servos controlled by this function.

The time can be programmed symmetrically for both sides or separate for each control direction. This setting has a programmable range of 0 s to 9.9 s. In

the case of side-separate settings, the joystick is to be moved to the respective side so that the inverse video field will switch between sides to the one for which the change is to be made—for example, even to ensure gentle rev-up of the propulsion motor despite a (too) fast motion of the C1 stick.

| | | | |
|-------------|--------|----------|-----------|
| ▶ Channel 1 | global | 4 | 0.0s 1.1s |
| Aileron | global | 4 | 0.0s 0.0s |
| Elevator | Phase | 8 | 0.0s 0.0s |
| Rudder | global | 4 | 0.0s 0.0s |
| | Trim | Tr. step | - time + |
| ▼ | | | |

On the other hand, for reasons of safety, the motor cut-off should always be "immediate".

A simultaneous tap on the ▲▼ or ◀▶ keys of the right touch pad (**CLEAR**) will reset any change made to the active field back to "0.0 s".

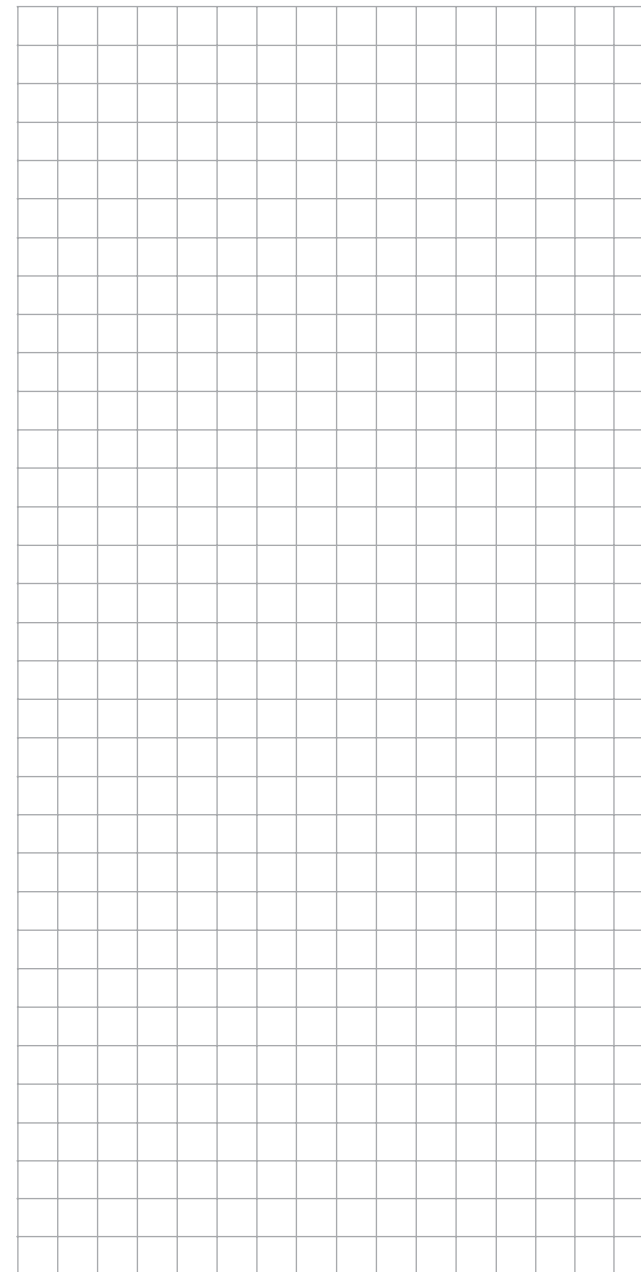

Joystick setting

Setting stick mode 1 through 4

Both joysticks are equipped for digital trimming. When turning trim wheels, every "click" will shift the joystick's neutral position by a certain value.

The current position is shown on the screen and the adjustment is also made "audible" with acoustic tones. This makes finding the mid-point during flight easy, without looking at the screen. If the mid-point is overrun, a brief motion pause will be inserted.

Current trim values are automatically stored when a model memory change is made.

Furthermore—except for trimming the throttle/brake joystick—digital trimming is effective selectively either as a global parameter, i.e. consistent in all flight phases, or as a flight-phase specific parameter. This specification as "Global" or "Phase" is made in the »**Stick mode**« menu described here, whereas throttle trimming is always made "global" by software, i.e. independent of flight phases.

This setting is visualized in the base screen by a "shadow" on trim bars:

- shadow present = global,
- no shadow = flight phase dependent.

In the following figure, pitch-axis trimming is used as an example of flight-phase dependence—presented at the left in its default Mode 1.

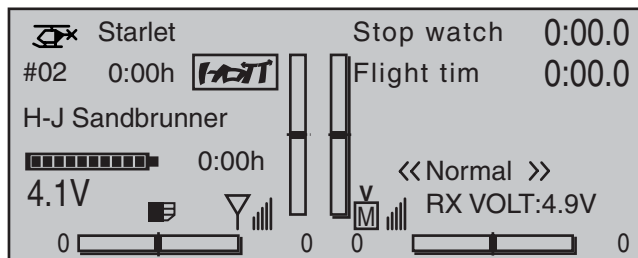

Use the selection keys on the left or right touch pad to scroll to the »**Stick mode**« option in the multi-function menu:

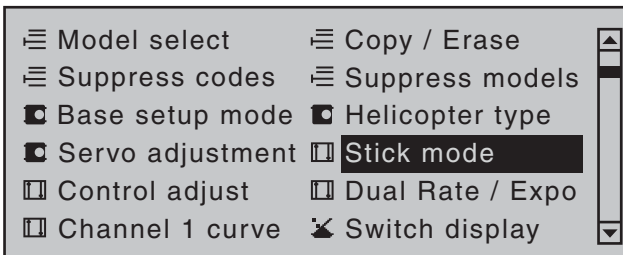

Open this menu option with a tap on the center **SET** key of the right touch pad.

| ► Pitch/thr | Thr trim | 4 | 0.0s | 0.0s |
|-------------|----------|----------|----------|------|
| Roll | global | 4 | 0.0s | 0.0s |
| Pitch ax | global | 4 | 0.0s | 0.0s |
| Tail rot. | global | 4 | 0.0s | 0.0s |
| | Trim | Tr. step | – time + | |

This menu, adapted for helicopter models, permits the four digital trim wheels to be set and their trim effects to be assigned, selectively, as a "deceleration" factor to control functions 1 through 4.

The desired line can be reached by using the selection keys of the left or right touch pad. Once the appropriate function field has been selected and then the center **SET** key of the right touch pad is touched briefly, the field will appear in inverse video and the desired setting can be made with the selection keys of the right touch pad.

Trim

These setting variations are configured to accommodate the needs of helicopter models, which is why the following alternative options are available for the "Thr." line:

| ► Pitch/thr | Thr trim | 4 | 0.0s | 0.0s |
|-------------|----------|----------|----------|------|
| Roll | global | 4 | 0.0s | 0.0s |
| Pitch ax | global | 4 | 0.0s | 0.0s |
| Tail rot. | global | 4 | 0.0s | 0.0s |
| | Trim | Tr. step | – time + | |

"Thr trim": (throttle limit)
C1 trimming operates as idle trimming when the "throttle limit" function regulates the motor for starting, see »**Control adjust**« menu, page 117.

"Throttle AR": (Throttle Autorotation)
C1 trim operates as idle trim exclusively in the «Autorot» flight phase.

This makes it possible to assign a principle (fixed) preset AR throttle position in the »**Helicopter mixer**« menu, page 176, e.g. during autorotation practice with the trim wheel "varied".

A simultaneous tap on the ▲▼ or ◀▶ keys of the right touch pad (**CLEAR**) will reset the option back to "Thr trim".

"Pitch": Due to internal coupling, C1 trimming acts equally on all pitch servos available without influencing the throttle servo.

On the other hand, the trim effects of respective digital trim controls for the lines "Roll", "Pitch ax" and "Tail rot." can be switched over from "Global" to "Phase" and vice versa.

| | | | | |
|-------------|----------|----------|--------|------|
| Pitch/thr | Thr trim | 4 | 0.0s | 0.0s |
| Roll | global | 4 | 0.0s | 0.0s |
| Pitch ax | global | 4 | 0.0s | 0.0s |
| ▶ Tail rot. | Phase | 4 | 0.0s | 0.0s |
| | Trim | Tr. step | - time | + |

"Global": The position of the respective trim wheel is effective "globally" for all flight-phases programmed for the given model, page 140.

"Phase": The position of the respective trim wheel is effective on a phase-specific basis and will be automatically stored upon change of flight phase so that the setting is again available following a return to this flight phase.

A simultaneous tap on the ▲▼ or ◀▶ keys of the right touch pad (**CLEAR**) will reset the option back to "Global".

Trim steps

The four digital trim wheels shift the neutral point of the respective joystick in the given direction by one adjustable increment, as set here, for each "click". This is where the increment size (step) can be adjusted for a given direction, whereby maximum trim travel, independent of the selected number of trim steps, is always about ±30% of control travel. After selecting the "Tr. step" column and the desired trim control with the ▲▼ selection keys of the left or right touch pad, the corresponding entry field will be framed.

| | | | | |
|------------|----------|----------|--------|------|
| Pitch/thr | Thr trim | 4 | 0.0s | 0.0s |
| Roll | global | 4 | 0.0s | 0.0s |
| ▶ Pitch ax | global | 4 | 0.0s | 0.0s |
| Tail rot. | Phase | 4 | 0.0s | 0.0s |
| | Trim | Tr. step | - time | + |

Briefly tap the center **SET** key of the right touch pad. The current setting will be displayed in inverse video. Now select the desired value, between 0 and 10, with the selection keys of the right touch pad. For example:

| | | | | |
|------------|----------|----------|--------|------|
| Pitch/thr | Thr trim | 4 | 0.0s | 0.0s |
| Roll | global | 4 | 0.0s | 0.0s |
| ▶ Pitch ax | global | 0 | 0.0s | 0.0s |
| Tail rot. | Phase | 4 | 0.0s | 0.0s |
| | Trim | Tr. step | - time | + |

A simultaneous tap on the ▲▼ or ◀▶ keys of the right touch pad (**CLEAR**) will reset any change made to the active field back to "4".

Time

The rate of control signal change with respect to the speed of joystick motion can be influenced by the entries made in the "- time +" column. Each joystick movement direction, i.e. joystick control channels 1 through 4, can be set individually. This means that respective servos will then follow rapid control position changes only at an accordingly delayed rate. This time delay has a direct effect on the control signal and therefore also commensurately on any servos controlled by the effected controls. The time can be programmed symmetrically for both sides or separate for each control direction. This

setting has a programmable range of 0 s to 9.9 s. In this latter case, the given stick control is to be moved to the respective side so that the inverse video field will switch between sides to the one for which the change is to be made.

Example:

All three servos are to be actuated for swashplate pitch control, e.g. a "Pitch" control movement for a "3Sv (2Roll)" swashplate. However, travel for the middle servo is greater than that of the other two servos on the shorter lever.

A rash "Pitch" control movement would not operate the nick servo in the middle as quickly as it would the two roll servos on the shorter lever. This would cause a momentary control motion in the "nick" direction. However, if response time for the "pitch" control function were to be reduced by at least the positioning time for the servo in the middle then all three servos would reach their proper positions at the same time. The necessary delay times typically amount to only a few tenths of a second. For example:

| | | | | |
|-------------|----------|----------|--------|------|
| ▶ Pitch/thr | Thr trim | 4 | 0.0 | 4.4s |
| Roll | global | 4 | 0.0s | 0.0s |
| Pitch ax | global | 0 | 0.0s | 0.0s |
| Tail rot. | Phase | 4 | 0.0s | 0.0s |
| | Trim | Tr. step | - time | + |

A simultaneous tap on the ▲▼ or ◀▶ keys of the right touch pad (**CLEAR**) will reset any change made to the active field back to "0.0 s".

Control adjust

Basic procedure for transmitter control and switch assignment

Use the selection keys on the left or right touch pad to scroll to the »**Control adjust**« option in the multi-function menu:

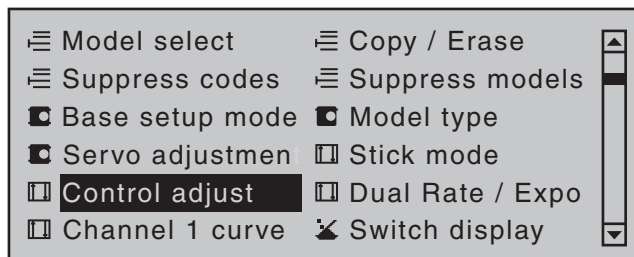

Tap briefly on the center **SET** key of the right touch pad to open this menu option:

| | | | | | | | |
|---------------------------------------|----|----|-----|----|-------|-------|---------|
| ► I5 | GL | fr | --- | 0% | +100% | +100% | 0.0 0.0 |
| I6 | GL | fr | --- | 0% | +100% | +100% | 0.0 0.0 |
| I7 | GL | fr | --- | 0% | +100% | +100% | 0.0 0.0 |
| I8 | GL | fr | --- | 0% | +100% | +100% | 0.0 0.0 |
| ▼ TYP SEL /_ Offset - travel + -time+ | | | | | | | |

In addition to the two joysticks for control functions 1 to 4 and their trim wheels, the **MC-20** HoTT transmitter also has other controls as standard equipment:

- two 3-way switches
- two 2-way switches
- two unlockable 2-way switches
- two self-restoring 2-way switches
- three proportional sliders on the middle console, designated SR 1 ... 3 in the menu
- two side-mounted "rotary sliders", designated SD1 and 2 in the menu
- two depressible "rotary controls", designated DG2 and 4 in the menu
- three roller-shaped rotary controls, designated as DG1, DG3 and DG5 in the menu

In contrast to the two joysticks which, when initialized for a new model memory as a "Winged aircraft" model type will already be configured to operate the servos connected to receiver outputs 1 ... 4, these "other" operating elements initially remain inactive.

Thus, at least in the system's delivered state—as already mentioned on page 68—or even after initialization of a new model memory with an "aircraft" model type and its "binding" to the receiver intended for installation, only those servos connected to the two joysticks by way of receiver outputs 1 ... 4 are able to be operated; any servos which may be connected to receiver outputs 5 ... 16 will initially remain inactive in their middle positions.

While this may appear a bit awkward at first glance ... this is the only way to ensure a completely free selection from among "additional" operating elements while, at the same time, not requiring the "deactivation" of unused operating elements. This is because

the only way to ensure an unused operating element can have no effect on the model, even if operated by accident, is to make it inactive, i.e. not assigned to any function.

All of the aforementioned operating elements can be freely assigned in this »**Control adjust**« menu, see page 54, to any function input just to accommodate personal requirements. Equally, this also means that each of these operating elements can also be assigned to multiple functions at the same time, as needed. For example: the exact same toggle switch assigned to an input in this menu can, at the same time, also have an assignment in the »**Timers (general)**« menu as an "On/Off" switch, etc.

Furthermore, *all* inputs can be selectively set to *global* or *flight-phase specific* operation if they have been defined for flight-phases in the »**Phase settings**« menu, page 142, and »**Phase assignment**« menu,

page 148. The names assigned to given flight phases then appear in the second-from-the-bottom display line, e.g. «Normal».

Basic procedure

1. Use the ▲▼ selection keys of the left or right touch pad to select the desired input, "I5 ... I16".
2. If necessary, use the ◀▶ selection keys of the left or right touch pad to change to the desired column.
3. Briefly tap the center **SET** key of the right touch pad. The corresponding input field is shown highlighted.
4. Operate the chosen operating element or set the desired value with the selection keys of the right touch pad.
5. Briefly tap the center **SET** key of the right touch pad to complete data entry.
6. A simultaneous tap on the ▲▼ or ◀▶ keys of the right touch pad (**CLEAR**) will any setting made back to its respective default value.

Column 2, "TYP"

Similar to the previously described »**Stick mode**« menu, this column can be used to define whether further settings for the given input are to have a "GL(lobal)" or a "PH(ase-specific)" effect. Do this by using the selection keys of the left or right touch pad to select the desired input 5 through 16 in the column labeled "TYP".

| | | | | | | | |
|---------------------------------------|----|----|-----|----|-------|-------|---------|
| ► I5 | GL | fr | --- | 0% | +100% | +100% | 0.0 0.0 |
| I6 | GL | fr | --- | 0% | +100% | +100% | 0.0 0.0 |
| I7 | GL | fr | --- | 0% | +100% | +100% | 0.0 0.0 |
| EI | GL | fr | --- | 0% | +100% | +100% | 0.0 0.0 |
| «Normal » | | | | | | | |
| ▼ TYP SEL /_ Offset - travel + -time+ | | | | | | | |

"GL": The settings for the input in question affect all flight phases programmed (if any) and thus act "globally" on the model memory in question.

"PH": The settings for this input take effect per flight phase and must therefore be configured separately for each flight phase.

Note:

See page 140 for more information about flight phases.

Column 3, "Transmitter control/switch assignment"

Select an input, 5 through 16, with the ▲▼ selection keys of the left or right touch pad.

Transmitter control assignment

Use the selection keys to move into the column labeled **SEL**. After completing the activation of transmitter control assignment by tapping the center **SET** key of the right touch pad, the message shown below will appear in the display:

| | | | | | | | |
|---------------------------------------|----|----|--------------|----|-------|-------|---------|
| ▶ I5 | GL | fr | --- | 0% | +100% | +100% | 0.0 0.0 |
| I6 | GL | fr | Move desired | 0% | 0.0 | 0.0 | 0.0 |
| I7 | GL | fr | control adj. | 0% | 0.0 | 0.0 | 0.0 |
| I8 | GL | fr | --- | 0% | +100% | +100% | 0.0 0.0 |
| «Normal » | | | | | | | |
| ▼ TYP SEL /_ Offset - travel + -time+ | | | | | | | |

Now actuate the desired transmitter control: The notice window will disappear and the designation of the selected transmitter control will appear in the transmitter control assignment window.

| | | | | | | | |
|---------------------------------------|----|-----|-----|----|-------|-------|---------|
| ▶ I5 | GL | S11 | --- | 0% | +100% | +100% | 0.0 0.0 |
| I6 | GL | fr | --- | 0% | +100% | +100% | 0.0 0.0 |
| I7 | GL | fr | --- | 0% | +100% | +100% | 0.0 0.0 |
| EI | GL | fr | --- | 0% | +100% | +100% | 0.0 0.0 |
| «Normal » | | | | | | | |
| ▼ TYP SEL /_ Offset - travel + -time+ | | | | | | | |

Alternatively, the center **SET** key of the right touch pad can be tapped for a second time while the notice window, see above, is still on the display:

| | | | | | | | |
|---------------------------------------|----|----|-----|----|-------|-------|---------|
| ▶ I5 | GL | fr | --- | 0% | +100% | +100% | 0.0 0.0 |
| I6 | GL | fr | --- | 0% | +100% | +100% | 0.0 0.0 |
| I7 | GL | fr | --- | 0% | +100% | +100% | 0.0 0.0 |
| EI | GL | fr | --- | 0% | +100% | +100% | 0.0 0.0 |
| «Normal » | | | | | | | |
| ▼ TYP SEL /_ Offset - travel + -time+ | | | | | | | |

Now use the selection keys of the left or right touch pad to select the desired input out of the list if the respective plug-in location on the transmitter board is occupied or switch the entry to "fr" if the input is to be decoupled from a transmitter control. In this case, or even when a non-existent transmitter control is assigned, the servo corresponding to this input will be in its neutral position and can only be controlled via mixers.

| | | | | | | | |
|---------------------------------------|----|-----|-----|----|-------|-------|---------|
| ▶ I5 | GL | S11 | --- | 0% | +100% | +100% | 0.0 0.0 |
| I6 | GL | fr | --- | 0% | +100% | +100% | 0.0 0.0 |
| I7 | GL | fr | --- | 0% | +100% | +100% | 0.0 0.0 |
| EI | GL | fr | --- | 0% | +100% | +100% | 0.0 0.0 |
| «Normal » | | | | | | | |
| ▼ TYP SEL /_ Offset - travel + -time+ | | | | | | | |

Switch assignment

If the input is to be actuated like a switch module, the input can alternatively be assigned to a switch.

A simple switch can be used to switch back and forth between two limit values, for example motor On/Off.

A 2-way momentary or toggle switch, see appendix, achieves the same effect as a 2-channel switch module, for example motor Off/Half/Full.

Use the selection keys to move into the column above the /_ switch symbol label. Briefly tap the center **SET** key of the right touch pad to activate the option for assigning a switch.

| | | | | | | | |
|---------------------------------------|----|----|----------------------|----|-------|-------|---------|
| ▶ I5 | GL | fr | --- | 0% | +100% | +100% | 0.0 0.0 |
| I6 | GL | f | Move desired switch | 0% | 0.0 | 0.0 | 0.0 |
| I7 | GL | f | to ON position | 0% | 0.0 | 0.0 | 0.0 |
| I8 | GL | f | (ext. switch: ENTER) | 0% | 0.0 | 0.0 | 0.0 |
| «Normal » | | | | | | | |
| ▼ TYP SEL /_ Offset - travel + -time+ | | | | | | | |

Actuate the desired toggle switch from its "OFF" to its "ON" position or, for a 3-way switch, beginning from its middle position, assign a switch direction—preferably the "second" direction. This means, if a function is to be switched on by moving the switch forward two positions, i.e. away from the pilot, then begin from the switch's middle position and move the switch away from the pilot.

The display will then present the switch number together with a symbol indicating the given switch direction. At the same time, the column label in the footer line will change from **SEL** into another switch symbol.

| | | | | | | | |
|--------------------------------------|----|-----|-----|----|-------|-------|---------|
| ▶I5 | GL | --- | 7 | 0% | +100% | +100% | 0.0 0.0 |
| I6 | GL | fr | --- | 0% | +100% | +100% | 0.0 0.0 |
| I7 | GL | fr | --- | 0% | +100% | +100% | 0.0 0.0 |
| I8 | GL | fr | --- | 0% | +100% | +100% | 0.0 0.0 |
| «Normal » | | | | | | | |
| ▼ TYP /- /- Offset - travel + -time+ | | | | | | | |

Now put the 3-way switch back into its middle position. Move the marker frame as necessary to the left into the column labeled with the new switch symbol, briefly tap on the center **SET** key of the right touch pad then assign the switch's other switch direction by once again starting from the middle position but this time move the switch in the other direction.

The display will now present the given switch number together with a symbol indicating the given switch direction.

| | | | | | | | |
|--------------------------------------|----|----|-----|----|-------|-------|---------|
| ▶I5 | GL | 8 | 7 | 0% | +100% | +100% | 0.0 0.0 |
| I6 | GL | fr | --- | 0% | +100% | +100% | 0.0 0.0 |
| I7 | GL | fr | --- | 0% | +100% | +100% | 0.0 0.0 |
| I8 | GL | fr | --- | 0% | +100% | +100% | 0.0 0.0 |
| «Normal » | | | | | | | |
| ▼ TYP /- /- Offset - travel + -time+ | | | | | | | |

Erasing a transmitter control or switch assignment

A simultaneous tap on the ▲▼ or ◀▶ keys of the right touch pad (**CLEAR**) while on an input line with an active transmitter control or switch assignment—see above figures—will reset the given input back to "fr" and "---".

Tips:

- When assigning switches, pay attention to the desired switching direction and also that all

unused inputs remain "free" or are again reset to "free". This is necessary to ensure that inadvertent actuations of these unused controls cannot cause malfunctions.

- The travel setting described below allows the appropriate end state to be established for an assigned switch.

Column 4, "Offset"

The control center for the given control, i.e. its zero point, can be changed in this column. The adjustment range lies between -125% and +125%.

| | | | | | | | |
|--------------------------------------|----|----|-----|----|-------|-------|---------|
| ▶I5 | GL | 8 | 7 | 0% | +100% | +100% | 0.0 0.0 |
| I6 | GL | fr | --- | 0% | +100% | +100% | 0.0 0.0 |
| I7 | GL | fr | --- | 0% | +100% | +100% | 0.0 0.0 |
| I8 | GL | fr | --- | 0% | +100% | +100% | 0.0 0.0 |
| «Normal » | | | | | | | |
| ▼ TYP /- /- Offset - travel + -time+ | | | | | | | |

A simultaneous tap on the ▲▼ or ◀▶ keys of the right touch pad (**CLEAR**) will reset the entry field value displayed in inverse video back to "0%".

Column 5, "- travel +"

This column is used to set servo travel symmetrically or asymmetrically for each side. The setting range is ±125% of normal servo travel.

Select an input, 5 through 16, with the ▲▼ selection keys of the left or right touch pad.

To set *symmetric* travel, i.e. control-side independent travel, the respective operating element (transmitter control or switch) is to be put into a position in which the travel setting will be covered on both sides by the marker frame.

| | | | | | | | |
|-----------------------------------|----|----|-----|----|-------|-------|---------|
| ▶E5 | GL | 8 | 7 | 0% | +100% | +100% | 0.0 0.0 |
| E6 | GL | fr | --- | 0% | +100% | +100% | 0.0 0.0 |
| E7 | GL | fr | --- | 0% | +100% | +100% | 0.0 0.0 |
| E8 | GL | fr | --- | 0% | +100% | +100% | 0.0 0.0 |
| «Normal » | | | | | | | |
| ▼ Typ /- /- Offset - Weg + -Zeit+ | | | | | | | |

To set *asymmetric* travel, the respective operating element (transmitter control or switch) is to be moved to the side to be set such that the marker frame only includes the value to be changed.

| | | | | | | | |
|--------------------------------------|----|----|-----|----|-------|-------|---------|
| ▶I5 | GL | 8 | 7 | 0% | +100% | +100% | 0.0 0.0 |
| I6 | GL | fr | --- | 0% | +100% | +100% | 0.0 0.0 |
| I7 | GL | fr | --- | 0% | +100% | +100% | 0.0 0.0 |
| I8 | GL | fr | --- | 0% | +100% | +100% | 0.0 0.0 |
| «Normal » | | | | | | | |
| ▼ TYP /- /- Offset - travel + -time+ | | | | | | | |

The value setting is activated by briefly touching the center **SET** key of the right touch pad. The value field/s will be displayed in inverse video. Values can be changed with the selection keys of the right touch pad.

| | | | | | | | |
|--------------------------------------|----|----|-----|----|-------|-------|---------|
| ▶I5 | GL | 8 | 7 | 0% | +111% | +111% | 0.0 0.0 |
| I6 | GL | fr | --- | 0% | +100% | +100% | 0.0 0.0 |
| I7 | GL | fr | --- | 0% | +100% | +100% | 0.0 0.0 |
| I8 | GL | fr | --- | 0% | +100% | +100% | 0.0 0.0 |
| «Normal » | | | | | | | |
| ▼ TYP /- /- Offset - travel + -time+ | | | | | | | |

| | | | | | | |
|--------------------------------------|----|---------|----|-------|-------|---------|
| ▶15 | GL | 8 ▣ 7 ▣ | 0% | +100% | +88% | 0.0 0.0 |
| 16 | GL | fr --- | 0% | +100% | +100% | 0.0 0.0 |
| 17 | GL | fr --- | 0% | +100% | +100% | 0.0 0.0 |
| 18 | GL | fr --- | 0% | +100% | +100% | 0.0 0.0 |
| «Normal » | | | | | | |
| ▼ TYP /_ /_ Offset - travel + -time+ | | | | | | |

Another brief tap on the center **SET** key of the right touch pad will complete the entry. Negative and positive parameter values are possible in order to appropriately adapt the control's direction or effect.

A simultaneous tap on the ▲▼ or ◀▶ keys of the right touch pad (**CLEAR**) will reset the changed parameter displayed in inverse video back to "+100%".

Important:

In contrast to servo travel settings, changing the control travel setting affects all "downstream" mixer and coupling inputs, i.e. any and all servos actuated by the given transmitter control.

Column 6, "-time+"

Each of the function inputs 5 ... 16 can be assigned a symmetrical or asymmetric time delay of between 0 and 9.9 s.

Move the marker frame to the right beyond the column labeled "- travel +" with the ▶ selection key of the left or right touch pad.

To set a *symmetric*, i.e. control-side independent, time delay, the respective operating element (transmitter control or switch) is to be put into a position in which the time setting is covered on both sides by the marker frame.

| | | | | | | |
|--------------------------------------|----|---------|----|-------|-------|---------|
| ▶15 | GL | 8 ▣ 7 ▣ | 0% | +111% | +111% | 0.0 0.0 |
| 16 | GL | fr --- | 0% | +100% | +100% | 0.0 0.0 |
| 17 | GL | fr --- | 0% | +100% | +100% | 0.0 0.0 |
| 18 | GL | fr --- | 0% | +100% | +100% | 0.0 0.0 |
| «Normal » | | | | | | |
| ▼ TYP /_ /_ Offset - travel + -time+ | | | | | | |

To set an *asymmetric* time delay, move the given transmitter control (proportional control or switch) as necessary to the side to be set such that only the value to be changed is covered.

| | | | | | | |
|--------------------------------------|----|---------|----|-------|-------|---------|
| ▶15 | GL | 8 ▣ 7 ▣ | 0% | +111% | +111% | 0.0 0.0 |
| 16 | GL | fr --- | 0% | +100% | +100% | 0.0 0.0 |
| 17 | GL | fr --- | 0% | +100% | +100% | 0.0 0.0 |
| 18 | GL | fr --- | 0% | +100% | +100% | 0.0 0.0 |
| «Normal » | | | | | | |
| ▼ TYP /_ /_ Offset - travel + -time+ | | | | | | |

Briefly tap the center **SET** key of the right touch pad to activate value setting. The value field will be displayed in inverse video. Use the selection keys of the right touch pad to change the value in a range of 0.0 to 9.9 s.

Another brief tap on the center **SET** key of the right touch pad will complete the entry.

A simultaneous tap on the ▲▼ or ◀▶ keys of the right touch pad (**CLEAR**) will reset the changed parameter displayed in inverse video back to 0.0.

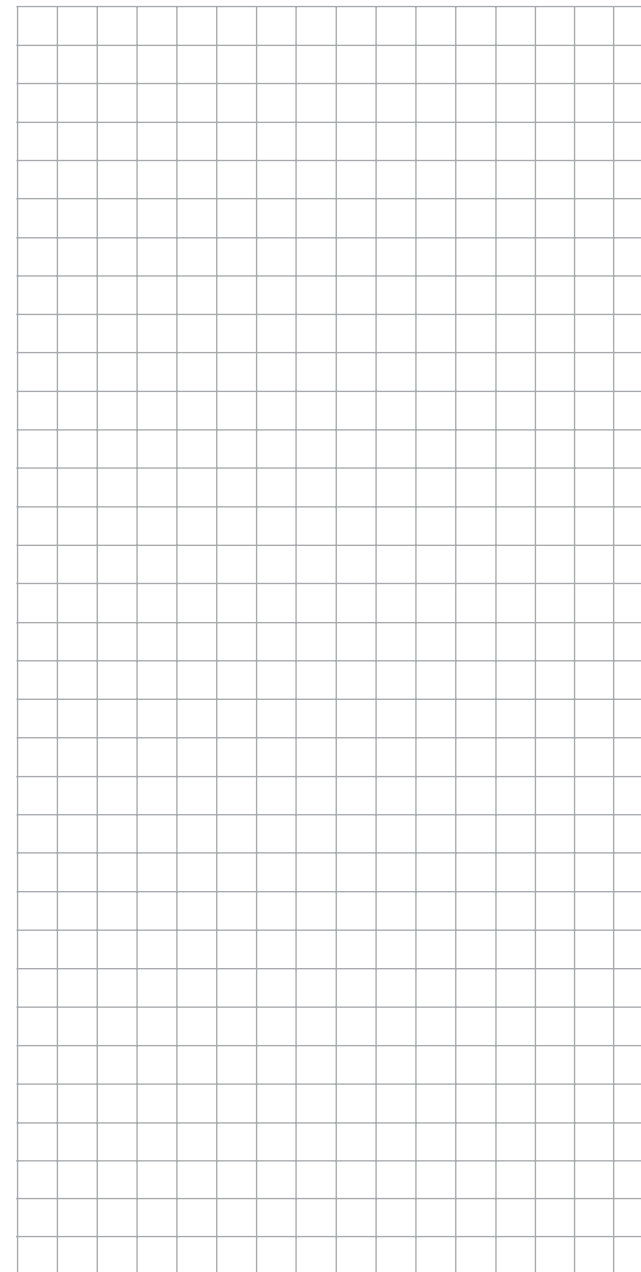

Control adjust

Basic procedure for transmitter control and switch assignment

Use the selection keys on the left or right touch pad to scroll to the »**Control adjust**« option in the multi-function menu:

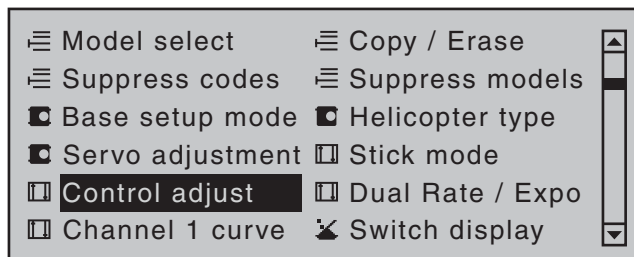

Tap briefly on the center **SET** key of the right touch pad to open this menu option:

| | | | | | | | |
|------|-----|-----|-----|--------|----------|-------|---------|
| ► I5 | GL | fr | --- | 0% | +100% | +100% | 0.0 0.0 |
| Thr6 | GL | fr | --- | 0% | +100% | +100% | 0.0 0.0 |
| Gyr7 | GL | fr | --- | 0% | +100% | +100% | 0.0 0.0 |
| I8 | GL | fr | --- | 0% | +100% | +100% | 0.0 0.0 |
| ⋮ | ⋮ | ⋮ | ⋮ | ⋮ | ⋮ | ⋮ | ⋮ |
| I15 | GL | fr | --- | 0% | +100% | +100% | 0.0 0.0 |
| Tl16 | GL | Lv1 | --- | 0% | +100% | +100% | 0.0 0.0 |
| ▼ | TYP | SEL | ↙ | Offset | - travel | + | -time+ |

In addition to the two joysticks for control functions 1 to 4 and their trim wheels, the **MC-20** HoTT transmitter also has other controls as standard equipment:

- two 3-way switches
- two 2-way switches
- two unlockable 2-way switches
- two self-restoring 2-way switches
- three proportional sliders on the middle console, designated SR 1 ... 3 in the menu
- two side-mounted "rotary sliders", designated SD1 and 2 in the menu

- two depressible "rotary controls", designated DG2 and 4 in the menu
- three roller-shaped rotary controls, designated as DG1, DG3 and DG5 in the menu

In contrast to the two joysticks which, even for a newly initialized "Helicopter" model type will automatically use the servos attached to receiver outputs 1 ... 4 and 6, the aforementioned "other" operating elements—except for the standard assignment of servo 6 to the right-side proportional slider, designated in this menu as SD1 (throttle limiter)—are initially inactive.

One of the effects of this is that (as already mentioned on page 68) with a factory-fresh system—as with a newly initialized model memory for a "Helicopter" model type following its "binding" to the intended receiver—only those servos connected to receiver outputs 1 ... 4 and—depending on the position of the throttle limiter—servo 6 can be moved by the two joysticks. Any servos connected to plug-in locations 5 and 7 through 15, on the other hand, will simply remain at their center positions.

While this may appear a bit awkward at first glance ... this is the only way to ensure a completely free selection from among "additional" operating elements while, at the same time, not requiring the "deactivation" of unused operating elements. This is because

the only way to ensure an unused operating element can have no effect on the model, even if operated by accident, is to make it inactive, i.e. not assigned to any function.

All of the aforementioned operating elements can be freely assigned in this »**Control adjust**« menu, see page 54, to any function input just to accommodate personal requirements. Equally, this also means that each of these operating elements can also be assigned to multiple functions at the same time,

as needed. For example: the exact same toggle switch assigned to an input in this menu can, at the same time, also have an assignment in the »**Timers (general)**« menu as an "On/Off" switch, etc.

Furthermore, *all* inputs can be selectively set to *global* or *flight-phase specific* operation if they have been defined for flight-phases in the »**Phase settings**« menu, page 142, and »**Phase assignment**« menu, page 148. The names assigned to given flight phases then appear in the second-from-the-bottom display line, e.g. «Normal».

Note:

As a rule, input 6 must kept "free" for a helicopter model. On this, see "Throttle" on the next double page.

Basic procedure

1. Use the ▲▼ selection keys of the left or right touch pad to select the desired input: I5, Thr6, Gyr7, I8 ... 15 or Tl16.
2. If necessary, use the ◀▶ selection keys of the left or right touch pad to select the desired column.
3. Briefly tap the center **SET** key of the right touch pad. The corresponding input field is shown highlighted.
4. Operate the chosen operating element or set the desired value with the selection keys of the right touch pad.
5. Briefly tap the center **SET** key of the right touch pad to complete data entry.
6. A simultaneous tap on the ▲▼ or ◀▶ keys of the right touch pad (**CLEAR**) will any setting made back to its respective default value.

Column 2, "typ"

Similar to the previously described »Stick mode« menu, this column can be used to define whether further settings for the given input are to have a "GL(lobal)" or a "PH(ase-specific)" effect. Do this by using the selection keys of the left or right touch pad to select the desired input 5 through 16 in the column labeled "TYP".

| | | | | | | | |
|--|----|----|-----|----|-------|-------|---------|
| ►I5 | GL | fr | --- | 0% | +100% | +100% | 0.0 0.0 |
| Thr6 | GL | fr | --- | 0% | +100% | +100% | 0.0 0.0 |
| Gyr7 | GL | fr | --- | 0% | +100% | +100% | 0.0 0.0 |
| E8 | GL | fr | --- | 0% | +100% | +100% | 0.0 0.0 |
| «Normal » | | | | | | | |
| ▼ TYP SEL  Offset - travel + -time+ | | | | | | | |

"GL": The settings for the input in question affect all flight phases programmed (if any) and thus act "globally" on the model memory in question.

"PH": The settings for this input take effect per flight phase and must therefore be configured separately for each flight phase.

Note:

See page 142 for more information about flight phases.

Column 3, "Transmitter control/switch assignment"

Using the ▲▼ selection keys of the left or right touch pad to select an input: I5, Thr6, Gyr7, I8 ... 15 or TI16.

Transmitter control assignment

Use the selection keys to move into the column labeled **SEL**. After completing the activation of transmitter control assignment by tapping the center **SET** key of the right touch pad, the message shown below will appear in the display:

| | | | | | | | |
|--|----|----|-----|----|-------|-------|---------|
| ►I5 | GL | fr | --- | 0% | +100% | +100% | 0.0 0.0 |
| Thr6 | GL | fr | --- | 0% | +100% | +100% | 0.0 0.0 |
| Gyr7 | GL | fr | --- | 0% | +100% | +100% | 0.0 0.0 |
| I8 | GL | fr | --- | 0% | +100% | +100% | 0.0 0.0 |
| «Normal » | | | | | | | |
| ▼ TYP SEL  Offset - travel + -time+ | | | | | | | |

Now actuate the desired transmitter control: The notice window will disappear and the designation of the selected transmitter control will appear in the transmitter control assignment window.

| | | | | | | | |
|--|----|-----|-----|----|-------|-------|---------|
| ►I5 | GL | S11 | --- | 0% | +100% | +100% | 0.0 0.0 |
| Thr6 | GL | fr | --- | 0% | +100% | +100% | 0.0 0.0 |
| Gyr7 | GL | fr | --- | 0% | +100% | +100% | 0.0 0.0 |
| E8 | GL | fr | --- | 0% | +100% | +100% | 0.0 0.0 |
| «Normal » | | | | | | | |
| ▼ TYP SEL  Offset - travel + -time+ | | | | | | | |

Alternatively, the center **SET** key of the right touch pad can be tapped for a second time while the notice window, see above, is still on the display:

| | | | | | | | |
|--|----|----|-----|----|-------|-------|---------|
| ►I5 | GL | fr | --- | 0% | +100% | +100% | 0.0 0.0 |
| Thr6 | GL | fr | --- | 0% | +100% | +100% | 0.0 0.0 |
| Gyr7 | GL | fr | --- | 0% | +100% | +100% | 0.0 0.0 |
| E8 | GL | fr | --- | 0% | +100% | +100% | 0.0 0.0 |
| «Normal » | | | | | | | |
| ▼ TYP SEL  Offset - travel + -time+ | | | | | | | |

Now use the selection keys of the left or right touch pad to select the desired input out of the list if the respective plug-in location on the transmitter board is occupied or switch the entry to "fr" if the input is to be decoupled from a transmitter control. In this case, or even when a non-existent transmitter control is assigned, the servo corresponding to this input will be

in its neutral position and can only be controlled via mixers.

| | | | | | | | |
|--|----|-----|-----|----|-------|-------|---------|
| ►I5 | GL | S11 | --- | 0% | +100% | +100% | 0.0 0.0 |
| Thr6 | GL | fr | --- | 0% | +100% | +100% | 0.0 0.0 |
| Gyr7 | GL | fr | --- | 0% | +100% | +100% | 0.0 0.0 |
| E8 | GL | fr | --- | 0% | +100% | +100% | 0.0 0.0 |
| «Normal » | | | | | | | |
| ▼ TYP SEL  Offset - travel + -time+ | | | | | | | |

Switch assignment

If the input is to be actuated like a switch module, the input can alternatively be assigned to a switch.

A simple switch can be used to switch back and forth between two limit values, for example motor On/Off.

A 2-way momentary or toggle switch, see appendix, achieves the same effect as a 2-channel switch module, for example motor Off/Half/Full.

Use the selection keys to move into the column above the  switch symbol label. Briefly tap the center **SET** key of the right touch pad to activate the option for assigning a switch.

| | | | | | | | |
|--|----|----|-----|----|-------|-------|---------|
| ►I5 | GL | fr | --- | 0% | +100% | +100% | 0.0 0.0 |
| Thr6 | GL | f | --- | 0% | +100% | +100% | 0.0 0.0 |
| Gyr7 | GL | f | --- | 0% | +100% | +100% | 0.0 0.0 |
| I8 | GL | f | --- | 0% | +100% | +100% | 0.0 0.0 |
| «Normal » | | | | | | | |
| ▼ TYP SEL  Offset - travel + -time+ | | | | | | | |

Actuate the desired toggle switch from its "OFF" to its "ON" position or, for a 3-way switch, *beginning from its middle position*, assign a switch direction—preferably the "second" direction. This means, if a function is to be switched on by moving the switch forward two positions, i.e. away from the pilot, then begin from the switch's middle position and move the switch away from the pilot.

The display will then present the switch number together with a symbol indicating the given switch direction. At the same time, the column label in the footer line will change from **SEL** into another switch symbol.

| | | | | | | | |
|--------------------------------------|----|-----|-----|----|-------|-------|---------|
| ►I5 | GL | --- | 7 | 0% | +100% | +100% | 0.0 0.0 |
| Thr6 | GL | fr | --- | 0% | +100% | +100% | 0.0 0.0 |
| Gyr7 | GL | fr | --- | 0% | +100% | +100% | 0.0 0.0 |
| I8 | GL | fr | --- | 0% | +100% | +100% | 0.0 0.0 |
| «Normal » | | | | | | | |
| ▼ TYP /_ /_ Offset - travel + -time+ | | | | | | | |

Now put the 3-way switch back into its middle position. Move the marker frame as necessary to the left into the column labeled with the new switch symbol, briefly tap on the center **SET** key of the right touch pad then assign the switch's other switch direction by once again starting from the middle position but this time move the switch in the other direction.

The display will now present the given switch number together with a symbol indicating the given switch direction.

| | | | | | | | |
|--------------------------------------|----|----|-----|----|-------|-------|---------|
| ►I5 | GL | 8 | 7 | 0% | +100% | +100% | 0.0 0.0 |
| Thr6 | GL | fr | --- | 0% | +100% | +100% | 0.0 0.0 |
| Gyr7 | GL | fr | --- | 0% | +100% | +100% | 0.0 0.0 |
| I8 | GL | fr | --- | 0% | +100% | +100% | 0.0 0.0 |
| «Normal » | | | | | | | |
| ▼ TYP /_ /_ Offset - travel + -time+ | | | | | | | |

A simultaneous tap on the ▲▼ or ◀▶ keys of the right touch pad (**CLEAR**) while on an input line with an active transmitter switch assignment—see above figure—will reset the input back to "fr" and "---".

Tips:

- When assigning switches, pay attention to the desired switching direction and also that all unused inputs remain "free" or are again reset to "free". This is necessary to ensure that inadvertent actuations of these unused controls cannot cause malfunctions.
- The travel setting described below allows the appropriate end state to be established for an assigned switch.

Column 4, "offset"

The control center for the given control, i.e. its zero point, can be changed in this column. The adjustment range lies between -125% and +125%.

| | | | | | | | |
|--------------------------------------|----|----|-----|----|-------|-------|---------|
| ►I5 | GL | 8 | 7 | 0% | +100% | +100% | 0.0 0.0 |
| Thr6 | GL | fr | --- | 0% | +100% | +100% | 0.0 0.0 |
| Gyr7 | GL | fr | --- | 0% | +100% | +100% | 0.0 0.0 |
| I8 | GL | fr | --- | 0% | +100% | +100% | 0.0 0.0 |
| «Normal » | | | | | | | |
| ▼ TYP /_ /_ Offset - travel + -time+ | | | | | | | |

A simultaneous tap on the ▲▼ or ◀▶ keys of the right touch pad (**CLEAR**) will reset the entry field value displayed in inverse video back to "0%".

Column 5, "-travel+"

This column is used to set servo travel symmetrically or asymmetrically for each side. The setting range is ±125% of normal servo travel.

Use the ▲▼ selection keys of the left or right touch pad to select an input: I5, Thr6, Gyr7, I8 ... 15 or TI16.

To set *symmetric* travel, i.e. control-side independent, put the respective operating element (proportional control or switch) into a position where the marker frame encloses both sides of the travel setting.

| | | | | | | | |
|--------------------------------------|----|----|-----|----|-------|-------|---------|
| ►I5 | GL | 8 | 7 | 0% | +111% | +88% | 0.0 0.0 |
| Thr6 | GL | fr | --- | 0% | +100% | +100% | 0.0 0.0 |
| Gyr7 | GL | fr | --- | 0% | +100% | +100% | 0.0 0.0 |
| I8 | GL | fr | --- | 0% | +100% | +100% | 0.0 0.0 |
| «Normal » | | | | | | | |
| ▼ TYP /_ /_ Offset - travel + -time+ | | | | | | | |

To set *asymmetric* travel, the respective control (proportional control or switch) is to be moved to the side to be set such that the marker frame only encloses the value to be changed.

| | | | | | | | |
|--------------------------------------|----|----|-----|----|-------|-------|---------|
| ►I5 | GL | 8 | 7 | 0% | +111% | +100% | 0.0 0.0 |
| Thr6 | GL | fr | --- | 0% | +100% | +100% | 0.0 0.0 |
| Gyr7 | GL | fr | --- | 0% | +100% | +100% | 0.0 0.0 |
| I8 | GL | fr | --- | 0% | +100% | +100% | 0.0 0.0 |
| «Normal » | | | | | | | |
| ▼ TYP /_ /_ Offset - travel + -time+ | | | | | | | |

Briefly tap the center **SET** key of the right touch pad to activate value setting. The value field is shown highlighted. Values can be changed with the selection keys of the right touch pad.

| | | | | | | | |
|--------------------------------------|----|----|-----|----|-------|-------|---------|
| ►I5 | GL | 8 | 7 | 0% | +111% | +111% | 0.0 0.0 |
| Thr6 | GL | fr | --- | 0% | +100% | +100% | 0.0 0.0 |
| Gyr7 | GL | fr | --- | 0% | +100% | +100% | 0.0 0.0 |
| I8 | GL | fr | --- | 0% | +100% | +100% | 0.0 0.0 |
| «Normal » | | | | | | | |
| ▼ TYP /_ /_ Offset - travel + -time+ | | | | | | | |

| | | | | | | |
|------------------------------------|----|---------|----|-------|-------|---------|
| ► I5 | GL | 8 ▣ 7 ▣ | 0% | +100% | +88% | 0.0 0.0 |
| Thr6 | GL | fr --- | 0% | +100% | +100% | 0.0 0.0 |
| Gyr7 | GL | fr --- | 0% | +100% | +100% | 0.0 0.0 |
| I8 | GL | fr --- | 0% | +100% | +100% | 0.0 0.0 |
| «Normal » | | | | | | |
| ▼ TYP ▽ ▽ Offset - travel + -time+ | | | | | | |

Another brief tap on the center **SET** key of the right touch pad will complete the entry. Negative and positive parameter values are possible in order to appropriately adapt the control's direction or effect.

A simultaneous tap on the ▲▼ or ◀▶ keys of the right touch pad (**CLEAR**) will reset the changed parameter displayed in inverse video back to "+100%".

Important:

In contrast to altering servo travel, changing the control travel setting affects all "downstream" mixer and coupling inputs, i.e. any and all servos that could be actuated by the transmitter controls concerned.

Column 6, "- time +"

Each of the function inputs, I5 ... I6, can be assigned a symmetric or asymmetric time delay of between 0 and 9.9 s.

Move the marker frame to the right beyond the column labeled "- travel +" with the ► selection key of the left or right touch pad.

To set a *symmetric* time delay, i.e. control-side independent, move the affected transmitter control (proportional control or switch) as necessary to a position such that the marker frame encloses both sides of the time setting.

| | | | | | | |
|------------------------------------|----|---------|----|-------|-------|---------|
| ► I5 | GL | 8 ▣ 7 ▣ | 0% | +111% | +111% | 0.0 0.0 |
| Thr6 | GL | fr --- | 0% | +100% | +100% | 0.0 0.0 |
| Gyr7 | GL | fr --- | 0% | +100% | +100% | 0.0 0.0 |
| I8 | GL | fr --- | 0% | +100% | +100% | 0.0 0.0 |
| «Normal » | | | | | | |
| ▼ TYP ▽ ▽ Offset - travel + -time+ | | | | | | |

To set an *asymmetric* time delay, move the affected operating element (transmitter control or switch) as necessary to a position such that the marker frame encloses only the value to be changed.

| | | | | | | |
|------------------------------------|----|---------|----|-------|-------|---------|
| ► I5 | GL | 8 ▣ 7 ▣ | 0% | +111% | +111% | 0.0 0.0 |
| Thr6 | GL | fr --- | 0% | +100% | +100% | 0.0 0.0 |
| Gyr7 | GL | fr --- | 0% | +100% | +100% | 0.0 0.0 |
| I8 | GL | fr --- | 0% | +100% | +100% | 0.0 0.0 |
| «Normal » | | | | | | |
| ▼ TYP ▽ ▽ Offset - travel + -time+ | | | | | | |

Briefly tap the center **SET** key of the right touch pad to activate value setting. The value field is shown highlighted. Values can be changed with the selection keys of the right touch pad.

Another brief tap on the center **SET** key of the right touch pad will complete the entry.

A simultaneous tap on the ▲▼ or ◀▶ keys of the right touch pad (**CLEAR**) will reset the changed parameter displayed in inverse video back to 0.0.

Thr6

| | | | | | | |
|------------------------------------|----|---------|----|-------|-------|---------|
| I5 | GL | 8 ▣ 7 ▣ | 0% | +111% | +88% | 0.0 0.0 |
| ► Thr6 | GL | fr --- | 0% | +100% | +100% | 0.0 0.0 |
| Gyr7 | GL | fr --- | 0% | +100% | +100% | 0.0 0.0 |
| I8 | GL | fr --- | 0% | +100% | +100% | 0.0 0.0 |
| «Normal » | | | | | | |
| ▼ TYP ▽ ▽ Offset - travel + -time+ | | | | | | |

In principle, the helicopter program also permits the individual inputs to be assigned to any existing transmitter control (proportional controls and switches).

However, please note here that some of the inputs available on this menu are already assigned to helicopter-specific functions, and therefore cannot be re-assigned in this way.

Nevertheless, the receiver layout on page 65 indicates that the throttle servo or the speed controller of an electrically-powered helicopter must be connected to receiver output "6", since control channel "6" is reserved for motor power regulation.

Unlike a fixed-wing model aircraft, the throttle servo or speed controller is not directly controlled by the joystick or other transmitter control but rather by a complex mixer system, see »Helicopter mixer« menu beginning page 176. Furthermore, the "Throttle limit function" described on the next page also influences this mixer system.

Assigning a transmitter control or switch on the "Throttle" line, or to its supplementary control signal, would unnecessarily "confuse" this complex mixer system. **For this reason the "Throttle" input MUST be left "free".**

"Gyr7"

| | | | | | | | | |
|------------|-----|----|-----|--------|----------|-------|-------|-----|
| I5 | GL | 8 | 7 | 0% | +111% | +88% | 0.0 | 0.0 |
| Thr6 | GL | fr | --- | 0% | +100% | +100% | 0.0 | 0.0 |
| ►Gyr7 | GL | fr | --- | 0% | +100% | +100% | 0.0 | 0.0 |
| I8 | GL | fr | --- | 0% | +100% | +100% | 0.0 | 0.0 |
| « Normal » | | | | | | | | |
| ▼ | TYP | ↘ | ↗ | Offset | - travel | + | -time | + |

Most of the latest gyro systems not only feature infinitely variable proportional gyro gain setting, but also offer a choice of two separate types of gain mode on the transmitter.

If the gyro in use also has this feature then this menu option provides the opportunity to specify both a "normal" gyro effect as well as a "heading-lock mode" in the "Offset" column within a range of ±125%. Such a specification can include a certain effect to fly normal, slow flights with maximum stability or the reduction of the gyro effect for fast circuit flights and aerobatics.

To proceed as described above, use flight phase switching to enter different settings on the "Gyro" line.

Important notice:

The value of this option is identical to the offset value set in the "Gyro offset" option of the »Helicopter mixer« menu, page 185. For this reason, any changes made always affect the other menu directly, and vice versa.

Beginning with these preset–static–flight phase-specific settings, a transmitter control assigned to the "Gyr7" line, for example one of the middle console sliders, can be used to vary the gyro effect around the respective "offset point". The center point of the control corresponds to the setting specified by the offset. If the transmitter control is moved from this center point in the direction of full travel, gyro gain increases proportionally; it diminishes when moved

in the opposite direction. This provides a fast and straightforward method of adjusting gyro effect even in flight – e.g. to suit changing weather conditions – or to test-fly optimal settings. Furthermore, the range of the gyro's effect within transmitter control travel in both directions can be restricted by software.

In this context, be sure to comply with the instructions accompanying the gyro, otherwise there is a risk the helicopter will be impossible to fly.

Adjusting the gyro sensor

To achieve the maximum possible level of stabilization for the helicopter with the gyro along the vertical axis, observe the following:

- The controls should have as little friction and "play" as possible.
- There should be no "spring" in the control linkage.
- Use a strong and – in particular – a fast servo.

When the gyro sensor detects a model rotation, the faster its response – a corresponding corrective change to tail rotor thrust – takes effect, the further the gyro gain adjuster can be moved without causing the tail of the model to start oscillating, and the better the model's stability about its vertical axis. If the response is slower, there is a risk that the model's tail will start to oscillate even at low gyro gain settings. Here, further reductions to gyro gain will need to be made – either by using the default value under "Gyro" or the associated transmitter control – to eliminate the oscillation.

If the model is flying forward at high speed or hovering in a powerful headwind, the net result of the stabilizing effect of the vertical fin combined with the gyro may also lead to an overreaction that once again manifests itself through tail oscillation. To achieve optimum gyro stabilization under all conditions, make use of the option to adapt gyro effect with one of the transmitter's proportional controls.

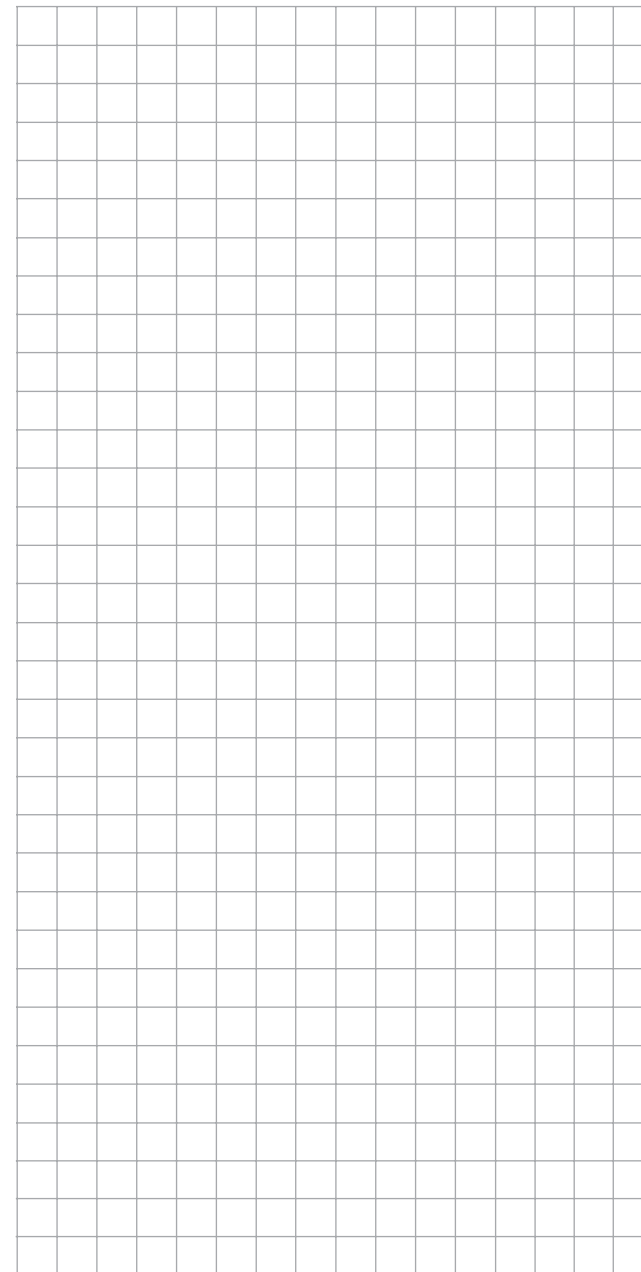

Throttle limit function

"TI16"

The proportional slider SD1, mounted on the right side of the transmitter, is assigned by default to input "TI16".

| | | | | | | | | | |
|---------------------------------------|----|-----|-----|----|-------|-------|-----|-----|-----|
| I13 | GL | fr | --- | 0% | +100% | +100% | 0.0 | 0.0 | 0.0 |
| I14 | GL | fr | --- | 0% | +100% | +100% | 0.0 | 0.0 | 0.0 |
| I15 | GL | fr | --- | 0% | +100% | +100% | 0.0 | 0.0 | 0.0 |
| ▶TI16 | GL | Lv1 | --- | 0% | +100% | +100% | 0.0 | 0.0 | 0.0 |
| «Normal » | | | | | | | | | |
| ▲ TYP SET ↘_ Offset - travel + -time+ | | | | | | | | | |

This pre-assignment makes it unnecessary to program the two flight phases as may be familiar from use of other remote control systems—one "with idle-up" and one "without idle-up"—because the **MC-20** HoTT program offers a much more flexible approach to fine-tuning and optimizing increases to system rotational speed below the hover point than the so-called "idle-up". If it is nevertheless preferable for the helicopter to be programmed "with idle-up", then deactivate the "throttle limit" function described below by setting input "TI16" to "fr".

Meaning and application of "throttle limit"

As already mentioned under "Throttle", and in contrast to fixed-wing models, the power output of a helicopter's drive system is not controlled directly with the C1 joystick, but only indirectly via the throttle curve settings in the »**Helicopter mixer**« menu or—if the model features a speed controller—via that mechanism.

Note:

Of course for different flight phases, flight phase programming can be used to set individual throttle curves.

Nevertheless, both methods of output control de facto result in the helicopter carburetor never approaching

anything near its idle speed under "normal" flight conditions, and that the motor can therefore neither be started or stopped cleanly without some other means of intervention.

The "throttle limit" feature resolves this problem elegantly by using a separate transmitter control—by default the SD1 proportional slider mounted on the right side of the transmitter—to *limit* the throttle servo or the output level of a speed controller. In this way, it is possible to "throttle back" with the throttle limit control, even as far as the idle setting, at which point the trim control for the throttle/pitch joystick takes over or directly shuts off an electric drive. Conversely, the throttle servo or speed controller can only open up to its full-throttle position if the throttle limit control has also released the full servo travel path.

The value set on the (right-hand) plus side of the "travel" column must therefore always be set high enough to ensure that the maximum setting of the throttle limit control never restricts the full-throttle position achievable with throttle curve settings—which typically means setting a value in the range +100% to 125%.

| | | | | | | | | | |
|---------------------------------------|----|-----|-----|----|-------|-------|-----|-----|-----|
| I13 | GL | fr | --- | 0% | +100% | +100% | 0.0 | 0.0 | 0.0 |
| I14 | GL | fr | --- | 0% | +100% | +100% | 0.0 | 0.0 | 0.0 |
| I15 | GL | fr | --- | 0% | +100% | +100% | 0.0 | 0.0 | 0.0 |
| ▶TI16 | GL | Lv1 | --- | 0% | +100% | +125% | 0.0 | 0.0 | 0.0 |
| «Normal » | | | | | | | | | |
| ▲ TYP SET ↘_ Offset - travel + -time+ | | | | | | | | | |

The value on the (left-hand) minus side of the "travel" column should be set so that the throttle limit control can safely cut off an electric drive or close a carburetor sufficiently to cut off a combustion motor in conjunction with –digital–C1 trim. Because of this, leave this value (initially) at +100%. Furthermore, this variable "limitation" of throttle travel

not only provides a convenient means to start and stop the motor but may also prove to be more than an insignificant safety improvement! For example, just imagine what could happen if, while carrying the helicopter to the take-off site with the motor running, the C1 joystick were to be inadvertently operated ... If the carburetor or speed controller is open too far when the transmitter is switched on, an audible warning will be sounded and the basic display will show the message:

Throttle
too
high!

Tip:

Take advantage of the »**Servo display**« to observe the influence of the throttle limit control. The »**Servo display**« screen can be reached from almost any menu position with a simultaneous tap on the ◀▶ selection keys of the left touch pad, Bear in mind that servo output 6 controls the throttle servo on the **MC-20** HoTT!

Basic idle setting

Put the throttle limit into its "full throttle" position by pushing the throttle limit regulator –by default, the right side proportional slider SD1—all the way to its forward position limit. Set the throttle/pitch joystick to the maximum pitch position and also check the sub-menu "Channel 1 CURVE" of the menu ...

»**Helicopter mixer**« (page 176 ... 191)

... to ensure that a standard throttle curve is active. If, for example, the standard throttle curve has already been changed following the initialization of a model memory then this must be at least temporarily reset to the values "Point L = -100%", "Point 1 = 0%" and "Point H = +100%":

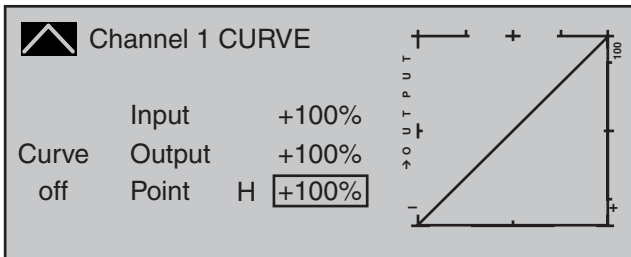

Note:

Since throttle trim has no effect if the throttle limiter is open, its position here is meaningless.

Now—without starting the combustion motor—adjust the throttle servo, preferably mechanically and, if necessary, also by way of the servo 6 travel adjustment option in the »**Servo adjustment**« menu, so that the carburetor is completely open.

Now close the throttle limiter completely by moving the side proportional slider all the way to its rear limit. Use the trim wheel of the Throttle/Pitch joystick to place the trim position marker into the motor OFF position or actuate the "Thr. CutOff" option, see page 90.

Note:

In contrast, when the throttle limiter is closed, the position of the throttle/collective pitch stick is meaningless. It can therefore remain at the maximum collective pitch position so that, when adjusting carburetor linkages, the throttle limiter alone can be used to switch between full throttle (throttle limiter open) and "Motor OFF" (throttle limiter closed).

Now, with the throttle limiter closed, adjust the carburetor linkages so that the carburetor is (just) completely closed. Take extreme care to ensure that the throttle servo does not become mechanically blocked in either of its end positions (full throttle/motor OFF).

To complete this basic configuration, the idle trim adjustment range must now be matched against point "L" on the throttle curve. Do this by setting Point "L" of the "Channel 1 CURVE" mixer, in the »**Helicopter mixer**« menu, to about -65% to -70%.

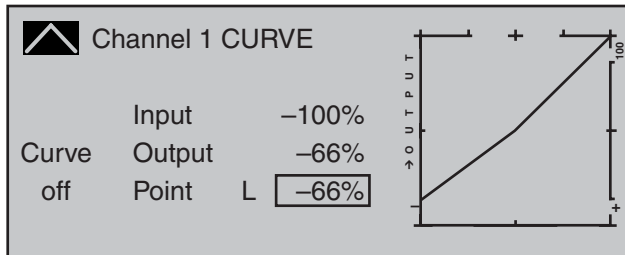

To configure a smooth transition from the idle trim to the throttle curve *exactly*, the collective pitch stick should be moved to and fro slightly at its minimum position with the throttle limiter closed and the idle trim fully open. The throttle servo must not move as well! Any further adjustments to the throttle curve must of course be made later in flight.

The motor is always started with the throttle limiter fully closed, whereby idle is set exclusively by using the trim wheel of the throttle/pitch joystick and the motor is shut off by the "Thr. CutOff" option.

Notes:

- Take advantage of the »**Servo display**« to observe the influence of the throttle limit control. The »**Servo display**« screen can be reached from almost any menu position with a simultaneous tap on the ◀ ▶ selection keys of the left touch pad, Bear in mind that servo output 6 controls the throttle servo on the **MC-20 HoTT!**
- A servo connected to output 16 can be used, independently of this, for other purposes by means of mixers, provided that this servo is decoupled from the operating element specified by function input 16 via the »**Mix only channel**« menu; see page 205.

- The throttle restriction set by the throttle limiter is shown as a horizontal bar in the throttle curve diagram on the second display page of the "Channel 1 CURVE" option in the »**Helicopter mixer**« menu (see page 180). The output signal for the throttle servo cannot be higher than the level set by the horizontal bar:

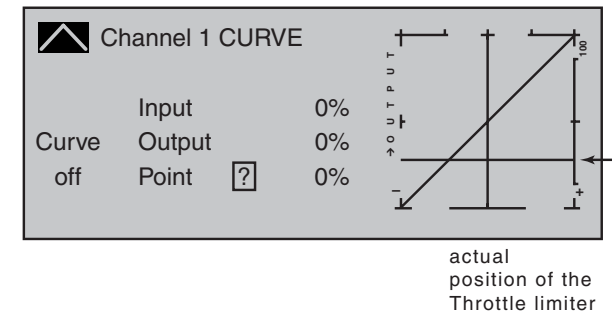

The above diagram shows precisely this scenario: in the above example, the throttle limit control is set to about -60% and thus restricts the movement of the throttle servo to about -60% of full travel.

Time delay for the throttle limiter

To safely prevent the carburetor from opening too rapidly, assign the throttle limiter input "Tl16" to a time delay that takes effect only in the direction of full throttle. This applies especially if the throttle limiter is controlled by a switch rather than, as preset, with the right-side proportional rotary slider.

To set a delay time, push the throttle limit control to its forward limit or move the switch into its full-throttle position then use the selection keys of the left or right touch pad to select the "-time+" column.

| | | | | | | | | |
|---------------------------------------|----|-----|-----|----|-------|-------|-----|-----|
| I13 | GL | fr | --- | 0% | +100% | +100% | 0.0 | 0.0 |
| I14 | GL | fr | --- | 0% | +100% | +100% | 0.0 | 0.0 |
| I15 | GL | fr | --- | 0% | +100% | +100% | 0.0 | 0.0 |
| ▶Tl16 | GL | Lv1 | --- | 0% | +100% | +100% | 0.0 | 0.0 |
| «Normal » | | | | | | | | |
| ▲ TYP SET ↘_ Offset - travel + -time+ | | | | | | | | |

After a brief tap on the center **SET** key of the right touch pad, the selection keys of the left or right touch pad can be used to select the desired time delay, e.g. 5 seconds.

| | | | | | | | | |
|---------------------------------------|----|-----|-----|----|-------|-------|-----|-----|
| I13 | GL | fr | --- | 0% | +100% | +100% | 0.0 | 0.0 |
| I14 | GL | fr | --- | 0% | +100% | +100% | 0.0 | 0.0 |
| I15 | GL | fr | --- | 0% | +100% | +100% | 0.0 | 0.0 |
| ▶Tl16 | GL | Lv1 | --- | 0% | +100% | +100% | 0.0 | 5.0 |
| «Normal » | | | | | | | | |
| ▲ TYP SET ↘_ Offset - travel + -time+ | | | | | | | | |

A brief tap on the center **SET** key of the right touch pad or the **ESC** key of the left touch pad will complete the entry.

Throttle limit in combination with "Thr AR" in the »Stick mode« menu

As already explained on page 106, when "Thr AR" is selected in the "Pitch/thr" line of the ...

»Stick mode« (page 106)

| | | | | |
|-------------|--------|----------|--------|------|
| ▶ Pitch/thr | Thr AR | 4 | 0.0s | 0.0s |
| Roll | global | 4 | 0.0s | 0.0s |
| Pitch ax | global | 4 | 0.0s | 0.0s |
| Tail rot. | global | 4 | 0.0s | 0.0s |
| | Trim | Tr. step | - time | + |

... menu then digital trim of the throttle/pitch joystick is only active for the «Autorotation» flight phase. As a consequence, the motor's idle speed cannot be regulated in the "normal" flight phases with the C1 trim control. To ensure the availability of sufficient setting options, use of the "Expo throttle limiter" is recommended.

The exponential curve characteristic offered by the ...

»Helicopter type« (page 98)

| | |
|---------------------|-------|
| H E L T Y P E | |
| Linearis. swashpl. | no |
| Rotor direction | right |
| Pitch min. | rear |
| ▶Expo throttle lim. | 0% |
| ▼ ▲ SEL | |

... menu's sub-menu can be used to alter the control behavior of the throttle limit control such that the latter provides sufficiently sensitive regulation of the idle setting and can also stop the motor.

In this case, with a completely closed throttle limiter—in contrast to the previously described setting— use the »Control adjust« menu set the "-" side of the column labeled "- travel +" for the "Tl16"

line such that the throttle limiter fully closes the carburetor, i.e. the motor is safely switched off at this control position.

Following this, move the throttle limit control to its center point and change the % value of the "Expo thro lim." line in the »Helicopter type« menu, page 98, until the carburetor is in a position suitable for starting the motor. Now start the motor, and adjust the value if necessary until the motor idles reliably in this throttle limit control position.

The value for the plus side of the "- travel +" column should be increased, as described before, to +125 % so that the full-throttle position of the throttle servo is also reliably released from the throttle limiter.

Finally, set an asymmetrical time delay of, say 4.0 seconds, so the motor also picks up speed gradually even if the side proportional slider is pushed forward too quickly. Select the time preset to correlate to how far the carburetor opens up at the minimum collective pitch position. The value set is to be optimized by testing.

Dual Rate / Expo

Configurable control characteristics for aileron, elevator and rudder

Use the selection keys of the left or right touch pad to scroll to the »Dual Rate / Expo« menu option in the Multi-function menu:

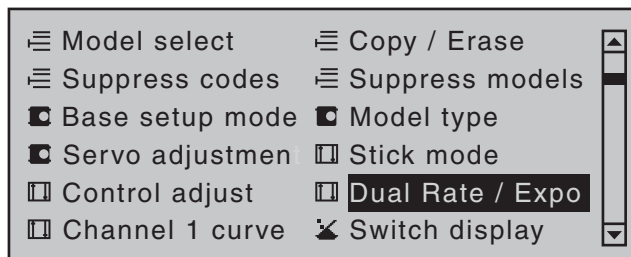

Open this menu option with a tap on the center **SET** key of the right touch pad.

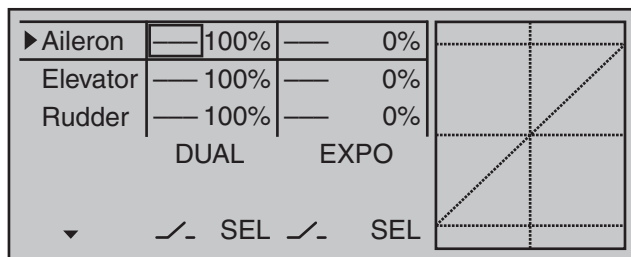

The *Dual-Rate-/Expo function* permits flight-phase dependent switching and control over the deflection and characteristics of the aileron (Ail), elevator (Ele) and rudder (Rud) (control functions 2 ... 4) by way of switches.

The »Channel 1 curve« menu, see text beginning page 128, can be used to set an individual curve characteristic for control function 1 (throttle/brake) with up to 8 separately programmable points.

Similar to control travel settings in the »Control adjust« menu, **Dual Rate** operates directly on the respective *control function*, independent of whether it is an individual servo or multiple servos connected via complex mixer and coupling functions.

The control travel for each switch position can be set to between 0 and 125 % of normal full travel.

Expo, on the other hand, enables finer-grained control of the model for values larger than 0 % around the center position of the primary control function (aileron, elevator and rudder), without forfeiting full movement at the end-points of joystick travel. For values less than 0 %, the reverse is true: control increases around the neutral position and diminishes towards the end-points. The degree of "progression" can therefore be set within a total range of -100 % to +100 %, where 0 % equates to the normal, linear control characteristics.

Rotary-output servos, now generally commonplace, offer another application. This is because the actual control surface movement is not linear: as the rotational angle of the output disc or lever increases, the control surface rate of travel over the control linkage continually decreases—depending on the position of the linkage point on the output disc. This effect can be counteracted with Expo values greater than 0 % such that rotational angle travel increases over-proportionally with increasing joystick throw.

The Expo setting also affects the relevant control function directly, whether this controls a single servo or multiple servos – via any number of mixer and coupling functions.

For both Dual Rate and Expo functions, switch assignment can be set up in any way desired, which therefore permits the triggering of multiple functions using one and the same switch. This, in turn, offers the opportunity to link the triggering of Dual Rate and Expo functions to a single switch: this offers many advantages – particularly for very high-speed models. The graphic screen displays the curve characteristics directly. After selecting the appropriate line, the dotted vertical line will follow the movement of the respective joystick so a better evaluation of the transmitter-control-travel dependent curve value can be made.

Flight phase-dependent Dual Rate and Expo settings

If flight phases are set up in the »Phase settings« and »Phase assignment« menus and each assigned a name, e.g. "Normal", the name in question will be displayed at the bottom left of the display. Just actuate the respective switch to switch between flight phases.

Basic procedure

1. Switch to the desired flight phase then use the ▲▼ selection keys of the left or right touch pad to select the desired line: "Aileron", "Elevator" or "Rudder".
2. Use the ◀▶ selection keys of the left or right touch pad to change into the column labeled "EXPO".
3. Tap the center **SET** key of the right touch pad. The corresponding input field is shown highlighted.
4. Use the selection keys of the right touch pad to set the desired value.
5. Tap the center **SET** key of the right touch pad to complete the entry.
6. A simultaneous tap on the ▲▼ or ◀▶ keys of the right touch pad (**CLEAR**) will any setting made back to its respective default value.

Dual Rate function

If a switchover between two variants is desired, assign a switch in the column labeled with the ⚡ switch symbol (as described in the section "Assigning transmitter controls, switches and control switches" on page 56).

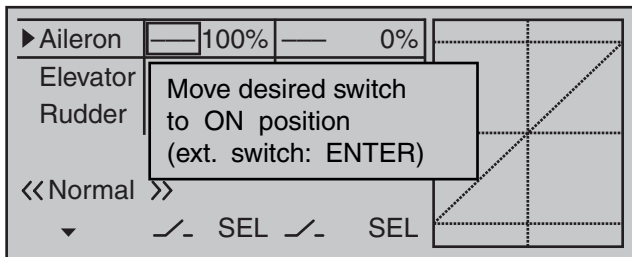

If necessary, this may also be one of the transmitter control switches C1 ... C8 or C1i ... C8i or one of the logical switches L1 ... L8 or L1i ... L8i from the list of "expanded switches".

The switch so assigned appears on the display, together with a switch icon that indicates the switch's switching direction.

In the case of "C" or "L" switches, the joystick or another transmitter control or a certain switching logic can itself be used as a switch. However, such a control switch must have been appropriately defined in the »**Control switch**« menu, see page 135, and a logical switch must have been appropriately defined in the »**Logical switch**« menu, see page 138.

Whichever switch has been assigned ... the respective switch will appear in the display together with a switch symbol indicating the switch's direction if actuated, e.g. in the «Normal» flight phase.

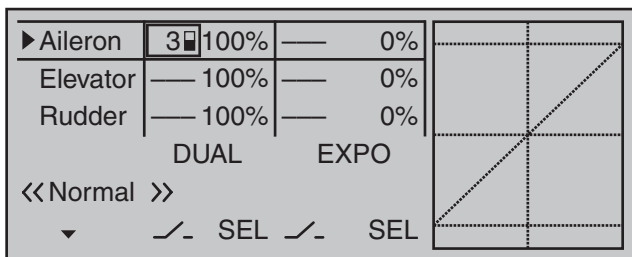

Once the value field has been activated with a brief tap on the **SET** key of the right touch pad, use the selection keys of the left or right touch pad to move into the Dual-Rate value column labeled **SEL** at the

bottom edge of the display in order to separately change the dual-rate values shown in inverse video for each of the two switch positions.

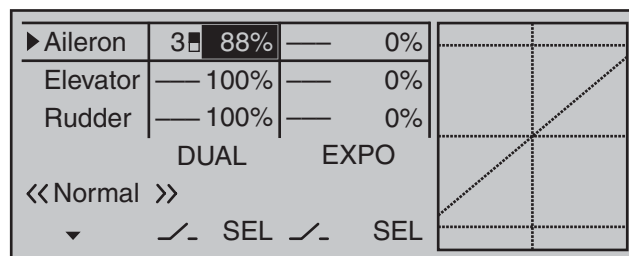
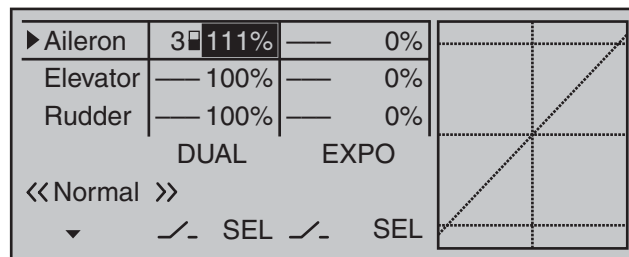

At the same time, the Dual-Rate curve will be presented in the graph. A simultaneous tap on the ▲▼ or ◀▶ keys of the right touch pad (**CLEAR**) will reset a changed entry field value displayed in inverse video back to "100 %".

Caution:

For safety reasons, Dual Rate value settings should not be less than 20 %.

Some examples of Dual Rate values:

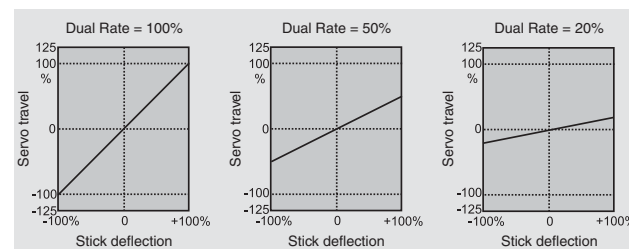

Exponential function

If a switchover between two variants is desired, assign a switch in the column labeled with the switch symbol (as described in the section "Assigning transmitter controls, switches and control switches" on page 56).

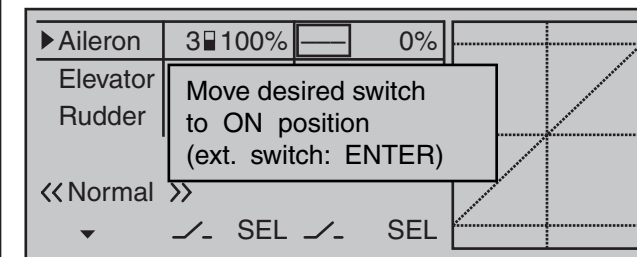

If necessary, this may also be one of the transmitter control switches C1 ... C8 or C1i ... C8i or one of the logical switches L1 ... L8 or L1i ... L8i from the list of "expanded switches".

The switch so assigned appears on the display, together with a switch icon that indicates the switch's switching direction.

In the case of "C" or "L" switches, the joystick or another transmitter control or a certain switching logic can itself be used as a switch. However, such a control switch must have been appropriately defined in the »**Control switch**« menu, see page 135, and a logical switch must have been appropriately defined in the »**Logical switch**« menu, see page 138.

Whichever switch has been assigned ... the respective switch appears on the display together with a switch symbol indicating the switch's respective direction when moved.

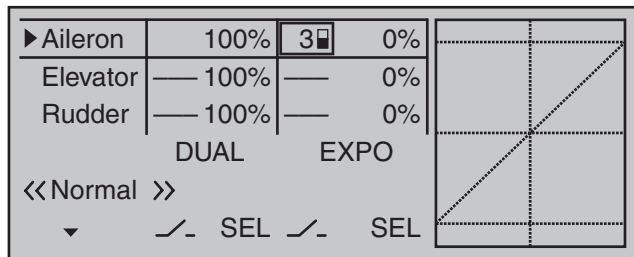

Select the right-hand column at the lower edge of the display marked with **SEL** and activate the value field with a brief tap on the center **SET** key of the right touch pad, the selection keys on the left or right touch pad can now be used to alter the Expo value shown in the highlighted field, separately for each of the two switch positions.

Now, for example, there is an opportunity to fly with a linear curve characteristic with the switch in one direction, and to preset a value other than 0% for the other switch direction:

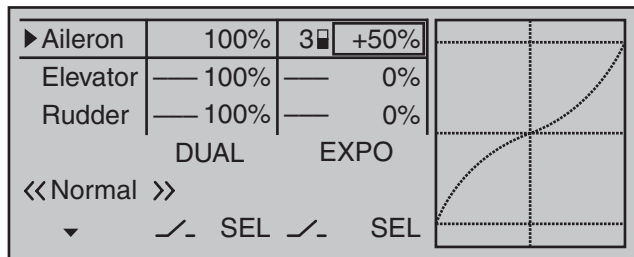

At the same time, the Expo curve will be presented in the graph. A simultaneous tap on the ▲▼ or ◀▶ keys of the right touch pad (**CLEAR**) will reset a changed entry field value displayed in inverse video back to "0%".

Some examples of Expo values:

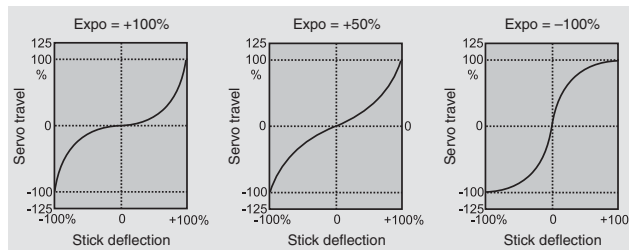

In each of these examples, the Dual Rate value equals 100%.

Combining Dual Rate and Expo

If values have been entered for both the Dual Rate and the Expo function, the effects of both functions will overlap, for example, as follows:

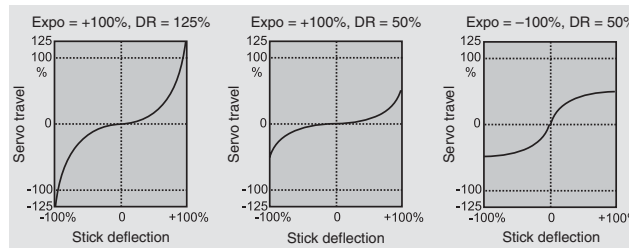

Asymmetric setting of Dual Rate and Expo

To make an asymmetric setting, i.e. a Dual Rate or Expo setting dependent on the direction of the respective joystick, first access the »**Control switch**« menu and assign one of the C1 ... C8 control switches—"C3", for example—to the desired transmitter control, e.g. control 3 for the elevator function. Do not change the switching point for the joystick's neutral position (0%). Now return to the "Dual Rate / Expo" menu and select the corresponding control function ("Elevator" in this example).

Now, with a brief tap on the center **SET** key of the right touch pad, activate the switch assignment and change to the expanded switches then use the selection keys to move on to the previously defined "C3" control switch.

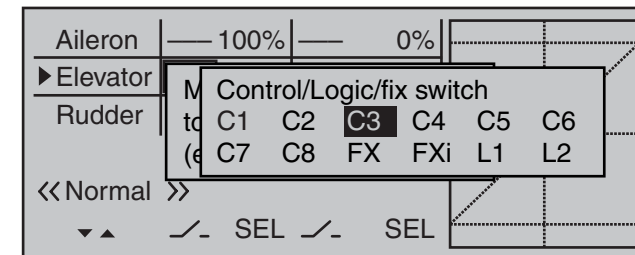

A brief tap on the center **SET** key of the right touch pad will confirm the assignment of this switch.

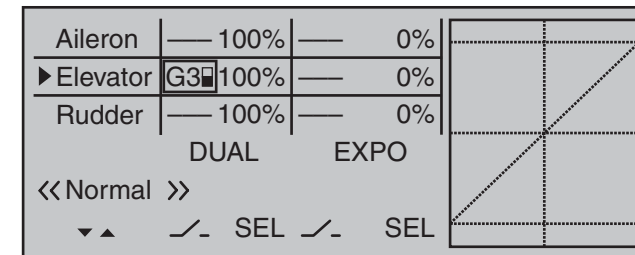

Now use one of the selection keys to move into the right column then move the elevator joystick into its appropriate end-point to enter a separate Dual Rate value for each direction, e.g. for "Up elevator" ...

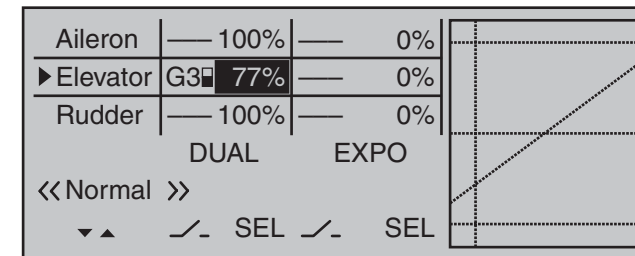

... and "Down elevator":

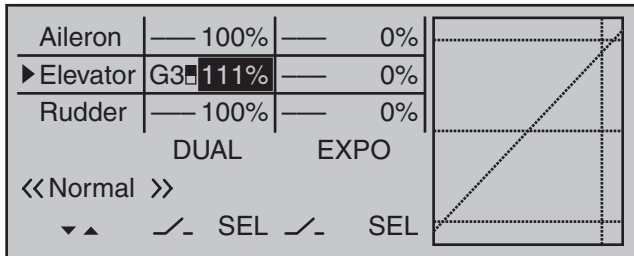

The vertical dashed line shows the current elevator joystick position.

Set the Expo values as necessary in the same manner.

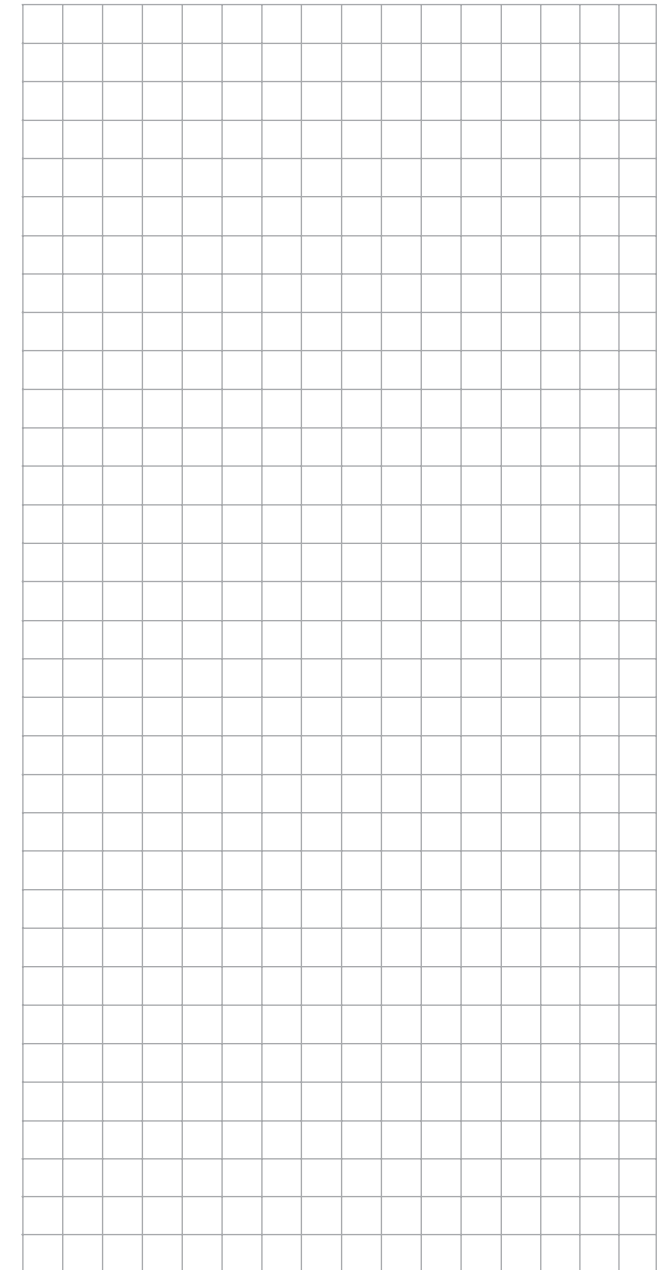
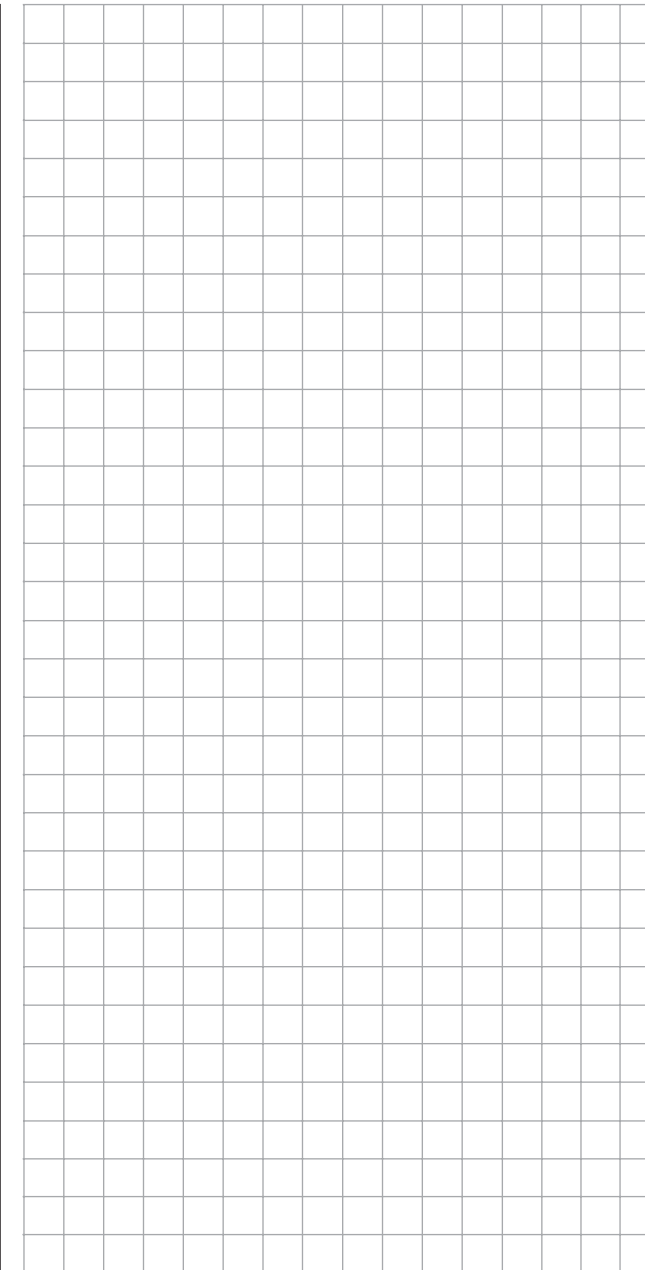

Dual Rate / Expo

Configurable control characteristics for roll, pitch-axis, tail rotor

Use the selection keys of the left or right touch pad to scroll to the »Dual Rate / Expo« menu option in the Multi-function menu:

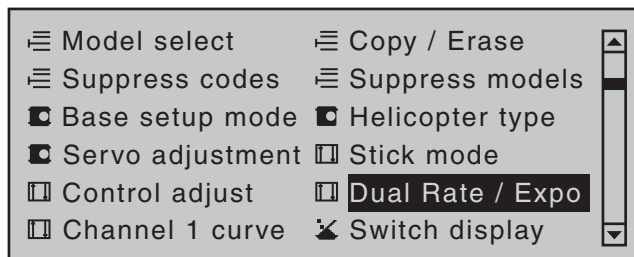

Open this menu option with a tap on the center **SET** key of the right touch pad.

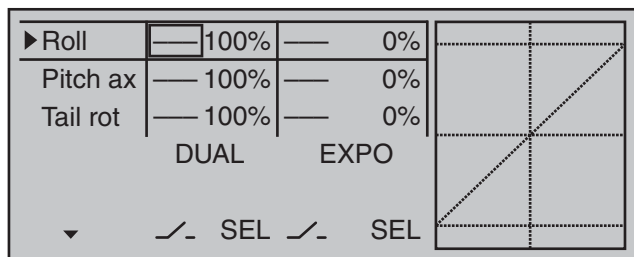

The *Dual Rate / Expo function* permits switching or controlling of control travels and characteristics for the control functions roll, pitch-axis, tail rotor, i.e. control functions 2 ... 4; it is switch-driven and flight-phase independent.

An individual curve characteristic for control function 1 (motor/collective pitch), featuring up to 8 separately programmable points, can be set either in the »Channel 1 curve« menu or separately for throttle and pitch in the »Helicopter mixer« menu, see text beginning page 176 and 312.

Similar to control travel settings in the »Control adjust« menu, **Dual Rate** operates directly on the respective *control function*, independent of whether it is an individual servo or multiple servos connected via complex mixer and coupling functions.

The control travel for each switch position can be set

to between 0 and 125% of normal full travel.

Expo, on the other hand, enables finer-grained control of the model for values larger than 0% around the center position of the primary control function (roll, pitch-axis, tail rotor), without forfeiting full movement at the end-points of joystick travel. For values less than 0%, the reverse is true: control increases around the neutral position and diminishes towards the end-points. The degree of "progression" can therefore be set within a total range of -100% to +100%, where 0% equates to the normal, linear control characteristics.

Rotary-output servos, now generally commonplace, offer another application. This is because the actual control surface movement is not linear: as the rotational angle of the output disc or lever increases, the control surface rate of travel over the control linkage continually decreases—depending on the position of the linkage point on the output disc. This effect can be counteracted with Expo values greater than 0% such that rotational angle travel increases over-proportionally with increasing joystick throw.

The Expo setting also affects the relevant control function directly, whether this controls a single servo or multiple servos – via any number of mixer and coupling functions.

For both Dual Rate and Expo functions, switch assignment can be set up in any way desired, which therefore permits the triggering of multiple functions using one and the same switch. This, in turn, offers the opportunity to link the triggering of Dual Rate and Expo functions to a single switch: this offers many advantages – particularly for very high-speed models.

The graphic screen displays the curve characteristics directly. Once you select a menu line, the dotted vertical line follows the movement of the respective joystick, so you can clearly see the dependency of the curve value on the transmitter control.

Flight phase-dependent Dual Rate and Expo settings

If flight phases are set up in the »Phase settings« and »Phase assignment« menus and each assigned a name, e.g. "Normal", the name in question will be displayed at the bottom left of the display. In this scenario, you can operate the corresponding switch to switch between flight phases.

Basic procedure

1. Switch to the desired flight phase then use the ▲▼ selection keys of the left or right touch pad to select the desired line: "Roll", "Pitch ax" or "Tail rot".
2. Use the ◀▶ selection keys of the left or right touch pad to change into the column labeled "EXPO".
3. Tap the center **SET** key of the right touch pad. The corresponding input field is shown highlighted.
4. Use the selection keys of the right touch pad to set the desired value.
5. Tap the center **SET** key of the right touch pad to complete the entry.
6. A simultaneous tap on the ▲▼ or ◀▶ keys of the right touch pad (**CLEAR**) will any setting made back to its respective default value.

Dual Rate function

If a switchover between two variants is desired, assign a switch in the column labeled with the ⚡ switch symbol (as described in the section "Assigning transmitter controls, switches and control switches" on page 56).

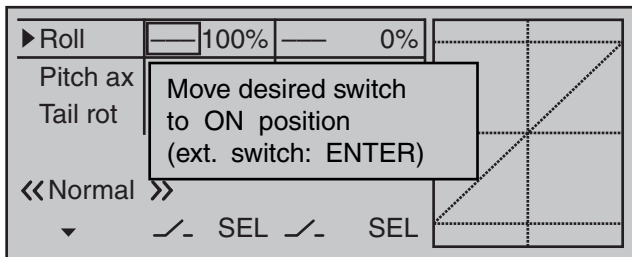

If necessary, this may also be one of the transmitter control switches C1 ... C8 or C1i ... C8i or one of the logical switches L1 ... L8 or L1i ... L8i from the list of "expanded switches".

The switch so assigned appears on the display, together with a switch icon that indicates the switch's switching direction.

In the case of "C" or "L" switches, the joystick or another transmitter control or a certain switching logic can itself be used as a switch. However, such a control switch must have been appropriately defined in the »**Control switch**« menu, see page 119, and a logical switch must have been appropriately defined in the »**Logical switch**« menu, see page 138.

Whichever switch has been assigned ... the respective switch will appear in the display together with a switch symbol indicating the switch's direction if actuated, e.g. in the «Normal» flight phase.

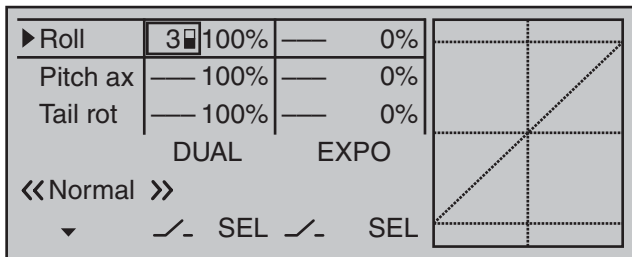

Once the value field has been activated with a brief tap on the **SET** key of the right touch pad, use the selection keys of the left or right touch pad to move into the Dual-Rate value column labeled **SEL** at the

bottom edge of the display in order to separately change the dual-rate values shown in inverse video for each of the two switch positions.

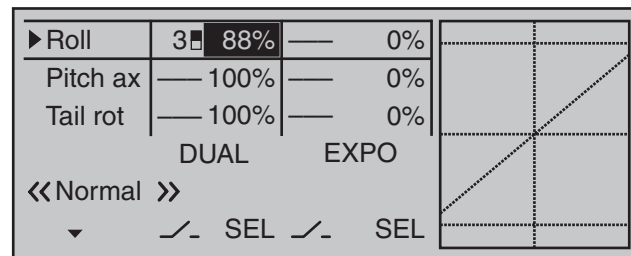
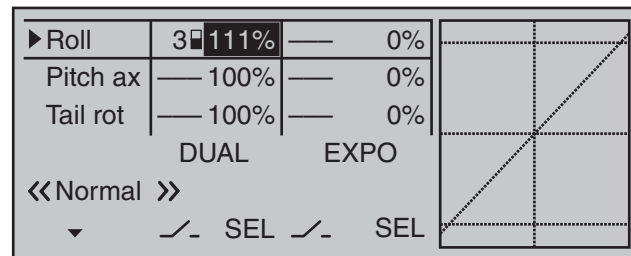

At the same time, the Dual-Rate curve will be presented in the graph. A simultaneous tap on the ▲▼ or ◀▶ keys of the right touch pad (**CLEAR**) will reset a changed entry field value displayed in inverse video back to "100%".

Caution:

For safety reasons, Dual Rate value settings should not be less than 20%.

Some examples of Dual Rate values:

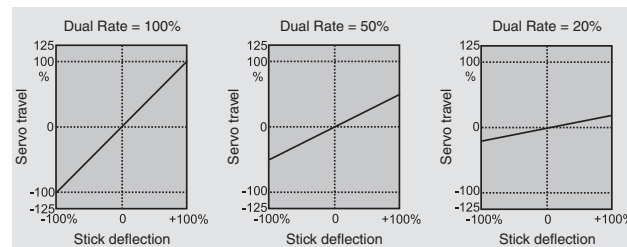

Exponential function

If a switchover between two variants is desired, assign a switch in the column labeled with the ◡ switch symbol (as described in the section "Assigning transmitter controls, switches and control switches" on page 56).

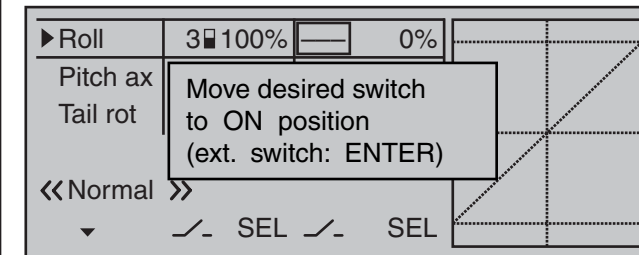

If necessary, this may also be one of the transmitter control switches C1 ... C8 or C1i ... C8i or one of the logical switches L1 ... L8 or L1i ... L8i from the list of "expanded switches".

The switch so assigned appears on the display, together with a switch icon that indicates the switch's switching direction.

In the case of "C" or "L" switches, the joystick or another transmitter control or a certain switching logic can itself be used as a switch. However, such a control switch must have been appropriately defined in the »**Control switch**« menu, see page 119, and a logical switch must have been appropriately defined in the »**Logical switch**« menu, see page 138.

Whichever switch has been assigned ... the respective switch appears on the display together with a switch symbol indicating the switch's respective direction when moved.

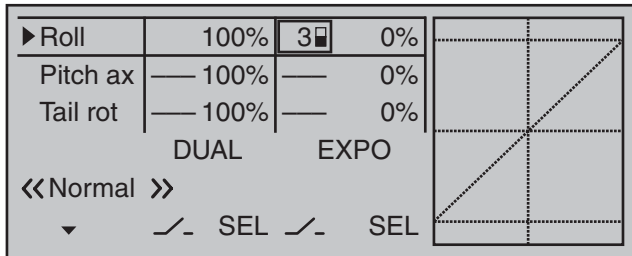

Select the right-hand column at the lower edge of the display marked with **SEL** and activate the value field with a brief tap on the center **SET** key of the right touch pad, the selection keys on the left or right touch pad can now be used to alter the Expo value shown in the highlighted field, separately for each of the two switch positions.

Now, for example, you have the opportunity to fly with a linear curve characteristic with the switch in one direction, and to pre-set a value other than 0% in the other switching direction:

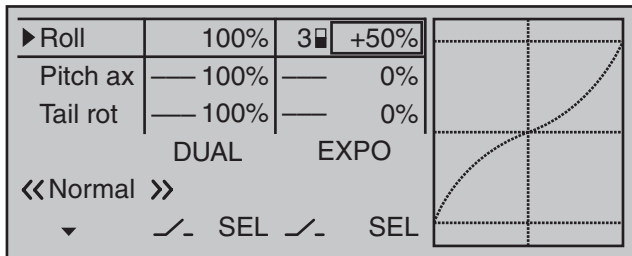

At the same time, the Expo curve will be presented in the graph. A simultaneous tap on the ▲▼ or ◀▶ keys of the right touch pad (**CLEAR**) will reset a changed entry field value displayed in inverse video back to "0%".

Some examples of Expo values:

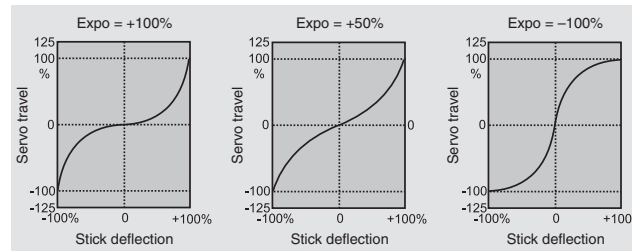

In each of these examples, the Dual Rate value equals 100%.

Combining Dual Rate and Expo

If you have entered values for both the Dual Rate and the Expo function, the effect from one function is superimposed on the other, as shown in these examples:

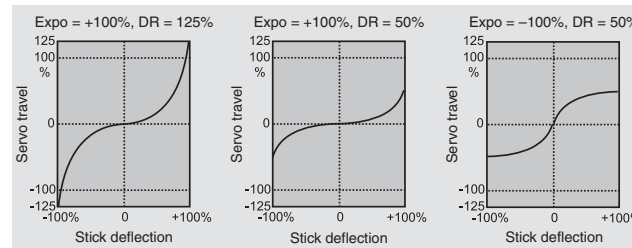

Asymmetric setting of Dual Rate and Expo

To make an asymmetric setting, i.e. a Dual Rate or Expo setting dependent on the direction of the respective joystick, first access the »**Control switch**« menu and assign one of the C1 ... C4 control switches—"C3" for example—to the desired transmitter control, e.g. control 3 for the pitch function. Do not change the switching point for the joystick's neutral position (0%). Now return to the "Dual Rate / Expo" menu and select the corresponding control function ("Pitch ax" in this example).

Now, with a brief tap on the center **SET** key of the right touch pad, activate the switch assignment and change to the expanded switches then use the selection keys to move on to the previously defined "C3" control switch.

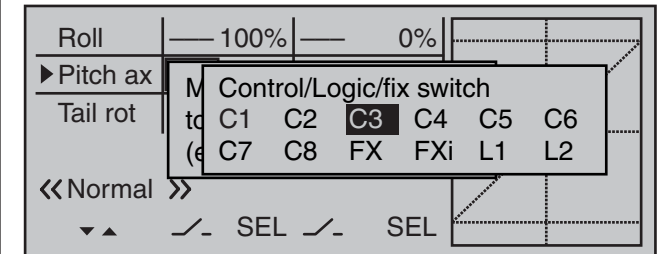

A brief tap on the center **SET** key of the right touch pad will confirm the assignment of this switch.

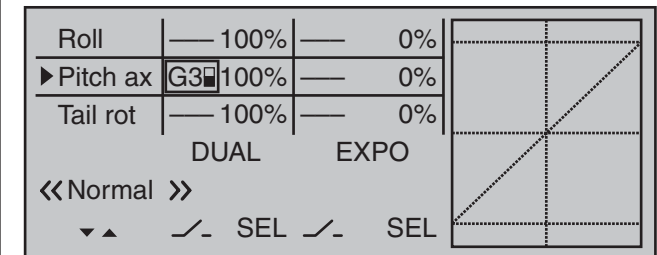

Now use one of the selection keys to move into the right column then move the pitch-axis joystick to the appropriate end-point in order to enter a separate Dual Rate value for each direction, e.g. for "Pitch-axis up" ...

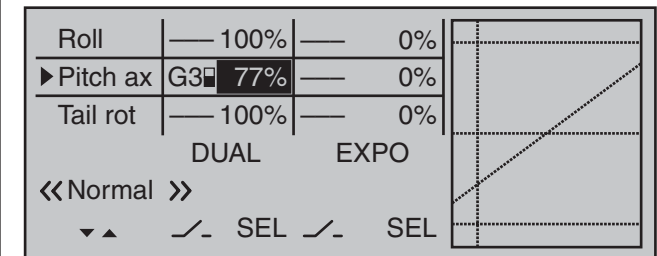

and "Pitch-axis down":

| | | | |
|-------|----------|----|--|
| Roll | — 100% — | 0% | |
| ►Nick | C3 111% | 0% | |
| Tail | — 100% — | 0% | |

DUAL EXPO

<<Normal >>

▼ ▲ /- SEL /- SEL

The vertical dashed line shows the current pitch axis joystick position.

Set the Expo values as necessary in the same manner.

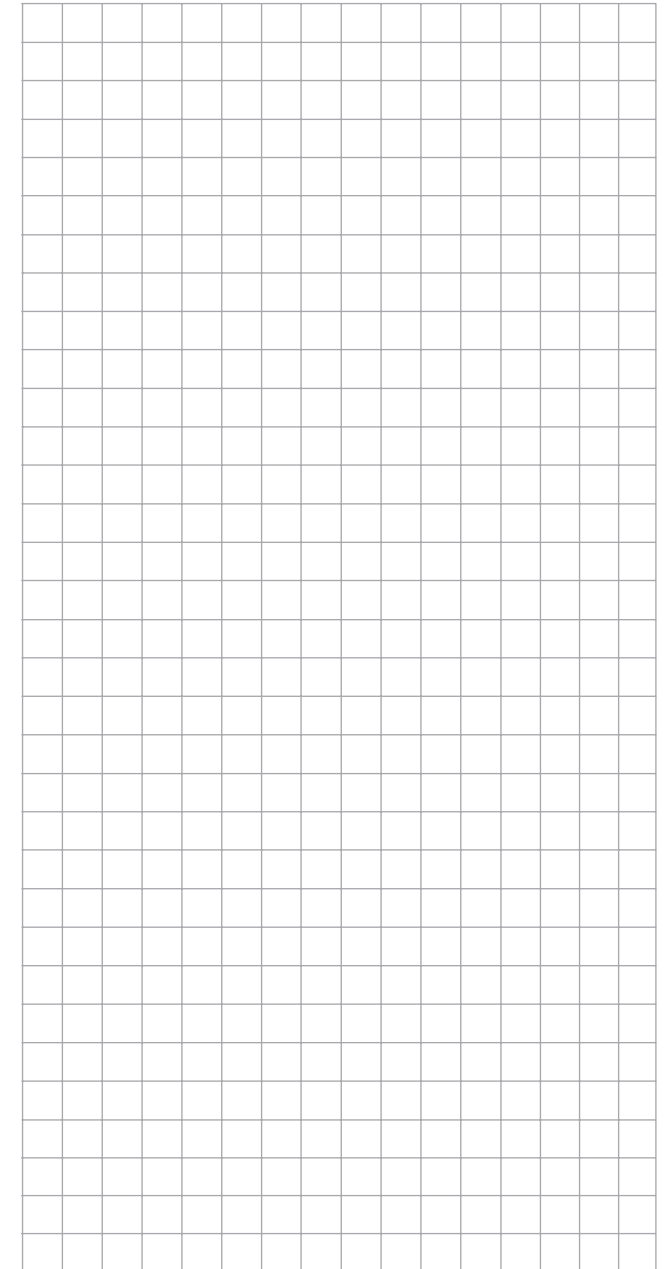
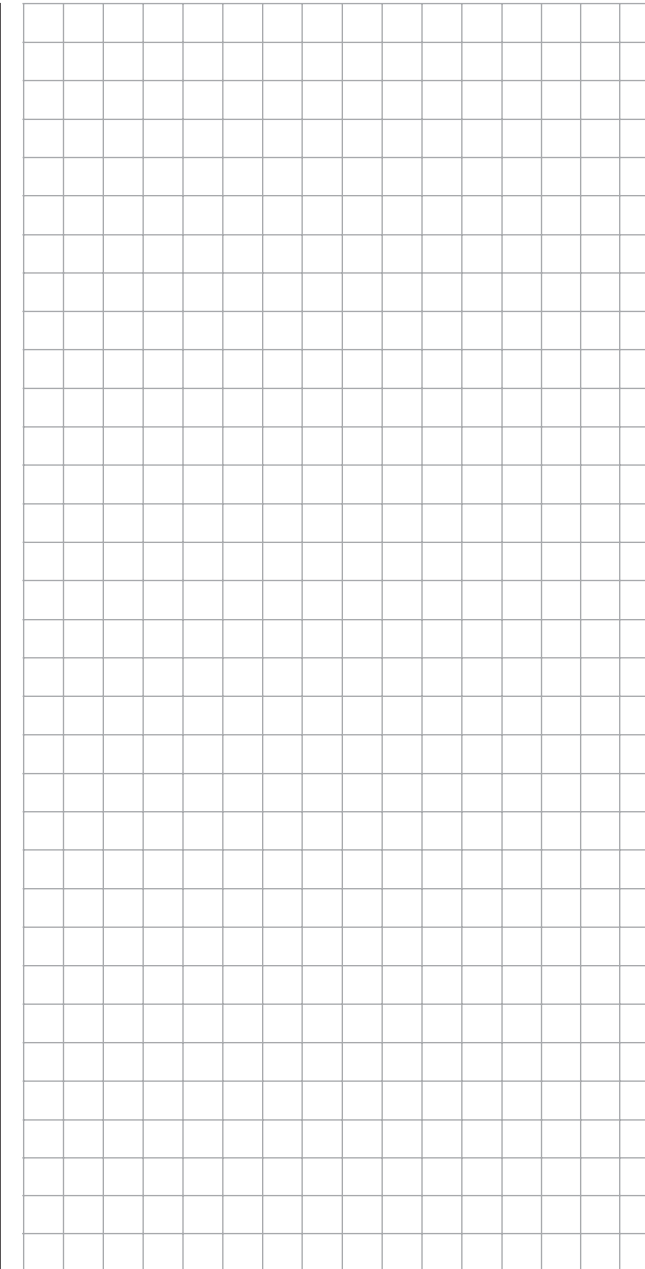

Channel 1 curve

Control characteristics for throttle/spoiler joystick

Using the selection keys of the left or right touch pad, scroll to the »**Channel 1 curve**« menu option in the Multi-function menu:

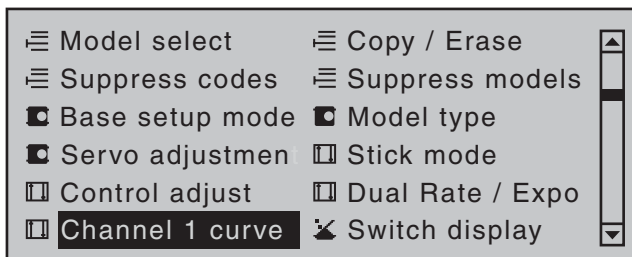

Open this menu option with a tap on the center **SET** key of the right touch pad.

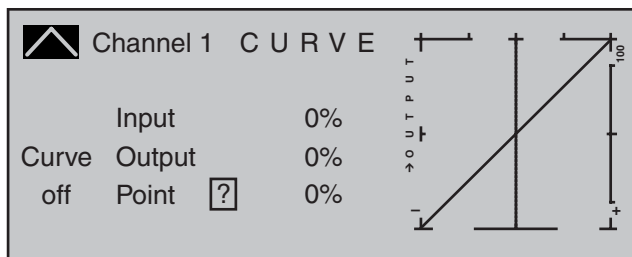

Since the carburetor response or the effect of the airbrakes or spoilers is often non-linear, you can make compensatory adjustments to these in this menu.

The menu therefore enables you to change the *control characteristics of the throttle / airbrake joystick*, regardless of whether this control function affects the servo connected to control channel 1 directly or affects multiple servos via various mixers.

If flight phases have been specified in the »**Phase settings**« and »**Phase assignment**« menus (see pages 142 and 148) this option can be adapted on a flight-phase basis. The given flight phase name, e.g. «normal», will be shown at the bottom left of the screen.

The control curve can be defined by up to 8 points (termed "reference points" below) placed anywhere

along the path of joystick travel. While the on-screen graph considerably simplifies the process of setting and adjusting the reference points, we recommend that you set fewer reference points to begin with.

In the basic software set-up, 2 reference points—namely the end-points at the bottom end of joystick travel ("L", low = -100% travel) and the top end of joystick travel ("H", high = +100% travel)—define a linear characteristic curve.

First, switch to your chosen flight phase, if necessary.

Setting reference points

By moving the transmitter control (throttle/airbrake joystick), you can reposition the vertical line in the graph between the two end-points "L" and "H". The current joystick position is also displayed in numerical form on the "Input" line (-100% to +100%). The point at which this line crosses the curve is termed the "Output", and can be varied at the reference points within the range -125% to +125%. The control signal altered in this way will then affect all subsequent mixer and coupling functions.

In the example above, the joystick is at 0% of control travel and also generates an output signal of 0%, since the characteristic curve is linear.

Up to 6 additional reference points can be set *between* the two end-points "L" and "H", although the distance between neighboring reference points must not be less than approx. 25%.

Move the joystick. If a question mark can be seen in the "Point" frame, then the next reference point can be set with a tap on the center **SET** key of the right touch pad. Simultaneously, the "?" is replaced by a number and the value field to the right of the reference point number will be shown in inverse video.

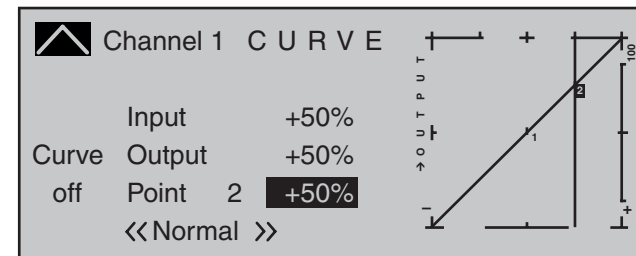

The order in which you generate the (maximum) 6 reference points between the end-points "L" and "H" is irrelevant, since the reference points are continuously renumbered automatically from left to right as they are entered.

Erasing reference points

To delete one of the reference points (1 to max. 6), use the joystick to move the vertical line into the vicinity of the reference point in question. As soon as the reference point number and its corresponding value on the "Point" line are displayed in inverse video, see figure above, these can be erased with a simultaneous tap on the ▲▼ or ◀▶ keys of the right touch pad (**CLEAR**). Complete the operation with a brief tap on the center key **ESC** of the left touch pad.

Changing reference point values

Move the joystick into the range of the reference point that is to be changed: "L" (low), 1 ... 6 or "H" (high). The number and current curve value of this point are displayed. The reference point value displayed in inverse video can be changed in a range of -125% to +125% without influencing the neighboring reference points.

Example:

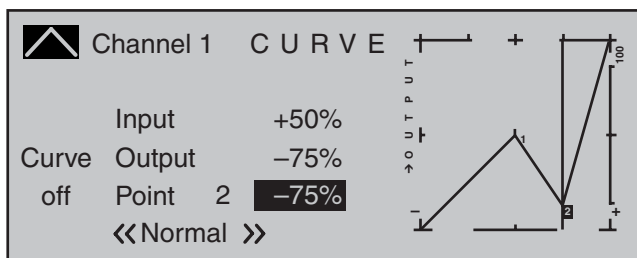

In this sample screen image, reference point "2" has been set to -75%.

Note:

If the joystick does not coincide with the exact reference point, please note that the percentage value on the "Output" line always relates to the current joystick position.

Trim point function

Alternatively, jumping through *active* reference points, in ascending or descending order, can be done with the ◀ ▶ selection keys of the left touch pad. Note that "active" reference points are those which have already been set. When a jump is made from one to another, the point value field for the jump's destination reference point in the screen's Point line will be displayed in inverse video and its position in the graph will be marked with the point's number (L, 1 ... max. 6 and H) in inverse video and a small triangle. The selection keys on the right touch pad can then be used to change the reference point jumped to as described above, entirely independently of the control position.

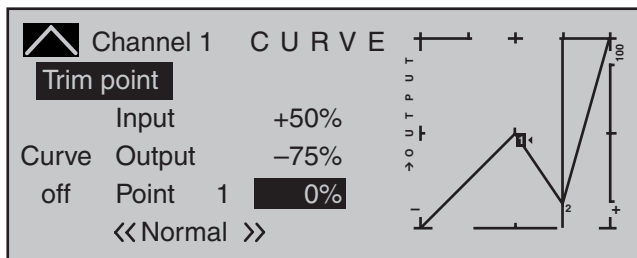

One touch on the center **ESC** key of the left touch pad terminates this trim point function.

Trim offset function

When a value field is active, i.e. in inverse video, it is not only possible, as previously described, to jump to and change a reference point already set with the ◀ ▶ selection keys of the left touch pad but also an existing curve can be vertically repositioned with the ▲ ▼ keys of the left touch pad within a range of ±25%.

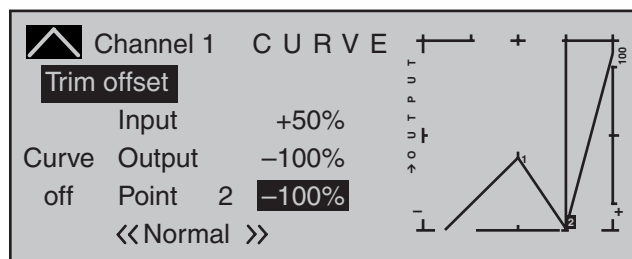
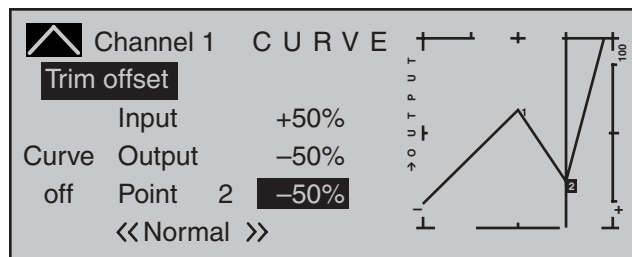

A tap on the center **ESC** key of the left touch pad will also terminate this function.

Trim x-axis function

This function is activated by tapping the left (◀) or right (▶) selection key of the right touch pad with an active (i.e. inverse video) value field. You can then use the selection keys on the right touch pad to reposition the active point horizontally or vertically as you wish.

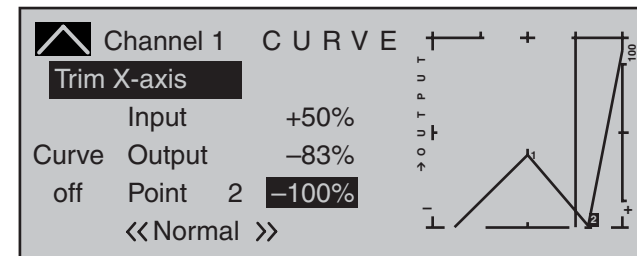

Notes:

- If the point is repositioned horizontally further away from the current control position than approx. ±25%, a "?" sign will reappear in the line Point. This question mark does not refer to the repositioned point, however: instead, it signifies that a further point can be set at the current control position.
- Please note that the percentage value on the "Output" line always relates to the current joystick position and not to the position of the point.

Smoothing the Channel 1 curve

In the example below, sample reference points have been set:

- reference point 1 to 0%,
- reference point 2 to +25% and
- reference point 3 to -75%

as described in the last section.

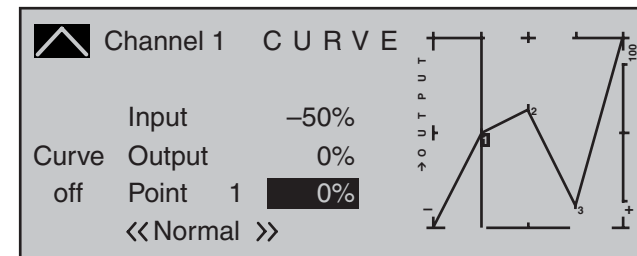

This "jagged" curve profile can be smoothed automatically simply by pressing a button.

Do this – from a situation as illustrated – with a brief tap on the ▼ selection key of the left touch pad. This will cause a switchover from "(Curve) off" to "(Curve) on" (or vice versa).

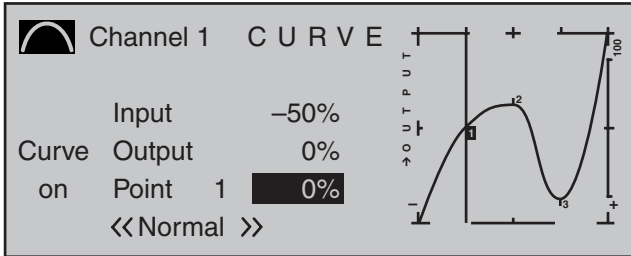

Note:

The curves shown here are for demonstration purposes only and are not at all representative of real throttle or airbrake curves. A specific application example can be found in the programming examples on page 274.

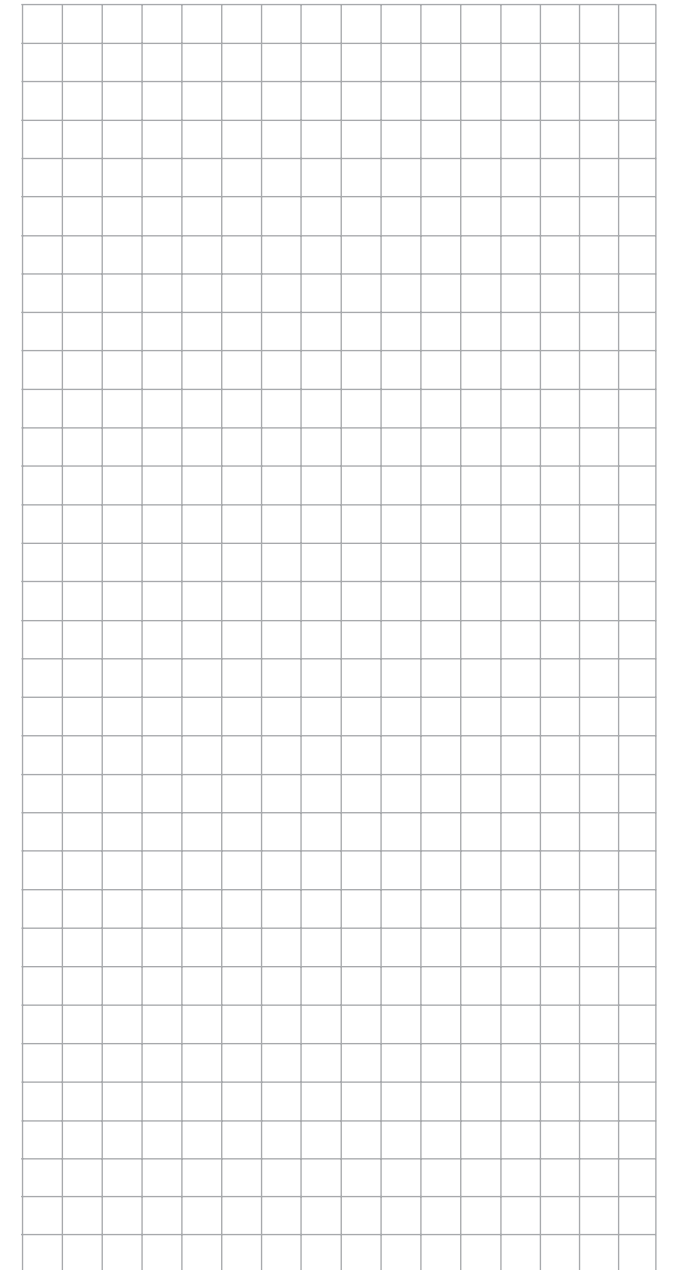
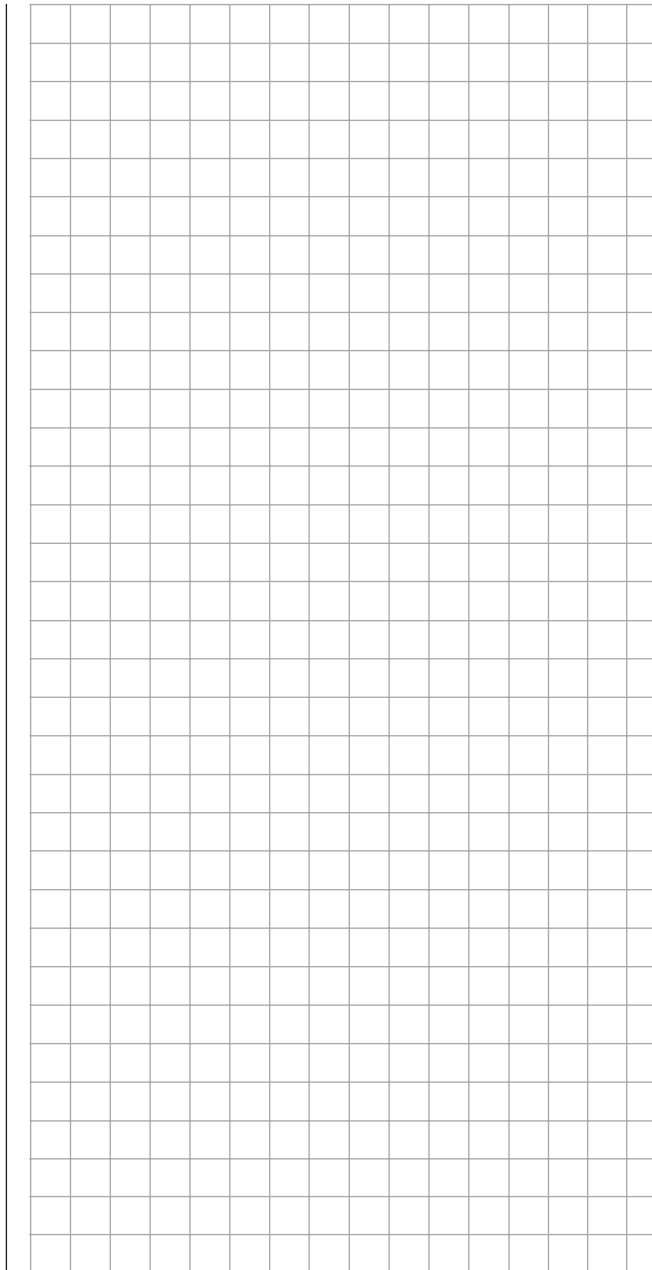

Channel 1 curve

Control characteristics for throttle/collective pitch stick

Using the selection keys of the left or right touch pad, scroll to the »**Channel 1 curve**« menu option in the Multi-function menu:

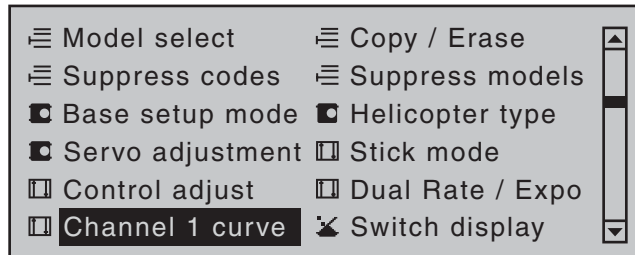

Open this menu option with a tap on the center **SET** key of the right touch pad.

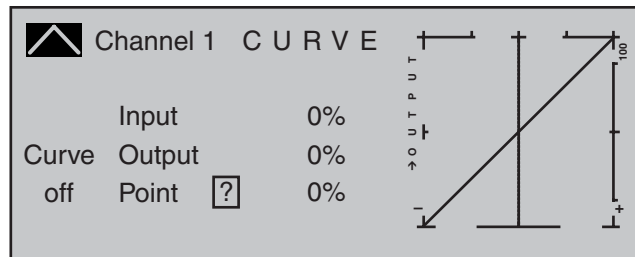

Since the carburetor response or the effect of collective pitch is often non-linear, you can make compensatory adjustments to these in this menu. The menu therefore enables modification of the *control characteristics of the motor/collective pitch joystick*, regardless of whether this control function affects the servo connected to control channel 1 directly or affects multiple servos via various mixers. If flight phases have been specified in the »**Phase settings**« and »**Phase assignment**« menus (see pages 142 and 148) this option can be adapted on a flight-phase basis. The given flight phase name, e.g. «normal», will be shown at the bottom left of the screen.

The control curve can be defined by up to 8 points (termed "reference points" below) placed anywhere

along the path of joystick travel. While the on-screen graph considerably simplifies the process of setting and adjusting the reference points, we recommend that you set fewer reference points to begin with.

Please note that the curve characteristic you set here acts as the input signal for specific mixers in the »**Helicopter mixer**« menu, page 176.

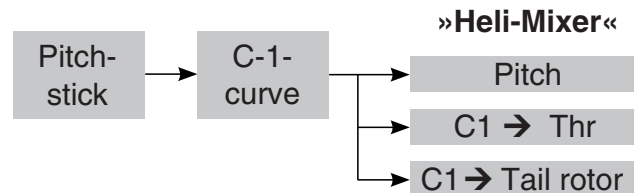

In the basic software set-up, 2 reference points—namely the end-points at the bottom end of joystick travel ("L", low = -100% travel) and the top end of joystick travel ("H", high = +100% travel)—define a linear characteristic curve.

First, switch to your chosen flight phase, if necessary.

Setting reference points

By moving the transmitter control (motor/collective pitch stick), you can reposition the vertical line in the graph between the two end-points "L" and "H". The current joystick position is also displayed in numerical form on the "Input" line (-100% to +100%). The point at which this line crosses the curve is termed the "Output", and can be varied at the reference points within the range -125% to +125%. The control signal altered in this way will then affect all subsequent mixer and coupling functions.

In the example above, the joystick is at 0% of control travel and also generates an output signal of 0%, since the characteristic curve is linear.

Up to 6 additional reference points can be set *between* the two end-points "L" and "H", although the distance between neighboring reference points must not be less than approx. 25%.

Move the joystick. If a question mark can be seen in the "Point" frame, then the next reference point can be set with a tap on the center **SET** key of the right touch pad. Simultaneously, the "?" is replaced by a number and the value field to the right of the reference point number will be shown in inverse video.

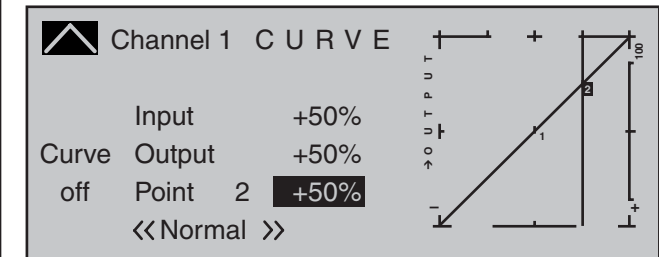

The order in which you generate the (maximum) 8 reference points between the end-points "L" and "H" is irrelevant, since the reference points are continuously renumbered automatically from left to right as they are entered.

Erasing reference points

To delete one of the reference points (1 to max. 6), use the joystick to move the vertical line into the vicinity of the reference point in question. As soon as the reference point number and its associated value is shown on the "Point" line (see screen image above), following activation of the value field on the "Point" line now in inverse video with a simultaneous tap on the ▲▼ or ◀▶ keys of the right touch pad (**CLEAR**) it can be erased. Complete the operation with a brief tap on the center key **ESC** of the left touch pad.

Changing reference point values

Move the joystick into the range of the reference point that is to be changed: "L" (low), 1 ... 6 or "H" (high). The number and current curve value of this point are displayed. Activate the value field with a brief tap on the center **SET** key of the right touch pad. The point value field is now highlighted and can be set within

the range -125% to +125%, and without influencing the neighboring reference points.

Example:

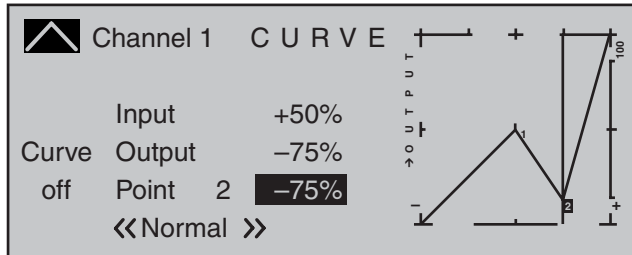

In this sample screen image, reference point "2" has been set to -75%.

Note:

If the joystick does not coincide with the exact reference point, please note that the percentage value on the "Output" line always relates to the current joystick position.

Trim point function

Alternatively, jumping through set reference points can be done with the ◀ ▶ selection keys of the left touch pad in either ascending or descending order, whereby the number of the jump's destination reference point in the graph will be marked with the point's number, 1 ... max. 6, in inverse video. The selection keys on the right touch pad can then be used to change the reference point jumped to as described above, entirely independently of the control position.

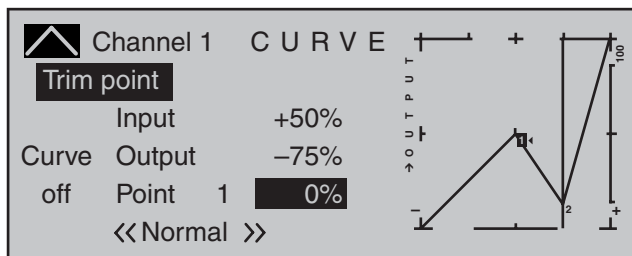

One touch on the center **ESC** key of the left touch pad terminates this trim point function.

Trim offset function

When a value field is active, i.e. in inverse video, it is not only possible, as previously described, to jump to and change a reference point already set with the ◀ ▶ selection keys of the left touch pad but also an existing curve can be vertically repositioned with the ▲ ▼ keys of the left touch pad within a range of ±25%.

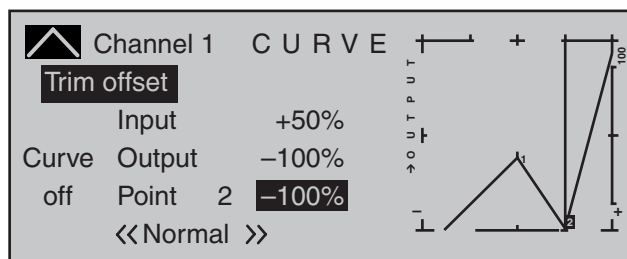
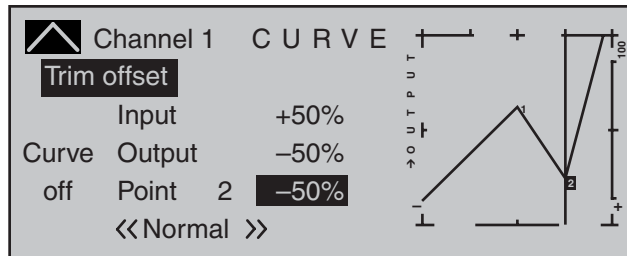

A tap on the center **ESC** key of the left touch pad will also terminate this function.

Trim x-axis function

This function is activated by tapping the left (◀) or right (▶) selection key of the right touch pad with an active (i.e. inverse video) value field. You can then use the selection keys on the right touch pad to reposition the active point horizontally or vertically as you wish.

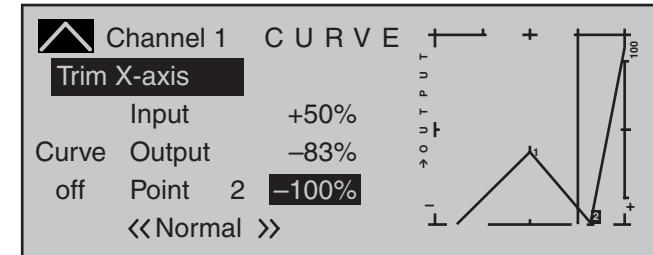

Notes:

- If the point is repositioned horizontally further away from the current control position than approx. ±25%, a "?" sign will reappear in the line Point. This question mark does not refer to the repositioned point, however: instead, it signifies that a further point can be set at the current control position.
- Please note that the percentage value on the "Output" line always relates to the current joystick position and not to the position of the point.

Smoothing the Channel 1 curve

In the example below, sample reference points have been set:

- reference point 1 to 0%,
- reference point 2 to +25% and
- reference point 3 to -75%

as described in the last section.

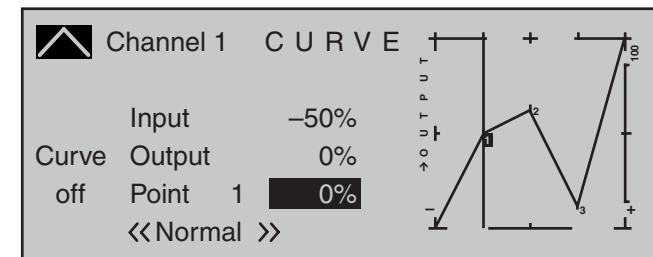

This "jagged" curve profile can be smoothed automatically simply by pressing a button.

Do this – from a situation as illustrated – with a brief tap on the ▼ selection key of the left touch pad. This will cause a switchover from "(Curve) off" to "(Curve) on" (or vice versa).

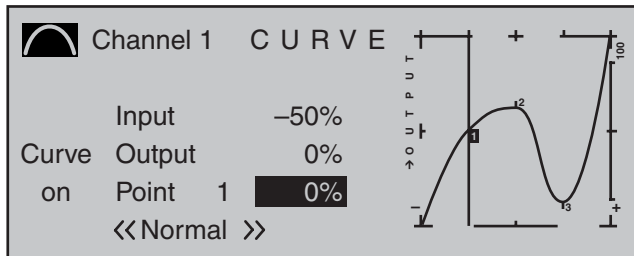

Note:
The curves shown here are for demonstration purposes only and are not at all representative of real throttle curves. For real-world application examples, see the programming examples on pages 274 and 313.

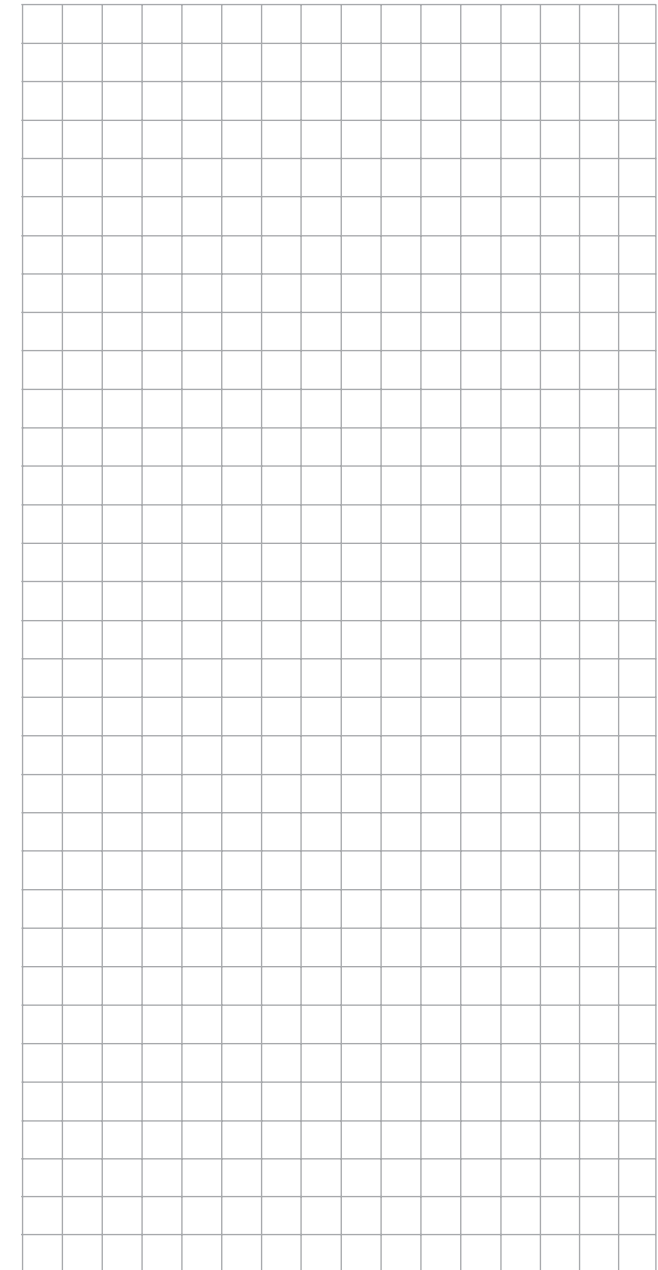
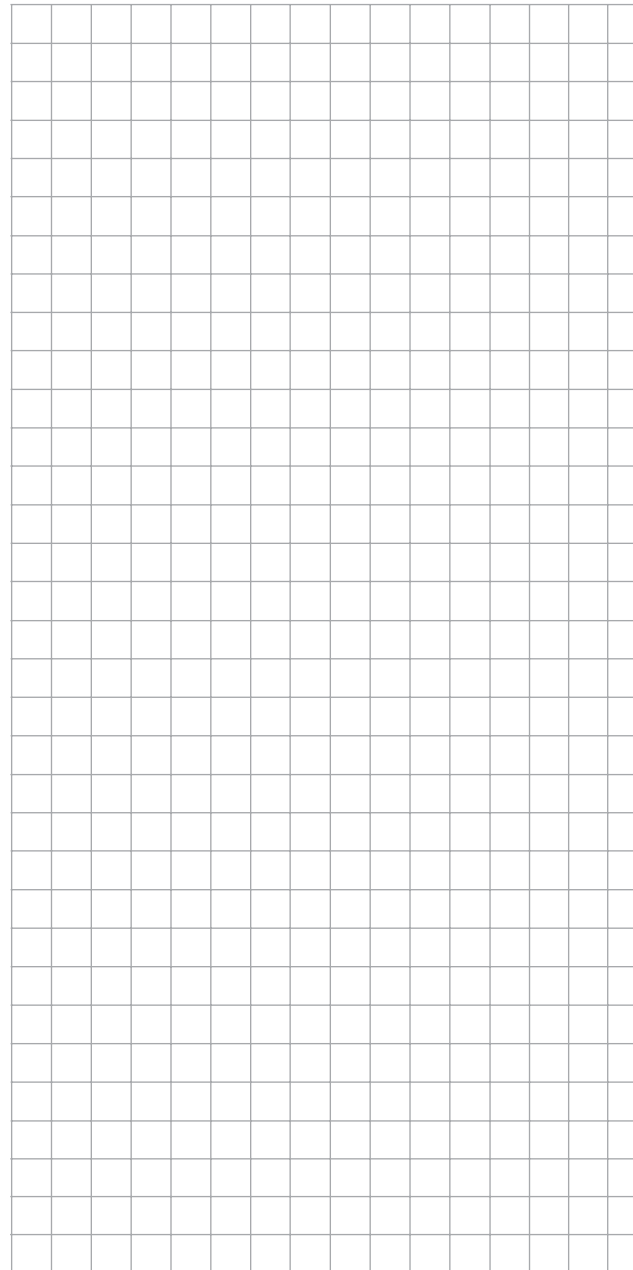

Switch display

Displaying switch positions

Use the selection keys on the left or right touch pad to scroll to the »**Switch display**« option in the multi-function menu:

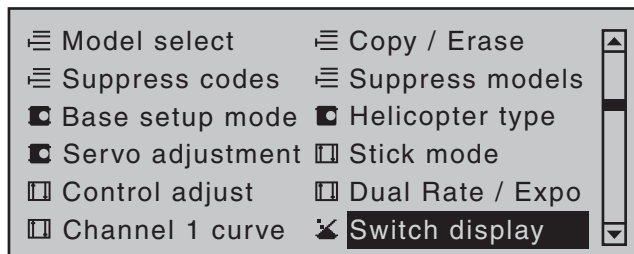
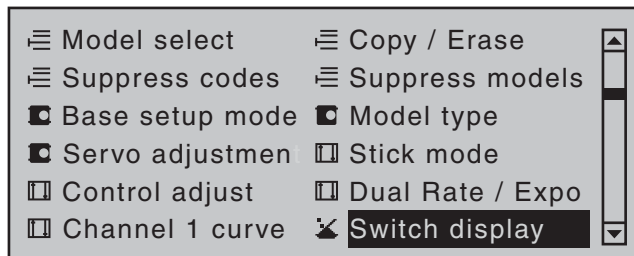

Open this menu option with a tap on the center **SET** key of the right touch pad.

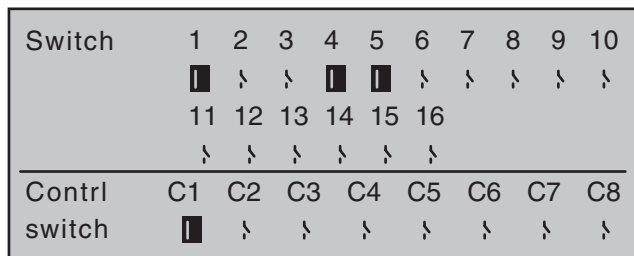

This feature is used to check the functions and give an overview of switches 1 ... 16 and the programmable control switches C1... C8.

If a switch is pressed, the switch number is revealed by one of the display items changing from an OFF to an ON symbol (or vice versa). To improve the legibility of this screen, a closed switch field is also shown in inverse video (i.e. on a dark background).

For control switches C1 ... C8, activation of the corresponding transmitter control—which must have been previously assigned on the »**Control switch**« menu—will reveal the control switch number and direction.

Note:
Switch numbering 1 to 16 as shown here corresponds to the labeling of switch plug-in locations on the transmitter's circuit board. The numbering of the switches has no effect on the programming of the transmitter, however.

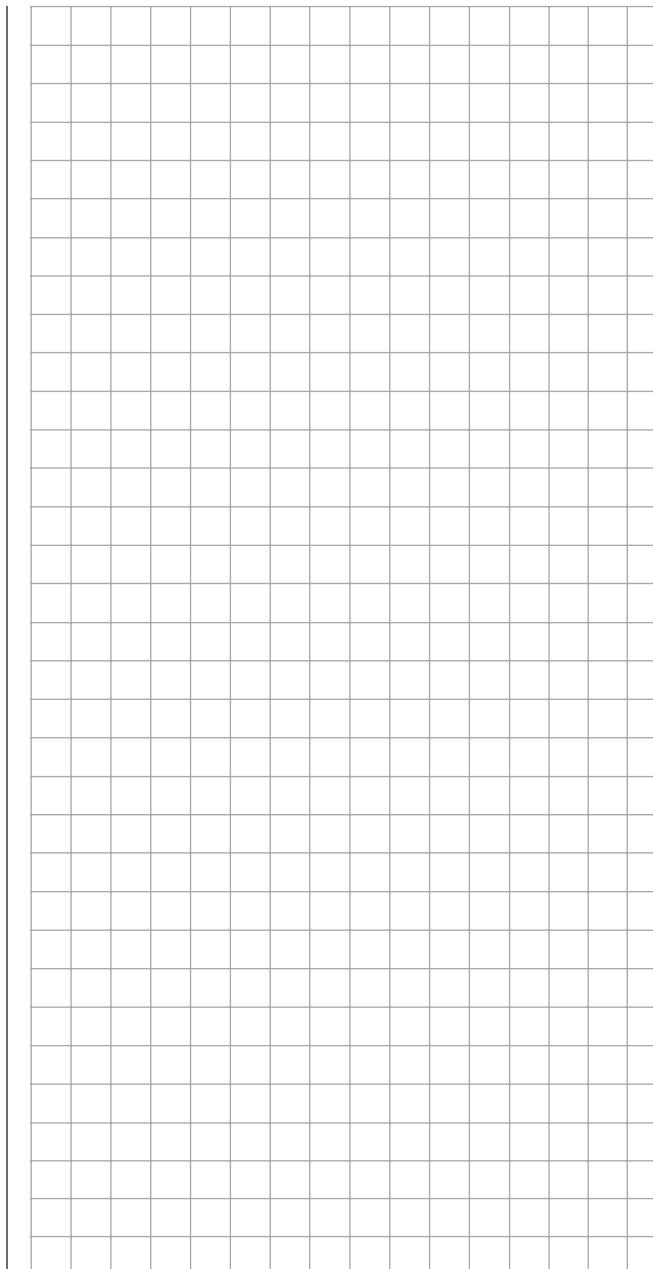

Control switches

Programming the control switches

Use the selection keys on the left or right touch pad to scroll to the »**Control switch**« option in the multi-function menu:

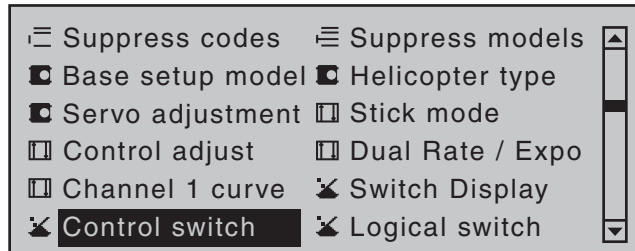
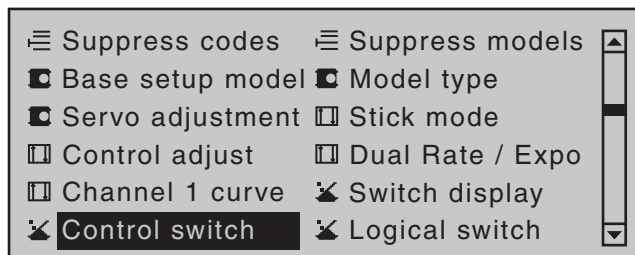

Open this menu option with a tap on the center **SET** key of the right touch pad.

| CONTROL SWITCH | | | | | |
|----------------|------|----|----|------|------|
| ▶C1 | free | 0% | => | ---- | C1 ↵ |
| C2 | free | 0% | => | ---- | C2 ↵ |
| C3 | free | 0% | => | ---- | C3 ↵ |
| C4 | free | 0% | => | ---- | C4 ↵ |
| ▼ | SEL | | | | |

With many functions, it makes sense not to trigger their actuation by using one of the normal switches, but to trigger them automatically by the specific, freely programmable position of a transmitter control or joystick.

Typical applications:

- On/Off switching of an on-board glow plug in conjunction with the carburetor setting and/or

motor speed. (The glow plug heater switch for this will be controlled by a transmitter-side mixer.)

- Switching a stopwatch on or off to measure the simple running time of electric motors
- Automated switch-off of a combi "aileron → rudder" mixer when extending the airbrakes, e.g. so as to match the bank attitude of the model to the ground slope when landing on a ridge, without the direction of flight also being affected by the rudder (if the mixer were active).
- Lowering landing flaps, adjusting elevator trim and/or executing specific Dual Rate, Exponential and Differential switchings when coming in to land, as soon as the throttle joystick is moved beyond the switching point. If required, a control switch can be overridden using a separately assigned switch in the 5th column.

The **MC-20** HoTT program is equipped with a total of eight so-called control switches ("C1" to "C8").

Accordingly, anywhere where switches can be assigned you have the option not only of using the 16 possible transmitter switches, but also of choosing and assigning one of the "C1" ... "C8" control switches from the list of expanded switches – as described in the section "Assigning transmitter controls, switches and control switches" on page 56.

Furthermore, combining a control switch with an additional switch (as described later) also permits more complex switching permutations.

Basic procedure:

1. If no transmitter control is assigned, the corresponding input field of the column labeled **SEL** (second column from the left) will be empty.
2. Use the selection keys of the left or right touch pad to select the line for the desired control switch (1 to 8).

3. Briefly tap the center **SET** key of the right touch pad.
4. Move your selected transmitter control. The associated transmitter control number appears in the input field of the column above the left switch icon.
5. Use the selection keys on the left or right touch pad to move to the right into the column labeled **STO**.
6. Move the transmitter control to the desired switching point then briefly tap on the center **SET** key of the right touch pad to save the switching point.
7. Complete the remaining settings such as switching direction, etc.
8. Exit from the menu with a tap on the center **ESC** key of the left touch pad.

Assigning a transmitter control to a control switch

Using the selection keys on the left or right touch pad, select your chosen line (1 to 8). Following a final tap on the center SET key of the right touch pad to activate the control assignment, the message shown below will appear in the display:

| CONTROL SWITCH | | | | | |
|----------------|------|----|----|------|------|
| ▶C1 | fre | 0% | => | ---- | C1 ↵ |
| C2 | fre | 0% | => | ---- | C2 ↵ |
| C3 | free | 0% | => | ---- | C3 ↵ |
| C4 | free | 0% | => | ---- | C4 ↵ |
| ▼ | SEL | | | | |

A callout box highlights the 'fre' in the C1 row and the '0%' in the C2 row, with the text 'Move desired control adj.' inside.

For example, the right-side proportional slider is now to be assigned to control switch "C1", the default throttle limiter for a helicopter model memory. So just move this control in any direction. As soon as this is detected, the control name appears on the display:

| CONTROL SWITCH | | | | | |
|----------------|--------|-----|-----|-----|------|
| ▶C1 | Lever1 | 0% | => | --- | C1 |
| C2 | free | 0% | => | --- | C2 ↓ |
| C3 | free | 0% | => | --- | C3 ↓ |
| C4 | free | 0% | => | --- | C4 ↓ |
| ▼ | SEL | STO | SEL | ↙ | |

Resetting a control switch back to "free"

To reset a control switch back to "free", make sure the display is as below ...

| CONTROL SWITCH | | | | | |
|----------------|--------|---------------------------|-----|-----|------|
| ▶C1 | Lever1 | Move desired control adj. | | --- | C1 |
| C2 | free | | | --- | C2 ↓ |
| C3 | free | 0% | => | --- | C3 ↓ |
| C4 | free | 0% | => | --- | C4 ↓ |
| ▼ | SEL | STO | SEL | ↙ | |

... then, with a brief simultaneous tap on the ▲▼ or ◀▶ keys of the right touch pad (**CLEAR**), the entry for a control will be erased.

Defining the switching point

Using the ▶ selection key of the left or right touch pad to move the marker frame into the column labeled **STO** (store).

Move the selected transmitter control to the position at which the switching point, i.e. the switch between OFF/ON, should trigger and briefly tap the center **SET** key of the right touch pad. The current position is displayed, for example "+85%":

| CONTROL SWITCH | | | | | |
|----------------|--------|------|-----|-----|------|
| ▶C1 | Lever1 | +85% | => | --- | C1 |
| C2 | free | 0% | => | --- | C2 ↓ |
| C3 | free | 0% | => | --- | C3 ↓ |
| C4 | free | 0% | => | --- | C4 ↓ |
| ▼ | SEL | STO | SEL | ↙ | |

The switching point can be altered at any time with another tap on the center **SET** key of the right touch pad.

Note:

Do not, however, set a switching point at a transmitter control's travel end-point, since this makes reliable switching impossible. If a 2-way or 3-way switch is used to operate a control switch, the switch point should be programmed in advance with one of the transmitter's proportional controls.

First, assign the corresponding proportional control in the 2nd column and set the switching point in such a way that will ensure the subsequent configuration for the 2-way or 3-way switch will reliably exceed this value. If you do not, the switching function will be unreliable, since the control switch triggers only if a value unambiguously fails to meet or exceeds the value set! To complete the procedure, cancel the transmitter control assignment then assign the 2-way or 3-way switch.

Setting the switching direction

The switching direction of the control switch is changed as required in the 4th column. Use the ▶ selection key of the left or right touch pad to move the marker frame into the column labeled **SEL** (select). Following a brief tap on the center **SET** key of the right touch pad, the switch direction can be changed back-and-forth between "normal" and "reversed" with the selection keys of the left or right touch pad.

| CONTROL SWITCH | | | | | |
|----------------|--------|------|-----|-----|------|
| ▶C1 | Lever1 | +85% | ⇒ | --- | C1 |
| C2 | free | 0% | => | --- | C2 ↓ |
| C3 | free | 0% | => | --- | C3 ↓ |
| C4 | free | 0% | => | --- | C4 ↓ |
| ▼ | SEL | STO | SEL | ↙ | |

| CONTROL SWITCH | | | | | |
|----------------|--------|------|-----|-----|------|
| ▶C1 | Lever1 | +85% | ⇐ | --- | C1 |
| C2 | free | 0% | => | --- | C2 ↓ |
| C3 | free | 0% | => | --- | C3 ↓ |
| C4 | free | 0% | => | --- | C4 ↓ |
| ▼ | SEL | STO | SEL | ↙ | |

A simultaneous tap on the ▲▼ or ◀▶ keys of the right touch pad (**CLEAR**) will reset the switch direction back to "=>".

The current switch position of the control switch is displayed in the leftmost column by the switch icon next to the number of the control switch.

Notes:

- In this example control switch "C1" is open as long as transmitter control "Lever 1" (the throttle limiter for a helicopter) is less than +85% of control travel. It closes once the switching point is exceeded, i.e. by a value over +85% and up to the upper limit.
- In the above example with the switching direction reversed, control switch "C1" remains closed while the transmitter control is at less than +85% of full travel. As soon as the switching point is exceeded, in this example a value between +85% and the upper travel end-point, "C3" will open.
- If a control switch – e.g. "C1" – has multiple assignments, you should bear in mind that the switching direction set here applies to all C3 switches.

- The switch state can also be inverted by reversing the control in the »**Control adjust**« menu.

Combining a control switch with a switch

The control switch can be overridden by a further switch, so that e.g. in certain flight situations the function to be triggered can be activated independently of the control position and thus the position of the control switch.

Change to the value field in the 5th column, the column above the rightmost switch symbol. In the simplest case, select one of the switches mounted in the two switch panels, as described in the section "Assigning transmitter controls, switches and control switches" on page 56. The number of this switch, e.g. "10", appears on the display in the next-to-the last column at the right, together with a switch icon indicating the switch's current state.

While this switch is open, the "C1" control switch is active, i.e. it triggers at the switching point; if the switch is closed, the control switch now remains permanently closed as well, independently of the control position and switching direction:

| CONTROL SWITCH | | | | | |
|----------------|--------|------|-----|------|------|
| ▶C1 | Lever1 | +85% | <= | 10 | C1 |
| C2 | free | 0% | => | ---- | C2 † |
| C3 | free | 0% | => | ---- | C3 † |
| C4 | free | 0% | => | ---- | C4 † |
| ▼ | SEL | STO | SEL | ↘ | |

Combining two control switches

For more complex applications, however, it can prove necessary to override this control switch with a second control switch.

Example:

Control switch "C1" will now be assigned to control function 3 (= control 3) instead of its previous

assignment "Lever1". The switching point is at its center point, i.e. at 0%. The switch chosen in the next-to-the-last right column is "C2" from the list of expanded switches. This "C2" control switch will now be allocated in its own line to the middle proportional slider "Slide2", whose switch-point is +50% liege:

| CONTROL SWITCH | | | | | |
|----------------|--------|------|-----|------|------|
| C1 | Cnt. 1 | 0% | <= | C2 | C1 |
| ▶C2 | Slide2 | +50% | => | ---- | C2 |
| C3 | free | 0% | => | ---- | C3 † |
| C4 | free | 0% | => | ---- | C4 † |
| ▼ ▲ | SEL | STO | SEL | ↘ | |

The switching directions indicated in the fourth column from the left will now show control switch "C2" as being closed as long as joystick (control 3) and/or "Slide 2" are located on the other side of their switch-points.

This diversity of switching options certainly offers you enough scope for specialized applications to suit any type of model.

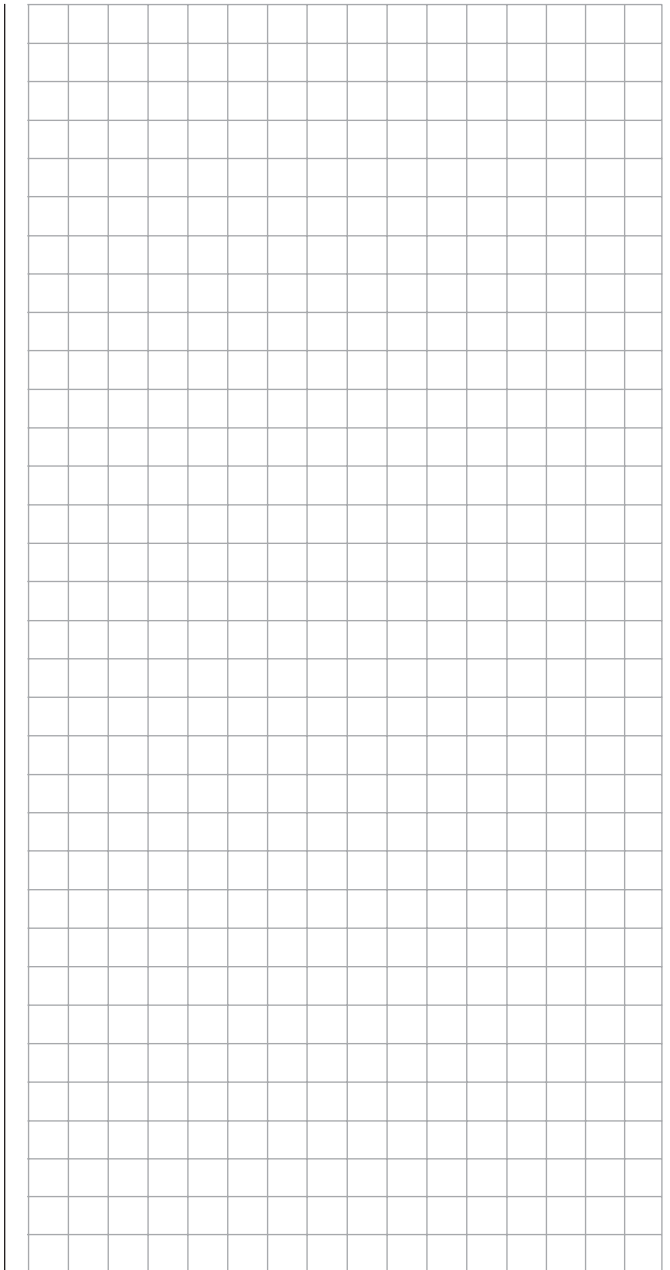

Logical switches

Programming logical switches

Use the selection keys on the left or right touch pad to scroll to the »**Control switch**« option in the multi-function menu:

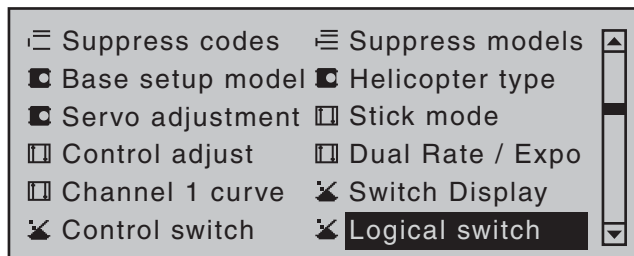
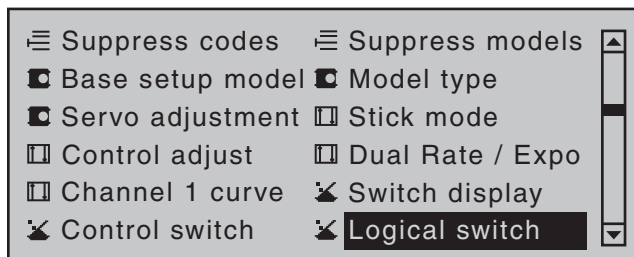

Open this menu option with a tap on the center **SET** key of the right touch pad.

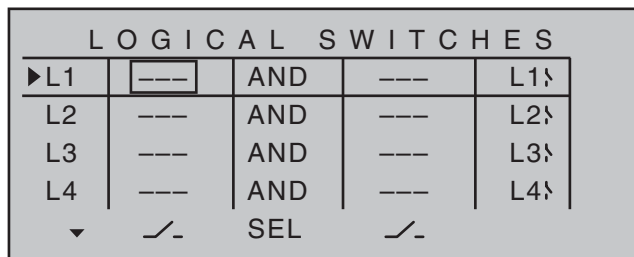

These functions permit two switches, control switches and/or logical switches or any combination of these to be combined with one another to create logical "AND" and "OR" functionality. A total of 8 logical switches, "L1 ... L8" can be programmed.

The result of such a logical switch function—shown in the display's rightmost column—can be used as another switch function. Allocation of a switch to a logical function is done in the familiar manner in

the columns labeled by the two switch symbols, as described in the section "Assigning transmitter controls, switches and control switches" on page 56. That is, by moving the respective switch from OFF to ON or, after a tap on the center SET key of the right touch pad, by selecting one of the expanded switches with the selection keys.

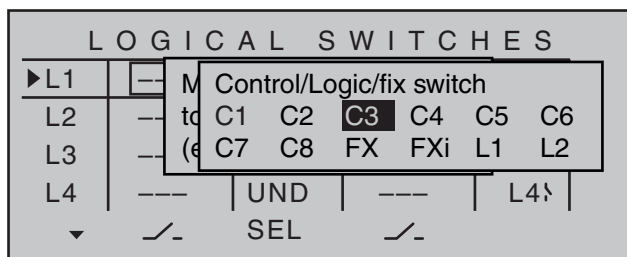
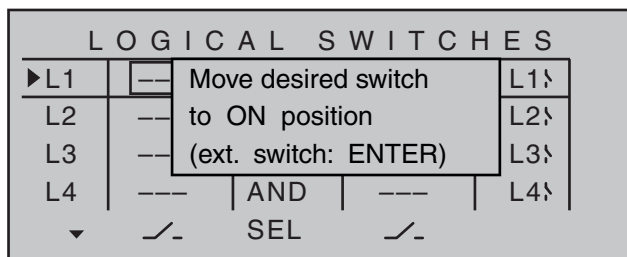

Potential applications for this:

- Multiple functions, which are normally independent of one another, are to be put into a defined state by way of an »Emergency switch«.
- The establishment of dependencies for initiating a switch-on warning, see »**Basic settings, model**« menu.

"AND" / "OR"

Once a given value field has been activated in the column labeled **SEL**, the "AND" and "OR" logic operator can be selected with the selection keys.

"AND" function: The logical switch is only closed when both input switches are closed.

"OR" function: The logical switch is closed when at least one of the input switches is closed.

Note:

The difference between AND and OR logic switches is made clear by the settings and input states of the display figure below.

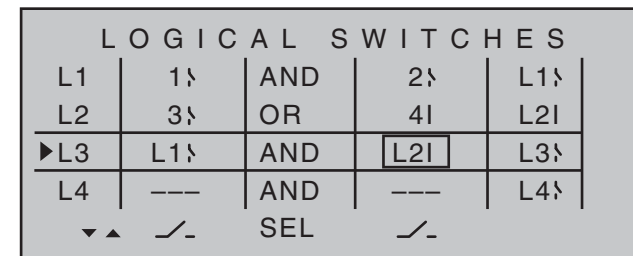

"L3" is only closed when both the "L1" and "L2" switches are closed. This means that both switches, 1 and 2, must be closed and, at the same time, either 3 or 4.

In order to make these logical switches usable, they can be specified in those menus which use switches by calling them up via the additional "expanded switches" selection menu.

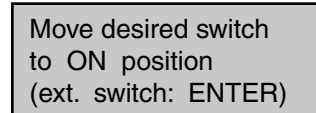

A brief tap on the center **SET** key of the right touch pad will afford access to the expanded switches.

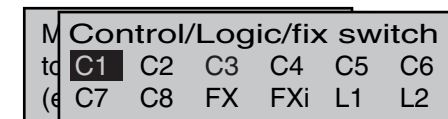

Now use the selection keys to pick the desired control switch "C1 ... C8", fixed switch "FX" or logical switch "L1 ... L8" or the respected inverted switch "C1i ... C8i", "FXi" or "L1i ... L8i", for example, "L3i":

| | |
|----|--------------------------------|
| M | Control/Logic/fix switch |
| to | C7i C8i L1i L2i L3i L4i |
| (e | L5i L6i L7i L8i |

A brief tap on the center **SET** key of the right touch pad will adopt the selected switch into the menu.

| | | |
|----------------------|-------------|------------|
| Model time | 12:34h | --- |
| Batt. time | 1:23h | |
| Top : Stop watch | 0:00 0s | L3I |
| ► Centr: Flight time | 0:00 0s | L3I |
| ▼ ▲ | Timer Alarm | ↙ - |

Remark about inverted switches:

Selection of an inverted switch for a switch assignment, e.g "L1i" instead of "L1", simply specifies the opposite switch direction (state), i.e. non-inverted usage results in a certain switch activating a particular function when it is in its switched-on state but inverted usage results in a certain switch activating a particular function when it is in its switched-off state. Such applications arise when, for example, one and the same switch is to switch one function on but, at the same time, it is to switch a second function off, and vice versa. Logical switches permit other, quite complex, switching options to be created.

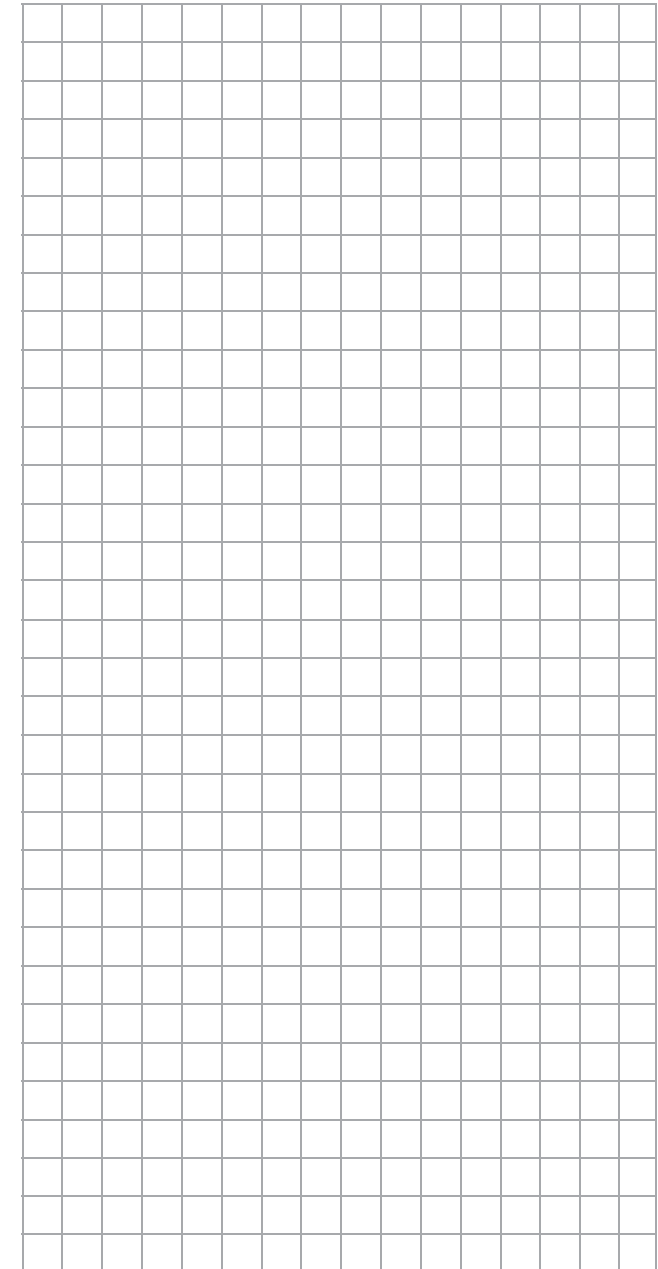
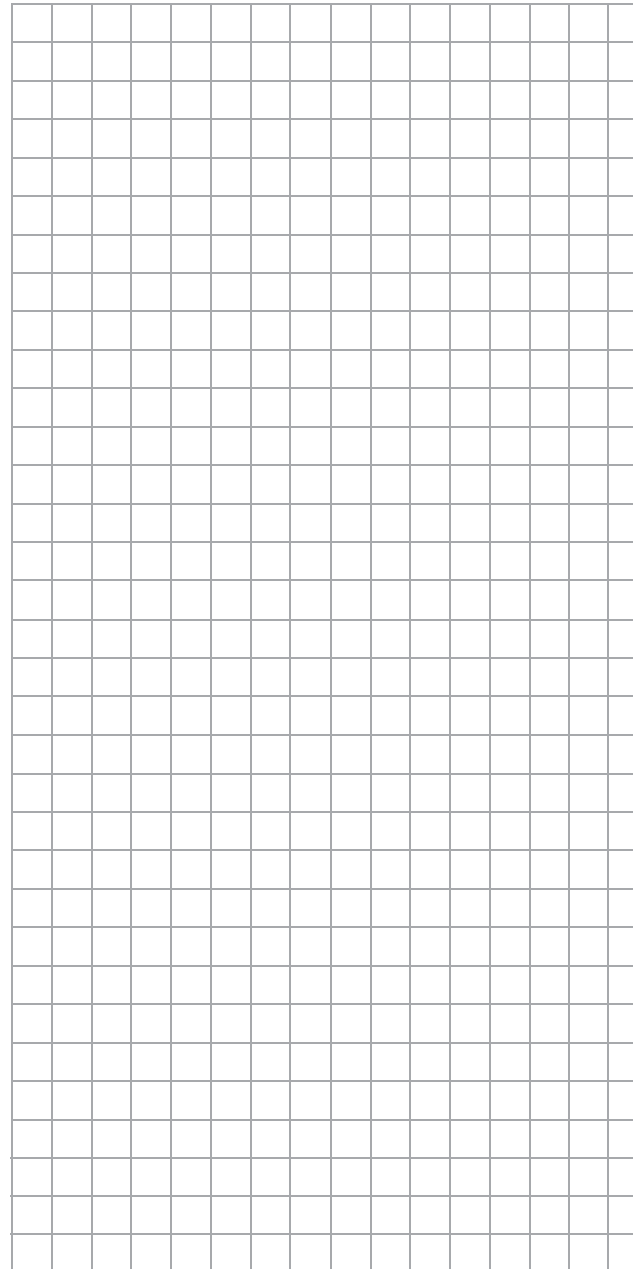

How is a flight phase programmed?

The concept of flight phase programming

General information on flight phase programming

During a flight, you will often want to apply different settings – e.g. flap or trim settings for a fixed-wing aircraft or collective pitch and throttle servo settings for a helicopter – at particular times in the flight (e.g. take-off, approach, hover, auto-rotate, etc.). With **FLC-20** HoTT, you can access such presets automatically using switches or control switches.

Flight phases are also of great utility during flight testing. You can configure various set-ups and then switch between them during the flight: this enables you to identify the most appropriate program set-up for your model quickly and easily.

The basic programming procedure is a three-stage process

1. First, you have to set up the different flight phases, i.e. you assign names to phases 1 ... max. 8. Each name is then shown in all phase-specific menus and also on the basic display. To avoid abrupt transitions when switching between the various phases, you can also program a period of time during which a "soft" transition to the next phase takes place.
For fixed-wing aircraft programs, these settings are made in the **»Phase settings«** menu. The programming of helicopters begins with either the **»Basic settings, model«** menu, if you wish to set up autorotation or, otherwise, with the **»Phase settings«** menu.
2. In the second stage, you use the **»Phase assignment«** menu to set up the required "phase switches".
3. Once these are set, you can then move to the flight phase-dependent menus (see the tables below) to start programming the settings for the individual flight phases.

List of flight phase-relevant menus for fixed-wing programs:

| Menu | Page |
|-------------------------------|------|
| »Control adjust« | 108 |
| »Dual Rate / Expo« | 120 |
| »Channel 1 curve« | 128 |
| »Phase settings« | 142 |
| »Phase assignment« | 148 |
| »Phase trim« | 150 |
| »Non-delayed channels« | 151 |
| »Flight phase timers« | 156 |
| »Wing mixers« | 160 |
| »MIX active/phase« | 204 |
| »Trim memory« | 224 |

List of flight phase-relevant menus for helicopter programs:

| Menu | Page |
|-------------------------------|------|
| »Control adjust« | 112 |
| »Dual Rate / Expo« | 124 |
| »Channel 1 curve« | 131 |
| »Phase settings« | 146 |
| »Phase assignment« | 148 |
| »Non-delayed channels« | 151 |
| »Flight phase timers« | 156 |
| »Helicopter mixer« | 176 |
| »MIX active/phase« | 204 |
| »Trim memory« | 226 |

All other menus are model-specific and thus cannot be programmed separately for each flight phase. Accordingly, changes you make in all other menus apply uniformly to all flight phases for that specific model. In some cases it may be desirable to use the **»Suppress codes«** menu (see page 74) to remove non-alterable menus from the multi-function list while programming flight phases. Two examples of flight phase programming can be found in the text beginning on page 288.

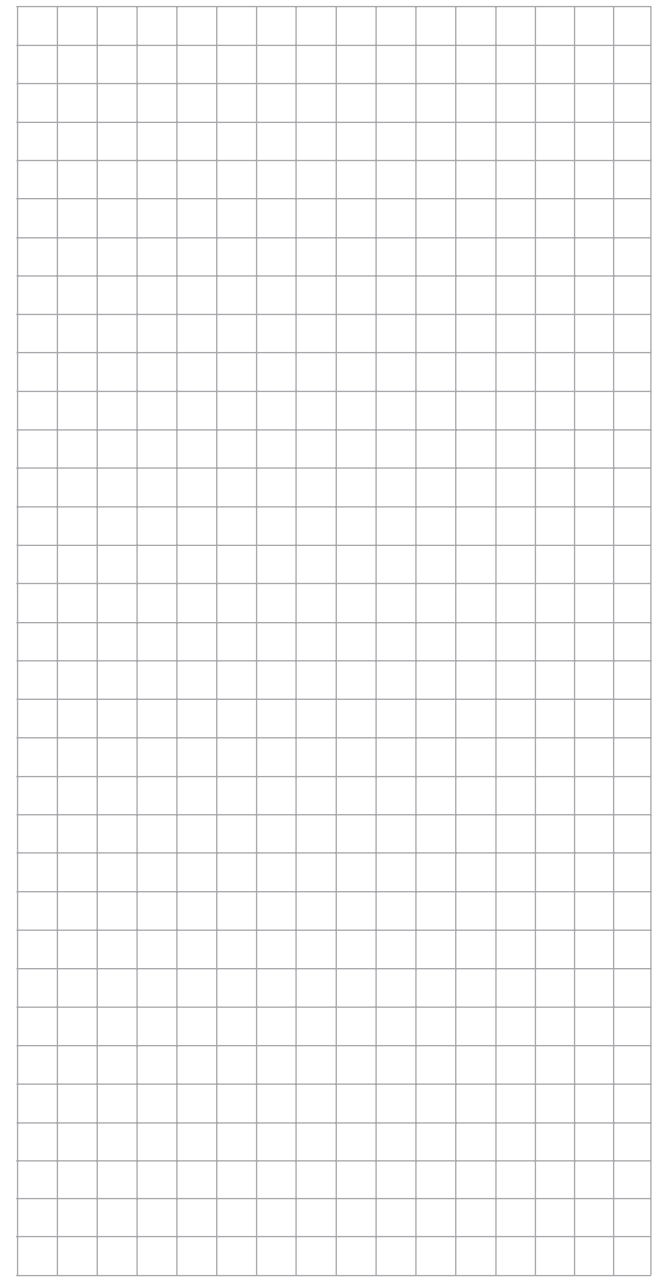
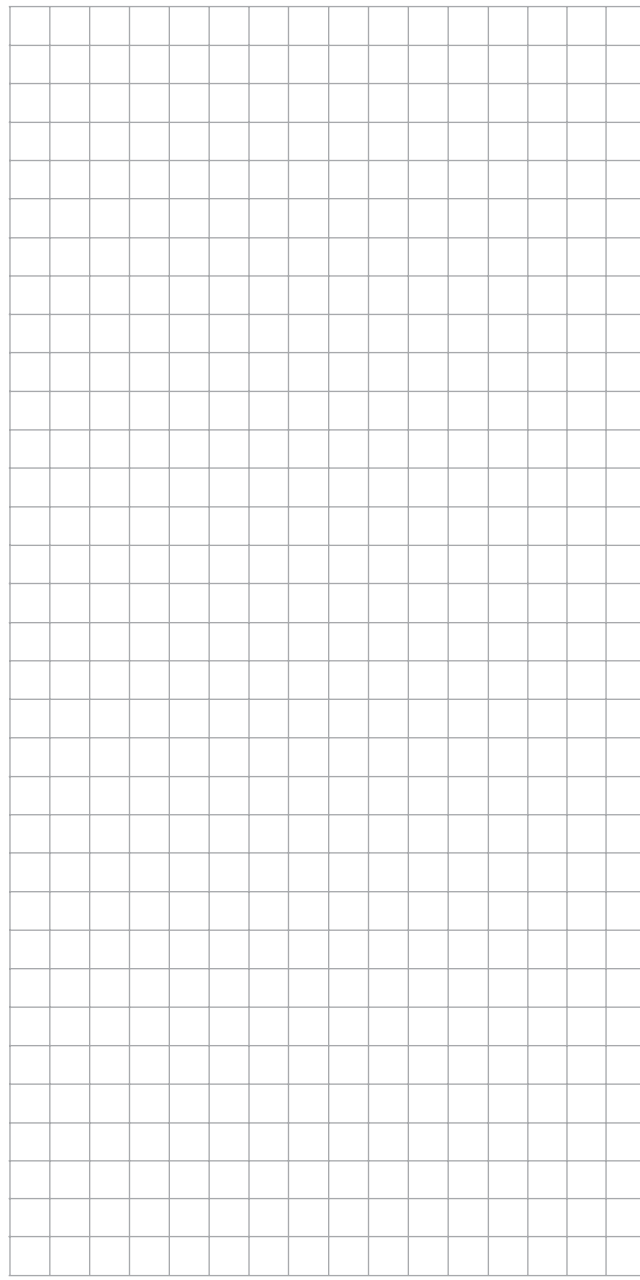
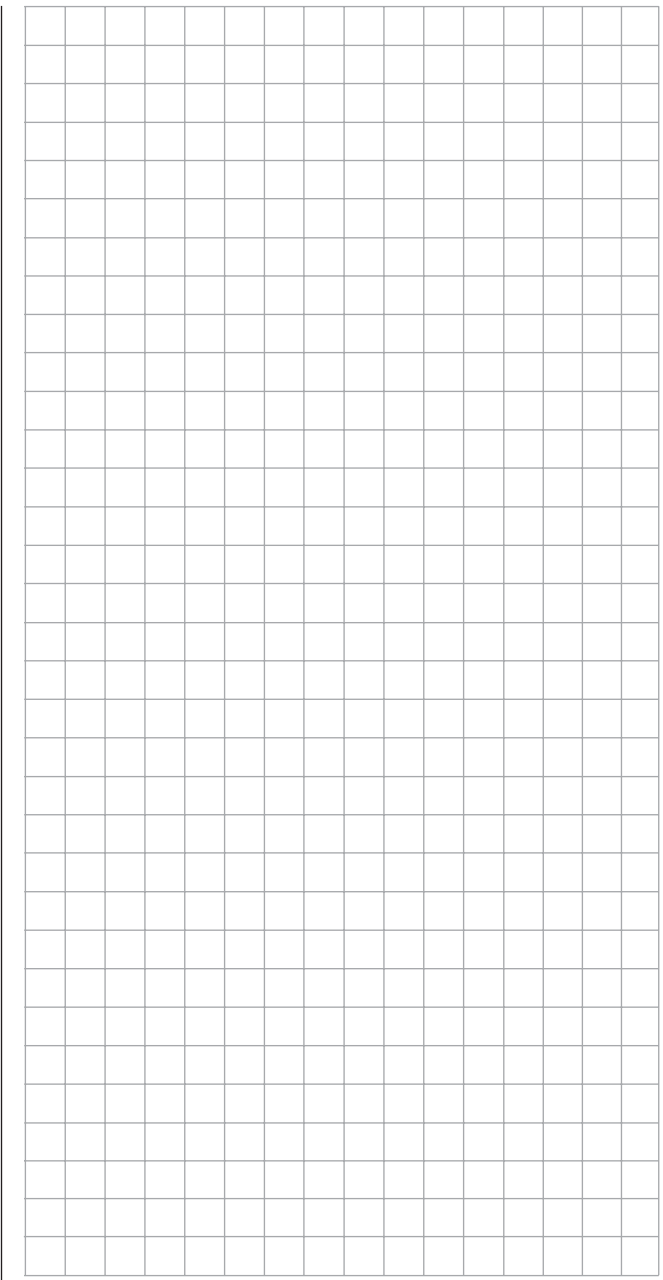

Phase settings

Setting up flight phases

Use the selection keys of the left or right touch pad to scroll to the »**Phase settings**« menu option in the multi-function menu:

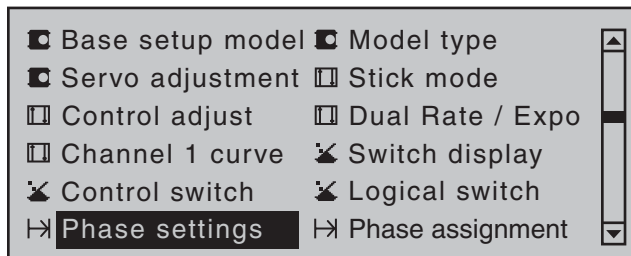

Within one model memory, the **MC-20** HoTT lets you program up to 8 discrete groups of settings for various conditions met during the flight. The grouped settings are typically termed "flight phases" and are programmed in the corresponding menus.

Depending on the setting "Throttle min. forward/back" or "None" in the "Motor on C1" line of the »**Model type**« menu, calling up the »**Phase settings**« menu option will cause the transmitter's display to look like one of the two variants shown below ...

- Motor on C1 "none"

| Phase | Name | Fl.ph.Tim | Sw. time | |
|-----------|------|-----------|----------|---|
| ► Phase 1 | | | 0.1s | * |
| Phase 2 | | | 0.1s | — |
| Phase 3 | | | 0.1s | — |
| Phase 4 | | | 0.1s | — |
| Phase 5 | | | 0.1s | — |

- Motor on C1 "Throttle min front/rear"

| Phase | Name | Timer | Motor | Sw. time | |
|-----------|------|-------|-------|----------|---|
| ► Phase 1 | | yes | | 0.1s | * |
| Phase 2 | | yes | | 0.1s | — |
| Phase 3 | | yes | | 0.1s | — |
| Phase 4 | | yes | | 0.1s | — |
| Phase 5 | | yes | | 0.1s | — |

Setting up flight phases

When you set up flight phases for fixed-wing aircraft models, you start with this menu. You assign individual phases a name and also assign a period of time for a (soft) transition into each phase. Note that—depending on your model and your settings—switch times much longer than the default 0.1 s have proven useful. You can also set up several phases with names and transition times even if you don't currently have a use for them, since the decision as to which of the "occupied" phases you activate is made only on the »**Phase assignment**« menu (page 148) when setting "phase switches".

Whether or not one of the phases 1 ... 8 currently has an assigned switch and the state of the switch can be seen in the "status" column at the far right.

| Symbol | Meaning |
|--------|--------------------------------------|
| — | No switch assigned |
| + | Phase can be accessed via switch |
| * | Indicates the phase currently active |

Note:

The "Copy flight phase" option on the »Copy / Erase« menu is a useful aid when programming the various flight phases. First, you need to determine the parameters for a specific flight phase; these are then copied to the next flight phase, where they can then be modified as appropriate.

"Name" column

Briefly tap on the center **SET** key of the right touch pad then assign the needed phases (phase 1 up to maximum of 8 phases) by picking their names from the selection list with the selection keys of the left or right touch pad. In addition to this standard pool of names, the »**General basic settings**« menu, page 261, permits up to 10 names of personal preference to be defined.

The order in which phases 1 to max. 8 are assigned is entirely irrelevant and you can leave gaps as you wish. Nonetheless, you should always start with "Phase 1", the "Normal phase", which is always active if ...

- ... no phase switch is set in the »**Phase assignment**« menu or if
- no phase has been assigned to specific combinations of switches.

The definition of the phase name "Normal" could therefore be a useful one to adopt for "Phase 1". The names themselves have absolutely no technical significance for programming; their only purpose is to help you to identify which phase is active at any time and are thus displayed in all flight phase-dependent menus and also on the transmitter's basic display.

Column "Fl.ph.Tim" or "Timer"

In addition to the standard timers on the basic screen display, other timers are also available whose settings are configured in the »**Flight phase timers**« menu, page 156.

Clk 1, Clk 2, Clk 3, Lap, Time1, Time2

The flight phase timers "Clk 1 ... 3" plus "Time1" and "Time2" run only in the flight phase to which they have been assigned in this menu. During other flight phases they are stopped (and hidden) and the assigned stop/start switch then has no effect.

The lap counter, once started, continues to run through changes of phase, however, although it can be stopped during any flight phase via the center **ESC** key of the left touch pad.

While you can obviously record lap times using "Lap" and a switch, the two timers "Time1" and "Time2" have the following meaning:

Time 1 This timer will only measure time during which the switch or control switch assigned in the "Lap time/Tim tab" line of the »**Flight phase timers**« menu, page 156, is "closed". The frequency at which the switch is activated is shown on the

basic display. This counter field is highlighted as soon as the switch for the "Time1" timer is "opened", i.e. the timer is stopped:

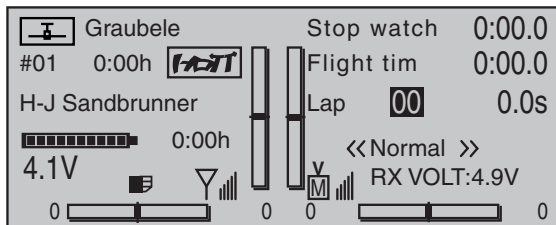

When necessary, the selection keys can be used to access and read the sequence of switching times.

Application:

Measurement of e.g. motor switch-on times, if the same switch also actuates the motor.

Time 2 This timer stores both the "off" and the "on" periods for the associated switch, i.e. every switch actuation in either direction will cause a record to be written for the timer, the timer will be reset then starts incrementing by "1" again as time passes.

Each time count can be suspended with the center **ESC** key of the right touch pad, without actuating the switch itself. Activating the switch, in turn, increments the counter by 1 and restarts the "Time 2" timer.

In order to read out the time memory with the selection keys, the "Time 2" timer must first be suspended by using the **ESC** key of the right touch pad.

Application:

In addition to the motor runtimes, for example, the unpowered glide times between these could also be recorded.

A simultaneous tap on the ▲▼ or ◀▶ keys of the right touch pad (**CLEAR**) will reset suspended timers shown in the basic display.

"Motor" column

Note:

This column is only available if "forward/back" is present in the "Motor on C1" line of the »Model type« menu.

| | | | | | |
|----------|--------|-------|-------|----------|---|
| ▶Phase 1 | Normal | | yes | 0.1s | * |
| Phase 2 | Launch | | yes | 0.1s | — |
| Phase 3 | Dist. | | yes | 0.1s | — |
| Phase 4 | | | yes | 0.1s | — |
| Phase 5 | | | yes | 0.1s | — |
| ▼ | Name | Timer | Motor | Sw. time | |

"yes" The motor connected to receiver output 1 will be controlled by the C1 joystick (throttle/brake stick).

The brake system to be set up on the »Wing mixers« menu is deactivated:

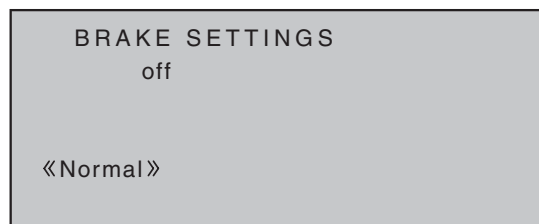

The motor connected to receiver output 1 is decoupled from the C1 joystick (throttle/brake stick) and is held in its OFF position—as specified by the setting "Throttle min. forward / back"—automatically.

The brake system to be set up in the »Wing mixers« menu is activated and is actuated by the C1 joystick.

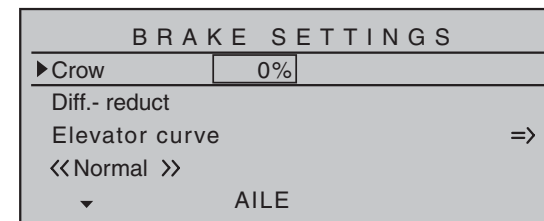

Note:

The settings available depend on the number of control surface servos selected on the line "Ailerons/Camber-changing flaps in the »Model type« menu.

"Sw. time" column

When you switch between flight phases, it is advisable to use this column to program a switch time for a "soft" transition INTO (!) the respective phase. Accordingly, there is also an option for specifying a different time for the switchover from any phase to, for example, Phase 3 than for a switchover to Phase 1.

Use the ▶ selection key of the left or right touch pad to move the marker frame to the right beyond the column labeled "Timer" and, if applicable, also the column labeled "Motor".

| | | | | | |
|----------|--------|-------|-------|----------|---|
| ▶Phase 1 | Normal | | yes | 0.1s | * |
| Phase 2 | Launch | | yes | 0.1s | — |
| Phase 3 | Dist. | | yes | 0.1s | — |
| Phase 4 | | | yes | 0.1s | — |
| Phase 5 | | | yes | 0.1s | — |
| ▼ | Name | Timer | Motor | Sw. time | |

Following a brief tap on the center **SET** key of the right touch pad, the switchover time value in the field displayed in inverse video can be changed within a range of 0 and 9.9 s.

Example:

| | | | | | |
|-----------|--------|-------|-------|----------|---|
| Phase 1 | Normal | | yes | 0.1s | * |
| Phase 2 | Launch | | yes | 0.1s | - |
| ▶ Phase 3 | Dist. | | yes | 1.1s | - |
| Phase 4 | | | yes | 0.1s | - |
| Phase 5 | | | yes | 0.1s | - |
| ▼ | Name | Timer | Motor | Sw. time | |

The switchover time from any other phase to Phase 1 «normal» will take 2.2 s.

The time for a switchover from, for example, Phase 1 to Phase 3, is set to 1.1 s and the time for a switchover from Phase 1 or 3 to Phase 2 "Launch" is 1.5 s.

Such asymmetric transition times can be useful when, e.g. switching between extremely different flight phases, such as between aerobatics and normal flight.

A simultaneous tap on the ▲▼ or ◀▶ keys of the right touch pad (**CLEAR**) will reset the time in the currently active value field back to 0.1.

Note:

The "switch time" set here applies uniformly to all settings that are specific to flight phases, and thus to all mixers activated in the »Wing mixers« menu, see page 160. Accordingly, the transition between flight phase-specific mixers does not occur abruptly. However, if individual servos are to be switched without a delay then these can be defined accordingly in the »Non-delayed chan« menu (see page 151).

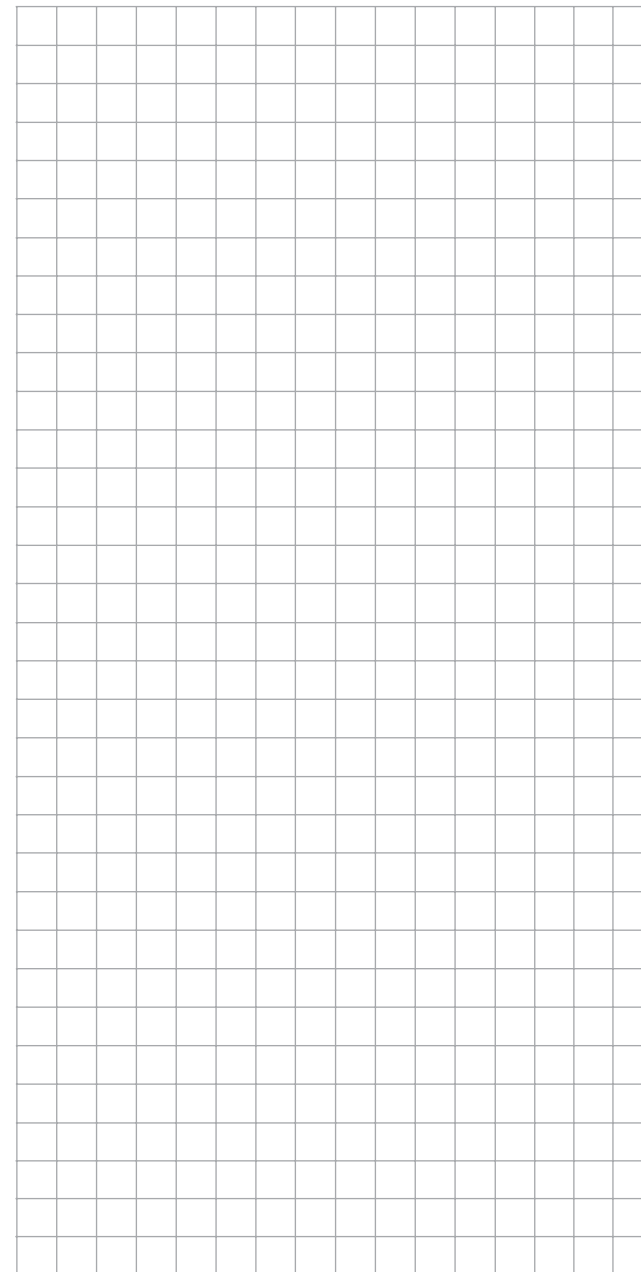
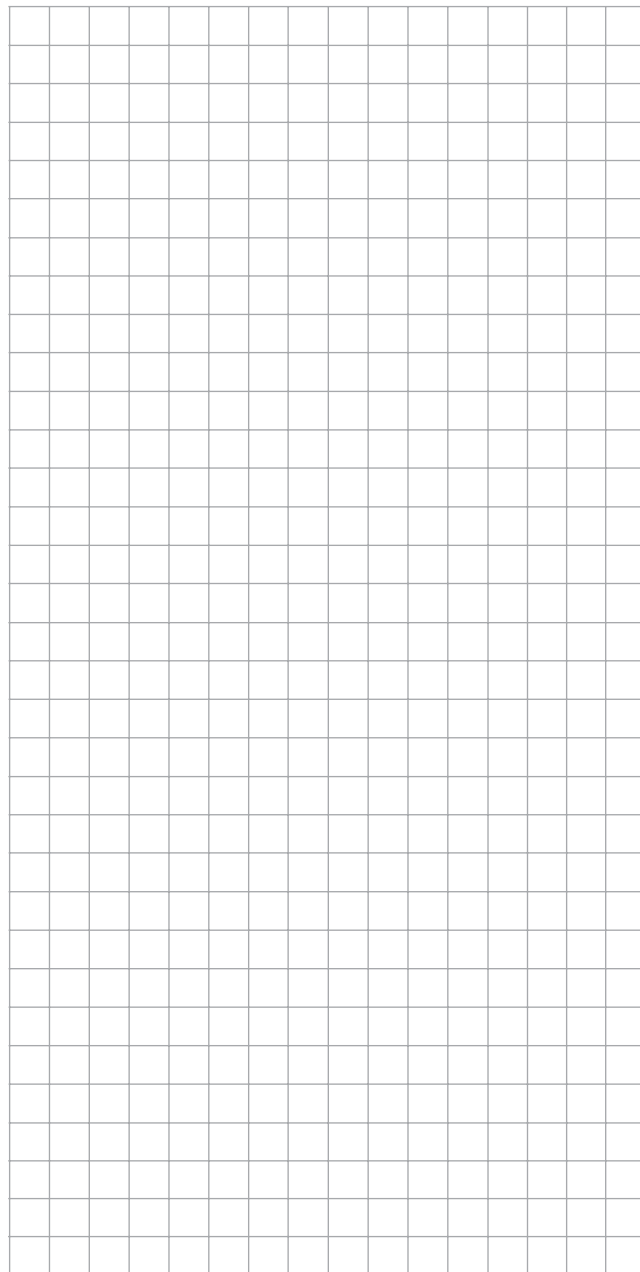

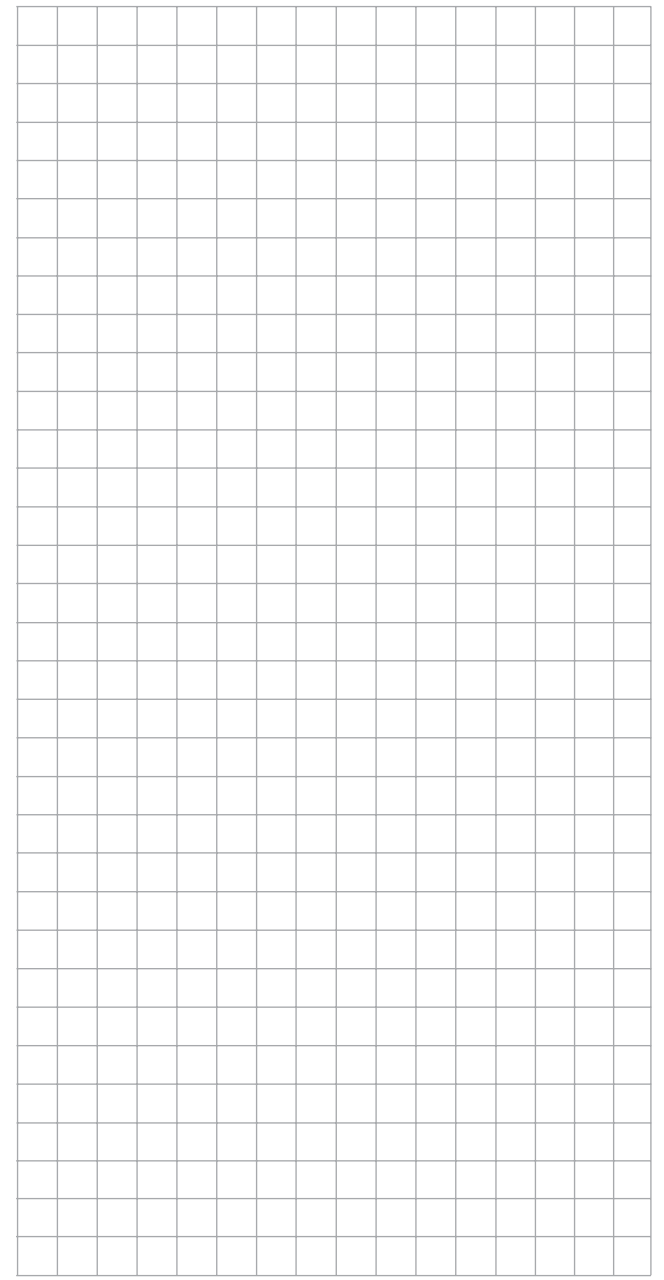
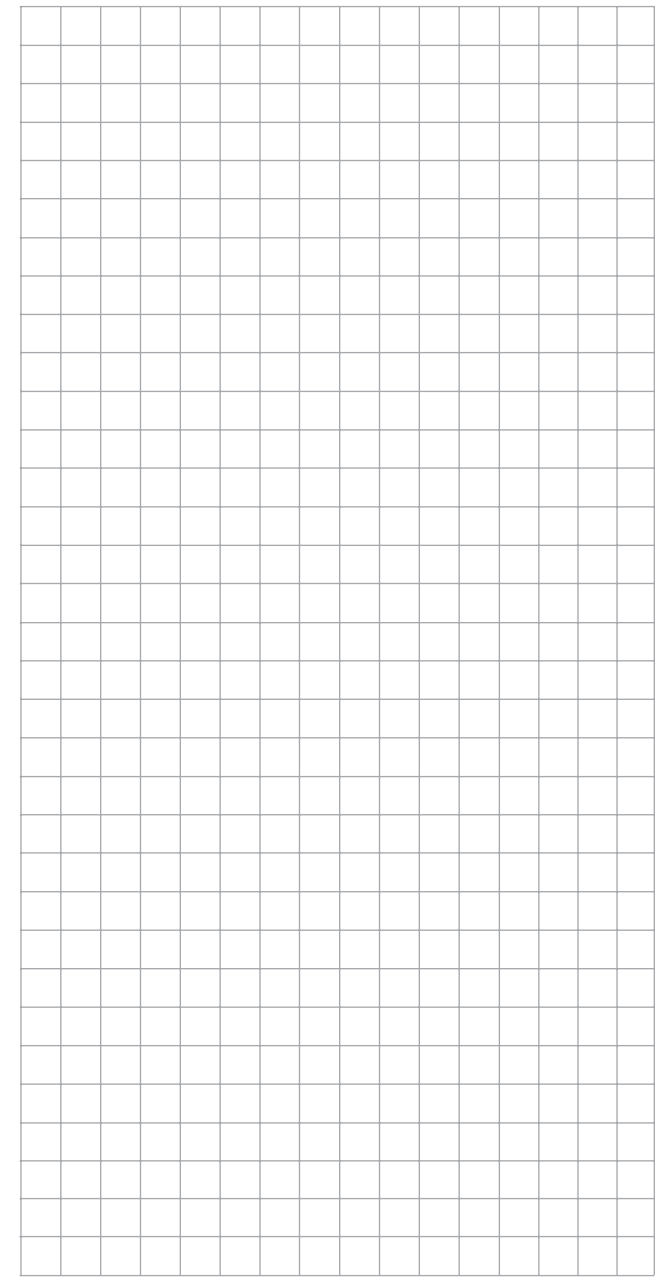
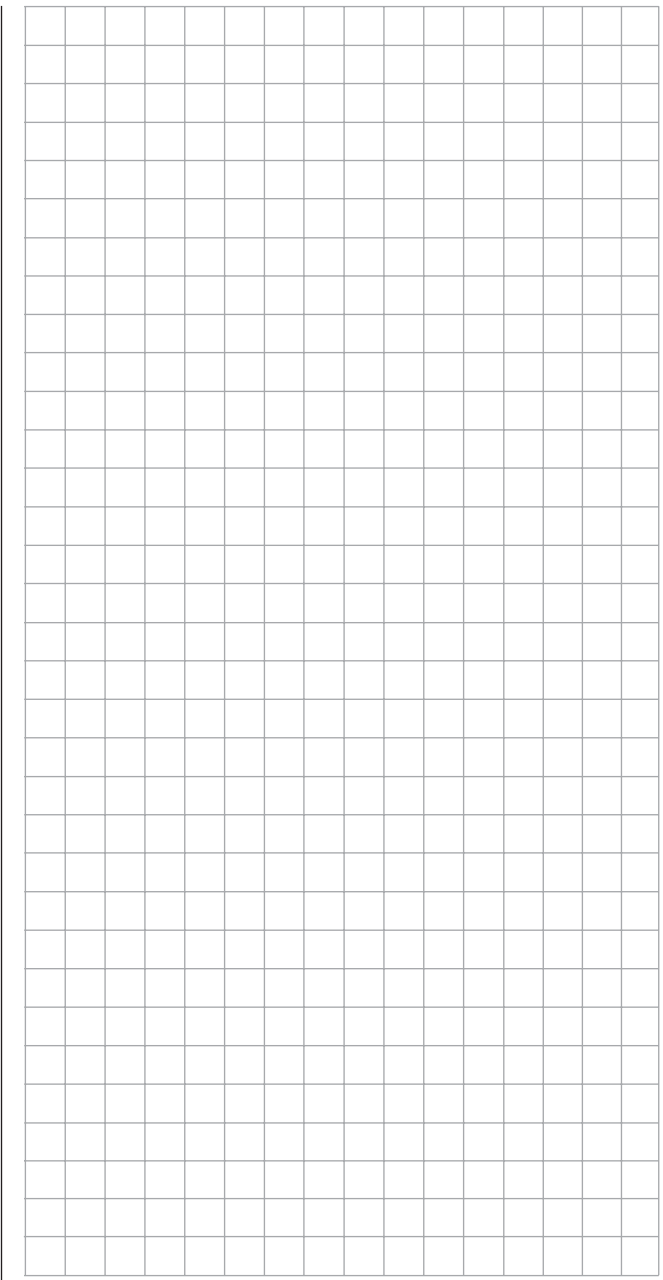

Phase settings

Setting up flight phases

Use the selection keys of the left or right touch pad to scroll to the »**Phase settings**« menu option in the multi-function menu:

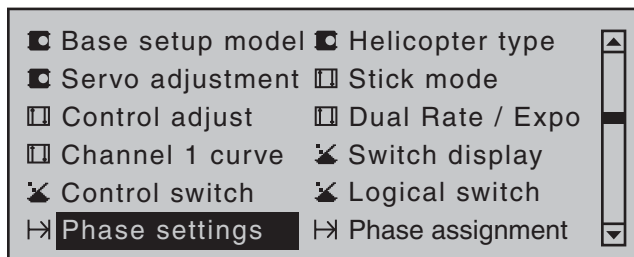

Open this menu option with a tap on the center **SET** key of the right touch pad.

| ▶ Autorot | Autorot | | 0.1s → | * |
|-----------|---------|------------|---------|---|
| Phase 1 | | | 0.1s | – |
| Phase 2 | | | 0.1s | – |
| Phase 3 | | | 0.1s | – |
| Phase 4 | | | 0.1s | – |
| ▼ | Name | Fl.ph.Tim. | Sw.time | |

Within one model memory, the **MC-20** HoTT lets you program up to 7 discrete groups of settings for various conditions met during the flight. These are in addition to the auto-rotation flight phase that can be set up in the »**Basic settings, model**« menu. The grouped settings are typically termed "flight phases" and are programmed in appropriate menus.

Setting up flight phases

When you set up flight phases for helicopter models, you start with this menu. You assign individual phases a name and also assign a period of time for a (soft) transition into each phase. Note that—depending on your model and your settings—switch times much longer than the default 0.1 s have proven useful. You can also set up several phases with names and transition times even if you don't currently have a use for them, since the decision as to which of the

"occupied" phases you activate is made only on the »**Phase assignment**« menu (page 148) when setting "phase switches".

The "Status" column, second from the left, shows which one of the phases 1 ... 7, including the autorotation phase this is 8, has already been assigned to a switch, plus the current status of that switch:

| Symbol | Meaning |
|--------|--------------------------------------|
| – | No switch assigned |
| + | Phase can be accessed via switch |
| * | Indicates the phase currently active |

Note:

The "Copy flight phase" option on the »**Copy / Erase**« menu is a useful aid when programming the various flight phases. First, you need to determine the parameters for a specific flight phase; these are then copied to the next flight phase, where they can then be modified as appropriate.

"Name" column

The first line, and thus the first flight phase, is reserved for autorotation flight, see »**Basic settings, model**« menu. Accordingly, the predefined name cannot be changed.

Use the selection keys to move to the line "Phase 1". Briefly tap on the center **SET** key of the right touch pad then assign the needed phase (phase 1 up to maximum of 7 phases) by picking the respective name from the selection list with the selection keys of the left or right touch pad. In addition to this standard pool of names, the »**General basic settings**« menu, page 261, permits up to 10 names of personal preference to be defined.

The order in which phases 1 to max. 7 are assigned is entirely irrelevant and you can leave gaps as you wish. Nonetheless, you should always start with "Phase 1", the "Normal phase", which is always active if ...

- ... no phase switch is set in the »**Phase assignment**« menu or if
- no phase has been assigned to specific combinations of switches.

The definition of the phase name "Normal" could therefore be a useful one to adopt for "Phase 1". The names themselves have absolutely no technical significance for programming; their only purpose is to help you to identify which phase is active at any time and are thus displayed in all flight phase-dependent menus and also on the transmitter's basic display.

"ph. Tim." column

In addition to the standard timers on the basic screen display, other timers are also available whose settings are configured in the »**Flight phase timers**« menu, page 156.

Clk 1, Clk 2, Clk 3, Lap, Time1, Time2

The flight phase timers "Clk 1 ... 3" plus "Time1" and "Time2" run only in the flight phase to which they have been assigned in this menu. During other flight phases they are stopped (and hidden) and the assigned stop/start switch then has no effect.

The lap counter, once started, continues to run through changes of phase, however, although it can be stopped during any flight phase via the center **ESC** key of the left touch pad.

While you can obviously record lap times using "Lap" and a switch, the two timers "Time1" and "Time2" have the following meaning:

Time1 This timer will only measure time during which the switch or control switch assigned in the "Lap time/Tim tab" line of the »**Flight phase timers**« menu, page 156, is "closed". The frequency at which the switch is activated is shown on the basic display. This counter field is highlighted as soon as the switch for the "Time1" timer is "opened", i.e. the timer is stopped:

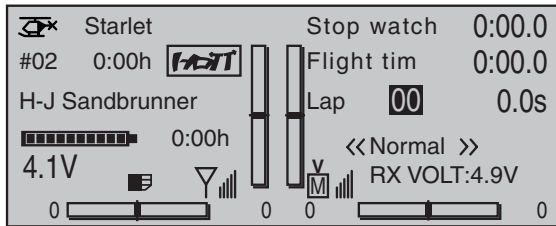

When necessary, the selection keys can be used to access and read the sequence of switching times.

Application:

Measurement of (e.g.) flight phases with increased motor speed, if the same switch is used to actuate flight phase switching.

Time2 This timer stores both the "off" and the "on" periods for the associated switch, i.e. every switch actuation in either direction will cause a record to be written for the timer, the timer will be reset then starts incrementing by "1" again as time passes.

Each time count can be suspended with the center **ESC** key of the right touch pad, without actuating the switch itself. Activating the switch, in turn, increments the counter by 1 and restarts the "Time2" timer.

In order to read out the time memory with the selection keys, the "Time2" timer must first be suspended by using the **ESC** key of the right touch pad.

A simultaneous tap on the ▲▼ or ◀▶ keys of the right touch pad (**CLEAR**) will reset suspended timers shown in the basic display.

"Sw. time" column

When you switch between flight phases, it is advisable to use this column to program a switch time for a "soft" transition INTO (!) the respective phase. Accordingly, there is also an option for specifying a

different time for the switchover from any phase to, for example, Phase 3 than for a switchover to Phase 1.

However, for reasons of safety, transition into the autorotation flight phase should **ALWAYS** be set to switch without any time delay. The arrow "->" in the column labeled "Sw.time" at the end of the "Autorot" line indicates that a delay can be set when transitioning FROM (!) autorotation INTO (!) another phase.

Use the ▶ selection key of the left or right touch pad to move the marker frame to the right beyond the "Sw.time" column.

| ▶ Autorot | Autorot | | 0.1s -> | * |
|-----------|---------|------------|---------|---|
| Phase 1 | | | 0.1s | - |
| Phase 2 | | | 0.1s | - |
| Phase 3 | | | 0.1s | - |
| Phase 4 | | | 0.1s | - |
| ▼ | Name | Fl.ph.Tim. | Sw.time | |

Following a brief tap on the center **SET** key of the right touch pad, the switchover time value in the field displayed in inverse video can be changed within a range of 0 and 9.9 s.

Example:

| ▶ Autorot | Autorot | | 5.5s -> | * |
|-----------|---------|------------|---------|---|
| Phase 1 | Normal | | 3.0s | + |
| Phase 2 | Hover | | 2.0s | + |
| Phase 3 | Speed | | 4.0s | - |
| Phase 4 | | | 0.1s | - |
| ▼ | Name | Fl.ph.Tim. | Sw.time | |

A delay of 5.5 s applies when switching FROM auto-rotation into any other phase. A delay of 0.0 s always applies when switching TO auto-rotation.

The switchover time from any other phase to Phase 1

«normal» will take 3.0 s.

When switching from e.g. Phase 1 to Phase 3, the switch time is set to 4.0 s.

Such asymmetric transition times can be useful when, e.g. switching between extremely different flight phases, such as between aerobatics and normal flight. A simultaneous tap on the ▲▼ or ◀▶ keys of the right touch pad (**CLEAR**) will reset the time in the currently active value field back to 0.1.

Note:

The "switch time" set here applies uniformly to all settings that are specific to flight phases, and thus to all mixers activated in the »Wing mixers« menu, see page 160. Accordingly, the transition between flight phase-specific mixers does not occur abruptly. If you want individual servos to be switched without a delay, however, define these accordingly in the »Non-delayed channels« menu (see page 151).

Phase assignment

Setting up flight phases

Use the selection keys of the left or right touch pad to scroll to the »Phase assignment« menu option in the multi-function menu:

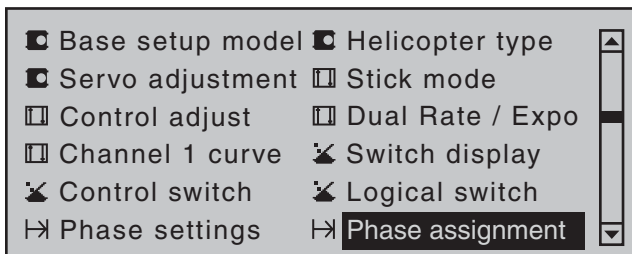
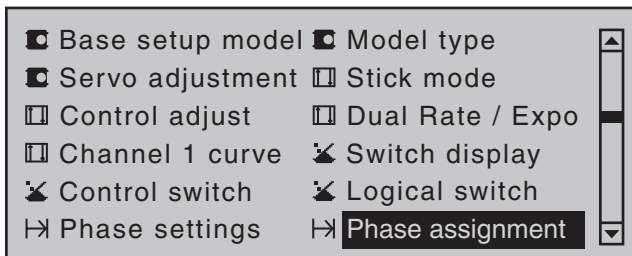

Open this menu option with a tap on the center **SET** key of the right touch pad.



Note:

A phase name appears to the right of the phase number at the bottom right of the display only if you have assigned the name beforehand on the »Phase settings« menu.

In the »Phase settings« menu, described above separately for fixed-wing and helicopter models, you

will have set up names for your phases. On this menu – which is identical for both model types – you must now specify the switches or switch combinations that you want to use to trigger each phase. One exception for helicopter menu: one of the two auto-rotation switches must be set on the menu »Basic settings, model«.

Please note the following priorities:

- If *no* flight phase switches nor these names have been assigned in this menu, the model is in flight phase "1". Accordingly, by the time you start programming flight phases, you should therefore have already given this flight phase the phase name "Normal".
- Independent of the phases with allocated switch settings made *in this menu*, the autorotation phase (only present for the "Helicopter" model type and to be assigned a switch in the »Basic settings, model« menu) always (!) takes precedence. Accordingly, as soon as the auto-rotation switch in question is activated, the following warning appears:

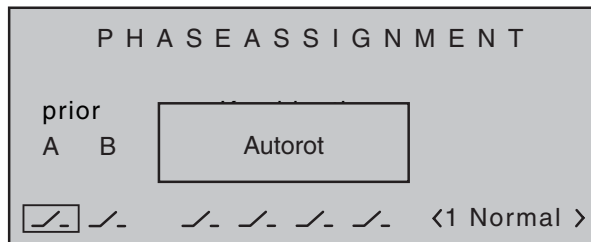

- Phase switch "A" is given priority over all subsequent switch positions, from "B" to "F"
- Phase switch "B" is given priority over all subsequent switch positions, from "C" to "F"
- 3-way switches should *always* be assigned from the middle position.

Therefore use switch "A" and/or switch "B" only if you wish to change from any other flight phase – apart

from the helicopter's autorotation phase – directly into the phase that is assigned to this switch.

Programming flight phase switches

Once you have configured your desired switch position, "A" to "F", using the selection keys on the left or right touch pad, a switch (whether a "normal" switch or an expanded switch) is then assigned as described in the section "Assigning transmitter controls, switches and control switches" (page 56). The order in which assignment is made is irrelevant: you must ensure only that you assign what are, for you, the "correct" switches. (In the helicopter program, for example, you should also take care to ensure you do not use this menu to re-assign any auto-rotation switch already assigned on the »Basic settings, model« menu.)

Example: 4 flight phases with phase priority

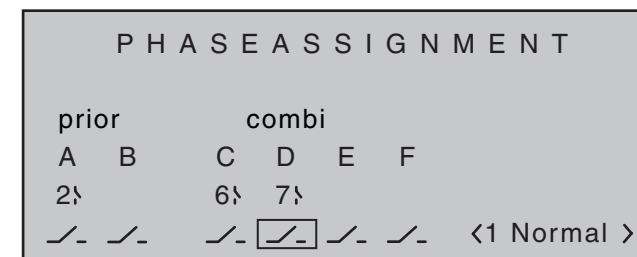

Assigning flight phases to switch positions

Now that names have been assigned to the flight phases (1 ... max. 8) in the »Phase settings« menu and also programmed switches in this menu, but ... at the bottom right of the display screen, you only see <1 Normal > – regardless of the positions the switches are in!?

Use the selection keys on the left or right touch pad to move the marker frame down and to the right and then briefly tap the center **SET** key of the right touch pad:



Now close one (or more, as required) of the switches that you have assigned, and assign one of the flight phase names from the list you selected beforehand on the »Phase settings« menu to this switch position or combination.

Here, for example, we assign the "Launch" phase to the closed ("I") priority switch "A" ...



... if, for example, we wish to switch to this phase regardless of the "C" ... "F" switch positions, because the same switch activates an electric motor, etc.

Use the same approach to set the other switches or combinations of switches.

Theoretically—for the situation where all three are closed—you could use the three single switches shown in the example to define an additional fifth flight phase on the »Phase settings« menu.

However, since this example assumes just four flight phases, you can leave the default phase name as «1 Normal» for this switch position.

Leave this menu in the familiar way, with a tap on the center **ESC** key of the left touch pad.

Tips:

- If you have named more phases than you currently have switches defined for then this is not really problematic. You can repeat and change your switch assignment as you wish at any point in time. And you can also name additional phases at any time and then assign switches to them.
- When assigning switches, check whether the switches are already otherwise assigned to ensure that you avoid duplicate assignments.

Important notice:

Before a phase switch is assigned, the model settings configured are now to be found in the flight phase «1 Normal», i.e. all flight phase-dependent menus are reset to the standard configurations for all other flight phases.

To avoid having to start from scratch in every flight phase, you can copy over these standard settings by using the command "Copy flight phase" on the "Copy / Erase" menu to replace them with flight data obtained from the «Normal» flight phase. You then need only to make further flight phase-specific changes to the settings.

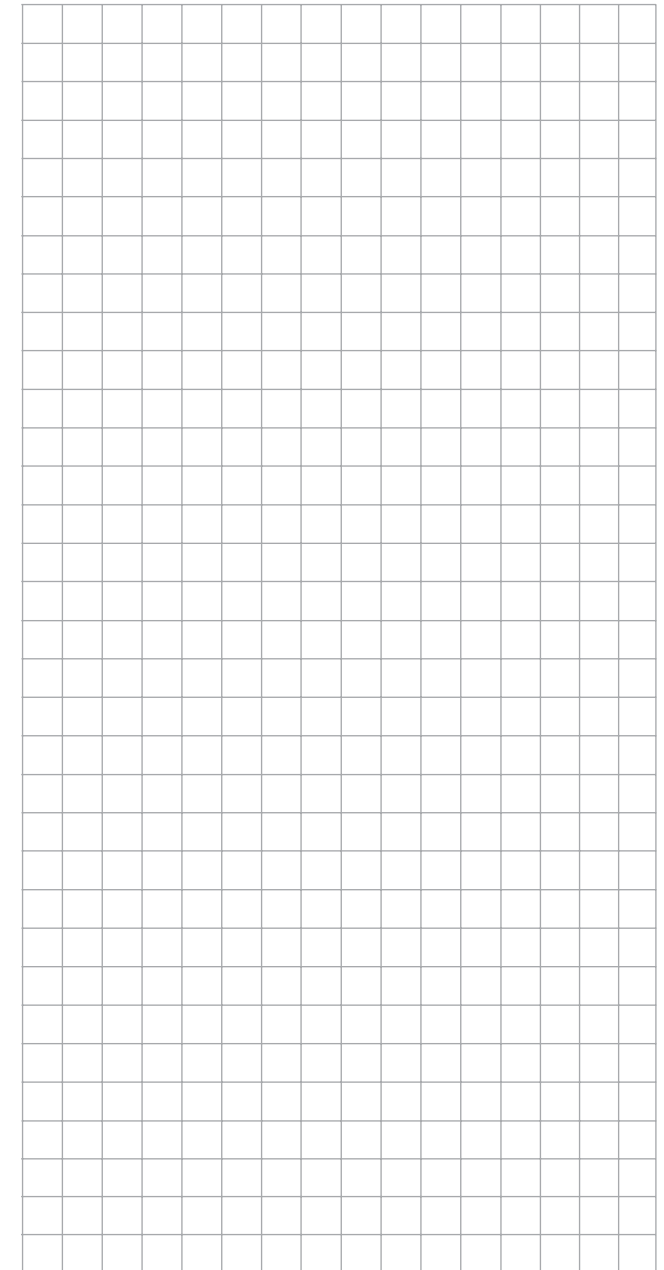

Phase trim

Flap settings specific to flight phases

Use the selection keys of the left or right touch pad to scroll to the »Phase trim« menu option in the multi-function menu:

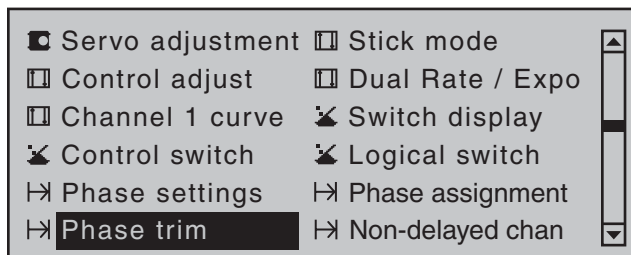

Open this menu option with a tap on the center **SET** key of the right touch pad.

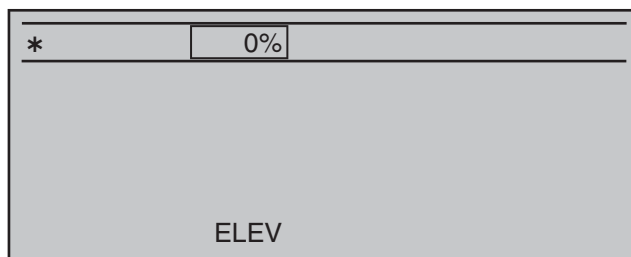

Depending on the settings made on the "Aileron/ camber flaps" line of the »Model type« menu, page 94, and in the »Phase settings« menu, page 142, this menu offers at least one control function for ELEV ...

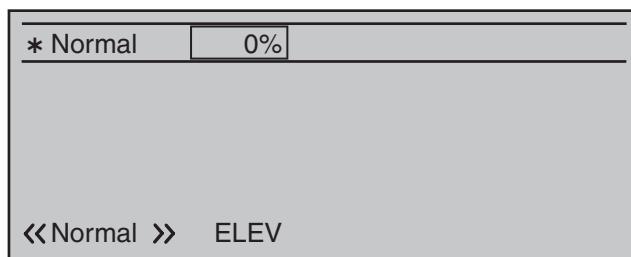

... and, with the maximum of 4 for ELEV, AI, AI2, FL and FL2 a total of five control functions for flight-phase-specific trim settings. The setting of the flight phase switches, to be defined beforehand in the

»Phase assignment« menu, determines the line that is chosen. An asterisk marks the flight phase currently active. At the same time, the name of the respective flight phase is also shown at the bottom left of the screen. You can enter settings only for the currently active flight phase, e.g.:

| | | | | | |
|----------|----|----|----|----|----|
| * Normal | 0% | 0% | 0% | 0% | 0% |
| Launch | 0% | 0% | 0% | 0% | 0% |
| Thermal | 0% | 0% | 0% | 0% | 0% |
| Dist. | 0% | 0% | 0% | 0% | 0% |

<<Normal >> ELEV ▲ AI▲▲ AI2▲ ▲ FL▲▲ FL2▲

In the column labeled "ELEV" a phase-specific elevator trim setting can be stored.

Important notice:

Settings made in this column have an immediate effect on elevator trim and, accordingly, the trim setting display. In turn, the elevator trim control affects the values of this column either "globally" or "phase-specifically", depending on the "global/phase" setting made on the "Elev" line of the »Stick mode« menu.

Columns "AI", "AI2", "FI", "FI2"

The values in these columns (max. 4) are identical to those in the "Fl.pos" (flap position) line on the "Multi-flap menu" within the »Wing mixers« menu. For this reason, any changes made always affect the other menu directly – and vice versa.

After selecting the appropriate column with the selection keys of the left or right touch pad and a brief tap on the center **SET** key of the right touch pad, these values can be entered, independent of one another, with the selection keys within a range of ±150%.

A simultaneous tap on the ▲▼ or ◀▶ keys of the right touch pad (**CLEAR**) will reset a changed value in the currently active value field back to 0%.

Non-delayed channels

Channel-dependent delays to switching

Use the selection keys of the left or right touch pad to scroll to the »Phase trim« menu option in the multi-function menu:

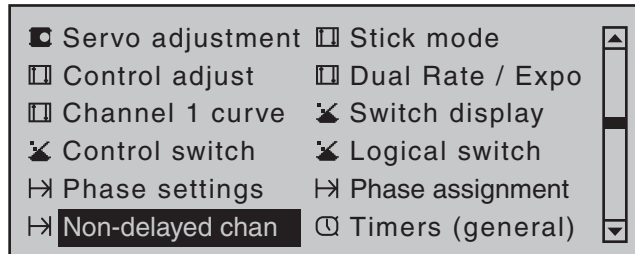
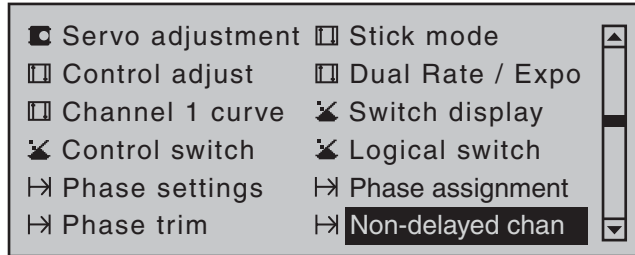

Open this menu option with a tap on the center **SET** key of the right touch pad.

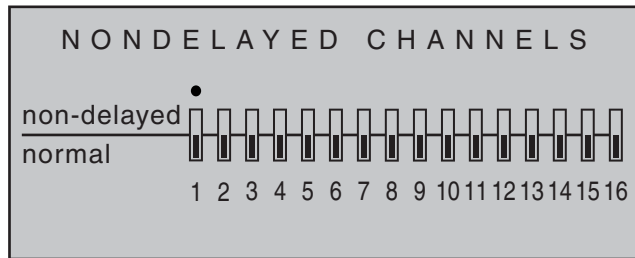

On the »Phase settings« menu, you will have set the necessary switch times for flight phase transitions.

In this menu, you can now deactivate the transition delay set previously, per flight phase and for individual control channels – e.g. for the motor channel for electric models or heading-lock systems for helicopter gyros, etc.

Switch over to the corresponding flight phase. This is shown at the bottom left of the display.

Use the selection keys of the left or right touch pad to move the " " onto the corresponding channel then briefly tap the center **SET** key of the right touch pad. The switch icon changes from "normal" to "non-delay" and vice versa.

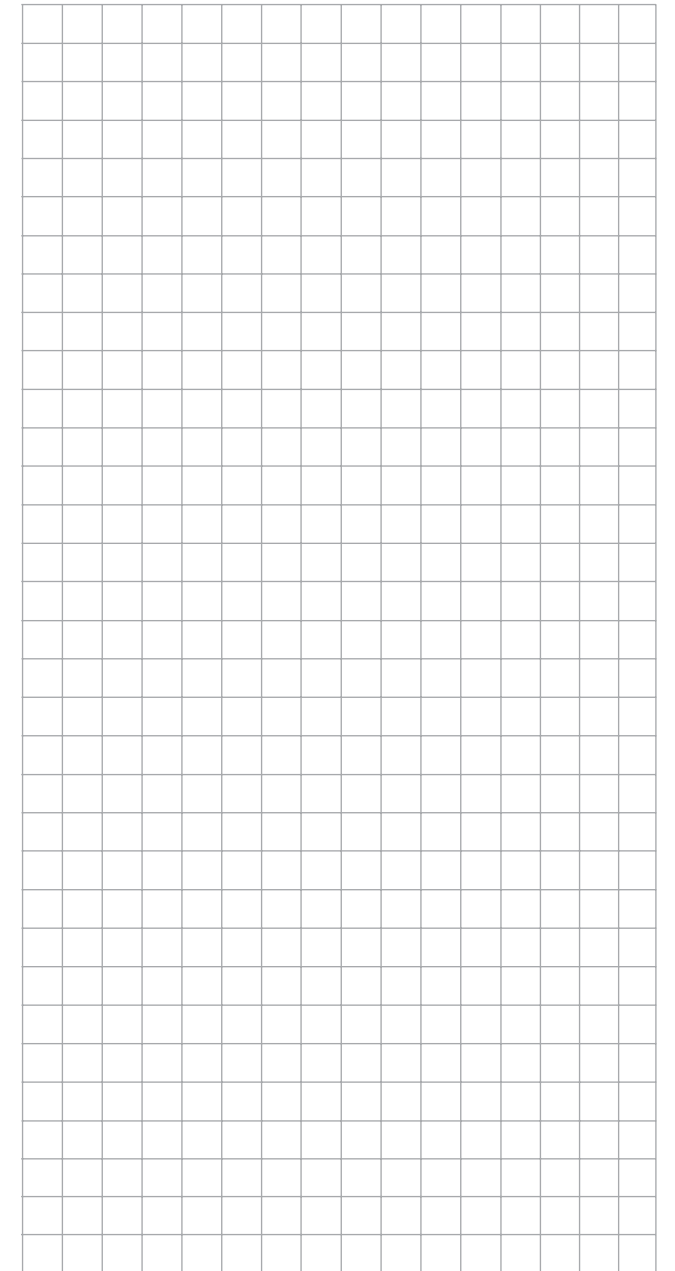
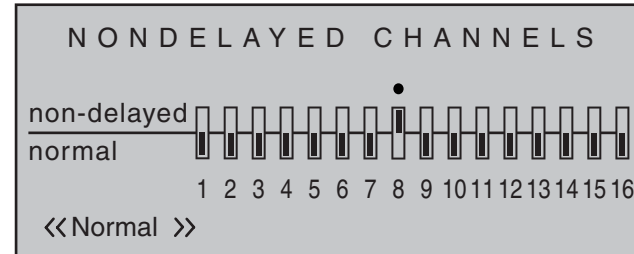

Timers (general)



Timers on the basic display

The default transmitter display shows a total of three timers. These are: the transmitter operating time on the left of the display, plus a "Top" and a "Centr" timer on the right of the display:

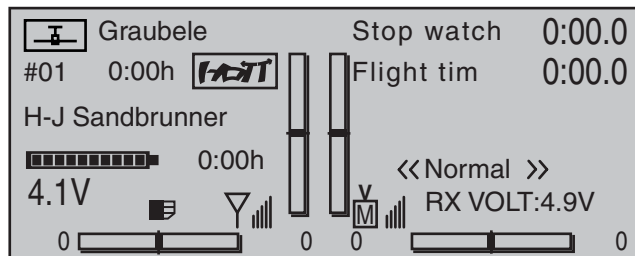

Another, flight-phase specific timer can also be configured with settings in the two menus »**Flight phase timers**«, page 156, and »**Phase settings**«, pages 142 and 146. This optional flight phase timer – such as the lap time timer – appears underneath the "Centr" (flight time) timer:

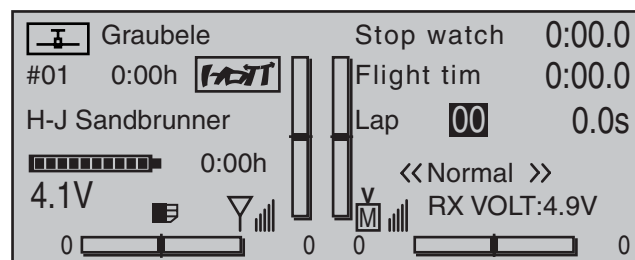

To configure the "Top" and/or "Centr" timer, use the selection keys on the left or right touch pad to access the menu option »**Timers (general)**« in the Multi-function menu:

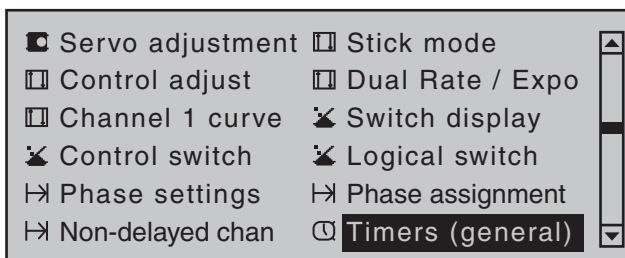
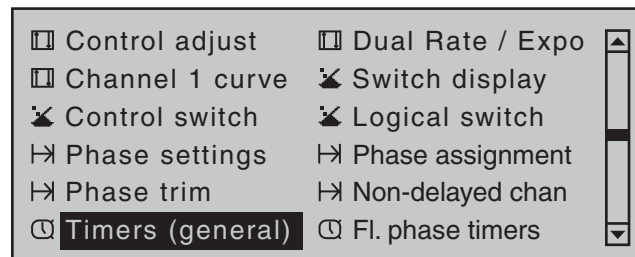

Open this menu option with a tap on the center **SET** key of the right touch pad.

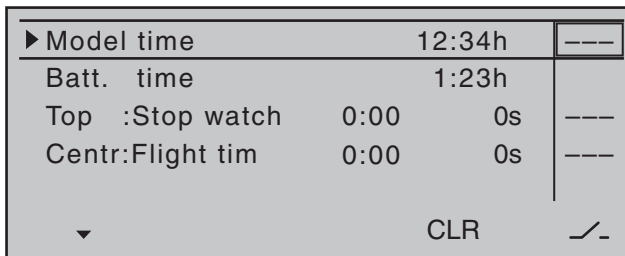

"Model time"

This timer shows the currently registered total access time to the currently active model memory location. If necessary, this automatic time acquisition can also be influenced by assigning an on/off switch to this "Model time" timer in the rightmost column labeled with the switch symbol. This timer can then be switched on and off as desired. This switch is assigned (and erased again as required) as described in the section "Assigning transmitter controls, switches and control switches" on page 56. A simultaneous tap on the ▲▼ or ◀▶ keys of the right touch pad (**CLEAR**) will reset the time back to "0:00 h".

"Batt. time"

This operating hours timer records the transmitter's total switch-on time since the last time the battery was charged, thus monitoring the transmitter battery. A switch cannot be assigned to this function.

This timer is automatically reset to "0:00 h" when the transmitter detects that the voltage of the battery is significantly higher than the last time it was switched on, e.g. as a result of a charge process or the installation of a replacement battery.

A simultaneous tap on the ▲▼ or ◀▶ keys of the right touch pad (**CLEAR**) will also reset this time back to "0:00 h".

"Top" and "Centr"

These two timers are located at the top right of the basic display (see the screen image immediately to the left) and can be assigned a different name; their function and mode of operation varies according to the name you give them. Independently of the name each is given, the "Top" and "Centr" timer can be programmed to run any length of time forwards or backwards – see further below.

Use the selection keys of the left or right touch pad to select the line for the "Top" or "Centr" timer.

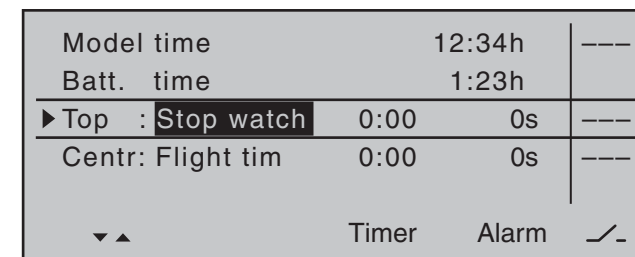

Now use the selection keys of the left or right touch pad to select your desired timer and complete your selection with another tap on the center **SET** key of the right touch pad:

"Stop watch" or "Motor(run)time"

Both of these two timer variants can be started and stopped using any of the available switches.

The timer defined as "Stopwatch" or "Motor runtime" sums the "ON" times continually, so that once your aircraft has landed, you can read off the sum of all switch "ON" times since the timer was last reset.

"Flight tim"

This timer is especially for measuring flight time: it can be started with an assigned switch and stopped (once the switch has been re-opened) on the basic display with a tap on the center **ESC** key of the left touch pad. Once in a stopped state, it can be reset to its starting value with a simultaneous tap on the ▲▼ or ◀▶ keys of the right touch pad at the same time (**CLEAR**).

If you wish to assign a control switch, you must first define the switch on the »**Control switch**« menu and specify the switching point along the travel of the transmitter control. As an example, the timer can then be started by "opening the throttle" or by opening the throttle limiter for helicopter models.

Note:

The combination of the flight time timer and stopwatch means that you can glance at the display at any time and see how long you have been flying since the timers were started, plus the total motor runtime within this particular period of flight time.

"Time frame"

The time frame timer is intended primarily for use by competition pilots, who are frequently given a timeframe within which they must complete certain tasks. The timer is started in precisely the same way as the flight time timer. To stop the timer, first ensure the timer switch is at its OFF position. Then touch and hold the ▲▼ or ◀▶ selection keys then touch the center **ESC** key.

Switch assignment

Use the ▶ selection key of the left or right touch pad to move the marker frame next to the triangle as shown in the screen image shown below to the rightmost column of the relevant line:

| | | |
|--------------------|-------------|------|
| Model time | 12:34h | ---- |
| Batt. time | 1:23h | ---- |
| ▶ Top : Stop watch | 0:00 0s | ---- |
| Centr: Flight tim | 0:00 0s | ---- |
| ▼▲ | Timer Alarm | ↗ |

Here, you assign a switch as described in the section "Assigning transmitter controls, switches and control switches" (page 56).

Typical application:

The "stop watch" and "flight timer" are both to be started simultaneously using the C1 stick as soon as a user-defined switching point is exceeded.

*For this purpose, define a control switch, e.g. "C1", in the »**Control switch**« menu, page 135. To complete the procedure, you select this from the expanded switches (see the section "Assigning transmitter controls, switches and control switches" on page 56) and assign it to both these lines:*

| | | |
|---------------------|-------------|------|
| Model time | 12:34h | ---- |
| Batt. time | 1:23h | ---- |
| Top : Stop watch | 0:00 0s | G1▶ |
| ▶ Centr: Flight tim | 0:00 0s | G1▶ |
| ▲ | Timer Alarm | ↗ |

*The stopwatch will now stop when the stick is below the switching point and resume running above the switching point. The same is not true for the flight time timer, however, which also starts the first time the switching point is exceeded. It can be stopped (with a tap on the center **ESC** key of the left touch pad) only once the stopwatch is stopped; it can then be reset to its starting value with a simultaneous tap on the ▲▼ or ◀▶ keys of the right touch pad*

(**CLEAR**).

Switchover between "forward" and "backward"

Timer runs forwards (stopwatch function)

Following switch assignment, if the stopwatch shown on the basic display is started with the initial value of "0:00", then it will run forwards for max. 180 min and 59 s and then restart from 0:00.

Timer runs backwards (countdown function)

In the –left–minutes field, select a start time between 0 and 180 min ...

| | | |
|--------------------|-------------|------|
| Model time | 12:34h | ---- |
| Batt. time | 1:23h | ---- |
| ▶ Top : Stop watch | 180:00 0s | ---- |
| Centr: Flight tim | 0:00 0s | ---- |
| ▼▲ | Timer Alarm | ↗ |

... and in the –right–seconds field, select a start time between 0 and 59 s (or any combination of these):

| | | |
|--------------------|-------------|------|
| Model time | 12:34h | ---- |
| Batt. time | 1:23h | ---- |
| ▶ Top : Stop watch | 180:59 0s | ---- |
| Centr: Flight tim | 0:00 0s | ---- |
| ▼▲ | Timer Alarm | ↗ |

Procedure

1. Select the desired input field with the ◀▶ selection keys of the left or right touch pad.
2. Now tap on **SET** in the center of the right touch pad.
3. Make a time selection in the inverse video minutes or seconds field with the selection keys of the right touch pad.

- Complete the entry with a tap on the center **SET** key.
- A simultaneous tap on the ▲▼ or ◀▶ keys of the right touch pad (**CLEAR**) will reset any setting made back to "0" or "00".
- Following a switch back to the basic display (by tapping the center **ESC** key of the left touch pad as many times as required), make sure the stopwatch is stopped then simultaneously tap on the ▲▼ or ◀▶ keys of the right touch pad (**CLEAR**) to switchover the stopwatch to the "timer" function. Look at the top right in the following figure.

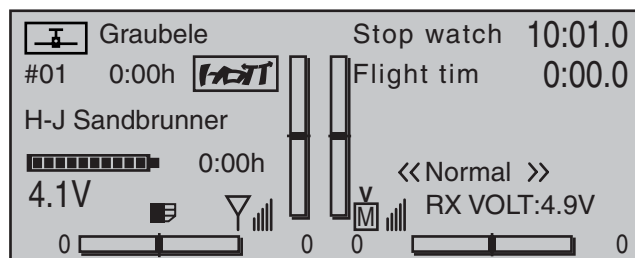

After the assigned switch is activated, the stopwatch starts at the initial value set and runs *backward* ("countdown clock function"). Once the timer reaches zero it does not stop, but continues to run to enable you to read off the time elapsed after it reached 0:00. To make this absolutely clear, the timer is shown highlighted.

"Alarm" timer

The "Alarm" column is accessed by moving the marker frame to the right with the ▶ selection key of the left or right touch pad until it is over the column labeled "Alarm". In the "Alarm" column a time between 5 and 90 seconds (in 5-second increments) can be defined. This is the amount of time the timer is to count down before issuing an acoustic signal. This eliminates the need to repeatedly check the display continually during the flight.

| | | |
|--------------------|--------|----------|
| Model time | 12:34h | --- |
| Batt. time | 1:23h | --- |
| ▶ Top : Stop watch | 180:59 | 90s |
| Centr: Flight tim | 0:00 | 0s |
| ▼▲ | Timer | Alarm ✓- |

A simultaneous tap on the ▲▼ or ◀▶ keys of the right touch pad (**CLEAR**) will reset any settings made back to "0 s".

Audible signal sequence

- 30 s before zero: Triple beep
Single beep every two seconds
- 20 s before zero: Double beep
Single beep every two seconds
- 10 s before zero: Single beep
Single beep every second
- 5 s before zero: every second a single beep at a higher frequency
- zero: longer beep signal and
changeover of display presentation to inverse video

Resetting *suspended* timers

A simultaneous tap on the ▲▼ or ◀▶ keys of the right touch pad (**CLEAR**) will reset timers which have already been *suspended*.

Notes:

- Timers that are running backwards are shown on the basic display with a flashing colon (:) between the minutes and the seconds fields.
- A typical application, "Timer activation via the C1 joystick", can be found on page 284.
- An interim timer function change becomes active after timer/s have been suspended and subsequently reset by a simultaneous tap on the ▲▼ or ◀▶ keys of the right touch pad (**CLEAR**).

- Remember that the timer switches also remain active during programming.
- A simultaneous tap on the ▲▼ or ◀▶ keys of the right touch pad (**CLEAR**) will reset the previously stopped timer to its programmed initial value, refer to sections "Alarm" and "Timer".

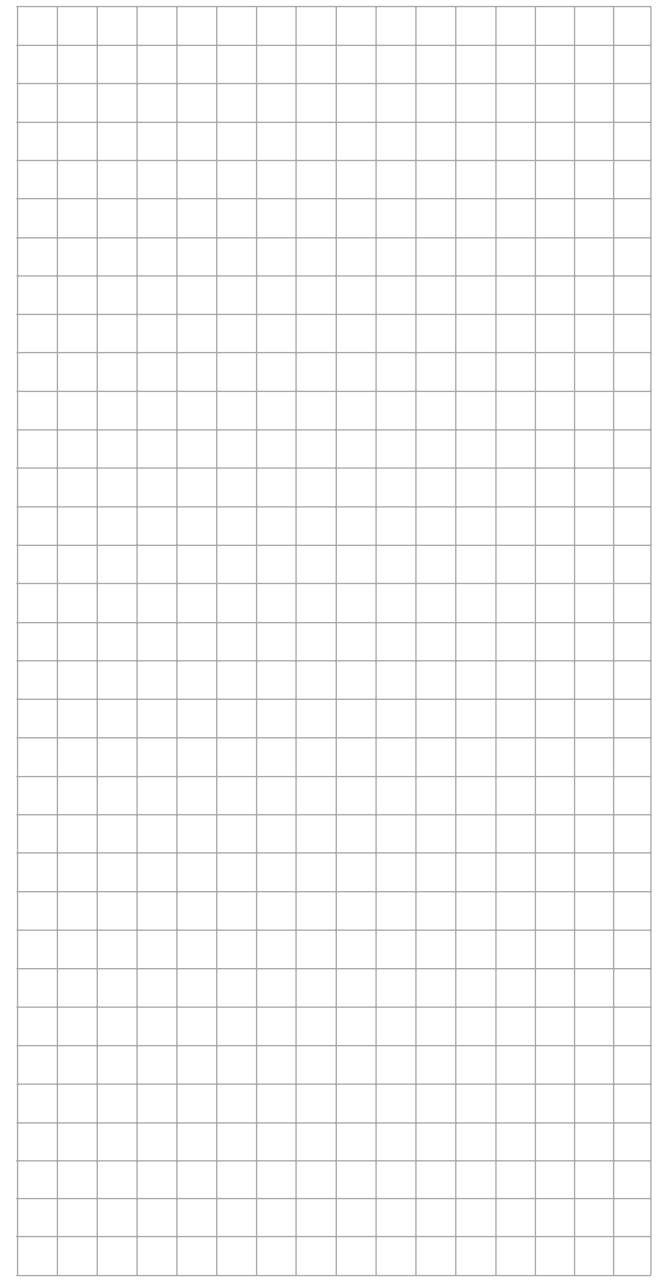
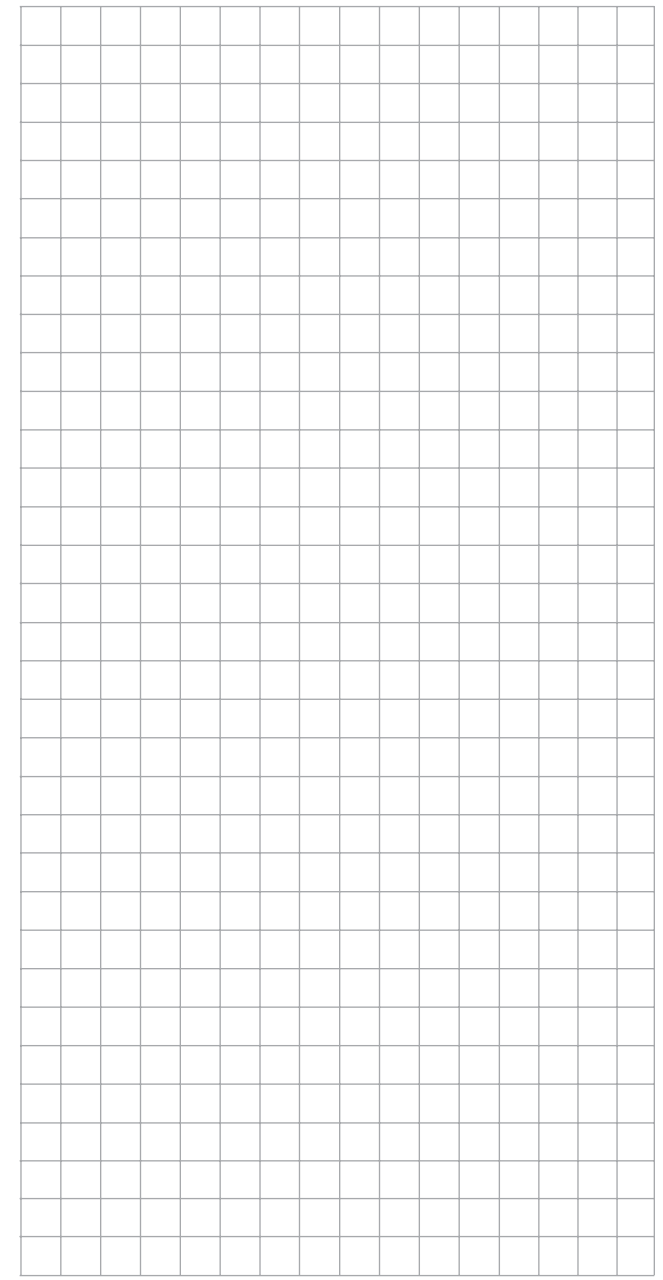
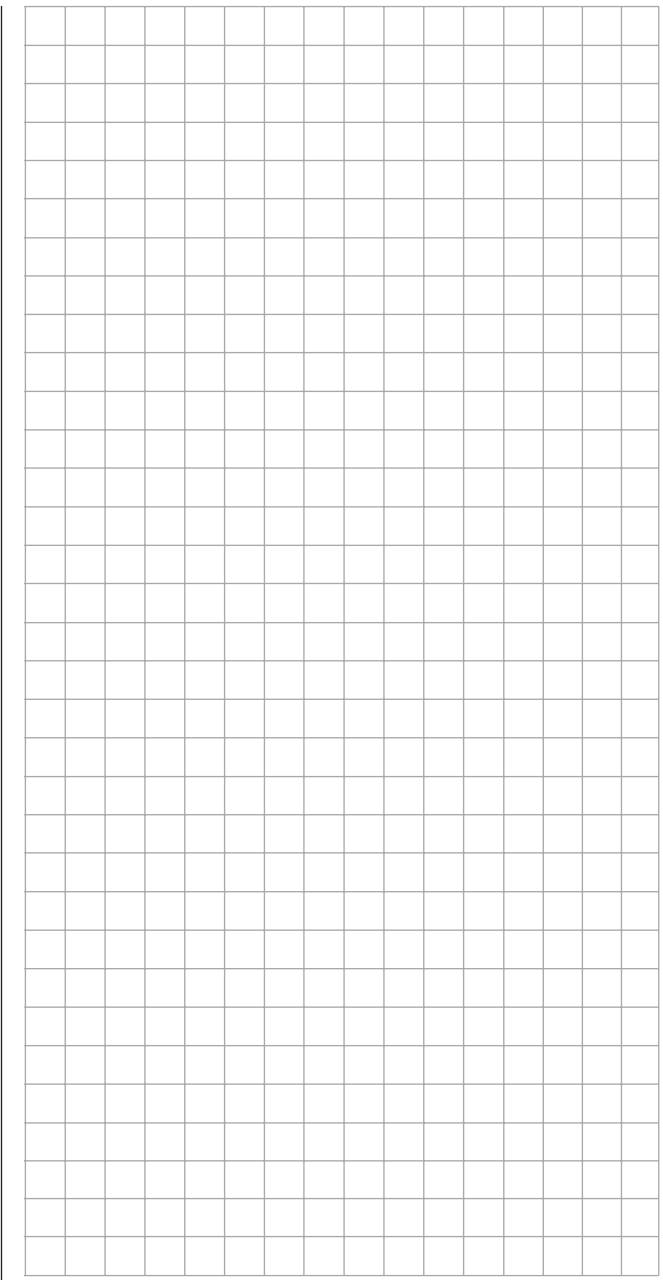



Fl. phase timers

Selecting and setting

A description of how timers are assigned to a flight phase has already been provided in the text for the »Phase settings« menu, page 142 and 146. The same section has also described the properties of "Time1" and "Time2". This section now proceeds to describe "Timer 1, 2 and 3" and the "lap counter/time table" timer variants.

The additional, flight phase-specific timer selected is displayed on the basic display underneath the "center" timer, as shown below:

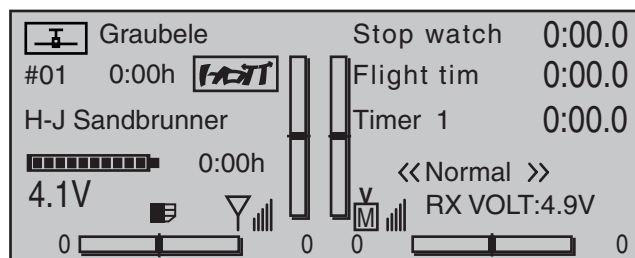

On this menu ...

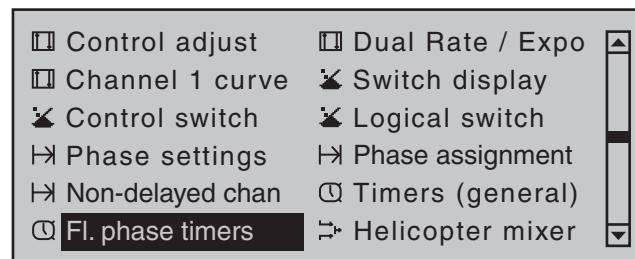
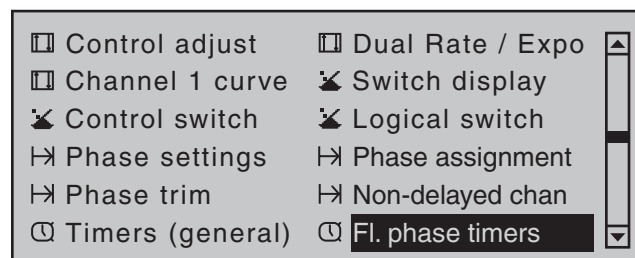

... you can now program "Clks 1 ... 3" as stopwatches (i.e. timers that run forward) or as countdown/alarm timers (i.e. timers that run backwards). You can assign

any switch to these timers, and the same is true of the "lap counter/timetable" timer:

| | | | |
|------------------|-------|-------|------|
| ▶ Timer 1 | 0:00 | 0s | ---- |
| Timer 2 | 0:00 | 0s | ---- |
| Timer 3 | 0:00 | 0s | ---- |
| Lap time/Tim tab | | | ---- |
| Lap display | | | ---- |
| ▼ | Timer | Alarm | ✓- |

The flight phase timers "Timer 1 ... 3" and the "Time1"/"Time2" timers (described in the »Phase settings« section, pp. 142 and 146) run only in the flight phase to which they have been assigned. They are also shown as appropriate on the basic display. During other flight phases they are stopped (and hidden) and the assigned stop/start switch then has no effect.

The lap counter, once started, continues to run through changes of phase (as discussed further below), however, although it can be stopped during any flight phase via the center **ESC** key of the left touch pad.

Clks 1, 2 and 3

These timers are started and stopped via a switch or control switch. To do so, first use the selection keys to select the appropriate column via the switch icon at the bottom right. Then set the switch that you want by briefly tapping the center **SET** key of the right touch pad, as described in the section "Assigning transmitter controls, switches and control switches" (p. 56). Here, too, a control switch offers you the option of activating the timer via one of the joysticks or proportional controls. The switching point along the transmitter control travel is set on the »Control switch« menu (page 135).

Remember that the timer switches also remain active in programming mode.

Switching between "forwards" and "backwards"

Stopwatch mode (timer runs forwards)

In this mode, the timer starts at the initial value "0:00" (min:sec) when you operate the assigned switch. If it reaches the maximum time of 180 min. and 59 s, it will re-start at "0:00".

"Countdown" (timer runs backwards)

Following the activation of the corresponding value fields (by tapping the center **SET** key of the right touch pad), if a time in minutes (maximum 180 min) and/or a time in seconds (maximum 59 s, right field) is set, then the timers will run backwards from this initial value following the activation of the assigned switch (see section "Assigning transmitter controls, switches and control switches" on page 56), i.e. a "countdown" function will apply. Once the timer reaches zero it does not stop, however, but continues to run (highlighted) so you can read off the time elapsed after reaching zero.

Note:

Timers that are running backwards are shown on the basic display with a flashing colon (:) between the minutes and the seconds fields.

A simultaneous tap on the ▲▼ or ◀▶ keys of the right touch pad (**CLEAR**) will reset entry values in the currently active field back to zero.

"Alarm" timer

| | | | |
|------------------|-------|-------|------|
| ▶ Timer 1 | 0:00 | 0s | ---- |
| Timer 2 | 0:00 | 0s | ---- |
| Timer 3 | 0:00 | 0s | ---- |
| Lap time/Tim tab | | | ---- |
| Lap display | | | ---- |
| ▼ | Timer | Alarm | ✓- |

The input field in the "Alarm" column is activated with a tap on the center **SET** key of the right touch pad. In this field, use the selection keys on the left or right touch pad to define a time between 5 and 90 seconds (in 5-second increments) before zero is reached: at this point an audible signal will be emitted, which eliminates the need for you to check the screen continually during the flight.

Audible signal sequence

30 s before zero: Triple beep
 Single beep every two seconds
 20 s before zero: Double beep
 Single beep every two seconds
 10 s before zero: Single beep
 Single beep every second
 5 s before zero: every second a single beep at a higher frequency
 zero: longer beep signal and changeover of display presentation to inverse video

A simultaneous tap on the ▲▼ or ◀▶ keys of the right touch pad (**CLEAR**) will reset entry values entered in the currently active field to "0 s".

Note:

*If timer functionality has been changed at any point, then the new changes to settings are made active only after the timer(s) have been stopped on the basic display then making a simultaneous tap on the ▲▼ or ◀▶ keys of the right touch pad (**CLEAR**) to reset them.*

Like the two standard timers positioned above it, this third, phase-specific timer is reset to its starting value with a simultaneous tap on the ▲▼ or ◀▶ keys of the right touch pad (**CLEAR**). It is stopped in all flight phases at the same time, even if it has not been stopped separately in the other flight phases.

Lap counter/timetable

| | | | |
|-------------------|-------|-------|------|
| Timer 1 | 0:00 | 0s | ---- |
| Timer 2 | 0:00 | 0s | ---- |
| Timer 3 | 0:00 | 0s | ---- |
| ▶Lap time/Tim tab | | | ---- |
| Lap display | | | ---- |
| | Timer | Alarm | ✓ |

On the "Lap time/tim tab" line, assign a switch only as described in the section "Assigning transmitter controls, switches and control switches" (page 56). Preferably, make use of one of the two momentary switches which are included as standard equipment in the switch panels. The lap count is incremented each time by one lap while simultaneously (and automatically) the lap time elapsed during this lap is stopped (and recorded). This momentary switch simultaneously starts the stopwatch for the next lap. As the timer is triggered, the lap or switch impulse counter is shown highlighted.

| | | |
|-----------------|--------------|------------------|
| Graubele | Stop watch | 0:00.0 |
| #01 0:00h | Flight tim | 0:00.0 |
| H-J Sandbrunner | Lap | 11 2:34.5 |
| 0:00h | << Normal >> | |
| 4.1V | RX VOLT:4.9V | |

"Time1" and "Time2" operate in the same manner; for more details please read the section on the »**Phase settings**« menu option.

Up to 99 lap times can be recorded and accessed, each with a maximum duration of 99 minutes and 59.9 seconds.

To stop the timer in question, tap the center **ESC** key of the left touch pad on the basic display after the

flight is over. The lap or switch impulse counter is now shown in "normal" mode:

| | | |
|-----------------|--------------|-----------|
| Graubele | Stop watch | 0:00.0 |
| #01 0:00h | Flight tim | 0:00.0 |
| H-J Sandbrunner | Lap | 12 1:23.4 |
| 0:00h | << Normal >> | |
| 4.1V | RX VOLT:4.9V | |

A simultaneously tap on the ▲▼ or ◀▶ keys of the right touch pad at the same time (**CLEAR**) will reset the counter to "00" and deletes the stored times. However, the timers *must* have been stopped before this.

Notes:

- If you have selected a normal switch to operate the lap counter, take care to ensure that this switch is set to "OFF" before touching the center **ESC** key of the left touch pad.
- If you should forget to switch off the lap counter in a phase which is now not currently active, simply touch the center **ESC** key of the left touch pad.

To swap between the basic display and the "Lap Display" ...

| | | | | | |
|-----------|----------------|----|---------|----|-------------|
| 01 | 01:23.4 | 07 | 00:00.0 | 13 | 00:00.0 |
| 02 | 02:34.5 | 08 | 00:00.0 | 14 | 00:00.0 |
| 03 | 03:45.6 | 09 | 00:00.0 | 15 | 00:00.0 |
| 04 | 04:56.7 | 10 | 00:00.0 | 16 | 00:00.0 |
| 05 | 05:67.8 | 11 | 00:00.0 | 17 | 00:00.0 |
| 06 | 06:78.9 | 12 | 00:00.0 | 18 | 00:00.0 1/6 |

... go to the line ...

Lap Display

| | | | |
|------------------|-------|-------|-----|
| Timer 1 | 0:00 | 0s | --- |
| Timer 2 | 0:00 | 0s | --- |
| Timer 3 | 0:00 | 0s | --- |
| Lap time/Tim tab | | | --- |
| ▶ Lap display | | | --- |
| ▼ | Timer | Alarm | ↘- |

... and use the switch assigned. You assign this switch as described in the section "Assigning transmitter controls, switches and control switches" (page 56).

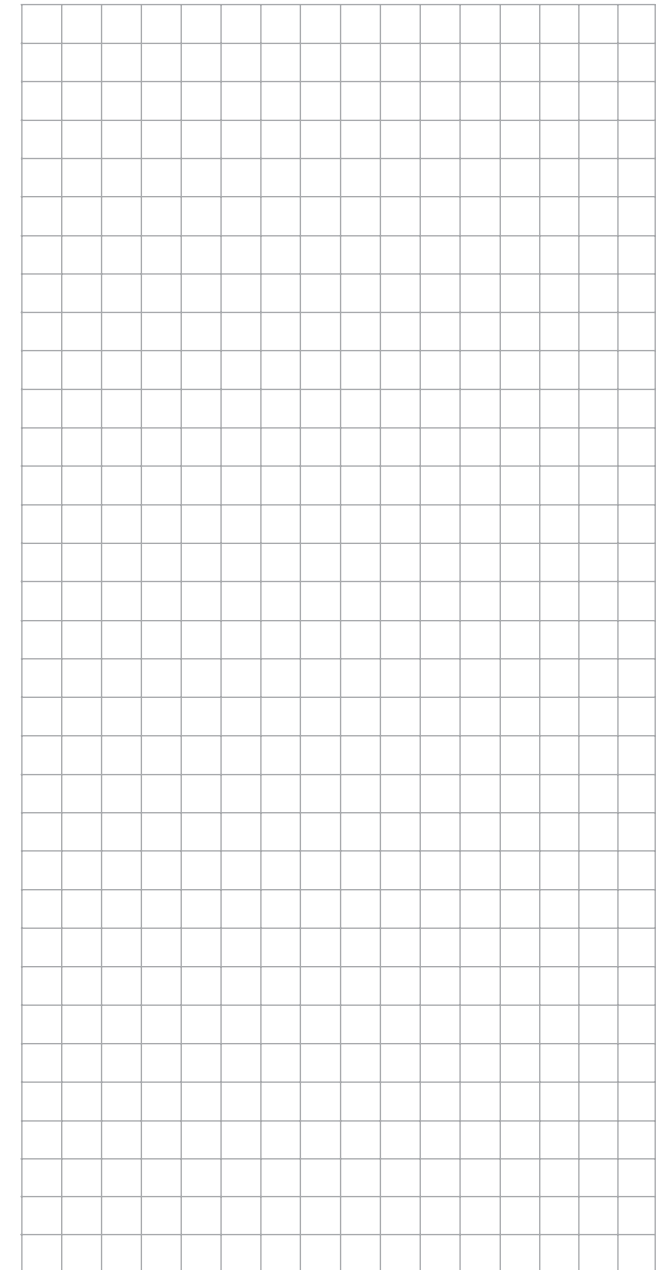
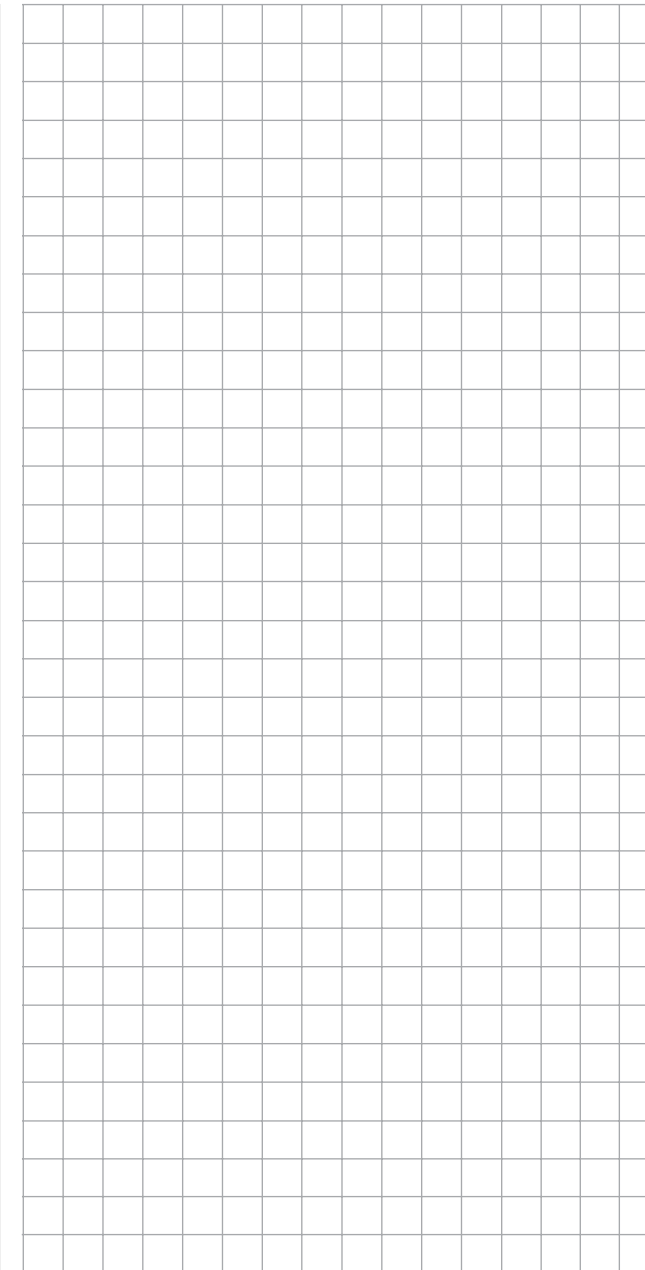

What is a mixer?

Basic functionality

With many models, a mix of the model's functions is often desirable, i.e. coupling aileron to rudder or coupling two servos together, in cases where rudder control surfaces with the same functionality are to be controlled together using a single servo. In all cases, the signal flow at the "output" of the control function on the transmitter control-side "branches"—, this also means: "downstream" of transmitter control options such as e.g. »Dual Rate / Expo«, »Control adjust«, »Channel 1 curve« etc.—in order for the signal to have its predefined effect on the "input" of another control channel and thus on another receiver output.

Example: V-tail mixer

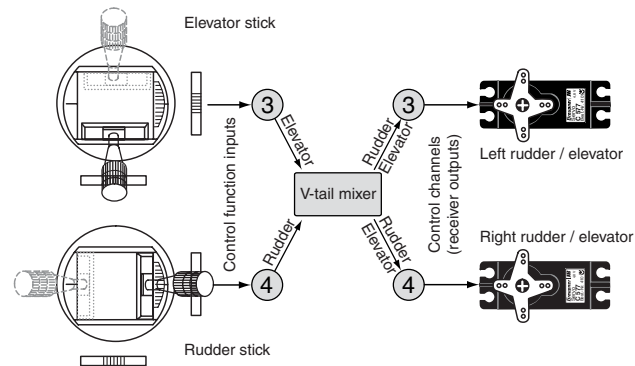

The **MC-20** HoTT transmitter software contains a large number of pre-programmed coupling functions as standard, which are designed to mix together two (or more) control channels. Accordingly, the mixer named in the example just above can be activated in the "Tail" line of the »**Model type**« menu by selecting "V-tail".

In addition, for each model memory in the fixed-wing and helicopter programs, the software makes available a total of eight freely programmable linear mixers, four freely programmable curve mixers and four dual mixers.

Also be sure to read the general remarks about "free mixers" in this manual, beginning on page 192.

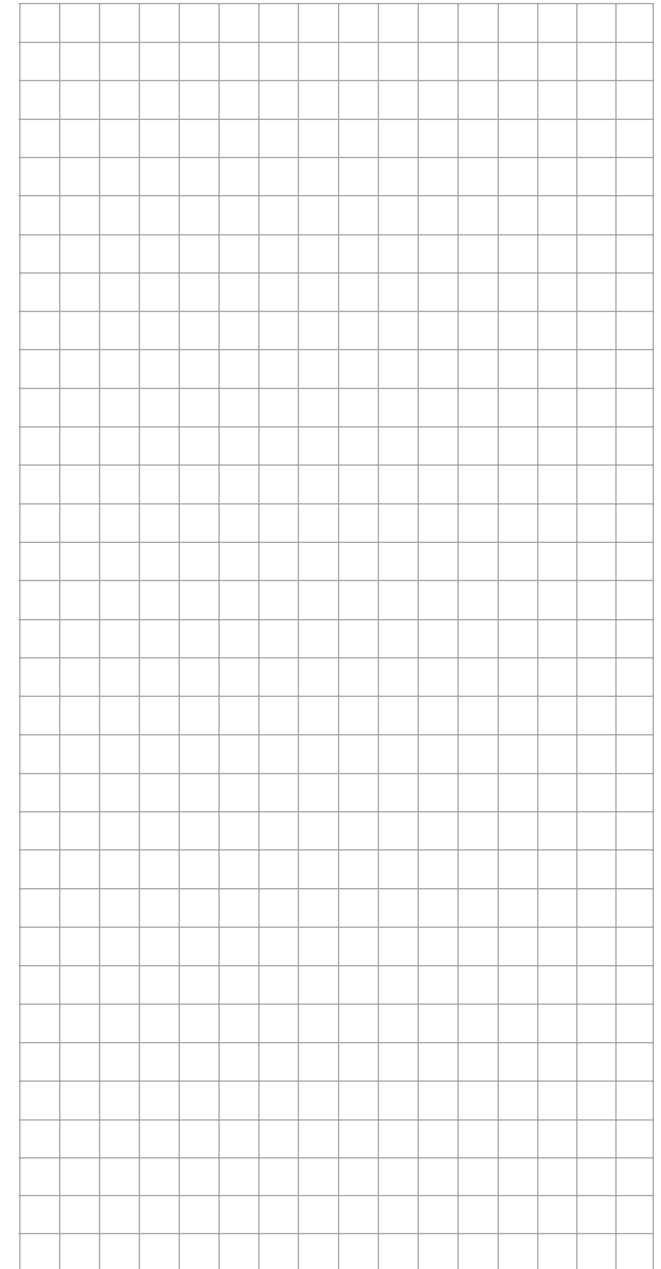

Wing mixers

Calibrating the wing flap system

Within the menu tree of the menu ...

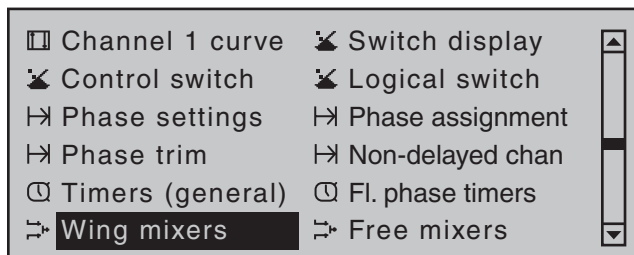

... the sub-menus and options available depend entirely on the number of aileron and flap servos set up on the »**Model type**« menu, page 94 ...

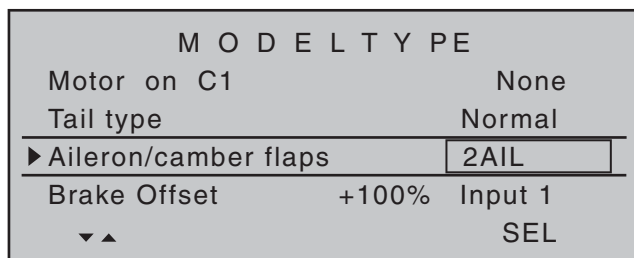

... which means that the only settings listed are the ones that can actually be configured. The resulting menu structure gains not only in clarity but also prevents potential programming errors. For example, if "2AIL" has been preset, display of the »**Wing mixers**« menu would appear (without camber flaps) as shown below:

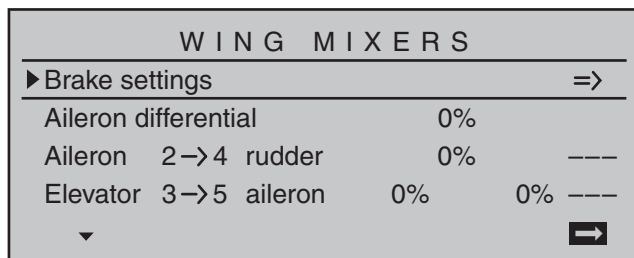

If various flight phases are envisioned in the settings of the »**Phase settings**«, page 142, and

»**Phase assignment**«, page 148 menus, and these flight phases have been given names, the flight phase names will appear along the bottom display edge, e.g. «Normal».

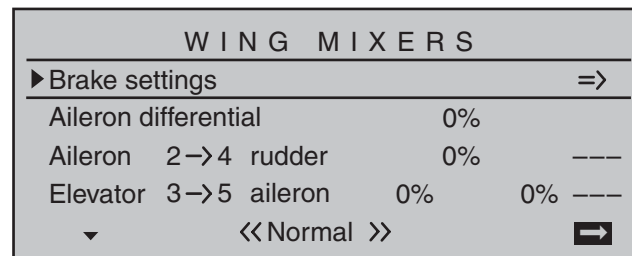

All options can then also be programmed specific to a flight phase.

Comments:

- In the »**Model type**« menu, (page 94), control of the brake flap mixer can be reprogrammed from control input 1 to 7, 8 or 9 and a corresponding offset point can be set.
- Braking with raised ailerons and, if present, lowered flaps (crow system) can be implemented by making appropriate settings on the "Crow" line of the "Brake settings" sub-menu.
- If you would like to alternate between the C1 stick controlling an electric drive system and a butterfly system, then you can use the options in the "Motor" column on the »**Phase settings**« menu – refer to the example on page 279.
- You can also use the opportunity to set switch times for a "soft" transition from flight phase to flight phase on the »**Phase settings**« menu (see page 142).
- If your model features multiple wing flaps and a "crow / butterfly system" (see below), but without additional airbrakes, then you can separate output 1 (usually freed up by the above system) from control function input 1 (throttle/brake stick) on the

»**Mix only channel**« (see page 205) and use it for another purpose with the help of a "free mixer" (see page 193).

- If "2AIL" is set in the »**Model type**« menu, page 94, then flight-phase dependent flap functionality can be achieved with appropriate offset settings for input 5 in the »**Control adjust**« menu, page 108.
- For almost any menu option, you have the option of checking your settings by switching to the servo display screen, which is accessed with a simultaneous tap on the ◀ ▶ selection keys of the left touch pad.

Caution:

With aileron actuation the bars of the »**Servo display**« move in the same manner and in the opposite manner with camber changing flap actuation.

- Note that if two flap servos have been selected, any transmitter control assigned to input 7 will be decoupled in the software in order to avoid errors in operating the flaps. The same applies to input 10 and the selection "2AIL 4FL".
- A range of options are available for positioning flaps. You can ...
 - ... simply accept one position per flight phase, by setting only the corresponding trim values.
 - ... vary the flaps positioned by a) with a transmitter control assigned to "Input 6" in the »**Control adjust**« menu, (page 108), and if desired by also selecting flight-phase dependency "PH" in the "Type" column. The selected transmitter control directly controls the two flap servos located on receiver outputs 6 and 7 and, as required, also the two FL2 servos connected to outputs 9 and 10 – assuming that corresponding flaps have been specified on the "Aileron/camber flaps" line in the »**Model type**« menu. This transmitter control indirectly

controls the flap position of the ailerons via the percentage value entered in the "Ail" (and "Ail2") column on the "FLAP" line of the multi-flap menu. However, in order to improve control sensitivity for flap settings, travel should be reduced to about 25% in "Input 6" line of the »**Control adjust**« menu.

c) ... alternatively, you can also leave the default entry of "0%" in the "AILE" (and "AIL2") column on the "FLAP" line of the multi-flap menu, and use the »**Control adjust**« menu to assign both input 6 and input 5 to the same transmitter control. You can then set the degree to which both flap pairs are affected, optionally making this flight phase-dependent by selecting "PH" in the "Type" column, with the respective travel adjustment.

Basic programming procedure

1. Select the desired line with the ▲▼ selection keys of the left or right touch pad.
Depending on the line selected, the bottom line of the display will either show the "Next page" icon (➡) or a switch icon.
2. Depending on the line selected, you will either switch to the next page – on which you carry out the same procedure as below – or the desired value field is activated by tapping the center **SET** key of the right touch pad.
3. Use the selection keys to set the mixer ratio or degree of differential.
To configure symmetrical mixer values, move the transmitter control or joystick to its center position, so that the marker frame surrounds both value fields. To configure asymmetric values, move the transmitter control/joystick to the corresponding side. Negative and positive parameter values are possible, in order to be able to adjust the respective function to the direction of servo

rotation or flap orientation.

4. A simultaneous tap on the ▲▼ or ◀▶ keys of the right touch pad (**CLEAR**) will reset the entry value in the given active (inverse video) field back to its default value.
5. Complete the entry with a tap on the center **ESC** key of the left touch pad or the center **SET** key of the right touch pad.

Assigning switches

Wing mixers "Aileron 2 → 4 rudder" and "Flaps 6 → 3 elevator" can be made optionally on/off switchable by way of a switch or expanded switch. Accordingly, when the respective line is selected, the familiar switch symbol (↙-) will appear on the lower edge of the screen.

Switching delays

The delay time or switch time configured on the »**Phase settings**« menu, page 142, for the respective flight phase also affects all wing mixers and thus avoids abrupt changes to flap configurations when switching between the flight phases.

Mixer neutral points (Offset)

For all mixers on the "Brake settings" sub-menu, the "brake offset" to be set on the »**Model type**« menu is to be configured to the transmitter control position at which the airbrakes are retracted.

Accordingly, in the "Brake offset" line of the »**Model type**« menu, see page 94, specify Input 1, 7, 8 or 9 and the offset to accommodate personal piloting habits. When selecting "input 1", please note also that you may need to specify your desired "Throttle min" position "forward/back" before establishing the offset point in the "Motor at C1" line.

Note:

If the offset is not set right at the end of the transmitter travel, the rest of the travel is a "dead zone", i.e. the transmitter control does not influence

any mixers on the "Brake settings" sub-menu. Otherwise, the mixer travel is expanded back to 100% automatically.

All other mixers in the »**Wing mixers**« menu have their neutral point with the control at its center, i.e. they have no effect at this control position. The value set is mixed in at full travel.

Mixer functions

The individual options in the »**Wing mixers**« menu are discussed below, separately for single-, dual- and multi-flap models. Before we start, a number of remarks on the differentials for ailerons and flaps:

Aileron differential

| WING MIXERS | | | | |
|------------------------|--------------|----|----|-----|
| Brake settings | | | | => |
| ▶ Aileron differential | | 0% | | |
| Aileron 2 → 4 rudder | | 0% | | --- |
| Elevator 3 → 5 aileron | | 0% | 0% | --- |
| ▼ | << Normal >> | | | ➡ |

| | | | |
|--------------|-------|-------|-------|
| ▲ AI ▼ | +100% | 0% | |
| Ail-tr | +100% | 0% | |
| ▶ Diff. | 0% | 0% | |
| FI-Pos. | 0% | 0% | |
| ▲ FL ▲ | 0% | +100% | +100% |
| << Normal >> | AILE | FLAP | ▼ ▲ |

For aerodynamic reasons, the drag generated on an aileron oriented downwards is greater than that generated by the same aileron when it is oriented upwards by the same amount. One effect of this unequal distribution of drag produces is a yawing motion around the vertical axis and, accordingly, a "turning away" from the intended direction of flight, which is why this undesirable side effect is also

termed "adverse yaw". This effect is naturally greater on the comparably long aerofoils possessed by model gliders, compared to e.g. powered aircraft models, which generally have relatively short moment arms. For the former, it must normally be compensated for by making a simultaneous rudder deflection in the opposite direction. However, this rudder deflection also generates drag and therefore further degrades flight characteristics.

If, on the other hand, a differential is applied to the aileron orientations, by giving the aileron oriented downwards a smaller deflection than the aileron oriented upwards, the (undesirable) adverse yaw can be reduced – and possibly entirely negated. However, the basic precondition for this is that each aileron must have its own servo present, which can therefore also be embedded straight into the aerofoils. In addition, the shorter linkage paths produce an additional benefit: reproducible aileron configurations that also exhibit less "play".

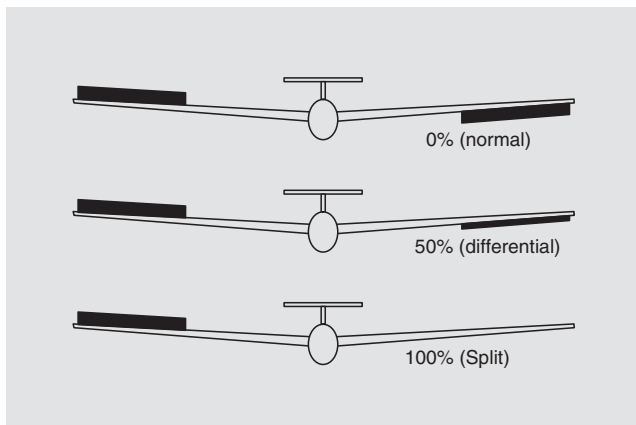

Unlike mechanical solutions, which not only commonly need to be designed and built in when constructing the model but also produce a slightly increased "play" in the control system for strong differentials, the transmitter-based differential typically

used today offers considerable benefits.

The degree of differential can be changed at any time, for example, and, in extreme circumstances, the downward deflection of an aileron, in what is termed a "split" position, can be suppressed entirely. This approach not only reduces or even suppresses "adverse yaw", but can, in certain circumstances, even generate a positive yaw: in such cases, an aileron command will generate a yaw about the vertical axis in the direction of the turn. For large glider models in particular, this approach lets such aircraft fly "clean" turns using just the ailerons, which is not otherwise possible unaided.

The adjustment range of -100% to +100% makes it possible to set a differential appropriate for each side, regardless of the direction of rotation of the aileron servos. While "0%" corresponds to a normal linkage, i.e. no differential, "-100%" or "+100%" represents the "split" function.

For aerobatic flying, low absolute values are required to ensure the model rotates exactly along its longitudinal axis when an aileron command is given. Values near to the center (-50% or +50%) are typical for facilitating turns in thermals. The split setting (-100%, +100%) is popular with slope fliers, where ailerons alone are often used for turning the model. A simultaneous tap on the ▲▼ or ◀▶ keys of the right touch pad (CLEAR) will reset a changed value in a given active (inverse video) field back to 0%.

Note:

Negative values are not usually necessary if channels are assigned properly.

Diff. (Differentiation)

| | | | |
|-------------|-------|-------|--------|
| ▲QR▼ | +100% | 0% | 0% |
| QR-Tr. | +100% | 0% | 0% |
| ▶Diff. | 0% | 0% | 0% |
| WK-Pos. | 0% | 0% | 0% |
| ▲WK▲ | 0% | +100% | +100% |
| <<Normal >> | QR | WK | WK2 ▼▲ |

The "▲AI▼" (topmost) line in the Multi-flap menu can be used to set the extent to which the flaps act as ailerons and follow the aileron joystick.; this value is entered as a percentage. The flaps differential – to be set on the line "Diff." (two lines below) – works in a similar way to the aileron differential, i.e. where an aileron command acts on the flaps, the respective deflection downwards can be reduced.

The adjustment range of -100% to +100% makes it possible to set a differential appropriate for each side, regardless of the direction of rotation of the servos. A value of 0% is equal to normal linkage, i.e. the servo travel downwards is the same as the travel upwards. A value of -100% to +100% means that travel downwards will be reduced to zero for aileron commands affecting the flaps ("split" mode).

A simultaneous tap on the ▲▼ or ◀▶ keys of the right touch pad (CLEAR) will reset a changed value in a given active (inverse video) field back to 0%.

Note:

Negative values are not usually necessary if channels are assigned properly.

Model type: "1AIL"

If you have entered "1AIL" for the "Aileron/camber flaps" line on the »**Model type**« menu (page 94), then the "Wing mixers menu" on your transmitter will match the following screen image:

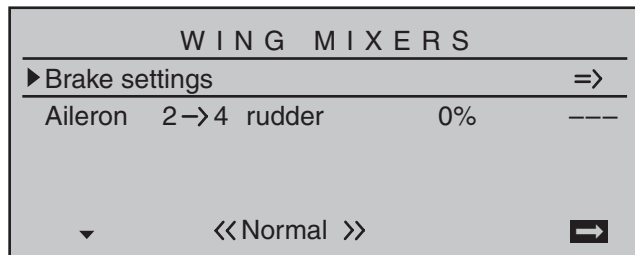

From the first line on this display screen, you can switch to the sub-menu with a brief tap on the center **SET** key of the right touch pad ...

Brake settings

Note:

The "Brake settings" menu is switched "off" if: "Motor on C1 forward / back" in the »**Model type**« menu (page 94) AND the "Motor" column of the »**Phase settings**« menu, (page 142) are set to "yes" for the currently active flight phase. Switch the flight phase if required:

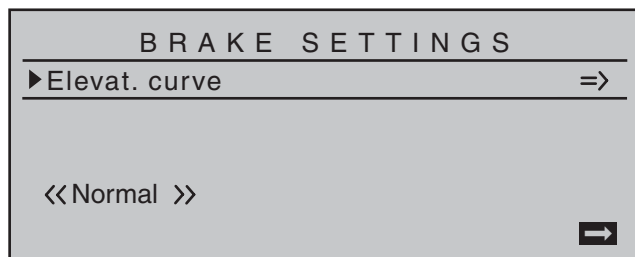

Since you cannot set up a butterfly or aileron differential in a model with only a single aileron servo, this menu offers no further configuration options with the exception of a "pointer" to the "Elevat curve" sub-menu. Therefore, move ahead from here with another

tap on the center **SET** key of the right touch pad:

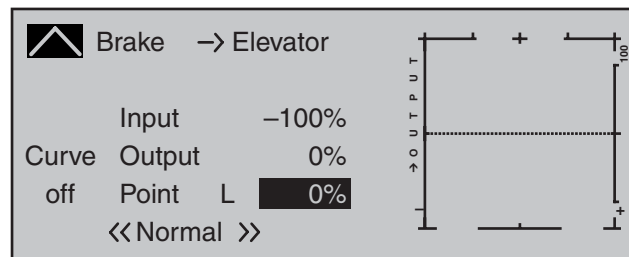

If required, i.e. if you have the feeling that you will need to set pitch trim compensation when the airbrakes are extended, you can program an appropriate automatic mixer affecting the elevator at this point.

For detailed instructions on setting a curve mixer, please refer to the »**Channel 1 curve**« menu option text beginning page 128.

Aileron 2 → 4 rudder

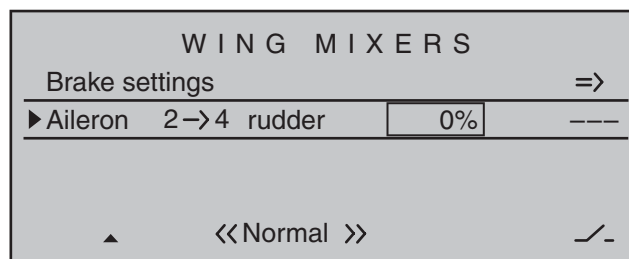

Here, you can set the degree to which the rudder follows commands acting on ailerons. This is used in particular in connection with aileron differential to suppress adverse yaw and thus make it easier to fly "clean" curves. You can of course still issue separate commands to the rudder.

The adjustment range of $\pm 150\%$ lets you set the direction of deflection as appropriate. Optionally, this mixer can be activated and deactivated with of the switches or a control switch that is not self-restoring so the model can be controlled with only the ailerons or rudder if desired.

Typically, this mixer is set so that the rudder is deflected to the same side as the upward-oriented aileron, and you will find that setting a value of around 50% is usually highly appropriate.

Settings are always made symmetrically relative to the neutral point of the aileron joystick.

A simultaneous tap on the ▲▼ or ◀▶ keys of the right touch pad (**CLEAR**) will reset a changed value in a given active (inverse video) field back to 0%.

Model type: "1AIL 1FL"

If you have entered "1AIL 1FL" for the "Aileron/camber flaps" line on the »**Model type**« menu (page 94), then the "Wing mixers menu" on your transmitter will match the following screen image:

| WING MIXERS | | | | |
|------------------|-------------|----------|----|--------|
| ▶ Brake settings | | | | ⇒ |
| Aileron | 2→4 | rudder | 0% | --- |
| Elevator | 3→6 | flaps | 0% | 0% --- |
| Flaps | 6→3 | elevator | 0% | 0% --- |
| ▼ | <<Normal >> | | | ⇒ |

From the first line on this display screen, you can switch to the sub-menu with a brief tap on the center **SET** key of the right touch pad ...

Brake settings

Note:

The "Brake settings" menu is switched "off" if: "Motor on C1 forward / back" in the »**Model type**« menu (page 94) AND the "Motor" column of the »**Phase settings**« menu, (page 142) are set to "yes" for the currently active flight phase. Switch the flight phase if required:

| BRAKE SETTINGS | |
|----------------|------|
| ▶ Crow | 0% |
| Elevat. curve | ⇒ |
| <<Normal >> | |
| ▼ | FLAP |

Appropriate to the model type selected, you can now enter a suitable value in the "Crow" line to lower the flap when you activate the brake control – which is typically the C1 joystick.

To configure the setting, first position the brake control in the brake position at full travel (i.e. its end-point). Then, briefly tap the center **SET** key of the right touch pad and enter a suitable value using the selection keys on the left or right touch pad. To ensure a sufficiently strong braking effect, note that you should try to lower the flap as low as is mechanically possible.

From the second line on this display screen, you can switch to the sub-menu "Elevat curve" by briefly tapping the center **SET** key of the right touch pad:

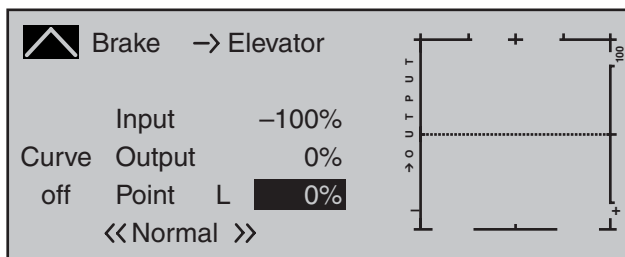

If required, i.e. if you have the feeling that you will need to set pitch trim compensation when the airbrakes are extended, you can program an appropriate automatic mixer affecting the elevator at this point.

For detailed instructions on setting a curve mixer, please refer to the »**Channel 1 curve**« menu option text beginning page 128.

Aileron 2 → 4 rudder

| WING MIXERS | | | | |
|------------------|-------------|----------|----|--------|
| ▶ Brake settings | | | | ⇒ |
| ▶ Aileron | 2→4 | rudder | 0% | --- |
| Elevator | 3→6 | flaps | 0% | 0% --- |
| Flaps | 6→3 | elevator | 0% | 0% --- |
| ▼ ▲ | <<Normal >> | | | ↘ |

Here, you can set the degree to which the rudder follows commands acting on ailerons. This is used

in particular in connection with aileron differential to suppress adverse yaw and thus make it easier to fly "clean" curves. You can of course still issue separate commands to the rudder.

The adjustment range of $\pm 150\%$ lets you set the direction of deflection as appropriate. Optionally, this mixer can be activated and deactivated with of the switches or a control switch that is not self-restoring so the model can be controlled with only the ailerons or rudder if desired.

Typically, this mixer is set so that the rudder is deflected to the same side as the upward-oriented aileron, and you will find that setting a value of around 50% is usually highly appropriate.

Settings are always made symmetrically relative to the neutral point of the aileron joystick.

A simultaneous tap on the ▲▼ or ◀▶ keys of the right touch pad (**CLEAR**) will reset a changed value in a given active (inverse video) field back to 0%.

Elevator 3 → 6 flaps

| WING MIXERS | | | | |
|------------------|-------------|----------|----|--------|
| ▶ Brake settings | | | | ⇒ |
| Aileron | 2→4 | rudder | 0% | --- |
| ▶ Elevator | 3→6 | flaps | 0% | 0% --- |
| Flaps | 6→3 | elevator | 0% | 0% --- |
| ▼ ▲ | <<Normal >> | | | ↘ |

To provide support for the elevator for tight turns and aerobatics, this mixer can be used to make the flap function follow controls sent to the elevator. The mixer direction chosen must ensure that the flaps are deflected downwards when the elevator is oriented upwards and vice versa for a downward-oriented elevator – i.e. in opposite directions. This mixer can be made optionally on/off switchable with one of the switches or a control switch that is not self-restoring. To configure symmetrical mixer values, move

the elevator joystick to its center position, so that the marker frame surrounds both value fields. To configure asymmetric values, move the joystick to the corresponding side.

Values in the range -150% to +150% are possible, so as to adjust the function to the direction of servo rotation or direction of flap deflection.

A simultaneous tap on the ▲▼ or ◀▶ keys of the right touch pad (**CLEAR**) will reset a changed value in a given active (inverse video) field back to 0%.

The "typical" values configured for this mixer are single-digit or low two-digit values.

Flaps 6 → 3 elevator

| WING MIXERS | | | | |
|----------------|-------------|----------|----|---------|
| Brake settings | | | | => |
| Aileron | 2→4 | rudder | 0% | ---- |
| Elevator | 3→6 | flaps | 0% | 0% ---- |
| ▶ Flaps | 6→3 | elevator | 0% | 0% ---- |
| ▼ ▲ | <<Normal >> | | | ↗ |

This mixer is used to set elevator (pitch-trim) compensation when a flap command is given. This typically enables you to adjust the model's airspeed automatically when flaps are lowered.

If you have used the »**Control adjust**«, page 108, to assign Input 6 to a transmitter control or switch then this also affects this mixer.

Depending on the position of the flap control, either a symmetrical or asymmetric setting within the range ±150% is possible.

A simultaneous tap on the ▲▼ or ◀▶ keys of the right touch pad (**CLEAR**) will reset a changed value in a given active (inverse video) field back to 0%.

If required, the mixer can be switched on or off by assigning a switch in the right column.

The values configured for this mixer are typically in the single-digit range.

Model type: "2AIL"

If you have entered "2AIL" for the "Aileron/camber flaps" line on the »**Model type**« menu (page 94), then the "Wing mixers menu" on your transmitter will match the following screen image:

| WING MIXERS | | | | |
|----------------------|-------------|---------|----|---------|
| ▶ Brake settings | | | | => |
| Aileron differential | | | 0% | ---- |
| Aileron | 2→4 | rudder | 0% | ---- |
| Elevator | 3→5 | aileron | 0% | 0% ---- |
| ▼ | <<Normal >> | | | ➔ |

From the first line on this display screen, you can switch to the sub-menu with a brief tap on the center **SET** key of the right touch pad ...

Brake settings

Note:

The "Brake settings" menu is switched "off" if: "Motor on C1 forward / back" in the »**Model type**« menu (page 94) AND the "Motor" column of the »**Phase settings**« menu, (page 142) are set to "yes" for the currently active flight phase. Switch the flight phase if required:

| BRAKE SETTINGS | |
|----------------|------|
| ▶ Crow | 0% |
| Diff.- reduct | |
| Elevator curve | => |
| <<Normal >> | |
| ▼ | AILE |

Depending on the model type selected, setting options will now be available in the "**Crow**" and "**Diff(erential)reduct(ion)**" lines for the column labeled "**AILE**". These options should be utilized by

...

- ... putting the transmitter control for "Brake" (refer to the »**Model type**« menu description on page 94) – typically the C1 joystick – in its limit position in the brake direction. Switch to the "Crow" line, briefly tap on the center **SET** key of the right touch pad and use the selection keys on the left or right touch pad to set a value that moves the aileron upwards as far as possible to brake the model or, if you are using airbrakes as the main braking system, the aileron should be set to elevate only minimally to provide an extra braking effect.

Note:

To reliably prevent the servos mechanically striking their end-stops – which draws a heavy current – you can set an appropriate limit value in the column labeled "– limit +" in the »**Servo adjustment**« menu, page 102.

- ... then finally, moving to the "Diff. reduct" line, set a % value there which is greater than or equal to that value set (or to be set) in the "Aileron differential" line of the display screen "before" this one. In this way, you can suppress the aileron differential when braking, thus ensuring that you can count on sufficient aileron response despite your ailerons being deflected upwards.

From the lowest line, "Elevator curve", you can switch to setting the "Elevator curve" mixer by briefly tapping the center **SET** key of the right touch pad:

▲ Brake → Elevator

Input -100%

Curve Output 0%

off Point L 0%

<<Normal >>

If required, i.e. if you have the feeling that you will need to set pitch trim compensation when the airbrakes are extended, you can program an appropriate automatic mixer affecting the elevator at this point.

For detailed instructions on setting a curve mixer, please refer to the »Channel 1 curve« menu option text beginning page 128.

Aileron differential

| WING MIXERS | | | |
|------------------------|-------------|----|-----|
| Brake settings | | | => |
| ▶ Aileron differential | 0% | | |
| Aileron 2→4 rudder | 0% | | --- |
| Elevator 3→5 aileron | 0% | 0% | --- |
| ▼ | <<Normal >> | | → |

The adjustment range of $\pm 100\%$ makes it possible to set the correct direction of differential, regardless of the direction of rotation of the aileron servos. While "0%" corresponds to a normal linkage, i.e. no transmitter-side differential, "-100%" or "+100%" represents the "split" function.

For aerobatic flying, low absolute values are required to ensure the model rotates exactly along its longitudinal axis when an aileron command is given. Values near to the center (-50% or +50%) are typical for facilitating turns in thermals. The split setting (-100%, +100%) is popular with slope fliers, where ailerons alone are often used for turning the model.

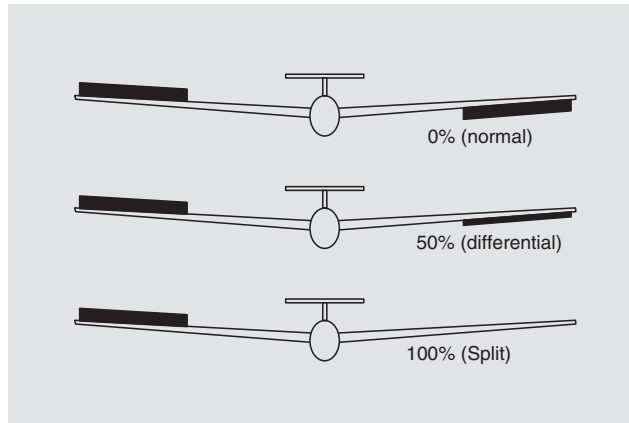

A simultaneous tap on the ▲▼ or ◀▶ keys of the right touch pad (**CLEAR**) will reset a changed value in an active (inverse video) field back to 0%.

Note:

Negative values are not usually necessary if channels are assigned properly.

Aileron 2 → 4 rudder

| WING MIXERS | | | |
|----------------------|-------------|----|-----|
| Brake settings | | | => |
| Aileron differential | 0% | | |
| ▶ Aileron 2→4 rudder | 0% | | --- |
| Elevator 3→5 aileron | 0% | 0% | --- |
| ▼ ▲ | <<Normal >> | | ↙ |

Here, you can set the degree to which the rudder follows commands acting on ailerons. This is used in particular in connection with aileron differential to suppress adverse yaw and thus make it easier to fly "clean" curves. You can of course still issue separate commands to the rudder.

The adjustment range of $\pm 150\%$ lets you set the direction of deflection as appropriate. Optionally, this

mixer can be activated and deactivated with of the switches or a control switch that is not self-restoring so the model can be controlled with only the ailerons or rudder if desired.

Typically, this mixer is set so that the rudder is deflected to the same side as the upward-oriented aileron, and you will find that setting a value of around 50% is usually highly appropriate.

Settings are always made symmetrically relative to the neutral point of the aileron joystick.

A simultaneous tap on the ▲▼ or ◀▶ keys of the right touch pad (**CLEAR**) will reset a changed value in a given active (inverse video) field back to 0%.

Elevator 3 → 5 aileron

| WING MIXERS | | | |
|------------------------|-------------|----|-----|
| Brake settings | | | => |
| Aileron differential | 0% | | |
| Aileron 2→4 rudder | 0% | | --- |
| ▶ Elevator 3→5 aileron | 0% | 0% | --- |
| ▲ | <<Normal >> | | ↘ |

To provide support for the elevator for tight turns and aerobatics, this mixer can be used to make the aileron function follow controls sent to the elevator. The mixer direction chosen must ensure that the flaps are deflected downwards when the elevator is oriented upwards and vice versa for a downward-oriented elevator– i.e. in opposite directions. This mixer can be made optionally on/off switchable with one of the switches or a control switch that is not self-restoring.

To configure symmetrical mixer values, move the elevator joystick to its center position, so that the marker frame surrounds both value fields. To configure asymmetric values, move the transmitter control to the corresponding side.

Values in the range -150% to +150% are possible, so as to adjust the function to the direction of servo rotation or direction of aileron deflection.

A simultaneous tap on the ▲▼ or ◀▶ keys of the right touch pad (**CLEAR**) will reset a changed value in a given active (inverse video) field back to 0%.

The "usual" values for this mixer are in the low two-digit range.

Model type: "2/4AIL 1/2/4FL"

If you have entered "2AIL 1FL" for the "Aileron/camber flaps" line on the »**Model type**« menu (page 94), then the "Wing mixers menu" on your transmitter will match the following screen image:

| W I N G M I X E R S | | | | | |
|----------------------|--------------|----------|----|------|------|
| ▶ Multi-flap menu | | | | | => |
| Brake settings | | | | | => |
| Aileron differential | | 0% | | | |
| Aileron | 2→4 | rudder | 0% | ---- | |
| Flaps | 6→3 | elevator | 0% | 0% | ---- |
| ▼ | << Normal >> | | | → | |

If, on the other hand, "2/4AIL 1/2/4FL" has been entered for the "Aileron/camber flaps" line of the »**Model type**« menu, page 94, then the "Wing mixers menu" on the transmitter should correspond to the figure below:

| W I N G M I X E R S | | | | | |
|---------------------|--------------|----------|----|------|------|
| ▶ Multi-flap menu | | | | | => |
| Brake settings | | | | | => |
| Aileron | 2→3 | rudder | 0% | ---- | |
| Flaps | 6→4 | elevator | 0% | 0% | ---- |
| ▼ | << Normal >> | | | → | |

Regardless of the combination of aileron and flap servos you choose, all of the parameters available can be adjusted separately for each flight phase.

Note:

For almost any menu option, you have the option of checking your settings by switching to the servo display screen, which is accessed with a simultaneous tap on the ◀▶ selection keys of the left touch pad. If you do, note however that the vertical lines on the »**Servo display**« move in the same direction for ailerons and in the opposite direction for flaps.

Before we address the details of this menu we would like to provide a brief explanation of the different display modes for the multi-flap menu:

Model type: "2 AIL 1 FL"

If servos have been connected to the receiver as described on page 61 and selected accordingly in the »**Model type**« menu, page 94, then the abbreviations "AILE" and "FLAP" refer to the following flaps:

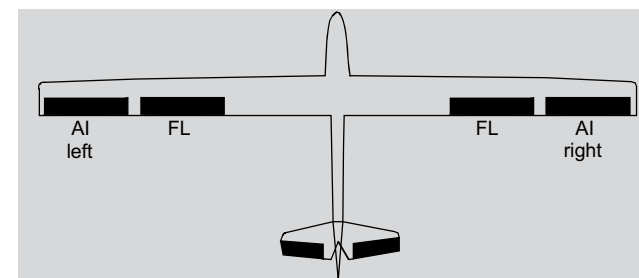

Since the options available on the wing mixer menu and its sub-menus vary according to the number of flap servos specified on the »**Model type**« menu, page 94, the list contains only those set-up options available for the given model.

Therefore, with a preset to "2AIL 1FL", the options for setting aileron functions to flaps will be suppressed, as will all setting options throughout the (right-side) column labeled "FL2".

| | | | | |
|--------------|------|------|-------|-------|
| ▶ Fl.pos | 0% | 0% | | |
| ▲ FL ▲ | 0% | 0% | +100% | +100% |
| HR → WK | 0% | 0% | 0% | 0% |
| << Normal >> | AILE | FLAP | ▼ | |

In addition, the settings for "Aile(ron) diff(erential)" are not found on the "multi-flap menu", as with "2AIL 2/4FL", but one level higher in the "Wing mixers" menu, see the screenshot at top left.

Model type: "2AIL 2FL"

If servos have been connected to the receiver as described on page 61 and selected accordingly in the »**Model type**« menu, page 94, then the abbreviations "AILE" and "FLAP" refer to the following flaps:

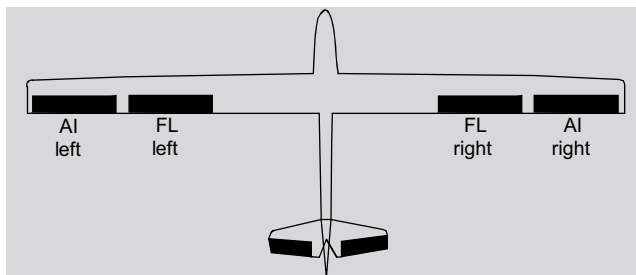

Since the options available on the wing mixer menu and its sub-menus vary according to the number of flap servos specified on the »**Model type**« menu, page 94, the list contains only those set-up options available for the given model.

Therefore, with a preset to "2AIL 2FL", all options for setting options for a second set of flap pairs will be suppressed throughout the (right-side) column labeled "FL2".

| | | |
|-------------|-------|----------------|
| ▶ ▲AI ▼ | +100% | 0% |
| Ail-tr | +100% | 0% |
| Diff. | 0% | 0% |
| Fl.pos | 0% | 0% |
| ▲FL ▲ | 0% | 0% +100% +100% |
| EI →FI | 0% | 0% 0% |
| <<Normal >> | AILE | FLAP ▼ |

Model type: "2AIL 4FL"

If servos have been connected to the receiver as described on page 61 and selected accordingly in the »**Model type**« menu, page 94, then the abbreviations "AILE", "FLAP" and "FL2" refer to the following flaps:

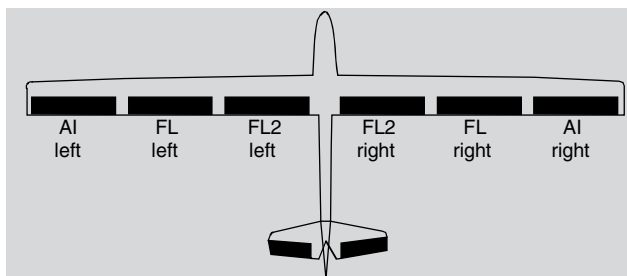

Since the options available on the wing mixer menu and its sub-menus vary according to the number of flap servos specified on the »**Model type**« menu, page 94, the list contains only those set-up options available for the given model.

| | | | |
|-------------|-------|----------------|-------------|
| ▶ ▲AI ▼ | +100% | 0% | 0% |
| Ail-tr | +100% | 0% | 0% |
| Diff. | 0% | 0% | 0% |
| Fl.pos | 0% | 0% | 0% |
| ▲FL ▲ | 0% | 0% +100% +100% | +100% +100% |
| EI →FI | 0% | 0% | 0% 0% |
| <<Normal >> | AILE | FLAP | FL2 ▼ |

Model type: "4AIL 2FL"

If servos have been connected to the receiver as described on page 61 and selected accordingly in the »**Model type**« menu, page 94, then the abbreviations "AILE", "AILE2" and "FL" refer to the following flaps:

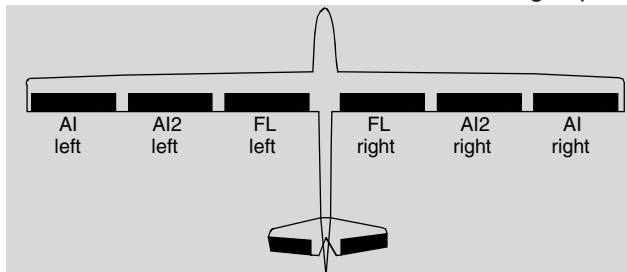

Since the options available on the wing mixer menu and its sub-menus vary according to the number of

flap servos specified on the »**Model type**« menu, page 94, the list contains only those set-up options available for the given model.

Therefore, with a preset to "4AIL 2FL", all options for setting options for the first and second set of aileron pairs as well as those for the flap pair will be displayed throughout.

| | | | |
|-------------|-------|-------|----------------|
| ▶ ▲AI ▼ | +100% | +100% | 0% |
| Ail-tr | +100% | +100% | 0% |
| Diff. | 0% | 0% | 0% |
| FL.pos | 0% | 0% | 0% |
| ▲FL ▲ | 0% | 0% | 0% +100% +100% |
| EI →FI | 0% | 0% | 0% 0% |
| <<Normal >> | AILE | AILE2 | FL ▼ |

Model type: "4AIL 4FL"

If servos have been connected to the receiver as described on page 61 and selected accordingly in the »**Model type**« menu, page 94, then the abbreviations "AILE", "AILE2", "FLAP" and "FL2" refer to the following flaps:

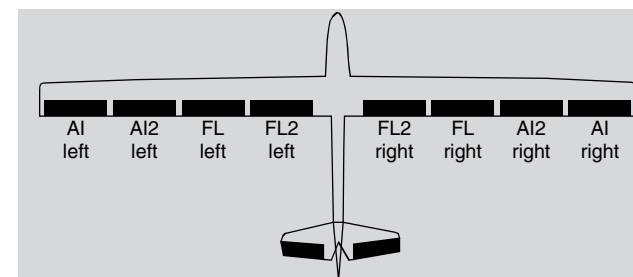

Since the "4AIL 4FL" selection represents the maximum possible number of wing servos, in addition to the columns labeled "AILE" and "AILE2" there will now also be columns available labeled "FLAP" and "FL2".

| | | | | |
|-------------|-------|-------|------|----------------------|
| ▶▲AI ▼ | +100% | +100% | 0% | 0% |
| Ail-tr | +100% | +100% | 0% | 0% |
| Diff. | 0% | 0% | 0% | 0% |
| Fl.pos | 0% | 0% | 0% | 0% |
| ▲FL ▲ | 0 | 0% | 0 | 0%+100+100%+100+100% |
| EI →FI | 0 | 0% | 0 | 0%+100+100%+100+100% |
| <<Normal >> | AILE | AILE2 | FLAP | FL2 ▼ |

Delta/flying wing type models with more than two wing flaps

If the "ELEVON" tail type (for a delta-wing or flying wing model) has been selected and number of wing flaps in the "Aileron/camber flaps" line of the »**Model type**« menu conforms to that menu's description, then activation of the elevator joystick will normally result in as little movement for both ailerons as for the inside flaps (FL) and, if present, (FL2). The reason for this is the default mixer ratio of 0% for all wing flaps set for the "EL→FL" mixer found in the "Multi-flap" menu:

| | | |
|-------------|-------|----------------|
| ▲AI ▼ | +100% | 0% |
| Ail-tr | +100% | 0% |
| Diff. | 0% | 0% |
| Fl.pos | 0% | 0% |
| ▲FL ▲ | 0% | 0% +100% +100% |
| ▶EI →FI | 0% | 0% |
| <<Normal >> | AILE | FLAP ▲ |

Accordingly, you must first specify your desired elevator control on the "EL → FL" line. Take care to ensure that up/down activation occurs in the right sequence.

Note:

The "Brake settings" sub-menu (see next double page) is also suitable for setting up the butterfly (crow) function with delta and flying wing models. In fine-tuning the deflection of the flap pairs AIL, FL and (if present) FL2, however, ensure that the moments created by one pair of flaps compensate the moments created by the other pair of flaps in each case. For example: the "up" effect of ailerons when deflected up should be compensated by a "down" effect from flaps when they are lowered.

Multi-flap menu

▲AI▼ (Aileron → camber flaps)
(suppressed by "2AIL 1FL")

| | | | |
|-------------|-------|------|----------------|
| ▶ ▲AI ▼ | +100% | 0% | 0% |
| Ail-tr | +100% | 0% | 0% |
| Diff. | 0% | 0% | 0% |
| Fl.pos | 0% | 0% | 0% |
| ▲FL ▲ | 0% | 0% | 0% +100% +100% |
| <<Normal >> | AILE | FLAP | FL2 ▼ |

The "▲AI▼" line can be used to make flight-phase dependent settings for the percentage of aileron action to result for the camber flap pair "FLAP" and, if present, also "FL2" when aileron control is exercised. (In the "AILE" column it is also possible to adjust the deflection of the aileron pair, if required.) Normally, however, the flaps should follow the ailerons with less of a deflection, i. e. the mixer ratio should be smaller than 100%.

The adjustment range of -150% to +150% means the direction of deflection can be adjusted, depending on the direction of rotation of the servos, to suit the ailerons.

A simultaneous tap on the ▲▼ or ◀▶ keys of the right touch pad (**CLEAR**) will reset the given active (inverse video) field to its default value shown in the figure.

Ail-tr. (aileron trim)

(suppressed by "2AIL 1FL")

| | | | |
|-------------|-------|-------|---------|
| ▲AI ▼ | +100% | 0% | 0% |
| ▶Ail-tr | +100% | 0% | 0% |
| Diff. | 0% | 0% | 0% |
| Fl.pos | 0% | 0% | 0% |
| ▲FL ▲ | 0% | 0% | 0% |
| 0% | +100% | +100% | |
| <<Normal >> | AILE | FLAP | FL2 ▼ ▲ |

In this line, you specify the percentage rate with which aileron trim is to affect "AILE", "FLAP" and – if present – "FLAP2".

The available range of values is -150% to +150%, relative to the adjustment range of the trim wheel.

A simultaneous tap on the ▲▼ or ◀▶ keys of the right touch pad (**CLEAR**) will reset the given active (inverse video) field to its default value shown in the figure.

Diff. (Differential for aileron function)

(With "2AIL 1FL", at one level higher in the »Wing mixers« menu, see figure on the previous double page.)

| | | | |
|-------------|-------|-------|---------|
| ▲AI ▼ | +100% | 0% | 0% |
| Ail-tr | +100% | 0% | 0% |
| ▶Diff. | 0% | 0% | 0% |
| Fl.pos | 0% | 0% | 0% |
| ▲FL ▲ | 0% | 0% | 0% |
| 0% | +100% | +100% | |
| <<Normal >> | AILE | FLAP | FL2 ▼ ▲ |

On this line, you set the aileron differential, plus the differential for the FLAP and FLAP2 wing flaps – if the latter are being activated as ailerons.

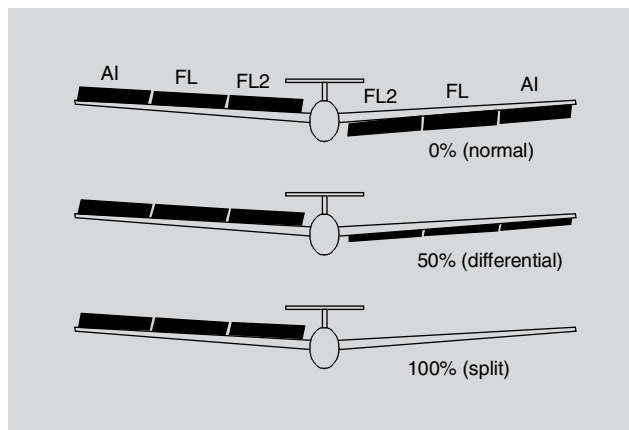

If you are unsure about the meaning of differential travel, please read the appropriate explanation at the start of this section on page 161.

The setting range of -100% to +150% permits correct differentiation direction adjustment regardless of the direction of rotation of aileron and flap servos.

A simultaneous tap on the ▲▼ or ◀▶ keys of the right touch pad (**CLEAR**) will reset the given active (inverse video) field to its default value shown in the figure.

Fl.pos (flap position)

| | | | |
|-------------|-------|-------|---------|
| ▲AI ▼ | +100% | 0% | 0% |
| Ail-tr | +100% | 0% | 0% |
| Diff. | 0% | 0% | 0% |
| ▶Fl.pos | 0% | 0% | 0% |
| ▲FL ▲ | 0% | 0% | 0% |
| 0% | +100% | +100% | |
| <<Normal >> | AILE | FLAP | FL2 ▼ ▲ |

Here, you set the flight phase-specific wing flap positions for all of the flaps present on the model in question. In this way, you can specify the flap positions that apply to each flight phase.

The adjustment range of -100% to +100% makes it possible to set the correct direction of travel regardless of the direction of rotation of the aileron and flap servos.

A simultaneous tap on the ▲▼ or ◀▶ keys of the right touch pad (**CLEAR**) will reset the given active (inverse video) field to its default value shown in the figures.

▲FL▲ (effect of flaps)

This line specifies the percentage of effect produced on aileron and flaps by the settings (if applicable, also flight-phase dependent settings) made for Input 6 in the »Control adjust« menu, page 108.

| | | | |
|-------------|-------|-------|---------|
| ▲AI ▼ | +100% | 0% | 0% |
| Ail-tr | +100% | 0% | 0% |
| Diff. | 0% | 0% | 0% |
| Fl.pos | 0% | 0% | 0% |
| ▶▲FL ▲ | 0% | 0% | 0% |
| 0% | +100% | +100% | |
| <<Normal >> | AILE | FLAP | FL2 ▼ ▲ |

For each flap pair, you can define either a symmetrical or an asymmetric effect. Position the transmitter control accordingly – either centrally or to the relevant side.

If each travel adjustment is left at +100% on the »Control adjust« menu, page 108, then values between 5% and 20% should generally be sufficient here.

A simultaneous tap on the ▲▼ or ◀▶ keys of the right touch pad (**CLEAR**) will reset the given active (inverse video) field to its default value shown in the figures.

Note:

By default, NO transmitter control is assigned to input 6 on the »Control adjust« menu. However, you can

assign a transmitter control or switch to this input at any time – also in a flight phase-dependent way – thus enabling different flap settings within a flight phase; see also example 2 on page 292.

EI → FI (elevator → flap)

To provide support for the elevator for tight turns and aerobatics, this mixer can be used to make the flap function follow controls sent to the elevator. The mixer direction chosen must ensure that the flaps are deflected downwards when the elevator is oriented upwards and vice versa for a downward-oriented elevator – i.e. in opposite directions.

For each flap pair, you can define either a symmetrical or an asymmetric effect. Position the transmitter control accordingly – either centrally or to the relevant side. Values in the range -150% to +150% are possible:

| | | | | |
|-------------|-------|------|--------|--------------|
| Ail-tr | +100% | 0% | 0% | 0% |
| Diff. | 0% | 0% | 0% | 0% |
| Fl.pos | 0% | 0% | 0% | 0% |
| ▲FL ▲ | 0% | 0% | 0% | 0%+100%+100% |
| ▶EI →FI | 0% | 0% | 0% | 0%+100%+100% |
| <<Normal >> | AILE | FLAP | FL2 ▼▲ | |

A simultaneous tap on the ▲▼ or ◀▶ keys of the right touch pad (**CLEAR**) will reset the given active (inverse video) field to its default value shown in the figures.

The "usual" values for this mixer are in the low two-digit range.

If a switch is assigned in the next line, "EI → FL" then the effect produced on flaps can be switched on and off with the elevator.

Important general notice:

Do not let control surfaces and servos strike their mechanical end-stops when large deflections are set! This is especially relevant in relation to the functions "▲AI▼", "▲FL▼" and possibly "▲FL2▼". Use the "- limit +" option (travel limit) available in the "Servo adjustments" menu (page 102), as required.

EI → FI offset (elevator)

| | | | |
|-------------|-------|------|--------------|
| Ail-tr | +100% | 0% | 0% |
| Diff. | 0% | 0% | 0% |
| Fl.pos | 0% | 0% | 0% |
| ▲FL ▲ | 0% | 0% | 0%+100%+100% |
| ▶EI →FI | 0% | 0% | 0%+100%+100% |
| <<Normal >> | AILE | FLAP | FL2 ▼▲ |

A value entered into the "EI" → FI" line offers support to the elevator during tight curves and aerobatics. This "EI" → FI offset" line determines the offset value introductory point where this percentage of effect on flaps is to take place for elevator action.

- With an offset value of 0%, flaps will be affected by elevator action beginning with the neutral position of the elevator joystick by the percentage set in the "EI" → FI".
- With an offset value other than 0%, flaps will be affected by movement of the elevator joystick, in either the "up" or "down" direction, only after reaching the preset offset point.

To set this offset point, put the elevator joystick at the offset point to be set (in either of the two possible directions). A brief tap on the center **SET** key of the right touch pad will store this position.

Tap on the center **SET** key of the right touch pad with the elevator joystick in its centered position to set the offset value back to 0% again. If a switch is assigned

in column "Switch", the effect produced on flaps can be switched on and off with the elevator.

Brake settings

Notes:

- The "Brake settings" menu is switched "off" if: "Motor on C1 forward / back" in the »Model type« menu (page 94) AND the "Motor" column of the »Phase settings« menu, (page 142) are set to "yes" for the currently active flight phase. Switch the flight phase if required:
- The "brake mixers" described below can also – and should also – be configured to be specific to individual flight phases.

Crow

| BRAKE SETTINGS | | | |
|----------------|------|------|-----|
| ▶Crow | 0% | 0% | 0% |
| Diff. reduct | 0% | 0% | 0% |
| Elevat. curve | | | => |
| <<Normal >> | | | |
| ▼ | AILE | FLAP | FL2 |

The "Crow" mixer function is actuated by control function 1, 7, 8 or 9, depending on the input assigned on the "Brake Offset" line in the »Model type« menu (see page 94).

| MODEL TYPE | |
|----------------------|---------------|
| Motor on C1 | None |
| Tail type | Normal |
| Aileron/camber flaps | 2AIL2FL |
| ▶Brake Offset | +100% Input 1 |
| ▲ | SEL |

Note:

The Offset, i.e. the activation direction, is also set in the »**Model type**« menu, page 94. This offset should be set to about +90% of stick travel (if the C1 joystick is used, this is generally located at the forward position of the stick). To extend the flaps, the stick must therefore be moved back towards the pilot. The remaining joystick travel of around 10% then has no effect, although it is not "lost", since the control travel is automatically expanded back to 100%.

Use the select fields of the columns labeled "AILE", "FLAP", "FL" and, if present, "FL2" to specify the extent and the direction that corresponding flap pairs are to follow when the airbrake control (control function 1, 7, 8 or 9) is operated. If the model has no airbrakes, leave the corresponding receiver output free or set it in the »**Mix only channel**« menu to "MIXonly" to be able to use it elsewhere.

Values in the range -150% to +150% are possible. A simultaneous tap on the ▲▼ or ◀▶ keys of the right touch pad (**CLEAR**) will reset the given active (inverse video) field to its default value shown in the figure.

• **"AILE" column**

When braking the model as it comes in to land, neither of the two aileron flaps should ever be deflected more than half of the possible travel upwards, to ensure that enough travel is available to control the model along its longitudinal axis (aileron function).

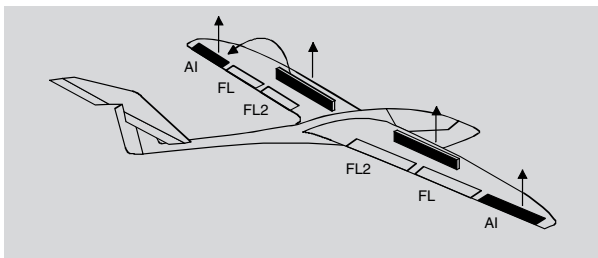

• **"FLAP" (and "FLAP2") column**

As the model is braked on the landing approach, both pairs of flaps can be set to deflect by different amounts, e.g.:

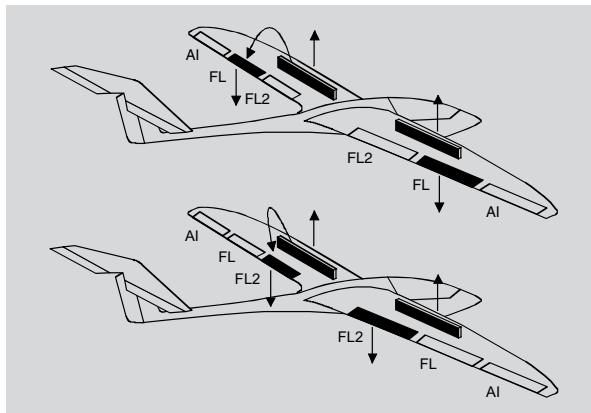

• **Combining AILE and FLAP for "Crow"**

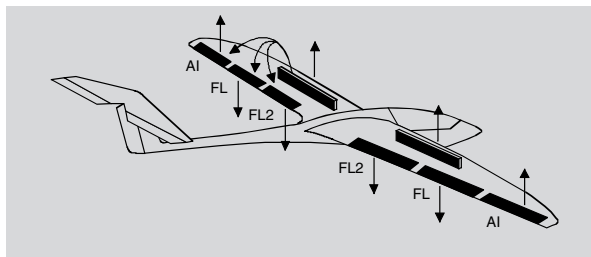

Though the airbrake mixers are set as described above, there is a special flap constellation, called "crow position" or "butterfly", that can also be set. This airbrake setting causes both ailerons move moderately upward while the flaps move downward as far as possible. Another mixer—see below, under the section "Elevat. curve"—is then used to trim the elevator such that the flight speed does not change significantly in comparison to the normal flight position. Otherwise, there is a danger that the model loses too much speed and then, after the braking system is retracted (e.g. to extend a landing approach that was too short, for example), pancakes or even stalls.

A tip for "seeing" the effect of brakes:

lift the flaps and look over and under the surface from the front. The larger the surface projected by the lifted flap, the greater the braking effect achieved.

Tips for activating airbrakes:

- When, in addition to aileron and camber flap servos, there is also a built-in servo for actuating wing airbrakes, it can be most simply connected to that receiver output—if free—whose input has been selected for the brake function, i.e. either on 1, 7, 8 or 9. If this is not possible then, as an alternative, use a free mixer to connect the selected brake control channel with the airbrake servo.
- To activate two airbrake servos, the best approach is to leave one servo on output 1 and to connect the second servo to a free output of your choice—for example, output 9. You then also assign this output to transmitter control 1 (as standard) on the »**Control adjust**« menu, page 108, see figure.

| | | | | | | | | |
|-----------|-----|-----|-----|--------|-------|--------|-----|--------|
| ►I9 | GL | Cn1 | --- | 0% | +100% | +100% | 0.0 | 0.0 |
| I10 | GL | fr | --- | 0% | +100% | +100% | 0.0 | 0.0 |
| I11 | GL | fr | --- | 0% | +100% | +100% | 0.0 | 0.0 |
| I12 | GL | fr | --- | 0% | +100% | +100% | 0.0 | 0.0 |
| «Normal » | | | | | | | | |
| ▼▲ | Typ | SEL | ↙_ | offset | - | travel | + | -time+ |

As you do, leave the settings for offset, travel, etc. at their default values. Also leave the default "GL" value in the column labeled "TYP" so that the second airbrake, like the first, operates in the same way across all flight phases.

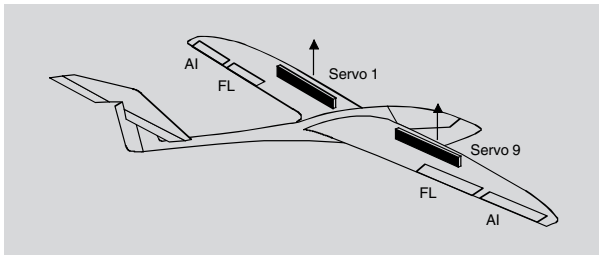

You can assure yourself that this works as stated by accessing the »**Servo display**« menu, accessible from almost any menu level with a brief simultaneous tap on the ◀▶ keys on the left touch pad (see page 262):

| | | | | | |
|----|---|-----|----|---|---|
| 1 | + | 100 | 2 | 0 | 0 |
| 3 | 0 | 4 | 0 | 0 | |
| 5 | 0 | 6 | 0 | 0 | |
| 7 | 0 | 8 | 0 | 0 | |
| 9 | + | 100 | 10 | 0 | 0 |
| 11 | 0 | 12 | 0 | 0 | |
| 13 | 0 | 14 | 0 | 0 | |
| 15 | 0 | 16 | 0 | 0 | |

If this relatively simply variant should prove impossible for whichever reasons, then the alternative is a solution with two free mixers—and potentially involving the »**Mix only channel**« menu, page 205.

In either case, however, the airbrake travels must then be fine-tuned on the »**Servo adjustment**« menu, page 102.

Diff. reduct

| BRAKE SETTINGS | | | |
|----------------|------|------|-----|
| Crow | 0% | 0% | 0% |
| ▶ Diff. reduct | 0% | 0% | 0% |
| Elevat. curve | => | | |
| << Normal >> | | | |
| ▼ ▲ | AILE | FLAP | FL2 |

Earlier, we discussed the problems with the butterfly (crow) configuration. Namely: that with the use of aileron differential, the aileron effect can be strongly (negatively) affected by the aileron elevation. This is firstly because further deflection of the one aileron upwards is (almost) no longer possible and secondly because the downward-deflected aileron—depending on the elevation and degree of differential configured—is often unable to achieve even its "normal" position.

To be able to restore the effect of the aileron altered in this way as far as possible, you should ensure that you make use of the automated "Differential reduction" feature. This feature continuously reduces the degree of aileron differential as the airbrake system is extended. The feature is configurable and can even be set to suppress differential entirely.

A value of 0% means that the "aileron differential" set at the transmitter remains fully in force. An entry that equals the % value set for aileron differential means the differential is fully eliminated once the butterfly function is at maximum travel, i.e. with flaps fully extended. Setting a reduction value greater than the aileron differential configured will eliminate the latter even before the full travel of the airbrake joystick.

Values can be set in the range 0 to 150%.

A simultaneous tap on the ▲▼ or ◀▶ keys of the right touch pad (**CLEAR**) will reset a changed value in a given active (inverse video) field back to 0%.

Elevat. curve

(Brake → Elevator)

| BRAKE SETTINGS | | | |
|-----------------|------|------|-----|
| Crow | 0% | 0% | 0% |
| Diff. reduct | 0% | 0% | 0% |
| ▶ Elevat. curve | => | | |
| << Normal >> | | | |
| ▼ ▲ | AILE | FLAP | FL2 |

If the airbrake control—to be set to 1, 7, 8 or 9 on the "Brake Offset" line of the »**Model type**« menu, page 95—is used to extend the flaps as described previously for the "Brake settings" menu, this will often have a negative effect on the aircraft model's airspeed. This mixer can be used to compensate this type of effect by applying a corrective value to the elevator.

A brief tap on the center **SET** key of the right touch pad will switch to the display screen shown below:

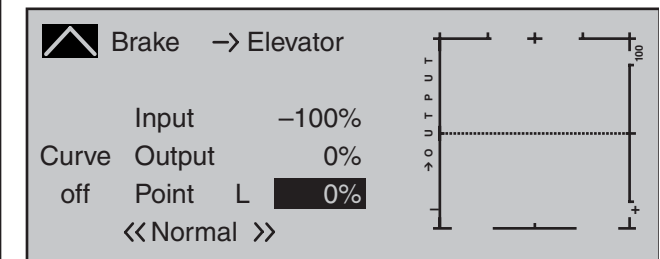

Setting notices for "Elevat. curve" (Brake → Elevator)

The offset set in the »**Model type**« menu, page 94, affects this mixer.

The vertical line on the display that indicates the position of the airbrake control only moves from the edge of the graph when the configured offset is exceeded. In doing so, airbrake control travel is automatically expanded back to 100%, as described in the »**Model type**« menu.

Accordingly, the mixer's neutral point always lies on the left edge, independently of the offset configured. Now adjust the elevator curve in the direction of the opposite end-point in accordance with requirements. Note that this method for setting the 5-point curve mixer follows the same principles that are applicable to the curve mixers, already described on page 128 in the context of the »**Channel 1 curve**« menu.

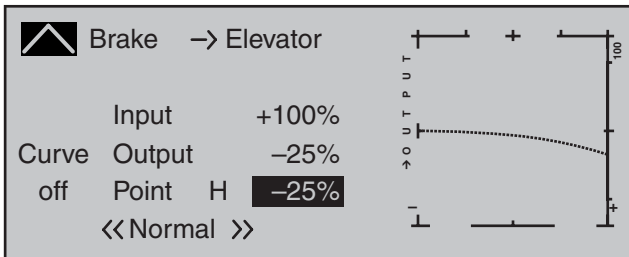

The selected setting should certainly be tried out in sufficient altitude and, if necessary, readjusted. When doing this, be sure to pay attention that the model does not slow down too much while the brake system is extended! Otherwise, you run the risk that, after the braking system is retracted, e.g. to extend a landing approach that was too short, for example, your model pancakes or even stalls.

Aileron differential

(Only for "2AIL 1FL". For the "2AIL 2/4 FL" selection, this is included on the Multi-flap menu, see page170.)

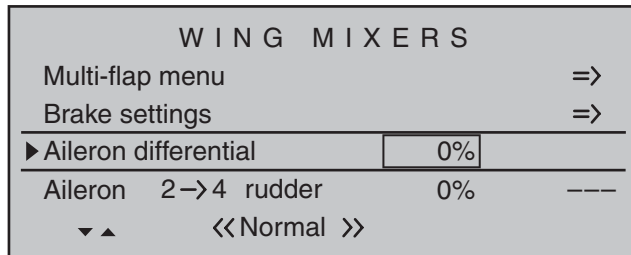

On this line you can set the aileron differential for the two aileron servos.

If you are unsure about the meaning of differential travel, please read the appropriate explanation at the start of this section on page 161.

The setting range of -100% to +150% permits correct differentiation direction adjustment regardless of the direction of rotation of aileron and flap servos.

A simultaneous tap on the ▲▼ or ◀▶ keys of the right touch pad (**CLEAR**) will reset a changed value in a given active (inverse video) field back to 0%.

Aileron 2 → 4 rudder

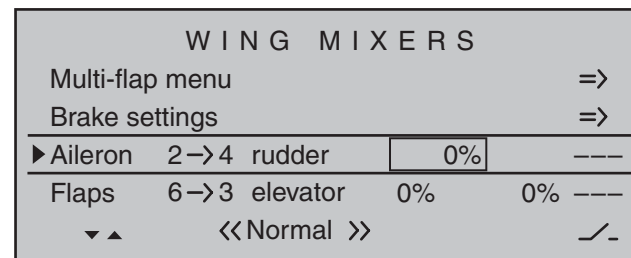

Here, you can set the degree to which the rudder follows commands acting on ailerons. This is used in particular in connection with aileron differential to suppress adverse yaw and thus make it easier to fly "clean" curves. You can of course still issue separate commands to the rudder.

The mixer direction is typically chosen to ensure that the rudder moves in the direction of the aileron that is deflected upwards.

Settings are always made symmetrically relative to the neutral point of the aileron joystick.

The adjustment range of ± 150% lets you set the direction of deflection as appropriate. Optionally, this mixer can be activated and deactivated with of the switches or a control switch that is not self-restoring so the model can be controlled with only the ailerons or rudder if desired.

A simultaneous tap on the ▲▼ or ◀▶ keys of the right touch pad (**CLEAR**) will reset a changed value in an active (inverse video) field back to 0%.

A value of around 50% is generally an excellent starting point.

Flaps 6 → 3 elevator

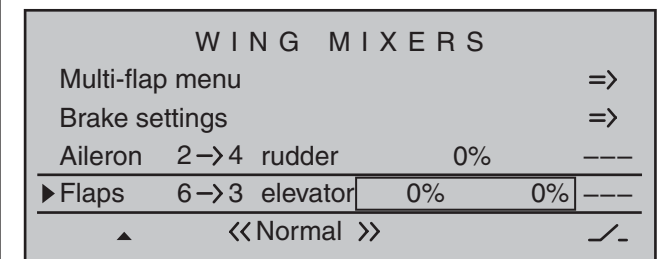

When setting camber-changing flaps, one side-effect can be to generate moments causing movement around the transverse axis. Equally, however, it may also be desirable that e.g. your aircraft model opts for a more pacey flight style with the flaps slightly raised. This mixer can be used to achieve both results.

With this mixer, the extension of the flaps—depending on the value configured—automatically ensures the elevator position follows suit. Symmetrical or asymmetrical settings relative to the neutral point of the flap control are possible.

If required, the mixer can be switched on or off by assigning a switch in the right column.

Values can be set in the range 150 to 150%. The "typical" values configured for this mixer are single-digit or low two-digit values.

A simultaneous tap on the ▲▼ or ◀▶ keys of the right touch pad (**CLEAR**) will reset a changed value in a given active (inverse video) field back to 0%.

Note:

If a transmitter control or switch has been assigned in the »**Control adjust**« menu, as described under "▲FL▼" on page 171, then that setting will also have an effect on this mixer.

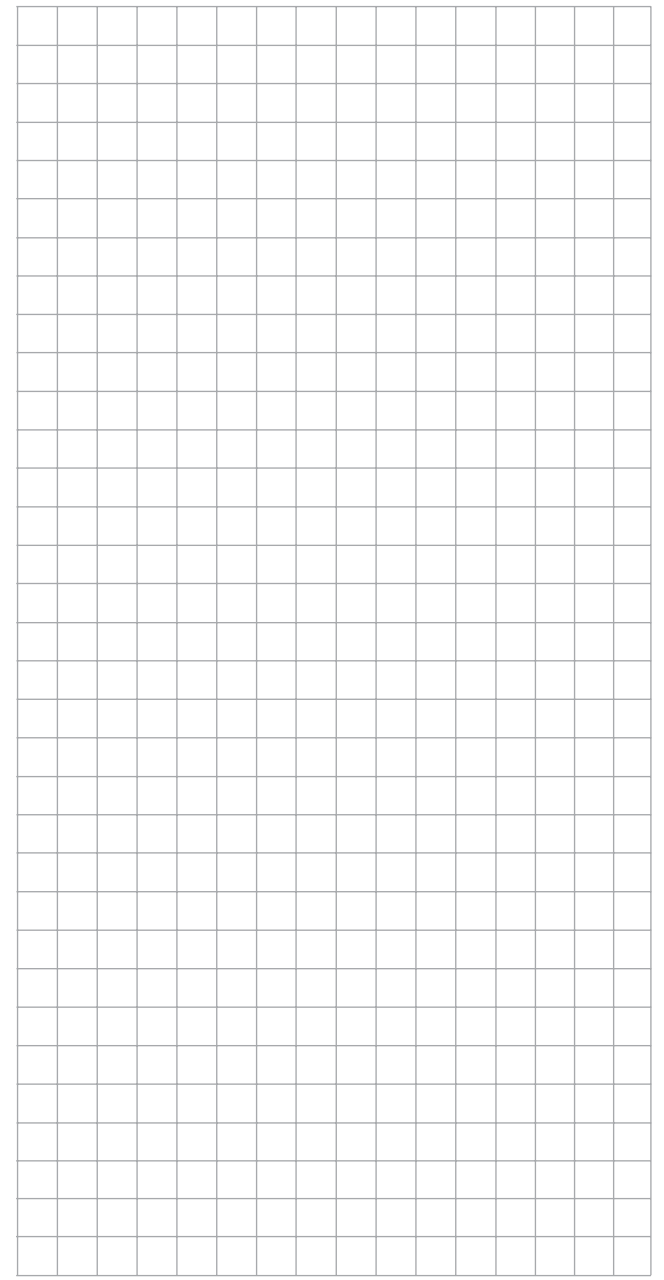
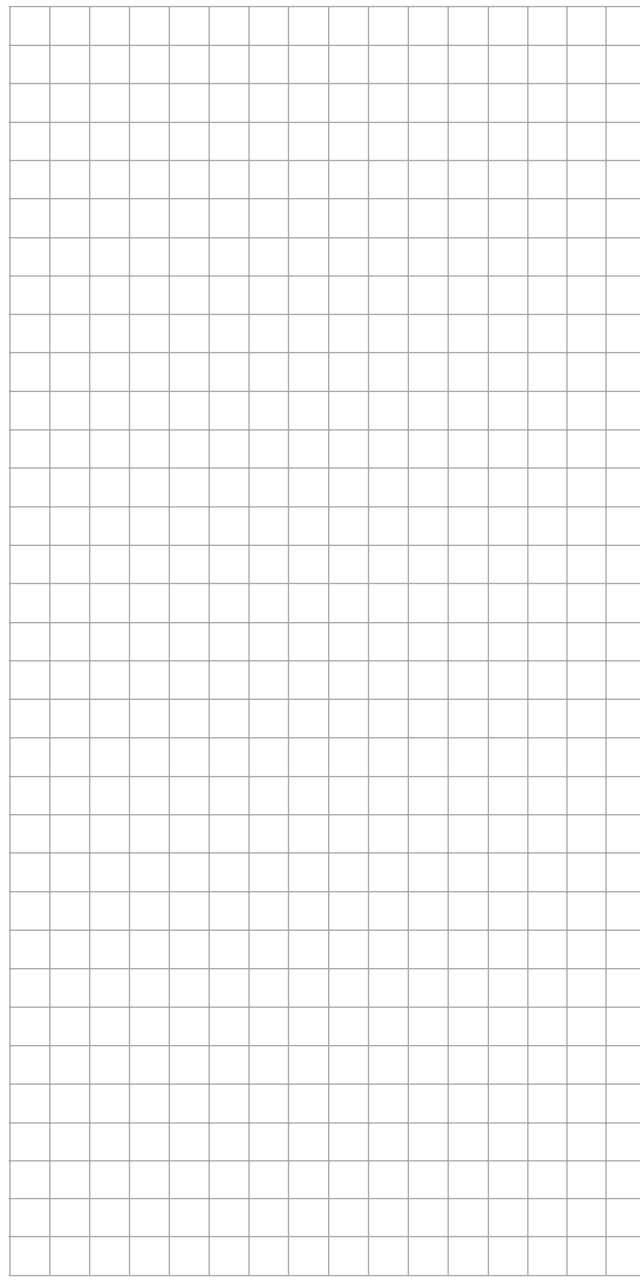
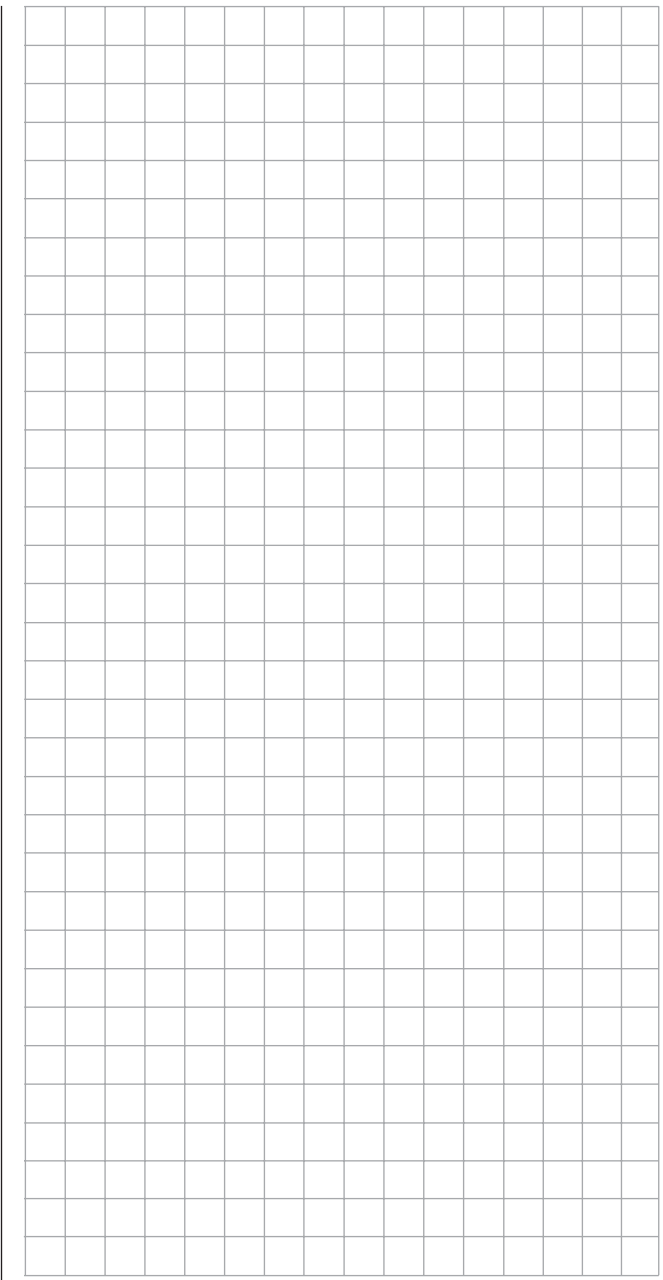

✂ Helicopter mixer

Flight phase-specific setting of collective pitch, throttle and tail rotor

In this menu ...

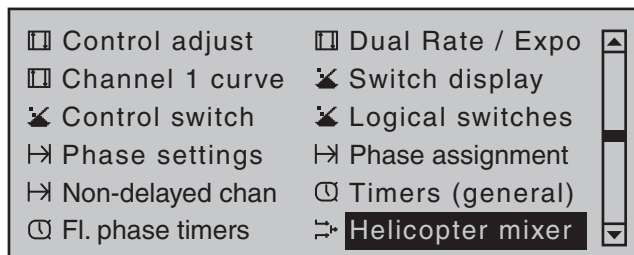

... all of the flight phase-specific helicopter mixers are described, with the exception of the mixers for auto-rotation flight (discussed from page 190 onward.) These mixers are used for the basic set-up of a model helicopter.

For flight phase programming, see the menus:

- »Basic settings, model«, page 84
- »Phase settings«, page 146
- »Phase assignment«, page 148

When the switch for a specific flight phase is actuated, then the name of the given flight phase, e.g. «Normal», will be displayed at the lower left edge of the display screen:

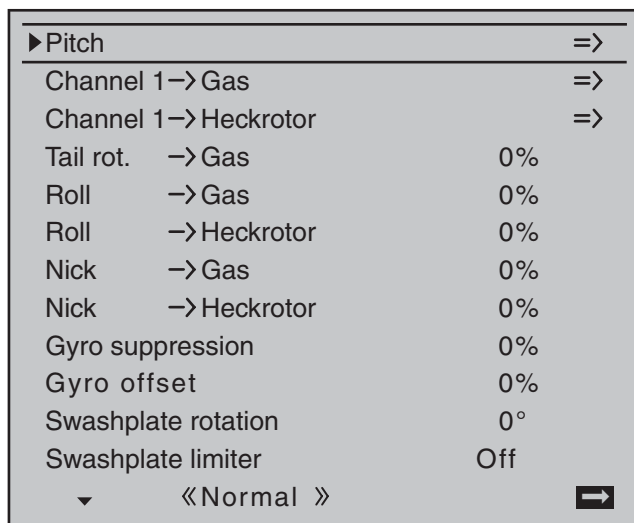

In each of these flight phases—with the exception of the auto-rotation phase—the typical helicopter mixing and coupling functions shown in the screenshot above are available for setting up the model helicopter. These functions are described in the first part of this comprehensive chapter.

General information on mixers, (see also pages 159 and 192)

An arrow "→" indicates a mixer. A mixer "branches off" the signal flow of a control function at a particular point, in order to use this flow to cause a predetermined effect on a further control channel and, ultimately, the receiver output. "Pitch ax → Tail rot" mixer means, for example, that when the pitch-axis joystick is actuated, the tail rotor servo must also react within the scope of its setting.

Basic programming procedure:

1. Select the mixer by using the selection keys of the left or right touch pad.
Depending on the mixer involved, the bottom display line will show either **SEL** or the (indicating a change to a second page is necessary).
2. A brief tap on the center **SET** key of the right touch pad will permit direct settings for linear mixer ratios. Use the selection keys to set the mixer ratio.
Otherwise you will need to switch to the second screen page where you can set up the appropriate curve mixer.
A simultaneous tap on the or keys of the right touch pad (**CLEAR**) will reset a changed value in a given active (inverse video) field back to 0%.
3. Another tap on the center **SET** key of the right touch pad will complete the entry.
4. A tap on the center **ESC** key of the left touch pad will cause a return to the previous display page.

Description of helicopter mixers

To set collective pitch curves as well as the two mixers, "Channel 1 → Throttle" and "Channel 1 → Tail rotor", there are curve mixers available in all flight phases. Accordingly, these mixers also permit the programming of non-linear mixing ratios along the path of joystick travel, if required. Switch to the display screen for curve settings with a brief tap on the center **SET** key of the right touch pad, see description below.

The curve is set up basically in the same way as the Channel 1 curve for helicopters, but we will describe it again here in detail using pitch configuration as an example, to save you having to leaf through the manual.

In the remaining lines, first activate the value field and then use the selection keys of the left or right touch pad to set a mixer value in the value field (inverse video).

The settings available are rounded off with the "Swashplate limiter" option: This option can be set to restrict maximum deflection of the swashplate servo in the sense of a limiter. Together, these settings configure the basic set-up of the helicopter model. In the "Autorotation" flight phase as described on page 190, however, the mixers "Channel 1 → Throttle" and "Channel 1 → Tail rot" are not needed and therefore switched to a configurable default value.

Changed parameters can be reset to their respective default values at any time with a simultaneous tap on the or keys of the right touch pad (**CLEAR**).

Pitch (Pitch curve (Channel 1 → Pitch))

If necessary, use the selection keys of the left or right touch pad to move to the "Pitch" line then tap briefly on the center **SET** key of the right touch pad.

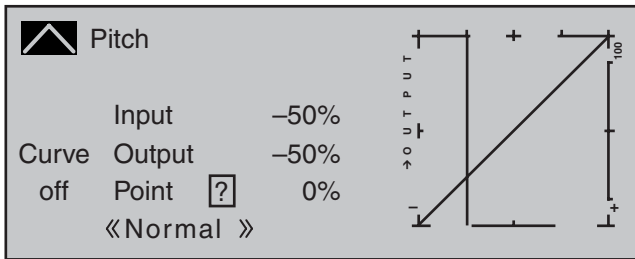

Unlike the »Channel 1 curve« menu, this display is only associated with the control curve of pitch servos, whereas the the "Channel 1 curve" affects all servos controlled by the throttle/pitch joystick.

Note that the output signal of the "Channel 1 curve" option thus functions as an input signal for the collective pitch curve programmed here: In the graph, the vertical line is synchronized with the throttle/collective pitch stick and therefore follows the current Channel 1 curve characteristic.

The control curve can be defined (separately per flight phase) by up to 8 points, termed "reference points", placed at any point along the joystick travel.

Initially, however, fewer reference points are adequate for setting up the collective pitch curve. We recommend beginning with three reference points to start with. These three points, namely the two end-points "Pitch low (L)" (= -100% control travel) and "Pitch high (H)" (= +100% control travel) plus a point at the center of control travel still to be set, define an initially linear profile for the pitch curve.

Programming details

First, switch to your chosen flight phase, e.g. «Normal». The throttle/collective pitch stick is used to move the vertical line in the graph between the two end-points "Point L" (minimum pitch at -100%) and "Point H" (maximum pitch at +100% control travel): at the same time, the current joystick position is shown numerically on the "Input" line (-100% to +100%).

The point at which the vertical line crosses the curve is termed the "Output", and can be varied at the maximum of 8 reference points within the range -125% to +125%. A control signal modified in this way affects only the collective pitch servos.

In the example to the left, the joystick is at exactly 0% of control travel and also generates an output signal of 0%, since the characteristic curve is linear.

Up to six additional reference points can be set between the two end-points "L" and "H", although the distance between neighboring reference points must not be less than approx. 25%.

Setting reference points

Move the joystick. If the display shows a framed question mark, then you can set the next reference point with a tap on the center **SET** key of the right touch pad. Simultaneously, the "?" is replaced by its number and the value field to the right of the reference point number is highlighted:

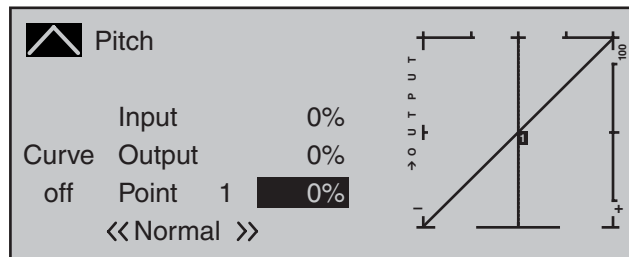

The order in which up to six reference points are generated between the end-points "L" and

"H" is irrelevant since these reference points are continuously renumbered automatically from left to right as they are entered.

Configuring reference points

To configure a point, use the joystick to move the vertical line onto the point you wish to change. The number and current curve value of this point are displayed on the left side of the display, on the "Point" line. Briefly tap the center **SET** key of the right touch pad. Use the selection keys on the right touch pad to change the current curve value shown in the highlighted field. The possible range is -125% to +125% and changes do not affect neighboring reference points.

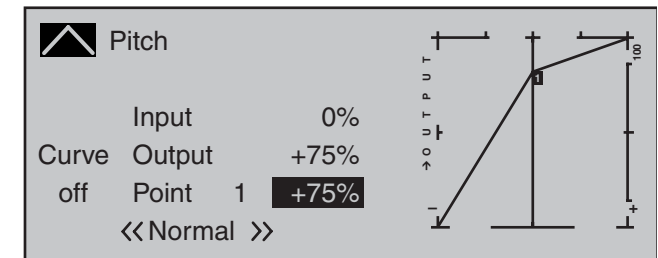

In this sample screen image, reference point "1" has been set to +75%.

If you wish, however, other points can also be set. At -50%, for example ...

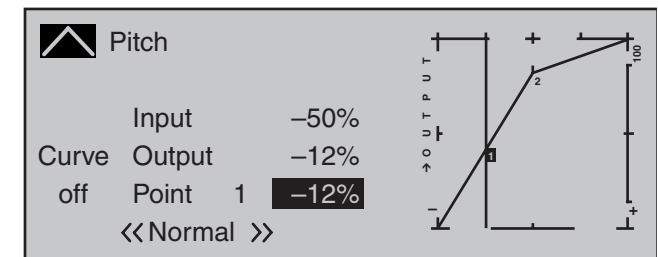

... and/or a further point at +50%:

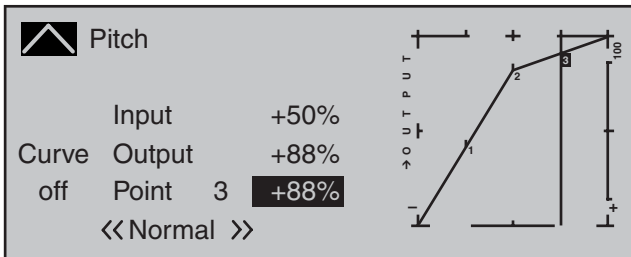

To do so, use the joystick to move to the corresponding area. As soon as a "?" appears in the marker frame on the "Point" line, the respective point can be set by touching the selection keys of the right touch pad. Just as with other points, this can be set ...

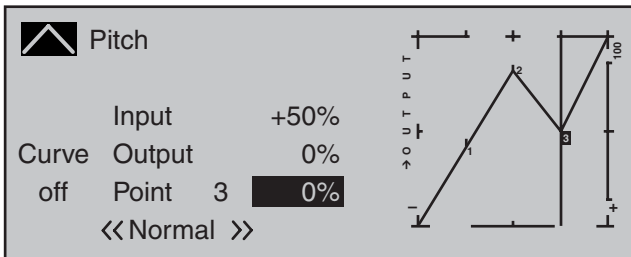

... or, reset again with a simultaneous tap on the ▲▼ or ◀▶ selection keys of the right touch pad (**CLEAR**). The "L" and "H" points, on the other hand, CANNOT be deleted.

Trim point function

Alternatively, a jump up or down to reference points already set, L, 1 ... max. 6 and H, can be accomplished by using the ◀▶ selection keys on the left touch pad. The selection keys on the right touch pad can then be used to change the reference point jumped to as described above, entirely independently of the control position.

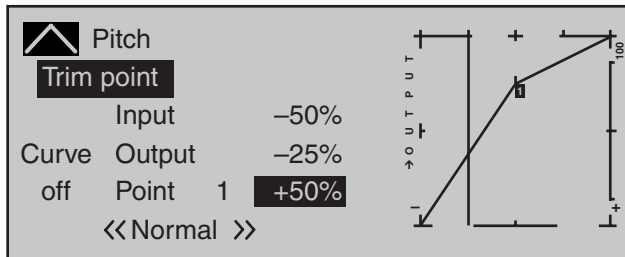

In this simple example, the pitch joystick—represented by the vertical line—is halfway between "Pitch minimum" and the midpoint of control travel (input = -50%). However, "Point 1" will be relocated to control center at a point value of +50%, resulting in a momentary output value of -25%.

One touch on the center **ESC** key of the left touch pad terminates this trim point function.

Trim offset function

When a value field is active, i.e. in inverse video, it is not only possible, as previously described, to jump up or down to reference points already set with the ◀▶ selection keys of the left touch pad and to make a change with the selection keys of the right touch pad, but also an existing curve can be vertically repositioned within a range of ±25% through use of the ▲▼ keys on the left touch pad. Starting with a point value for "Point 1" at 0%, the control curves in both of the following figures have been vertically shifted within the ±25% range by the trim offset function:

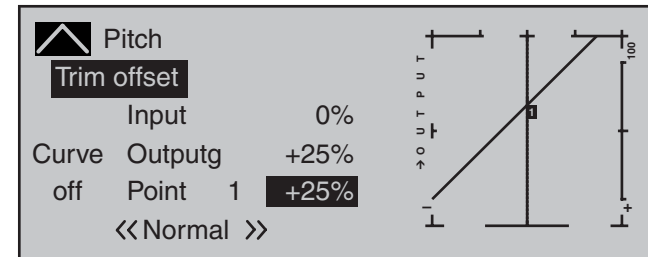
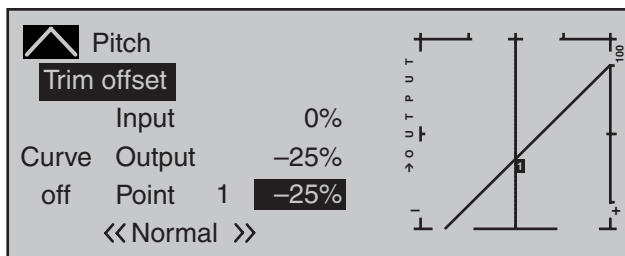

A tap on the center **ESC** key of the left touch pad will also terminate this function.

Trim x-axis function

This function is activated by tapping the left (◀) or right (▶) selection key of the right touch pad with an active (i.e. inverse video) value field. You can then use the selection keys on the right touch pad to reposition the active point horizontally or vertically as you wish. In the figure below, "Point 1" which was just shifted to +50% with the trim point function, will now be shifted to the left:

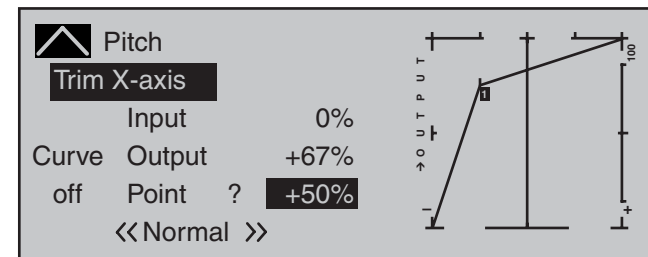

Notes:

- If the point is repositioned horizontally further away from the current control position than approx. ±25%, a "?" sign will reappear in the line Point. This question mark does not refer to the repositioned point, however: instead, it signifies that a further point can be set at the current control position.

- Please note that the percentage value on the "Output" line always relates to the current joystick position and not to the position of the point.

Smoothing the collective pitch curve

In the example below, sample reference points have been set ...

- reference point 1 to +50%,
- reference point 2 to +75% and
- reference point 3 to -50%

... as described in the last section.

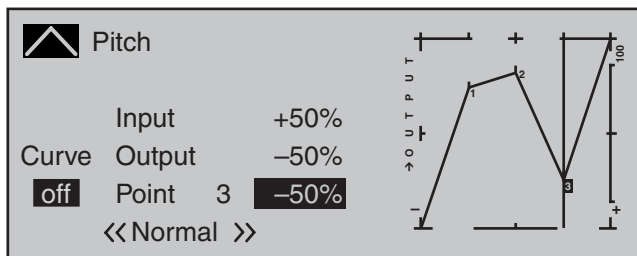

This "jagged" curve profile can be smoothed automatically simply by pressing a button.

Do this – from a situation as illustrated – with a brief tap on the ▼ selection key of the left touch pad. This will cause a switchover from "(Curve) off" to "(Curve) on" (or vice versa).

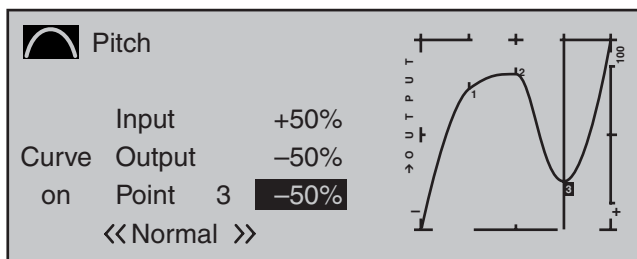

Notes:

- If the joystick does not coincide with the exact reference point, please note that the percentage value on the "Output" line always relates to the current joystick position.

- The figures on these pages show control curves created only for the purpose of illustration. Please note, therefore, that the curve characteristics displayed do not in any way represent real-life collective pitch curves. A specific application example can be found in the programming examples on page 312.

The following three graphs show typical 3-point pitch curves for various flight phases, such as hovering, aerobatics and 3D flight.

The vertical bar depicts the current joystick position. Please note that trim values greater than +100% and less than -100% cannot be presented in the display.

Sample collective pitch curves for various flight phases:

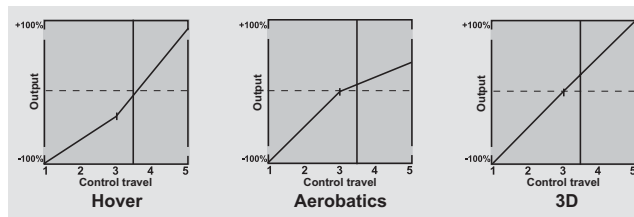

Notice about marker keys:

If marker keys have been set in the »Basic settings, model« menu, page 91, touching a key while in this graph will set a dashed vertical line to show the position of the C1 joystick at the time the key was pressed.

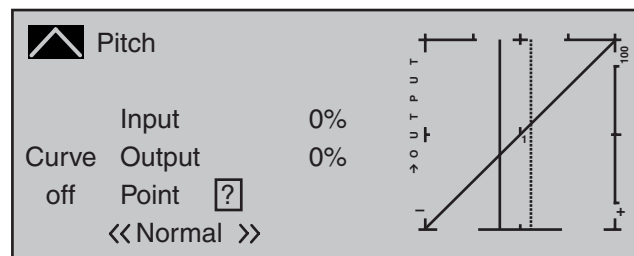

Move the C1 joystick (continuous line) to the marker

line in order to read out the input and output values. If the marker line, for example, indicates momentary hovering flight and this is to be put exactly in control center then it is only necessary to transfer the "output" value of the marker line, in this example, shift control center to reference point "1".

Erasing reference points

To delete one of the reference points (1 to max. 6), use the joystick to move the vertical line into the vicinity of the reference point in question. As soon as the reference point number and its associated value is shown on the "Point" line (see screen image above), following activation of the value field on the "Point" line now in inverse video with a simultaneous tap on the ▲▼ or ◀▶ keys of the right touch pad (**CLEAR**) it can be erased. Complete the operation with a brief tap on the center key **ESC** of the left touch pad.

Channel 1 → Throttle

(Throttle curve)

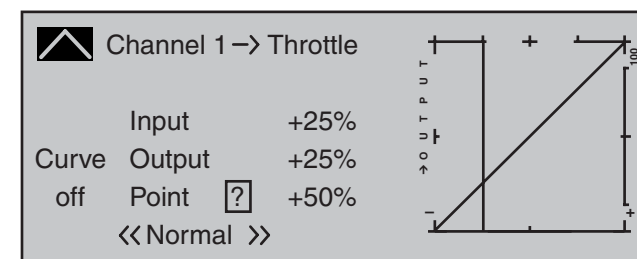

Unlike the »Channel 1 curve« menu, this display is only associated with the control curve of the throttle servo, whereas the the "Channel 1 curve" affects all servos controlled by the throttle/pitch joystick.

Note that the output signal of the "Channel 1 curve" menu thus functions as an input signal for the throttle curve programmed here: In the graph, the vertical line is synchronized with the throttle/collective pitch stick and therefore follows the current Channel 1 curve characteristic.

The throttle curve can also be defined (separately

per flight phase) by up to 8 points, termed "reference points", placed at any point along the joystick travel. The reference points are defined, adjusted and erased in the usual way, as explained in the previous section on the collective pitch curve. Start by defining the throttle curve with three points, namely the points "L" and "H" at the extremes, plus the Point "1" still to be set in the control center in order to match the motor power curve to the collective pitch curve.

Helicopter with carburetor or electric drive system with speed CONTROLLER

This setting relates only to the control curve of the throttle servo or the speed controller.

Setting the throttle curve to suit a helicopter equipped with a speed controller is discussed in the following section.

As with the configuration of the collective pitch curve (see previous page), the throttle curve can also be defined by up to 8 points.

- In each case, set the control curve so that when the throttle/collective pitch stick is in its end position, the carburetor is fully open or the controller of an electrically-powered helicopter is set to maximum (except for auto-rotation flight, see page 190).
- For the hover point, which is normally at the control center, the carburetor setting or power control for the speed controller must be matched to the collective pitch curve so that the correct system rotational speed is obtained.
- At the minimum position of the throttle/collective pitch stick, the throttle curve must first be configured so that a glow motor runs at a speed considerably higher than idle speed and the clutch is firmly engaged.

Starting and stopping of the motor—whether combustion or electric drive—always takes place within the given flight phase as a consequence of the throttle limiter and the "Thr. CutOff" option (see below).

This makes it unnecessary to program the two flight phases that may be familiar to you from using other remote control systems—namely "with idle-up" and "without idle-up", and with the associated "waste" of a flight phase for this purpose—since the **MC-20** HoTT program offers a much more flexible approach to fine-tuning and optimizing increases to system rotational speed below the hover point than the "idle-up"

approach taken by older **mc** remote control systems. Ensure that the throttle limiter is closed before starting a motor with carburetor, i.e. so that the carburetor can be adjusted within the idle range only with trim. Ensure that you follow the safety instructions on page 189 at all times. If the throttle is set too high when switching on the transmitter, you will receive audible and visible warnings!

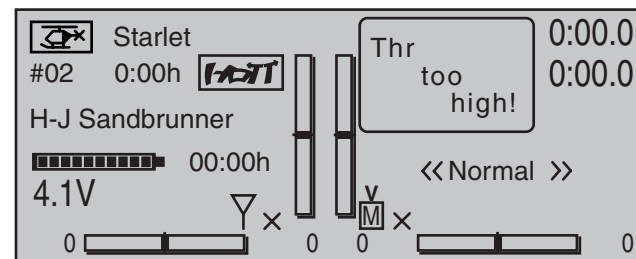

The following three graphs show (typical) 3-point throttle curves for various flight phases, such as hovering aerobatics and 3D flight.

Sample throttle curves for various flight phases:

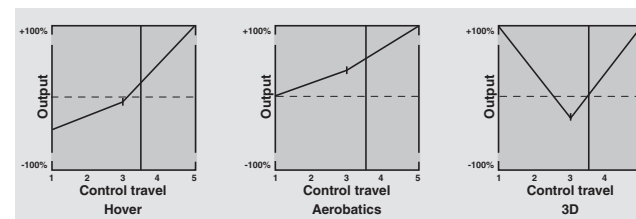

Notes on using the "throttle limit" function:

- The throttle limit function should be used in any case (»**Control adjust**« menu, page 117). At the rear limit of the default transmitter control, the right-side throttle limit proportional rotary slider, the throttle servo is completely decoupled from the throttle curve, the motor is at idle and will respond only to C1 trim. This option permits the motor to be started in any flight phase and to shut the motor off with the "Thr. CutOff" option.

Once the motor has started, push the throttle limiter *s l o w l y* in the direction of the opposite end-point to put actuation of the throttle servo fully under the control of the throttle/collective pitch joystick once again. In order to prevent the throttle servo from being restricted by the throttle limiter in the full throttle direction, set control travel on the plus-side of the column labeled "travel" to +125% in the "T116" line of the »**Control adjust**« menu. Leave the default value of "GL" in the "Type" column alone, however, to configure this setting globally for all flight phases.

For a more finely-tuned control travel curve for the throttle limit control, you can also use the "Expo throttle limiter" (page 100). This gives you the option of defining the idle setting at the throttle limit control's center position, as readily determined both visually and audibly.

Set the throttle limiter to its center position and adjust the "EXPO thro lim." value as far as is needed until the motor is idling smoothly with the throttle limit control set at its center point. In this position, the motor will then start without any problems. To switch off, turn or push the throttle limit control—that is, without C1 cutoff trim—to its rearmost end-point. As you do, ensure that the affected servo cannot hit an end-stop mechanically. The throttle restriction set by the throttle limiter is made visible as a horizontal bar in the diagram:

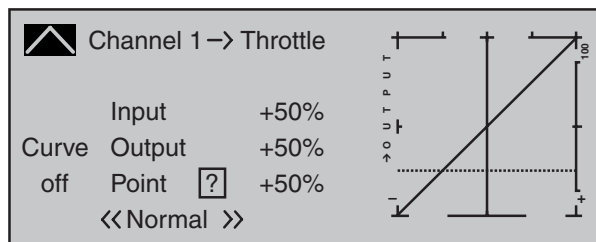

The output signal for the throttle servo can never be higher than that set by the horizontal bar. In this example, about a maximum of +25%.

- Since electric drive systems have no need for an idle setting, the basic configuration of settings for an electrically-powered helicopter merely involves making sure that the control range of the throttle limiter is both higher and lower than the adjustment range of the speed controller (usually -100% to +100%) by a safe margin. If necessary, therefore, adjust the "travel" setting of the throttle limiter as appropriate on the "T116" line of the »**Control adjust**« menu. Leave the default value of "GL" in the "Type" column alone, however, to configure this setting globally for all flight phases. Fine-tuning of the throttle curve itself, however, must take place in flight – as with a glow-powered helicopter.
- If you wish to record the flight time of a (glow-powered) helicopter, you can assign a control switch to the throttle limit slider, and then use this to switch a timer on and off; see page 135.

For auto-rotation flight, an automatic switch-over is made from this mixer to a configurable default value; see page 190.

Helicopter with speed CONTROLLER

Unlike speed *controllers*, which merely adjust output level in a manner similar to a carburetor, a speed regulator keeps speed in the system it monitors constant by regulating its output autonomously. In the case of combustion motor powered helicopters, the regulator therefore controls the throttle servo itself as appropriate or, for an electric helicopter, the motor's speed controller. *Therefore, speed regulators do not need a traditional throttle curve but rather only a speed setting.* A deviation from the preset speed will therefore only take place if the level of output required exceeds the maximum level available.

Usually, receiver output 8 is reserved for connecting a speed regulator; refer to the receiver layout on page 65. However, if this connection is used there will be no throttle limit function because the throttle limit function can only be implemented via the "Channel 1 → Throttle" mixer which is on the –then unused–output 6. To make the comfort and safety features of a throttle limiter available, a speed regulator should be connected to receiver output 6 (contrary to the general connection notices) and only requires appropriate adaptation to the throttle curve so it can take over the task of the "conventional" transmitter control.

Since in this case the "throttle curve" only regulates the target speed of the motor controller and this target motor speed should typically remain constant over the entire collective pitch adjustment range, the "Channel 1 → Throttle" mixer must be used to set a horizontal line—i.e. every (pitch) input value will result in the same ("throttle") output value—whose "height" is defined by the target motor speed.

First, therefore, the reference points "1" to "6"—if present and set—are erased. Following this, the reference points "L" (input = -100%) and "H" (input = +100%) are then each set to the same value, for example:

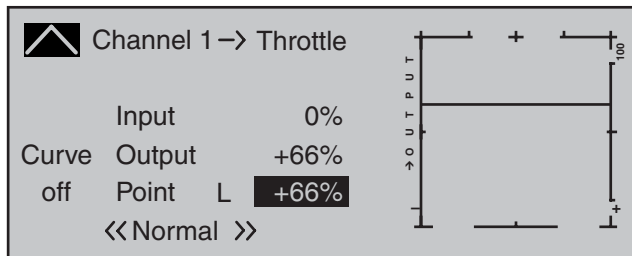

The value to be set depends both on the speed controller used and on the target motor speed that is desired, and can, of course, be varied according to the flight phase.

For auto-rotation flight, an automatic switch-over is made from this mixer to a configurable default value; see page 190.

Channel 1 → Tail rot. (static torque compensation)

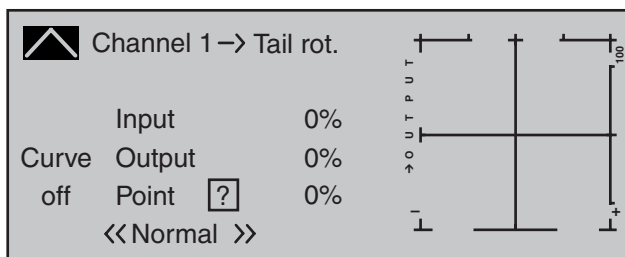

The default approach here is to preset a torque compensation curve with a linear mixer ratio of a uniform 0%, as is required for a gyro sensor working in "heading lock mode" – see the screen image above.

Important notice:

In this context, ensure that you comply with the instructions on adjusting your gyro: if not, you risk making adjustments that render your helicopter impossible to fly.

If, on the other hand, you use your gyro sensor in the "normal" operating mode, or if it only has what is termed "normal mode", then configure the mixer as follows:

As with the configuration of the collective pitch curve (see page 176), the control curve of the tail rotor can also be defined by up to 6 points. If required, therefore, you can modify the mixer at any time and preset both symmetrical and asymmetric mixer ratios both above and below the hover point. Before you do, however, ensure you have entered the correct direction of rotation for the main rotor on the »**Helicopter type**« menu.

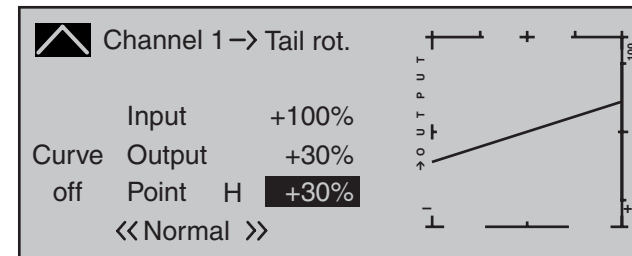

Starting with values of -30% for point "L" and +30% for point "H", the mixer is to be configured in such a way that the helicopter, even during prolonged vertically ascending or descending flights, does not deviate from the yaw axis as a result of the main rotor's altered torque while hovering. For hovered flight, trim should only be affected by way of the (digital) tail rotor trim wheel.

For a reliable torque compensation setting, it is essential that the collective pitch and throttle curves have been set up correctly, i.e. that the rotor speed remains constant over the collective pitch's full adjustment range.

This third curve mixer applies only to the control curve of the tail rotor servo when the throttle/collective pitch stick is moved, whereas the "Channel 1 curve" (see page 131) acts on all servos that are affected by the throttle/collective pitch stick. Note that the output signal of the "Channel 1 curve" option also functions as an input signal for the tail rotor curve programmed here: In the graph, the vertical line is synchronized with the throttle/collective pitch stick and follows the current Channel 1 curve characteristic from the »**Channel 1 curve**« menu.

In the auto-rotation flight phase this mixer is automatically switched off.

Tail rotor → throttle

| | | |
|----------------------|----|-----|
| Pitch | => | |
| Channel 1→Throttle | => | |
| Channel 1→Tail rot. | => | |
| ▶Tail rot. →Throttle | | 0% |
| Roll →Throttle | | 0% |
| ▼▲ <<Normal >> | | SEL |

While the tail rotor normally compensates for the effect of main rotor torque on the fuselage, it is also used to control the helicopter around the vertical axis. Increasing tail rotor thrust requires a corresponding adjustment to motor power, however, to avoid a fall-off in system rotational speed.

This mixer sets the extent to which the throttle follows the tail rotor. The throttle will follow on one side only, to the side on which the tail rotor thrust is increased. The setting range is therefore 0 to +100%. The direction depends on the main rotor's direction of rotation (left or right), and this must first be set correctly on the »**Helicopter type**« menu. For left-hand rotation systems, the throttle follows the tail rotor when the tail rotor joystick is moved to the left, and vice versa for right-hand rotation systems. A simultaneous tap on the ▲▼ or ◀▶ keys of the right touch pad (**CLEAR**) will reset a changed value in an active (inverse video) field back to 0%.

In the auto-rotation flight phase this mixer is automatically switched off.

Set-up notes:

To set the mixer value accurately you should either first fly several high-speed pirouettes against the direction of main rotor rotation or, if a strong wind is blowing, hover at right angles to the wind with a sufficiently large tail rotor deflection. Set the mixer value so that there is no fall-off in system rotational speed.

Roll → Throttle and Pitch axis → Throttle

| | | |
|---------------------|----|-----|
| Channel 1→Tail rot. | => | |
| Tail rot. →Throttle | | 0% |
| Roll →Throttle | | 0% |
| Roll →Tail rot. | | 0% |
| ▶Nick →Throttle | | 0% |
| ▼▲ <<Normal >> | | SEL |

Increasing collective pitch is not the only change that requires the throttle to follow suit: major cyclic control movements also require this, i.e. if the swashplate is tilted in any direction. The **MC-20** HoTT program lets you adjust the degree of throttle follow separately for roll and pitch-axis controls.

This offers particular advantages in aerobatic flying, e.g. when flying a roll: here, with moderate collective pitch values and the carburetor only about half-open, cyclic control travels are nonetheless executed that require much higher performance from the motor. The mixer value can be varied within the range 0 to +100%. The correct mixer direction is automatically taken into account.

A simultaneous tap on the ▲▼ or ◀▶ keys of the right touch pad (**CLEAR**) will reset a changed value in an active (inverse video) field back to 0%.

In the auto-rotation flight phase this mixer is automatically switched off.

Roll → Tail rot. and Pitch axis → Tail rot.

| | | |
|---------------------|--|-----|
| Tail rot. →Throttle | | 0% |
| Roll →Throttle | | 0% |
| Roll →Tail rot. | | 0% |
| Nick →Throttle | | 0% |
| ▶Nick →Tail rot. | | 0% |
| ▼▲ <<Normal >> | | SEL |

Increasing pitch is not the only change that requires a corresponding torque compensation via the tail rotor: major cyclic control movements also require this, e.g. if the swashplate is tilted in any direction. Here, too, the **MC-20** HoTT program lets you configure settings for both types of tilt movement (roll and pitch-axis) separately.

For advanced aerobatics in particular, which involve very large control deflections in the pitch-axis controls, e.g. the "Bo-turn" (vertical pull-up followed by tipping over around the pitch-axis) and tight loops, the uncompensated torque present in these flights causes the model to turn to a greater or lesser degree around the yaw axis. This spoils the appearance of the maneuver.

These two mixers permit static torque compensation to be activated by the swashplate tilting in any direction. The mixers work by always increasing tail rotor thrust, starting from the center point of the roll and pitch-axis sticks, i.e. they always generate a tail rotor deflection in the same direction regardless of the direction of the command.

The mixer value can be varied within the range 0 to +100%.

The mixer direction is determined automatically by your definition of the direction of main rotor rotation on the »**Helicopter type**« menu, page 98.

In the auto-rotation flight phase this mixer is automatically switched off.

Gyro suppression

| | | |
|-------------------|--|-----|
| Roll →Throttle | | 0% |
| Roll →Tail rot. | | 0% |
| Nick →Throttle | | 0% |
| Nick →Tail rot. | | 0% |
| ▶Gyro suppression | | 0% |
| ▼▲ <<Normal >> | | SEL |

Important: in normal situations, this function should not be used if your model is fitted with a modern gyro system. In this context, ensure that you comply with the instructions on adjusting your gyro: if not, you risk making adjustments that render your helicopter impossible to fly. This menu has nonetheless been retained in order to cater to a full range of requirements and flying habits.

With this option, the effect of the gyro sensor ("gyro") can be varied according to the tail rotor joystick position; this assumes the use of a gyro system whose gyro gain can be controlled from the transmitter via an auxiliary channel. This channel will be channel 7 for *Graupner* remote control systems. The gyro suppression function reduces gyro gain in a linear progression as the pilot increases the tail rotor deflection. Without gyro suppression—i.e. when set to 0%—the gyro effect is constant, regardless of the joystick position.

With a transmitter control assigned on the "Gyr7" line on the »**Control adjust**« menu (page 116), e.g. one of the proportional sliders mounted in the middle console; as applicable, also made flight-phase dependent and/or with infinitely variable gyro effect between minimum and maximum. In this case, gyro gain is maximum at full deflection of the slider, and zero at the opposite end-point.

Of course, the software lets you limit the gyro gain range on both sides by altering the transmitter control travel.

Depending on the transmitter control's position, the gyro gain at full travel on the tail rotor joystick is:

**"current control position
minus
gyro suppression value".**

Accordingly, if the transmitter control is at the neutral point, and gyro suppression is set to 100%, the gyro gain is reduced to zero as the tail rotor

deflection increases. For values between 100% and the maximum value of 199%, the gyro can be fully suppressed—depending on the transmitter control position—well before full deflection of the tail rotor; see the diagram on the next page.

For the *Graupner/JR* gyro NEJ-120 BB, order no. **3277**, both the upper and the lower values are set via rotary controls: control 1 sets the *minimum* gyro gain at the *bottom* position of the slider; control 2 sets the *maximum* gain at the *top* end-point of the slider; the transition between these two values occurs roughly in the middle of the slider travel.

In contrast, the PIEZO 900, PIEZO 2000 and PIEZO 3000 gyro systems feature proportional, infinitely variable adjustment of gyro gain; see below for typical diagrams.

As an example, the option to configure flight phase-specific—and static—gyro gain gives you the opportunity to exploit maximum stabilization for normal, slow flying, but to reduce gyro gain for fast circuits and aerobatics.

Samples of various gyro settings and configuration notes

- *Linear gyro suppression: 0% to 199%.*
With the tail rotor joystick in the center position, the resulting gyro effect is set using the selected transmitter control. Using a proportional rotary control or slider, the effect is infinitely variable between zero ("min") and maximum ("max"), provided transmitter control travel is not restricted. With full tail rotor deflection, the effective gyro gain is as follows:

**"current control position
minus
gyro suppression value".**

This means that at 0% gyro suppression, gyro gain is constant for tail rotor joystick movement; at 50% suppression, gyro gain is reduced to half

if the assigned transmitter control is moved to the +50% position (as shown here); and only at >150% suppression is gain reduced to zero with the slider at this position, well before full tail rotor deflection.

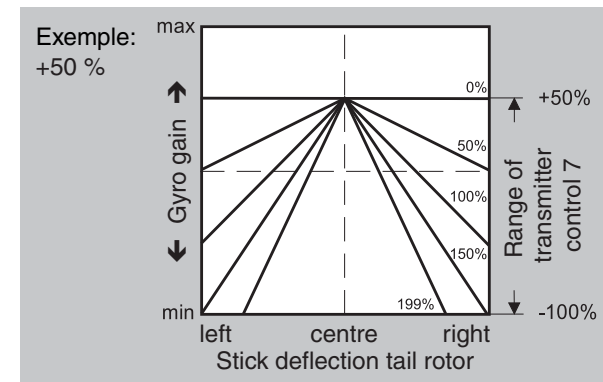

- *Linear gyro suppression with reduced control travel, e.g. -50% to +80% of full travel.*
Gyro gain is infinitely variable within these transmitter control limits. Here too, for purposes of illustration, we plot gyro gain values in relation to tail rotor deflection for various parameter values of gyro suppression.

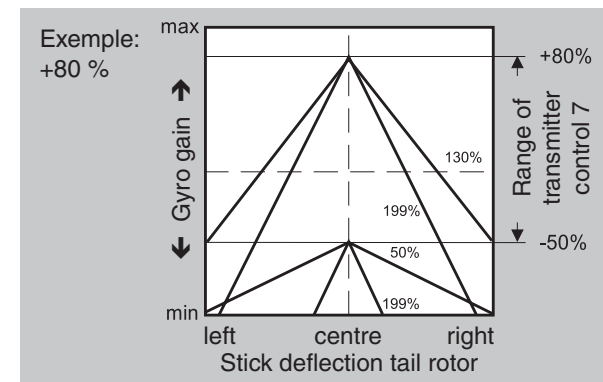

Adjusting the gyro sensor

To achieve the maximum possible level of stabilization for the helicopter with the gyro along the

vertical axis, observe the following:

- The controls should have as little friction and "play" as possible.
- There should be no "spring" in the control linkage.
- Use a strong and comparably fast servo.

When the gyro sensor detects a model rotation, the faster its response – a corresponding corrective change to tail rotor thrust – takes effect, the further the gyro gain adjuster can be moved without causing the tail of the model to start oscillating, and the better the model's stability about its vertical axis. If the response is slower, there is a risk that the model's tail will start to oscillate even at low gyro gain settings. Here, further reductions to gyro gain will need to be made to eliminate the oscillation.

If the model is flying forward at high speed or hovering in a powerful headwind, the net result of the stabilizing effect of the vertical fin combined with the gyro may also lead to an overreaction that once again manifests itself through tail oscillation. To achieve optimum gyro stabilization under all conditions, you can make use of the option to adjust gyro gain from the transmitter using a transmitter control assigned to input "7", in connection with gyro suppression and/or the two settings on the Gyro NEJ-120 BB.

Further notes on gyros with configurable multilevel gyro gain (e.g. NEJ-120 BB)

Since you cannot specify the gyro gain from the transmitter proportionally via the transmitter control, the gyro's own control 1 must be used to set the (weaker) gyro gain (e.g. for aerobatics) and control 2 the stronger gyro gain (e.g. for hovered flight). Even though a proportional control is used for control function 7, only a switch-over between these two values takes place and the setting is therefore not proportional.

You should therefore advance control 2 to the point where the model is on the brink of oscillating when hovering in calm conditions, and advance control 1 to

the point where the model does not oscillate with its tail even when flying at maximum speed into a strong headwind. Depending on the state of the weather and the flight program planned, you can also switch over the gyro gain from the transmitter – also with gyro suppression dependent on tail rotor deflection if required.

Gyro offset

Important notice:

The value of this option is identical to the offset value set in the "Gyr7" line of the »Control adjust« menu, page 116. For this reason, any changes made always affect the other menu directly – and vice versa.

Most of the latest gyro systems not only feature infinitely variable proportional gyro gain setting, but also offer a choice of two separate types of gain mode on the transmitter.

If the gyro in use has at least one of these features then this alternative offset setting provides an opportunity to preset both "normal" gyro gain as well as, as appropriate, to specify a "heading-lock mode" whereby, even within this pre-selection, gyro gain can be reduced by a particular gain type for normal, slow flight with maximum flight stabilization, fast circuit flights and aerobatics.

To proceed as described above, use flight phase switching to enter different settings on the "Gyro offset" line. Values between -125% and +125% are possible:

| | | |
|------------------|-------------|-----|
| Roll | → Tail rot. | 0% |
| Nick | → Throttle | 0% |
| Nick | → Tail rot. | 0% |
| Gyro suppression | | 0% |
| ▶ Gyro offset | | 0% |
| ▼ ▲ << Normal >> | | SEL |

Based on these flight-phase specific (offset) settings, gyro gain can also be infinitely varied by a transmitter control assigned in the "Gyr7" line of the »Control adjust« menu, page 116.

Swashplate rotation

| | | |
|-----------------------|-------------|-----|
| Nick | → Throttle | 0% |
| Nick | → Tail rot. | 0% |
| Gyro suppression | | 0% |
| Gyro offset | | 0% |
| ▶ Swashplate rotation | | 0° |
| ▼ ▲ << Normal >> | | SEL |

Some rotor head control systems make it necessary to incline the swashplate in a different direction from the intended inclination of the rotor plane when a cyclic control command is given. If your model features a four-bladed main rotor, for example, you may need to use this menu to set up a software-driven 45° rotation of the control linkage to the right, so that the pushrods from the swashplate to the rotor head can be set exactly vertical, ensuring that the blade control system works correctly, without unwanted differential effects. This eliminates the need to make mechanical changes to the control linkages. Negative angles equate to a virtual rotation of the rotor head to the left; positive angles a virtual rotation to the right.

Swashplate limiter

| | | |
|----------------------|--------------------------|-----|
| Nick | → Tail rot. | 0% |
| Gyro suppression | | 0% |
| Gyro offset | | 0% |
| Swashplate rotation | | 0° |
| ▶ Swashplate limiter | <input type="checkbox"/> | off |
| ▲ | << Normal >> | SEL |

This function works like a circular mechanical surround acting upon the stick which controls the swashplate, restricting the normally square stick travel to a circular range. In fact, if the helicopter is set up in such a way that the deflections for roll and/or pitch-axis exploit the maximum travel mechanically possible, e.g. for 3D helicopters, then the total tilt applied to the swashplate if full roll and pitch-axis commands are applied simultaneously will be considerably greater (141% in numerical terms). The swashplate mechanism may then strike its end-stops and, in the worst case, the ball-links could even be disengaged.

The **MC-20** HoTT transmitter contains a configurable software function for limiting the total swashplate travel, i.e. it restricts the tilt angle of the swashplate from 100% (the travel is limited to the value obtainable either with roll or pitch-axis alone) to 149% (no effective limit). In addition, the function can be set to "Off" and hence completely deactivated. The swash limiter can also be configured per model and per flight phase.

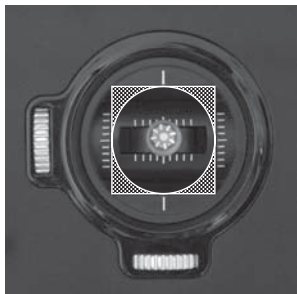

This software solution is therefore much more flexible than a physical circular surround attached to the stick

unit: the latter can, in any case, only be used if the roll and pitch-axis functions are controlled by a common stick unit.

The adjacent sketch illustrates the effect for a 100% setting. the cross-hatched area of travel is curtailed and appears as a "dead zone".

If this function is used, "Dual Rate" should be set to 100% and Dual Rate values above 100% should also not be used. If not, and you set a swashplate limit of 100%, for example, then swashplate movement will be restricted even if roll and pitch-axis commands are given separately.

Setting range: 100 ... 149% and "off".

Fine-tuning the throttle and collective pitch curve

Practical approach

Although the throttle and collective pitch control systems are based on separate servos, they are always operated together by the throttle/pitch joystick (except during autorotation flight). This coupling is performed by the helicopter program automatically. In the **MC-20** HoTT program, the trim wheel of control function 1 acts principally only on the throttle servo. However, in the »**Stick mode**« menu (see page 106) a decision can be made if this should be used for idle trimming as part of the throttle limit function, or for idle trimming during the auto-rotation phase ("throttle AR").

The process of fine-tuning throttle and collective pitch, i.e. setting the motor power curve to match the collective blade pitch setting, is the most important aspect of setting up a model helicopter. The **MC-20** HoTT software provides for independent configuration of the throttle, collective pitch and torque compensation curves, in addition to the C1 control curve (»**Channel 1 curve**« menu, page 131). While these curves can be modeled using up to six points, fewer points are generally sufficient. We recommend starting with three-point curves to begin with. This involves setting individual values for the center point and other (optional) reference points, and for the two end-points ("L", "low", and "H", "high") of the throttle/collective pitch stick: together, these define the control curves.

Before setting the throttle and collective pitch function, the rods of all servos should be mechanically pre-adjusted correctly according to the set-up instructions for the given helicopter.

Note:

The hover point should normally be set to the center position of the throttle / collective pitch stick. In special cases, e.g. for "3D" flight, deviating hover points can also be programmed. For example, one point for normal flight attitude above the center and one point for inverted flight attitude below the center.

Idle setting and throttle curve

Note:

Since electric drive systems have no need for an idle setting, motor idling does not need to be calibrated. Fine-tuning of the throttle and collective pitch curve(s), however, must take place as for glow-powered helicopters.

The idle setting, whose detailed description begins on page 117, always takes place with the throttle limiter closed—normally with the trim wheel of the C1 function and only in special cases is the throttle limiter itself also utilized (as standard, the CTRL 6 proportional rotary control).

The programming of a corresponding value for the "L" point of the throttle curve acts to set the descent speed of the motor, without influencing the hover configuration. Here, for example, flight phase programming can be used to set different throttle curves. This increased system rotational speed below the hover point proves to be useful in certain circumstances, e.g. for fast, steep landing approaches with greatly reduced collective pitch, and for aerobatics.

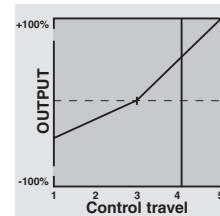

The figure depicts a curve with a slightly changeable throttle setting below the hover point at the control center.

Different throttle curves are programmed to be flight-phase dependent in order to achieve the given optimal adaptation to hovering flight as well as aerobatics:

- Low system rotational speed with smooth, gentle control response and low noise when hovering
- Higher rotor speed for aerobatics with motor power set close to the maximum. In this case, the throttle curve must also be adjusted in the hover range.

Basic set-up procedure

Even though pitch and throttle curves can be set electronically over a wide range with the **MC-20** HoTT transmitter, all linkage in the model should already be mechanically pre-adjusted correctly according to the instructions for the given helicopter. Experienced helicopter pilots will be glad to help with this basic set-up.

The carburetor linkage must be set so that the throttle is just past the fully open setting with collective pitch set to maximum or, for electric helicopters, with the speed controller set to full. When the throttle limiter is closed, however, it must be possible to just close off the carburetor using the C1 trim wheel (rapid throttle setting of the "digital trim", see page 58), without the servo mechanically striking its end-stop. For electric helicopters, it must be possible to cut the electric motor's speed controller safely with the throttle limiter closed.

Take great care when configuring these settings, by adjusting the control linkage as required and/or altering the linkage point on the servo or carburetor lever. Only then should the throttle servo's fine-tuning be electronically optimized.

Caution:

Inform yourself thoroughly about the dangers and safety precautions applicable to handling motors and helicopters before starting the motor for the first time!

With this basic set-up complete, the motor should be started in accordance with the motor operating instructions: idling can then be configured using the trim wheel of the throttle/collective pitch stick. The preset idle position will be displayed on the transmitter's basic display by a horizontal bar next to the C1 trim wheel position indicator. Refer to the description of digital trim on page 58 of this manual.

The model should lift off the ground with the collective pitch stick roughly at its center point and hover roughly at the expected rotational speed. If this is not the case, proceed as follows:

1. The model does not lift off until the collective pitch stick is above the center point.

a) Rotational speed is too low

Remedy: On the graph page for "Channel 1 → Throttle" increase the value for point "1".

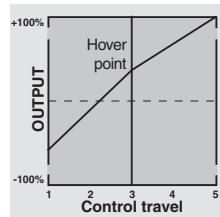

b) Rotational speed is too high

Remedy: Increase the blade angle of attack pitch by increasing the value of point "1" on the "Pitch" graph page.

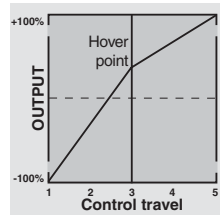

2. The model lifts off before the center point is reached.

a) Rotational speed is too high

Remedy: Decrease the carburetor opening by reducing the value of point "1" on the graph page for "Channel 1 → Throttle".

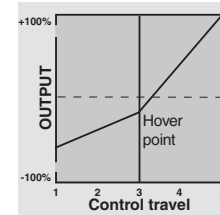

b) Rotational speed is too low

Remedy: Decrease the blade angle of attack pitch by reducing the value of point "1" on the graph page for "Pitch".

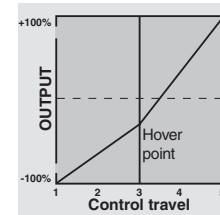

Important:

These settings must be reconfigured until the model hovers at the correct rotational speed with the throttle/collective pitch stick at its center point. The configuration of all other model parameters depends on these settings being made correctly!

Standard set-up

Standard set-up is completed on the basis of the basic set-up described above, whereby the model hovers in normal flight at the correct rotational speed with the throttle/collective pitch stick set to its center point: This means a set-up with which the model is capable of both hovering and flying circuits in all phases while maintaining a constant rotational speed.

Climb settings

The combination of throttle hover setting, collective pitch setting for the hover and the maximum collective pitch setting (point "H") now permits, in a simple manner, a means of attaining a constant rotational speed from hovering right through to maximum climb. First, perform a prolonged, vertical climb by moving

the collective pitch stick to its end-point. Compared to the hover configuration, motor speed should remain unchanged.

If motor speed falls off in the climb, even with the drive system working at full power and therefore no further power increase is possible, then reduce maximum blade pitch angle at full deflection of the collective pitch stick, i.e. the value of point "H". Conversely, the attack angle should be increased if motor speed is to increase while climbing. Therefore, on the "Pitch" graph page, put the vertical line on Point "H" by moving the pitch joystick then change this point's value appropriately with the ▲▼ selection keys of the right touch pad.

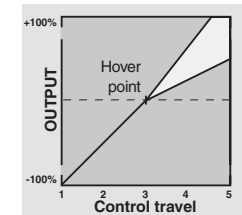

This diagram shows only the changes when setting the maximum collective pitch value.

Then bring the model back to hover, which should, in turn, be achieved with the C1 stick at its center point. If the hover flight point is now achieved only by moving the pitch joystick away from its center point toward "higher" values then this deviation should be compensated by increasing the hover-flight pitch value—i.e. for point "1"—a little until the model once again hovers with the joystick at its center point. Conversely, if the model hovers below the mid-point, correct this by reducing the angle of attack appropriately.

It may also be necessary to correct the carburetor opening for the hover point (point "1") with "C1 → throttle".

This diagram shows only the change to the hover point, i.e. collective pitch minimum and maximum are both left at -100% or +100%.

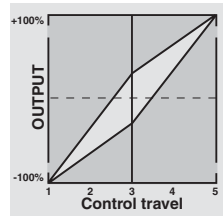

Modify these settings until they really result in a constant rotational speed over the full control range between hovering and climbing flight.

Descent setting

The descent setting should now be configured by placing the model in a steady descent from forward flight at a considerable altitude by fully reducing collective pitch; adjust the collective pitch minimum value (point "L") so that the model descends at an angle of 60° ... 70°. Therefore, on the "Pitch" graph page, put the vertical line on Point "L" by moving the pitch joystick then change this point's value appropriately with the selection keys of the right touch pad.

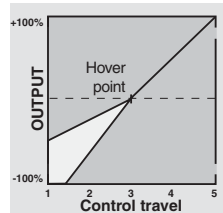

This diagram shows only the changes when setting the minimum collective pitch value.

Once the model can fly this maneuver properly, set the value for "Throttle min" – the value for point "L" on the graph page for "C1 → throttle" – so that the rotational speed neither increases nor decreases. This completes the set-up procedure for throttle and collective pitch.

Some important closing remarks

Before starting the motor, ensure that the throttle limiter is fully closed: this ensures that the carburetor now responds only to the C1 trim wheel. There will

be a visual and an acoustic warning if the carburetor is open too wide when the transmitter is switched on. Otherwise, if the carburetor or speed controller is open too far when the motor starts, there is a danger that the motor will run up to speed immediately after starting, and the centrifugal clutch will engage immediately.

Accordingly,

always hold the rotor head firmly when starting.

Nevertheless, if the motor is accidentally started with the carburetor too wide open, the golden rule is this:

**Don't panic!
Hold the rotor head securely!
Don't let go!**

Instead, close the throttle limiter immediately, even if this risks damaging the drive system (in the worst case scenario).

YOU must ensure the helicopter never moves in an uncontrolled manner.

The costs of repairing a clutch, a gearbox or even the motor itself are negligible in comparison to the injuries and damage that an uncontrolled model helicopter can cause if it is allowed to thrash about with spinning rotor blades.

Always make sure no other person is present in the helicopter's hazard area.

The switchover from idle to a flight setting with increased system rotational speed must not take place abruptly. This will cause the rotor to accelerate very quickly, resulting in premature wear to the clutch and gear train. Since the main rotor blades are generally mounted on a freewheeling unit, they will be unable to keep pace with such rapid acceleration; they will respond by swinging far out of their normal position and may even cause a boom strike.

Therefore, after the motor is started, system rotational speed should be increased *s l o w l y* by way of the throttle limiter. If a switch has been assigned to the throttle limiter, always ensure the »**Control adjust**« menu (page 112) is used to program a time constant of about 5 seconds to run up system rotational speed (opening the throttle limiter). Do not, however, program a delay for closing the throttle limiter. Leave the default value of "GL" in the "Type" column alone, however, to configure this setting globally for all flight phases.

Helicopter mixers

Auto-rotation setting

Auto-rotation permits both full-size and model helicopters to land safely in a crisis, e.g. if the motor should fail. Moreover, if the tail rotor should fail, cutting the motor and landing using auto-rotation is also the only possible way to avoid a high-speed, uncontrollable rotation around the vertical axis and a resulting catastrophic crash—which is why a switchover TO the auto-rotation phase takes place immediately.

When the switchover to the auto-rotation phase is made, the Helicopter mixer menu screen changes as follows:

| | |
|---------------------|------|
| ►Pitch | => |
| Thr. position AR | -90% |
| Tail rot. offset AR | 0% |
| Gyro suppression | 0% |
| Gyro offset | 0% |
| Swashplate rotation | 0° |
| Swashplate limiter | AUS |
| ▼ << Autorot >> | ➡ |

During auto-rotation flight, the main rotor is no longer driven by the motor but only by its own momentum and the the airflow through the rotor plane during descent. Since the energy stored by a rotor kept spinning in this way is rapidly consumed if the helicopter flares, pilots must not only have experience in handling helicopter models but must also consider carefully how the relevant functions should be configured.

The advanced pilot should therefore practice auto-rotation landings at regular intervals. Not only to be able to demonstrate mastery of the maneuver at competitions, but also to ensure the pilot can land the helicopter undamaged from a great height if the motor should fail. For this purpose, the program provides a range of adjustment options designed to help the pilot fly a motorized model in its unpowered

state. Note that the auto-rotation settings comprise a complete seventh flight phase, which provides access to all the flight phase- specific configuration options, and to trims, collective pitch curve settings, etc., in particular. The following functions have special features not present in the powered flight phases:

Pitch (Collective pitch curve (C1 → Pitch))

In powered flight, the maximum blade pitch angle is limited by available motor power. In auto-rotation, however, it is limited only by the point at which airflow ceases over the main rotor blades. Greater maximum collective pitch must therefore be set to ensure sufficient thrust when flaring the helicopter even as rotational speed is falling off. To do so, briefly tap the center **SET** key of the right touch pad to switch to the "Pitch" graph page and then use the joystick to move the vertical line to point "H". Start by setting a value that is about 10 to 20% *greater* than your "normal" maximum value for collective pitch. Initially, however, do NOT set a value that is considerably greater than for normal flight, since, if this is done, the behavior of the collective pitch controls may then be very unfamiliar following the switchover. Indeed, there is a danger that the pilot will oversteer during the flare and the model will balloon: this will case the rotor speed to collapse at a considerable altitude and the model will then crash to the ground. The value can always be readjusted later after flying some test auto-rotations.

The minimum value for collective pitch can differ from that set for normal flight. This depends on the pilot's usual style for normal flight. For auto-rotation, however, always set a sufficiently generous minimum value for collective pitch at point "L" to ensure the model can be brought out of forward flight at moderate speed into a descent at an angle of around 60 ... 70 degrees when collective pitch is reduced to a minimum. If, like most helicopter pilots, you have used this kind of setting for normal flight anyway, then

this value can simply be transferred.

If, however, you normally let your model "fall" at a shallower angle, then you should increase the value at point "L", and vice versa.

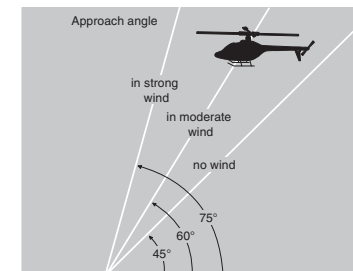

Approach angle for various wind conditions

As a rule, the collective pitch stick itself is not positioned right at the bottom of its travel for auto-rotation. Instead, it is typically between the hover position and the bottom end-point. This offers the pilot an option for further adjustment, e.g. via pitch inclination through pitch-axis controls.

The approach can be shortened by pulling back slightly on the pitch-axis joystick and gently reducing pitch or by extending the approach by pushing forward on the pitch-axis joystick and carefully increasing pitch.

Throttle setting AR

Although pilots will be expected to cut the glow motor completely during competitions, This is rather inconvenient during training sessions because the motor must be restarted after every practice auto-rotation landing.

Therefore, for training sessions, set this line's value such that a combustion motor is held at a safe idle without the clutch engaging during the auto-rotation phase; electric drive systems should be set safely to "Off".

Note:

The "Motor Stop" option in the »Base setup model« menu offers an alternative "Emergency STOP"

function.

Tail rotor AR

In normal flight, the tail rotor is set so that it compensates for motor torque while the model is hovering. It therefore generates some a certain amount of thrust even in its normal position. The level of thrust is then varied by the tail rotor control system, and also by the various mixers which provide all manner of torque compensation, while the tail rotor trim is also used to compensate for varying weather conditions, fluctuations in system rotational speed and other influences.

For auto-rotation, however, the main rotor is not driven by the motor, but by the "windmill" principle. Since this, in turn, does not generate any torque for which the tail rotor must compensate, all corresponding mixers are switched off automatically.

Since the absence of torque in auto-rotation also means the above-mentioned thrust is superfluous, however, a different tail rotor configuration is also required:

Cut the motor and place the helicopter on the ground in a level attitude. With the transmitter and receiving system switched on, select the flight phase "Auto-rotation" and then fold the tail rotor blades down. Now change the value on the "Tail rotor" line until the tail rotor blade angle of attack is zero degrees. Viewed from the tail, the tail rotor blades should be parallel to one another.

Depending on the friction and running resistance of the gearbox, the fuselage may still yaw slightly, however. This relatively slight torque must then be corrected if necessary by adjusting the tail rotor blade pitch angle. This value will always be a figure between zero degrees and a pitch angle opposed to the pitch angle in normal flight.

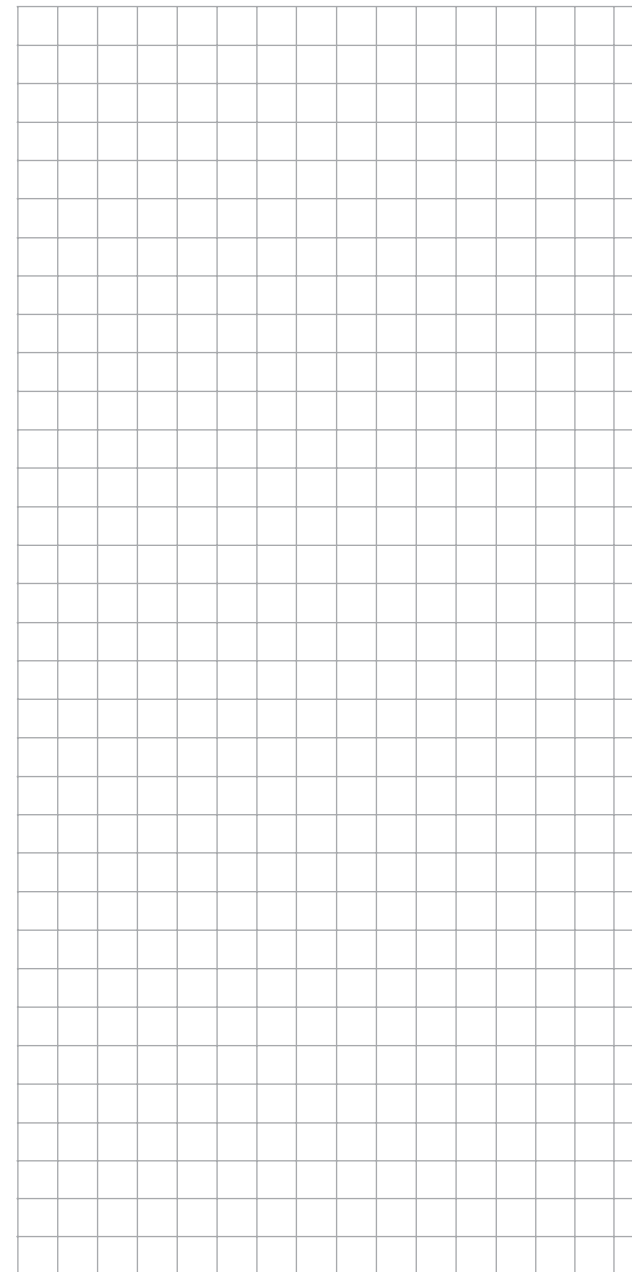
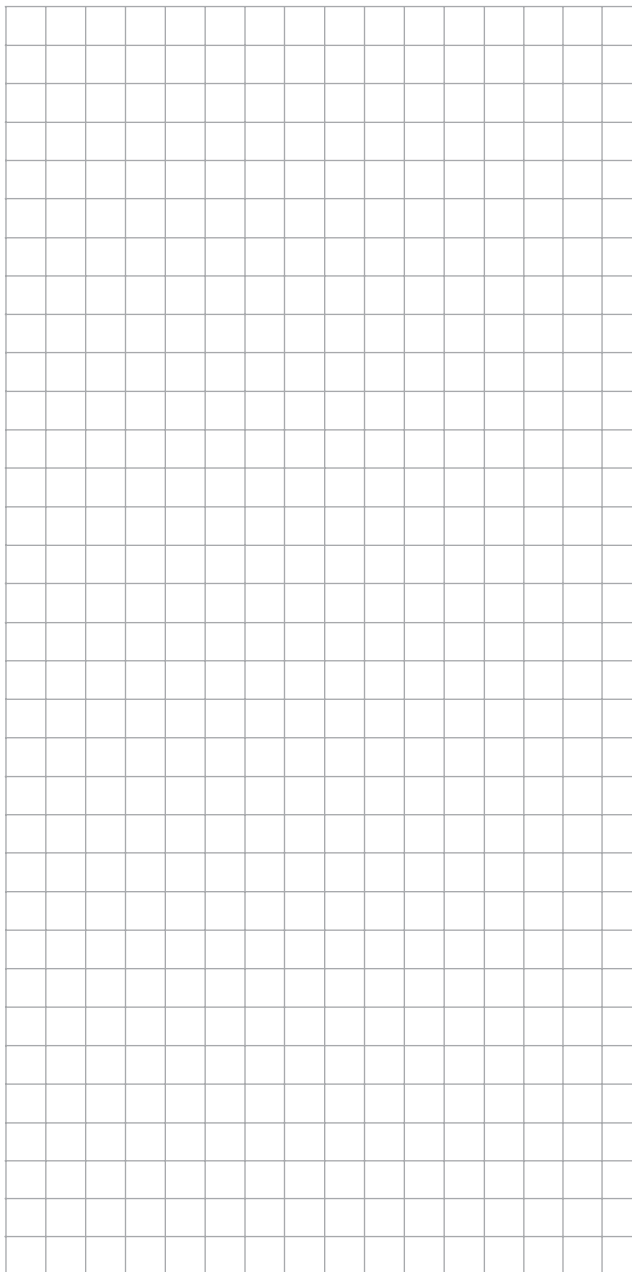



General notes on freely programmable mixers

The previous pages have described a wealth of ready-to-use built-in coupling functions, in the context of the two menus »**Wing mixers**« and »**Helicopter mixers**«. The fundamental significance of mixers and the principle by which they work are described on page 159. The following section provides information about the so-called "free mixers".

In addition to the pre-programmed mixers mentioned above, the **MC-20** HoTT also offers a number of freely programmable mixers in every model memory location, whose inputs, outputs and mixer ratios can be defined to meet one's own requirements. These include:

- 8 linear mixers, numbered 1 through 8
- 4 curve mixers, numbered 9 through 12

These 12 mixers are certainly adequate for most applications and are certainly sufficient when the potential of the pre-programmed coupling functions are utilized. In the »**Mix active/phase**« menu (see page 204), each of these 12 mixers can be activated or deactivated separately for each flight phase.

For the "free mixers", the signal present at any control function (1 to 16) can be assigned as the *input signal* or, for a so-called "switch channel" (see further below), the signal from any switch can be utilized. The signal that is present at the control channel and passed to the mixer input is always influenced by its own transmitter control and by any control characteristic that may have been set, e.g. those specified by the »**Dual Rate / Expo**«, »**Channel 1 curve**« and »**Control adjust**« menus.

The mixer output acts on a control channel (1 to –depending on receiver type– a maximum of 16) that can also be assigned freely. Before this channel routes the signal to the servo, it can only still be influenced by the »**Servo adjustments**« menu, i.e. by the servo reverse, neutral point offset, servo travel and servo travel limit functions, and possibly by »**Tx. output swap**«.

One control function can be used for any number of mix inputs simultaneously: if, for example, several mixers are to be switched to act in parallel.

Conversely, it is possible for any number of mixers to affect one and the same control channel. Particularly in the latter case, however, it is very important to ensure that the servo concerned does not strike its mechanical end-stops when several mixer signals accumulate excessively. For safety's sake, it may therefore be necessary to set an appropriate travel limit in the »**Servo adjustments**« menu.

For more complex applications, mixers can be switched in sequence. In this case, it is not the (transmitter) signal at the "output" of a control function which forms the input signal of the "series-wired" mixer, but the (mixed) signal "further back" at the "input" of a control channel. The following description of the free mixers includes several examples of this type.

In the software, one "free mixer" is always initially activated. Optionally the mixer can also be assigned to an ON/OFF switch. Since there are so many functions to which switches can be assigned, be careful to avoid (undesired) multiple assignments to a single switch.

The two key mixer parameters are:

- ... the **mixer ratio**, which defines the extent to which the input signal acts on the output of the control channel connected to the mixer output. The mixer ratio for linear mixers can be set as symmetrical or asymmetric. Curve mixers can also be configured with up to 8 points to suit one's own application and even implement extremely non-linear curves.
- ... the **neutral point** of a mixer, which is also referred to as the "offset". The offset is that specific point along the movement of a transmitter control (joystick, proportional control or switch) at which the mixer no longer influences the control channel

connected to its output. Normally, the neutral point is the center point of the transmitter control. However, the offset can also be set at any other point along the control travel. Since there are no restrictions on the design of the curve mixers, setting a mixer neutral point only makes sense for the 8 linear mixers.

Switch channel "S" as a mixer input

Occasionally, however, only a constant control signal is required at the mixer output, e.g. for a slightly increased "up-elevator" trim when the aero-tow release is closed – fully independently of its normal trim setting.

In this case a switch is assigned both to the aero-tow release and the mixer; it is then used not only to open and close the release, but also to pass the desired trim signal to the elevator via the mixer ratio. To identify this special arrangement, this mixer input control function in the program is designated "S" for "Switch channel".

In addition, if the corresponding "target channel" should now no longer be influenced by its "normal" transmitter control, isolate the latter from the function input of the affected control channel by way of the »**MIX-only channel**« menu (page 205). Here too, for clarification of this there is an example of the function provided in the following menu description.

Free mixers

Freely-programmable linear and curve mixers

Using the selection keys on the left or right touch pad, page to the menu option ...

| | |
|------------------|--------------------|
| Channel 1 curve | Switch display |
| Control switch | Logical switch |
| Phase settings | Phase assignment |
| Phase trim | Non-delayed chan |
| Timers (general) | Fl. phase timers |
| Wing mixers | Free mixers |

| | |
|--------------------|-------------------|
| Channel 1 curve | Switch display |
| Control switch | Logical switch |
| Phase settings | Phase assignment |
| Non-delayed chan | Timers (general) |
| Fl. phase timers | Helicopter mixer |
| Free mixers | MIX aktiv / Phase |

... on the multi-function menu. Briefly tap the center **SET** key of the right touch pad to open this menu option.

Regardless of the model type selected, each of the 80 model memory locations offers eight linear mixers (LinearMIX 1 ...8) ...

| | | |
|---------------|---------|---|
| ▶ LinearMIX 1 | ?? → ?? | — |
| LinearMIX 2 | ?? → ?? | — |
| LinearMIX 3 | ?? → ?? | — |
| LinearMIX 4 | ?? → ?? | — |
| LinearMIX 5 | ?? → ?? | — |
| ▼ | from | |

... and 4 curve mixers (CurveMIX 9 ... 12), which also offer non-linear control characteristics:

| | | |
|--------------|---------|---|
| LinearMIX 8 | ?? → ?? | — |
| CurveMIX 9 | ?? → ?? | — |
| CurveMIX10 | ?? → ?? | — |
| CurveMIX11 | ?? → ?? | — |
| ▶ CurveMIX12 | ?? → ?? | — |
| ▲ | from | |

In addition, the »MIX active/phase« menu (page 204) permits the independent activation and deactivation of only particular mixers for specific flight phases.

On the "Free mixers" menu, the blocked mixers are then suppressed in the corresponding flight phase. If you are hunting for a mixer that is not shown, you should therefore switch to the appropriate flight phase!

In this first section, however, we will concentrate on how to program the first screen page of the "free mixers". We will then move on to the method of programming mixer ratios, both for linear mixers and curve mixers, as found on the second screen page of this menu.

Basic programming procedure

1. Select the mixer you want by using the ▲ ▼ selection keys on the left or right touch pad.
2. Tap the center **SET** key of the right touch pad. The input field on the line marked "fr" at the lower edge of the screen is now shown highlighted.
3. Use the selection keys on the right touch pad to select the "fr" mixer input.
4. Tap the center **SET** key of the right touch pad; using the ▶ selection key of the left or right touch pad, switch to the column marked "to" at the lower edge of the screen then tap the center **SET** key of the right touch pad once again.

The input field "to" is shown highlighted.

5. Use the selection keys on the right touch pad to select the "to" mixer output.
6. Tap the center **SET** key of the right touch pad. Optionally use the ◀ selection key of the left or right touch pad to switch to the column marked "ty" at the lower edge of the screen in order to include the trim of the respective joystick in the mixer input signal ("Tr" for trim or "P" for phase) and/or to add series switching for mixers ...
... and/or use the ▶ selection key of the left or right touch pad to change the column marked with the switch icon /- on the lower edge of the screen. To do this, tap the center **SET** key of the right touch pad once again and assign a switch as described in the section "Assigning transmitter controls, switches and control switches" (page 56).
7. Using the ▶ selection key of the left or right touch pad, switch to the column "Settings" then tap the center **SET** key of the right touch pad.
8. Define the mixer ratios on the second screen page.
9. Return to the first page by using the center **ESC** key of the left touch pad.

"fr"

After selecting a mixer line and a subsequent tap on the center **SET** key of the right touch pad, select one of the control functions, 1 ... 16 or S, for the value field now in inverse video with the selection keys of the right touch.

For the sake of clarity, control functions 1 ... 4 are marked as follows when setting wing mixers:

| | |
|----|-------------------------|
| C1 | Throttle/airbrake stick |
| AI | Aileron stick |
| EL | Elevator stick |
| RU | Rudder stick |

... and, for the helicopter program:

| | |
|---|---------------------------------|
| 1 | Throttle/collective pitch stick |
| 2 | Roll stick |
| 3 | Pitch-axis stick |
| 4 | Tail rotor stick |

Note:

If you select any of the control functions 5 ... 16 for fixed-wing models or 5, 7 ... 16 for helicopter models, do not forget to assign a transmitter control for each of these in the »Control adjust« menu!

"S" as switch channel

Selecting "S" (switch channel) in the fr column has the effect of passing a constant input signal to the mixer input, e.g. in order to add a little more "up-elevator" trim when the aero-tow release is closed, as mentioned on the previous page.

After assigning a control function or the "S" switch channel in the "fr" column, the following is also displayed ...

"to "

... on the lower edge of the screen.

Use this column's input field to specify the destination of the mixer, i.e. assign mixer output, to one of the control channels. At the same time, additional fields will appear in the bottom line of the screen:

| | | | | |
|---------------|--|---------|------|-------------|
| LinearMIX 1 | | 6 → EL | 4 ↘ | off => |
| LinearMIX 2 | | C1 → EL | C4 ↘ | off => |
| LinearMIX 3 | | 3 → 8 | | => |
| ▶ LinearMIX 4 | | S → EL | 2 ↘ | off => |
| LinearMIX 5 | | ?? → ?? | | — |
| ▼ ▲ | | type | from | to ↘ Adjust |

In this example, four mixers have already been defined. The second mixer is already familiar in

principle as "Elevat curve" from the "Brake settings" sub-menu of the »Wing mixers« menu and the third is familiar from the line "Tail" ("2ELSV3+8") of the »Model type« menu. As a general rule, however, you should first make use of the pre-programmed mixers. However, if you need asymmetric mixer ratios, want to program non-linear curves or need to offset the mixer neutral point, then you should set or leave the pre-programmed mixers at "0%" and replace these with free mixers.

Erasing mixers

To erase a previously-defined mixer, select the appropriate line with the ▲ ▼ selection keys on the left or right touch pad, switch to the "fr" column, if necessary, with the ◀ ▶ selection keys then briefly tap the center SET button on the right touch pad:

| | | | | |
|---------------|--|---------|------|-------------|
| LinearMIX 1 | | 6 → EL | 4 ↘ | off => |
| LinearMIX 2 | | C1 → EL | C4 ↘ | off => |
| ▶ LinearMIX 3 | | 3 → 8 | | => |
| LinearMIX 4 | | S → EL | 2 ↘ | off => |
| LinearMIX 5 | | ?? → ?? | | — |
| ▼ ▲ | | type | from | to ↘ Adjust |

The field in the "fr" column for the mixer you want to delete will now be shown in inverse video: tap both ▲ ▼ selection keys or ◀ ▶ on the right touch pad at the same time (CLEAR):

| | | | | |
|---------------|--|---------|------|-------------|
| LinearMIX 1 | | 6 → EL | 4 ↘ | off => |
| LinearMIX 2 | | C1 → EL | C4 ↘ | off => |
| ▶ LinearMIX 3 | | ?? → ?? | | — |
| LinearMIX 4 | | S → EL | 2 ↘ | off => |
| LinearMIX 5 | | ?? → ?? | | — |
| ▼ ▲ | | type | from | to ↘ Adjust |

Mixer switches

In the sample screen image shown above, switches "4" and "2" have been assigned to linear mixers 1 and 4 and to mixer 2 of the control switch "G4".

The switch symbol to the right of the switch number shows the current switch state.

Any mixers not assigned to a switch, as indicated by an empty cell for the column marked by the switch icon ↘ on the screen's bottom line, are fundamentally active!

A switch must be assigned to LinearMIX 4 if you wish to switch between two fixed mixer values (still to be set) that correspond to the two end-points of a (proportional) transmitter control. Accordingly, the "switch channel" mixer cannot also be switched "on" or "off" as with the other mixers.

If you intend to assign a control switch (G1 ... G4) as a switch, then please note that you must define this appropriately BEFOREHAND in the »Control switch« menu. If you do not, you will assign an undefined control switch and therefore one that functions as a fixed switch.

"Ty"

Including the trim

For control functions 1 ... 4, you can also allow trimming of the digital trim wheel for the given joystick effect the mixer's input. In this case, briefly tap the center SET key of the right touch pad then use the selection keys to select "Tr" in the inverse video field:

| | | | | |
|---------------|----|---------|------|-------------|
| LinearMIX 1 | | 6 → EL | 4 ↘ | off => |
| ▶ LinearMIX 2 | Tr | C1 → EL | C4 ↘ | off => |
| LinearMIX 3 | | 3 → 8 | | => |
| LinearMIX 4 | | S → EL | 2 ↘ | off => |
| LinearMIX 5 | | ?? → ?? | | — |
| ▼ ▲ | | type | from | to ↘ Adjust |

The effect of the C1 trim wheel on mixer output will depend on the function assigned in the »**Model type**« menu (page 94), in the "Motor on C1" column for fixed-wing models ...

| Trim | Effect on mixer output |
|---------|---------------------------------------|
| None | linear over full trim wheel travel |
| Forward | Only effective if C1 stick is forward |
| Back | Only effective if C1 stick is back |

... or on the "Pitch" line of the »**Stick mode**« menu for helicopter models:

| Trim | Effect on mixer output |
|------------------------|--|
| AR (Thr-AR) | linear over full trim wheel travel |
| TL (throttle limit) | only effective at minimum position of the assigned throttle limit control (the right side proportional rotary control as standard) |

Switching mixers in series

As already explained on page 192, you can also switch mixers in series: Where mixers are switched in "sequence", the "input signal" of a control channel already on its way to the servo "branches off" and is directed to a further channel. In the "ty" column, select the right angle bracket ">" or "Tr >", if the trim should also act simultaneously on the mixer input:

| | | | | |
|---------------|------|---------|----|----------|
| LinearMIX 1 | | 6 → 7 | | => |
| ▶ LinearMIX 2 | > | 7 → 8 | | => |
| LinearMIX 3 | | ?? → ?? | | — |
| LinearMIX 4 | | ?? → ?? | | — |
| LinearMIX 5 | | ?? → ?? | | — |
| ▼ ▲ | type | from | to | ↙ Adjust |

Example:

Two mixers (MIX 6 → 7 and 7 → 8):

a) WITHOUT series switching:

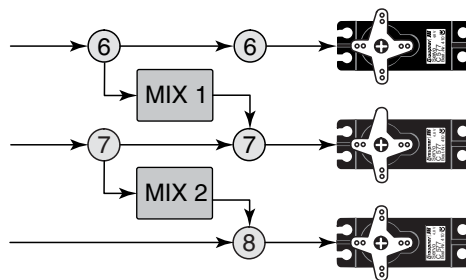

b) The same mixers WITH series switching:

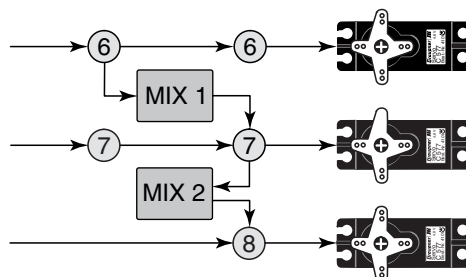

In this highly simplified example, if mixer 2 is switched in series, then it does not "take over" solely the transmitter signal of control function 7 – as shown under a) – but, instead, the entire (mixed) signal present at the servo side of control channel 7, as shown under b). It then directs this in accordance with its configured mixer ratio forwards to control channel 8. In this case, the effect of transmitter control "6" extends as far as output "8". This kind of serial linkage can be extended as far as you wish. For example, another mixer "8 → 12" can be used to route the control signal from "6" as far as output "12", taking into consideration the associated mixer ratios. Of course, even with an active serial link, each separate mixer can still be controlled via the

transmitter control assigned to the mixer input. Fixed-wing and helicopter mixers also work in the same way, when set up to switch "in sequence".

Including phase trim

If you wish to apply the FLAP channel ("6") or FLAP2 channel ("9") trim values stored in the »**Phase trim**« menu – flight phase dependent – then first tap the center **SET** key of the right touch pad and use its selection keys to select "P":

| | | | | |
|---------------|------|---------|----|----------|
| ▶ LinearMIX 1 | P | 6 → 11 | | => |
| LinearMIX 2 | | ?? → ?? | | — |
| LinearMIX 3 | | ?? → ?? | | — |
| LinearMIX 4 | | ?? → ?? | | — |
| LinearMIX 5 | | ?? → ?? | | — |
| ▼ | type | from | to | ↙ Adjust |

Depending on the mixer value configured, a mixer can, as shown in the example above, route the signal from a flap control present (e.g.) on input 6 to control channel 11, while also applying the FLAP trim value set on the »**Phase trim**« menu (page 150) for the respective flight phase.

Other special features of free mixers

Mixer input = mixer output

If you set up a mixer whose input is the same as its output, e.g. "C1 → C1", you can achieve some very special effects in conjunction with the option of switching a free mixer on and off in any way you like. A typical application of this can be found at the end of this section, as Example 2 on page 202.

Tip:

If you separate a control function, e.g. "9", from control channel 9" using the »**MIX-only channel**« menu (see page 205), then servo response is defined only by the mixer ratio (yet to be specified)

of the mixer programmed on the same channel. Thus, with linear mixers LinearMIX 1 ... 8 or curve mixers CurveMIX 9 ... 12, 8-point control curves can be defined for any transmitter control in a manner analogous to that described in the »**Channel 1 curve**« menu and these can also be used in flight phase switching if needed. This method of "linking" is not only also switchable but can even be subject to a delay by assigning an appropriate delay in the "- time +" column of the »**Control adjust**« menu.

Mixer output affecting default software coupling of aileron, camber-changing flap or collective pitch servos

Before we start specifying the mixer ratio, we must first give some thought to what happens if we permit a mixer to affect the default software coupling of aileron, camber-changing flap or collective pitch servos:

- **Fixed-wing models:**

Depending on the number of wing servos available on the "Aile/flaps" line of the »**Model type**« menu, control channels 2 and 5 are connected via special mixers for the "aileron" function, 6 and 7 for the "flap" function, outputs 9 and 10 (if present) for the FLAP2 servos and 11 and 12 for AI2 servos.

If mixer outputs are programmed to affect these kinds of couplings, then their effect on the respective flap pair derived from the "receiving" control channel must be accounted for:

| Mixer | Effect |
|-----------|--|
| N.N.* → 2 | servo pair 2 + 5 responds with an aileron function |
| N.N.* → 5 | servo pair 2 + 5 responds with a flap function |
| N.N.* → 6 | servo pair 6 + 7 responds with a flap function |

| | |
|------------|--|
| N.N.* → 7 | servo pair 6 + 7 responds with an aileron function |
| N.N.* → 9 | servo pair 9 + 10 responds with a flap function |
| N.N.* → 10 | servo pair 9 + 10 responds with an aileron function |
| N.N.* → 11 | servo pair 11 + 12 responds with a flap function |
| N.N.* → 12 | servo pair 11 + 12 responds with an aileron function |

- **Model helicopters:**

With helicopter mixers, collective pitch control may be provided by up to 4 servos connected to receiver outputs 1, 2, 3 and 5, depending on helicopter type. The software links these together to control collective pitch, roll and pitch-axis.

Other than within the »**Helicopter mixers**« menu, it is **not** advisable to mix a free mixer into these channels because this can lead to very complex interactions. One of the few exceptions is "Collective pitch trim using a separate transmitter control" – see example 3 on page202.

Important notices:

- **With serial links in particular, remember that that the travels of the individual mixers are cumulative if multiple stick commands are made simultaneously: there is a risk that the servo(s) may strike a mechanical end-stop. If necessary, reduce "servo travel" to avoid this; alternatively, set "Travel limit" on the "Servo adjustments" menu and/or reduce mixer values.**
- **Take advantage of the ever-present option to switch over to the transmitter's »Servo display«" menu (see page 262). This menu is reached from almost any menu with a**

brief, simultaneous tap on the ◀ ▶ keys of the left touch pad. This menu gives you the opportunity to check the effects of all of your settings on a single screen.

Mixer ratios and mixer neutral point

Now that we have explained the wide-ranging nature of the mixer functions, the following section describes how to program linear and non-linear mixer curves. For each of the 12 available mixers, the mixer curves are programmed on a second page of the screen display. Use the selection keys ▲ ▼ on the left or right touch pad to select the desired mixer line. If necessary, use the touch pad's selection keys to move to the right column (=>) then briefly tap the center **SET** key of the right touch pad to access the graph page.

LinearMIX 1 ... 8: Setting linear mixer values

As a practical example, we will now define a linear mixer curve to resolve the following problem:

For a motorized aircraft model, the two servos connected to receiver outputs 6 and 7 – defined on the "Aile/flaps" line of the »**Model type**« menu as "... 2FL" – are to be used for actuating landing flaps. That is; when a transmitter control is moved, they must deflect downwards only. This requires a simultaneous elevator trim, however.

First allocate, for example, input 6 to the leftmost slider control SR1 located in the middle of the console by making settings in the »**Control adjust**« menu. A transmitter control on input 6, –as shown in the above table– will control the two servos connected to receiver outputs 6 and 7 by default as flaps. Leave the default value of "GL" in the "Type" column alone, however, to configure this setting globally for all flight phases – as is the case for the free mixer.

* N.N. = Nomen Nominandum (the name to be stated)

»Control adjust« menu

| | | | | | | | | |
|-----|----|-----|-----|----|-------|-------|-----|-----|
| ▶15 | GL | S11 | --- | 0% | +100% | +100% | 0.0 | 0.0 |
| 16 | GL | fr | --- | 0% | +100% | +100% | 0.0 | 0.0 |
| 17 | GL | fr | --- | 0% | +100% | +100% | 0.0 | 0.0 |
| 18 | GL | fr | --- | 0% | +100% | +100% | 0.0 | 0.0 |

▼ Typ SEL /_ offset - travel + -time+

Note:

Note that if two flap servos have been selected, any transmitter control assigned to input 7 will be decoupled in the software in order to avoid errors in operating the flaps. However, in the interests of safety, you should make a habit of leaving all inputs not currently required to "free", or of resetting these back to "free"!

Start by moving this transmitter control to its forward limit and adjust the landing flaps so that they are retracted or closed in this position. If you now move the dial to the rear, the flaps should move downward; if not the direction of servo rotation must be adapted. We now turn our attention to the first mixer shown in the screen image on page 194 ("6 → EL"), to which switch 4 was assigned:

| | | | | |
|--------------|--|---------|------|--------|
| ▶LinearMIX 1 | | 6 → EL | 4 ↘ | off => |
| LinearMIX 2 | | C1 → EL | C4 ↘ | off => |
| LinearMIX 3 | | 3 → 8 | | => |
| LinearMIX 4 | | S → EL | 2 ↘ | off => |
| LinearMIX 5 | | ?? → ?? | | — |

▼ type from to /_ Adjust

Briefly tap the center **SET** key of the right touch pad to open the second screen page:

Linear MIX 1 6 → EL
off

If this screen appears, the mixer has not yet been activated in combination with the assigned toggle switch—"4", in this example. If so, operate the switch:

Linear MIX 1 6 → EL

| | |
|----------------|---------|
| Mix input | Offset |
| 0% 0% | 0% |
| SYM ASY | STO SET |

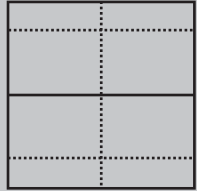

The continuous vertical line represents the current position of the transmitter control linked to input 6. (However, it is not visible in the above graphic because it is at the left edge since slider control SR1, in this example assigned to input 6 (see previous page), is at its forward limit.) The dotted vertical line in the middle of the diagram indicates the position of the mixer neutral point – see under "Offset", below. The solid horizontal line shows the mixer ratio, which currently has the value zero over the entire stick travel; accordingly, the elevator will not yet follow the movement of the flaps.

First, the ...

Offset (mixer neutral point)

... should be defined. Switch over to **STO** for this by using the ▶ selection key of the left or right touch pad:

Linear MIX 1 6 → EL

| | |
|-----------|----------------|
| Mix input | Offset |
| 0% 0% | 0% |
| SYM ASY | STO SET |

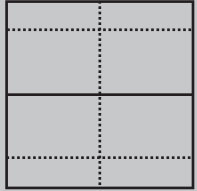

The dotted vertical line in the middle of the diagram indicates the position of the mixer neutral point ("Offset"), i.e. the specific point along the control travel at which the mixer does NOT influence the control channel connected to its output. The default position for this point is at the control center. However, since in our example the flaps should be closed or retracted with the slider control at its forward limit and therefore the elevator should not be further influenced in this position, the mixer neutral point must be relocated to precisely this point. To do so, push the slider control used (in this example, slider control SR1) to its forward limit if you have not already done so, then briefly tap the center **SET** key of the right touch pad. The dotted vertical line moves across to this point, the new mixer neutral point, which by definition always retains the "initial" value of zero.

However, to better illustrate our example, we now wish to set this "Offset" value to only -75%.

Linear MIX 1 6 → EL

| | |
|-----------|----------------|
| Mix input | Offset |
| 0% 0% | -75% |
| SYM ASY | STO SET |

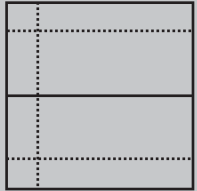

Notes:

- By selecting **SET** with the ► selection key of the left or right touch pad followed by a tap on the center **SET** key of the right touch pad ...

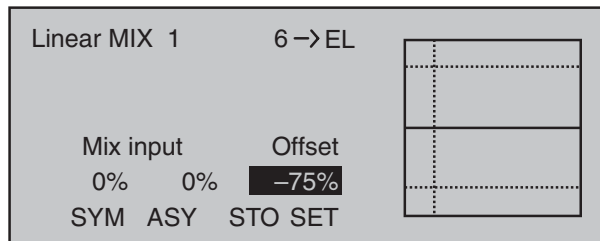

... the offset value can be set manually or adjusted in 1 % increments with the selection keys on the left or right touch pad.

- By selecting **SET** ...

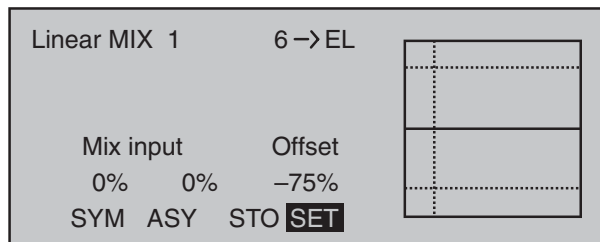

- ... –see previous figure–set the mixer's neutral point automatically back to control center with a simultaneous tap on both the ▲▼ or ◀▶ selection keys of the right touch pad (**CLEAR**).

Symmetrical mixer ratios

The next task is to define the mixer values above and below the mixer neutral point—starting from its current position.

If necessary, use selection keys ◀▶ on the left or right touch pad to select the **SYM** field in order to establish a mixer value which is symmetric to the offset point just set. Following a brief tap on the center **SET** key of the right touch pad, set both **SYM** fields (now in inverse video) via the selection keys of the right touch pad to values between -150 % and +150 %. Note that the mixer value set always refers to the input signal of the respective transmitter control (control signal)! Negative mixer values reverse the direction of the mixer.

A simultaneous tap on the ▲▼ or ◀▶ selection keys of the right touch pad (**CLEAR**) will erase the mixer ratio in the inverse video field.

The "optimum" value in our example will certainly need flight-testing.

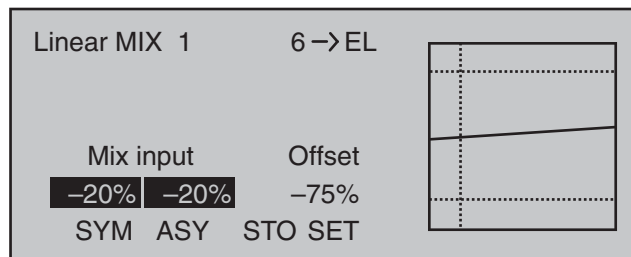

Earlier, we set the mixer neutral point at -75 % of control travel: as a result, the elevator ("EL") will exhibit a (slight) down-elevator effect even at the neutral point of the landing flaps and this is naturally undesirable. Accordingly, you should reposition the mixer neutral point to -100 % of control travel, as described earlier.

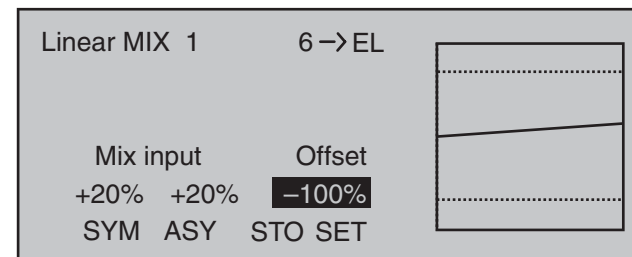

If the offset, now -100 %, is reset to 0 % of control travel by using selection key ► on the left or right touch pad to select the **SET** field then tapping either the selection key combination ▲▼ or ◀▶ on the right touch pad (**CLEAR**), the following screen will appear:

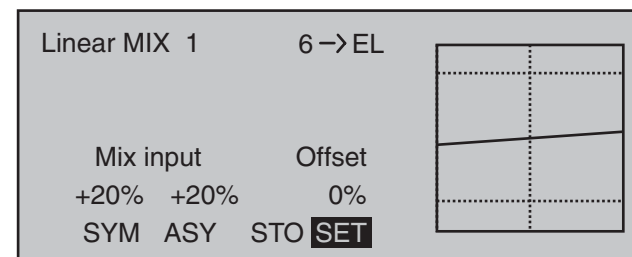

Asymmetric mixer ratios

In many cases, however, we require different mixer values on each side of the mixer neutral point.

Do this by first resetting the offset of the mixer used in the example, "6 → EL" again to 0 %, if necessary, refer to the figure above. Now select the **ASY** field with the selection key ► on the left or right touch pad then tap the center **SET** key of the right touch pad. If slider control SR1, assigned to input 6 in this example, is now moved in each corresponding direction, the mixer ratios for each of the two control directions, i.e. left and right of the established offset point, can be adjusted with the selection keys of the right touch pad:

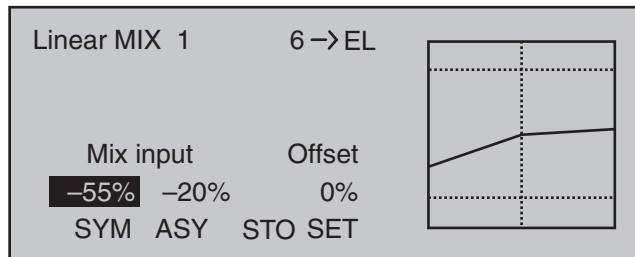

Note:

If you are using a type "S → N.N.*" switch channel mixer you will need to actuate the assigned switch. The vertical line then jumps between the left and right side.

Setting curve mixers 9 ... 12

These four curve mixers allow the definition of extremely non-linear mixer curves by placing up to six freely positionable points between the two endpoints "L" (low = -100% control travel) and "H" (high = +100% control travel) along the control travel.

If you have already read the »Channel 1 curve« menu description or about programming 8-point curves in the »Helicopter mixers« menu, you can safely skip the following description.

Programming details

The control curve is defined by up to 8 points, known as "reference points". In the default software configuration, 2 reference points are already defined, namely only the two end-points, "L" and "H"; see the next screen image.

The following section applies to "any" mixer to which we wish to assign a non-linear curve characteristic.

The examples shown in the following section are merely illustrative, however, and they do not represent real-life mixer curves.

Setting reference points

When you move the transmitter control assigned to the mixer input – here control function 8 – a vertical line in the graph follows the movement between the two end-points. The current control position is also shown numerically on the "Input" line. The point at which this line intersects with the curve in question is named the "Output" and can be varied between -125% and +125% by setting reference points; see further below. This control signal acts on the mixer output.

In the above example, the transmitter control is on input 8 at -50% of control travel. The output signal continue to show 0%, however, since no value has yet been entered.

Up to six additional reference points can be set between the two end-points "L" and "H", although the distance between neighboring reference points must not be less than approx. 25%.

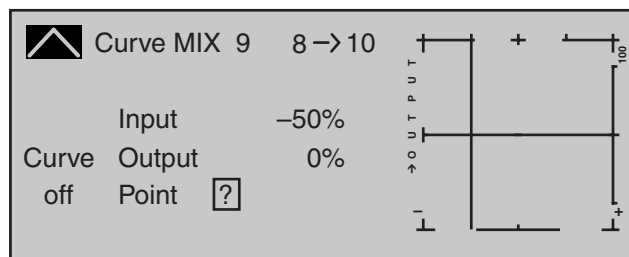

When you now briefly tap the center SET key of the right touch pad, the "?" is replaced by a point number and the value field to the right is activated, i.e. presented in inverse video:

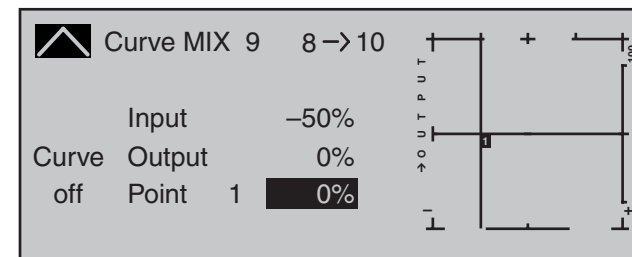

Using the selection keys on the right touch pad you can now change the point value within a range of ±125%, e.g.:

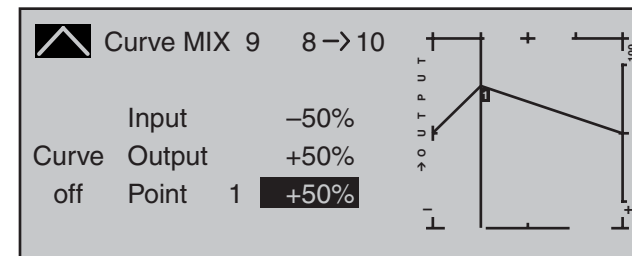

Note:

If the joystick does not coincide with the exact reference point, please note that the percentage value on the "Output" line always relates to the current joystick position.

Continue in this way to set other reference points. Note that the order in which you generate the (maximum) four reference points between end-points "L" and "H" is irrelevant, since the reference points are continuously renumbered automatically from left to right as they are entered.

Erasing reference points

To erase one of the reference points between "L" and "H", use the transmitter control in question to move the vertical line onto or into the vicinity of the reference point in question. The reference point number and associated reference point value

* N.N. = Nomen Nominandum (the name to be stated)

are shown on the "Point" line. The value field is highlighted, see screen image above.

Now tap the two selection keys ▲▼ or ◀▶ on the right touch pad at the same time (CLEAR).

The selected reference point is erased, and the numbering of the remaining reference points is updated as required. Briefly tap the center ESC key of the left touch pad to complete the procedure.

Note that the reference points "L" and "H" cannot be erased.

Changing reference point values

To change reference point values, use the associated transmitter control to move the vertical line onto the point you wish to change: "L", 1 ... 6 or "H".

The number and current curve value of this point are displayed. After activating the value field on the "Point" line by briefly tapping the center SET key, use the selection keys on the right touch pad to change the current curve value shown in the highlighted field. The possible range is -125% to +125% and changes do not affect neighboring reference points. Briefly tap the center ESC key of the left touch pad to complete the procedure.

Note:

If the joystick does not coincide with the exact reference point, please note that the percentage value on the "Output" line always relates to the current joystick position.

Trim point function

Alternatively, a jump up or down to reference points already set, L, 1 ... max. 6 and H, can be accomplished by using the ◀▶ selection keys on the left touch pad. The selection keys on the right touch pad can then be used to change the reference point jumped to as described above, entirely independently of the control position.

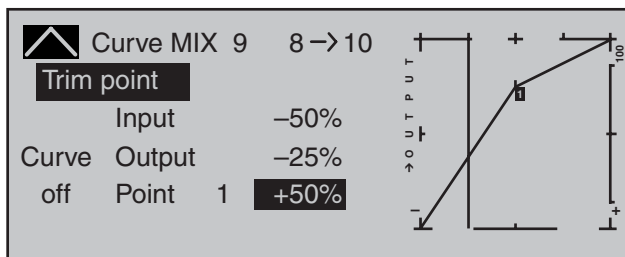

In this simple example, slider control SD1 – represented by the vertical line – is halfway between the forward limit and the midpoint of control travel (input = -50%). However, "Point 1" will be relocated to control center at a point value of +50%, resulting in a momentary output value of -25%. One touch on the center ESC key of the left touch pad will terminate this trim point function.

Trim offset function

When a value field is active, i.e. in inverse video, it is not only possible, as previously described, to jump up or down to reference points already set with the ◀▶ selection keys of the left touch pad and to make a change with the selection keys of the right touch pad, but also an existing curve can be vertically repositioned within a range of ±25% through use of the ▲▼ keys on the left touch pad. Starting with a point value for "Point 1" at 0%, the control curves in both of the following figures have been vertically shifted within the ±25% range by the trim offset function:

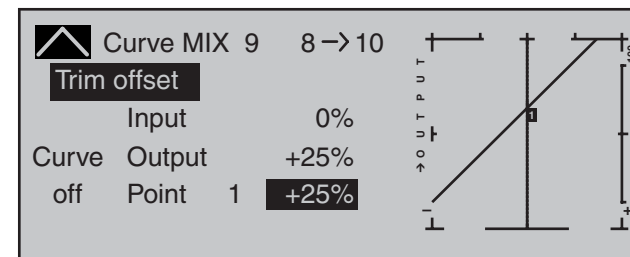
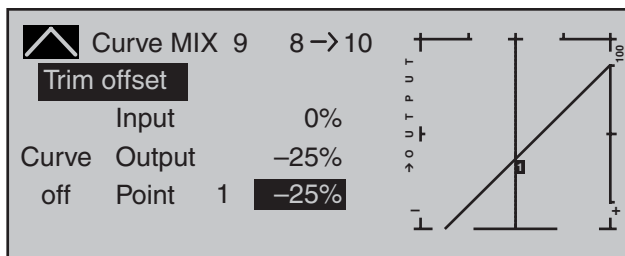

You can also exit this function by tapping the center ESC key of the left touch pad.

Trim x-axis function

This function is activated by tapping the left (◀) or right (▶) selection key of the right touch pad with an active (i.e. inverse video) value field. You can then use the selection keys on the right touch pad to reposition the active point horizontally or vertically as you wish. In the figure below, "Point 1" which was just shifted to +50% with the trim point function, will now be shifted to the left:

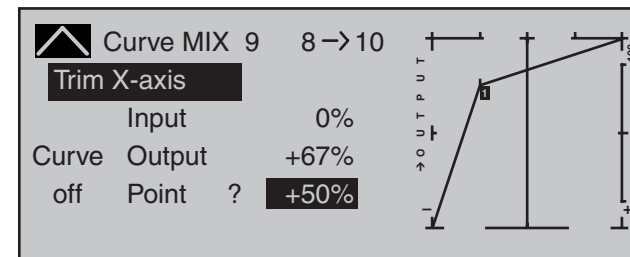

Notes:

- If the point is repositioned horizontally further away from the current control position than approx. ±25%, a "?" sign will reappear in the line Point. This question mark does not refer to the repositioned point, however: instead, it signifies that a further point can be set at the current control position.

- Please note that the percentage value on the "Output" line always relates to the current joystick position and not to the position of the point.

Smoothing the curve

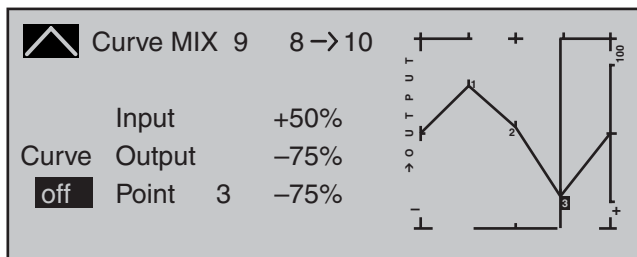

This "angular" curve profile created in the example can be smoothed automatically simply by pressing a button. Do this –from a situation as illustrated– with a brief tap on the ▼ selection key of the left touch pad. This will result in a switchover from "(Curve) off" to "(Curve) on" (or vice versa):

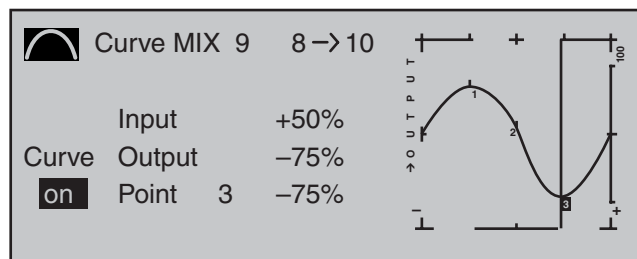

Note:

The curves shown here are for demonstration purposes only and are not at all representative of real mixer curves. For real-world application examples, see the programming examples on pages 274 and 313.

Examples:

- To open and close an aero-tow, a switch, e.g. SW 2, has already been assigned to control channel 8 in the »Control adjust« menu:

| | | | | | | | | |
|-----|----|-----|-----|----|-------|-------|-----|-----|
| I5 | GL | fr | --- | 0% | +100% | +100% | 0.0 | 0.0 |
| I6 | GL | fr | --- | 0% | +100% | +100% | 0.0 | 0.0 |
| I7 | GL | fr | --- | 0% | +100% | +100% | 0.0 | 0.0 |
| ►I8 | GL | --- | 2 | 0% | +100% | +100% | 0.0 | 0.0 |

«Normal »

▼ ▲ Typ /- /- Offset - travel + -time+

Subsequent aero-tow flying has proven that you always have to fly with the up-elevator held slightly in during the tow. The solution will be to set up a mixer that applies slight up-elevator trim to the elevator servo connected to receiver output 3 when the aero-tow release is closed. The screen-shot will be familiar from page 194: here, the fourth linear mixer has been set up for this function, with the switch channel "S" as mixer input: Move the selected switch to the OFF position and then switch ...

| | | | | | |
|--------------|--|---------|----|-----|---|
| LinearMIX 1 | | 6 → EL | 4 | off | ⇒ |
| LinearMIX 2 | | C1 → EL | C4 | off | ⇒ |
| LinearMIX 3 | | 3 → 8 | | | ⇒ |
| ►LinearMIX 4 | | S → EL | 2 | off | ⇒ |
| LinearMIX 5 | | ?? → ?? | | | |

▼ ▲ type from to /- Adjust

... to the mixer configuration page.

Here select **STO** under "Offset" then tap the center **SET** key of the right touch pad briefly ... depending on the selected travel setting in the »Control adjust« menu and the switch setting, the offset value will jump to +X% or -X%, for example:

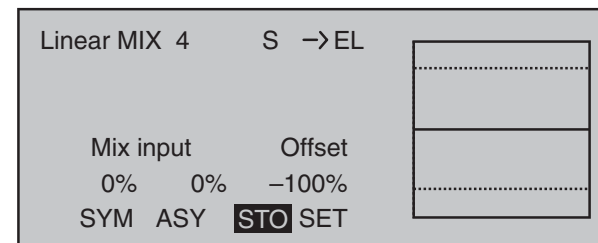

Now change left to **SYM** under "Mixer ratio" then tap briefly on the center **SET** key of the right touch pad. The value fields are now highlighted. After you have moved the selected switch to the mixer ON position, use the selection keys on the right touch pad to set the required symmetrical mixer ratio, for example:

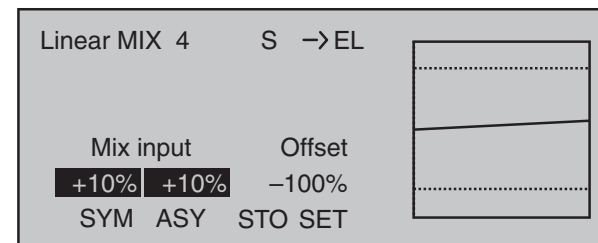

- If a multi-flap wing featuring a "crow or butterfly system" with (additional) airbrakes is intended, and this brake system is to be tested with and without airbrakes, then simply set channel 1 to "MIX-only" ...

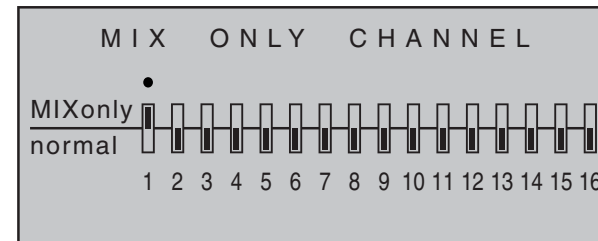

... and follow this by programming a free mixer "C1 → C1" to restore control over the airbrakes

via servo 1. If you also assign a switch to this mixer, then you will be able to switch this mixer on and off as you please.

- The final example applies to model helicopters: In the helicopter program, if you wish affect pitch trim with a proportional control, e.g. one of the slider controls in the middle of the console, then assign one of these controls to this function in the »**Control adjust**« menu; for example the "I9" input. (However, leave the default value of "GL" in the "Type" column as it is so this configuration, analogous to the free mixer yet to be programmed, will be applicable globally for all flight phases.) Finally, simply define a LinearMIX "9 → 1" with a symmetric mixer ratio of, for example, 25%. Due to the internal coupling, this transmitter control then acts equally on all of the model's collective pitch servos without affecting the throttle servo.

Linear MIX 5 9 → 1

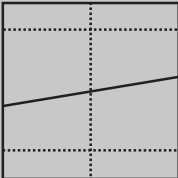
| | | |
|---|-----------------------------|--|
| Mix input | Offset |  |
| <input checked="" type="checkbox"/> +25% <input checked="" type="checkbox"/> +25% | <input type="checkbox"/> 0% | |
| SYM ASY STO SET | | |

Decouple the assigned transmitter control from control channel 9 in the »**MIX-only channel**« menu to ensure that any servo connected to receiver output 9 can no longer be operated by this transmitter control; see also page 205.

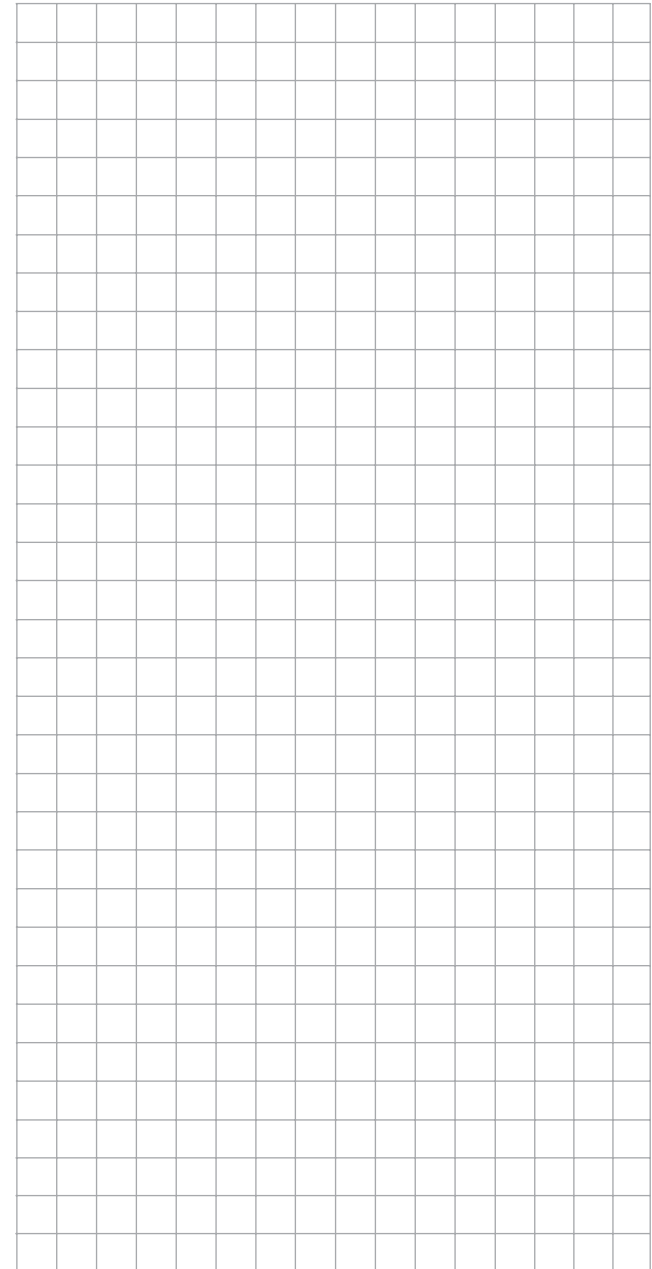

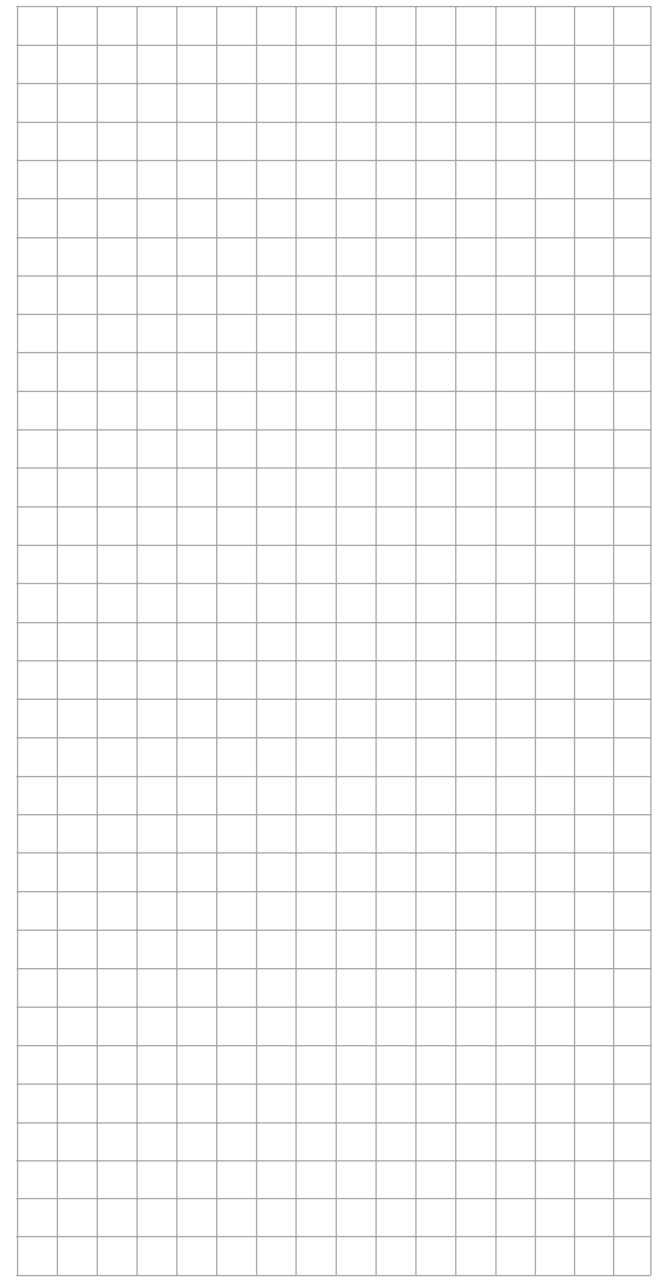
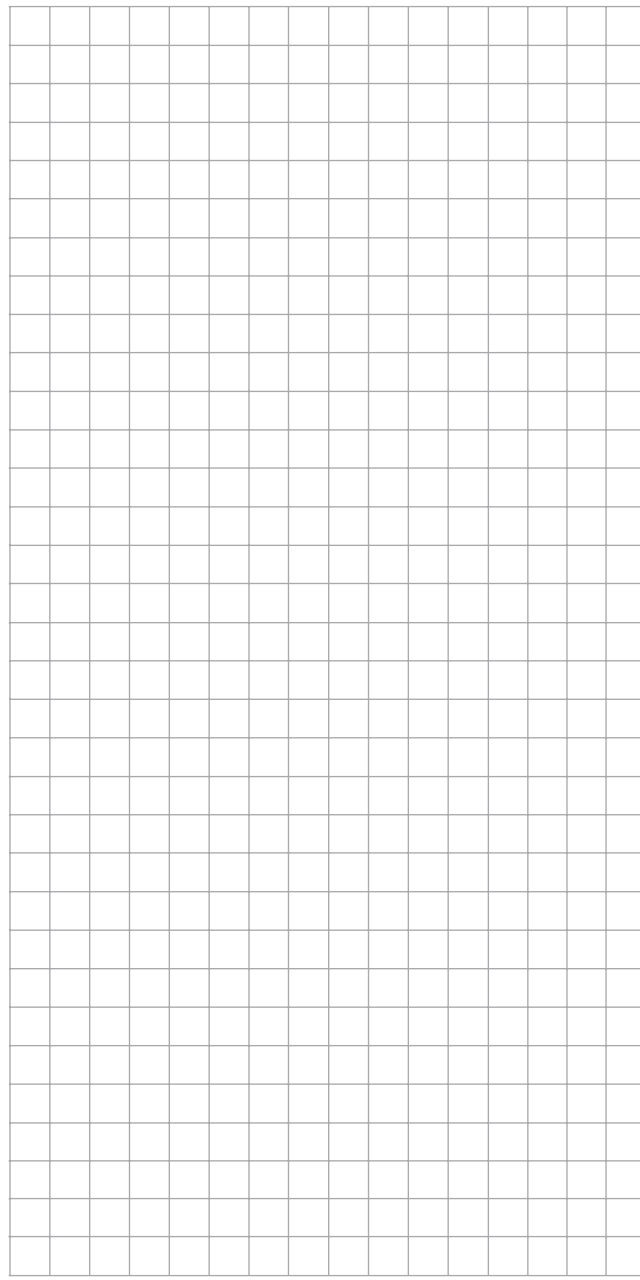
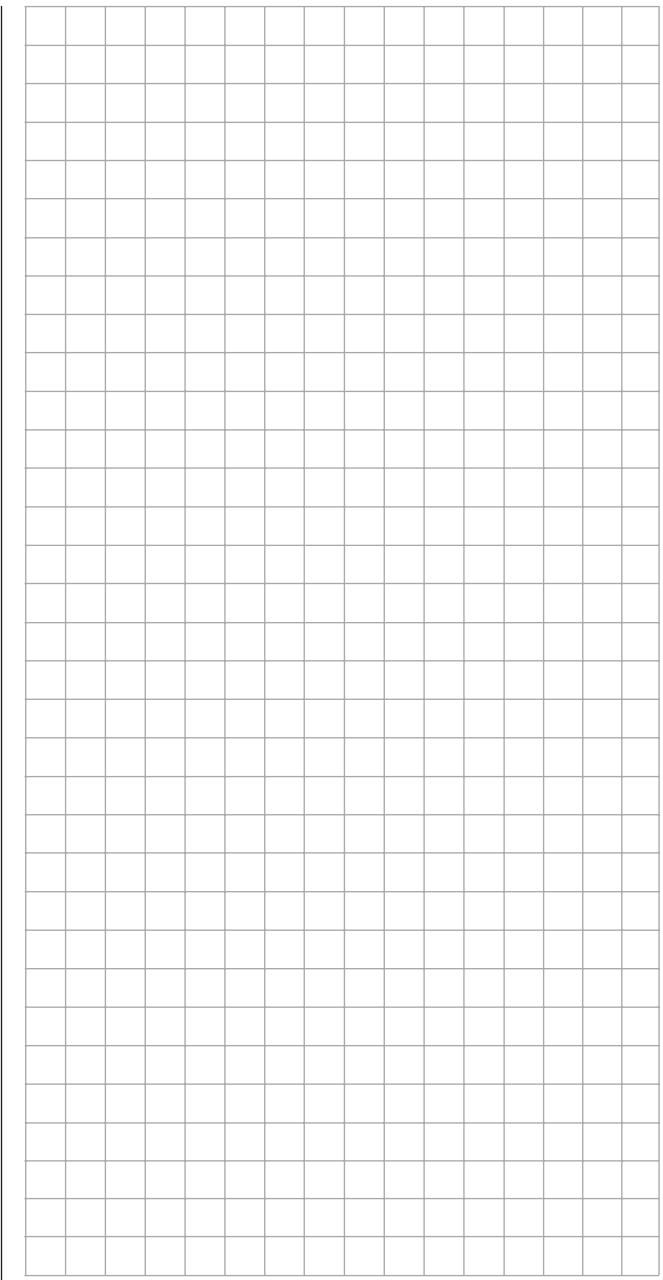



MIX active/phase

Selecting mixers for flight phases

Using the selection keys on the left or right touch pad, page to the menu option ...

| | | |
|-------------------------|------------------|--|
| Control switch | Logical switch | |
| Phase settings | Phase assignment | |
| Phase trim | Non-delayed chan | |
| Timers (general) | Fl. phase timers | |
| Wing mixers | Free mixers | |
| MIX active/phase | MIX only channel | |

| | | |
|------------------|-------------------------|--|
| Channel 1 curve | Switch display | |
| Control switch | Logical switch | |
| Phase settings | Phase assignment | |
| Non-delayed chan | Timers (general) | |
| Fl. phase timers | Helicopter mixer | |
| Free mixers | MIX active/phase | |

... on the multi-function menu. Briefly tap the center **SET** key of the right touch pad to open this menu option.

| MIX ACTIVE IN PHASE | | |
|---------------------|---------|-----|
| ▶ LinearMIX 1 | 6 → EL | yes |
| LinearMIX 2 | C1 → EL | yes |
| LinearMIX 3 | 3 → 8 | yes |
| LinearMIX 4 | S → EL | yes |
| | | SEL |

The "free mixers" on the previous menu can be enabled and disabled for specific flight phases. You therefore have complete freedom in assigning specific mixers only to specific flight phases. Switch to your chosen flight phase and use the selection keys to page through this menu. The mixers on the »Free mixers« menu are displayed in the center column.

Following the activation of the value field by briefly tapping the center **SET** key of the right touch pad, if the respective mixer is set to "no" by using the selection keys on the left or right touch pad, then this mixer is deactivated in the flight phase shown at the bottom of the display and, simultaneously, removed from the »Free mixers« menu list:

| MIX ACTIVE IN PHASE | | |
|---------------------|---------|-----------|
| LinearMIX 1 | 6 → EL | yes |
| ▶ LinearMIX 2 | C1 → EL | no |
| LinearMIX 3 | 3 → 8 | yes |
| LinearMIX 4 | S → EL | yes |
| | | SEL |

If a mixer is "lost" in the »Free mixers« menu ...

| | | | |
|---------------|---------|---------|--------|
| ▶ LinearMIX 1 | 6 → EL | 4 ↘ | off ⇒ |
| LinearMIX 2 | C1 → EL | C4 ↘ | off ⇒ |
| LinearMIX 4 | S → EL | 7 ↘ | off ⇒ |
| LinearMIX 5 | ?? → ?? | | — |
| LinearMIX 6 | ?? → ?? | | — |
| | type | from to | Adjust |

... then you should either switch through the flight phases until it appears again ... or, alternatively, switch to this menu and temporarily reactivate the mixer you are looking for:

| | | | |
|---------------|---------|---------|--------|
| LinearMIX 1 | 6 → EL | 4 ↘ | off ⇒ |
| LinearMIX 2 | C1 → EL | C4 ↘ | off ⇒ |
| ▶ LinearMIX 3 | 3 → 8 | | ⇒ |
| LinearMIX 4 | S → EL | 7 ↘ | off ⇒ |
| LinearMIX 5 | ?? → ?? | | — |
| | type | from to | Adjust |

MIX-only channel

Separating control functions from control channels for all flight phases

Using the selection keys on the left or right touch pad, page to the menu option ...

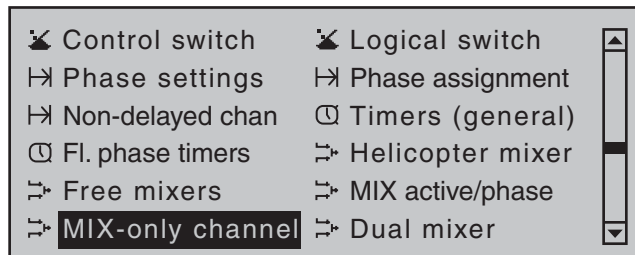
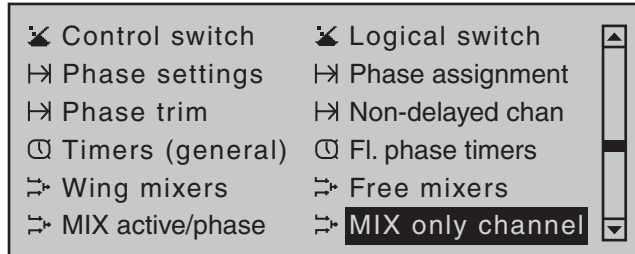

... on the multi-function menu. Briefly tap the center **SET** key of the right touch pad to open this menu option.

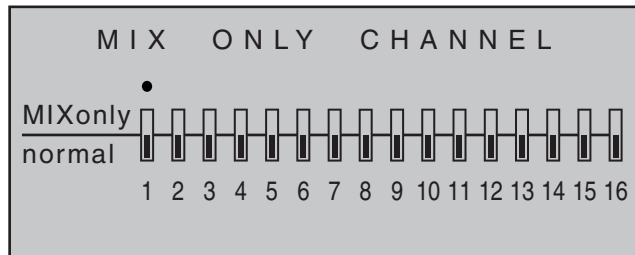

This menu can be used to interrupt the normal signal flow between the input side *control function* and the output side *control channel*, therefore the "classic" control-to-servo connection is actually separated. Use the potential offered by this *flight phase independent* menu, particularly to keep one of the control channels "free" in all flight phases from assignment to a transmitter control or switch for specific flight phases in the »**Control adjust**« menu.

Conversely of course, such a joystick, transmitter control or switch "robbed" of its servo can still be used freely as a control in other way—indeed even in flight phase dependence—, refer to the programming examples at the end of this section.

A joystick, transmitter control or switch robbed of its servo by setting the channel to "MIX only" will then namely affect mixer inputs only ...

... and the servo connected to a channel set to "MIX only" is then also only accessible from the mixers programmed to its control channel, i.e. "(with MIX(ers) only".

Accordingly, for any channel set to "MIX only", you can utilize both its control function and its control channel entirely independently of one another for any special functions you need; see the examples at the end of this section.

Use the selection keys on the left or right touch pad to select the desired channel from 1 to 16 () then briefly tap the center **SET** key of the right touch pad, to switch at will between "normal" (☐) and "MIX only" (◼) modes:

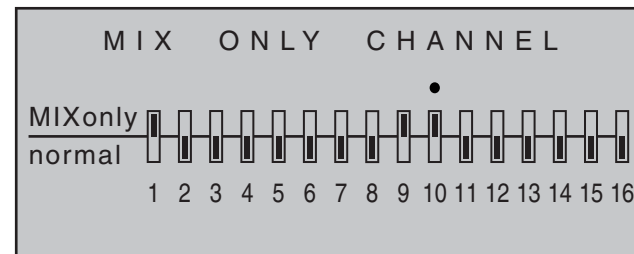

Examples:

- For model glider aircraft without airbrakes, the butterfly function (page 172) is generally used as a landing aid. Just as with "normal" airbrakes, this is generally controlled using the C1 stick. While the (airbrakes) servo typically connected to channel 1 is then generally absent as a rule, receiver output 1 is still not "free", since the control signal of the

brake stick is still present at this location. Its control signal—which in this specific case is not desired—can be decoupled from control channel "1" to thus "free up" this channel from the C1 joystick signal by setting channel 1 to "MIX only" in the »MIX-only channel« menu. This makes it possible to use control channel "1", together with receiver connection "1", at any time for other purposes, via freely-programmable mixers – e.g. to connect up a speed controller.

- If your model has built-in airbrakes, however, and you would like to perhaps test the performance of a butterfly system with and without airbrakes, simply set channel 1 to "MIX only" and program a free mixer "C1 → C1", so as to restore your ability to control the airbrakes via servo 1. If you also assign a switch to this mixer, then you will be able to switch this mixer on and off as you please.

Dual mixers

Same-sense/opposite-sense mixing of two control channels

Using the selection keys on the left or right touch pad, page to the menu option ...

| | |
|---------------------|--------------------|
| ⇒ Phase settings | ⇒ Phase assignment |
| ⇒ Phase trim | ⇒ Non-delayed chan |
| ⌚ Timers (general) | ⌚ Fl. phase timers |
| ⇒ Wing mixers | ⇒ Free mixers |
| ⇒ MIX active/phase | ⇒ MIX-only channel |
| ⇒ Dual mixer | △ Fail-safe adjust |

| | |
|--------------------|---------------------|
| ✂ Control switch | ✂ Logical switch |
| ⇒ Phase settings | ⇒ Phase assignment |
| ⇒ Non-delayed chan | ⌚ Timers (general) |
| ⌚ Fl. phase timers | ⇒ Helicopter mixer |
| ⇒ Free mixers | ⇒ MIX active/phase |
| ⇒ MIX-only channel | ⇒ Dual mixer |

... on the multi-function menu. Briefly tap the center **SET** key of the right touch pad to open this menu option.

| DUAL MIXER | |
|------------|-----------------|
| ▶ Mixer 1 | ▲ ?? ▲▲ ?? ▼ 0% |
| Mixer 2 | ▲ ?? ▲▲ ?? ▼ 0% |
| Mixer 3 | ▲ ?? ▲▲ ?? ▼ 0% |
| Mixer 4 | ▲ ?? ▲▲ ?? ▼ 0% |
| ▼ | Diff. |

The four *flight phase independent* dual mixers couple a V-tail mixer in a similar manner ...

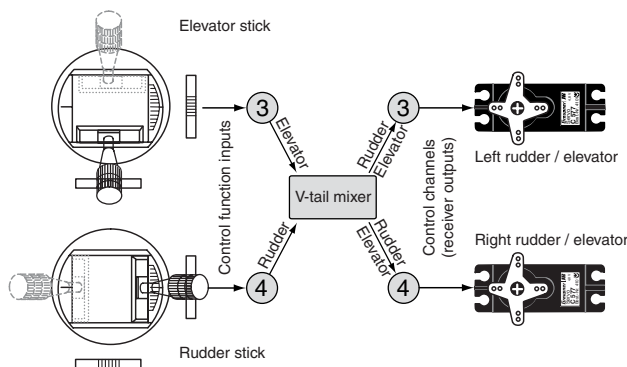

... a same-sense "▲ ▲" and an opposite-sense "▲ ▼" control function, although they permit any channel to be used and offer differential travel for the opposing function.

Important notice:

Since the same and opposite sense influences of the given input on the two servos or rudder flaps – coupled to one another by the dual mixer – are determined by, among other things, their installation situation and the direction of rotation specified in the »Servo adjustment« menu, the symbols "▲ ▲" and "▲ ▼" are to be perceived more as synonyms rather than as consistently appropriate definitions! Accordingly, if wing flaps are deflected in the wrong direction, simply swap the two inputs or use the "servo reverse" option in the »Servo adjustment« menu; see page 102.

In the software, the V-tail mixer already mentioned is supplemented by other "dual mixers" for realization of the two aileron servos on receiver outputs 2 and 5 and for the flap pairs on outputs 6 and 7, possibly also 9 and 10. These are activated via the aileron stick and the transmitter control that has been assigned to input "6" on the »Control adjust« menu. In the same way, the four freely-programmable

dual mixers on this menu can be used to couple two further control functions, a feature that would otherwise only be possible with time-consuming programming of free mixers.

Here, we will use a "V-tail with rudder differential" as our example to explain the programming of a dual mixer (see also the examples on page 286):

| DUAL MIXER | |
|------------|-------------------|
| ▶ Mixer 1 | ▲ EL ▲▲ RU ▼ +25% |
| Mixer 2 | ▲ ?? ▲▲ ?? ▼ 0% |
| Mixer 3 | ▲ ?? ▲▲ ?? ▼ 0% |
| Mixer 4 | ▲ ?? ▲▲ ?? ▼ 0% |
| ▼ | Diff. |

Depending on activation, both servos move in the sense of elevators or rudder flaps. The differentiation, according to dual mixer configuration, is only effective for rudder activation. In this case, both corresponding trim wheels are effective. No additional free mixers are required for this arrangement. **When using this mixer, however, the tail type MUST be entered as "normal" on the "Model type" menu.**

Tip:

All settings can be checked directly in the »Servo display« menu, which can be accessed from almost any other menu by simultaneously tapping the ◀ ▶ keys on the left touch pad.

Example:

Model with two rudders, with differential travel and outward movement (e.g. swept-back flying wing):

| DUAL MIXER | | |
|------------|--------------|-------|
| ►Mixer 1 | ▲ 8 ▲▲RU ▼ | +75% |
| Mixer 2 | ▲ ?? ▲▲ ?? ▼ | 0% |
| Mixer 3 | ▲ ?? ▲▲ ?? ▼ | 0% |
| Mixer 4 | ▲ ?? ▲▲ ?? ▼ | 0% |
| ▼ | | Diff. |

*When a rudder command is given, the second servo connected to output 8 follows suit. (With this type of programming, differential travel can be configured for the rudders.) In this case, too, trim from the rudder stick affects both servos. If the rudders are also required to deflect outwards when the airbrakes are activated, then you should assign the C1 stick (transmitter control 1) to input 8 on the »**Control adjust**« menu. Afterwards, change to the "Offset" column then modify the offset value until both rudders are again in their neutral positions. It may be necessary to "play" a bit with the offset and travel adjustments.*

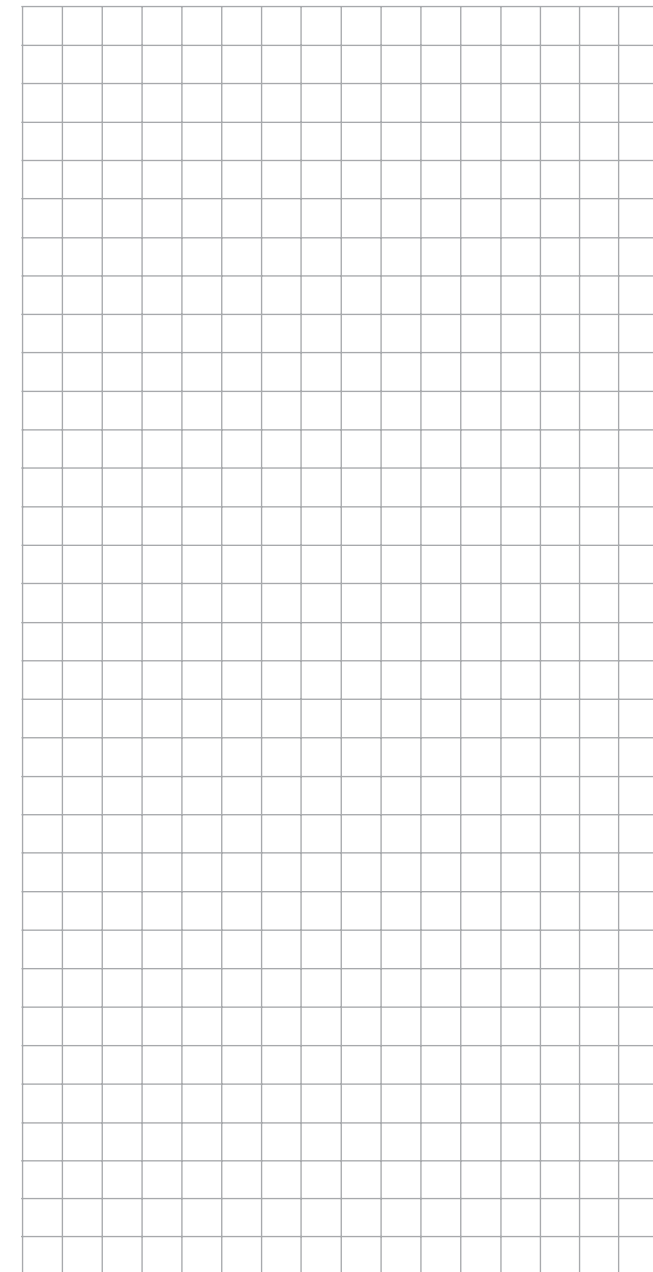
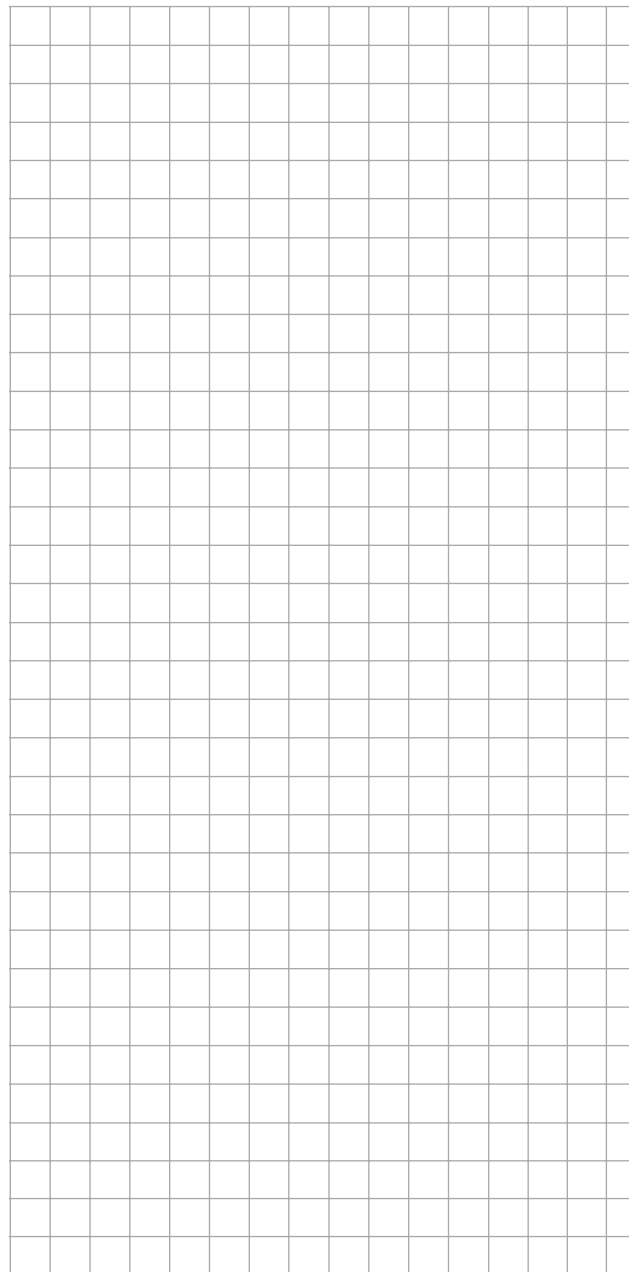

Swashplate mixer

Collective pitch, roll, pitch-axis mixer

Using the selection keys on the left or right touch pad, page to the menu option ...

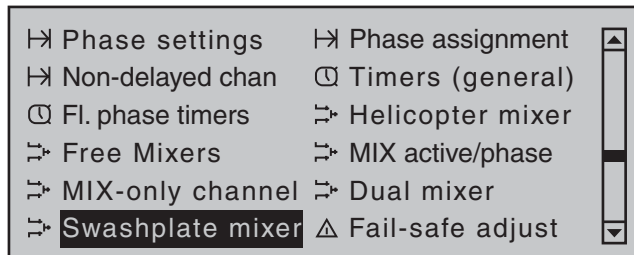

... on the multi-function menu. Briefly tap the center **SET** key of the right touch pad to open this menu option:



Note:
If "1 servo" is selected on the "Swashplate" line of the »Helicopter type« menu, this option is not shown on the multi-function menu.

The number of servos installed in your helicopter for pitch control was established in the Swashplate line of the »Helicopter type« menu, see page 98. This information is used to automatically couple together the functions for roll, pitch-axis and collective pitch, so that you do not need to define any other mixers yourself.

For helicopter models with only a single collective pitch servo, this "Swashplate mixer" menu option is of course superfluous because the software controls a total of three swashplate servos for pitch, nick and roll independently of one another, i.e. without a mixer. In

this scenario, this menu option is therefore no longer available to you from the multi-function menu. With all other swashplate linkages employing 2 ... 4 pitch servos, mixer ratios and mixer directions are set up by default as shown above. The default is +61% in each case but the value can be varied from -100% to +100% if required by briefly tapping the center **SET** key of the right touch pad and its selection keys. Simultaneously tapping both ▲▼ or ◀▶ selection keys on the right touch pad (**CLEAR**) will reset the mixer ration in inverse video again to the +61% default value.

If the swashplate control system (collective pitch, roll and pitch-axis) does not respond to the joysticks properly, you should alter the mixer directions ("+" or "-") before trying to correct the directions of servo rotation.

Note:
Ensure that changed mixer values do not result in the servos mechanically striking their end-stops.

Fail-safe

Fault condition setpoints

Using the selection keys on the left or right touch pad, page to the menu option ...

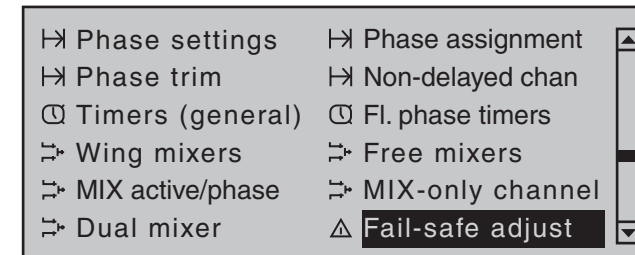

... on the multi-function menu. Briefly tap the center **SET** key of the right touch pad to open this menu option:

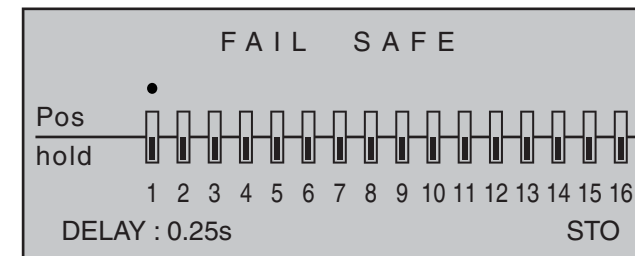

The higher level of operating safety exhibited by the HoTT system when compared to traditional PPM technology results from the fact that the microprocessor built into the HoTT receiver not only exclusively processes the signals of "its" transmitter, but can also clean up "dirty" control signals that it receives. Only when these signals become too error-prone or garbled due to outside interference does the processor automatically replace the disrupted signals

with the last received correct signal, temporarily stored in the receiver. This feature is configured by the settings as described below. This feature also suppresses brief interference caused by e.g. local drops in field strength, which otherwise result in the familiar "glitches". In this case, the red LED lights up on the receiver.

If you have selected a PCM transmission mode for the active model memory but have not yet carried out the fail-safe programming, you will see a warning message on the screen when you switch on the transmitter:



Programming procedure

The "Fail Safe" function determines the behavior of the receiver if communication between the transmitter and the receiver is disrupted. Receiver outputs 1 ... 16 can optionally ...

1. preserve the current position ("hold"): if communication is disrupted, all servos programmed to "hold" mode remain at the positions judged to be the last valid positions by the receiver until the receiver picks up another valid control signal, or
2. move to a freely selectable position ("Pos") if interference should occur, following the expiry of the "time delay".

Use selection keys ◀ ▶ on the left or right touch pad to select the desired servo connection 1 bis 16 () then briefly tap the center **SET** key of the right touch pad to freely switch between "hold" (□) and "Pos" mode (▣):

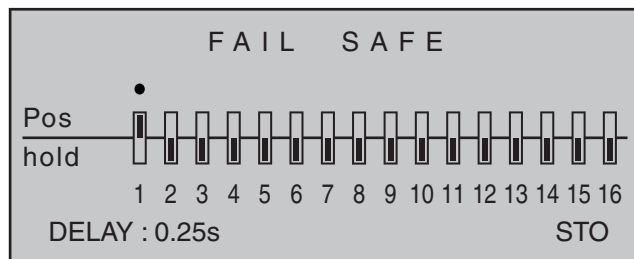

Following this, use the selection keys ◀ ▶ on the left or right touch pad to select the "DELAY" option shown at the bottom of the display ...

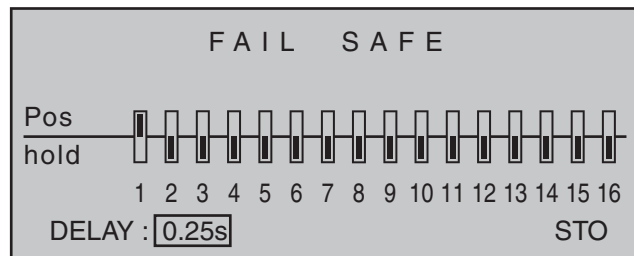

... and then briefly tap the center **SET** key of the right touch pad. Now use the touch pad's selection keys to make your choice from the four possible time delays (0.25 s, 0.5 s, 0.75 s and 1 s) offered.

A simultaneous tap on the ▲ ▼ or ◀ ▶ selection keys of the right touch pad (**CLEAR**) will reset the inverse video field to its default value 0.25 s.

Afterwards, select the **STO** field at the bottom right of the display with the ◀ ▶ selection keys on the left or right touch pad. Now put the servos which have been switched into position mode into their desired positions **SIMULTANEOUSLY** with the respective operating elements.

Briefly tap the center **SET** key of the right touch pad to store these positions as the fail-safe setting for the receiver, so that it can revert back to them if interference is experienced.

Successful storage of the positions is confirmed briefly on the screen:

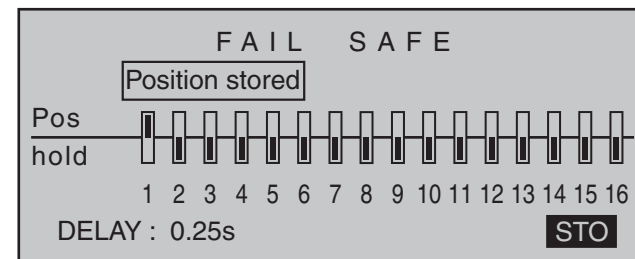

Attention:

- **Please note that decisive fail-safe settings are stored in the receiver! Therefore, following a change of receivers, these fail-safe settings should be renewed and in the previous receiver they should be erased, if necessary per Reset, see page 46.**
- **Ensure you make use of this safety net by at least programming the following for a fail-safe incident: for glow-powered models, set the motor throttle position to idle; for electric models, set the motor function to stop, or "Hold" for helicopter models. If interference should occur, the model is then less likely to fly off on its own and cause damage to property or even personal injury. Consider asking an experienced pilot for advice.**

Connecting two transmitters for trainer mode with a trainer lead

The **MC-20** HoTT transmitter is equipped standard—as viewed from the front, under the left front flap—with a DSC socket. This is not only usable for connecting flight simulators—as described on page 22— but also to integrate the transmitter into a cable-coupled teacher/pupil system.

To accommodate the settings necessary for this, scroll with the selection keys on the left or right touch pad to the »**Teacher/pupil**« menu option in the Multifunction menu:

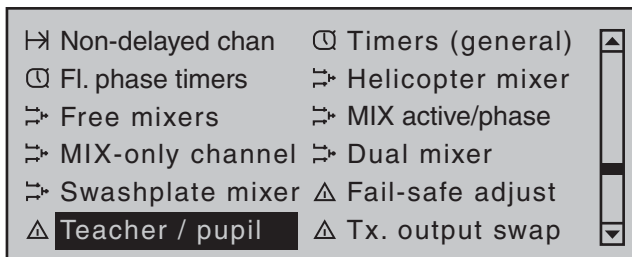
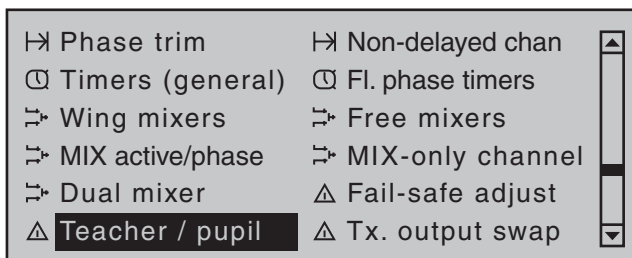

Briefly tap the center **SET** key of the right touch pad to open this menu option:

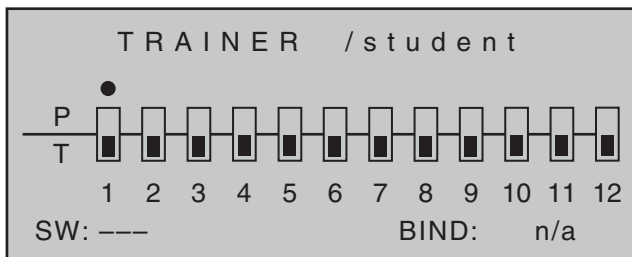

Note:

The screen image shown above shows the menu in its initial state: No transmitter controls have been released by the pupil (■) and no switch is assigned ("SW: ---" bottom left in the screen image).

When assigning control functions, the usual conventions must be observed:

| Channel | Function |
|---------|---------------------------------|
| 1 | Motor throttle/collective pitch |
| 2 | Aileron/roll |
| 3 | Elevator/pitch-axis |
| 4 | Rudder/tail rotor |

Teacher-pupil settings

Up to twelve *function inputs* (see "Term definitions" on page 54) of the teacher transmitter "T" can be individually or in any combination transferred to the pupil transmitter "P".

The lower display line, designated with "T", therefore indicates the **function inputs** with which control functions 1 ... 4 (joystick functions for fixed-wing and helicopter models) are permanently connected as well as inputs 5 ... 12, which can be freely assigned in the »**Control adjust**« menu.

Note:

Just which controls are assigned to any inputs turned over to the pupil is basically of no consequence. However, their assignment in the »**Control adjust**« menu is possible only when the trainer mode connection is inactive.

Use the ◀ ▶ selection keys of the left or right touch pad to select the function inputs 1 through 12 for transfer to the pupil() then briefly tap center **SET** key of the right touch pad for each switch to be switched between "T(eacher)"(■) and "P(upil)"(■):

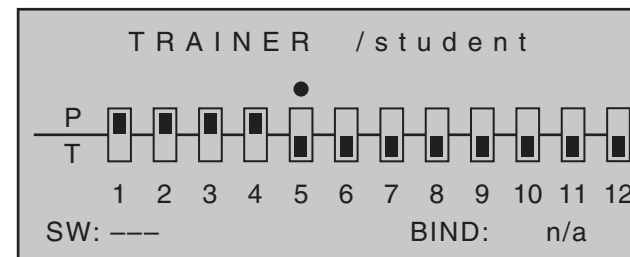

To be able to carry out the transfer, you must then assign a trainer mode switch on the left of the display. Do this by placing the marker just to the right of the "P" at the bottom left of the screen display by using the selection keys of the left or right touch pad then assign a switch as described in the section "Assigning transmitter controls, switches and control switches" on page 56.

Preferably you should utilize one of the two standard momentary switches on the switchboard to allow a return of control to the teacher transmitter at any time.

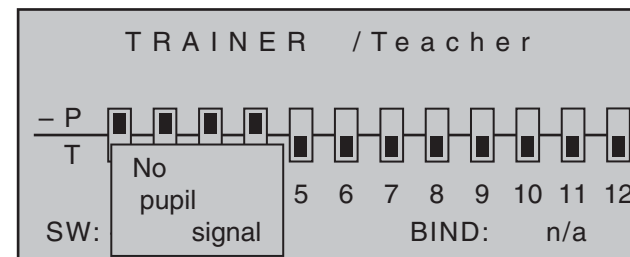

Since at this early stage of programming a trainer system it is unlikely that an operational pupil transmitter is connected to the teacher transmitter, the transmitter responds immediately to the switches closed during the switch assignment process with appropriate visual and audible warning notices. You should therefore re-open the switch you have just assigned:

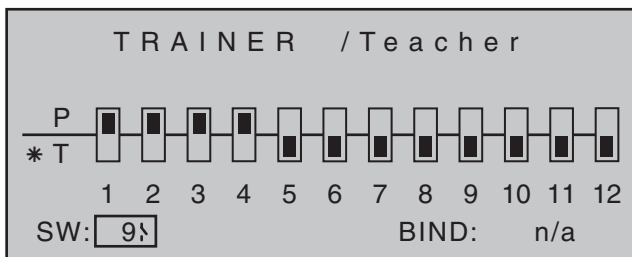

Note:

The switch assignment just described also determines the transmitter used to issue the teacher and pupil functions, respectively. For this reason, a pupil transmitter must NEVER be assigned a switch on this menu. **The header line therefore also switches from "Teacher / Pupil" to "Teacher / Teach" once a switch has been assigned.**

The model to be controlled by the pupil *must be programmed completely*—i.e. with all its functions including trims and any mixer functions—in one of the model memories of the **MC-20** HoTT teacher transmitter. The HoTT receiver of the model in question must also be "bound" to the teacher transmitter, since the latter ultimately controls the model, even in pupil mode.

ALWAYS ENSURE YOU SWITCH ON THE MC-20 HoTT teacher transmitter FIRST BEFORE PLUGGING THE CONNECTION CABLE INTO THIS UNIT. Otherwise the RF module will not be activated.

The **MC-20** HoTT teacher transmitter can be connected to any suitable pupil transmitter, even transmitters using the "traditional" 35/40 MHz range. This means, for example, that a **MC-20** HoTT teacher transmitter can indeed also be connected to a **mc-24** pupil transmitter.

However, if the pupil-side connection is NOT made via a two-pole DSC socket but rather via a three-pole trainer socket (for example, out of the *Graupner*

product line), **then the basic prerequisite for a correct connection to a pupil transmitter which is completely independent of the type of modulation used in the teacher transmitter must ALWAYS be set to modulation type PPM (10, 16, 18 or 24) in the pupil transmitter.**

Pupil transmitter set-up

The model to be controlled by the pupil *must be programmed completely*, i.e. with all its functions including trims and any mixer functions, in one of the model memories of the teacher transmitter and, if applicable, the HoTT receiver of the model in question must also be "bound" to the *teacher* transmitter. In principle, a **MC-20** HoTT pupil transmitter can also be connected to a teacher transmitter operating on the "traditional" 35/40 MHz bands. This is possible because the PPM signal required by the teacher transmitter is available in the (pupil) transmitter's DSC socket.

Almost any transmitter with at least four control functions from previous and current *Graupner* series can be used as a pupil transmitter. More detailed information can be found in the RC main catalog and on the www.graupner.de website.

If required, the pupil transmitter should be fitted with the connection module for pupil transmitters. This is to be connected to the transmitter board in accordance with the supplied installation instructions. Information on the pupil modules required in each case can be found in the *Graupner* RC main catalog and on the www.graupner.de website.

The connection to the teacher transmitter is made using the appropriate lead; see the following double page.

The control functions of the pupil transmitter MUST act directly on the control channels, i.e. the receiver outputs, without intermediary mixers.

If you are using an "mc" or "mx" series transmitter,

it is best to activate a free model memory with the required model type ("Fixed-wing" or "Heli"). Assign the model name "Pupil" and set up the stick mode (mode 1 ... 4) and "Throttle min. forward/back" to suit the pupil's preferences. All other settings are left at their default values, however. If you have selected the "Helicopter" model type, you must also set the throttle/ collective pitch direction and idle trim on the pupil transmitter. All other settings, including mixer and coupling functions, are configured exclusively on the teacher transmitter, which in turn transmits them to the model.

If the pupil transmitter is a **mx-20** HoTT or **MC-20** HoTT series model then it may also be necessary to adapt the type of modulation in the "DSC output" line of the »**Base setup model**« menu in order to accommodate the *number* of control channels to be transmitted. For example, the signal packet for modulation type "PPM10" contains only control channels 1 ... 5 but not channel 6. However, if this channel is to be used by the pupil then a modulation type must be selected in which it is included.

For transmitters of type "D" and "FM" it is necessary to check servo operating directions and their control correlations. It may be necessary to reconnect cables appropriately. All mixers must also be switched off or set to "zero".

When assigning control functions, the usual conventions must be observed:

| Channel | Function |
|---------|---------------------------------|
| 1 | Motor throttle/collective pitch |
| 2 | Aileron/roll |
| 3 | Elevator/pitch-axis |
| 4 | Rudder/tail rotor |

If other control functions are to be transferred to the pupil transmitter in addition to the functions of the two

dual axis sticks (1 ... 4), access the »Control adjust« menu in the pupil transmitter and assign those *inputs* which correspond to enabled *function inputs* 5 ... 12 as shown in the »Teacher/pupil« menu of the teacher transmitter. Afterwards, assign the operating elements appropriately.

Important:

- ***If you should forget to assign a transmitter control on the pupil side, then the affected servo or servos will remain in the center position when the transfer is made to the pupil transmitter.***
- ***The pupil transmitter must always be operated in PPM mode, regardless of the RF connection type used between the teacher transmitter and the model.***
- ***If the transmitter is connected using a DSC socket on the pupil side, ALWAYS leave the pupil transmitter's On/Off switch in the "OFF" position: this is the only way to guarantee that no RF signal is sent from the pupil transmitter's transmitter module, even after the DSC lead has been plugged in.***

Trainer mode operations

Both transmitters are connected to one another using a suitable lead (see summary on next page): The plug marked "M" (master) must be inserted into the socket on the teacher transmitter, and the plug marked "S" (student) into the pupil transmitter's socket. (Note that not all leads may have such "M" and "S" labeling.)

Important notices:

- ***Check that the model aircraft is operational and check that all functions issue the correct commands BEFORE setting up trainer mode.***
- ***The ends of the trainer lead, usually marked***

as either "S" or "M", terminate in a three-pole TRS jack. Do not insert these jacks into a DSC system socket, as it is not suitable for this application. The DSC socket is exclusively designed for cables with 2-pole TRS jacks.

Checking functionality

Activate the assigned trainer mode switch:

- The trainer mode system is working properly if the display now changes from "* L" to "* S".
- However, if the **WARNING** LED at the right, next to the transmitter's On/Off switch, blinks and an acoustic signal sounds off at the same time, then the connection between pupil and teacher transmitters is faulty.

The basic display also displays the following warning notice ...

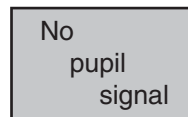

... and the left side of the screen display for the »Teacher/pupil« menu will change to show "-Pupil". In this case, all control functions are retained by the teacher transmitter automatically, regardless of switch position: this ensures the model is always under control.

Possible faults:

- Pupil transmitter not ready
- Interface in pupil transmitter not correctly connected in place of the RF module
- Cables connected wrongly: see right for cable connections
- Pupil transmitter not switched over to PPM (10, 16, 18, 24) mode

Other possible faults:

- Teacher transmitter not properly "bound" to HoTT receiver in training model

Trainer cables

- 4179.1** for trainer operation between any two *Graupner* transmitters equipped with DSC sockets – distinguished by a two-pole TRS jack at both ends.
- 3290.7** trainer cable for connecting a teacher transmitter with DSC socket (e.g. **NC-20** HoTT) or a transmitter retrofitted with an optional DSC module, order no. **3290.24**) to a *Graupner* pupil transmitter with an opto-electronic system pupil socket – identifiable by the mark "S" on the side of the three-pole TRS jack.
- 3290.8** trainer cable for connecting a pupil transmitter with DSC socket (e.g. **NC-20** HoTT) or a transmitter retrofitted with an optional DSC module, order no. **3290.24**) to a *Graupner* teacher transmitter with an opto-electronic system teacher socket – identifiable by the mark "M" on the side of the three-pole TRS jack.

Further details about the cables and modules mentioned in this section for teacher and pupil transmitters can be found in the respective transmitter handbook, in the *Graupner* RC main catalog or in Internet at www.graupner.de.

Trainer mode with the **MC-20** HoTT transmitter

Due to the continuous improvements made to the product range, please consult our website at www.graupner.de for the latest information

Pupil transmitter **MC-20** HoTT

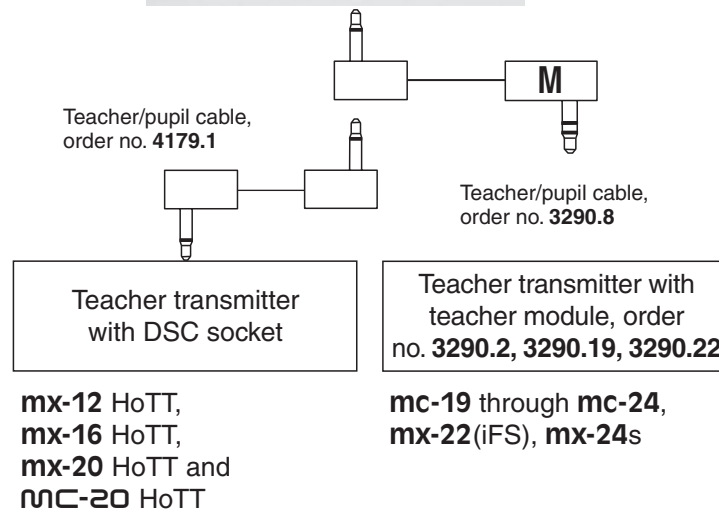

Teacher transmitter **MC-20** HoTT

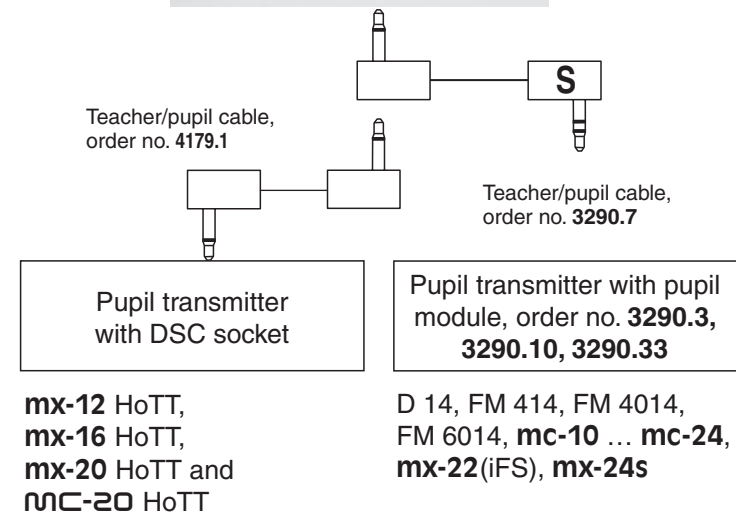

Note:

The lists present the possible transmitters/transmitter combinations at the time of going to press.

Wireless HoTT system

Wireless operation of the **MC-20** HoTT trainer mode system is also possible. To do so, the teacher transmitter must be "connected" to a pupil transmitter as described below. Prior to this, however, the training model's receiver must be bound to the PUPIL transmitter. This configuration is possible between transmitters which have the "BIND:" option in the »Teacher/pupil« menu.

Preparing for training mode

Teacher transmitter

The training model *must be programmed completely*, i.e. with all of its functions including trims and any mixer functions, in one model memory of the HoTT teacher transmitter. **The model to be used for training must therefore be under the complete control of the teacher transmitter. The final step in preparation, however, is to bind the training model to the pupil transmitter. For a detailed description of the binding process, please consult pages 77 and 85.**

Pupil transmitter

If you are using an "mc" or "mx" series transmitter, it is best to activate a free model memory with the required model type ("Fixed-wing" or "Heli"). Assign the model name "Pupil" and set up the stick mode (mode 1 ... 4) and "Throttle (or collective pitch) min. forward/back" to suit the pupil's preferences. All other options are left at their default values. All other settings, including all mixer and coupling functions, are configured exclusively on the teacher transmitter, which in turn transmits them to the model.

When assigning control functions, the usual conventions must be observed:

| Channel | Function |
|---------|---------------------------------|
| 1 | Motor throttle/collective pitch |
| 2 | Aileron/roll |

| | |
|---|---------------------|
| 3 | Elevator/pitch-axis |
| 4 | Rudder/tail rotor |

If other control functions are to be transferred to the pupil transmitter in addition to the functions of the two dual axis sticks (1 ... 4), access the »Control adjust« menu in the pupil transmitter and assign those *inputs* which correspond to enabled *function or transmitter control inputs 5 ... 12* as shown in the »Teacher/pupil« menu of the teacher transmitter. Afterwards, assign the operating elements appropriately.

Important:

If you should forget to assign a transmitter control on the pupil side, then the affected servo or servos will remain in the center position when the transfer is made to the pupil transmitter.

Preparing the teacher and pupil transmitters

Once you have bound the training model to the pupil transmitter, now switch on the teacher transmitter. On both transmitters, use the selection keys on the left or right touch pad, page to the »Teacher/pupil« menu option on the multi-function menu:

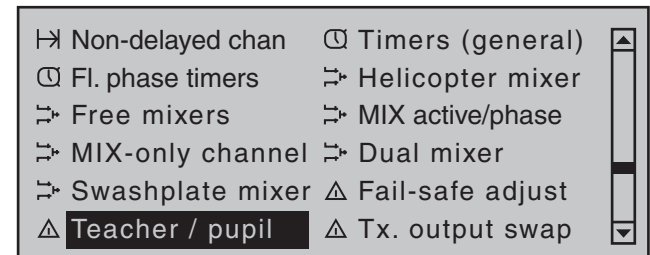
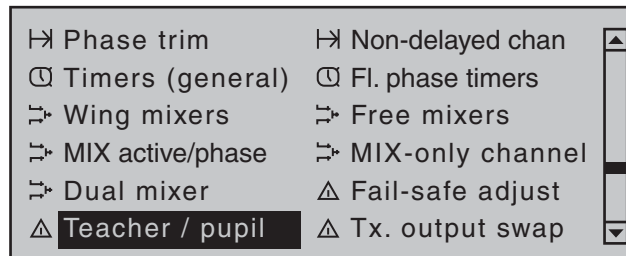

Briefly tap the center **SET** key of the right touch pad to open this menu option:

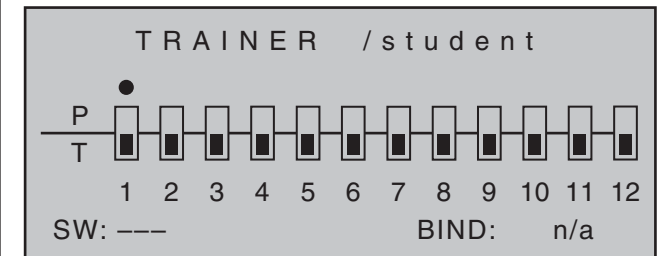

Note:

The screen image shown above shows the menu in its initial state: No transmitter controls have been released to the pupil (■) and no switch has been assigned ("SW: ---" bottom left in the screen image).

Pupil transmitter

Use the selection keys on the left or right touch pad to move the marker frame to the "BIND" input field. If there is a switch shown at the right of "S:" then this *must* first be erased, see screen image:

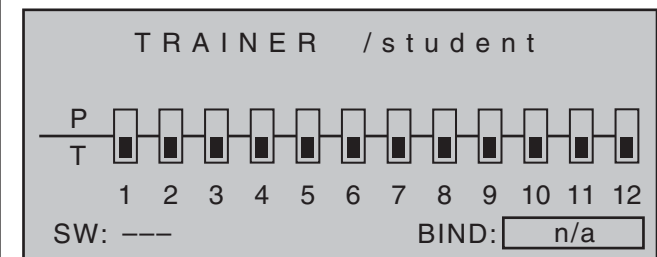

Teacher transmitter

Up to twelve *function inputs* (see "Term definitions" on page 54) of the teacher transmitter "T" can be individually or in any combination transferred to the pupil transmitter "P".

The lower display line, designated with "T", therefore indicates the **function inputs** with which control functions 1 ... 4 (joystick functions for fixed-wing and helicopter models) are permanently connected as well as inputs 5 ... 12, which can be freely assigned in the »**Control adjust**« menu.

Note:

Just which controls are assigned to any inputs turned over to the pupil is basically of no consequence. However, their assignment in the »**Control adjust**« menu is possible only when the trainer mode connection is inactive.

Use the ◀ ▶ selection keys of the left or right touch pad to select the function inputs 1 through 12 for transfer to the pupil () then briefly tap center **SET** key of the right touch pad for each switch to be switched between "T(eacher)" (☐) and "P(upil)" (☐):

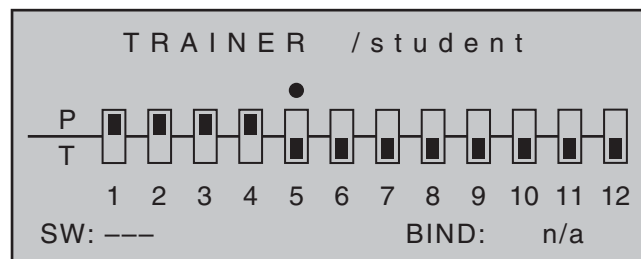

To be able to carry out the transfer, you must now assign a trainer mode switch. Do this by placing the marker frame just to the right of the "P" at the bottom left of the screen display by using the selection keys of the left or right touch pad then assign a switch as described in the section "Assigning transmitter controls, switches and control switches" on page 56. Preferably you should utilize one of the two standard

momentary switches on the switchboard to allow a return of control to the teacher transmitter at any time:

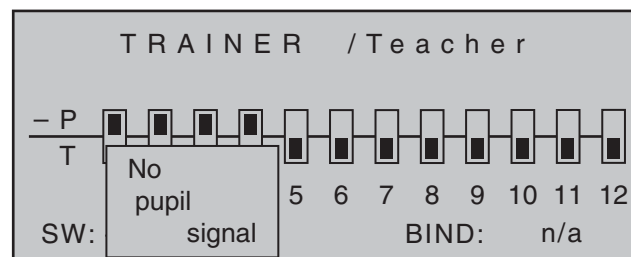

Since at this stage of programming the wireless trainer system no connection yet exists to a pupil transmitter, the transmitter responds immediately to the switches closed during the switch assignment process with appropriate visual and audible warning notices. You should therefore re-open the switch you have just assigned:

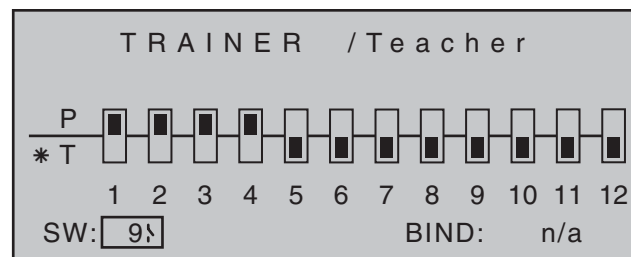

Note:

The switch assignment just described also determines the transmitter used to issue the teacher and pupil functions, respectively. For this reason, a pupil transmitter must NEVER be assigned a switch on this menu. **The header line therefore also switches from "Teacher / Pupil" to "Teacher / Teach" once a switch has been assigned.**

Using the selection keys on the left or right touch pad, now move the marker frame to the right, to "BIND: n/a":

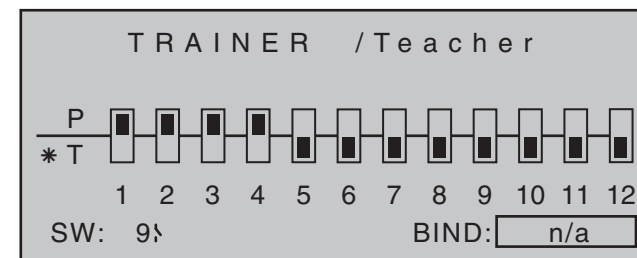

Binding the pupil transmitter to the teacher transmitter

Note:

The distance between the two transmitters should not be too great during the binding process. If necessary, change the positions of the transmitters and initiate the binding process again.

Initiate the "BINDING" process from the pupil transmitter by tapping the center **SET** key of the right touch pad ...

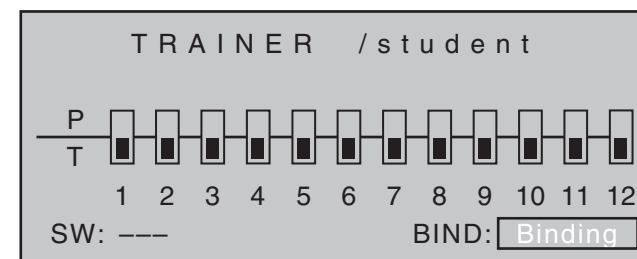

... and repeat this immediately on the teacher transmitter:

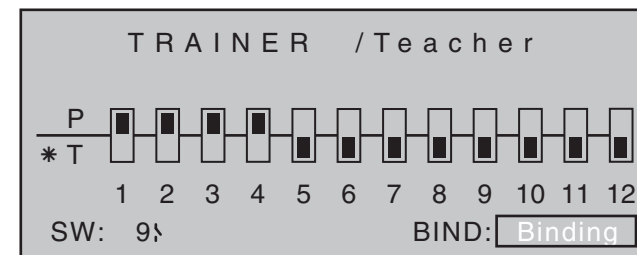

As soon as this process is complete, both screens will show "ON" instead of the flashing "BINDING":

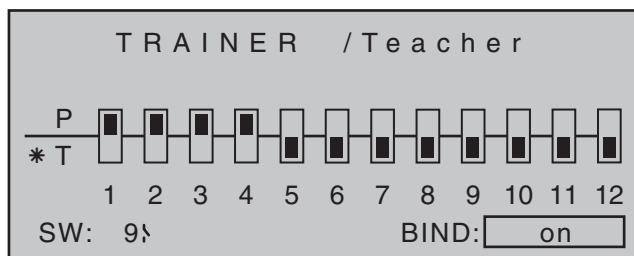
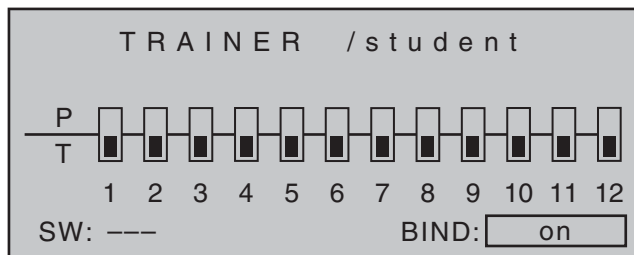

You can return to the basic display on both screens and start the training session after carefully checking all of the relevant functions.

If neither transmitter or only one transmitter displays "ON", this means the binding process has failed: try changing the positions of both transmitters and then repeat the entire procedure.

Important notice:

Check that the model aircraft is operational and check that all functions issue the correct commands BEFORE setting up trainer mode.

During the ...

Training session

... the teacher and pupil can maintain a variable distance from one another. The "reach of signal" (max. 50 m) should not be exceeded under any circumstances, however, no one else should be standing between the teacher and the pupil since

these persons could reduce the connection range of the return channel used by the two transmitters.

In this operating mode, the basic display of the teacher transmitter is as shown below ...

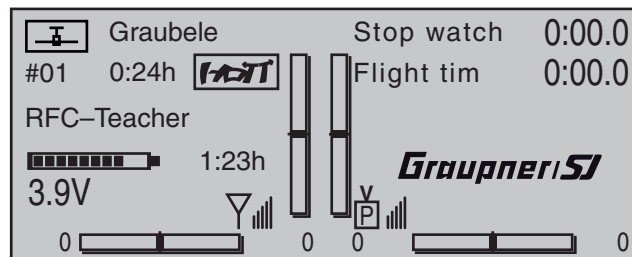

... and the pupil transmitter's display will look something like this:

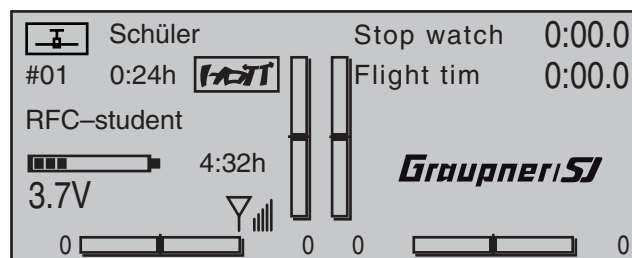

If, however, the connection between the teacher and pupil transmitters should be lost during the training session, then the teacher transmitter will automatically assume control of the model.

If the trainer mode switch is in the "Pupil" position when connectivity is lost, the **WARNING** LED on the teacher transmitter will blink and audible warning signals will also be sounded for as long as the signal is lost. The basic display also displays the following warning notice:

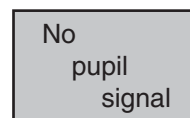

However, if only the character string "HF -" blinks on the transmitter's basic display accompanied by the audible warning signals, the pupil signal has been lost but the trainer mode switch is set to the "Teacher" position.

In both cases, your first step should be to reduce the distance between the two transmitters. If this does not help, then you should land immediately and establish the cause.

If both transmitters are operational and the receiver system is switched off, then the teacher transmitter's basic display will show the * icons instead of the "familiar" ... The antenna icon will also flash and an audible warning signal will sound twice per second.

Resuming trainer mode

If you switch off one or both transmitters during the session—for whatever reason—then the basic display of the transmitter(s) shows the following question after being switched back on:

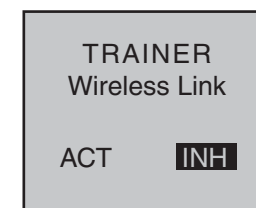

If "INH" (set) is confirmed by tapping the center **SET** key of the right touch pad or, alternatively, by waiting for approx. two seconds until the message disappears, then you will reset the transmitter in question back to its "normal" operating mode. You will then have to re-establish a connection between the teacher and pupil transmitters.

If, on the other hand, the selection keys on the left or right touch pad are used to select "ACT" ...

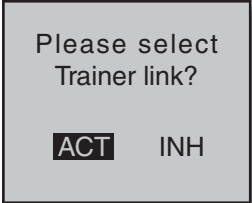

... and this selection is confirmed by tapping the center **SET** key of the right touch pad, then the existing teacher connection is restored. The same approach is used if the transmitter is configured as a pupil transmitter.

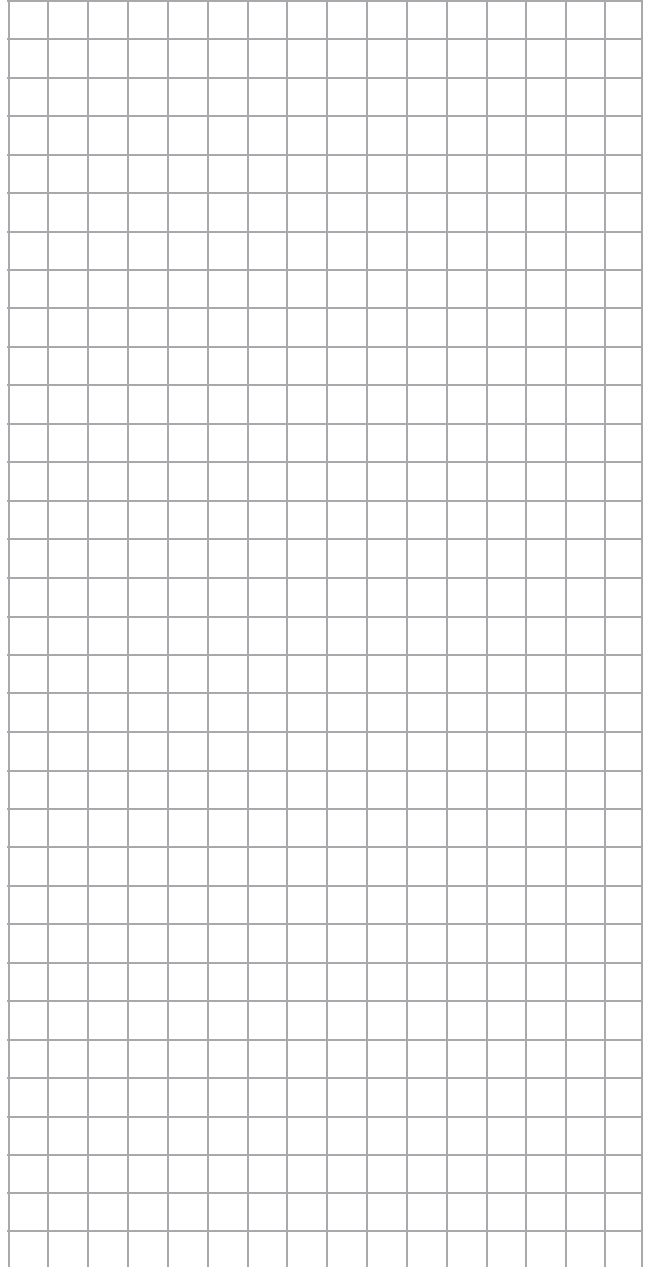
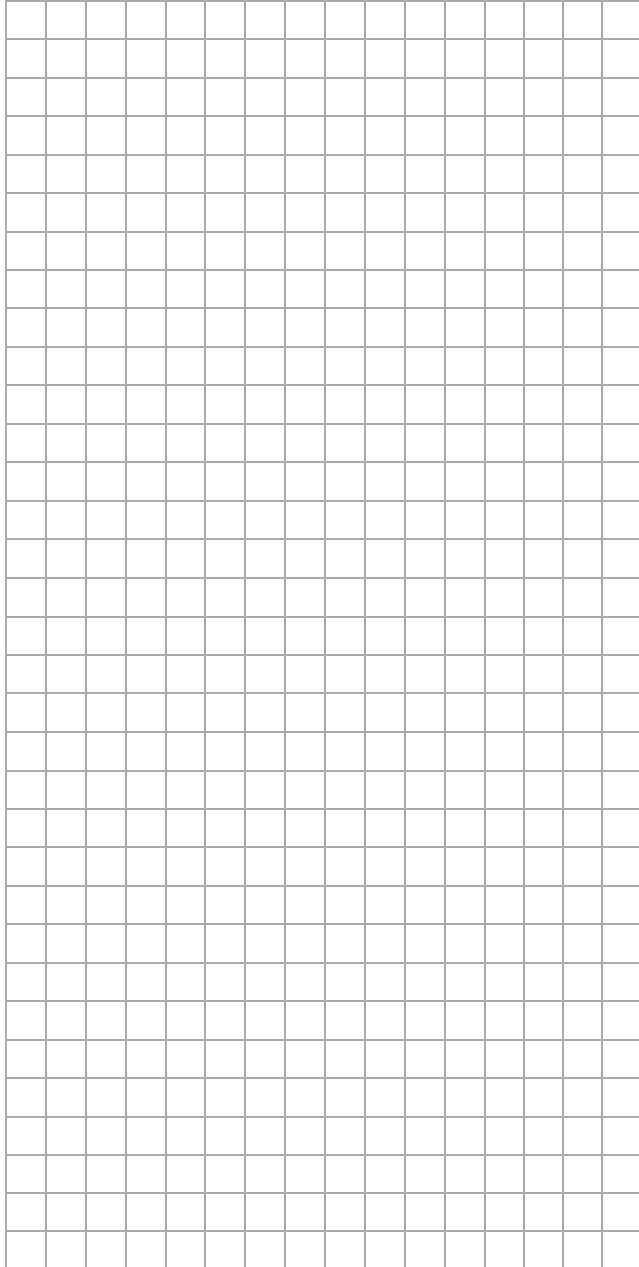



Tx. output swap

Swapping the outputs on the transmitter

Using the selection keys on the left or right touch pad, page to the menu option »Tx. output swap« Tx. output swap on the multi-function menu:

| | | |
|--------------------|--------------------|---|
| ↳ Phase trim | ↳ Non-delayed chan | ▲ |
| ⊞ Timers (general) | ⊞ Fl. phase timers | |
| ↳ Wing mixers | ↳ Free mixers | |
| ↳ MIX active/phase | ↳ MIX-only channel | |
| ↳ Dual mixer | △ Fail-safe adjust | |
| △ Teacher / pupil | △ Tx. output swap | ▼ |

| | | |
|--------------------|--------------------|---|
| ↳ Non-delayed chan | ⊞ Timers (general) | ▲ |
| ⊞ Fl. phase timers | ↳ Helicopter mixer | |
| ↳ Free mixers | ↳ MIX active/phase | |
| ↳ MIX-only channel | ↳ Dual mixer | |
| ↳ Swashplate mixer | △ Fail-safe adjust | |
| △ Teacher / pupil | △ Tx. output swap | ▼ |

Briefly tap the center **SET** key of the right touch pad to open this menu option.

Tx. output swap

To achieve maximum flexibility regarding receiver socket assignment, the **MC-20** HoTT program offers you the option of swapping servo outputs 1 to 16 as you please.

This option lets you distribute the transmitter's 16 "control channels" to any of the transmitter outputs 1 ... 16. If you do, you must remember that the »Servo display« screen – accessible from almost any menu option by simultaneously tapping the ◀ and ▶ keys on the left touch pad – refers exclusively to the "control channels" as preset by the receiver socket assignment: it therefore does NOT take any output swaps into account.

| TRANSFER OUTPUT | | | |
|-----------------|-----|---|----------|
| ▶ Servo | 1 | → | Output 1 |
| Servo | 2 | → | Output 2 |
| Servo | 3 | → | Output 3 |
| Servo | 4 | → | Output 4 |
| ▼ | SEL | | |

Use the ▲▼ selection keys on the left or right touch pad to select the channel/output combination to be changed then briefly tap the center **SET** key of the right touch pad. You can now use the right selection keys to assign your selected (control) channel to the desired output, confirming this with the **SET** key ...

| TRANSFER OUTPUT | | | |
|-----------------|-----|---|----------|
| ▶ Servo | 6 | → | Output 1 |
| Servo | 2 | → | Output 2 |
| Servo | 3 | → | Output 3 |
| Servo | 4 | → | Output 4 |
| ▼ | SEL | | |

... or, by tapping the ▲▼ or ◀▶ selection keys on the right touch pad at the same time (**CLEAR**), you can restore the original assignment.

Any subsequent changes, such as servo travel adjustments, Dual Rate / Expo, mixers etc., **must always be performed in accordance with the original receiver socket assignment!**

Example:

In the **MC-20** HoTT helicopter program, the outputs for a collective pitch servo and the throttle servo are swapped around, compared to some older **GRAUPNER/JR mc** units. The throttle servo now occupies transmitter output "6" and the collective pitch servo output "1". Perhaps, however, you wish to retain the previous configuration? In this case, you

will swap over channels 1 and 6 as appropriate, so that (control) channel 6 is located on output 1 and vice versa – as shown above:

Note:

"Channel Mapping" (channel assignment) is the receiver-side channel correlation function integrated into the **MC-20** HoTT transmitter's telemetry menu. With channel mapping, the transmitter's control channels (16 maximum) can be freely distributed to multiple receivers or receiver outputs having the same control function, for example to operate two servo controls per aileron surface instead of just being able to control one servo, etc. To keep controls manageable, however, we strongly recommend using only one of the options at a time.

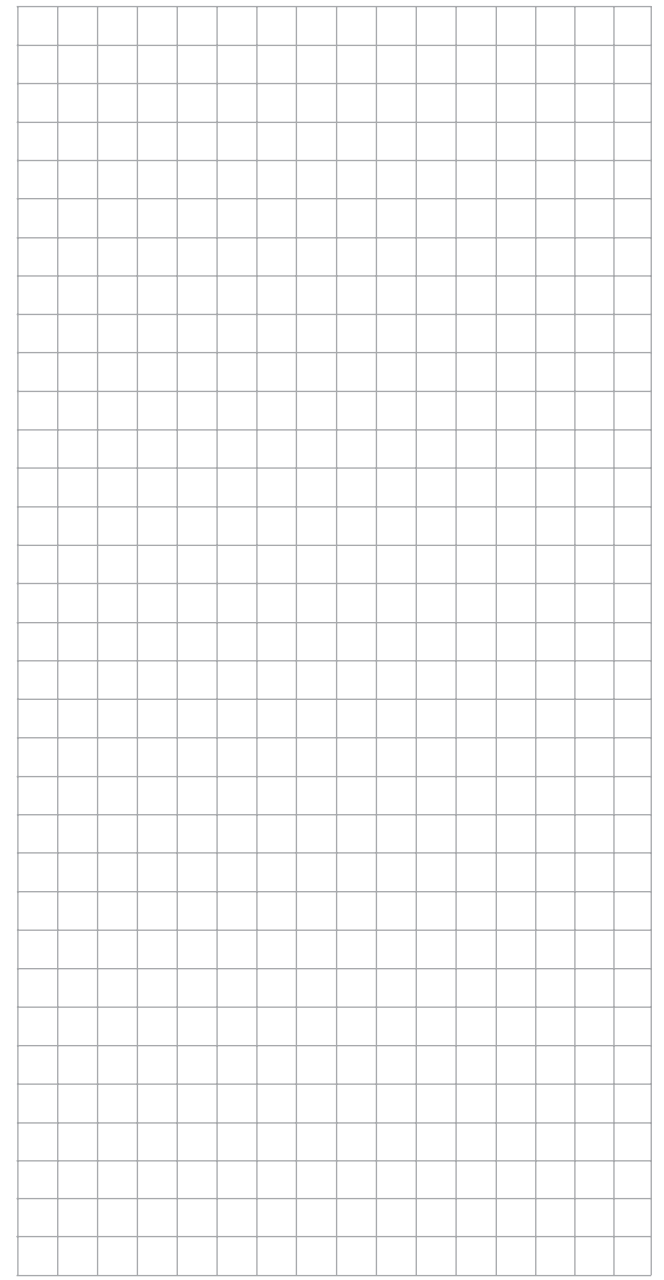
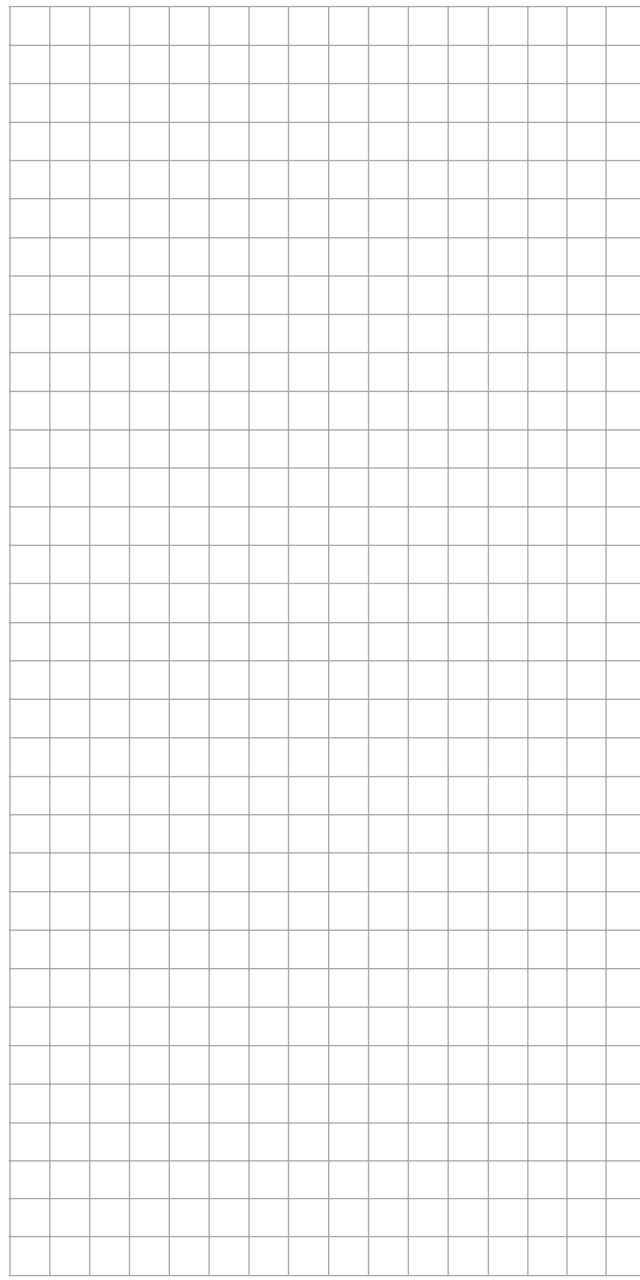
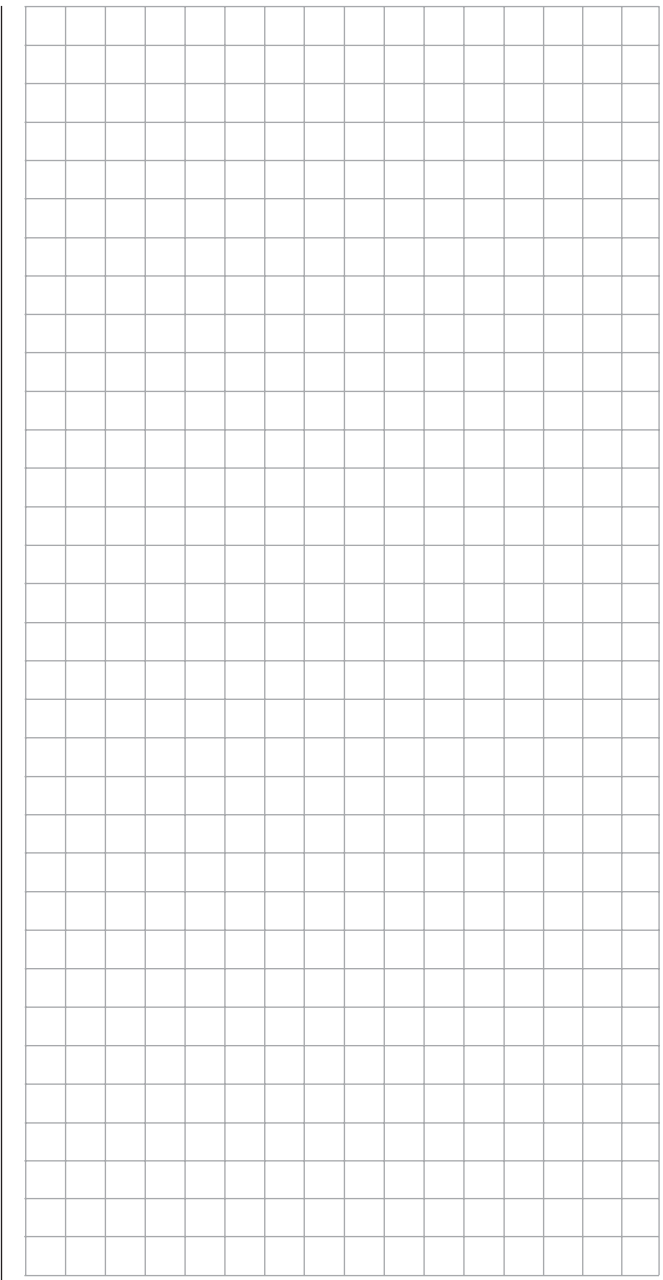

Profi-trim

Flaps and aileron trimming

The **MC-20** HoTT transmitter has an integrated software function for direct trimming of all flaps and ailerons.

Using the selection keys on the left or right touch pad, page to the »**Profi-trim**« menu option in the multi-function menu ...

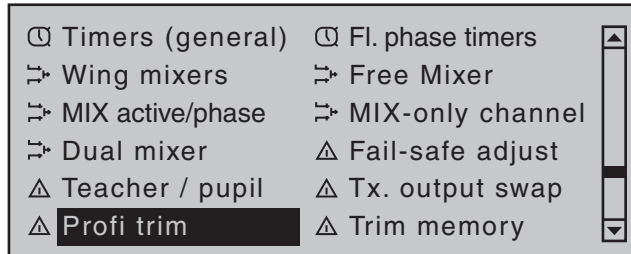

... then open this menu option with a brief tap on the center **SET** key of the right touch pad.

| P R O T R I M | | | | |
|---------------|--------|--------|--------|--------|
| | ▲ AI ▼ | ▲ AI ▲ | ▲ FL ▼ | ▲ FL ▲ |
| ▶ Trim | off | off | off | off |
| ctl sw | free | free | free | free |
| on/off | --- | | | |
| ▼ | SET | SET | SET | SET |

To set the desired option, move the marker frame onto the desired line or column with the selection keys of the left or right touch pad then briefly tap the center **SET** key of the right touch pad. Select the desired entry in the field now displayed in inverse video with the selection keys on the left or right touch pad or move the desired transmitter control. Conclude the procedure with a tap on the **ESC** key.

Programming is done in three steps.

First of all, in the "Trim" line it will be established just which flap pair is to be trimmed as "AI" and/or "FL". The "Control" line specifies the control channel over which the given trim function is to be performed and, finally, a switch is defined in the "ON/OFF" line by which this profi-trim function can be switched on or off globally.

Trim

Notes:

- Please note that, depending on the number of aileron and flap servos specified in the »**Model type**« menu (page 95), some settings cannot be used. For example, with only 1 aileron and/or 1 flap servo there is no aileron flap activation possible, and the opposite is also true. Since this is the case, a number of settings in various columns remain ineffective.
- Pay attention to potential double-assignments when making trim control choices.

The trim functions which can be activated (ON) or deactivated (OFF) on the first line of this menu, either individually or in any combination, make pre-flight corrections to aileron and flap settings quick and easy, without the complexity of having to call up individual setting options.

Individually, these are functions for ...

- Trim of the *aileron function* for aileron ("▲AI▼")

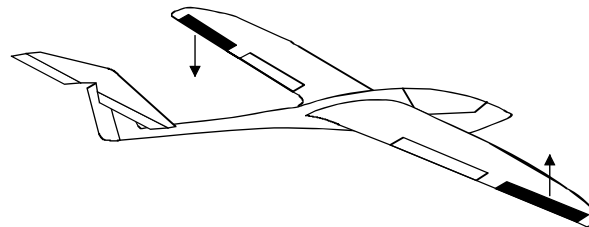

- Trim of the *flap function* for aileron ("▲AI▲▼")

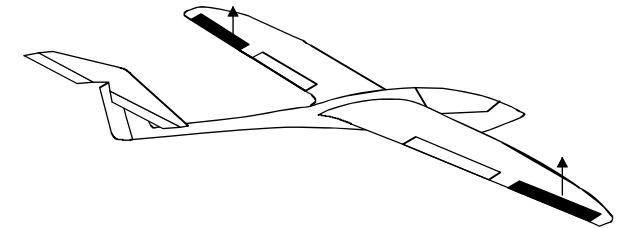

- Trim of the *aileron function* for flaps ("▲FL▼")

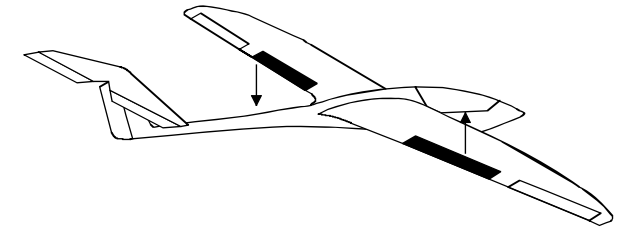

- Trim of the *flap function* for flaps ("▲FL▲")

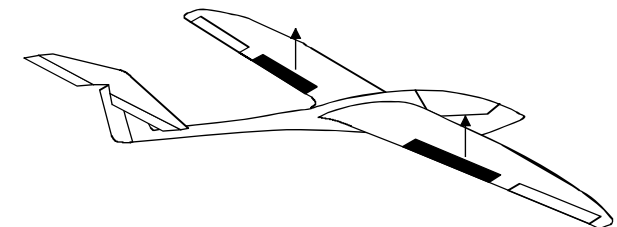

Tap on the ▲▼ or ◀▶ selection keys of the right touch pad at the same time (**CLEAR**) to reset the value of the field displayed in inverse video back to "OFF".

Note:

Regardless of a switch's ON/OFF setting (see further below), the reset of a value field in the "Trim" line has the effect an immediate return of the affected trim function to its original reference point.

Control

| P R O T R I M | | | | |
|---------------|--------|--------|--------|--------|
| | ▲ AI ▼ | ▲ AI ▲ | ▲ FL ▼ | ▲ FL ▲ |
| Trim | act | act | off | off |
| ▶ ctl sw | free | free | free | free |
| on/off | --- | | | |
| ▼ | SET | SET | SET | SET |

The second line of this menu is for selecting transmitter control assignments which appear advantageous from the many controls available on the transmitter.

To assign a transmitter control, use the selection keys to navigate to the desired column then tap briefly on the center **SET** key of the right touch pad ...:

| P R O T R I M | | | | |
|---------------|--------|--------|--------|--------|
| | ▲ AI ▼ | ▲ AI ▲ | ▲ FL ▼ | ▲ FL ▲ |
| Trim | act | act | off | off |
| ▶ ctl sw | Lever1 | free | free | free |
| on/off | --- | | | |
| ▼ ▲ | SET | SET | SET | SET |

... and move the desired transmitter control:

| P R O T R I M | | | | |
|---------------|--------|--------|--------|--------|
| | ▲ AI ▼ | ▲ AI ▲ | ▲ FL ▼ | ▲ FL ▲ |
| Trim | act | act | off | off |
| ▶ ctl sw | Tvr1 | Tvr2 | free | free |
| on/off | --- | | | |
| ▼ | SET | SET | SET | SET |

The mid-point position of enabled proportional controls corresponds to the programmed flap setting. The trim range for a given transmitter control is about $\pm 25\%$. However, these "trim" controls are

only effective when, as described in section "ON/OFF" further below, has been assigned to a profi-trim switch and switched on.

With trims switched on, make a test flight to determine the optimal setting then open the ON/OFF switch to secure the setting against inadvertent maladjustment. Now as long as the ON/OFF switch remains open or is erased, the located trim values will retain their settings.

An active transmitter control assignment can be erased with a simultaneous tap on the ▲▼ or ◀▶ selection keys of the right touch pad (**CLEAR**).

Note:

Trim values retain their settings until the next closure of the ON/OFF switch, even then when the trim functions in the "Control" line have been temporarily reset to "free".

ON/OFF

The "ON/OFF" line is used to assign a switch which permits the profi-trim function to be switched on/off globally. This assignment is done in the manner described in the section "Assigning transmitter controls, switches and control switches" on page 56. In this context, pay attention to the following dependencies:

- Only when the ON/OFF switch in the "Trim" line is set to "ON" will the trim functions assigned to trim controls in the "Transm. controls" line be able to affect trim within a range of $\pm 25\%$.
- As soon as the ON/OFF switch is opened or erased, the current trim positions will be stored and the selected trim controls become ineffective.

A tap, at the same time, on the ▲▼ or ◀▶ selection keys of the right touch pad (**CLEAR**) when a switch assignment is active will reset a field's value back to "---":

| P R O T R I M | | | | |
|---------------|--------|--------|--------|--------|
| | ▲ AI ▼ | ▲ AI ▲ | ▲ FL ▼ | ▲ FL ▲ |
| Trim | act | act | off | off |
| ctl sw | Tvr1 | Tvr2 | free | free |
| ▶ on/off | --- | | | |
| ▼ | SET | SET | SET | SET |

Pitch, throttle, tail-rotor, and C1 curve trimming

The **mc-20** HoTT transmitter's software has an integrated function for additional trimming of 8-point curves; in Heli programs »**Channel 1 curve**« page 131, and »**Helicopter mixer**« page 176. These are intended for "Pitch" curves "Channel 1 → Throttle" and "Channel 1 → Tail. rot.".

This feature, named »**Profitrimm**« because of its functional similarity to the Profi-Trim module for the **mc-24** but only available on that transmitter as a retrofit option. Select this feature from the multi-function menu with the selection keys of the left or right touch pad ...

| | | |
|---------------------|--------------------|---|
| ⊞ Fl. phase timers | ⇨ Helicopter mixer | ▲ |
| ⇨ Free mixer | ⇨ MIX active/phase | |
| ⇨ MIX-only channel | ⇨ Dual mixer | |
| ⇨ Swashplate mixer | △ Fail-safe adjust | |
| △ Teacher / pupil | △ Tx. output swap | |
| △ Profi trim | △ Trim memory | ▼ |

... then open this menu option with a brief tap on the center **SET** key of the right touch pad.

| | | | |
|--------|-------|-------|-------|
| ▶ free | None | L | 1 |
| free | None | L | 1 |
| free | None | L | 1 |
| free | None | L | 1 |
| | Mixer | Point | Phase |
| ▼ | | | |

"Trim control" column

Note:

Pay attention to potential double-assignments when making trim control choices.

This menu's first line is for assigning those transmitter controls (from the many available on the transmitter)

which appear most advantageous for this purpose.

To assign a transmitter control, use the selection keys to navigate to the desired line then tap briefly on the center **SET** key of the right touch pad ...

| | | | |
|--------|---------------------------|-------|-------|
| ▶ free | None | L | 1 |
| free | Move desired control adj. | | 1 |
| free | None | L | 1 |
| | Mixer | Point | Phase |
| ▼ | | | |

... then move the desired transmitter control:

| | | | |
|----------|-------|-------|-------|
| ▶ Slide1 | None | L | 1 |
| free | None | L | 1 |
| free | None | L | 1 |
| free | None | L | 1 |
| | Mixer | Point | Phase |
| ▼ | | | |

Erase trim control

Select the transmitter control assignment in the appropriate line as already described, e.g.:

| | | | |
|----------|---------------------------|-------|-------|
| ▶ Slide1 | None | L | 1 |
| free | Move desired control adj. | | 1 |
| free | None | L | 1 |
| | Mixer | Point | Phase |
| ▼ | | | |

A tap, at the same time, on the ▲▼ or ◀▶ selection keys of the right touch pad (**CLEAR**) will now reset the field's value back to "free".

"Mixer" column

There are a total of four value fields in this column. For each of these fields a helicopter mixer can be selected, individually or in any combination, from a list.

To do this, use the selection keys on the left or right touch pad to change to the desired value field. Then briefly tap the center **SET** key of the right touch pad ...

| | | | |
|----------|-------|-------|-------|
| ▶ Slide1 | None | L | 1 |
| free | None | L | 1 |
| free | None | L | 1 |
| free | None | L | 1 |
| | Mixer | Point | Phase |
| ▼ | | | |

... and select the desired mixer with the selection keys of the left or right touch pad:

| | | | |
|----------|-------|-------|-------|
| ▶ Slide1 | Pitch | L | 1 |
| free | None | L | 1 |
| free | None | L | 1 |
| free | None | L | 1 |
| | Mixer | Point | Phase |
| ▼ | | | |

Another tap on the center **SET** key of the right touch pad or the **ESC** key of the left touch pad will conclude the entry. This procedure is the same for the other menus.

A tap, at the same time, on the ▲▼ or ◀▶ selection keys of the right touch pad (**CLEAR**) will reset a field displayed in inverse video back to "None".

"Point" column

The lines of the column "Mixer" were used to select one or mixers. Now, in the "Point" column, the reference points to be trimmed will be set.

To do this, use the selection keys on the left or right touch pad to move to the desired value field. Then briefly tap the center **SET** key of the right touch pad ...

| ▶ Slide1 | Pitch | L | 1 |
|----------|-------|-------|-------|
| free | None | L | 1 |
| free | None | L | 1 |
| free | None | L | 1 |
| | Mixer | Point | Phase |

If a undefined point is selected – in the basic version, only points "L" and "H" are set – the respective regulator will remain ineffective.

The point offset (in a maximum range of about $\pm 12\%$) for the selected mixer will simultaneously be displayed in the curve diagrams of the »**Helicopter mixer**« menu so that the offset can also be checked visually.

Phase

The rightmost column is used, if desired, to determine which programmed flight phase the given regulator is to be active. The number preceding flight phase names, in the example "1" (Normal)", are based on the phase numbers as found in the »**Phase assignment**« menu on page 148:

| ▶ Slide1 | Pitch | L | 1 |
|----------|-------|-------|-------|
| free | None | L | 1 |
| free | None | L | 1 |
| free | None | L | 1 |
| | Mixer | Point | Phase |

However, the current position of the regulator will be – contrary to the corresponding fixed-wing program – set to a new zero point when ...

- by a change of flight phase, individual or all trim controls become active or
- the given trim control is erased or
- meanwhile the function assigned in the "Mixer" column is to be changed.

In all of these cases, the current regulator position will be stored and automatically overridden, i.e. adopted into the curve characteristic, by the pre-programmed curve points specified by the »**Channel 1 curve**« and »**Helicopter mixer**« menus. In this manner it is possible to simultaneously optimize up to four arbitrary curve points during the flight.

The memory storage option described here is, for example, useful during the first test flights of a new model as this permits the "flown" flight corrections to be immediately recorded in the program.

However, in order to have a clearly defined reference point prior to the first time a store is done, it is important to put all regulators into their middle positions.

But always be careful that, after repeated stores, servo travel is not too severely restricted on one side. Check and correct the control linkage if necessary.

Sometimes, despite an optimal basic setting for the model, it becomes necessary to temporarily change reference points, for example, when the weather has changed and the motor requires a short-term

correction or even when the muffler gets a leak unexpectedly, etc. Of course, in all of these cases, the corrected settings should not be stored via the Profi trim option. Storage can be prevented by ensuring that the regulator is in its middle position before activation or deactivation.

Note:

*Yet another point, independent of this, can be regulated via the "Trim function" through use of the selection keys. This is described in detail along with the programming of 8-point curves in section »**Channel 1 curve**« on page 131.*

Trim memory

Storing the current trim position

Use the selection keys on the left or right touch pad to scroll to the menu option »Trim memory« menu option in the multi-function menu:

| | |
|--------------------|----------------------|
| ⊞ Timers (general) | ⊞ Fl. phase timers |
| ➤ Wing mixers | ➤ Free Mixer |
| ➤ MIX active/phase | ➤ MIX-only channel |
| ➤ Dual mixer | △ Fail-safe adjust |
| △ Teacher / pupil | △ Tx. output swap |
| △ Profi trim | △ Trim memory |

Briefly tap the center **SET** key of the right touch pad to open this menu option:

| TRIM MEMORY | | |
|-------------|-----------|-----|
| ▶ Channel 1 | 0% | 0% |
| Aileron | 0% | 0% |
| Elevator | 0% | 0% |
| Rudder | 0% | 0% |
| ▼ | Trim Pos. | SET |

This menu permits selective storage of the given current position for the four digital trim controls in order to return them afterward to their visual middle points. This makes the last stored trim positions in the respective middle positions of trim wheels for control functions 1 ... 4 available again following a model memory location change or after long flight pauses. This memory store process is effective on a *flight-phase specific basis* for the currently active model memory location and is *not* to be stored globally. Therefore, as soon as flight phases have been defined in the »Phase settings« and »Phase assignment« menus, the given active flight phase will be displayed on the screen's bottom line. For example:

| TRIM MEMORY | | |
|-------------|-------------|---------------|
| ▶ Channel 1 | 0% | 0% |
| Aileron | 0% | 0% |
| Elevator | 0% | 0% |
| Rudder | 0% | 0% |
| ▼ | <<Normal >> | Trim Pos. SET |

Storing trim positions

The model has been flight tested and trimmed during the test flights. Current trim positions are now displayed in the column "Trim Pos." located approximately in the middle of the display. (The trim range is about ±30% of total control travel.) The right column displays trim memory content, currently filled uniformly with 0% because values have not yet been stored. Therefore, the display appears as follows:

| TRIM MEMORY | | |
|-------------|-------------|---------------|
| ▶ Channel 1 | 0% | 0% |
| Aileron | +5% | 0% |
| Elevator | +3% | 0% |
| Rudder | -7% | 0% |
| ▼ | <<Normal >> | Trim Pos. SET |

Now use the selection keys on the left or right touch pad to move to the line where a trim value is to be written into trim memory, e.g. the elevator trim value:

| TRIM MEMORY | | |
|-------------|-------------|---------------|
| Channel 1 | 0% | 0% |
| ▶ Aileron | +5% | 0% |
| Elevator | +3% | 0% |
| Rudder | -7% | 0% |
| ▼ | <<Normal >> | Trim Pos. SET |

Now, with a brief tap on the center **SET** key of the right touch pad, activate the **SET column's selected value field**. The message "Please press trim"

| TRIM MEMORY | | |
|-------------|-------------|---------------|
| Channel 1 | 0% | 0% |
| Aileron | Please | 0% |
| ▶ Elevator | press trim | 0% |
| Rudder | -7% | 0% |
| ▼ | <<Normal >> | Trim Pos. SET |

will then appear briefly in the display.

| TRIM MEMORY | | |
|-------------|-------------|---------------|
| Channel 1 | 0% | 0% |
| Aileron | +5% | 0% |
| ▶ Elevator | +3% | 0% |
| Rudder | -7% | 0% |
| ▼ | <<Normal >> | Trim Pos. SET |

Now briefly press the trim wheel for the elevator's joystick to accept the trim value.

| TRIM MEMORY | | |
|-------------|-------------|---------------|
| Channel 1 | 0% | 0% |
| Aileron | +5% | 0% |
| ▶ Elevator | 0% | +3% |
| Rudder | -7% | 0% |
| ▼ | <<Normal >> | Trim Pos. SET |

Another brief tap on the center **SET** key of the right touch pad or the center **ESC** key of the left touch pad will finish the procedure.

Now, if desired, change the flight phase and repeat the procedure. Perform the same procedure for the other control functions, as necessary.

Erasing stored trim positions

Use the selection keys on the left or right touch pad to move to the line where a trim value is to be erased from trim memory, e.g.:

| TRIM MEMORY | | |
|----------------|-----------|-----|
| Channel 1 | 0% | 0% |
| Aileron | +5% | 0% |
| ▶ Elevator | 0% | +3% |
| Rudder | -7% | 0% |
| ▼▲ <<Normal >> | Trim Pos. | SET |

Now briefly tap on the center **SET** key of the right touch pad to activate the value field.

| TRIM MEMORY | | |
|----------------|----------------------|-----|
| Channel 1 | 0% | 0% |
| Aileron | Please press trim | 0% |
| ▶ Elevator | | +3% |
| Rudder | -7% | 0% |
| ▼▲ <<Normal >> | Trim Pos. | SET |

As previously described, the message "Please press trim" will appear briefly. After this message has disappeared, simultaneously tap on the ▲▼ or ◀▶ selection keys of the right touch pad (**CLEAR**) to reset the value field again back to "0%".

However, if you do not erase a trim memory before storing a new value, the new value will be added to the stored value. Although this is an "elegant" way to effectively offset servo throw beyond the normal trim range of about ±30%, do keep in mind that excessive offsets for servo travel can lead to anomalies including one-sided restriction. It is then prudent to check control linkages and make corrections as necessary.

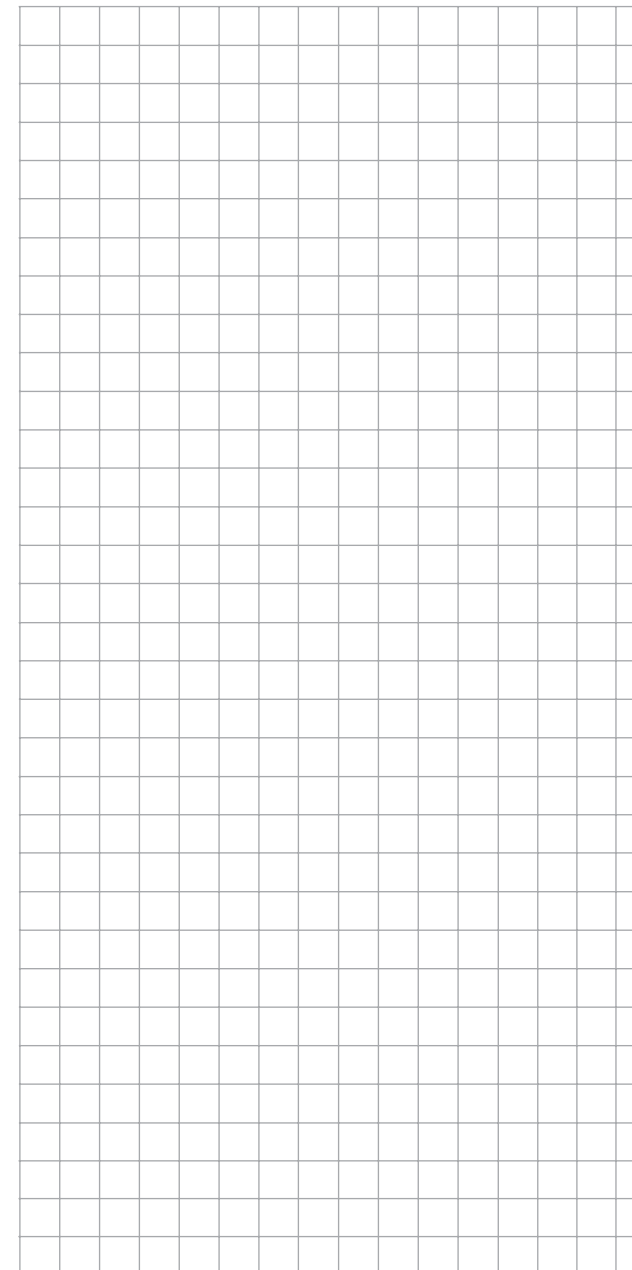
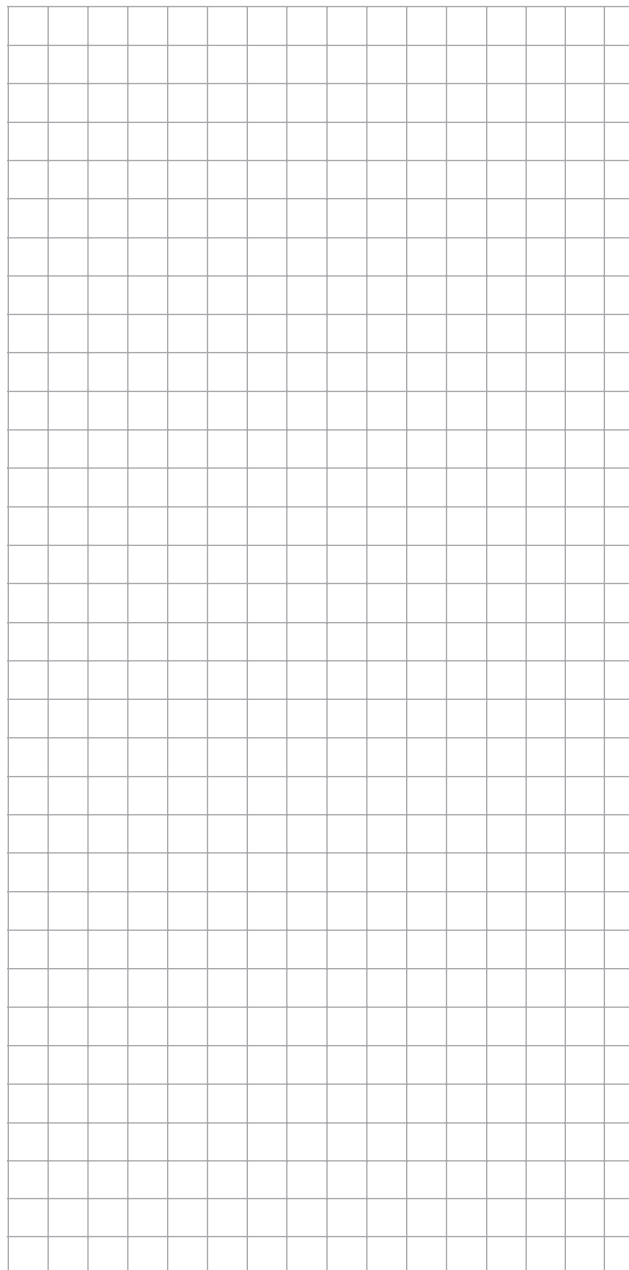

Trim memory

Storing the current trim position

Use the selection keys on the left or right touch pad to scroll to the menu option »**Trim memory**« menu option in the multi-function menu:

| | | |
|--------------------|----------------------|---|
| ⊖ Fl. phase timers | ⇒ Helicopter mixer | ▲ |
| ⇒ Free mixer | ⇒ MIX active/phase | |
| ⇒ MIX-only channel | ⇒ Dual mixer | |
| ⇒ Swashplate mixer | △ Fail-safe adjust | |
| △ Teacher / pupil | △ Tx. output swap | |
| △ Profi trim | △ Trim memory | ▼ |

Briefly tap the center **SET** key of the right touch pad to open this menu option:

| TRIM MEMORY | | |
|-------------|-----------|-----|
| ▶ Pitch/thr | 0% | 0% |
| Roll | 0% | 0% |
| Pitch ax. | 0% | 0% |
| Tail rot. | 0% | 0% |
| ▼ | Trim Pos. | SET |

This menu permits selective storage of the given current position for the four digital trim controls in order to return them afterward to their visual middle points. This makes the last stored trim positions in the respective middle positions of trim wheels for control functions 1 ... 4 available again following a model memory location change or after long flight pauses. This memory store process is effective on a *flight-phase specific basis* for the currently active model memory location and is *not* to be stored globally. Therefore, as soon as flight phases have been defined in the »**Phase settings**« and »**Phase assignment**« menus, the given active flight phase will be displayed on the screen's bottom line. For example:

| TRIM MEMORY | | |
|-------------|-------------|---------------|
| ▶ Pitch/thr | 0% | 0% |
| Roll | 0% | 0% |
| Roll ax. | 0% | 0% |
| Tail rot. | 0% | 0% |
| ▼ | <<Normal >> | Trim Pos. SET |

Storing trim positions

The model has been flight tested and trimmed during the test flights. Current trim positions are now displayed in the column "Trim Pos." located approximately in the middle of the display. (The trim range is about ±30% of total control travel.) The right column displays trim memory content, currently filled uniformly with 0% because values have not yet been stored. Therefore, the display appears as follows:

| TRIM MEMORY | | |
|-------------|-------------|---------------|
| ▶ Pitch/thr | 0% | 0% |
| Roll | +5% | 0% |
| Roll ax. | +3% | 0% |
| Tail rot. | -7% | 0% |
| ▼ | <<Normal >> | Trim Pos. SET |

Now use the selection keys on the left or right touch pad to move to the line whose trim value is to be written into trim memory, e.g. the pitch-axis trim value:

| TRIM MEMORY | | |
|-------------|-------------|---------------|
| Pitch/thr | 0% | 0% |
| Roll | +5% | 0% |
| ▶ Roll ax. | +3% | 0% |
| Tail rot. | -7% | 0% |
| ▼ | <<Normal >> | Trim Pos. SET |

Now, with a brief tap on the center **SET** key of the right touch pad, activate the **SET column's selected value field**. The message "Please press trim"

| TRIM MEMORY | | |
|-------------|-------------|---------------|
| Pitch/thr | 0% | 0% |
| Roll | Please | 0% |
| ▶ Roll ax. | press trim | 0% |
| Tail rot. | -7% | 0% |
| ▼ ▲ | <<Normal >> | Trim Pos. SET |

will then appear briefly in the display.

| TRIM MEMORY | | |
|-------------|-------------|---------------|
| Pitch/thr | 0% | 0% |
| Roll | +5% | 0% |
| ▶ Roll ax. | +3% | 0% |
| Tail rot. | -7% | 0% |
| ▼ | <<Normal >> | Trim Pos. SET |

Now briefly press the trim wheel for the elevator's joystick to accept the trim value.

| TRIM MEMORY | | |
|---------------|-----------|-----|
| Pitch/thr | 0% | 0% |
| Roll | +5% | 0% |
| ▶ Roll ax. | 0% | +3% |
| Tail rot. | -7% | 0% |
| ▼ <<Normal >> | Trim Pos. | SET |

Another brief tap on the center **SET** key of the right touch pad or the center **ESC** key of the left touch pad will finish the procedure.

Now, if desired, change the flight phase and repeat the procedure. Perform the same procedure for the other control functions, as necessary.

Erasing stored trim positions

Use the selection keys on the left or right touch pad to move to the line where a trim value is to be erased from trim memory, e.g.:

| TRIM MEMORY | | |
|---------------|-----------|-----|
| Pitch/thr | 0% | 0% |
| Roll | +5% | 0% |
| ▶ Roll ax. | 0% | +3% |
| Tail rot. | -7% | 0% |
| ▼ <<Normal >> | Trim Pos. | SET |

Now briefly tap on the center **SET** key of the right touch pad to activate the value field.

| TRIM MEMORY | | |
|-----------------|------------|-----|
| Channel 1 | 0% | 0% |
| Aileron | Please | 0% |
| ▶ Elevator | press trim | +3% |
| Rudder | -7% | 0% |
| ▼ ▲ <<Normal >> | Trim Pos. | SET |

As previously described, the message "Please

press trim" will appear briefly. After his message has disappeared, simultaneously tap on the ▲▼ or ◀▶ selection keys of the right touch pad (**CLEAR**) to reset the value field again back to "0%".

However, if you do not erase a trim memory before storing a new value, the new value will be added to the stored value. Although this an "elegant" way to effectively offset servo throw beyond the normal trim range of about $\pm 30\%$, do keep in mind that excessive offsets for servo travel can lead to anomalies including one-sided restriction. It is then prudent to check control linkages and make corrections as necessary.

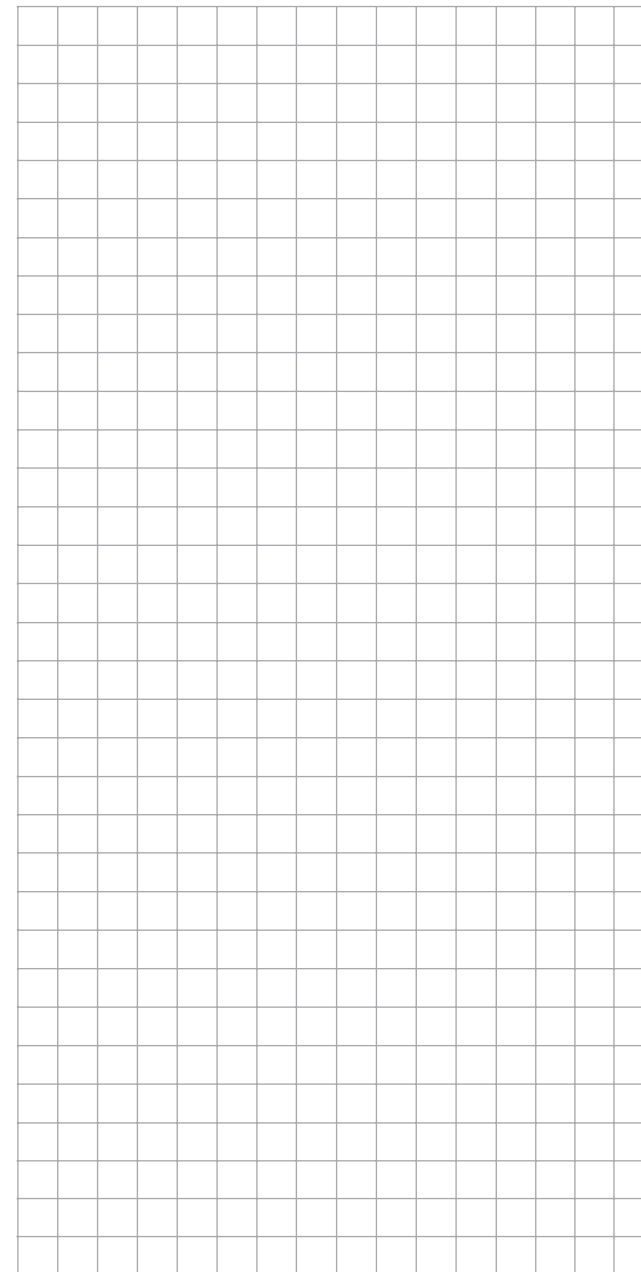

Read-in and settings for telemetry data

The receiver's settings, as well as optional telemetry sensor settings, can be called up and programmed in real-time by way of the »**Telemetry**« menu. Communication with the transmitter is accomplished over the return channel built into the HoTT receiver.

As many as four sensors can be attached, if necessary via V or Y adapter cables, to receivers with current firmware of types: GR-12S HoTT (order no. **33505**), GR-12 HoTT (order no. **33506**), GR-16 (order no. **33508**), GR-24 HoTT (order no. **33512**) and GR-32 DUAL (order no. **33516**).

The update capability of these and future receivers, which can be performed by the user, will keep the respective »**Telemetry**« menu up to date with the latest version and ensure enhancement with future functions or languages.

Note:

After registering your product at <https://www.graupner.de/de/service/produktregistrierung> you are automatically informed of new updates.

Important notices:

- This manual is based on the functions available at the time of printing.
- As already indicated in the section "Binding multiple receivers" on page 77 and 85, multiple receivers per model can be bound into the system as necessary. **However, only the receiver selected in the line "TELEMETRY RCV" of the "Telemetry" menu is able to establish a telemetry connection to the transmitter!** However, that also means the inverse, that only this receiver can be addressed through the Telemetry menu! If necessary, therefore, the selection must be changed before settings can be made on a specific receiver:

| TELEMETRY | |
|--------------------|---------|
| ▶ TELEMETRY RCV | BIND. 1 |
| SETTING & DATAVIEW | |
| SENSOR SELECT | |
| RF STATUS VIEW | |
| VOICE TRIGGER | |

- **When adjusting the settings of the remote control, make absolutely sure that the transmitter antenna is always far enough away from the receiver antennae! To be on the safe side, keep them at least one meter apart. Otherwise there is a risk of a faulty connection to the return channel and malfunctions will result.**
- Since the telemetric data between transmitter and receiver is only exchanged after the fourth data package, the data transmission requires a certain amount of time for technical reasons, so the reaction to the operating keys and changes to settings take place with a delay. Therefore, the delay is not due to an error.
- Programming on the model or on sensors may only take place if the model is on the ground. Only carry out the settings with the motor switched off and the battery disconnected! Otherwise, undesired programming cannot be ruled out. For example, a servo test initiated accidentally could cause the model to crash and cause personal injury and/or property damage. Observe the safety instructions on pages 4 ... 7 of this manual and the respective separate manuals.
- All settings (such as fail-safe, servo direction reversal, servo travel, mixer and curve settings, etc.) made through the »**Telemetry**« menu are stored only in the receiver and therefore are adopted along with it if it is implemented as a

receiver in another model. Therefore, to be on the safe side, re-initialize your HoTT receiver if you want to use the receiver in a different model; see "Reset" on page 46.

- Only program the servo direction reversal, servo travel, mixer and curve settings through the **MLC-20**-specific standard menus »**Servo adjustment**« page 102, »**Dual Rate / Expo**« page 120 or page 124, »**Channel 1 curve**« page 128 or 131, and so on. Otherwise, the settings superimpose one another, which can lead to complexity or even problems in the later operation.
- The channel assignment function, called "Channel mapping", integrated into the »**Telemetry**« menu of the **MLC-20** HoTT transmitter can also freely distribute control functions over multiple receivers or even distribute a single control function over multiple receiver outputs, such as two servos per aileron instead of only one individual servo, etc. **We also recommend exercising extreme during the programming.**

SETTINGS/DISPLAYS

Telemetry

The menu gathered under the heading »**Telemetry**« can be called up from the **MC-20** HoTT transmitter's basic display with a tap of about one second duration on the center **ESC** key of the left touch pad. The same menus can, like other transmitter menus, also be opened in the multifunction menu with a tap on the center **SET** key of the right touch pad:

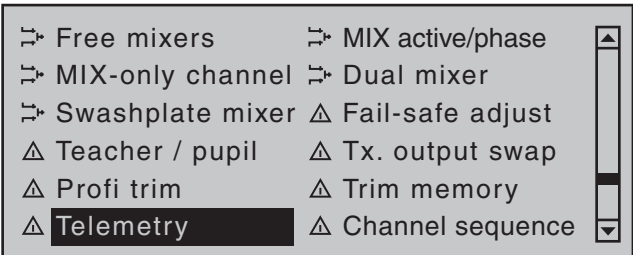
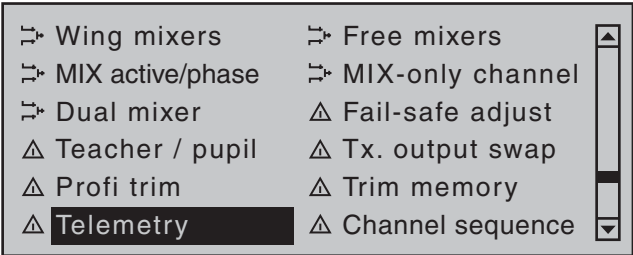

Basic operation

Operating the »**Telemetry**« menu is essentially the same as for the remaining **MC-20** HoTT transmitter menus. The few differences are described in the following:

The ◀ ▶ selection keys of the left or right touch pad can be used to switch between individual pages of the Telemetry menu. Corresponding directional indicators can be found at top right of each display page in the form of angled brackets (< >), refer to the figures below. If only one angled bracket is visible, you are on either the first or last respective page. In this case, changing pages is only possible in the

indicated direction.

Menu lines in which parameters can be changed are identified with the aforementioned angled bracket (>). The ">" pointer will jump a line forward or back with a tap on the ▲ ▼ selection keys of the left or right touch pad. Lines to which a jump cannot be made are unalterable.

In order to change a parameter, briefly touch the center **SET** key of the right touch pad (the parameter will be displayed in inverse video), change the value within the permissible adjustment range via the selection keys of the *right* touch pad and adopt the value with another tap on the **SET** key. A brief tap on the center **ESC** key of the left 4-way pad will cause a return to the starting position again.

Now use the ▲ ▼ selection keys of the left or right touch pad to pick the desired sub-menu. However, if the message ...



... appears instead of the desired sub-menu after touching the center **SET** key of the right touch pad then no connection has been established with a receiver. Therefore, switch on your receiver system or, if applicable reconnect the addressed receiver as described on page 77 or 85 or activate it as described under "Important Notices" on the previous page.

On the first display page of the sub-menu overwritten with ...

RX DATAVIEW

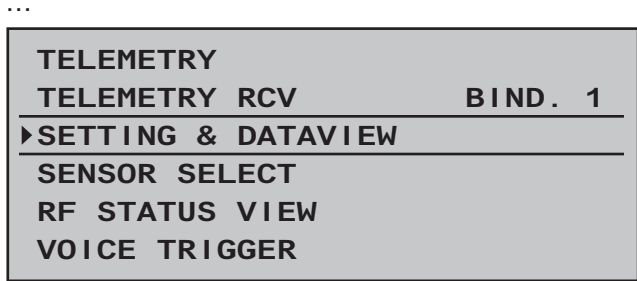

... no settings can be made. This page is only provided for information:

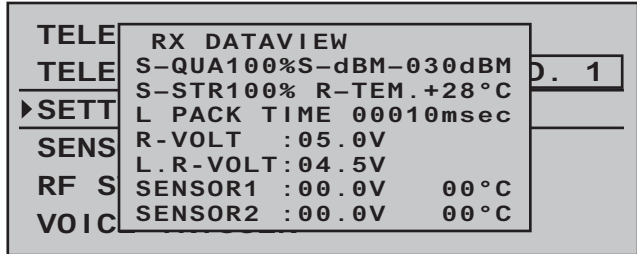

| Value | Explanation |
|-------------|---|
| S-QUA | signal quality in % |
| S-dBm | Reception power in dBm |
| S-STR | signal strength in % |
| R-TEM. | Receiver temperature in °C |
| L PACK TIME | Indicates the time in ms in which the longest data package is lost during the transmission from the transmitter to the receiver |
| R-VOLT | Current operating voltage of the receiver in volts |

| | |
|----------|--|
| L.R-VOLT | Lowest operating voltage of the receiver since it was last turned on, in volts |
| SENSOR1 | Indicates values of optional telemetric sensor 1, in volts and °C |
| SENSOR2 | Indicates values of optional telemetric sensor 2, in volts and °C |

Signal quality (S-QUA)

The signal quality (S-QUA) is sent "live" over the receiver's return channel to the transmitter and indicates the signal strength in %.

Reception power (S-dbm)

Reception power (S-dbm) is indicated with negative values, which means a value of zero is the maximum value (= best reception) and the lower the values are, the poorer the reception power! The range test before operation, among other things, is important for this.

Note:

With negative numbers the evaluation of a number is reversed: The higher the number following the minus symbol, the lower the value is. Therefore, a reception power of -80 dBm, for example, is poorer than one of -70 dBm.

Perform the range test as described on page 80 and 88 before each flight and, in doing so, simulate all servo movements which also take place during the flight. The range must be at least 50 m on the ground with the range test activated. At this distance, the value shown under "S-dBm" in the "RX DATAVIEW" display may not be greater than -80 dBm in order to guarantee safe operation. The model should never be operated with a lower value (e.g. -85 dBm). Check the installation of the receiver system and the position of the antenna.

The reception power should not drop below -90 dBm during operation. Otherwise, reduce the distance of the

model. Normally, however, the acoustic range warning (peep tone interval 1 s) is triggered before this value is reached in order to guarantee safe operation.

Signal strength (S-STR)

The signal strength (S-STR) is displayed in %. In general, an acoustic range warning (peep tone interval 1 s) is issued as soon as the receiver signal becomes too weak in the return channel. However, since the transmitter has a significantly higher transmission power than the receiver, the model can still be safely operated. For the sake of safety, the distance to the model should be reduced until the warning tone goes silent again.

Receiver temperature (R-TEM.)

Make sure the receiver remains within the permissible temperature range during all flight conditions (ideally between -10 and 55 °C).

The receiver temperature limit, at which a warning is issued, can be adjusted in the sub-menu »RX SERVO TEST« under "ALARM TEMP+" (50 ... 80 °C and "ALARM TEMP-" (-20 ... +10 °C). When the value is under-run or over-run, an acoustic signal sounds (continuous peep tone) and "TEMPE" will appear at the top right of all "RX" receiver sub-menus. Additionally, the parameter "R-TEM" will be displayed in inverse video on the »RX DATAVIEW« display page.

Data packages (L PACK TIME)

Indicates the longest time span in ms in which data packages are lost in the transmission from the transmitter to the receiver. In practice, that is the longest time span in which the remote control system has entered into fail-safe mode.

Receiver operating voltage (R-VOLT)

Always check the operating voltage of the receiver. Never operate or even start your model if the

operating voltage is too low.

The receiver low voltage warning can be adjusted between 3.0 and 6.0 volts in "ALARM VOLT" of the »RX SERVO TEST« sub-menu. If this range is under-run, an acoustic signal is sounded (repetitive double peep tone (long/short)) and "VOLT.E" will appear at the top right of all »RX ...« receiver sub-menus. In addition, the parameter "R-VOLT" will be displayed in inverse video in the »RX DATAVIEW« sub-menu.

The current receiver battery voltage is also displayed in the default display, see page 28.

Minimum receiver operating voltage (L.R-VOLT)

"L.R-VOLT" indicates the minimum operating voltage of the receiver since the last time it was switched on. If this voltage should deviate significantly from the current "R-VOLT" operating voltage, the receiver battery may be too heavily encumbered by the servos. The consequence is voltage drops. In this case, use a more powerful voltage supply in order to achieve maximum operational safety.

Sensor 1 + 2

Indicates the values of optional telemetric sensors 1 and 2, if present, in volts and °C. A description of these sensors can be found in the appendix.

RX SERVO

| | | | |
|-------|-------------------|----|------|
| TELE | RX SERVO | <> | |
| TELE | > OUTPUT CH : 01 | | D. 1 |
| ▶SETT | REVERSE : OFF | | |
| SENS | CENTER : 1500µsec | | |
| RF S | TRIM : -000µsec | | |
| VOIC | LIMIT- : 150% | | |
| | LIMIT+ : 150% | | |
| | PERIOD : 20msec | | |

It is very important that you read the notices on page 228 before doing any programming on this display

page.

| Value | Explanation | Possible settings |
|-----------|---|--|
| OUTPUT CH | Channel selection | 1 ... depending on receiver |
| REVERSE | Servo reversal | OFF / ON |
| CENTER | Servo center in μs | if active (inverse), dependent on control position |
| TRIM | Trim position in μs deviating from the CENTER position | -120 ... +120 μs |
| LIMIT- | Travel limit on the "-" side of servo travel in % servo travel | 30 ... 150 % |
| LIMIT+ | Travel limit on the "+" side of servo travel in % servo travel | 30 ... 150 % |
| PERIOD | Cycle time in ms | 10 or 20 ms |

OUTPUT CH (channel selection)

If applicable, select the line "OUTPUT CH" with the selection keys. Touch the **SET** key of the right touch pad. The value field is shown highlighted. Now set the desired channel (e.g. 01) with the selection keys on the right touch pad. **The following parameters are always based on the channel set here.**

Reverse (servo reversal)

Set the rotational direction of the servo connected to the selected servo channel: ON / OFF

CENTER (servo center)

The *active* value field (inverse video) in the "CENTER" line shows the current impulse time in μs for the control channel selected in the "OUTPUT CH" line. The displayed value depends on the current position of the control influencing this control channel and, if

applicable, the position of its trimming.

A channel impulse time of 1500 μs corresponds to the standard center position and thus the conventional servo center.

In order to change this value, select the "CENTER" line then touch the **SET** key. Now move the respective transmitter control, joystick and/or trim wheel to the desired position and store the current control's position with another tap on the **SET** key. This position is saved as the new neutral position.

TRIM (trim position)

In the "TRIM" line" you can carry out the fine adjustment of the neutral position of a servo connected to the control channel selected in the "OUTPUT CH" line using the selection keys of the right touch pad in 1 μs increments. The value in the "CENTER" line can be adjusted by the TRIM value set here in a range of $\pm 120 \mu\text{s}$.

Factory setting: 0 μs .

LIMIT-/+ (side dependent travel limit -/+)

This option is provided for the adjustment of a side-dependent limit (limiting) of the servo travel (rudder throw) of the servo connected to the control channel selected in the "OUTPUT CH" line.

The settings for both directions are separate but both are in a range of 30 ... 150%.

Factory setting: 150% each.

PERIOD (cycle time)

In this line you determine the time interval of the individual channel impulse. This setting is adopted for all control channels.

With the use of only digital servos, a cycle time of 10 ms can be set..

In mixed operation or with use of only analog servos, 20 ms should absolutely be set, because the latter can otherwise be "over-strained" and react with "shaking" or "quivering" as a result.

RX FAIL SAFE

| | | | |
|-------|-----------------------------------|----|------|
| TELE | RX FAIL SAFE | <> | D. 1 |
| TELE | >OUTPUT CH: 01 | | |
| | INPUT CH: 01 | | |
| ▶SETT | MODE : HOLD | | |
| SENS | F. S. POS. : 1500 μsec | | |
| RF S | DELAY : 0.75sec | | |
| VOIC | FAIL SAFE ALL: NO | | |
| | POSITION : 1500 μsec | | |

The description of this menu necessitates a few words of warning in advance:

"Do nothing" is the absolute worst thing to be done in this regard. "HOLD" is prescribed in the base setup model of the HoTT receiver.

In the event of a failure, in the best case scenario the model flies straight ahead for an indefinite amount of time and then hopefully "lands" somewhere without causing significant damage! However, if something like this happens in the wrong place at the wrong time, the model may become uncontrollable and "tear" across the flight field completely out of control, putting the pilot and spectators at risk.

Therefore, it would obviously be beneficial to program the the function "Motor off" at the very least, in order to prevent such risks. If necessary, seek the advice of an experienced pilot in order to fine a "logical" setting for your model.

And then another brief notice regarding the three possible versions of the **FLC-20** HoTT transmitter for the setting of Fail Safe:

The easiest, and recommended, way to fail-safe settings is the use of the »**Fail Safe**« menu, which can be reached from the multifunction menu, see page 208.

Similarly, in order to achieve the same result somewhat more laboriously, the "FAIL SAFE ALL" option described on the following pages is also available.

In addition, there are the relatively elaborate methods of the of the individual adjustment using the options "MODE", "F.S.Pos." and "DELAY". The description of these variants begins with the "MODE" option further below.

| Value | Explanation | Possible settings |
|---------------|--|---------------------------------|
| OUTPUT CH | Output channel (servo connection of the receiver) | 1 ... depending on receiver |
| INPUT CH | Input channel (channel coming from the transmitter) | 1 ... 16% |
| MODE | Fail-Safe mode | HOLD FAIL SAFE OFF |
| F.S.POS. | Fail-safe position | 1000 ... 2000 µs |
| DELAY | Reaction time (delay) | 0.25, 0.50, 0.75 and 1.00 s |
| FAIL SAFE ALL | Save of the Fail-safe Positions of all control channels | NO / SAVE |
| POSITION | Display of the saved Fail-safe position | Between approx 1000 and 2000 µs |

OUTPUT CH (servo connection)

In this line you select the respective OUTPUT CH (servo connection of the receiver) to be set.

INPUT CH (selection of the input channel)

As already mentioned on page 228, the 16 control functions of the **MC-20** HoTT transmitter can be arbitrarily distributed to multiple receivers, if necessary, or even assigned to multiple receiver

outputs with the same control function. For example, this might be used in order to be able to control two servos for each aileron flap or an oversize rudder with linked servos instead of an individual servo. Distribution to multiple HoTT receivers, in turn, offers the advantage of not having to use a long servo cable, e.g. for large models. In this case, bear in mind that only the receiver selected in the line "TEL. EMPF." through the »**Telemetry**« menu can be addressed!

The 16 control channels (INPUT CH) of the **MC-20** HoTT can be appropriately managed through so-called "Channel Mapping" (channel assignment) whereby a different control channel is assigned to the servo connection selected in the OUTPUT CH line for the receiver in the INPUT CH line. BUT CAUTION: If, for example, "2AIL" is specified in the transmitter on the "Aileron/camber flaps" line of the »**Base setup, model**« menu then *control function 2 (Aileron)* will already be assigned in the transmitter to *control channels 2 and 5 for distribution to the left and right ailerons*. The receiver's corresponding *INPUT CH*, which must also be mapped, would be the channels 02 and 05 in this case; see the following example.

Examples:

- *You would like to control each aileron of a large model with two or more servos.*
- *You would like to control each aileron of a large model with two or more servos.*
Assign one of the two standard aileron control channels 2 or 5 as INPUT CH to the corresponding OUTPUT CH (servo connections) depending on the left or right bearing surface.
- *You would like to control the rudder of a large model with two or more servos.*
Assign the same INPUT CH (control channel) to the corresponding OUTPUT CH (servo connections). In this case, this is the standard

rudder channel 4.

MODE

The settings of the options "MODE", "F.S.Pos." and "DELAY" determine the behavior of the receiver in the event of a failure in the transmission from transmitter to receiver.

The setting programmed under "MODE" is *always* based on the channel set in the OUTPUT CH line.

The factory setting for all servos is "HOLD".

For each selected OUTPUT CH (servo connection of the receiver) you can choose between:

- **FAI(L) SAFE**
With this selection, in the event of a failure the corresponding servo moves to the position shown in the "POSITION" line for the remainder of the failure until the "Delay time" set in the "DELAY" line has lapsed.
- **HOLD**
With a setting of "HOLD", in the event of a failure the servo maintains the last correctly received servo position for the duration of the failure.
- **OFF**
With a setting of "OFF", in the event of a failure the receiver discontinues the retransmission of (temporarily stored) control impulses for the respective servo output for the duration of the failure. In other words, the receiver switches the impulse line "off".
BUT CAUTION: Analog servos and even some digital servos no longer put up any resistance against the previous control pressure during the failure of the control impulse and are more or less pushed out of their position as a result.

F.S.POS. (Fail-safe position)

For each OUTPUT CH (receiver servo connection), set the position the given servo should assume in "FAI(L) SAFE" mode, i.e. in the event of a failure, via

the "F.S.POS." line. This is done by first activating the value field (inverse representation) with a tap on the **SET** key of the right touch pad then using the selection keys of the right touch pad to choose the servo position. The adjustment takes place in 10- μ s increments.

Factory setting: 1500 μ s (servo center).

Important notice:

The function "F.S.POS." has an additional meaning in all three modes, "OFF", "HOLD" and "FAI(L) SAFE" in the event that the receiver is switched on, but (still) does not receive a valid signal.

The servo immediately travels to the fail-safe position predefined in the "Position" line. In doing so, the landing gear, for example, is prevented from retracting of the receiver is accidentally switched on while the transmitter is switched off. In normal model mode, on the other hand, the corresponding servo behaves in accordance with the set "MODE" in the event of a failure.

DELAY (fail-safe reaction time or delay)

Here you adjust the delay time after which the servos should move to their predetermined positions in the event of a signal interruption. This setting is adopted for all channels and only pertains to the servos programmed to the "FAIL SAFE" mode.

Factory setting: 0.75 s.

FAIL SAFE ALL (global fail-safe setting)

This sub-menu allows servo fail-safe positions to be established at the "push of a button" in a similar manner to that described on page 208 for the »Fail Safe« menu.

Switch to the "FAIL SAFE ALL" line and activate the value field by touching the center **SET** key of the right touch pad. "NO" will be displayed in inverse video. Then adjust the parameter to "SAVE" with one of the

selection keys of the right touch pad. Now, using the operating elements of the transmitter, move all servos to the desired fail-safe position you assigned or want to assign in the line "MODE" "FAI(L) SAFE". The current position of the control for the channel which was just set is shown in the bottom "Position" line:

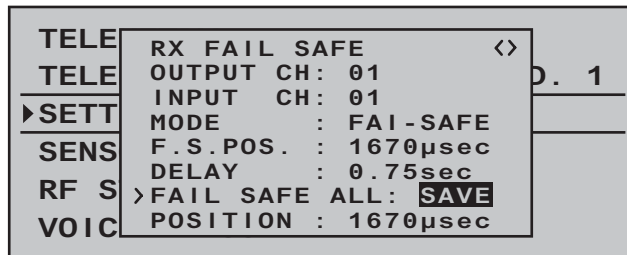

After a tap on the center **SET** key of the right touch pad, the display will change again, from "SAVE" to "NO". The saved the positions of all servos affected by this measure and adopted them in parallel to the line "F.S.Pos." and the display then immediately shows the following for the current OUTPUT CH (servo connection):

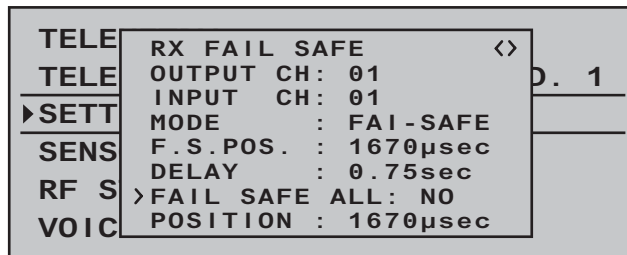

Switch off the transmitter and check the fail-safe positions based on the servo throws.

"Fail Safe" in combination with "Channel Mapping"

In order to ensure that the mapped servos—that is to say servos which are controlled from a common control channel (INPUT CH)—react the same way even in the event of a failure, *the corresponding*

settings of the INPUT CH determine the behavior of the mapped servos!!!

Therefore, the servo connections 6, 7 and 8 of a receiver are mapped with one another, whereby the OUTPUT CH (servo connections) 06, 07 and 08 are assigned as INPUT CH of the same respective control channel "04" ...

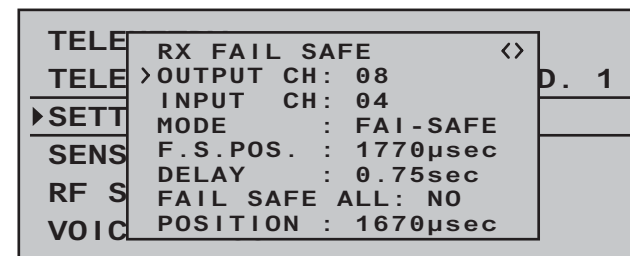
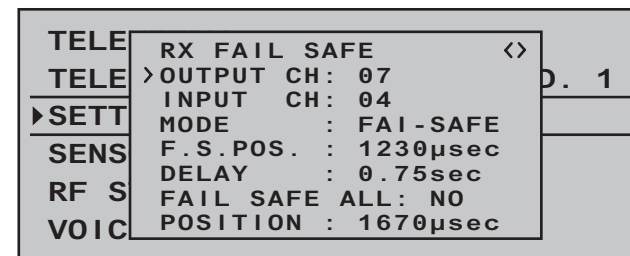
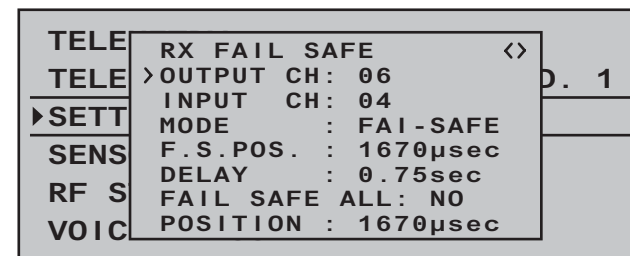

... the INPUT CH 04 determines the fail-safe behavior of these three servos connected to the control channel 4 completely independently of the individual settings of the respective OUTPUT CH:

```

TELE RX FAIL SAFE <>
TELE >OUTPUT CH: 04 D. 1
>SETT INPUT CH: 04
MODE : FAI-SAFE
SENS F.S.POS. : 1500µsec
RF S DELAY : 0.75sec
VOIC FAIL SAFE ALL: NO
POSITION : 1670µsec

```

This is also the case, for example, if this is mapped with INPUT CH 01:

```

TELE RX FAIL SAFE <>
TELE >OUTPUT CH: 04 D. 1
>SETT INPUT CH: 01
MODE : FAI-SAFE
SENS F.S.POS. : 1420µsec
RF S DELAY : 0.75sec
VOIC FAIL SAFE ALL: NO
POSITION : 1670µsec

```

In this case, the servo connection 04 would, in turn, react according to the fail-safe settings of CH 01.

The reaction or delay time set in the "DELAY" line, on the other hand, always applies uniformly for all channels set to "FAI(L) SAFE".

RX FREE MIXER

```

TELE RX FREE MIXER <>
TELE >MIXER : 1 D. 1
>SETT MASTER CH: 00
SLAVE CH : 00
SENS S-TRAVEL- : 100
S-TRAVEL+ : 100
RF S RX WING MIXER
VOIC TAIL TYPE: NORMAL

```

| Value | Explanation | Possible settings |
|-----------|---------------------------------|--------------------------------|
| MIXER | Mixer selection | 1 ... 5 |
| MASTER CH | Signal source or source channel | 0, 1 ... depending on receiver |

| Value | Explanation | Possible settings |
|-------------------------|----------------|---|
| SLAVE CH | Target channel | 0, 1 ... depending on receiver |
| S-TRAVEL- | Admix negative | 0 ... 100 % |
| S-TRAVEL+ | Admix positive | 0 ... 100 % |
| RX WING MIXER TAIL TYPE | tail type | NORMAL, V-TAIL (V-LW) ELEVON (vertical/horizontal mixer for delta and flying wing) |

MIXER

Up to three mixers can be programmed simultaneously. Use "MIXER" to switch between mixers 1 ... 5.

The following settings in this display *always* for just the mixer selected in the "MIXER" line.

Important notice:

If you have already programmed mixer functions in the »Wing mixer« or »Free mixer« Free mixer " menus, make absolutely sure that these mixers do not overlap with those in the menu "RX FREE MIXER"!

MASTER CH ("from")

According to the same principles described in the section "Free mixer" on page 192, the signal applied at the MASTER CH (signal source or source channel) is mixed to a variable extent to the SLAVE CH (target channel).

Select "00" if no mixer should be set.

SLAVE CH ("to")

The signal of the MASTER CH (source channel) is mixed proportionally to the SLAVE CH (target channel). The mix ratio will be determined by the percentages entered in the lines "TRAVEL-" and

"TRAVEL +".

Select "00" if no mixer should be set.

TRAVEL-/+ (proportion of the admix in %)

With the settings of these two lines the percentage of the admix is specified in relation to the MASTER signal separately for each direction.

RX WING MIXER TAIL TYPE (tail unit type)

The following model types are also available in the "Tail" line of the »Model type« menu, on page 94 and should, preferentially, be preset there. In this case, *always* leave the TAIL TYPE set to NORMAL.

However, if you would prefer to use the mixer integrated in the receiver, you can select the already pre-adjusted mixer functions for the corresponding model type:

- **NORMAL**

This setting corresponds to the classic aircraft type with rear tail unit and separate rudder and elevator. No mixer function is necessary for this model type.

- **V-TAIL (V-tail unit)**

With this model type the elevator and rudder control functions are connected, so that each of the two tail unit flaps—each controlled with a separate servo—assume both the elevator and rudder function.

The servos are normally connected to the receiver as follows:

OUTPUT CH 3: Left V-tail servo

OUTPUT CH 4: Right V-tail servo

If the servo's direction of rotation is incorrect, please observe the notices on page 62.

- **ELEVON (delta/flying wing models)**

The servos connect at the outputs 2 and 3 assume the aileron and elevator function. The servos are normally connected to the receiver as follows:

OUTPUT CH 2: Left horizontal/vertical

OUTPUT CH 3: Right horizontal/vertical
If the servo's direction of rotation is incorrect, please observe the notices on page 62.

RX CURVE (EXPO)

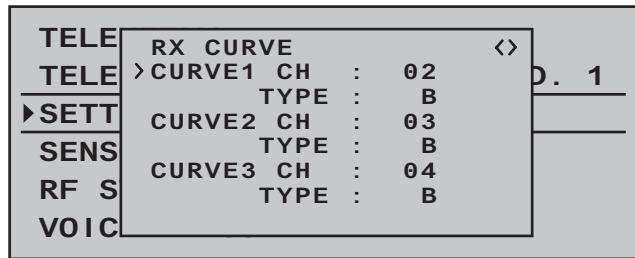

| Value | Explanation | Possible settings |
|-------------------|--|-----------------------------|
| CURVE1, 2 or 3 CH | Channel assignment of the respective curve setting | 1 ... depending on receiver |
| TYPE | Curve type | A, B, C see figure |

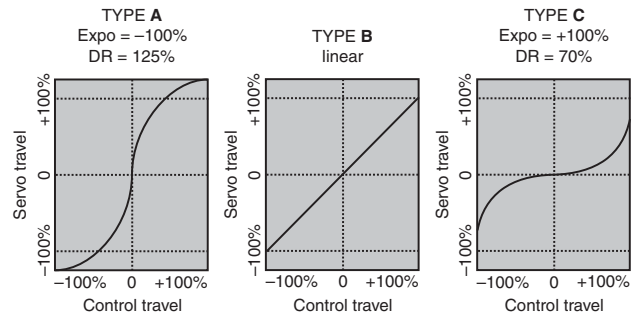

Normally a non-linear control function, if applicable, is used for the aileron (channel 2), elevator (channel 3) and rudder (channel 4). These channel defaults also correspond to the factory settings. BUT CAUTION: This assignment only applies when, on the transmitter side, neither "2HRSv3+8" is specified in the "Tail type" line nor is "2AIL" or 2AIL 2FL" specified in the "Aileron/camber flaps" line of the »**Base settings**«

menu. Otherwise, assignments will have already been made in the transmitter for *control function 3 (elevator)*, which will then be split between *control channels 3 & 8*, or *control function 2 (aileron)*, which will then be split between *control channels 2 & 5 for the left and right ailerons*. The corresponding *control channels (INPUT CH) in the receiver* would in both cases be channels 03 & 08 or 02 & 05.

Therefore if, for example, "2AIL" has been specified on the transmitter side and the intent here is to utilize the RX CURVE option instead of the **MC-20** HoTT transmitter's individually adjustable »Dual Rate / Expo« menu (see page 120 or 124), then two curves must be set:

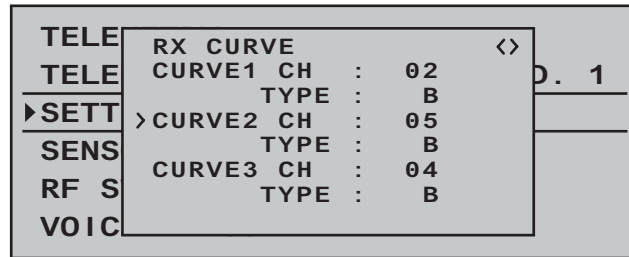

Otherwise, the left and right ailerons have different control characteristics.

With the RX CURVE function you can manage the control characteristics for up to three servos:

- **CURVE 1, 2 or 3 CH**

Select the desired *control channel (INPUT CH)* of the first servo.

The following setting in TYPE only pertains to the channel selected here.

TYPE

Select the servo curve:

A: EXPO = -100% and DUAL RATE = 125%

The servo reacts strongly to movements of the joystick around the neutral position. As the rudder throw increases, the curve becomes flatter.

B: Linear setting.

The servo follows the joystick movement linearly.

C: EXPO = +100% and DUAL RATE = 70%

The servo reacts weakly to the joystick movements around the neutral position. As the rudder throw increases, the curve becomes steeper.

Note:

The control characteristics programmed here also affect the mapped receiver outputs.

5CH FUNCTION: "SERVO" or "SENSOR"

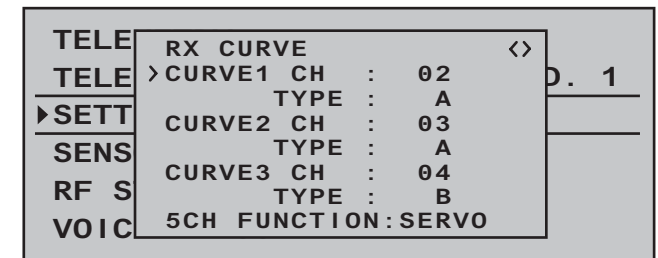

Some receivers have a specific servo connection which has been made switchable rather than an independent telemetry connection. Thus, for example, on the GR-12 receiver included with the **mx-12** HoTT set, order no. **33112**, , servo connector 5 has an extra "T" mark and can be alternatively connected ...



... not only via an order no. **7168.6A** adapter cable to upgrade the receiver but also connected to a telemetry sensor.

However, in order for the receiver to correctly recognize the given connected device correctly, servo connection 5 (in this case) MUST be appropriately set

for either "SERVO" or "SENSOR".

This switchover is accomplished by moving the ▼ with the selection key of the left or right touch pad until the ">" symbol is at the left margin of the bottom line then tapping on the center **SET** key of the right touch pad.

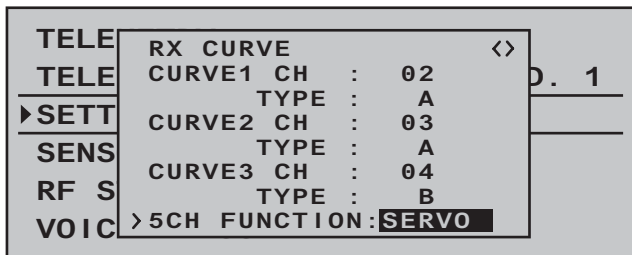

Now use one of the ▲▼ selection keys on the right touch pad to select the alternative setting "SENSOR".

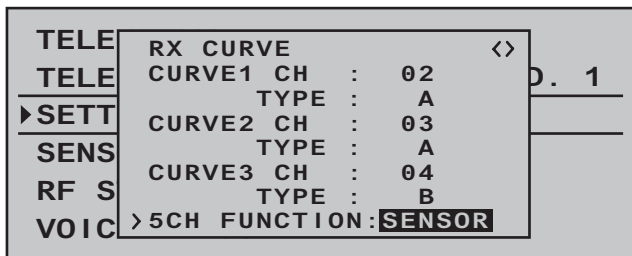

Another tap on the center **SET** key of the right touch pad will close the selection and, with appropriate repetitive taps on the center **ESC** key of the left touch pad, a return to the transmitter's basic display is accomplished.

RX SERVO TEST

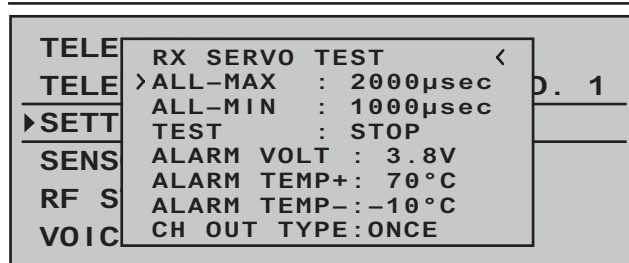

| Value | Explanation | Possible settings |
|----------------|---|---|
| ALL-MAX | Servo travel on the "+" side for all servo outputs for the servo test | 1500 ... 2000 µs |
| ALL-MIN | Servo travel on the "-" side for all servo outputs for the servo test | 1500 ... 1000 µs |
| TEST | Test procedure | START / STOP |
| ALARM VOLT | Alarm threshold of the receiver undervoltage warning | 3.0 ... 6.0 V factory setting: 3.8 V |
| ALARM TEMP+ | Alarm threshold for excessively high temperature of the receiver | 50 ... 80 °C Factory setting: 70 °C |
| ALARM TEMP- | Alarm threshold for excessively low temperature of the receiver | -20 ... +10 °C Factory setting: -10 °C |
| CH OUTPUT TYPE | Channel sequence | ONCE, SAME, SUMI, SUMO |

ALL-MAX (servo travel on the "+" side)

In this line you set the maximum servo travel on the plus side of the control travel for the servo test. 2000 µs corresponds to the full throw; 1500 µs corresponds to the neutral position. Make sure that the servos do not overrun mechanically during the test routine.

ALL-MIN (servo travel on the "-" side)

You adjust the maximum servo travel on the minus side of the control path for the servo test in this line. 1000 µs corresponds to the full throw; 1500 µs corresponds to the neutral position.

TEST

You start and stop the servo test integrated in the receivers in this line.

A brief tap on the center **SET** key of the right touch pad will open the entry field:

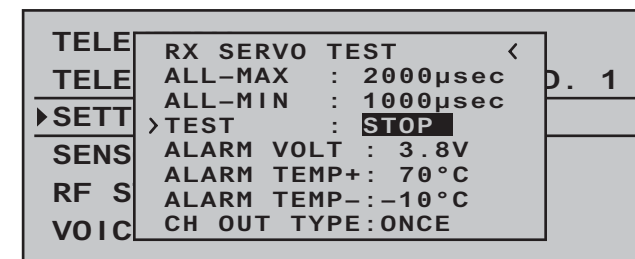

Now, with one of the selection keys of the right touch pad, select **START**:

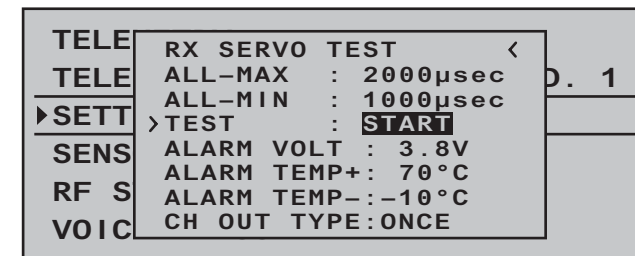

A brief tap on the center **SET** key of the right touch pad will now start the test run. The input field is

shown as "normal" again:

| | | |
|-------|---------------------|------|
| TELE | RX SERVO TEST < | D. 1 |
| TELE | ALL-MAX : 2000µsec | |
| ▶SETT | ALL-MIN : 1000µsec | |
| SENS | >TEST : START | |
| RF S | ALARM VOLT : 3.8V | |
| VOIC | ALARM TEMP+ : 70°C | |
| | ALARM TEMP- : -10°C | |
| | CH OUT TYPE : ONCE | |

To stop the servo test, reactivate the entry field as described above, select **STOP** and confirm this selection with the **SET** key of the right touch pad.

ALARM VOLT (receiver undervoltage warning)

The receiver voltage is monitored through ALARM VOLT. The interval can be adjusted between 3.0 and 6.0 Volt. If the set alarm threshold is undercut, an acoustic signal is issued (interval peep tone long/short) and "**VOLT.E**" blinks in the top right of all »RX ...« displays:

| | | |
|-------|---------------------------|------|
| TELE | RX SERVO VOLT.E <> | D. 1 |
| TELE | >OUTPUT CH : 01 | |
| ▶SETT | REVERSE : OFF | |
| SENS | CENTER : 1500µsec | |
| RF S | TRIM : -000µsec | |
| VOIC | TRAVEL- : 150% | |
| | TRAVEL+ : 150% | |
| | PERIOD : 20msec | |

The parameter "**R-VOLT**" is also represented inversely in the »RX DATAVIEW« display:

| | | |
|-------|-----------------------------|------|
| TELE | RX DATAVIEW VOLT.E > | D. 1 |
| TELE | S-QUA100% S-dBM-030dBm | |
| ▶SETT | S-STR100% R-TEM.+28°C | |
| SENS | L PACK TIME 00010msec | |
| RF S | R-VOLT : 03.7V | |
| VOIC | L R-VOLT : 03.5V | |
| | SENSOR1 : 00.0V 00°C | |
| | SENSOR2 : 00.0V 00°C | |

ALARM TEMP +/- (recommended temperature monitoring)

These two options monitor the receiver temperature. A lower threshold "ALARM TEMP-" (-20 ... +10°C) and an upper threshold "ALARM TEMP+" (50 ... 80°C) can be programmed. When these specifications are exceeded or undercut, an acoustic signal (continuous peep tone) sounds and "**TEMP.E**" appears in the top right of all receiver displays. In addition, the parameter "**R-TEM**" is shown inversely on the »RX DATAVIEW« display page.

Make sure that your receiver remains within the permissible temperature range during all flight conditions (ideally between -10 and 55°C).

CH OUTPUT TYPE (connection type)

Here you select how the receiver outputs are controlled.

- **ONCE**

| | | |
|-------|----------------------------|------|
| TELE | RX SERVO TEST < | D. 1 |
| TELE | ALL-MAX : 2000µsec | |
| ▶SETT | ALL-MIN : 1000µsec | |
| SENS | TEST : START | |
| RF S | ALARM VOLT : 3.8V | |
| VOIC | ALARM TEMP+ : 70°C | |
| | ALARM TEMP- : -10°C | |
| | >CH OUT TYPE : ONCE | |

The servo connections of the receiver are controlled successively. This is recommended for analog servos.

This setting automatically operates servos in a 20 ms cycle – or in a 30 ms cycle for a 12 channel receiver (order no. **33512**) –, regardless of what is set or displayed in the "PERIOD" line of the »RX SERVO« screen!

- **SAME**

| | | |
|-------|----------------------------|------|
| TELE | RX SERVO TEST < | D. 1 |
| TELE | ALL-MAX : 2000µsec | |
| ▶SETT | ALL-MIN : 1000µsec | |
| SENS | TEST : START | |
| RF S | ALARM VOLT : 3.8V | |
| VOIC | ALARM TEMP+ : 70°C | |
| | ALARM TEMP- : -10°C | |
| | >CH OUT TYPE : SAME | |

The servo connections of the receiver are controlled in parallel in blocks of four. This means channels 1 through 4, 5 through 8 and 9 through 12 each receive the control signals simultaneously.

This is recommended for digital servos when multiple servos are used for one function (e.g. aileron), so that the servos can run absolutely synchronized.

When only using digital servos, we recommend setting the "PERIOD" line of the »RX SERVO« to 10 ms in order to be able to utilize the fast reaction of digital servos. With the use of analog servos or in mixer mode, "20 ms" must be selected!

With this setting, pay particular attention to the sufficient dimensioning of the receiver current supply. Since up to four servos can always operate simultaneously, the requirement is higher.

- **SUMO (sum signal OUT)**

A HoTT receiver configured as SUMO permanently generates a so-called sum signal from the control signals of all of its control channels and provides this by default to the accompanying GR-32 DUAL receiver on servo connection 8.

On receivers whose display shows "SUMO" at the top right, an additional two-digit number appears ...

| | | | |
|-------|-----------------------|---|------|
| TELE | RX SERVO TEST | < | D. 1 |
| TELE | ALL-MAX : 2000µsec | | |
| ▶SETT | ALL-MIN : 1000µsec | | |
| SENS | TEST : START | | |
| RF S | ALARM VOLT : 3.8V | | |
| VOIC | ALARM TEMP+ : 70°C | | |
| | ALARM TEMP- : -10°C | | |
| | >CH OUT TYPE: SUMO 12 | | |

... after confirmation of "SUMO" with a brief tap on the center **SET** key of the right touch pad, the active field changes to the right for channel selection. With this selection you specify the *highest* of the transmitter channels contained in the SUMO signal:

| | | | |
|-------|-----------------------|---|------|
| TELE | RX SERVO TEST | < | D. 1 |
| TELE | ALL-MAX : 2000µsec | | |
| ▶SETT | ALL-MIN : 1000µsec | | |
| SENS | TEST : START | | |
| RF S | ALARM VOLT : 3.8V | | |
| VOIC | ALARM TEMP+ : 70°C | | |
| | ALARM TEMP- : -10°C | | |
| | >CH OUT TYPE: SUMO 12 | | |

Either confirm the default with another tap on the center **SET** key of the right touch pad or use the selection keys to pick another channel between 04 and 16 and confirm that with **SET**.

Receiver outputs will be controlled successively in a 20 ms cycle (30 ms with the GR-32 DUAL receiver, order no. **33516**), even if 10 ms is set in the "PERIOD" line of the the »RX SERVO« screen.

Primarily intended for the "Satellite mode" of two HoTT receivers, as described below, the sum signal generated by the SUMO-designated receiver can also be used, for example, to control of Flybar systems (provided they have an appropriate input) or to control flight simulators via an adapter cable, order no. **33310**

In ...

Satellite mode

... two HoTT receivers are connected to one another through a three-wire connecting cable (order no. **33700.1** (300 mm) or **33700.2** (100 mm)) at receiver-type-specific servo connections. Type GR-16 and GR-32 DUAL receivers, for example, are to be connected with one another at servo output 8. More detailed information can be found on the Internet at www.graupner.de.

This connection transmits all channels of the HoTT receiver configured as SUMO as well as those of the receivers designated as satellites continuously to the second HoTT receiver, which is to be programmed as ...

- **SUMI (sum signal IN)**

... the designation for the main receiver.

Therefore, the signal always goes toward SUMI:

| | | | |
|-------|---------------------|---|------|
| TELE | RX SERVO TEST | < | D. 1 |
| TELE | ALL-MAX : 2000µsec | | |
| ▶SETT | ALL-MIN : 1000µsec | | |
| SENS | TEST : START | | |
| RF S | ALARM VOLT : 3.8V | | |
| VOIC | ALARM TEMP+ : 70°C | | |
| | ALARM TEMP- : -10°C | | |
| | >CH OUT TYPE: SUMI | | |

The receiver defined as SUMI, however, only uses the sum signal coming from SUMO in the event of a failure of receipt if at least one channel in SUMI is programmed to fail-safe.

If the receiver programmed as the SUMO satellite receiver has a reception outage, the servos connected to this receiver assume the fail-safe positions which were programmed into the satellite receiver, completely independent of the main receiver.

On the other hand, if two receivers have a reception outage *simultaneously*, the fail-safe settings in the current receiver software at the

time this manual went to print (in principle, the SUMO's fail-safe settings) become effective. In the individual case, however, interactions cannot be ruled out, **which is why we urgently recommend performing an appropriate test BEFORE commissioning a model.**

This receiver combination is recommended if, for example, one of the two receivers is installed in the model at an unfavorable position for receiving or as a result of nozzles, carbon fiber material or the like, there is the danger that the receipt signal is weakened due to the flight position, so that interruptions of the range must be taken into account.

Therefore, make sure to connect the most important control functions to the main receiver programmed as SUMI, so that, in the event of a failure, the model remains controllable when the SUMO satellite receiver no longer receives a signal.

Telemetry data, such as the voltage of the on-board electricity supply, on the other hand, is only sent to the transmitter by the satellite receiver configured as SUMO. Therefore, telemetry sensors are to be connected to the satellite receiver (SUMO).

Each receiver should be connected with its own supply line from the common voltage supply. With receivers with a high current load, it may even be beneficial to connect them with two supply lines to the same current supply.

On the other hand, if each of the two receivers should be supplied from its own voltage source, the center cable must be removed from one of the two plugs of the satellite cable; see figure.

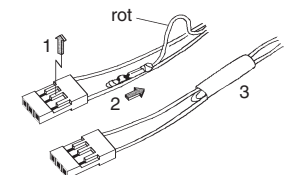

If you would like to carry out additional

programming, such as fail-safe settings, disconnect the three-pole satellite connection between the two receivers and switch on only the relevant receiver. It may be necessary to also change the connection sequence.

Setting/displaying sensors

If, in addition to a "receiver", at least one sensor is selected in the »**Telemetry**« menu's »**SENSOR SELECT**« sub-menu (described below) then its settings can be read in and changed on the previously described receiver screens.

However, to actually gain access to this data, the selected sensor/s must be connected to the receiver system and this receiver system must have an active telemetry connection.

If, as described in the next section, there is at least one sensor activated which has the support of current firmware, then it is possible to directly switch between individual modules. However, if sensors with older firmware are in use, it *may* be necessary to select "etc." instead of the direct sensor selection.

In either case, tap the ▲ or ▼ selection key of the *left* touch pad ...



... then use the same keys to select up or down for the desired module, for example:



If the selected module, in this case a Vario module, is active then on the last receiver screen ("RX SERVO TEST"), at the top right there will also be an additional ">" symbol pointing to the right. This symbol is located just to the right of the left-pointing "<" symbol and is the visible indicator that additional display screens can be accessed.

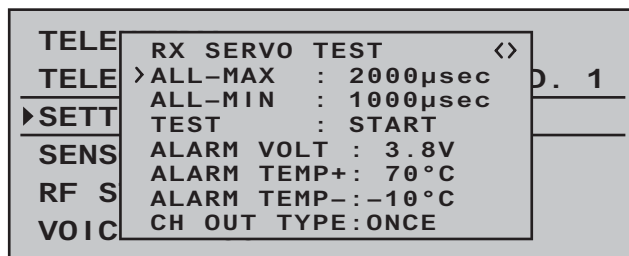

Now use one of the ▶ selection keys on the left or right touch pad to switch to the selected sensor's displays and check or change its settings as described in the manual delivered with the sensor.

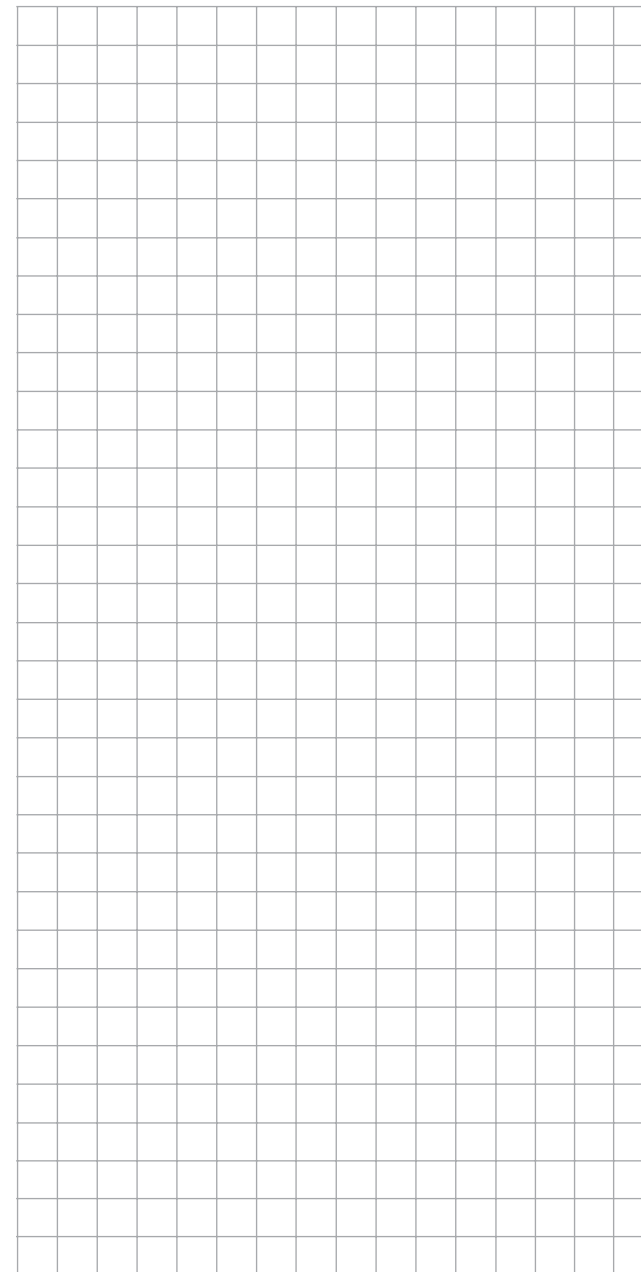

SENSOR SELECT

Selecting sensors

After selection of the desired menu line with the ▲▼ selection keys of the left or right touch pad ...

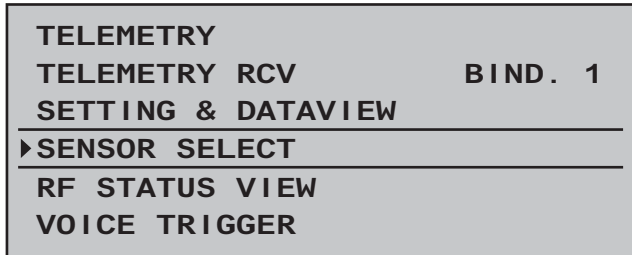

... and a subsequent tap on the center **SET** key of the right touch pad, the selected sub-menu will open.

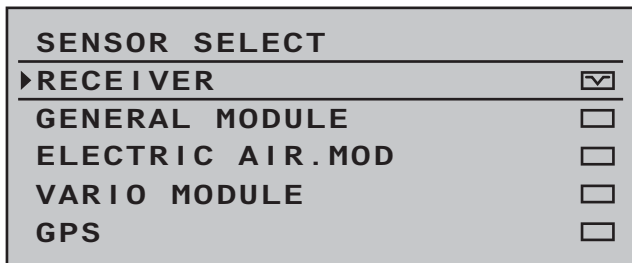

This menu option can be used to determine which of the graphic displays described on page 36, as well as those described previously for sub-menu »SETTINGS/DISPLAYS«, can be selected and which remain hidden.

Activate () or deactivate () the display of respective sensors by selecting the desired lines with the ▲▼ selection keys of the left or right touch pad then tapping on the center **SET** key of the right touch pad, e.g.:

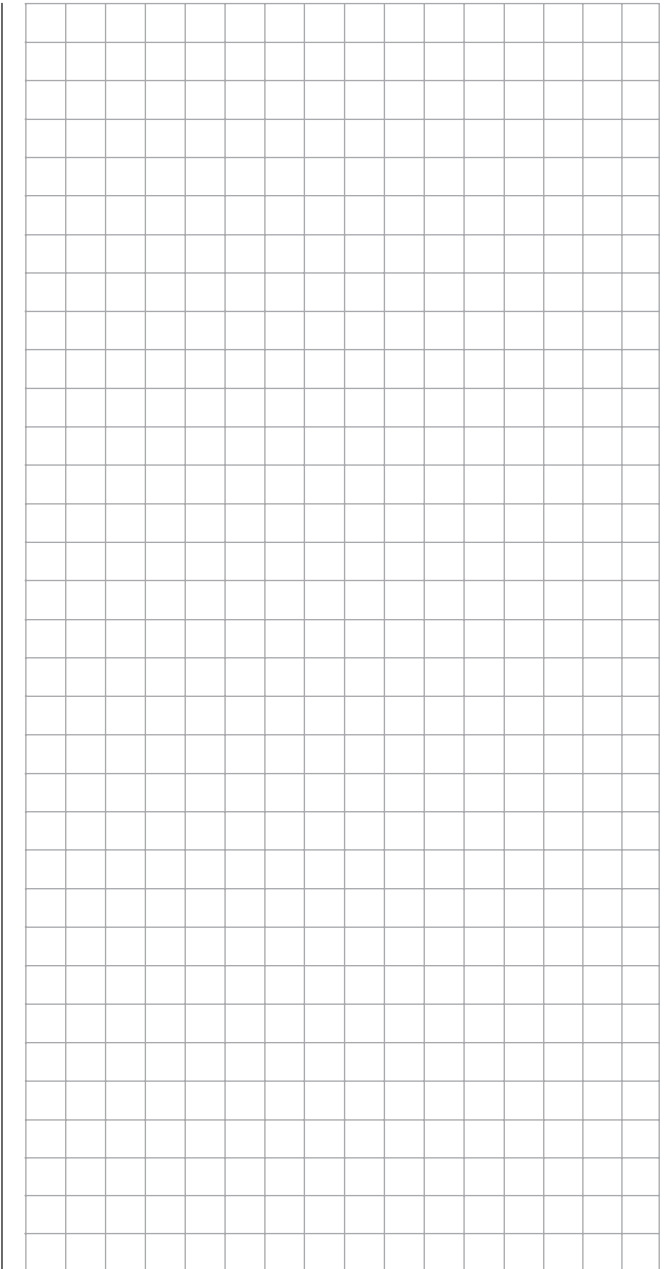
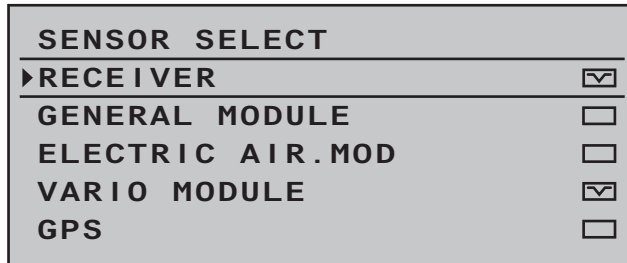

RF STATUS VIEW

After selection of the desired menu line with the ▲▼ selection keys of the left or right touch pad ...

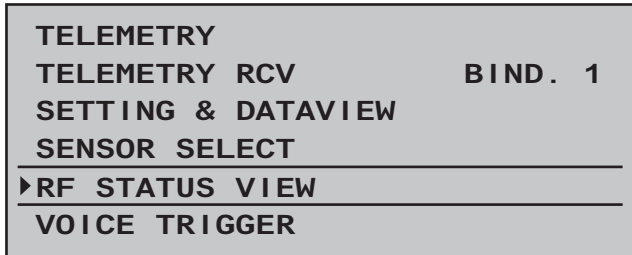

... and a subsequent tap on the center **SET** key of the right touch pad will open the selected sub-menu. This provides a visualization of the quality of the connection of transmitter and receiver:

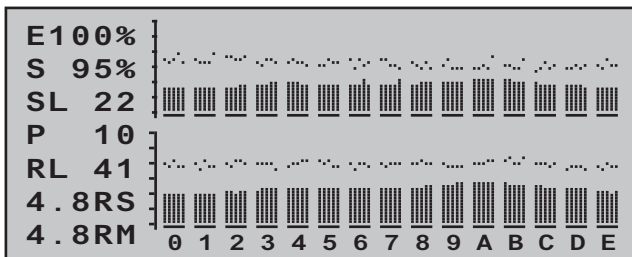

Top row: Reception power of the channels 1 ... 75 of the 2.4 GHz band in dBm coming from the receiver to the transmitter.

Bottom row: Reception power of the channels 1 ... 75 of the 2.4 GHz band in dBm coming from the transmitter to the receiver.

Comments:

- Since reception power is measured and presented in dBm, reception power is increasingly worse the higher the bar is and vice versa; refer also to "Reception power (S-dBm)" on page 230 about

this.

- The points above the bars mark the poorest reception since switching on the transmitter or the last reset of the display with a simultaneous tap on the▲▼ or ◀▶ keys of the right touch pad (**CLEAR**).

Additional figures are shown to the left of the graphic representation of the reception power. These mean:

| Value | Explanation |
|-------|--|
| E | Signal quality in % of the signal received from the receiver |
| S | Signal quality in % of the signal received by the receiver |
| SL | Reception power in dBm |
| P | Number of lost data packages of the receiver |
| RL | Reception power in dBm of the signal received by the receiver |
| RS | Current operating voltage of the receiver in volts |
| RM | Lowest receiver operating voltage since last startup, in volts |

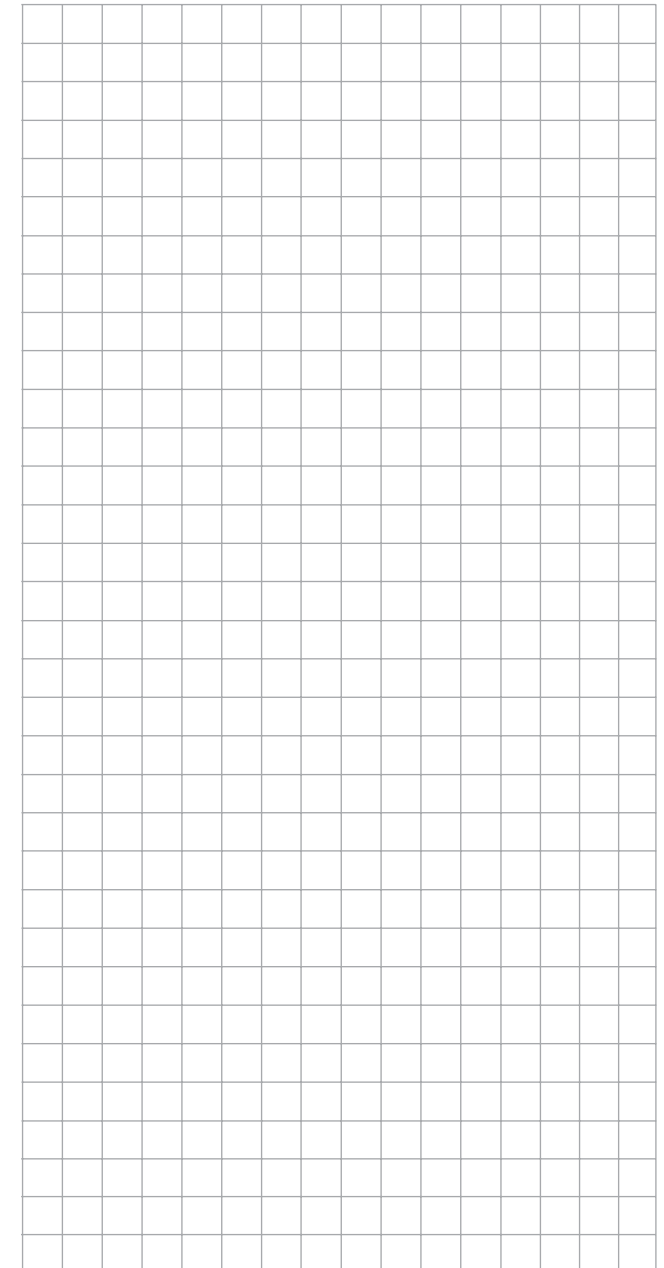

VOICE TRIGGER

After selection of the desired menu line with the ▲▼ selection keys of the left or right touch pad ...

| |
|-----------------------|
| TELEMETRY |
| TELEMETRY RCV BIND. 1 |
| SETTING & DATAVIEW |
| SENSOR SELECT |
| RF STATUS VIEW |
| ▶VOICE TRIGGER |

and a subsequent tap on the center **SET** key of the right touch pad will open the selected sub-menu.

REPEAT

| | | |
|---------------|------|-----|
| VOICE TRIGGER | | |
| ▶REPEAT | 1sec | --- |
| TRIG | | --- |
| VARIO | | --- |
| TRANSMIT | | |
| ▼ | | ↙- |

In order to be able to start the voice output through the headphone connection, at the very least the "REPEAT" line must be assigned to a switch. The takes place as described in the section "Switch and control switch assignments" on page 56:

| | | |
|---------------|---|-----|
| VOICE TRIGGER | | |
| ▶REPEAT | Move desired switch to ON position (ext. switch: ENTER) | --- |
| TRIG | | --- |
| VARIO | | --- |
| TRANSMIT | | |
| ▼ | | ↙- |

| | | |
|---------------|------|-----|
| VOICE TRIGGER | | |
| ▶REPEAT | 1sec | 3↓ |
| TRIG | | --- |
| VARIO | | --- |
| TRANSMIT | | |
| ▼ | | ↙- |

With this switch you can have the last respective voice trigger repeated for the duration of the time set to the left of the switch, as long as the assigned switch is closed:

TRIG

With a switch assigned to this line, preferably one of the two pushbuttons, switch the selected voice messages in rotation on to the next voice message for the below-described "TRANSMITTER", "RECEIVER" and "SENSOR" options, as described below.

| | | |
|---------------|------|-----|
| VOICE TRIGGER | | |
| REPEAT | 1sec | 3↓ |
| ▶TRIG | | 1↓ |
| VARIO | | --- |
| TRANSMIT | | |
| ▼▲ | | ↙- |

VARIO

If the "VARIO MODULE" line is activated () in the »**SENSOR SELECT**« sub-menu, as described on page 240, a switch assigned to one of these lines can be used to call up vario-specific voice messages for the headset connection which are completely independent of other voice messages, i.e. voice messages triggered by altitude changes, such as the message "slowly ascend/descend".

| | | |
|---------------|------|----|
| VOICE TRIGGER | | |
| REPEAT | 1sec | 3↓ |
| TRIG | | 1↓ |
| ▶VARIO | | 8↓ |
| TRANSMIT | | |
| ▼▲ | | ↙- |

TRANSMITTER

After selection of the desired menu line with the ▲▼ selection keys of the left or right touch pad ...

| | | |
|---------------|------|----|
| VOICE TRIGGER | | |
| REPEAT | 1sec | 3↓ |
| TRIG | | 1↓ |
| VARIO | | 8↓ |
| ▶TRANSMIT | | |
| ▼▲ | | |

and a subsequent tap on the center **SET** key of the right touch pad will open the selected sub-menu.

| | |
|------------------------|-------------------------------------|
| ▶VOLT : | <input checked="" type="checkbox"/> |
| MODEL TIME : | <input checked="" type="checkbox"/> |
| BATTERY TIME : | <input checked="" type="checkbox"/> |
| TIMER (GE .) TOP : | <input checked="" type="checkbox"/> |
| TIMER (GE .) CENTER : | <input checked="" type="checkbox"/> |
| PHASE TIMER : | <input checked="" type="checkbox"/> |
| TIME : | <input checked="" type="checkbox"/> |

Here, after selection of the desired line with the ▲▼ selection keys of the left or right touch pad and a subsequent tap on the center **SET** key of the right touch pad, the selected voice message can be activated () or deactivated ()

| | |
|------------------------|-------------------------------------|
| VOLT : | <input checked="" type="checkbox"/> |
| MODEL TIME : | <input type="checkbox"/> |
| ▶ BATTERY TIME : | <input type="checkbox"/> |
| TIMER (GE .) TOP : | <input checked="" type="checkbox"/> |
| TIMER (GE .) CENTER : | <input checked="" type="checkbox"/> |
| PHASE TIMER : | <input checked="" type="checkbox"/> |
| TIME : | <input checked="" type="checkbox"/> |

RECEIVER

After selection of the desired menu line with the ▲▼ selection keys of the left or right touch pad ...

| | |
|---------------|----|
| VOICE TRIGGER | |
| TRIG | 1↘ |
| VARIO | 8↘ |
| TRANSMIT | |
| ▶ RECEIVER | |
| ▼▲ | |

... and a subsequent tap on the center **SET** key of the right touch pad will open the selected sub-menu:

| | |
|------------|-------------------------------------|
| ▶ TEMP : | <input checked="" type="checkbox"/> |
| STRENGHT : | <input checked="" type="checkbox"/> |
| VOLT : | <input checked="" type="checkbox"/> |
| LOWVOLT : | <input checked="" type="checkbox"/> |

Here, after selection of the desired line with the ▲▼ selection keys of the left or right touch pad and a subsequent tap on the center **SET** key of the right touch pad, the selected voice message can be activated () or deactivated () .

SENSOR

This line only appears if a sensor was first activated in the »**SENSOR SELECT**« sub-menu. For example, if the »**VARIO**« sensor is selected then the selections for the "VARIO" line will be opened ...

| | |
|---------------|----|
| VOICE TRIGGER | |
| VARIO | 8↘ |
| TRANSMIT | |
| RECEIVER | |
| ▶ VARIO | |
| ▲ | |

when a subsequent tap on the center **SET** key of the right touch pad calls up the sub-menu.

| | |
|------------|-------------------------------------|
| ALT : | <input checked="" type="checkbox"/> |
| ▶ MAXALT : | <input checked="" type="checkbox"/> |
| MINALT : | <input checked="" type="checkbox"/> |

As described in the column at the left, these menus also allow every offered voice message to be activated () or deactivated () by selecting the desired line followed by a tap on the center **SET** key of the right touch pad.

Note:

The selection made here is completely independent of the "VARIO" voice triggers.

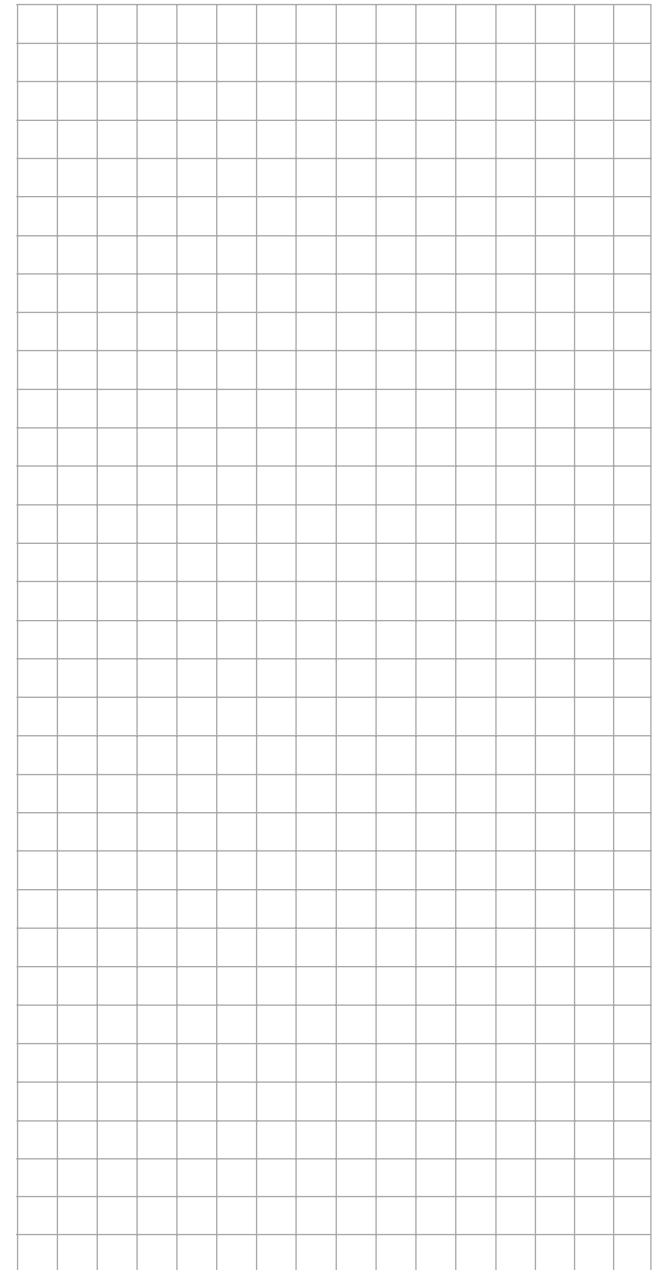



Channel sequencer

Programming the motion sequences of up to 3 servos

Use the selection keys on the left or right touch pad to scroll to the »**Channel sequence**« menu option in the multi-function menu:

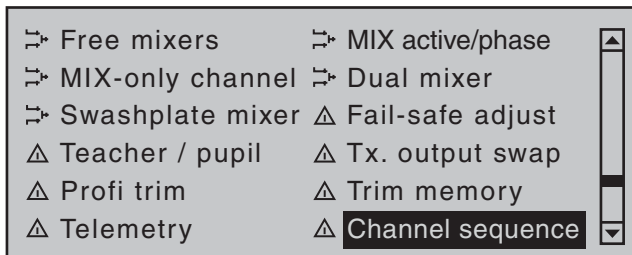
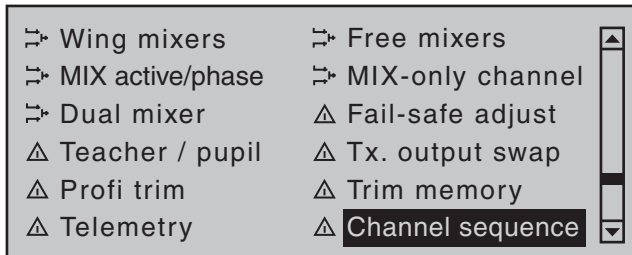

Tap briefly on the center **SET** key of the right touch pad to open this menu option:

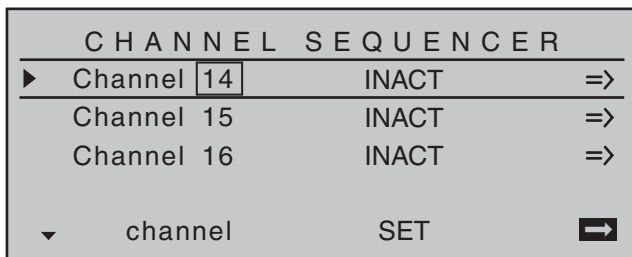

The »Channel sequence« menu option can be used to execute up to 9 exactly coordinated steps for up to three servos over a period of up to 30 seconds. Such a sequence can be triggered by a single switch and begin at an initial servo position which is freely adjustable. For example, this makes the opening of undercarriage doors, complete with subsequent extension of the retractable gear, just as simple to program as opening a wheel well with renewed closing

of one undercarriage door once the landing gear has been lowered or to program the raising of a cockpit canopy with subsequent head turns and waving performed by the pilot. However, the prerequisite for all these actions is the "parsing" of the desired motion sequence into practical, individual steps.

Programming procedure

On this menu option's first display page, see figure below left, either accept the three preset channels, 14 ... 16, or select an available channel, 5 ... 16, for each line to form any other desired combination, e.g.:

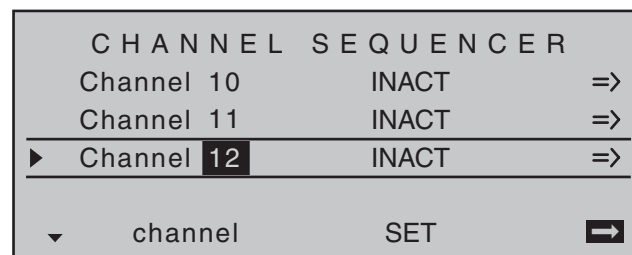

With a simultaneous tap on the ▲▼ or ◀▶ selection keys of the right touch pad (**CLEAR**), the given channel is reset back to 5, 6 or 7.

The next step makes the control channels needed for the channel sequence available. This is done in the "SET" column by changing settings from "INACT" to "ACT" and thus making the individual channels "available" to the program for sequencing. Conversely, this also means that channels defined as "active" in the »Channel sequence« menu are *not* available for other purposes.

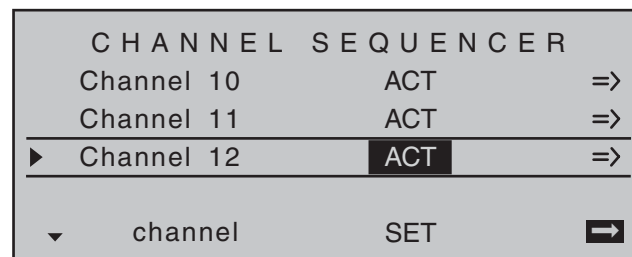

With a simultaneous tap on the ▲▼ or ◀▶ selection keys of the right touch pad (**CLEAR**), the given channel is reset back to "INACT".

Once control channels and their activity statuses have been set, switch to the right column then tap on the center **SET** key of the right touch pad to reach the second page, the »Channel sequence« menu's choreography page. Since the call-up of the second page in this example was issued from the "Servo 12" line, this servo remains the object of focus after the page change.

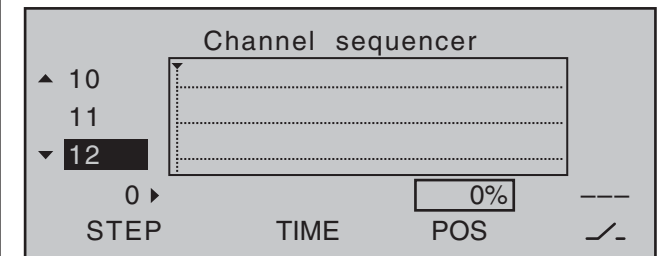

The previous display page permitted the selection of participating servos and their incorporation into the sequence. This display page will now be used to establish the sequence of steps for participating servos, beginning with initial positions yet to be defined. The step number, from "0▶" to a maximum of "◀9", will be shown in the column labeled "STEP" near the bottom left of the display.

Step 0: Setting initial position

Keep the focus of attention on "Servo 12" or change to any other of the three servos by using the ▲▼ keys of the *left* touch pad, e.g. upward to "Servo 10".

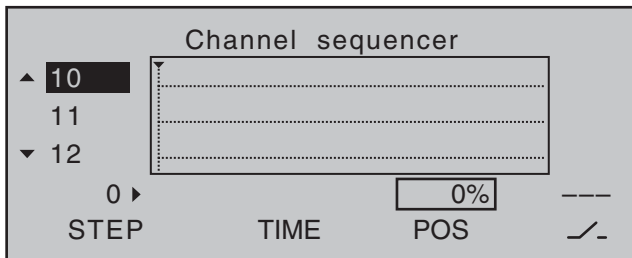

Use one of the ▲► selection keys of the *right* touch pad, as necessary, to shift the marker frame to the right from the column "TIME" to the value field above the column labeled "POS" then, after a tap on the center **SET** key of the right touch pad, alter this value within a range of ±100% until the servo is in the desired initial position. For example:

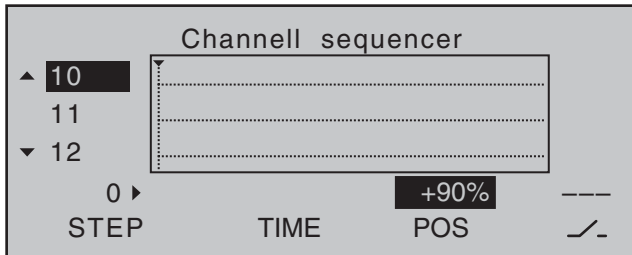

Repeat this procedure as necessary for the other two servos.

With a simultaneous tap on the ▲▼ or ◀► selection keys of the right touch pad (**CLEAR**), the given position value will be reset back to "0%".

Step 1: first event

Now that initial positions have been established, the first step can be set. This is a matter of defining what is to be done, or not done, first, following a certain span of time.

Do this by first using the ▲▼ selection keys of the *left* touch pad to select one of the servos. Now tap the ► key of the *left* touch pad. The step number, which was previously indicated by a "0" is now replaced

by a "1" and the value "0.0s" will appear in the field above "TIME".

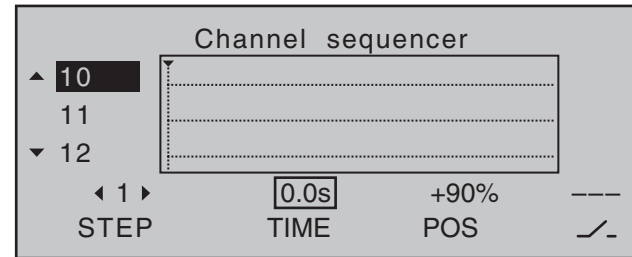

Use the selection keys of the *right* touch pad as necessary to shift the marker frame to the "TIME" column.

Now briefly tap on the center **SET** key of the right touch pad to set the activation time into the value field for the "TIME" column, e.g. 1.5 s. The current position in time is represented in the graphic by the dotted vertical line. It will move to the right according to the time setting and, at the same time, the course of servo positions will be presented as dotted lines between time-point "0" and time-point "1".

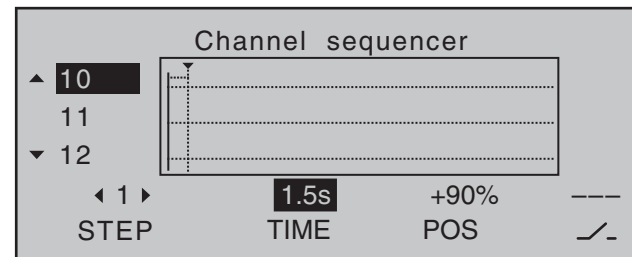

Now set the desired servo positions for the end of the first time span (with the same procedure as already described for "Step 0") or leave one or more of these servos in the same position they were in for the previous step.

A simultaneous tap on the ▲▼ or ◀► keys of the right touch pad (**CLEAR**) will reset the inverse video value displayed if the TIME field back to "blank" and erase the current sequence, in this example only Step "1".

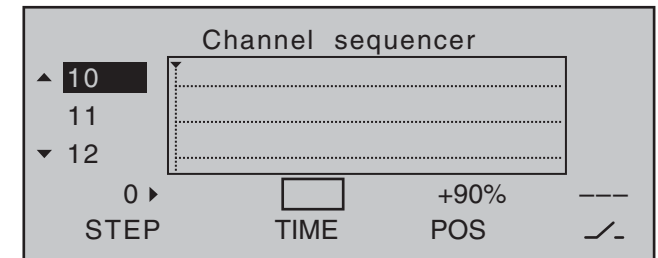

Step 2 ...

Repeat the previously described procedure for every other step to be defined until the servos have reached their terminal positions.

Switch assignment

In conclusion, assign the sequence of events created to a switch (as described on page 56 in the section "Assigning transmitter controls, switches and control switches") with which the servos can be switched between their initial and terminal positions.

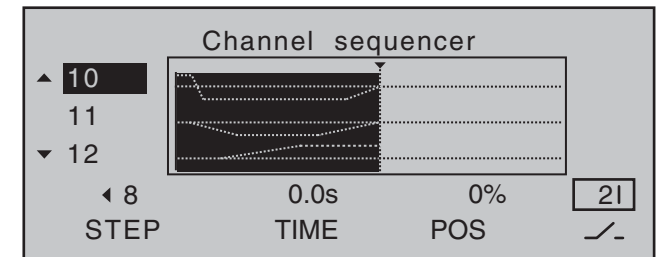

As soon as this switch is closed, the servos' sequence of movements can be followed in the graphic. The servo curves will be shown in inverse video according to the preset time windows. All movements will sequence in reverse when the switch is opened again.

Important notices:

- The sequence shown is only for demonstration purposes and is not at all representative of a real sequence of servo movements.

| | |
|-----------------------|--------------------|
| ➔ MIX active/phase | ➔ MIX-only channel |
| ➔ Dual mixer | △ Fail-safe adjust |
| △ Teacher / pupil | △ Tx. output swap |
| △ Profi trim | △ Trim memory |
| △ Telemetry | △ Channel sequence |
| △ Multichannel | △ Ring limiter |

| | |
|-----------------------|--------------------|
| ➔ MIX-only channel | ➔ Dual mixer |
| ➔ Swashplate mixer | △ Fail-safe adjust |
| △ Teacher / pupil | △ Tx. output swap |
| △ Profi trim | △ Trim memory |
| △ Telemetry | △ Channel sequence |
| △ Multichannel | △ Ring limiter |

... then open this menu option with a brief tap on the center **SET** key of the right touch pad.

Here, in the second column from the left, each of the two multi-channel functions can be activated ("ACT") or deactivated ("INACT") as desired and in the third column the given function can be assigned to one of the transmitter channels, C5 through C8, in a list.

| MULTICHANNEL | | | |
|--------------|-------|-----|---------------|
| ▶ MULTIC1 | INACT | C5 | MULTIC 4CH => |
| MULTIC2 | INACT | C6 | MULTIC 4CH => |
| ▼ | SET | SEL | SEL ➔ |

Note:

When a changeover is made to the »**Servo display**« or if »**Servo adjustment**« is used to select the "-travel+" or "-lim +" columns for these previously set channels, their respective cells will flash to indicate that these channels have been activated in the »**Multichannel**« menu. The preset values of 100% or 150% should not be changed.

Prior to channel selection, please observe the following notices:

- Switch to the "SETTINGS/DISPLAYS" line of the »**Telemetry**« menu and tap on the center **SET** key of the right touch pad:
 - on the "RX SERVO" page, select the "20msec" setting in the last line "PERIOD", see page 231.
 - On the "RX SERVO TEST" display page, select the "SAME" option for the last line "CH OUT TYPE", see page 238.
- The control channel used may not be used as an input nor as an output channel for any mixer! For example, if C5 is selected, be sure that the "Aile/flaps" line of the »**Model type**« menu is preset to "1AIL" or that the "Swashplate type" line of the »**Helicopter type**« menu is preset to "1 servo".
- The channel settings intended for NAUTIC control channel purposes in the »**Control adjust**« and »**Servo adjustment**« menus are to be left as they are or reset back to their original settings. Do not assign any transmitter control or switch to the respective input either. Also be sure that the servo's direction of rotation is not reversed. Leave the servo middle at 0%.

| MULTICHANNEL | | | |
|--------------|-----|-----|---------------|
| ▶ MULTIC1 | ACT | C5 | MULTIC 4CH => |
| ▶ MULTIC2 | ACT | C6 | MULTIC 4CH => |
| ▲ | SET | SEL | SEL ➔ |

In the next column to the right, make a separate channel count specification for each of the two multi-channels; "MULTIC 4C." for the NAUTIC-Multi-Prop mini decoder, order no. **4142.N** or "MULTIC 8C." for the NAUTIC-Expert switching module, order no.

4159.

| MULTICHANNEL | | | | |
|--------------|-----|-----|----------------------|---|
| MULTIC1 | ACT | C5 | MULTIC 4CH => | |
| ▶ MULTIC2 | ACT | C6 | MULTIC 8CH => | |
| ▲ | SET | SEL | SEL | ➔ |

Afterward, use the right arrow symbol at the bottom line's right end to switch over to the second page of settings for the »**Multichannel**« menu:

| MULTICH 2 | | | | |
|-----------|-----|-----|--------|------------|
| ▶ Input 1 | fr | --- | 0% | +100%+100% |
| Input 2 | fr | --- | 0% | +100%+100% |
| Input 3 | fr | --- | 0% | +100%+100% |
| Input 4 | fr | --- | 0% | +100%+100% |
| Input 5 | fr | --- | 0% | +100%+100% |
| Input 6 | fr | --- | 0% | +100%+100% |
| Input 7 | fr | --- | 0% | +100%+100% |
| Input 8 | fr | --- | 0% | +100%+100% |
| ▼ | SEL | / | Offset | - travel + |

This menu page is now used for making individual settings for "MULTICH 1" and "MULTICH 2".

Column 2, "Control"

| MULTICH 2 | | | | |
|-----------|-----|-----|--------|------------|
| ▶ Input 1 | fr | --- | 0% | +100%+100% |
| Input 2 | fr | --- | 0% | +100%+100% |
| Input 3 | fr | --- | 0% | +100%+100% |
| Input 4 | fr | --- | 0% | +100%+100% |
| ▼ | SEL | / | Offset | - travel+ |

Use the arrow keys to move to the column over **SEL**.

After completing the activation of transmitter control assignment by tapping the center **SET** key of the right touch pad, the message shown below will appear in the display:

| MULTICH 2 | | | | |
|-----------|-----|-----|--------|------------|
| ►Input 1 | fr | --- | 0% | +100%+100% |
| Input 2 | fr | --- | 0% | +100%+100% |
| Input 3 | fr | --- | 0% | +100%+100% |
| Input 4 | fr | --- | 0% | +100%+100% |
| ▼ | SEL | ↙ | Offset | - travel + |

Alternatively, the center **SET** key of the right touch pad can be tapped for a second time while this message is on display:

| MULTICH 2 | | | | |
|-----------|-----|-----|--------|------------|
| ►Input 1 | fr | --- | 0% | +100%+100% |
| Input 2 | fr | --- | 0% | +100%+100% |
| Input 3 | fr | --- | 0% | +100%+100% |
| Input 4 | fr | --- | 0% | +100%+100% |
| ▼ | SEL | ↙ | Offset | - travel + |

Now the desired transmitter control can be selected with the selection keys on the left or right touch pad. If the selected control has an assignment, it can be disconnected from a transmitter control switching its field to "fr".:

- transmitter control 1 ... 4 (CH 1 ...4)
- slider control 1 ... 3 in the middle of the console (SR1 ... 3)
- depressible, roller-shaped proportional speed control (DG1 ... 5)
- side proportional control control (SD1 and SD2) (Function inputs "UV1" through "UV8", which are also in the selection list, can be selected at a later time)

and then connected as necessary.)

If a Nautic-Expert switching module (order no. **4159**) is present, the assigned proportional control will function like a switch when it is put near its limit position.

Column 3, "Switch"

| MULTICH 2 | | | | |
|-----------|-----|-----|--------|------------|
| ►Input 1 | fr | --- | 0% | +100%+100% |
| Input 2 | fr | --- | 0% | +100%+100% |
| Input 3 | fr | --- | 0% | +100%+100% |
| Input 4 | fr | --- | 0% | +100%+100% |
| ▼ | SEL | ↙ | Offset | - travel + |

This column is used to assign each of the inputs used, 1 through 8 (maximum), to any switch available on the transmitter. These assignments are done as described in the section "Assigning transmitter controls, switches and control switches" on page 56: Any controls which were previously assigned in the second column will be erased. In this case, instead of **SEL**, the switch symbol ↙ will be displayed at the bottom of the 2nd column such that now a second "normal" switch, or even a transmitter control switch, logical switch, ... can be assigned as needed from the group of "expanded switches". In general it is sufficient to assign a simple switch or transmitter control.

| MULTICH 2 | | | | |
|-----------|-----|-----|--------|------------|
| ►Input 1 | --- | 3 | 0% | +100%+100% |
| Input 2 | fr | --- | 0% | +100%+100% |
| Input 3 | fr | --- | 0% | +100%+100% |
| Input 4 | fr | --- | 0% | +100%+100% |
| ▼ | ↙ | ↙ | Offset | - travel + |

Column 3, "Offset"

| MULTICH 2 | | | | |
|-----------|-----|-----|--------|------------|
| ►Input 1 | --- | 3 | 0% | +100%+100% |
| Input 2 | fr | --- | 0% | +100%+100% |
| Input 3 | fr | --- | 0% | +100%+100% |
| Input 4 | fr | --- | 0% | +100%+100% |
| ▼ | ↙ | ↙ | Offset | - travel + |

The control center for the given control, i.e. its zero point, can be changed in this column. The adjustment range lies between -100% and +100%.

Simultaneously tapping on the ▲▼ or ◀▶ keys of the right touch pad (**CLEAR**) will reset the value displayed in inverse video back to its "0%" value. Leave the offset setting at 0% while making switch assignments.

Column 3, "-travel+"

| MULTICH 2 | | | | |
|-----------|-----|-----|--------|------------|
| ►INPUT 1 | --- | 3 | 0% | +100%+100% |
| INPUT 2 | fr | --- | 0% | +100%+100% |
| INPUT 3 | fr | --- | 0% | +100%+100% |
| INPUT 4 | fr | --- | 0% | +100%+100% |
| ▼ | ↙ | ↙ | offset | - travel + |

Finally, transmitter control travel is set for both sides in the rightmost column "-travel+". The range for this lies between -100% and +100%. To accomplish this, push or turn the respective transmitter control in the given direction. This will set the "travel" for each given direction individually.

If the assignment is for a switch, leave the setting at the default value of 100%.

Note:

Due to technical reasons, servos connected to a 1/4 C NAUTIC Multi-Prop mini decoder may operate somewhat hesitatingly. This is not a fault.

Connection notes for the Nautic-Expert switching module, order no. 4159

As many as 16 switched functions can be controlled per switching module.

Eight loads, like lamps, LEDs, etc.–but not electric motors–, with a load current of up to 0.7 A each can be connected directly.

Two switch functions per connector socket are possible via the three conductor cable, order no. 3941.6 , see bottom right figure.

Electric motors and loads drawing substantial current should be connected by other means, e.g. via switching modules. Ask your dealer about this.

Connection example with the Graupner HoTT GR-16 receiver

Before first time operation of the NAUTIC modules make the above described settings.

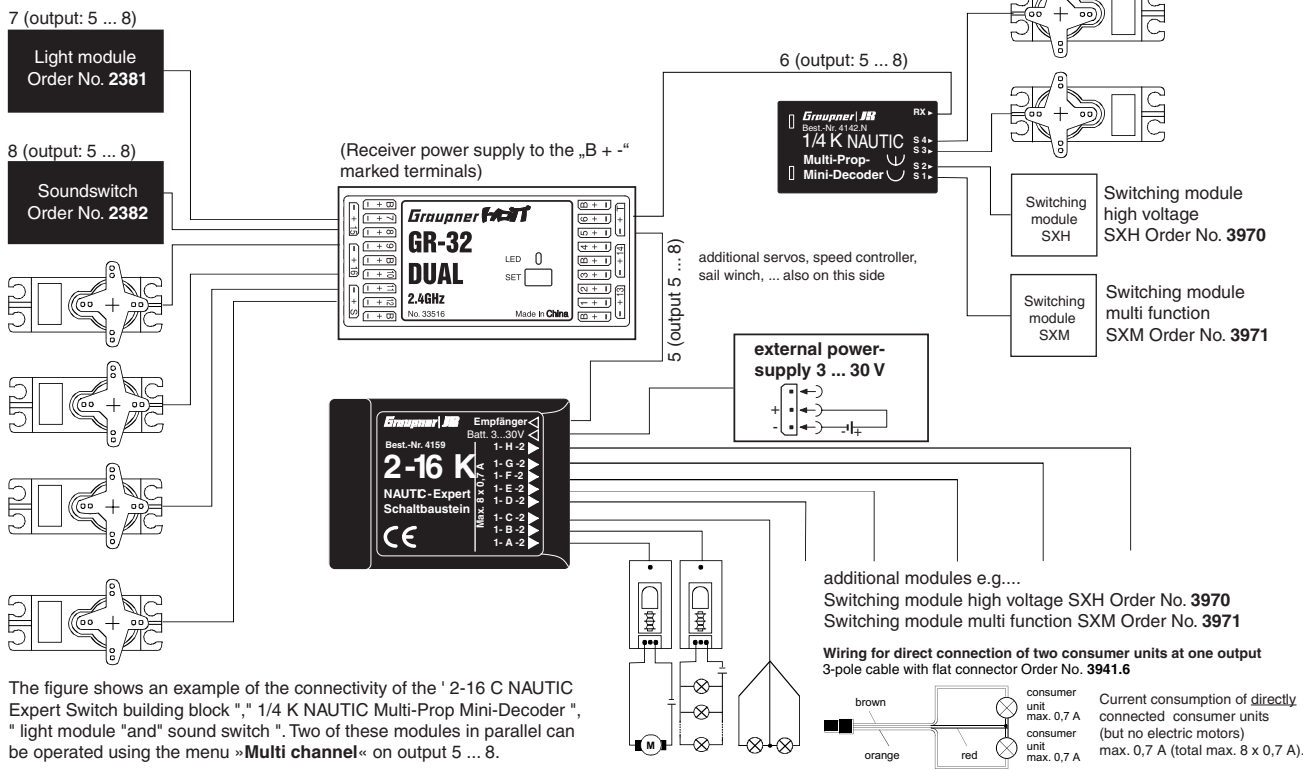

Ring Limiter

Control of Voith Schneider propellers in model ships

Scroll with the selection keys on the left or right touch pad to the menu option »Ring limiter« in the multi-function menu:

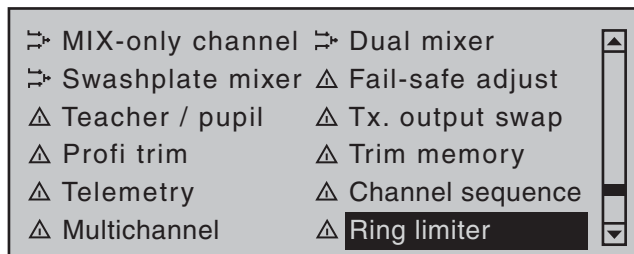
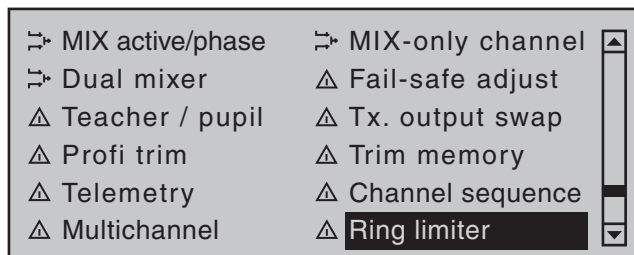

Tap briefly on the center **SET** key of the right touch pad to open this menu option:

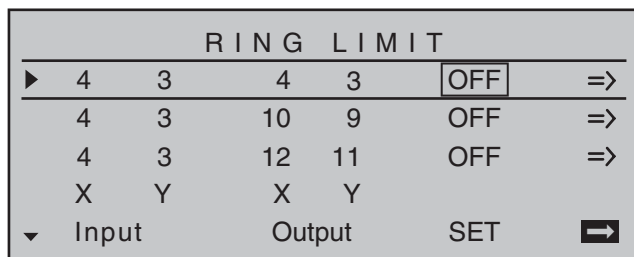

This »Ring limiter« is primarily intended for the control of up to three so-called Voith Schneider propellers in ship models. These are positioned beneath the ship where they are exposed to a free flow of water in all directions. The control of these drives and turning their vertically oriented propeller blades is done with two servos per Voith Schneider

propulsion unit whereby, for mechanical reasons, the propellers of this type offered by *Graupner* under order nos. **2358** and **2358.BL** have a maximum control travel limitation of 4 mm each.

As long as the joysticks for forward/reverse and left/right are operated individually (see section "Column Input") this is no problem because travel for the two servos can be appropriately adjusted, both mechanically as well as in the »Servo adjustment« menu. However, this becomes problematic when, for example, one joystick is 100% forward and, *at the same time*, the other joystick is pushed completely to the right to arithmetically produce a 141% sum for the two servo travel vectors. The mechanical controls of the Voith Schneider propellers will collide with their limits; in best case only drawing an unnecessary amount of electric current, in worst case causing damage or even bursting the linkage..

In order to avoid this problem, the **MC-20** HoTT transmitter has a maximum of three "ring limiters" available in the "SET" column of this option's first display page (see figure at left) that can be switched "ON" or "OFF" individually. In the first line on the setting page for a given "ring limiter", its maximum travel can then be set for a range of between 25 and 125%. The second line provides a setting for the size of limitation of overall deflection between:

- 0% circular limit ()
- 100% no limit ()
- (limitation is strictly a matter of the given joystick's mechanical stop)

Important notice:
When this function is used, leave the respective setting values in the »Dual Rate / Expo« and »Servo adjustment« menus at 0 and 100% or reset them back to their default values.

The adjacent sketch illustrates the effect for a 0% setting. The cross-hatched area of travel is curtailed and appears as a "dead zone".



Column, "Input"

With the standard preset control mode 1, all three ring limiters are pre-assigned to inputs 3 (forward/reverse) and 4 (left/right) which are actuated by the left joystick. However, this pre-assignment can be replaced anytime by any other transmitter control combination. Use the selection keys on the left or right touch pad to move the marker frame to the desired value field then briefly tap the center **SET** key of the right touch pad:

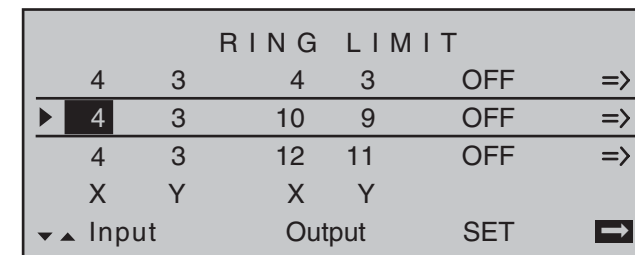

Select the desired control channel (1 ... 12) for the value field now displayed in inverse video by using the ▲▼ or ◀▶ selection keys. However, do not forget that if a control channel in the range of 5 ... 12 is selected, it must also be assigned to a control in the »Control adjust« menu, see page 108. Briefly tap the center **ESC** of the left touch pad or the center **SET** key of the right touch pad to conclude your entry. In principle, the other inputs are to be handled in the same manner.

A tap on the ▲▼ or ◀▶ keys of the right touch pad at the same time (**CLEAR**) will reset the active value field back to its given default value.

Column, "Output"

The three ring limiters are pre-assigned to receiver outputs 3/4, 9/10 and 11/12 by default, whereby the outputs in column "X" are for the forward/reverse function and the outputs in column "Y" are for the left/right function. However, this preset combination of receiver outputs can be replaced as necessary by any other combination at any time. This is essentially done in the same manner as described previously under "Input", for example:

| RING LIMIT | | | | | |
|------------|---|--------|---|-----|----|
| 4 | 3 | 4 | 3 | OFF | => |
| 4 | 3 | 10 | 9 | OFF | => |
| ▶ 4 | 3 | 6 | 7 | OFF | => |
| X | Y | X | Y | | |
| ▲ Input | | Output | | SET | ➡ |

Note:
Watch out for undesirable overlaps if you use one of the outputs within a mixer.

Column, "SET"

The **SET** column is used to determine just which of the ring limiters is to be "OFF" and which are to be "ON", i.e. active. Use the selection keys on the left or right touch pad to move the marker frame to the desired value field in the **SET** column then briefly tap the center **SET** key of the right touch pad:

| RING LIMIT | | | | | |
|------------|---|--------|---|-----|----|
| 4 | 3 | 4 | 3 | OFF | => |
| 4 | 3 | 10 | 9 | OFF | => |
| ▶ 4 | 3 | 6 | 7 | OFF | => |
| X | Y | X | Y | | |
| ▲ Input | | Output | | SET | ➡ |

In the value field now displayed in inverse video, make a choice between the two options, "ON" and "OFF", with the ▲▼ or ◀▶ selection keys then conclude the entry with a brief tap on the center **ESC** key of the left touch pad or on the center **SET** key of the right touch pad.

A tap on the ▲▼ or ◀▶ keys of the right touch pad at the same time (**CLEAR**) will reset the active value field back to its "OFF" default value.

Column

| RING LIMIT | | | | | |
|------------|---|--------|---|-----|----|
| ▶ 4 | 3 | 4 | 3 | ON | => |
| 4 | 3 | 10 | 9 | ON | => |
| 4 | 3 | 6 | 7 | ON | => |
| X | Y | X | Y | | |
| ▼ Input | | Output | | SET | ➡ |

Following a selection of one of the three lines with the selection keys, switch to the settings page for the selected ring limiter (1 ... 3) with a brief tap on the center **SET** key of the right touch pad.

| Ring Limit 1 | | VSP OUT X | | VSP OUT Y | |
|--------------|------|-----------|--|-----------|--|
| CH 4 | CH 3 | + | | 0% | |
| ▶ 100% | 100% | 0% | | 0% | |
| 0% | 0% | max-X | | 0% | |

If, however, the small diamond at the center of the circle in the figure above (which represents the current joystick position) is not visible ...

| Ring Limit 1 | | VSP OUT X | | VSP OUT Y | |
|--------------|------|-----------|--|-----------|--|
| CH 4 | CH 3 | + | | 0% | |
| ▶ 100% | 100% | 0% | | 0% | |
| 0% | 0% | max-X | | 0% | |

... then the respective ring limiter is still switched "OFF". In this case, switch back to the previous page with a brief tap on the center **ESC** key of the left touch pad then switch the respective ring limiter "ON" as previously described.

Programming procedure

The two upper value fields –labeled at the bottom left of the display as "max-X" or "max-Y", depending on the position of the marker frame– are used to specify separate settings for each of the two control functions, "left/right" and "forward/reverse" within a range of 25 ...

| Ring Limit 1 | | VSP OUT X | | VSP OUT Y | |
|--------------|------|-----------|--|-----------|--|
| CH 4 | CH 3 | * | | 0% | |
| ▶ 25% | 100% | 0% | | 0% | |
| 0% | 0% | max-X | | 0% | |

... and 125%:

| Ring Limit 1 | | VSP OUT X | | VSP OUT Y | |
|--------------|------|-----------|--|-----------|--|
| CH 4 | CH 3 | * | | 0% | |
| ▶ 125% | 100% | 0% | | 0% | |
| 0% | 0% | max-X | | 0% | |

In practice, the setting is made by changing the given value until the respective servos in the model just reach the point where they no longer move.

A tap on the ▲▼ or ◀▶ keys of the right touch pad at the same time (**CLEAR**) will reset the changed value in the active value field back to its "100%" default value.

In the next line down—labeled at the bottom left of the display as " <=> -X" or " <=> -Y", depending on the position of the marker frame—the setting values, in a range from 0% and a maximum of 125%, affect the form of limitation between "circular" and "rectangular", whereby a setting value here may never be greater than the value of the field above it.

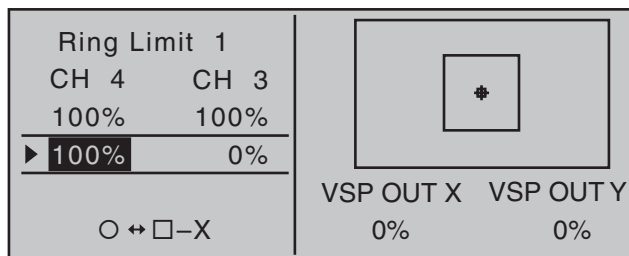
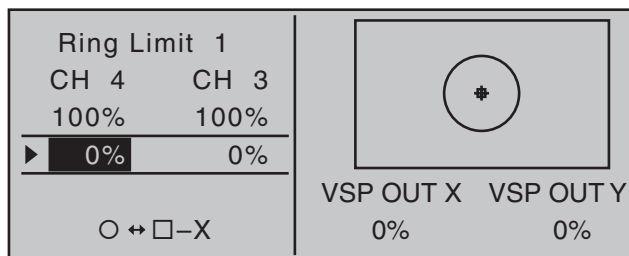

A tap on the ▲▼ or ◀▶ keys of the right touch pad at the same time (**CLEAR**) will reset the changed value in the active value field back to its "0%" default value.

When finished with these settings, switch back to the first display page for this option then repeat this procedure, as applicable, for the lines of ring limiter 2 or 3.

Final note:

This option can, of course, also be used as necessary and applicable for fixed-wing models.

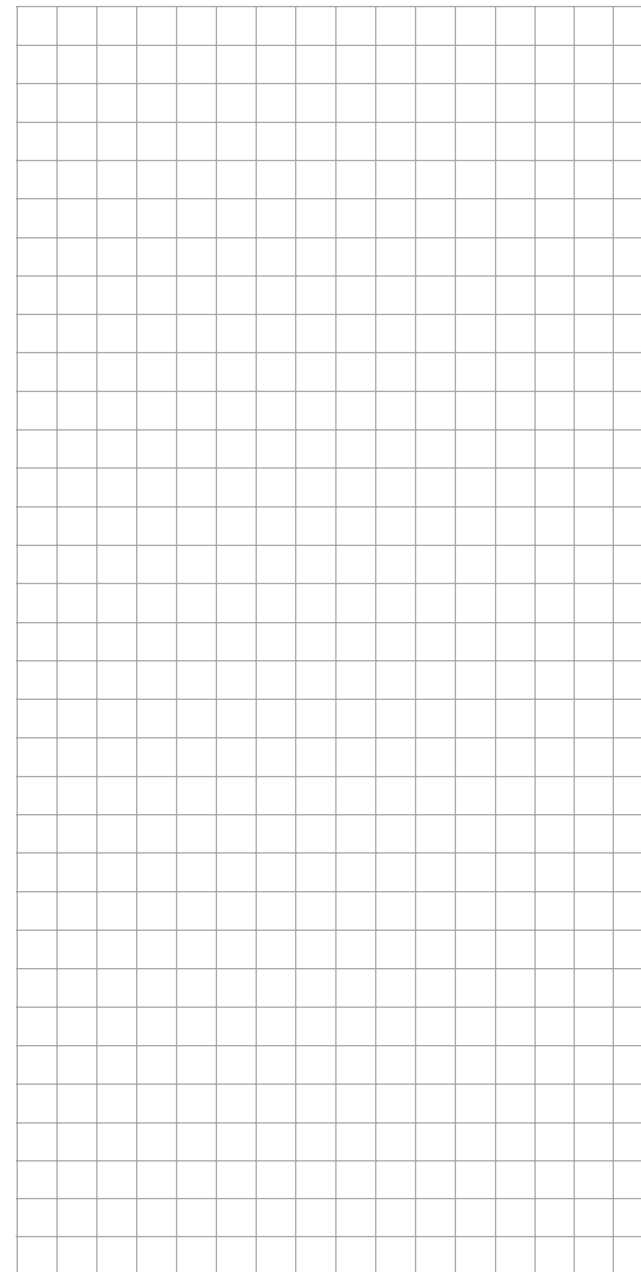

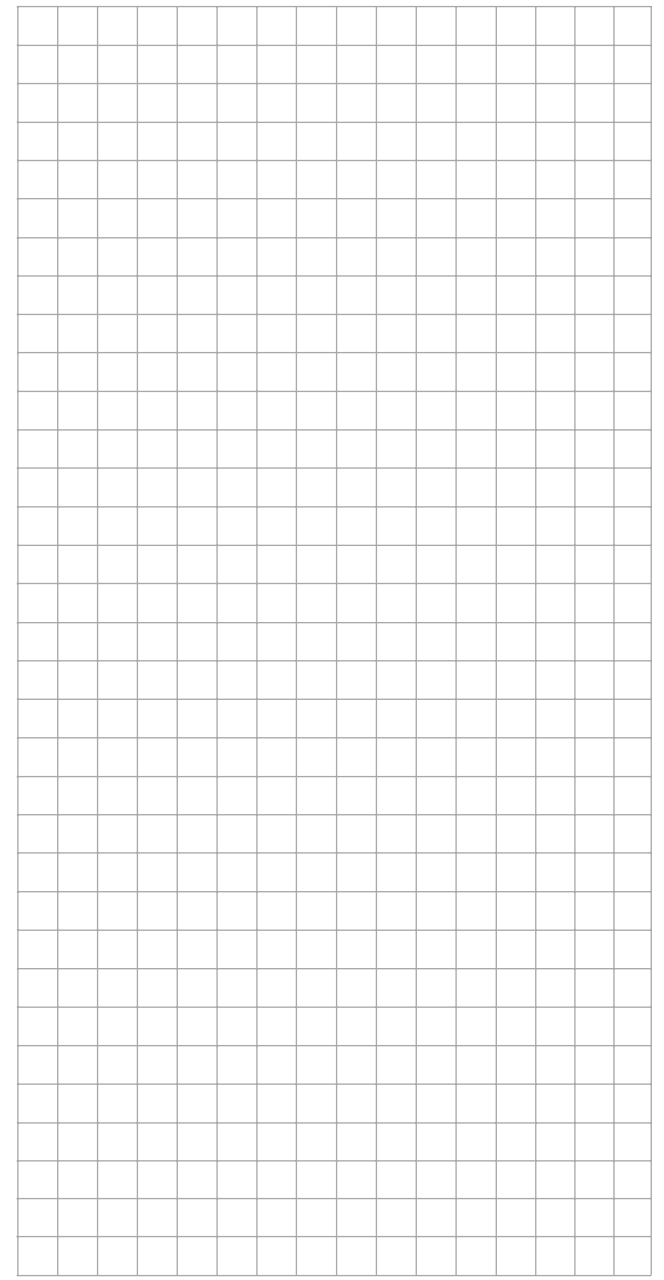
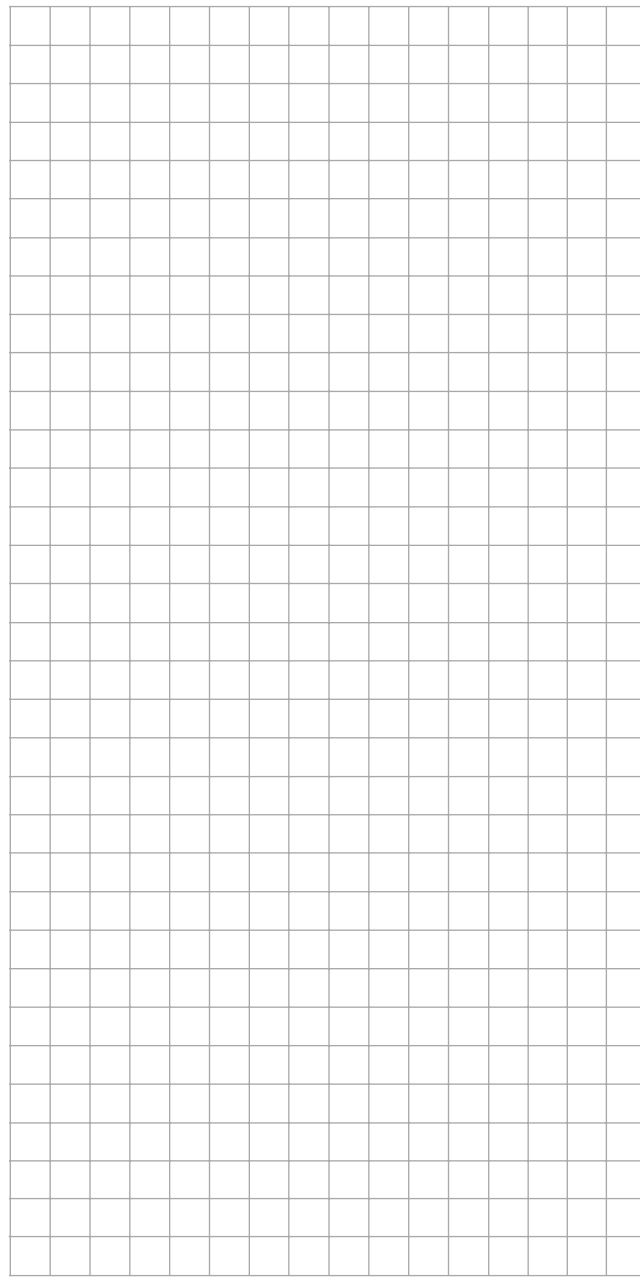
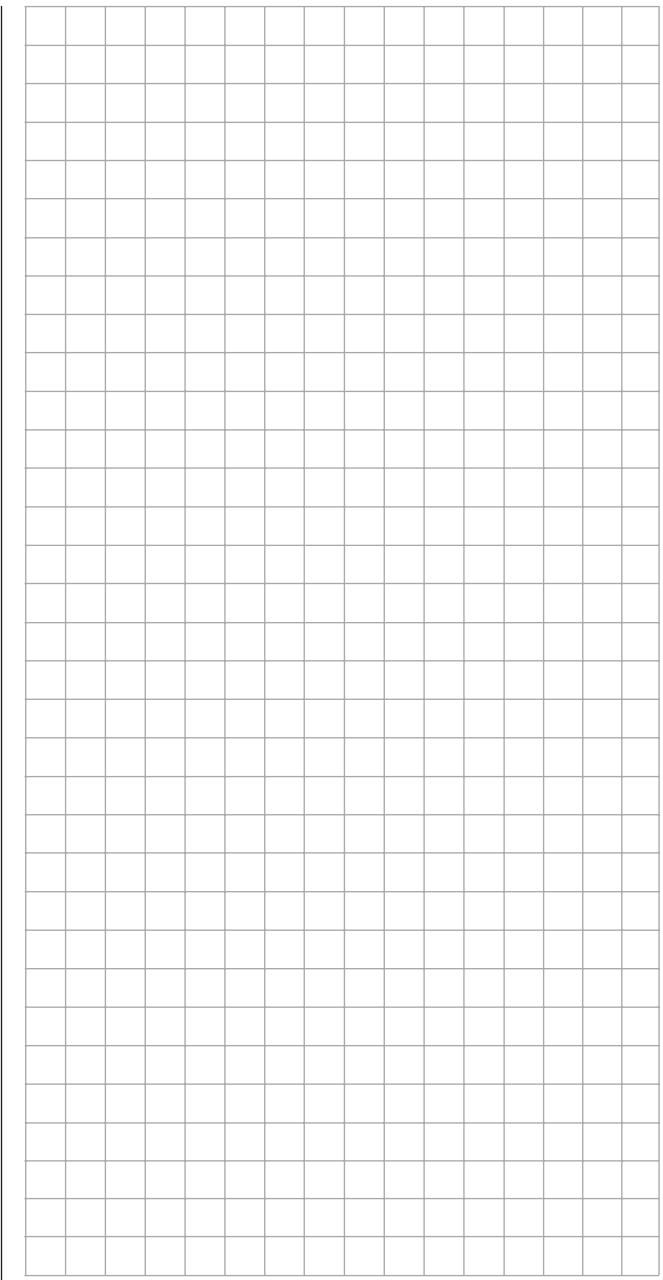

MP3 player

Replay program for MP3 files, such as music files

Scroll with the selection keys on the left or right touch pad to the menu option »Ring limiter« in the multi-function menu:

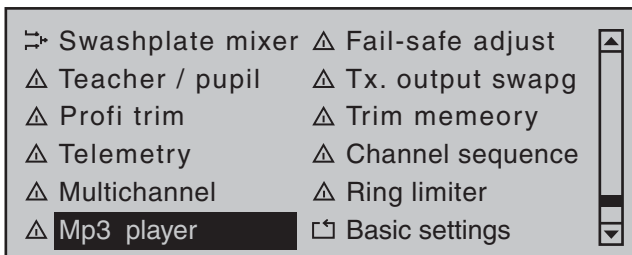
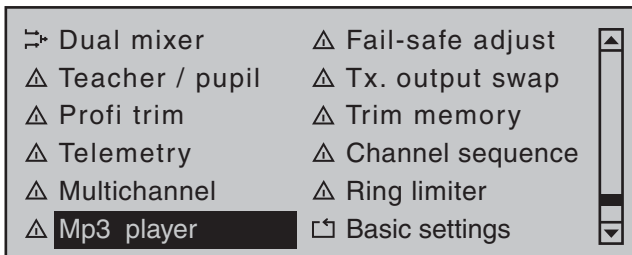

Tap briefly on the center **SET** key of the right touch pad to open this menu option:

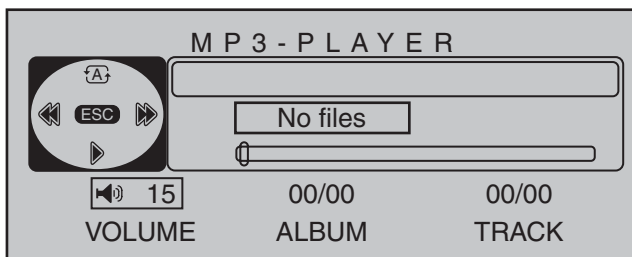

If the message "No files" appears near the middle of the display when this menu option is called then the transmitter has been unable to find any suitable MP3 files on the SD card. If this should happen, use a PC or laptop to check the content of the "MP3" directory on the SD card and copy suitable MP3 files into this directory if it is empty.

Therefore, insert a SD card containing MP3 files in a directory named "MP3" and, after switching the transmitter on, open the »MP3-Player« menu option.

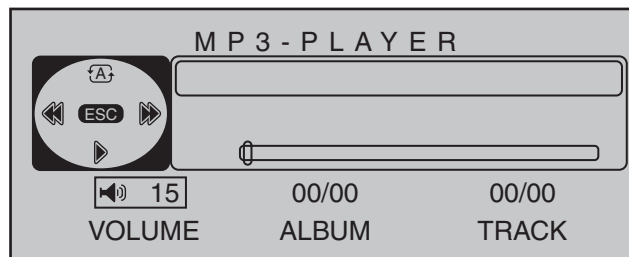

Briefly tap the ▼ key of the left touch pad to start replay of the first MP3 file of album 1. The replay will start immediately, however, the display of data about the number of albums and titles as well as playing time for the current MP3 file—depending on the size of the MP3 file—will only appear after some delay.

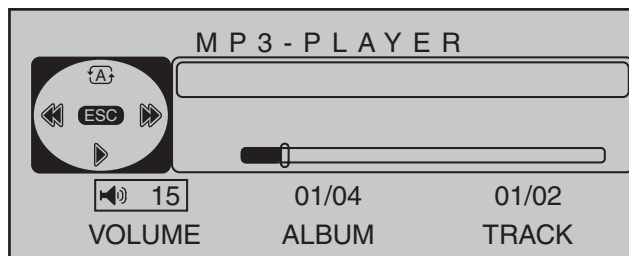

The automatic replay of album 1 will continue to run until it is stopped with a tap on the ▼ key of the left touch pad ...

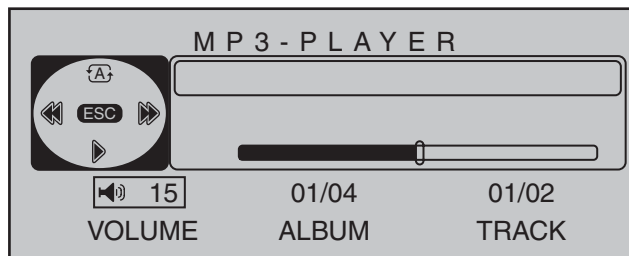

... or the the transmitter is switched off.

During ongoing replay, the menu can be exited at any time and the transmitter can be used without restriction. The ongoing MP3 replay is visualized in the transmitter's basic display by virtue of a "MP3" display label shown at the left of the SD card symbol and an animated triangle beneath that display label.

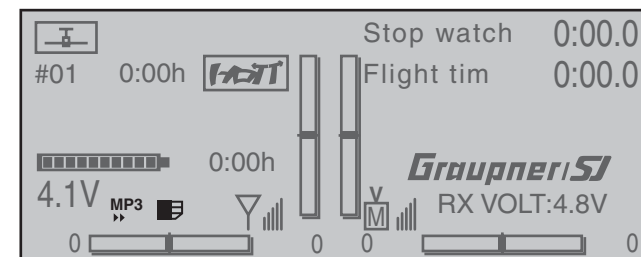

Note:

If voice output is activated it will be blended in with the playing MP3 file.

Volume

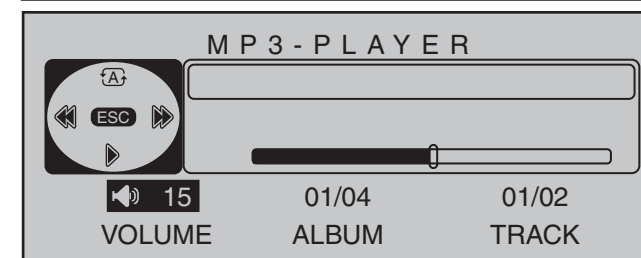

After a tap on the center **SET** key of the right touch pad to activate the value field, the volume of replay can be regulated within a range of "0" (= mute) to "30" (very loud).

Album

Use the selection keys of the *right* touch pad to move to the value field above "ALBUM" and briefly tap the center **SET** key of the right touch pad:

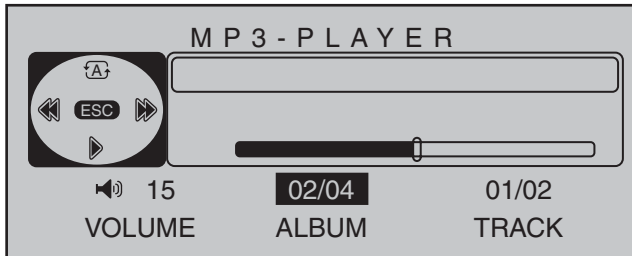

Use the ▲▼ selection keys of the *right* touch pad to select the desired album number (from 1 to a maximum of 10) in this value field. Briefly tap the center **SET** key of the right touch pad to confirm the selection.

Note:

The number of albums is a consequence of the number of files present in subdirectories of the "MP3" directory on the SD card, not the sum of album names which may be stored in identically named meta-data fields of the MP3 file.

Title

Use the selection keys of the *right* touch pad to move to the value field above "TRACK" and briefly tap the center **SET** key of the right touch pad:

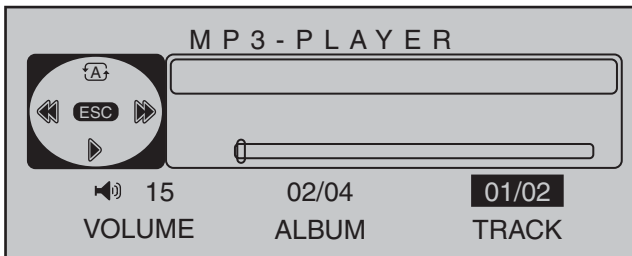

Now select the desire title by using the ▲▼ selection keys on the *right* touch pad. Briefly tap the center **SET** key of the right touch pad to start this selection.



Notes:

- The title displayed will be the filename of the MP3 file, not any identically named title which may be stored in the MP3 file as a meta-data field.
- The number of the title per album is a consequence of the number of MP3 files per directory.

MP3 player operator field

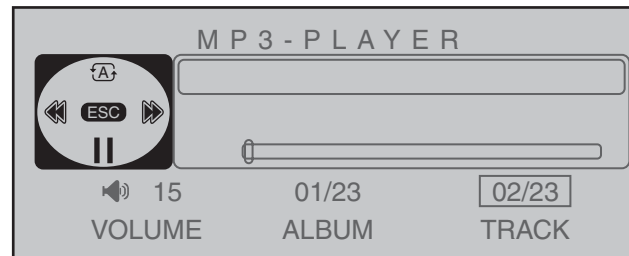

- ◀ ▶ Analogous to corresponding keys on a MP3 and other players, jump one title forward or back for each tap on one of the ◀ ▶ selection keys of the *left* touch pad.
- ▶ / || Analogous to corresponding keys on a MP3 and other players, start and stop the MP3 player with a tap on the ▼ selection keys of the *left* touch pad.
- ⏮ / ⏪ / ⏩ / ⏭ Switch between these three options with the ▲ selection keys of the *left* touch pad.

- ⏮ Replay of the selected album will repeat in an endless loop until it is either stopped or the transmitter is switched off.
- ⏪ Replay of the current title will repeat in an endless loop until it is either stopped or the transmitter is switched off.
- ⏩ Replay will stop automatically at the end of play for the current title.
- ESC** A tap on the center **ESC** key of the left touch pad will exit the menu option *without* stopping any replay that may be running.

Basic settings



Basic transmitter settings

Use the selection keys on the left or right touch pad to scroll to the »**Basic settings**« menu option in the multi-function menu:

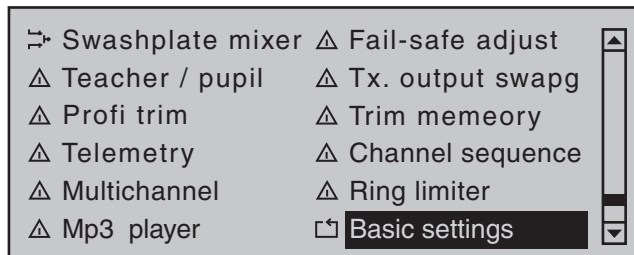
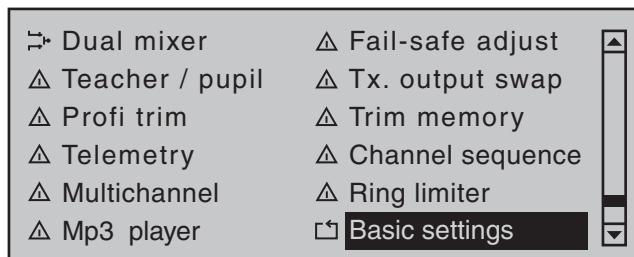

Tap briefly on the center **SET** key of the right touch pad to open this menu option:

| GENERAL BASIC SETTINGS | | | |
|------------------------|------|--------|-------|
| ▶ Voice volume | 7 | fr | --- |
| Vario volume | 7 | fr | --- |
| Touch-beeps vol. | 7 | fr | --- |
| Owners name | < | | > |
| Pre-set stick mode | | 1 | |
| Pre-set modulation | | HoTT | |
| Pre-set DSC Output | | PPM10 | |
| Pre-set Pitch min | | rear | |
| Top LCD Contrast | | 0 | |
| Bottom LCD Contrast | | 0 | |
| Display light | | unlim. | |
| Power-on/off beep | | yes | |
| Battery type | | Li-Io | |
| Battery warning | | 3.60V | |
| Stick warning: | | unlim. | |
| Touch Sense | | 2 | |
| Region | | EURO | |
| Own phase name | 1 < | | > |
| Own phase name | 2 < | | > |
| ⋮ | ⋮ < | | > |
| Own phase name | 10 < | | > |
| ▼ | | SEL | SEL / |

Basic settings are made in this menu. Transmitter-specific settings, such as volume regulation for acoustic signals and voice messages output via the built-in speaker or headset connector, the owner's name, country setting and even specifications for new model memories. The settings made in this menu on the lines ...

- "Pre-set stick mode",
- "Pre-set modulation",
- "Pre-set DSC Output" and
- "Pre-set Pitch min"

... therefore have no influence whatsoever on already existing model memories; instead, they are only *defaults* which are automatically adopted into newly initialized model memories and can be changed there individually at any time in the »**Basic settings, model**« and »**Helicopter type**« menus. A change to the "Pre-set" settings in value fields of *this* menu therefore only affects *those model memories created new at a later time*.

Note:

The settings in this menu are only specified once in the entire transmitter. Therefore, after opening this menu in another model memory, the last valid settings always appear.

Select the desired line with the ▲▼ selection keys of the left or right touch pad then tap the center **SET** key of the right touch pad. The value in the field now displayed in inverse video can be changed. After a change has been made, the entry can be concluded with another tap on the center **SET** key of the right touch pad or the center **ESC** key of the left touch pad.

Voice volume / Vario volume / Touch-beeps vol.

| GENERAL BASIC SETTINGS | | | |
|------------------------|---|-----|-------|
| Voice volume | 7 | fr | --- |
| Vario volume | 7 | fr | --- |
| ▶ Touch-beeps vol. | 7 | fr | --- |
| Owners name | < | | > |
| ▼▲ | | SEL | SEL / |

These three lines can be used to individually set the volume of the three groups of acoustic signals and voice messages. This involves selection from among a total of three variants, whereby each of the variants offer two or three options for individually regulating volume even after leaving this menu.

Pre-setting a value

Use the selection keys on the left or right touch pad to move the marker frame to the desired value field in the column above the left **SEL** at the display's lower edge then briefly tap the center **SET** key of the right touch pad. The desired volume for the selected group can be specified in increments between 0 and 10 in the value field now displayed in inverse video by using the selection keys of the left or right touch pad. Another tap on the center **SET** key of the right touch pad or the **ESC** key of the left touch pad will conclude the process.

Following a simultaneous tap on the ▲▼ or ◀▶ keys of the right touch pad (**CLEAR**), the display will return to its "7" default value.

via rotary control

Use the selection keys on the left or right touch pad to move the marker frame to the desired value field in the column above the right **SEL** label at the display's lower edge then briefly tap the center **SET** key of the right touch pad. The message shown below will then appear in the display:

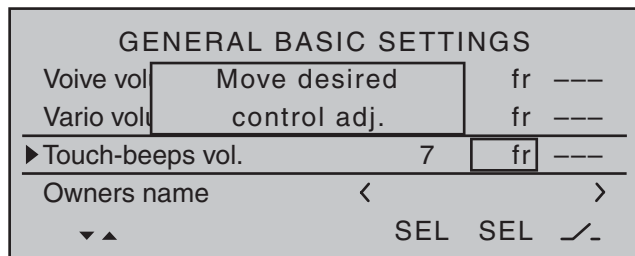

Now turn the desired rotary control, for example, the right retractable knob DG2. Afterward, this knob can be used anytime to incrementally regulate volume for the selected group between 0 and 10.

Following a simultaneous tap on the ▲▼ or ◀▶ keys of the right touch pad (**CLEAR**), the display will return to its "fr" default value.

via three position switch

Use the selection keys on the left or right touch pad to move the marker frame to the column above the switch symbol at the display's lower edge then briefly tap the center **SET** key of the right touch pad. The message shown below will then appear in the display:

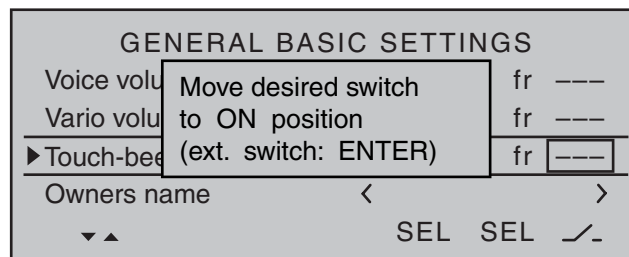

Now, assign a switch as described on page 56 in the section "Assigning transmitter controls, switches and control switches". Ideally a self-neutralizing three position switch, e.g. like that offered by *Graupner* under order no. **33001.5**. Afterward, this switch can be used anytime to incrementally regulate volume for the selected group between 0 and 10.

Following a simultaneous tap on the ▲▼ or ◀▶ keys of the right touch pad (**CLEAR**), the display will return to its "---" default value.

Owner

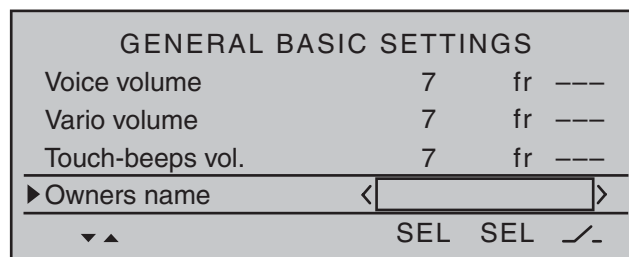

Up to 15 characters can be used to specify the owner's name. Change to the next screen page (▶) with a brief tap on the center **SET** key of the right touch pad:

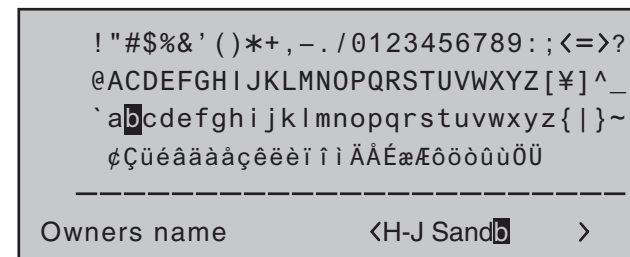

Select the desired characters with the selection keys of the left touch pad. With a brief tap on the ▶ selection key of the right touch pad or its center **SET** key, move to the next position in which a character can be selected. A simultaneous tap on the ▲▼ or ◀▶ keys of the right touch pad (**CLEAR**) will place a space character at the current position.

Positioning to any character position within the entry field can be done with the ◀▶ keys of the right touch pad.

A brief tap on the center **ESC** key of the left touch pad will cause a return to the previous menu page.

Pre-set stick mode

As a basic principle, there are four different ways to assign the four control functions, aileron, elevator, rudder and throttle or brake flaps for winged models as well as rolling, pitching, tail rotor and throttle/pitch for helicopter models to the two joysticks. Just which of these options is chosen depends on the individual preferences of the individual model pilot.

Use the ▲▼ selection keys of the left or right touch pad to select the "Stick mode" line. The option field will be framed.

| GENERAL BASIC SETTINGS | | | |
|------------------------|---------------------|-----|-----|
| Voice volume | 7 | fr | --- |
| Vario volume | 7 | fr | --- |
| Owners name | < H-J Sandbrunner > | | |
| ► Pre-set stick mode | 1 | | |
| | | SEL | |

Tap on the **SET** key briefly. The currently displayed stick mode will be displayed in inverse video. Now use the selection keys of the right touch pad to select the variant, from 1 to 4, you most frequently use. In the future this will be used for newly initialized model memories, but can be changed on an individual basis for up to 80 model memories.

Following a simultaneous tap on the ▲▼ or ◀▶ keys of the right touch pad (**CLEAR**), the display will return to stick mode "1".

With another tap on the **SET** key, the selection field will be deactivated again to permit a change to another line.

Winged model stick mode

| "MODE 1" (Throttle at right stick) | | "MODE 2" (Throttle at left stick) | |
|------------------------------------|---------------|-----------------------------------|---------------|
| elev. down | full throttle | full throttle | elev. down |
| left rudder | right rudder | left rudder | right rudder |
| elev. up | idle | idle | elev. up |
| left aileron | right aileron | left aileron | right aileron |
| "MODE 3" (Throttle at right stick) | | "MODE 4" (Throttle at left stick) | |
| elev. down | Motor Vollgas | full throttle | elev. down |
| left aileron | right rudder | left aileron | right rudder |
| elev. up | idle | idle | elev. up |
| left aileron | right rudder | left aileron | right rudder |

Helicopter model stick mode

| "MODE 1" (Throttle at right stick) | | "MODE 2" (Throttle at left stick) | |
|------------------------------------|-------------|-----------------------------------|------------|
| pitch axis | throttle | throttle | pitch axis |
| tail rotor | roll | tail rotor | roll |
| pitch axis | throttle | throttle | pitch axis |
| "MODE 3" (Throttle at right stick) | | "MODE 4" (Throttle at left stick) | |
| pitch axis | Motor/Pitch | throttle | pitch axis |
| roll | tail rotor | roll | tail rotor |
| pitch axis | throttle | throttle | pitch axis |

Pre-set modulation

Standard equipment for the **RC-20** transmitter includes a HoTT transmitter module and, under the right front cover—as viewed from the front—a connector socket for an external RF module, see page 25. Additionally, a transmitter-internal iFS RF module can be installed and connected. On a model-specific basis, the transmitter can be set to use the modulation of any one of these three RF modules by appropriately selecting "HoTT", "EXT. PPM" or "INT. PPM" in the "Pre-set modulation" line of the »**Basic settings, model**« menu. The most frequently used variant should logically be selected for the "Pre-set modulation" line in the "General Basic Settings" menu. In the future this will be used for newly initialized model memories, but can be changed on an individual basis for up to 80 model memories.

Briefly tap the center **SET** key of the right touch pad:

| GENERAL BASIC SETTINGS | | | |
|------------------------|---------------------|-----|-----|
| Touch-beeps vol. | 7 | fr | --- |
| Owners name | < H-J Sandbrunner > | | |
| Pre-set stick mode | 1 | | |
| ► Pre-set modulation | HoTT | | |
| | | SEL | |

Now use the selection keys of the right touch pad to select the variant from among "HoTT", "EXT. PPM" and "INT. PPM".

A simultaneous tap on the ▲▼ or ◀▶ keys of the right touch pad (**CLEAR**) will return the display back to modulation "HoTT".

With a brief tap on the **SET** or **ESC** key, the selected field is deactivated to permit a switch to another line.

Pre-set DSC Output

In the line with the same name in the »**Basic settings, model**« menu, a separate specification can be made from among the available modulation types which is specific to each model memory and will then be provided at the DSC socket. This choice primarily influences the maximum number of control channels which can be attached to the DSC (direct servo control) socket, and thus also available to a flight simulator or teacher/pupil system. By selecting "PPM10" this will be control channels 1 ... 5, for "PPM16" channels 1 ... 8, for "PPM18" channels 1 ... 9 and for "PPM24" channels 1 ... 12.

| BASIC SETTING, MODEL | | | |
|----------------------|-------|-----|---------|
| Rcv Ch Map | R16 | R08 | n/a n/a |
| RF transmit | on | | |
| RF range test | 99s | | |
| ► DSC Output | PPM10 | | |
| | | SEL | |

In a manner similar to "Pre-set stick mode, in this »General basic settings« menu the selection made for the "Pre-set DSC Output" line will determine which of the four possible modulation types will be adopted as the *default* variant for a newly initialized model memory.

If necessary, use the ▲▼ selection keys of the left or right touch pad to switch to the "DSC Output" line then, with a brief tap on the center **SET** key of the right touch pad, activate the value window:

| GENERAL BASIC SETTINGS | |
|------------------------|---------------------|
| Owners name | < H-J Sandbrunner > |
| Pre-set stick mode | 1 |
| Pre-set modulation | HoTT |
| ▶Pre-set DSC Output | PPM10 |
| ▼▲ | SEL |

Now a choice can be made from among the four possible modulation types: "PPM10", "PPM16", "PPM18" and "PPM24", with the selection keys of the right touch pad. Another tap on the center **SET** key of the right touch pad will conclude the entry.

A simultaneous tap on the ▲▼ or ◀▶ keys of the right touch pad (**CLEAR**) will reset this option back to "PPM10".

Pre-set Pitch min (only relevant to helicopter models)

In a manner similar to the previously described options "Stick mode" and "DSC Output", enter the preferred actuation direction for the throttle/pitch joystick on this line so the choice will already be present by default for model memories newly initialized in the future. The functionality of all other helicopter program options (to the extent they affect throttle and/or pitch) are dependent on this setting; in other words the throttle curve, idle trim, Channel 1 →

tail rotor mixer, etc.

This means:

- "**fwd.**": minimum front pitch setting, the pitch joystick (C1) points away from the pilot.
- "**back**": minimum rear pitch setting, the pitch joystick (C1) points towards the pilot.

A simultaneous tap on the ▲▼ or ◀▶ keys of the right touch pad (**CLEAR**) will set this option to "rear".

Note:

The C1 joystick's control direction for "Throttle min front/rear" in the fixed-wing program can be changed individually in the »Model type« menu.

Contrast, upper display / lower display

In assure optimal legibility of **RC-20** HoTT displays under all weather and temperature conditions, their contrast settings can be adjusted separately.

Contrast for the forward display, located between the switch panels, is adjusted by selecting the "Top LCD contrast" line with the selection keys of the left or right touch pad then briefly tapping on the center **SET** key of the right touch pad.

| GENERAL BASIC SETTINGS | |
|------------------------|----------|
| Pre-set DSC Output | PPM10 |
| Pre-set Pitch min. | rear |
| ▶Top LCD contrast | 0 |
| Bottom LCD contrast | 0 |
| ▼▲ | SEL |

Now display contrast can be adjusted in the value field displayed in inverse video within a range of ±20 by using the selection keys of the right touch pad.

| | | | |
|---------|-------|---------|--------|
| RX-S | QUA | : 100% | |
| RX-S | STR | : 100% | |
| RX | dBm | : 33dBm | |
| TX | dBm | : 33dBm | |
| L-PACK | | : 10ms | |
| RX-VOLT | : 4.8 | TMP | |
| R-LOW V | : 4.6 | | +22 °C |

| | | | |
|---------|-------|---------|--------|
| RX-S | QUA | : 100% | |
| RX-S | STR | : 100% | |
| RX | dBm | : 33dBm | |
| TX | dBm | : 33dBm | |
| L-PACK | | : 10ms | |
| RX-VOLT | : 4.8 | TMP | |
| R-LOW V | : 4.6 | | +22 °C |

Contrast for the rear display, located between the touch pads, is adjusted by selecting the "Bottom LCD contrast" line with the selection keys of the left or right touch pad then briefly tapping on the center **SET** key of the right touch pad.

| GENERAL BASIC SETTINGS | |
|------------------------|----------|
| Pre-set DSC Output | PPM10 |
| Pre-set Pitch min. | rear |
| Top LCD contrast | 0 |
| ▶Bottom LCD contrast | 0 |
| ▼▲ | SEL |

Now display contrast can be adjusted in the value field displayed in inverse video within a range of ±20 by using the selection keys of the right touch pad.

| | | |
|-----------------|-------------|--------------|
| Graubele | Stop watch | 0:00.0 |
| #01 0:00h | Flight tim | 0:00.0 |
| H-J Sandbrunner | | |
| 0:00h | | |
| 4.1V | | |
| | Graupner/SJ | RX VOLT:4.9V |

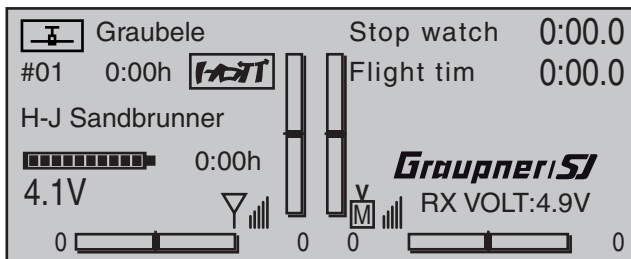

Simultaneously tapping the ▲▼ or ◀▶ selection keys of the right touch pad (**CLEAR**) will reset the inverse video field back to "0".

Display light

This line determines how long the transmitter display's backlight illumination is to remain on after switching the transmitter on or after the last activation of a transmitter operating element.

Available options are "unlim(ited)", "30 s", "60 s", "120 s" and "off".

A simultaneous tap on the ▲▼ or ◀▶ selection keys of the right touch pad (**CLEAR**) will reset the inverse video field to "unlimited".

Power on/off beep

A power on/off beep for the transmitter can be switched on ("yes") and off ("no") in this line.

A simultaneous tap on the ▲▼ or ◀▶ selection keys of the right touch pad (**CLEAR**) will switch this option shown in inverse video back to "yes".

Battery type

| GENERAL BASIC SETTINGS | |
|------------------------|--------|
| Bottom LCD contrast | 0 |
| Display light | unlim. |
| Power-on/off beep | yes |
| ▶ Battery type | Li-lo |
| ▼ ▲ | SEL |

This line specifies whether transmitter power is provided by a four-cell NiMH battery or a single-cell LiPo battery. As a consequence of this setting, the next line will offer a suitable voltage range for the "Battery warning" threshold.

A simultaneous tap on the ▲▼ or ◀▶ selection keys of the right touch pad (**CLEAR**) will switch this option shown in inverse video back to "Lith.".

Battery warning threshold

| GENERAL BASIC SETTINGS | |
|------------------------|--------|
| Display light | unlim. |
| Power-on/off beep | yes |
| Battery type | Li-lo |
| ▶ Battery warning | 3.60V |
| ▼ ▲ | SEL |

You can arbitrarily specify the warning threshold for the display ...

Batt. must be re-charged!!

... –contingent on the battery type selection in the line above –in increments of 0.01 volt between 4.50 and 5.50 V (NimH battery) or 3.40 and 4.20 V (Lilo/LiPo battery). Make sure that you do not enter a value which is too low, so that you still have sufficient time to safely land your model in the event of a battery warning.

A simultaneous tap on the ▲▼ or ◀▶ selection keys of the right touch pad (**CLEAR**) will switch the field shown in inverse video back to its factory setting, 4.70 V (NiMh) or 3.60 V (Lith.).

Power-on warning

| GENERAL BASIC SETTINGS | |
|------------------------|-------|
| Power-on/off beep | yes |
| Battery type | Li-lo |
| Battery warning | 3.60V |
| ▶ Stick warning | unlim |
| ▼ ▲ | SEL |

In this line you can determine how long the transmitter should wait after the last actuation of an operating element until the activation of an optical and acoustic power-on warning before the transmitter switches off automatically one minute later.

The values "unlim(ited)", "30 s" and 1, 5, 10, 20, 30 and 60 minutes are optional selections.

A simultaneous tap on the ▲▼ or ◀▶ selection keys of the right touch pad (**CLEAR**) will reset the inverse video field to "unlimited".

Note:

To restart the transmitter after an automatic shut-off, first push the transmitter's power switch to the right into its "OFF" position then, after about five seconds, again into its "ON" position (toward the antenna).

Touch Sense

| GENERAL BASIC SETTINGS | |
|------------------------|-------|
| Battery type | Li-lo |
| Battery warning | 3.60V |
| Stick warning | unlim |
| ▶ Touch Sense | 2 |
| ▼ ▲ | SEL |

In this line you can select the touch sensitivity of the touch pads in a range from 1 to 10. The lower this number is, the more sensitive the touch pad will be to taps and vice versa.

A simultaneous tap on the ▲▼ or ◀▶ selection keys of the right touch pad (**CLEAR**) will reset the field shown in inverse video back to "2".

Region

| GENERAL BASIC SETTINGS | |
|------------------------|-------|
| Battery warning | 3.60V |
| Stick warning | unlim |
| Touch sense | 2 |
| ▶ Region | EURO |
| ▼ ▲ | SEL |

The region is needed for compliance with various regulations (FCC, ETSI, IC etc.). In France, for example, the operation of a remote control is only permitted within a limited frequency band. Therefore, region **MUST be changed to "France" for the transmitter whenever it is operated in France**. In no case may the Universal/EURO mode be used in France!

A simultaneous tap on the ▲▼ or ◀▶ selection keys of the right touch pad (**CLEAR**) will reset the field shown in inverse video back to "Euro".

Own phase name 1 ... 10

| GENERAL BASIC SETTINGS | |
|------------------------|-------|
| Stick warning | unlim |
| Touch sense | 2 |
| Region | EURO |
| ▶ Own phase name 1 | < > |
| ▼ ▲ | → |

Up to ten phase names can be freely specified for one's own use. Each of these can be up to 7 characters long. The characters of the name are assembled by selecting them from a list. In addition to the standard names, these additional names will then also be available in all model memory locations.

If possible, new phase name entries should begin with the "Own phase name 1" line.

Change to the character table with a brief tap on the center **SET** key of the right touch pad:

| | | |
|--|-----|---|
| ! " # \$ % & ' () * + , - . / 0 1 2 3 4 5 6 7 8 9 : ; < = > ? | | |
| @ | A | B C D E F G H I J K L M N O P Q R S T U V W X Y Z [\] ^ _ |
| ` | a | b c d e f g h i j k l m n o p q r s t u v w x y z { } ~ |
| ø | Ç | ü é á à å ä ç è é ê ì í î ï Ä Å Æ æ ö ø ù ü Õ Ü |
| ----- | | |
| Own phase name | < A | > |

Now the desired characters can be selected with the selection keys of the left touch pad. With a brief tap on the ▶ selection key of the right touch pad or its center **SET** key, move to the next position in which a character can be selected. A simultaneous tap on the ▲▼ or ◀▶ keys of the right touch pad (**CLEAR**) will place a space character at the current position. Positioning to any character position within the entry field can be done with the ◀▶ keys of the right touch pad.

A return to the previous menu page is accomplished with a brief tap on the center **ESC** key of the left touch pad.

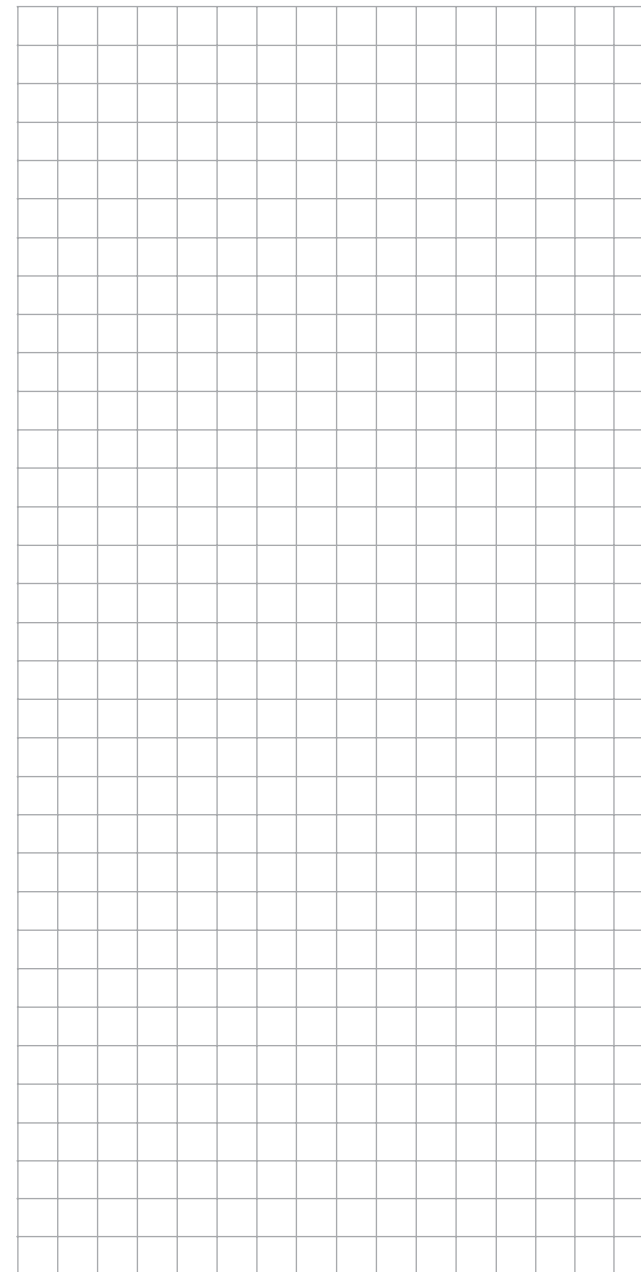

Servo display

Display of the servo position

Use the selection keys on the left or right touch pad to scroll to the menu option »**Servo display**« menu option in the multi-function menu:

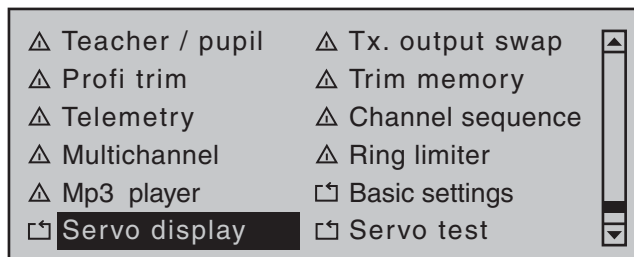

Briefly tap the center **SET** key of the right touch pad to open this menu option.

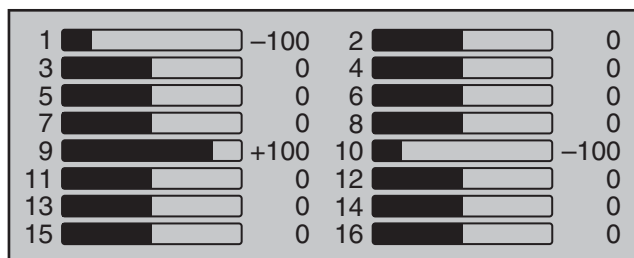

However, the visual display of current servo positions can not only be opened by selecting this menu, but also – directly from the transmitter's base screen as well as nearly all other menu positions – with a simultaneous tap on the ◀ ▶ keys of the left touch pad. A brief tap on the center **ESC** key of the left touch pad will cause a return to the respective point from which it was called.

The current position of each servo is displayed in a bar diagram between -150% and +150% of normal travel with consideration for the control and servo settings, the dual-rate/expo functions, the interplay of all active linear and curve mixers, etc. 0% corresponds precisely to the servo center position. This way, you can quickly check your settings without having to switch on the receiver. However, this does not absolve you from first carefully testing all program

steps, as well as on the model, prior to the first operation of the model in order to eliminate errors!

For winged models the display takes place according to the following scheme:

- Bar 1 = Throttle/brake servo
- Bar 2 = Aileron or left aileron
- Bar 3 = Elevator
- Bar 4 = Rudder
- Bar 5 = Right aileron
- Bar 6 = Camber-changing flap (left) / free channel
- Bar 7 = Right camber-changing flap / free channel
- Bar 8 = Free channel / second elevator servo
- Bar 9 = Free channel / Left FL2
- Bar 10 = Free channel / Right FL2
- Bar 11 = Free channel / Left AI2
- Bar 12 = Free channel / Right AI2
- Bar 13 = Free channel
- Bar 14 = Free channel
- Bar 15 = Free channel
- Bar 16 = Free channel

... and for helicopter models:

- Bar 1 = Pitch or roll (2) or pitch (2) servo
- Bar 2 = Roll (1) servo
- Bar 3 = Pitch (1) servo
- Bar 4 = Tail servo (gyro)
- Bar 5 = Pitch (2) servo / free channel
- Bar 6 = Throttle servo or speed controller
- Bar 7 = Gyro sensitivity / free channel
- Bar 8 = Speed controller / free channel
- Bar 9 = Free channel
- Bar 10 = Free channel
- Bar 11 = Free channel
- Bar 12 = Free channel

- Bar 13 = Free channel
- Bar 14 = Free channel
- Bar 15 = Free channel
- Bar 16 = Free channel

Notes:

- However, please note that the servo display is only based on the original sequence of servos. This means that any swapping of outputs which may have been implemented, in either the »**Transmitter output**« menu or »**Receiver output**« menu, is not taken into account.
- Please also note that, by default, bar diagram tracking is opposite to the left/right movements of a joystick.
- The number of channels shown in this menu correspond to the 16 control channels available in the **MIC-20** HoTT transmitter. However, the number of actually usable channels depends on the receiver type as well as the number of servos connected to it and, therefore, may be considerably lower under certain circumstances.
- Use this display during the model programming, because you can immediately check all settings on the transmitter. However, this does not absolve you from first carefully testing all program steps, as well as on the model, prior to the first operation of the model in order to eliminate errors!

Servo test

Function test of Servo 1 ... 16

Use the selection keys on the left or right touch pad to scroll to the menu option »**Servo test**« menu option in the multi-function menu:

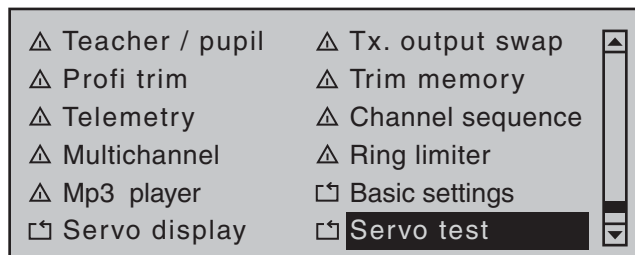

Tap briefly on the center **SET** key of the right touch pad to open this menu option:

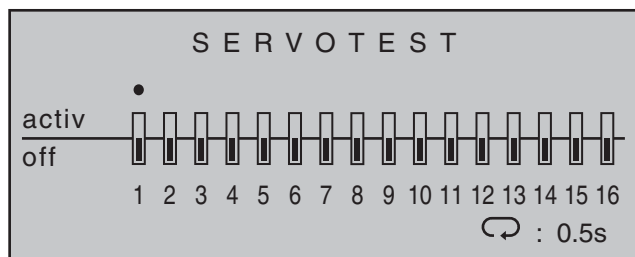

Any of the inputs 1 ... 16 can be activated for the servo test by selecting with the selection keys of the left or right touch pad and then briefly tapping the **SET** key of the right touch pad. As soon as you have set only one of the inputs 1 ... 16 to "active", the following notice appears at the bottom of the display screen:

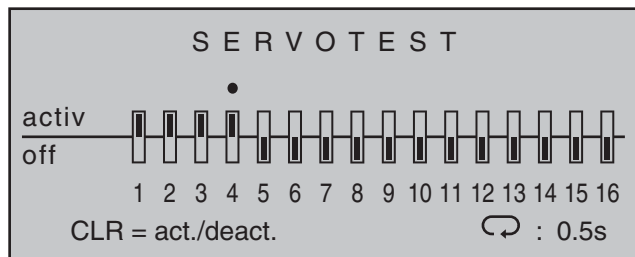

A simultaneous tap on the ▲▼ or ◀▶ selection keys of the right touch pad (**CLEAR**) would now start and stop, for example, a servo test of input "1" with a cycle time of 0.5 s.

To change cycle time, select the loop symbol at the bottom right of the display with the selection keys of the left or right touch pad.

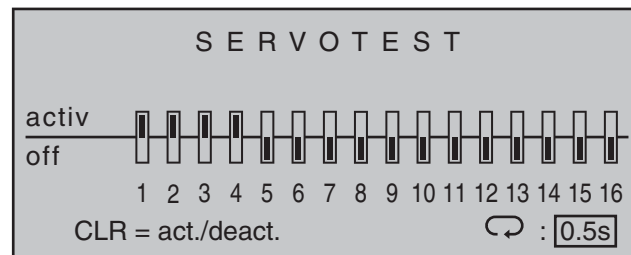

Once this value field has been activated with a brief tap on the center **SET** key of the right touch pad ...

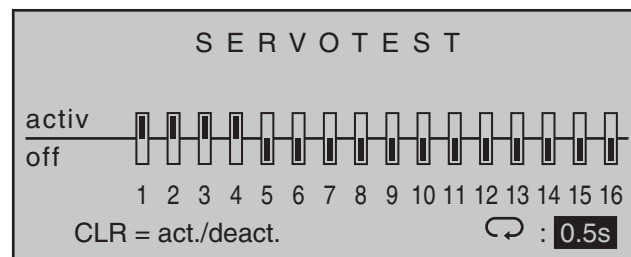

... the motion cycle can be changed for the value field shown in inverse video within a range of 0.5 s and 3.0 s in 0.5 s increments. Briefly tap the center **SET** key of the right touch pad to close time selection.

Important notice:

The shut-off of the transmitter does not automatically end an active servo test. Therefore, always stop a servo test manually BEFORE SHUTTING OFF the transmitter, because the servo test is otherwise restarted after switching on the transmitter again.

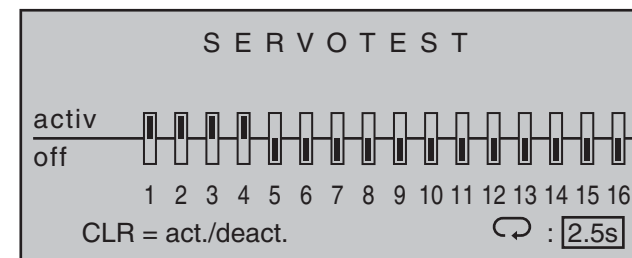

The "servo test" function, started with a simultaneous tap on the ▲▼ or ◀▶ selection keys of the right touch pad (**CLEAR**), automatically operates the servos as though the corresponding transmitter controls were being simultaneously and continuously moved back and forth between -100% and +100% during the preset time. All active mixing and coupling functions in the respective model memory, therefore, are effective and the servos move within the specified servo paths and servo delimitations.

As soon as the servo test has been started by a simultaneously tap on the ▲▼ or ◀▶ selection keys of the right touch pad (**CLEAR**) a window will open:

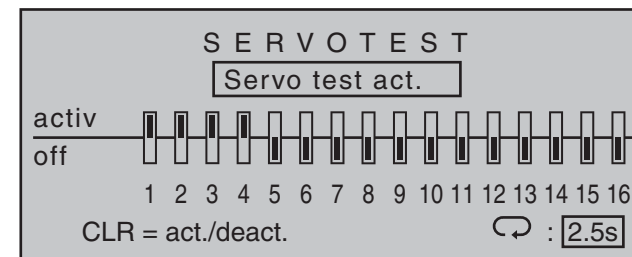

Another tap simultaneously on the ▲▼ or ◀▶ selection keys of the right touch pad (**CLEAR**) will terminate the test.



Entry lockout

Locking the multifunction menu

Use the selection keys of the left or right touch pad to scroll to menu option ...

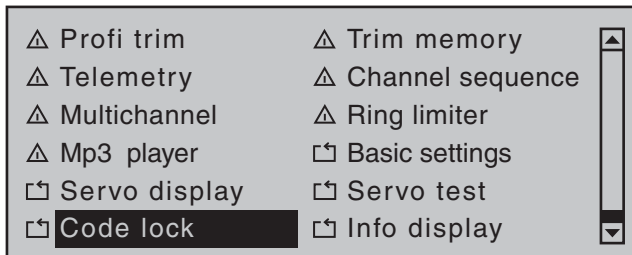

... in the multi-function menu. Tap briefly on the center **SET** key of the right touch pad to open this menu option:



Access to the multifunction menu can be locked against unauthorized use by a four-digit secret code comprised of the numbers 1 to 4. This code lock is entered by way of the selection keys of the left touch pad according to the scheme shown in the display, for example :



As soon as another tap of a left touch pad selection key occurs after the fourth number has been entered, the message shown below will appear in the display:

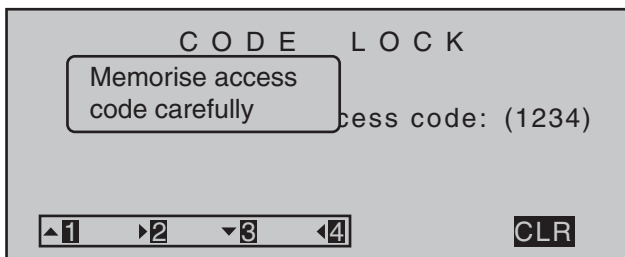

A brief tap on the center **ESC** key of the left touch pad will confirm the entered secret code and exit the menu.

On the contrary, a brief tap on the center **SET** key of the right touch pad will confirm the currently active **CLR** field at the bottom right of the display and thus erase the entered digits.

Make note of the secret code and keep it safe. Otherwise, the transmitter must be sent in to Graupner service for decoding.

The lock becomes active the next time the transmitter is switched on. However, the control remains ready for operation. However, a call-up of the multi-function menu, and thus also a model change, can no longer be accomplished without entering the correct number combination.



A renewed attempt following an incorrect entry is only possible after the lapse of a time-out.

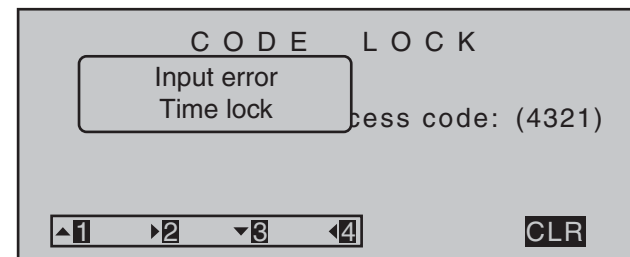

Deletion of the secret code

If the secret code is to be erased later on, tap *twice* on the center **SET** key of the right touch pad right after calling up this menu option.



The first activation of the center **SET** key of the right touch pad will erase the secret code (**CLR**):

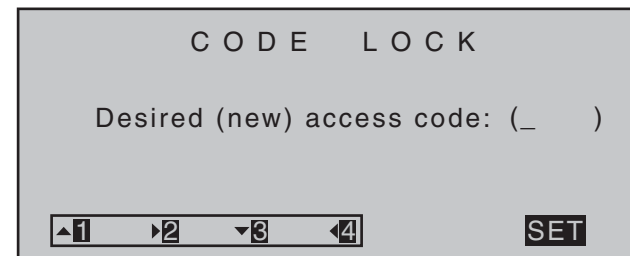

and the second activation will confirm the empty entry field (**SET**). The message shown will appear in the display:

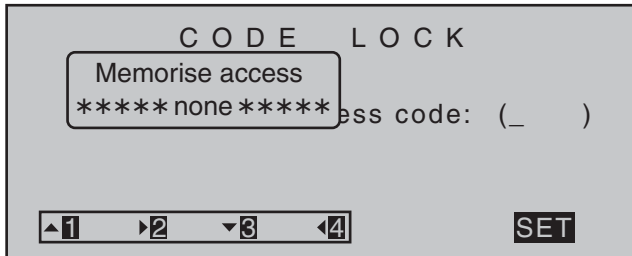

Now exit the menu with a brief tap on the **ESC** key of the left touch pad.

Leaving the menu without input of a secret code

To leave the menu opened out of curiosity or by accident when no other key has been touched. Therefore, the display appears as follows:



Tap *once* on the center **SET** key of the right touch pad. The following display appears:

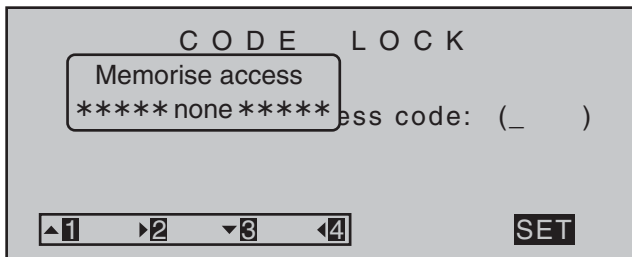

Now exit the menu with a brief tap on the **ESC** key of the left touch pad.

Tip:

*If you generally want to dispense with a programming lock, that option should be removed from the multifunction menu by way of »**Suppress menus**«.*
This will prevent unauthorized persons from entering a secret code "on the sly".

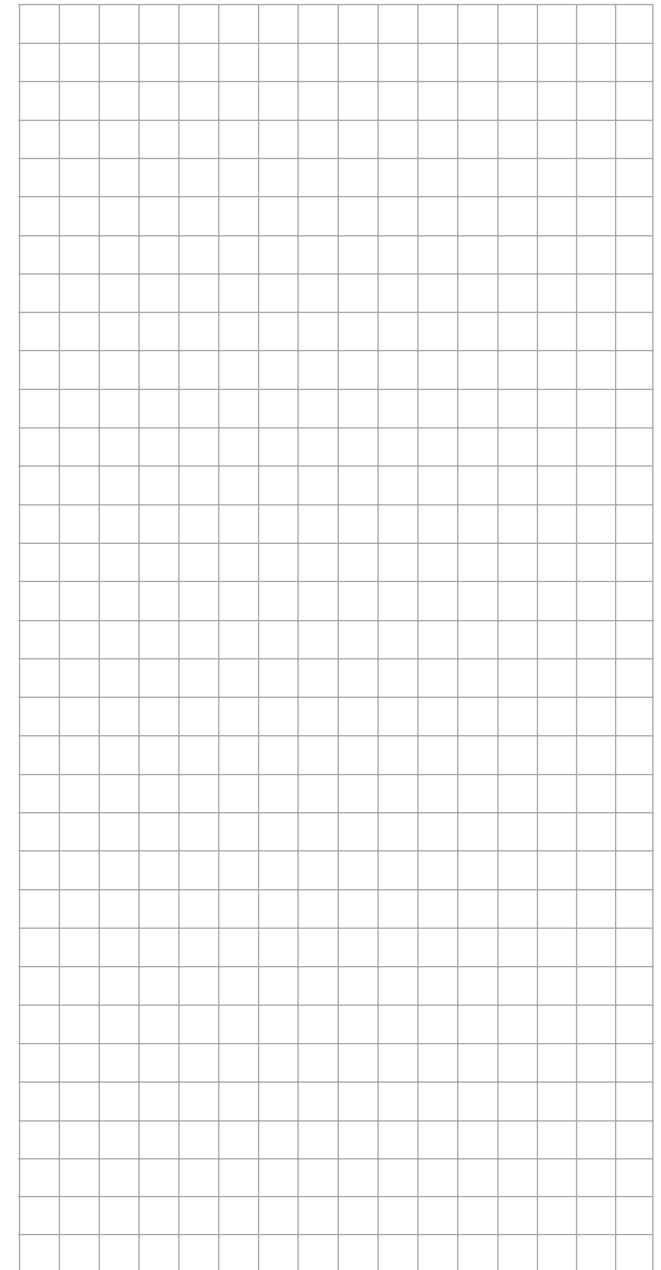

Info display

Transmitter ID, date, time and memory card

Use the selection keys of the left or right touch pad to scroll to menu option ...

| | |
|-----------------|-----------------------|
| △ Profi trim | △ Trim memory |
| △ Telemetry | △ Channel sequence |
| △ Multichannel | △ Ring limiter |
| △ Mp3 player | □ Basic settings |
| □ Servo display | □ Servo test |
| □ Code lock | □ Info display |

... in the multi-function list. A brief tap on the center **SET** key of the right touch pad will open this menu:

| | |
|------------------|-----------------|
| ▶ RFID | ABCDEF12 |
| Firmware Version | 1.234 |
| date | 2011/11/11(Fr) |
| time | 11:22:33s |
| SD-CARD | 1943MB |
| available | 1933MB |
| | 99% |

Transmitter-specific information is shown in this menu and—insofar as necessary and beneficial—can also be changed.

Select the appropriate line with the ▲ ▼ selection keys of the left or right touch pad then briefly tap on the center **SET** key of the right touch pad. The given default value in the value field displayed in inverse video can now be changed—insofar as possible and necessary—with the selection keys of the right touch pad followed by another tap on the center **SET** key to conclude the entry.

RFID

| | |
|------------------|-----------------|
| ▶ RFID | ABCDEF12 |
| Firmware Version | 1.234 |
| date | 2011/11/11(Fr) |
| time | 11:22:33s |
| SD-CARD | 1943MB |

The RF identification number of the transmitter is shown in this line. It is transmitter-specific, is only issued once per transmitter and cannot be changed. During the connection process, this is sent to the receiver, among other things, so that it is always capable of identifying the radio signals of "its" transmitter.

Firmware Version

| | |
|--------------------|-----------------|
| RFID | ABCDEF12 |
| ▶ Firmware Version | 1.234 |
| date | 2011/11/11(Fr) |
| time | 11:22:33s |
| SD-CARD | 1943MB |

The current version number of the transmitter software is shown in this line.

Through a comparison of the number shown here with the update version offered on the Internet download page of the corresponding product under www.graupner.de, you can determine whether a current update of the transmitter operating system is available.

If applicable, the version number is also required for inquiries with the service department.

Date

| | |
|------------------|-----------------|
| RFID | ABCDEF12 |
| Firmware Version | 1.234 |
| ▶ date | 2011/11/11(Fr) |
| time | 11:22:33s |
| SD-CARD | 1943MB |

If necessary, select this line with the selection keys of the left or right touch pad and, as necessary, select the month or date field. After activating the respective value field with a tap on the center **SET** key of the right touch pad, the year, month or day can be set with the selection keys of the right touch pad. Another tap on the center **SET** key of the right touch pad will close the given entry. Years ranging from 2000 through 2135 are available for selection.

The abbreviated day of the week to the right outside in brackets is automatically generated from the respective date.

Notes:

- If the transmitter is connected to a PC as described on page 43, the date and time can also be set through the PC program provided for the respective product via the Internet page at www.graupner.de.
- The date and time are protected against data loss due to power failure by a buffer battery for situations like a battery change, see page 18.

Time

| | |
|------------------|-----------------|
| RFID | ABCDEF12 |
| Firmware Version | 1.234 |
| date | 2011/11/11(Fr) |
| ▶time | 11:22:33s |
| SD-CARD | 1943MB |
| ▼ ▲ | |

If necessary, select this line with the selection keys of the left or right touch pad and, as applicable, the minute field. After activation of the respective value field by a tap on the center **SET** key of the right touch pad, the hour or minute can be adjusted with the selection keys of the right touch pad. Another tap on the center **SET** key of the right touch pad will close the given entry.

In contrast, the seconds display cannot be set directly; it can only be restarted at "00" with a brief tap on the center **SET** key of the right touch pad.

Note:

- If the transmitter is connected to a PC as described on page 43, the date and time can also be set through the PC program provided for the respective product via the Internet page at www.graupner.de.
- The date and time are protected against data loss due to power failure by a buffer battery for situations like a battery change, see page 18.

SD card

| | |
|------------------|-----------------|
| RFID | ABCDEF12 |
| Firmware Version | 1.234 |
| date | 2011/11/11(Fr) |
| time | 11:22:33s |
| ▶SD-CARD | 1943MB |
| ▼ ▲ | |

In this line the memory capacity of a memory card inserted in the transmitter, if applicable, is shown in MB.

Depending on the memory capacity of the inserted micro SD or micro SDHC memory card, it may take several minutes until the correct value is shown after switching on the transmitter.

available

| | |
|------------------|-----------------|
| Firmware Version | 1.234 |
| date | 2011/11/11(Fr) |
| time | 11:22:33s |
| SD-CARD | 1943MB |
| ▶available | 1933MB |
| ▼ ▲ | |

Display of the available storage space in MB.

As mentioned before, display of the available storage space—depending on the capacity of the inserted memory card—does not appear until some time has passed after switching on the transmitter.

The display of the available storage space in relation to the total memory capacity is shown in the line below:

| | |
|-----------|-----------------|
| date | 2011/11/11(Fr) |
| time | 11:22:33s |
| SD-CARD | 1943MB |
| available | 1933MB |
| ▶ 99% | |
| ▲ | |

As mentioned before, display of the available storage space—depending on the capacity of the inserted memory card—does not appear until some time has passed after switching on the transmitter.

MC-20 HoTT programming

Preparatory measures based on the example of a winged model

Programming models in an MC-20 HoTT ...

... is easier than it may appear at first!

The primary prerequisite for "clean" programming, and this applies not only to the MC-20 HoTT but is also a principle for all programmable transmitters, is a mechanically correct installation of all remote control components in the model! Therefore, it should be ensured no later than on connection of the linkages that the servos are in their respective neutral position and their rudder lever is also in the desired position. Otherwise you should loosen the rudder and re-fasten it with an offset of a few lobes. If servos are positioned with the help of a servo tester, e.g. RC tester, order no. **2894.12**, then the "correct" positions can be determined very easily.

The possibility of changing the neutral position of a servo in practically every modern transmitter is only intended for *fine-tuning*. Greater deviations from "0" can result to further asymmetries in the course of the further signal processing in the transmitter. In the same manner: A car with a bent chassis does not get any straighter if only the steering wheel is trimmed to "straight"!

An additional important point is the adjustment of the rudder paths: This should take place through a corresponding adjustment of the steering points, insofar as possible. Ultimately this is far more efficient than extensive efforts with the path adjustments in the transmitter! In this case: Path adjustments serve first and foremost for to compensate for the manufacturer-stipulated tolerances for the servos and their *fine-tuning*, and less for the compensation of carelessness. If two separate aileron servos are used for a winged model, the ailerons, controlled through the corresponding activated wing mixer—see the following pages—can be assigned with both the flap function and raised with the brake flaps—however this would make more sense in a glider or electro glider than in a motor model.

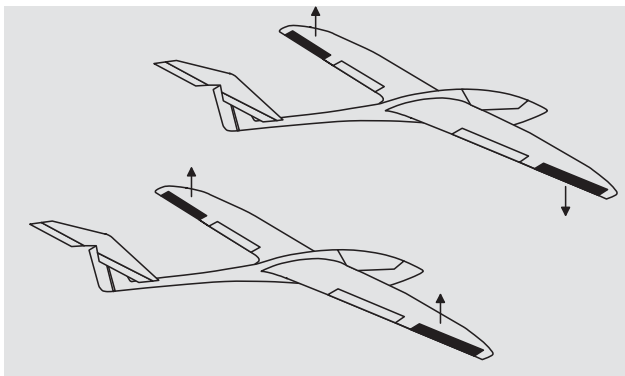

In this case the rudder arms—starting from the neutral position—should be tilted forward one lobe, pointing toward the nose, set to the respective servo.

The mechanical differentiation achieved through this asymmetric assembly contributes to the fact that the brake effect of the elevated ailerons increases with their deflection and, therefore, does not normally require a greater path upward than downward.

Correspondingly, when planning to operated separately controlled flap servos, they should also be integrated into a crow system. Since the brake effect of this flap position referred to as a "crow position" is influenced less by the elevated ailerons than the downward deflection of the flaps, the rudder arms should be installed somewhat toward the rear in this case, tilted toward the trailing edge. As a result, there is a greater available path for the downward deflection. With such a combination of lowered flaps with raised ailerons, however, the latter should only be elevated moderately, because they have more of a stabilizing and controlling function than a braking function in this type of crow system.

A "tip" for seeing the brake effect in this connection: lift the flaps and look over and under the surface from the front. The greater the projected surface of the protruding rudder, the greater the brake effect.

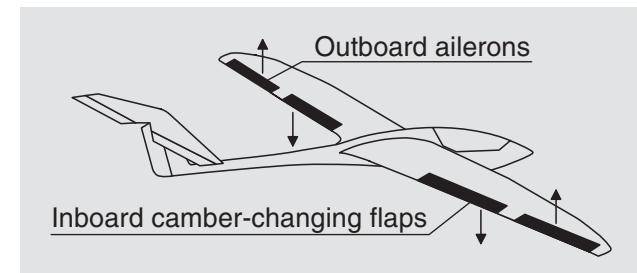

(Similar asymmetric installation of rudder arms can be meaningful, e.g. for open-cowl flaps or landing flaps, even in a motorized model.)

If a model is completed and mechanically attuned in this respect, you can basically begin with the programming of the transmitter. The following examples, an attempt is made to follow the practice of first describing the general basic settings and then fine-tuning or specializing them in the subsequent steps. After the initial flight and over the course of the further flying in of a model, it may be necessary to occasionally adjust some of the settings. As a pilot's experience increases, however, so does the desire for enhancements and expansions of settings. For this reason, the sequence of options is not always adhered to or some options are even mentioned multiple times. Of course, just the opposite can also be the case, that not everyone of the described steps is relevant for a certain model, just as some users may miss the description of a certain step for their model ... whatever the case may be, you should consider a logical assignment of the control mechanisms before you begin with the model programming.

For models in which the emphasis is on the "motor", regardless of whether it is powered by an electric or combustion motor, there should be no problem in this respect, because the assignment of the two joystick units essentially lies in the four basic functions "Power regulation (= throttle)", "Side", "Altitude" and "Transverse"! However, in the menu ...

»Model type« (beginning on page 94)

| M O D E L L T Y P E | | | |
|----------------------|--------|---------|--|
| ► Motor on C1 | None | | |
| Tail type | Normal | | |
| Aileron/camber flaps | 1 AIL | | |
| Brake Offset | +100% | Input 1 | |
| ▼ | SEL | | |

... you should determine whether you would like the minimum throttle position in the "front" or "rear", because "none (motor)" is entered by the program in the creation of a model memory as a basic principle. The difference between "none" and "idle front/rear" is not only the effect on C1 trimming, which covers the entire scope of joystick travel with "none" but with "idle front/rear" only has an effect in the idle direction. In the process, the "effective direction" of the C1 joystick is adapted accordingly, so that with a change from "front" to "rear" or vice versa, the rotational direction of the throttle servo or brake system do not have to be adapted as well. In addition, with an "idle front/rear" setting, a warning indication appears in the display for safety reasons and issues a warning beep, if the throttle joystick is too far in the full-throttle direction:

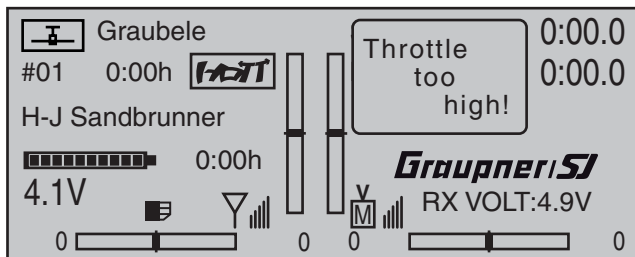

In any case, it will be necessary to give some thought to "special functions".

With electro gliders, on the other hand, it is only occasionally different. In this regard, one must ask

how the drive and brake system are actuated. Certain solutions have shown to be practical and others have shown to be less practical.

For example, it is certainly less practical, if you have to release a joystick for the approach of a glider model in order to be able to appropriately control the spoilers or a crow position using one of the other controls. It may be more advantageous to either design the function of the C1 joystick to be switchable (see Example 4, beginning on page 279) or to leave the control of the brake system at the joystick and to control the motor through one of the other controls or even with a switch! Since this type of model does not normally have a motor, and just a "start assistance" function to either "lift" the model in the sky with full force or, in any case, to "tow" it with "half" force by a wind field, When this is also mounted in a convenient to grip location, the motor can be switched on and off without letting loose of one of the joysticks – even during the landing approach.

If you cannot decide to have your *Graupner* service location retrofit a three-function control switch, order no. **33000.13**, for this purpose then use preferably the single-pole, three-function switch, order no. **33001.25**, and mount it to the side of the sender opposite from the hand in which you hold the model. In other words: If the model is started from the right hand, the motor switch should be mounted on the left side and vice versa.

The idea is the same for the control of flaps, regardless of whether only ailerons or flaps covering the entire wingspan (combinations) are raised or lowered. A 3-position switch with a long grip generally suffices for control of camber flaps, preferably mounted outboard on the throttle/brake joystick side. There it is always accessible without having to let loose of the joystick.

If everything is now in order, you can begin with the programming.

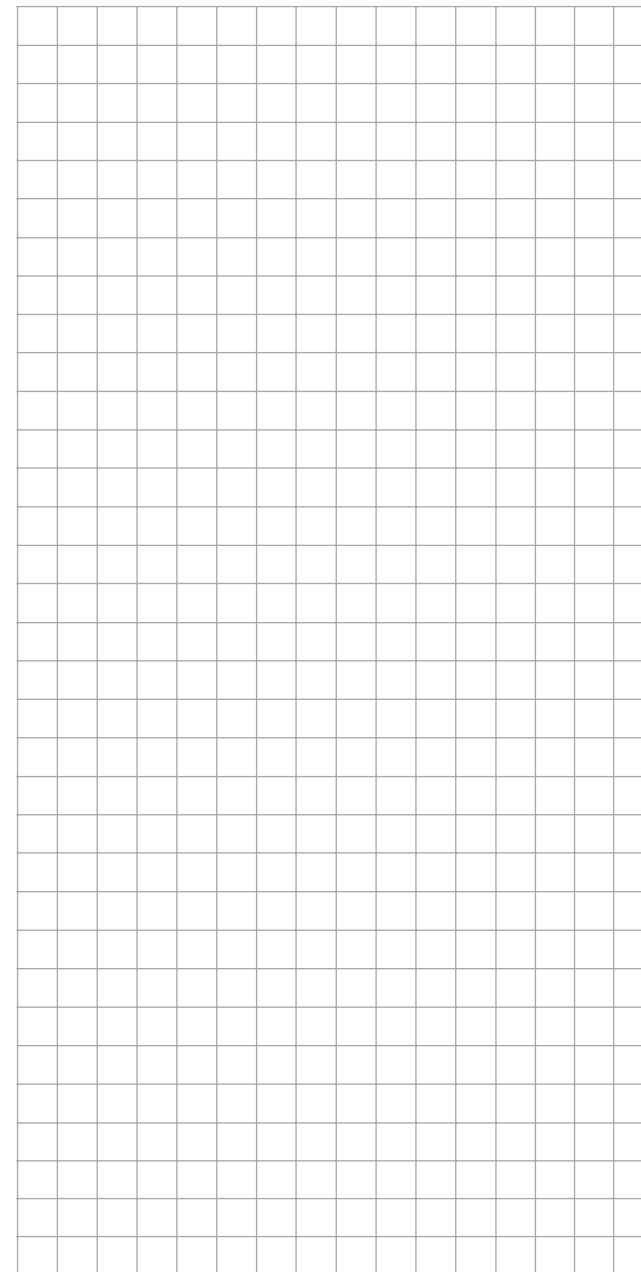

Initial steps for the programming of a new model

Example: Winged model with two ailerons and –initially– without motor propulsion

In the context of **initial commissioning a new transmitter**, in the selection menu ...

»General basic settings« (page 256)

| GENERAL BASIC SETTINGS | | | |
|------------------------|---------------------|-------|-----|
| Voice volume | 7 | fr | --- |
| Vario volume | 7 | fr | --- |
| Touch-beeps vol. | 7 | fr | --- |
| ► Owners name | < H-J Sandbrunner > | | |
| Pre-set stick mode | 1 | | |
| Pre-set modulation | | HoTT | |
| Pre-set DSC Output | | PPM10 | |
| Pre-set Pitch min | | rear | |
| Top LCD contrast | 0 | | |
| Bottom LCD contrast | 0 | | |
| Display light | | unlim | |
| Power-on/off beep | | yes | |
| Battery type | | Li-Io | |
| Battery warning | | 3.60V | |
| Stick warning | | unlim | |
| Touch Sense | | 2 | |
| Region | | EURO | |
| Own phase name | 1 | < | > |
| Own phase name | 2 | < | > |
| ⋮ | ⋮ | ⋮ | ⋮ |
| Own phase name | 10 | < | > |
| | | | ➡ |

... some basic information should be entered. This serves various purposes:

The first three lines of this menu can be used to individually regulate, in increments between 0 and 10, the volume of voice and signal output emitted via the built-in loudspeakers or the transmitter's headset connector. The fourth line of this menu is used to

record the transmitter owner's name and the lines "**Pre-set stick mode**", "**Pre-set modulation**", "**Pre-set DSC Output**" and "**Pre-set Pitch min**" are for the storage of pre-set values used as defaults for new models. These are then adopted on the activation of a new model memory in its basic settings, but can be changed there at any time.

The "**Top / Bottom LCD Contrast**" lines can be used to adapt the contrast of respective displays to ambient light conditions as necessary by changing the standard pre-set "0" in a range of ± 20 (as an alternative to the line with the same name in the »**Secret mode**« menu page 32).

The setting in the "**Display light**" line determines how long display lighting remains illuminated after the transmitter is switched on or after the last key actuation.

The selection of "yes/no" in the "**Power-on/off beep**" line determines whether the "recognition melody" is to sound when the transmitter is switched off or on again.

The "**Battery type**" line indicates to the transmitter whether its power comes from a four-cell NiMH battery or a single-cell LiPo battery and the "**Battery warning**" line can be used to individually set the threshold for the battery warning. Make sure that you do not enter a value which is too low, so that you still have sufficient time to safely land your model in the event of a battery warning.

If necessary, the "**Stick warning**" line can be used to determine how long the transmitter should wait after the last activation of an operating element before issuing a visual and acoustic stick warning, followed about a minute later by the transmitter switching itself off.

On the other hand, the setting made in the "**Touch Sense**" line is merely a personal comfort setting. The lower this number is, the more sensitive the touch pad will be to taps and vice versa.

In contrast, the setting in the "**Region**" line is anything but a matter of taste and is determined by statutory regulations: **Therefore, when in France, only commission the transmitter with the "France" setting.**

The ten "**Own phase name**" lines can be used to create one's own phase names, which are then valid throughout the transmitter, if none of the pre-set phase names appear appropriate. An entry itself is accomplished – as also for owner's name – by switching to a second display page and selecting the necessary characters from a character list.

This menu can be exited after completing "general settings" with a return to the multi-function menu by way of the center **ESC** key of the left touch pad.

To program a new model, now use the selection keys of the left or right touch pad to switch to the menu ...

"Model select" (page 69)

..., and use the selection keys of the left or right touch pad to select a free model memory location.

| | | |
|----|--------------|-----------|
| 01 | ⊞ | 00:12hR16 |
| 02 | *** free *** | |
| 03 | *** free *** | |
| 04 | *** free *** | |
| 05 | *** free *** | |
| 06 | *** free *** | |

Right after a tap on the center **SET** key of the right touch pad to confirm this selection, the type of model to be programmed will be requested:



Since the objective is to work with a winged model in this section, the symbol for a winged model is to be confirmed with a tap on the center **SET** key of the right touch pad. The display switches back to the base screen.

Notes:

- Of course, you can also use the predefined default "winged model" supplied with the receiver as model memory 01 for the programming of your first model.
- Once the "Select model type" option has been opened, the process can no longer be canceled! Even if you switch off the transmitter, this selection must be made! After a selection has been made, the selected model memory can only be made "free" again by subsequent erasing.
- If battery voltage is too low, the model switchover cannot be made due to reasons of safety. An appropriate message will appear in the screen:

not possible now
voltage too low

Once this first hurdle has been taken, the binding of the receiver built into the model to this model memory can be done in the menu ...

»**Basic settings, model**« (page 76 ... 83)

. To this end, switch to the line "**Module**".

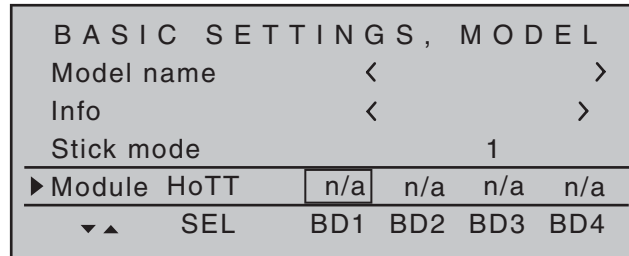

Note:

After confirmation of the model selection in the base screen, if you confirm the message appearing in the screen for a few seconds ...



... with a tap on the **SET** key of the right touch pad, this line is accessed automatically.

In this line the binding process between model memory and receiver is initiated, as described in detail on page 77. Otherwise, you cannot address the receiver.

Afterward, use the ▲ selection key of the left or right four-way pad to move up to the first line and begin with the actual model programming in the "**Model name**" line.

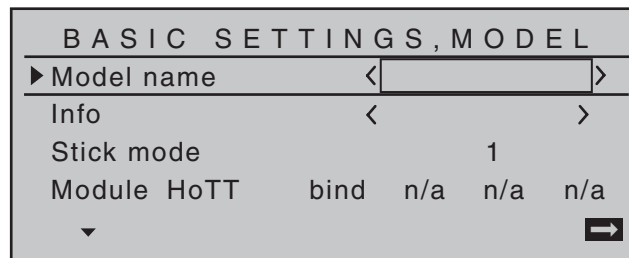

The "**Model name**" can now be entered here and, on the next line, an informative note about the model can be entered if necessary in the same manner, by a

brief tap on the center **SET** key of the right touch pad to switch to the character table.

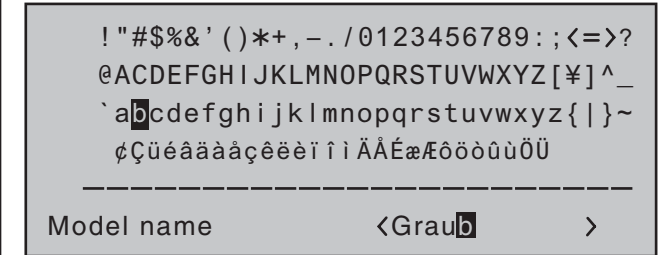

The pre-sets for "**Stick mode**", "**Modulation**" and "**DSC Output**" are adopted from data stored in the »**General basic settings**« menu and these should be reviewed and changed as necessary.

In the menu ...

Model type

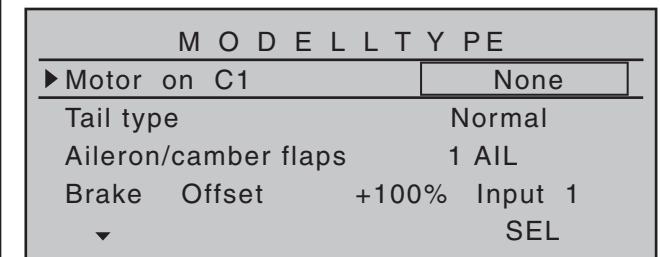

... the principle arrangement of the servos in the model is selected and communicated to the transmitter. The following selections are available:

"**Motor at C1**"

- "none"
Trimming works independently of the joystick position and the "Brake settings" sub-menu of the »**Wing mixers**« menu, beginning page 160", is available without limitation.

The "Throttle too high" warning message, see page 30 and/or 94, and the "Motor stop" option are *deactivated*.

- "(Idle) front or rear"
C1 trimming is affected in the front or rear and the "Motor stop" option is *activated*.

If the throttle joystick is too far in the full throttle direction when the transmitter is switched on, this will be indicated with the warning message "Throttle too high".

In parallel with this, the "Brake settings" sub-menu of the »Wing mixers« menu, beginning page 160, will only then be available if the "Motor" column of the »Phase settings« menu, page 142, has the entry "none" for the currently active flight phase.

In the next two lines, the principle arrangement of the servos in the model is selected and communicated to the transmitter:

| M O D E L L T Y P E | | | |
|----------------------|--------|--------|---------|
| Motor on C1 | | None | |
| ► Tail type | | Normal | |
| Aileron/camber flaps | | 1 AIL | |
| Brake | Offset | +100% | Input 1 |
| | | | SEL |

Tail type: "normal", "V-tail", "Delt/fl.wing" or "2 Sv EL 3+8"

Aileron/camber flaps:
1, 2 or 4 AI servos and 0, 1, 2 or 4 FL servos

Since we want to actuate the brake system of the "Brake settings" sub-menu under the »Wing mixers« menu with the C1 joystick, we will leave the outer right setting in the "**Brake Offset**" line with "Input 1". With the "Offset value" to the left of this, you should only place the mixer neutral point at the point where the brake system is retracted or inactive. If, in the process, the offset is not place completely at the end of the control path, the rest of the path is "idle travel",

which means the mixer is not influenced in this range of the joystick movement.

By now at the latest, servos should be plugged into the receiver in the standard *Graupner*'ish sequence:

| | |
|------|--|
| 5 + | — Anschluss für SUMO / SUMI-Verbindung |
| 16 + | — frei oder Sonderfunktion |
| 15 + | — frei oder Sonderfunktion |
| B + | — Empfängerstromversorgung |
| 12 + | — frei oder QR2 rechts oder Sonderfunktion |
| 11 + | — frei oder QR2 links oder Sonderfunktion |
| 10 + | — frei oder WK2 rechts oder Sonderfunktion |
| B + | — Empfängerstromversorgung |
| 9 + | — frei oder WK2 links oder Sonderfunktion |
| 8 + | — frei oder 2. Höhenruder od. Sonderfunktion |
| 7 + | — Wölbklappe rechts od. frei oder Sonderf. |
| B + | — Empfängerstromversorgung |

| | |
|------|--------------------------------------|
| T + | — Telemetrieanschluss |
| 14 + | — frei oder Sonderfunktion |
| 13 + | — frei oder Sonderfunktion |
| B + | — Empfängerstromversorgung |
| 6 + | — Wölbklappe oder Wölbklappe links |
| 5 + | — Querruder rechts oder Sonderfunkt. |
| 4 + | — Seitenruder |
| B + | — Empfängerstromversorgung |
| 3 + | — Höhenruder oder 1. Höhenruder |
| 2 + | — Querruder oder Querruder links |
| 1 + | — Bremsklappen- oder Motorservo |
| B + | — oder Regler bei Elektroantrieb |
| B + | — Empfängerstromversorgung |

Comments:

- If a V-tail unit should move incorrectly either "high/low" or "left/right", please observe the information in the table on page 62 in the right column. The same process applies for the ailerons and flaps.
- The settings described in the following are based on a model with "normal" tail unit and "none (motor)". The settings are adopted for models with a V-tail with practically no changes at all. However, the transfer of this information is not so

simple for delta/flying-wing models. Therefore, a special programming example for this model type is provided on page 301.

In the menu ...

»Servo adjustment« (page 102)

| ► Servo | => | 0% | 100% | 100% | 150% | 150% |
|---------|-----|-------|----------|------|---------|------|
| Servo 1 | => | 0% | 100% | 100% | 150% | 150% |
| Servo 2 | => | 0% | 100% | 100% | 150% | 150% |
| Servo 3 | => | 0% | 100% | 100% | 150% | 150% |
| Servo 4 | => | 0% | 100% | 100% | 150% | 150% |
| Servo 5 | => | 0% | 100% | 100% | 150% | 150% |
| ▼ | Rev | cent. | - travel | + | - limit | + |

... servos can now be adapted for appropriate "direction of rotation", "neutral position", "travel" and "limitation" to the requirements of the model.

In this sense, all settings which serve to compensate servos and make *minor* adaptations to the model are "necessary".

Notes:

- The maximum possible throw of a Graupner servo is 150% per side, based on both mechanical and electrical reasons. For example, if the the sum of the values of the columns "Center" and "Servo travel" exceed this limit, the respective servo can no longer follow the control commands starting from this point. Therefore, please bear in mind that mixers and settings in the »Dual Rate / EXPO« menu also have an influence on servo travel.
- The settings options provided in this menu for asymmetric servo travel do NOT serve for achieving differentiations for ailerons and/or flaps. There are options better suited for this purpose in the »Wing mixers« menu.

In the last column, "- limit +", the basic settings of 150% can, and perhaps should be, significantly reduced.

The values entered in this position act as a quasi "limiter", whereby the setting is actually for which point of travel the respective servo may not exceed, so that it does not start up mechanically and thus unnecessarily draw current. In this case it is the end of available mechanical play on the servo, rudder and/or steering which is decisive for the value to be set.

An example of this would be the selection of a model with cruciform tail, with which the rudder moves in a wedge-shaped cutout of the elevator. In order to prevent the rudder on the elevator starting up and possibly blocking it, the travel is normally mechanically adjusted (at the linkage) so that the rudder does not start with the full throw of the joystick. As long as the rudder is only controlled with the corresponding joystick, there will not be any further problems with this. But at the moment, when in addition to the normal rudder signal a mixer also influences the rudder, such as an "aileron 2 → 4 rudder" mixer (aileron to rudder), it is possible that the two signals can sum to an excessive extent. A correctly set limit of travel intercedes precisely at this point and thus reliably prevents the mechanical starting of the rudder. The limit of travel should, however, not be too small, so that the rudder throw is permanently and excessively limited. Of course, the travel on both sides could, of course, also be reduced to the that a start-up would not even occur with an addition of the maximum values. With this method, however, the prevention of an actually occurring event would result in a permanent reduction of the normal rudder throw.

The menu ...

»Stick mode« (page 104)

| | | | | |
|-------------|--------|----------|--------|------|
| ▶ Channel 1 | global | 4 | 0.0s | 0.0s |
| Aileron | global | 4 | 0.0s | 0.0s |
| Elevator | global | 4 | 0.0s | 0.0s |
| Rudder | global | 4 | 0.0s | 0.0s |
| | Trim | Tr. step | - time | + |

In addition to the generally interesting adjustment of the increments in the column "Tr. step" (number of trim increments for each "trim wheel click") for digital trimming—separate adjustments for each of the four trim wheels—in the case of the (later) programming of flight phases in the second column of this menu you can select whether the trimming of transverse, altitude and side should operate "globally" in equal measure over all flight phases or separately in each (flight) "phase".

The "Time" column, on the other hand, is not of interest for this initial programming.

The settings made up to this point are sufficient to permit basic flight of winged and motorized models—though the latter does require a correctly set idle joystick direction in the "Motor on C1" line of the »Model type« menu. However, the "fine-tuning" is still missing. The fine-tuning certainly adds to the enjoyment of flying over the course of time. Therefore, if you can already fly your model safely, you should delve into the menu...

»Wing mixers« (page 160 ... 175)

... where various options are available, depending on the specifications made in the »Model type« menu, page 94.

Since this section deals with a model having only 2 servos in the wings, the Multi-flap menu beginning on page 170 is not shown.

| WING MIXERS | | | |
|----------------------|----|-----|-----|
| ▶ Brake settings | => | | |
| Aileron differential | 0% | | |
| Aileron 2→4 rudder | 0% | --- | |
| Elevator 3→5 aileron | 0% | 0% | --- |
| ▼ | ▶ | | |

Therefore, we begin with the "Brake settings" sub-menu:

| BRAKE SETTINGS | |
|----------------|--|
| off | |

If this display appears, your model is equipped with a motor, contrary to the assumption of this section, and therefore you have selected "front/rear" instead of "none" in the line "Motor on C1" of the »Model type« menu, page 94. Therefore, change this setting temporarily or change the "yes" entry in the "Motor" column of the »Phase settings« menu, page 142, to "no" for the currently active flight phase—Phase 1 in this case.

| | | | | | |
|-----------|------|-------|-------|---------|---|
| ▶ Phase 1 | | | no | 0.1s | * |
| Phase 2 | | | yes | 0.1s | - |
| Phase 3 | | | yes | 0.1s | - |
| Phase 4 | | | yes | 0.1s | - |
| Phase 5 | | | yes | 0.1s | - |
| ▼ | Name | Timer | Motor | Sw.time | |

...

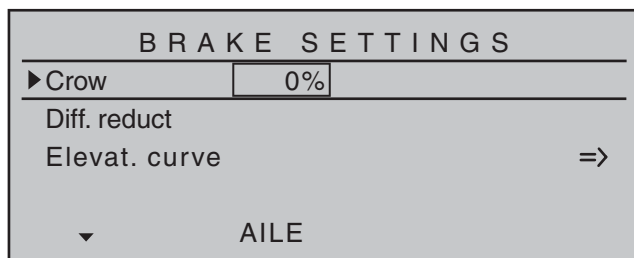

After this statement about mutual dependencies, back to the topic:

If the ailerons are to be elevated for braking, an appropriate value is entered into the "**Crow**" line after activating the "AILE" column's value field. In addition, a value should always be entered in the line below it, "**Diff.Reduct**" (differentiation reduction), which corresponds to the value you entered or would like to enter on the first page of the »**Wing mixers**« menu in the line "Aile.diff." (see figure above)! With this entry, on actuation of the brake joystick, the set aileron differentiation is hidden again proportionally in order to increase the downward the throw of the raised ailerons and thus significantly improve its effect in the braking phase.

A setting of the "**Elevat. curve**" mixer is then only necessary if the flight speed of the model changes too dramatically on actuation of the brake system. In any case, you should try out the setting at a sufficient and readjust, if necessary, whereby you should focus less on the flight position than on maintaining the "normal" flight speed of the model. Otherwise there is the risk that the model plunges when engaging the brake system, because it became too slow in the meantime:

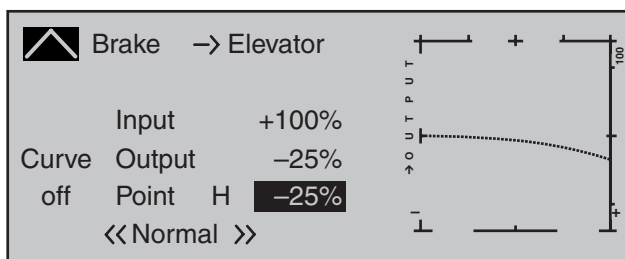

After exiting the "Brake settings", the "**Aileron differentiation**" can be set:

This serves to eliminate the negative torque. The downward deflected aileron normally generates a higher level of resistance during the flight than when deflected upward the same distance, whereby the model is pulled to the "wrong" side. In order to prevent this, with the input of a differentiation of the travel of the respective servo deflected downward is reduced accordingly. A value between 20 and 40 %, in this case, seldom arises, however, the "correct" setting must be sought.

The option "**AI 2 → 4 RU**" (aileron → rudder) also serves a similar purpose, as well as for the comfortable control of a model. A value of about 50 % is a practical initial value. However, this function should be made switchable with the assignment of a switch if you ever have aerobatic flight ambitions. (The author, for example, switches off this mixer "automatically" when switching to the "Speed" flight phase, in which he assigns both options to the same switch accordingly.)

The last option in the »**Wing mixers**« menu, the "**EI 3 → 6 FI**" mixer, is not yet of interest at the moment.

If the model-specific settings were made thus far, the initial start can be considered. If course, at first you should perform a "dry run", meaning you should carefully check all the settings once again on the

ground. Incorrect programming can damage more than just the model! In case of doubt, ask the advice of an experienced model pilot.

If you should find during the testing that one or multiple settings must be made for the adjustment of the rudder effects to your control habits, the control throws are too long or short on the whole, you should adjust this in the ...

»**Dual Rate / Expo**« (page 120)

... to your own requirements and habits.

"**Dual Rate**" establishes a relationship between joystick travel and control travel, see page 120:

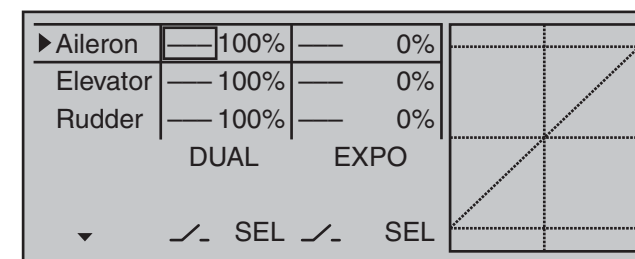

On the other hand, if the maximum throws are OK and only the reactions around the center position are too strong for more sensitive controls, then the "exponential" functions comes (additionally) into play:

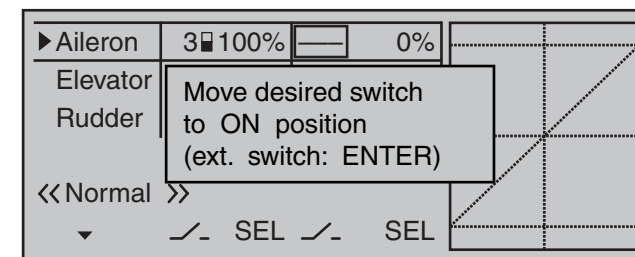

If a switch is also assigned, switching can even take place between two dual-rate/expo settings during the flight.

This is similar for the option ...

»Channel 1 curve« (page 128)

| | | |
|---|--------------------------|----|
|  | Channel 1 C U R V E | |
| Input | 0% | |
| Curve Output | 0% | |
| off Point | <input type="checkbox"/> | 0% |

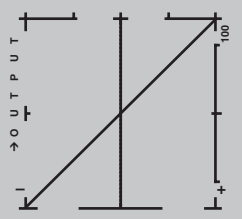

With this option, one or multiple points of the control curve of the throttle/brake joystick can be influenced in such a way that a pleasant or even purposeful behavior is guaranteed.

An example of this would be the "dead" travel of spoilers. The flaps first pass through this after a certain "idle travel" of the brake joystick from the wing. With a corresponding "bending" of the curve, the "dead" travel is covered more quickly. The spoilers come out from the wing earlier and then the remaining travel can be controlled with greater sensitivity. (This also applies for the control of a motor in the same manner, which can be controlled through C1 as an alternative.)

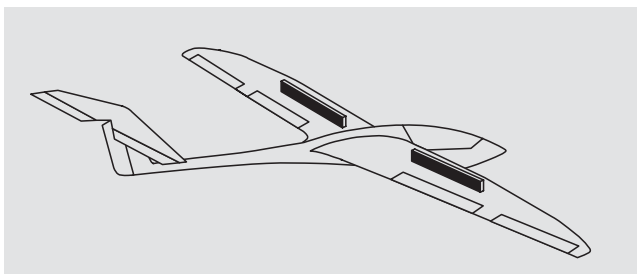

Finally, the receiver's behavior in the event of a failure should certainly be established in the menu...

»Fail Safe« (page 208)

| | | | | | | | | | | | | | | | | |
|---------------|---|---|---|---|---|---|---|---|---|----|----|----|----|----|-----|----|
| FAIL SAFE | | | | | | | | | | | | | | | | |
| Pos | | | | | | | | | | | | | | | | |
| hold | | | | | | | | | | | | | | | | |
| | 1 | 2 | 3 | 4 | 5 | 6 | 7 | 8 | 9 | 10 | 11 | 12 | 13 | 14 | 15 | 16 |
| DELAY : 0.25s | | | | | | | | | | | | | | | STO | |

... because "doing nothing" is the worst thing which can be done for a winged model.

In the transmitter's home position, "Hold" is specified and "Hold" means that the receiver continuously sends the last correctly recognized control impulse to the servos in the model. In the best case scenario the model flies straight ahead for an indefinite amount of time and then hopefully "lands" somewhere without causing significant damage! However, if something like this happens in the wrong place at the wrong time, the model may become uncontrollable and "tear" across the flight field completely out of control, putting the pilot and/or spectators at risk. Therefore, it would obviously be beneficial to program the the function "Motor off" at the very least, in order to prevent such risks.

With electro gliders, on the other hand, the fail-safe setting "motor off" can also be used, for example, for outlanding, to reliably stop the motor or its propeller by immediately switching off the transmitter after the landing.

The author usually prefers a "braking finish" within eyeshot to floating off "somewhere else".

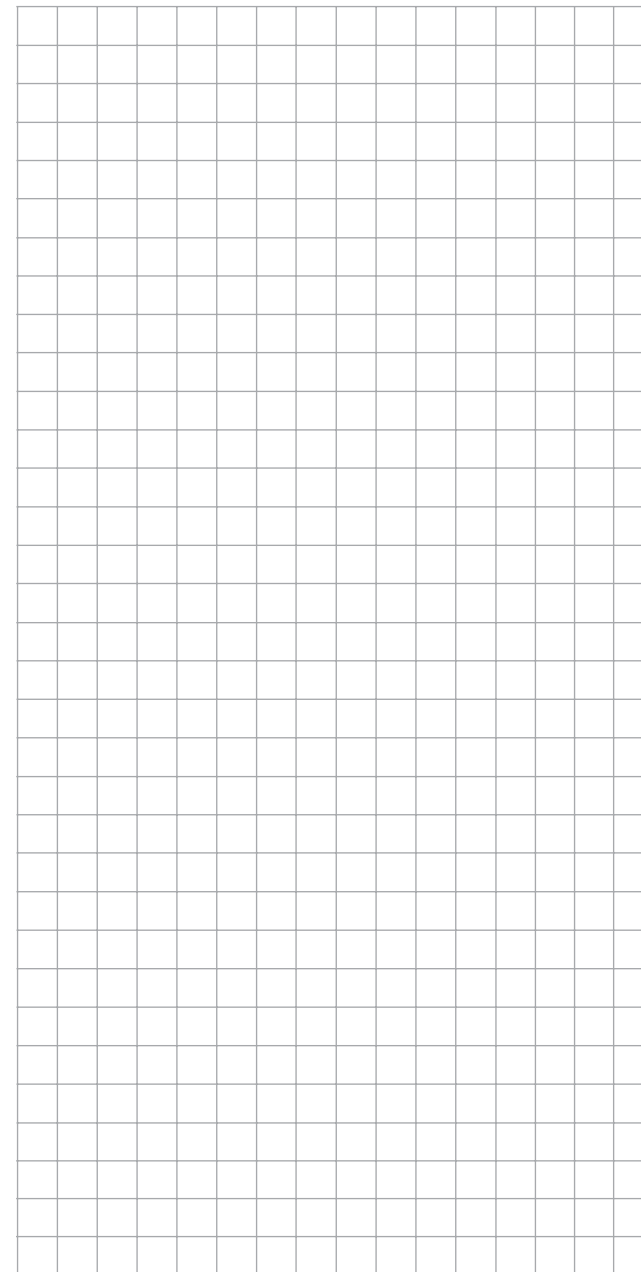

Integration of an electric drive into the model programming

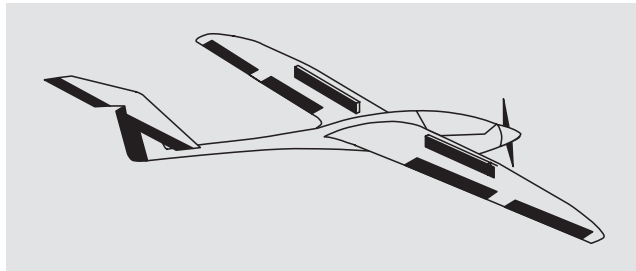

An electric drive can be controlled in different ways: The simplest method to integrate one such drive into the model programming is with the use of a throttle/ brake joystick (C1). However, since this is already specified for the brake system in the course of the model programming described above, either the switchable solution described beginning on page 279 or even the use of an alternative control is possible. As a suitable alternative, one of the two 3-position switches would be better than one of the proportionals controls. However, either one of the two side proportional rotary controls are also well suited to activation of a motor without having to let go of the joystick. An alternative would also be one of the two-stage switches. Basically, whatever switch is used should be located where it is within convenient reach. Before we turn to the individual examples, it is important must be noted that all inputs in the »Control adjust« menu can be selectively programmed as flight-phase specific ("PH" in the "Type" column) or model memory specific ("GL" in the "Type" column)!

However, since the drive should usually be available depending on the current flight phase, we recommend leaving the standard default "GL" ("global") in the "Type" column which your are using.

| | | | | | | | | |
|-----|----|----|-----|----|-------|-------|-----|-----|
| 15 | GL | fr | --- | 0% | +100% | +100% | 0.0 | 0.0 |
| 16 | GL | fr | --- | 0% | +100% | +100% | 0.0 | 0.0 |
| 17 | GL | fr | --- | 0% | +100% | +100% | 0.0 | 0.0 |
| ▶18 | GL | fr | --- | 0% | +100% | +100% | 0.0 | 0.0 |

▼ ▲ Typ SEL /_ offset - travel + -time+

A common option in the following examples 1 ... 5, the automatic tracking of the elevator trimming in the power flight, should also be mentioned at the beginning of this section:

If it becomes apparent after the initial power flights that the model must be continuously corrected with the elevator while the motor is switched on, this situation can be corrected by setting a free mixer and adjusting it accordingly. For this purpose, switch to the menu ...

»Free mixers«

... and program one of the linear mixers, Linear MIX 1 ... 8, or even one of the curve mixers, Curve MIX 9 ... 12, from "channel controlling the motor" according to "Ele", for example:

| | | | | |
|--------------|--|---------|--|-----|
| ▶LinearMIX 1 | | 8 → EL | | => |
| LinearMIX 2 | | ?? → ?? | | --- |
| LinearMIX 3 | | ?? → ?? | | --- |
| LinearMIX 4 | | ?? → ?? | | --- |
| LinearMIX 5 | | ?? → ?? | | --- |

▼ Typ from to /_ Adjust

On its second screen page, the required—usually low—correction value is entered:

Linear MIX 1 8 → EL

Mix input Offset
+4% +4% 0%

SYM ASY STO SET

Note:

The adjustment of a curve mixer is described in detail in the section »Channel 1 curve« starting on page 128.

Example 1

Proportional control usage

If one of these controls is used, the connection is very simple. Only the motor controller (speed control) has to be connected to a free servo connection 5 ... 16 of the receiver.

Bear in mind that, depending on the model type and number of aileron and flap servos, the output 2 + 5 or 6 + 7 are already linked.

Therefore connect your speed controller to the next free input and assign the selected input—for example, "Inp. 8"—to one of the transmitter's proportional controls, for example the left-side proportional rotary control. This is done in the menu ...

»Control adjust« (page 108)

Select the desired line with the ▲▼ selection keys of the left or right touch pad. A tap on the the center **SET** key of the right touch pad will activate "Switch and control assignment". Now move the selected proportional control. After a short time, an entry, e.g. "Cn2", will appear in the inverse video field.

| | | | | | | | | |
|---|----|-----|-----|----|-------|-------|-----|-----|
| 15 | GL | fr | --- | 0% | +100% | +100% | 0.0 | 0.0 |
| 16 | GL | fr | --- | 0% | +100% | +100% | 0.0 | 0.0 |
| 17 | GL | fr | --- | 0% | +100% | +100% | 0.0 | 0.0 |
| ▶18 | GL | Cn2 | --- | 0% | +100% | +100% | 0.0 | 0.0 |
| ▼ ▲ Typ SEL /- offset - travel + -time+ | | | | | | | | |

However, since propulsion must usually be available, independent of the current flight phase, leave the default value "GL" in the "Typ" column—as already mentioned earlier in this section.

If applicable, for necessary adjustment of appropriate control travel for the motor control (speed control), use one of the arrow keys to switch to the right into the "- travel +" column.

| | | | | | | | | |
|---|----|-----|-----|----|-------|-------|-----|-----|
| 15 | GL | fr | --- | 0% | +100% | +100% | 0.0 | 0.0 |
| 16 | GL | fr | --- | 0% | +100% | +100% | 0.0 | 0.0 |
| 17 | GL | fr | --- | 0% | +100% | +100% | 0.0 | 0.0 |
| ▶18 | GL | Cn2 | --- | 0% | +100% | +100% | 0.0 | 0.0 |
| ▼ ▲ Typ SEL /- offset - travel + -time+ | | | | | | | | |

This fields of this column can be use to set the travel required, even asymmetric if necessary.

A simultaneous tap on the ◀ ▶ keys of the left touch pad now will switch over to the »**Servo display**« where the selected proportional control can be activated to watch the the bars for channel 8 "wander" from one side to the other and back.

However, if the proportional control is moved too fast—in practice—the resulting sudden motor acceleration can briefly strain the entire drive train (too much). In this case, be sure to enter a value in the "- time +" column to counteract such a condition. Therefore, using one of the selection keys, switch

one column to the right, to the "- time +" column then move the selected control close to "full throttle" so the marker frame is only placed around one value field. Now enter a value of at least 1 s ...

| | | | | | | | | |
|---|----|-----|-----|----|-------|-------|-----|-----|
| 15 | GL | fr | --- | 0% | +100% | +100% | 0.0 | 0.0 |
| 16 | GL | fr | --- | 0% | +100% | +100% | 0.0 | 0.0 |
| 17 | GL | fr | --- | 0% | +100% | +100% | 0.0 | 0.0 |
| ▶18 | GL | Cn2 | --- | 0% | +100% | +100% | 0.0 | 1.0 |
| ▼ ▲ Typ SEL /- offset - travel + -time+ | | | | | | | | |

... with which a movement of the proportional control in the "ON" on direction which is too fast is processes move gently, and you can check immediately this by switching to the »**Servo display**«.

Note:

No delay is entered on the "OFF" side, so that the drive can be switched off instantly at any time. This does not additionally stress the drive, because it merely "runs down".

The adjustment of the appropriate control travel and directions for the motor control (speed control) is normally carried out in the »**Control adjust**« menu in the "- travel +" column. Alternatively, these settings can also be made in the menu ...

»**Servo adjustment**« (page 102)

| | | | | | | |
|------------------------------------|----|-------|------|------|------|------|
| Servo 4 | => | +100% | 100% | 100% | 150% | 150% |
| Servo 5 | => | +100% | 100% | 100% | 150% | 150% |
| Servo 6 | => | +100% | 100% | 100% | 150% | 150% |
| Servo 7 | => | +100% | 100% | 100% | 150% | 150% |
| ▶ Servo 8 | => | +100% | 100% | 100% | 150% | 150% |
| ▼ ▲ Rev cent. - travel + - limit + | | | | | | |

Example 2

2-way switch usage

This variant realizes a purely ON/OFF function. On the receiver side, either a simple electronic switch or—if a gentle motor start-up, for example, is desired—an appropriate motor control (speed control) is required.

With the exception of assigning a different operating element, the settings required for this are essentially the same as those described under Example 1. Therefore, the same comments and recommendations also apply.

Apart from the infinitely variable motor control under Example 1 and the two-stage motor control in this example, the selection of the two transmitter control types only has an effect on the type of timer control, see page 284.

Only the nature of the assignment and representation of the selected switch in the display of the menu ...

»**Control adjust**« (page 108)

As in example 1, change over to the line of a free input, activate the "Switch and control assignment" in the second column, page 56, then move the selected switch, in this case for example switch 2, from the desired motor OFF position in the direction of motor ON.

| | | | | | | | | |
|--|----|-----|-----|----|-------|-------|-----|-----|
| 15 | GL | fr | --- | 0% | +100% | +100% | 0.0 | 0.0 |
| 16 | GL | fr | --- | 0% | +100% | +100% | 0.0 | 0.0 |
| 17 | GL | fr | --- | 0% | +100% | +100% | 0.0 | 0.0 |
| ▶18 | GL | --- | 2 | 0% | +100% | +100% | 0.0 | 0.0 |
| ▼ ▲ Typ /- /- offset - travel + -time+ | | | | | | | | |

Here again—as already mentioned earlier in this section— leave the standard default "GL" in the "Typ" column.

The setting of the appropriate control travel for the motor control (speed control) is made in the "- Travel +" column. If the motor should up gently with the use of a motor control (speed control), an appropriate delay time can be set—as described in Example 1—in the "- time +" column:

| | | | | | | | | |
|-----|----|-----|-----|----|-------|-------|-----|-----|
| 15 | GL | fr | --- | 0% | +100% | +100% | 0.0 | 0.0 |
| 16 | GL | fr | --- | 0% | +100% | +100% | 0.0 | 0.0 |
| 17 | GL | fr | --- | 0% | +100% | +100% | 0.0 | 0.0 |
| ▶18 | GL | --- | 2 | 0% | +100% | +100% | 0.0 | 1.1 |

▼ ▲ Typ ↘ ↙ offset - travel + -time+

All other settings—as already mentioned earlier in the example—are made analogous to Example 1. Therefore, the same comments and recommendations also apply.

Note:

No delay is entered on the "OFF" side, so that the drive can be switched off instantly at any time. This does not additionally stress the drive, because it merely "runs down".

Example 3

3-way switch usage

This variant realizes a three-stage speed setting, such as Motor OFF, "half" and full power.

A corresponding motor control (speed control) is required on the receiver side.

The required settings are basically the same as those described under Example 1 and 2. Therefore, the same comments and recommendations also apply.

Apart from the infinitely variable motor control under Example 1 and the three-stage motor control in this example, the selection of the operating element only has an effect on the type of clock control, see page 284, and the nature of the assignment.

Here again—as already mentioned earlier in this section—leave the standard default "GL" in the "Typ" column.

Put the desired 3-way switch into its middle position then activate "Switch and control assignment" above the column with the switch symbol, as described on page 56. Now put the selected 3-way switch forward, out of its middle position:

| | | | | | | | | |
|-----|----|-----|-----|----|-------|-------|-----|-----|
| 15 | GL | fr | --- | 0% | +100% | +100% | 0.0 | 0.0 |
| 16 | GL | fr | --- | 0% | +100% | +100% | 0.0 | 0.0 |
| 17 | GL | fr | --- | 0% | +100% | +100% | 0.0 | 0.0 |
| ▶18 | GL | --- | 7 | 0% | +100% | +100% | 0.0 | 0.0 |

▼ ▲ Typ ↘ ↙ offset - travel + -time+

Now put the activated switch from its forward position back into its middle position.

Now move the marker frame to the left and into the column above the column now labeled with a second switch symbol instead of the previous label **SEL**.

Reactivate "Switch and control assignment" for this column then move the 3-way switch out of its middle position toward the rear:

| | | | | | | | | |
|-----|----|----|-----|----|-------|-------|-----|-----|
| 15 | GL | fr | --- | 0% | +100% | +100% | 0.0 | 0.0 |
| 16 | GL | fr | --- | 0% | +100% | +100% | 0.0 | 0.0 |
| 17 | GL | fr | --- | 0% | +100% | +100% | 0.0 | 0.0 |
| ▶18 | GL | 8 | 7 | 0% | +100% | +100% | 0.0 | 0.0 |

▼ ▲ Typ ↘ ↙ offset - travel + -time+

The setting of the appropriate control travel for the motor control (speed control) is made in the "- travel +" column. The motor should rev up gently with a motor control (speed control), to this end a suitable delay time can be set—as described in examples 1 and 2—in the "- time +" column:

All other settings—as already mentioned earlier in the example—are made analogous to Example 1. Therefore, the same comments and recommendations also apply.

Note:

By shifting the neutral position and subsequent adjustment of travel, the "half throttle position" can be influenced in the »Control adjust« menu by reducing travel from the offset value on the side to which the neutral point has been shifted and adding it to the other side. For example, an offset value of -20% results in +80% on the minus side of the travel setting and +120% on the plus side, and vice versa.

Control E-motor and crow alternately with C1 joystick

Example 4

Before we discuss the programming of this fourth example or turn the to the expansion of the previously described basic programming, a few words should be said about the position of the throttle/brake joystick with "Motor OFF" or "Brake OFF". Normally the C1 control joystick is moved forward for the throttle control and backward for the extension of the brake. However, if for this type of "traditional" assignment, for example, a switchover of the brake system is to take place for the "Motor OFF" condition (joystick "back") then a switchover to "full brake" would take place immediately after the pre-set switchover time specified in the »Phase settings« menu, and the opposite will take place when "brakes retracted" is switched over to propulsion causing the motor to switch over to "full power" within this time range ...

A "glider pilot" can make the best of this "Emergency" – normally with "brake retracted = front" – by switching to motor "ON" only if necessary so that power decreases, if applicable (and hopefully not forgetting to push the C1 joystick "forward" again when switching back). A typical "motor pilot", on the other hand, operates in the opposite manner, only switching to the brake if necessary, etc... You can also combine the "Zero point" of both systems to avoid confusion, whereby a "glider pilot" would tend prefer the "front" and a "motor pilot", on the other hand", would likely prefer the "rear".

Whichever the case may be, the **MC-20** HoTT transmitter permits both variants. In the following text, however, the combination of the two "OFF" positions to "front" is assumed. However, if you have a different preference, it is not a problem: The only difference from the described version lies in the logical selection of "Throttle min rear/front" and, if applicable, of a corresponding brake offset in the menu ...

»Model type« (beginning page 94)

Here you first specify in the "motor" line whether the throttle minimum position (= Motor "OFF" position) should be at the "front" or "rear" - as already discussed: In the following programming example, "Motor OFF" and "Brake OFF" are combined at "front":

| M O D E L T Y P E | | | |
|----------------------|-------|----------------|-----|
| ► Motor on C1 | | Thr. min front | |
| Tail type | | Normal | |
| Aileron/camber flaps | | 1 AIL | |
| Brake Offset | +100% | Input 1 | |
| ▼ | | | SEL |

Note:

With the selection of "Throttle min front/rear" the trimming will then only have an effect in the "idle" direction of the motor and is not the same as with the "none" entry, having the same effect at every position of the C1 joystick. Since the C1 trimming is not normally used with electric drives, however, this has no further relevance.

You adjust the "according to your model, in this case "normal".

In the "Aileron/flaps" line you enter the correct number of aileron and flap servos – in this example "2 AIL".

In the last line you leave the standard entries for the selection of "Brake retracted = front". On the other hand, if the preference is for "Brake retracted = rear", select the "Brake offset" line and define the offset point – as described on page 95 – as "rear". In the process, if the offset point is not placed completely at the end of the control travel, the remainder of the travel is "idle" up to this limit.

| M O D E L T Y P E | | | |
|----------------------|------|----------------|-----|
| Motor on C1 | | Thr. min front | |
| Tail type | | Normal | |
| Aileron/camber flaps | | 1 AIL | |
| ► Brake Offset | -90% | Input 1 | |
| ▼ | | | SEL |

This idle path ensures that all brake settings remain at "neutral", even with minor deviations from the limit of the brake flap control. At the same time, the effective control path is automatically spread to 100%.

For this reason, in the next step it must be ensured that the influence of the C1 joystick on the motor can be influenced. For this purpose, switch to the menu ...

»Phase settings« (page 142)

... and assign a meaningful name, such as "Normal", from the list for "Phase 1" after activation of the selection field in the "Name" column. The asterisk in the second column indicates which phase is currently active. As long as no phase switch has been assigned, this is always Phase 1. "Phase 2" can be given, appropriate to the example, the name «Landing».

In the "Ph.Tim" column you can assign a so-called flight phase timer for the measurement of the motor running time and/or the gliding times as necessary for each phase. You could, for example, assign one of the "Timers 1 ... 3" to the "Normal" flight phase in order to measure the total motor runtime via the C1 joystick:

| | | | | | |
|----------|---------|-------|-------|---------|---|
| Phase 1 | Normal | Clk1 | yes | 0.1s | * |
| ▶Phase 2 | Landing | | yes | 0.1s | - |
| Phase 3 | | | yes | 0.1s | - |
| Phase 4 | | | yes | 0.1s | - |
| Phase 5 | | | yes | 0.1s | - |
| ▼▲ | Name | Timer | Motor | Sw.time | |

Then the timer is controlled through a corresponding control switch to be defined on the C1 joystick. As soon as you switch to the "Landing" flight phase, this flight phase timer is automatically stopped and hidden in the base screen. More about this can be found on page 156.

Now move the marker frame over the "Ph.Tim" column to the "Motor" column to the right. Here you can decide with "yes/no" in which phase the motor is controlled by the throttle/brake joystick and the brake system to be adjusted in the "Brake settings" sub-menu of the »Wing mixers« menu should be shut off (= "yes") and vice versa (= "no"):

| | | | | | |
|----------|---------|-------|-------|---------|---|
| Phase 1 | Normal | Clk1 | yes | 0.1s | * |
| ▶Phase 2 | Landing | | no | 0.1s | - |
| Phase 3 | | | yes | 0.1s | - |
| Phase 4 | | | yes | 0.1s | - |
| Phase 5 | | | yes | 0.1s | - |
| ▼▲ | Name | Timer | Motor | Sw.time | |

Now move the marker frame once more to the right and enter an appropriate switching time after activation of the value field of the "Sw.Time" column; for example:

| | | | | | |
|----------|---------|-------|-------|---------|---|
| Phase 1 | Normal | Clk1 | yes | 1.1s | * |
| ▶Phase 2 | Landing | | no | 1.1s | - |
| Phase 3 | | | yes | 0.1s | - |
| Phase 4 | | | yes | 0.1s | - |
| Phase 5 | | | yes | 0.1s | - |
| ▼▲ | Name | Timer | Motor | Sw.time | |

Then you must assigned these two flight phases to a switch with which you can switch between the two flight phases during the flight. In this case, a single switch is sufficient. It should be easy to reach, however, so that you can still switch between "motor" and "brake" during a landing approach, for example, without having to release a joystick.

The assignment of the selected switch takes place in the menu ...

»Phase assignment« (page 148)

Select the switch symbol under "C" with one of the selection keys. Following a brief tap on the center **SET** key of the right touch pad, actuate the desired switch, e.g "2".

| | | | | | |
|-------------------------------|-------|-------------------------------------|----|----|-------------|
| P H A S E A S S I G N M E N T | | | | | |
| Prior. | combi | | | | |
| A B | C | D | E | F | |
| | | 2I | | | |
| /- | /- | <input checked="" type="checkbox"/> | /- | /- | /- |
| | | | | | <1 Normal > |

Both switch positions, in other words ON (I) and OFF (I), are initially assigned at the bottom right of the display to phase «1 Normal». Select this value field with one of the selection keys then activate the phase selection list that was set up in the »Phase settings« menu with a brief tap on the center **SET** key of the right touch pad. For example, you name

the phase for the front switch position "normal" and "landing" for the rear position (or vice versa):

| | | | | | |
|-------------------------------|-------|-------------------------------------|----|----|-------------|
| P H A S E A S S I G N M E N T | | | | | |
| Prior. | combi | | | | |
| A B | C | D | E | F | |
| | | 2I | | | |
| /- | /- | <input checked="" type="checkbox"/> | /- | /- | /- |
| | | | | | <2Landing > |

These phase names then appear in all flight-phase dependent menus and, of course, also in the base screen of the transmitter.

Now switch to the «Landing» flight phase and in the "Crow" line of the sub-menu ...

»Brake settings« (page 172)

| | |
|---------------------------|----|
| B R A K E S E T T I N G S | |
| ▶Crow | 0% |
| Diff. reduct. | |
| Elevat. curve | => |
| <<Landing >> | |
| ▼ | QR |

... of the »Wing mixers« menu, set the desired throw of the ailerons by actuation of the C1 joystick ("brake") upward. Then, if applicable, switch to the "FL" column in order to specify the desired through of the flaps with C1 actuation downward (hidden in the figure above). This flap position is referred to as "Crow position" or "Butterfly"; see also page 172.

In the line "Diff. reduct." (differentiation reduction), enter a value which corresponds to the value entered or want to enter on the first page of the »Wing mixers« menu in the "Aile.diff." line.

With the "Elevat curve" mixer the normally occurring "Upward tilting" of the model on the raising of the

ailerons can be automatically suppressed. The suitable correction values for the respective value must be tested out through flight. Set this mixer so that the flight speed of the model does not change too much with the brake system extended in comparison with the "normal" flight speed. Otherwise, there is the risk, among other things, that the model plunges when the brake system is retracted, e.g. for the extension of a landing approach which is too short. If everything is correctly set so far, only the motor is controlled with the C1 joystick in the "Normal" flight phase, whereas this should be switched off in the flight phase "landing" (Servo 1 in »**Servo display**« independent of "Throttle min front/rear" to -100% or adequately for a servo travel setting deviating by 100%, if necessary). In this flight phase the C1 joystick then only controls the raising of the ailerons and, if applicable, the lowering of the flaps with the neutral point in the C1 control position selected per offset.

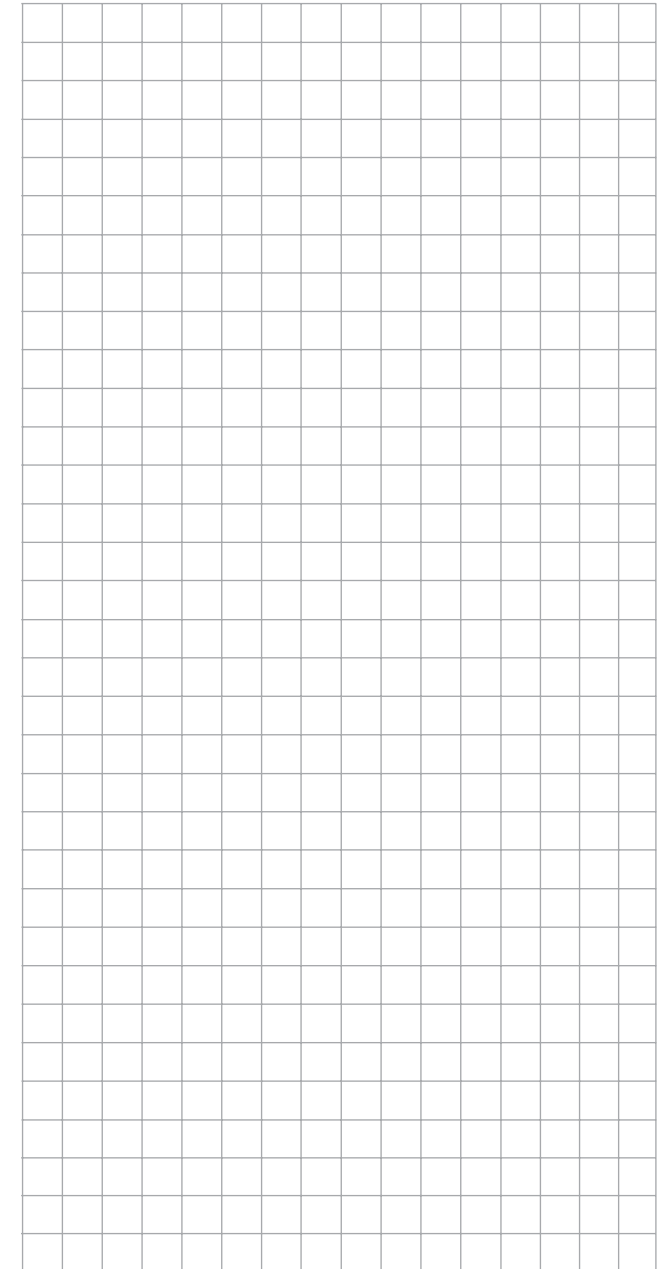
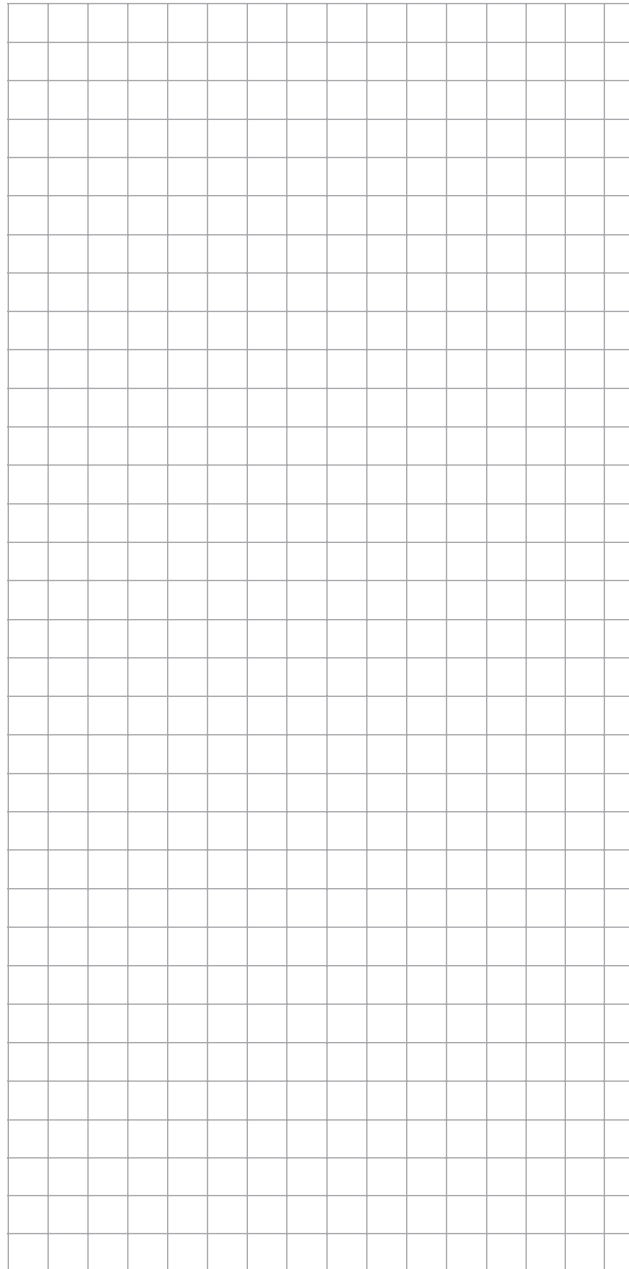

C1 joystick switchable between E-motor and spoiler

Example 5

If, contrary to the assumptions of the preceding Example 4, the model has additional spoilers or only spoilers, they can be incorporated into the control of the model by means of the following programming.

Do this by programming the menus »**Model type**«, »**Phase settings**« and »**Phase assignment**« in the same manner as described under Example 4. The settings described there in the "Brake settings" sub-menu of the »**Wing mixers**« menu are only then relevant if an additional crow system is to be employed in parallel with the spoilers.

With the settings described under Example 4, the control of the E-motor and, if applicable, that of a crow system will function as usual. Only the control of a spoiler connected to Output 8, for example, must additionally be programmed. For this purpose, switch to the menu ...

»**Control adjust**« (page 108)

... and switch into the «**normal**» flight phase.

Now use the selection keys to switch to the left into the "Typ" column to set the parameter in this line, e.g. "I8" from "GL(lobal)" to "PH(ase)", so that the settings too follow become effective on a flight-phase specific basis.

| | | | | | | | |
|--|----|----|-----|----|-------|-------|---------|
| 15 | GL | fr | --- | 0% | +100% | +100% | 0.0 0.0 |
| 16 | GL | fr | --- | 0% | +100% | +100% | 0.0 0.0 |
| 17 | GL | fr | --- | 0% | +100% | +100% | 0.0 0.0 |
| ▶18 | PH | fr | --- | 0% | +100% | +100% | 0.0 0.0 |
| «Normal » | | | | | | | |
| ▼ ▲ Typ SEL ↙ _ offset – travel + –time+ | | | | | | | |

Afterward, switch to the "Offset" column and, following activation of the value field with a brief tap on the **SET** key of the right touch pad, change the offset value for this Input 8 value field now displayed in inverse video until the spoilers are again

"retracted", e.g.:

| | | | | | | | |
|--|----|----|-----|------|-------|-------|---------|
| 15 | GL | fr | --- | 0% | +100% | +100% | 0.0 0.0 |
| 16 | GL | fr | --- | 0% | +100% | +100% | 0.0 0.0 |
| 17 | GL | fr | --- | 0% | +100% | +100% | 0.0 0.0 |
| ▶18 | PH | fr | --- | -95% | +100% | +100% | 0.0 0.0 |
| «Normal » | | | | | | | |
| ▼ ▲ Typ SEL ↙ _ offset – travel + –time+ | | | | | | | |

Confirm this setting with a brief tap on the center **ESC** key of the left key pad or the center **SET** key of the right touch pad then switch to the left into the column above **SEL**. Now switch to the flight phase «**Landing**» then briefly tap on the center **SET** key of the right touch pad. The display shows the window ...

| | | | | | | | |
|--|----|----|-----|----|-------|-------|---------|
| 15 | GL | fr | --- | 0% | +100% | +100% | 0.0 0.0 |
| 16 | GL | fr | --- | 0% | +100% | +100% | 0.0 0.0 |
| 17 | GL | fr | --- | 0% | +100% | +100% | 0.0 0.0 |
| ▶18 | PH | fr | --- | 0% | +100% | +100% | 0.0 0.0 |
| «Landing » | | | | | | | |
| ▼ ▲ Typ SEL ↙ _ offset – travel + –time+ | | | | | | | |

Now move the C1 joystick As soon as this is recognized, "Cn1" will appear in the display instead of "fr":

| | | | | | | | |
|--|----|-----|-----|----|-------|-------|---------|
| 15 | GL | fr | --- | 0% | +100% | +100% | 0.0 0.0 |
| 16 | GL | fr | --- | 0% | +100% | +100% | 0.0 0.0 |
| 17 | GL | fr | --- | 0% | +100% | +100% | 0.0 0.0 |
| ▶18 | PH | Cn1 | --- | 0% | +100% | +100% | 0.0 0.0 |
| «Landing » | | | | | | | |
| ▼ ▲ Typ SEL ↙ _ offset – travel + –time+ | | | | | | | |

Leave the offset value in this flight phase at "0%". It may be necessary to change the leading symbol of the travel setting to reverse the control direction. Do this by switching the travel setting from

+100% to -100% in the "travel" column.

Now we are practically finished. Check the programming in the »**Servo display**« menu, which you can reach from the base screen of the transmitter as well as nearly every other menu position with a simultaneous tap on ◀ ▶ keys of the left touch pad. You will discover that "Servo 1" (motor control) is controlled in the "Normal" phase and in the "landing" phase only the spoiler is controlled at "Servo 8" and, if applicable the aileron and flap servos—just as we intended.

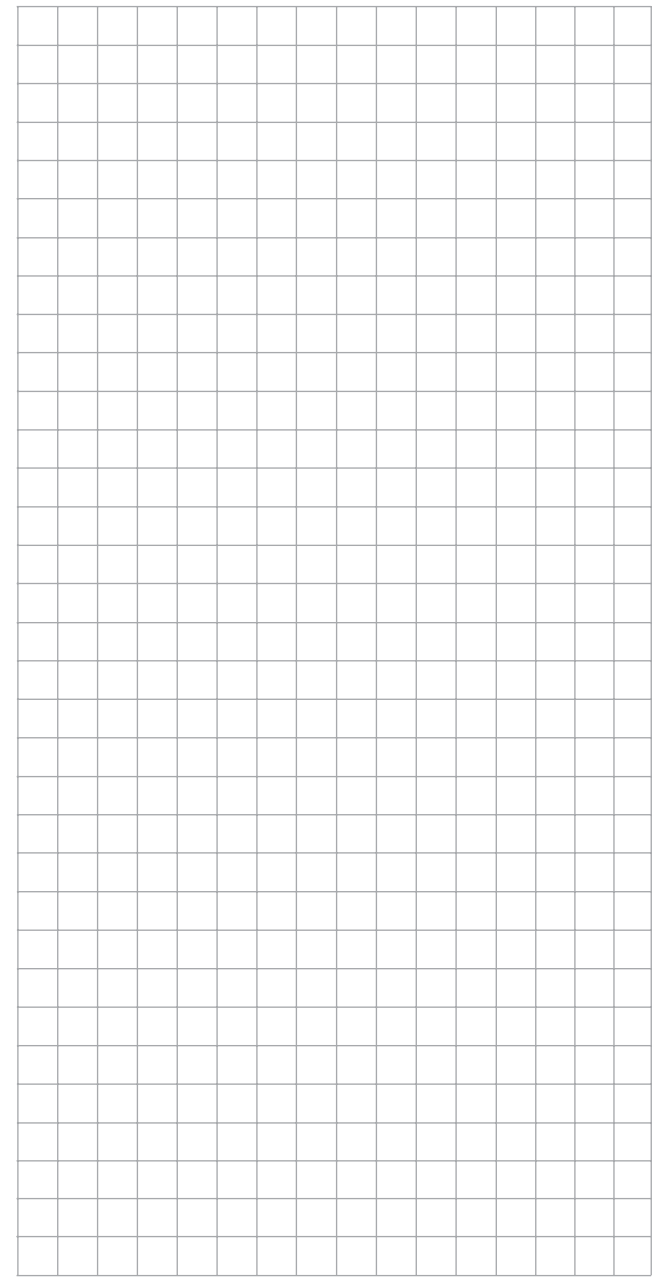
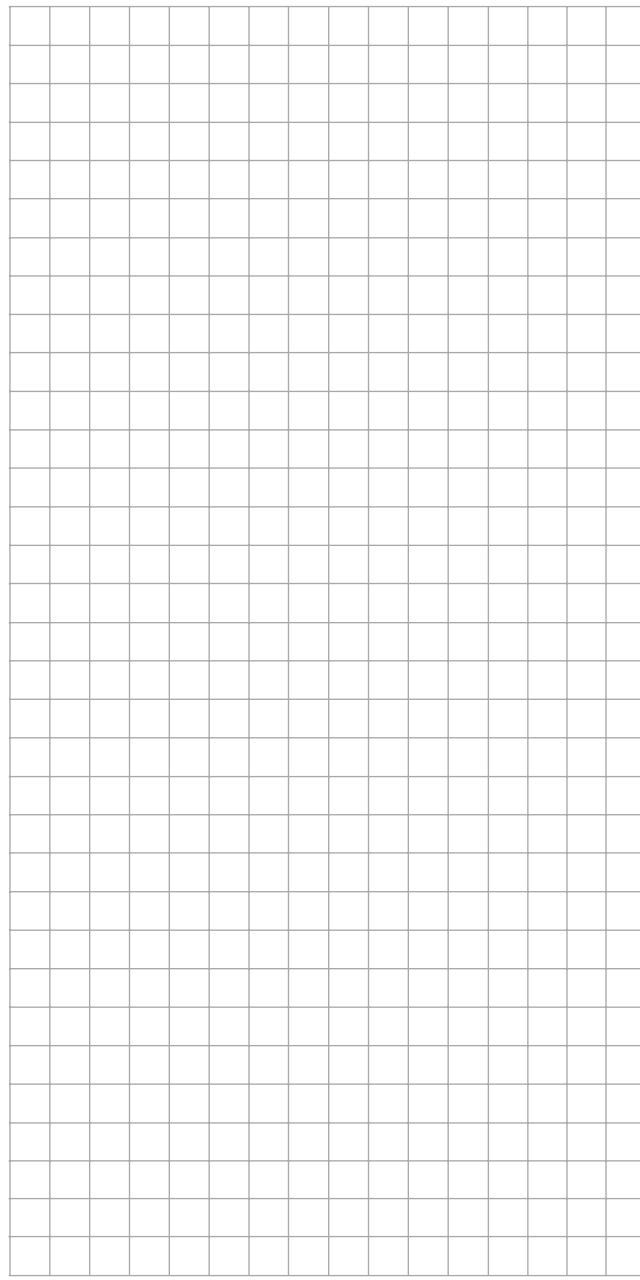
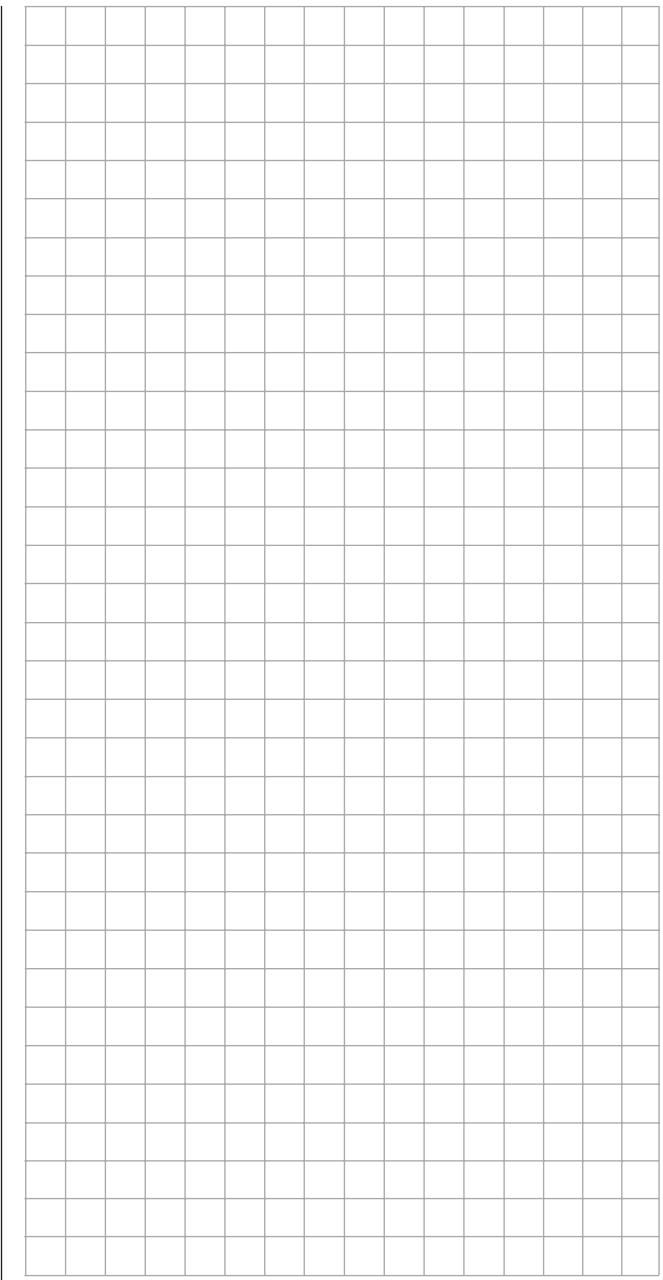



Timer confirmation with control or switch

Examples 4 and 5 of the preceding pages

If model programming is to be continued for **Example 4**, page 279 or **Example 5**, page 282 as described on previous pages or, completely independent of this example programming, the C1 joystick (throttle/brake joystick) is to be used for power regulation, then a control switch can be used to automatically start and stop the stopwatch. For this purpose, first switch to the menu ...

»Control switch« (page 135)

... and select the line of a control switch which has not been assigned yet with the selection keys. After activation of the control assignment with a brief tap on the center **SET** key of the right touch pad, the following window will appear:

| CONTROL SWITCH | | | | | |
|----------------|------|---------------------------|----|-----|------|
| ►C1 | fre | Move desired control adj. | | --- | C1 ↵ |
| C2 | fre | | | --- | C2 ↵ |
| C3 | free | 0% | => | --- | C3 ↵ |
| C4 | free | 0% | => | --- | C4 ↵ |
| ▼ | SEL | | | | |

Now simply move the C1 joystick (throttle/brake joystick) from the motor "OFF" position in the motor "ON" direction.

Thereafter, change to the column above **STO** by using the appropriate selection key, move the C1 joystick close to its motor "OFF" position then set the switch-point at the selected position with a brief tap on the center **SET** key of the right touch pad. The switch's state will be displayed at the right of the control number, e.g.:

| CONTROL SWITCH | | | | | |
|----------------|--------|------|-----|-----|------|
| ►C1 | Cnt. 1 | -85% | => | --- | C1 |
| C2 | free | 0% | => | --- | C2 ↵ |
| C3 | free | 0% | => | --- | C3 ↵ |
| C4 | free | 0% | => | --- | C4 ↵ |
| ▼ | SEL | STO | SEL | ↙ | |

In order to assign the control switch you just created to the desired timer, switch to the menu ...

»Timers (in general)« (page 152 ... 154)

... and select the line "Top" with the selection keys. This is the standard line assigned to the stopwatch. In this line, move the marker frame over the "Timer" column to the right, to the column above the switch symbol, using the appropriate selection key of the left or right touch pad. Now tap twice on the center **SET** key of the right touch pad: The first tap will activate the switch assignment, the second tap will call up the list of "expanded switches":

| | | |
|--------------------------|--------|---------|
| Model time | 12:34h | --- |
| Batt. | M | --- |
| ►Top | to | --- |
| Centr | (e | --- |
| Control/Logic/fix switch | | |
| ►C1 C2 C3 C4 C5 C6 | | |
| C7 C8 FX FXi L1 L2 | | |
| ▼ ▲ | Timer | Alarm ↙ |

Now select the previously programmed control switch, C1 in the example, and assign it to the timer with a brief tap on the center **SET** key of the right touch pad:

| | | |
|------------|--------------|-------------|
| Modeltime | 12:34h | --- |
| Batt. time | 1:23h | --- |
| ►Top | : Stop watch | 0:00 0s C1 |
| Centr: | Flight tim | 0:00 0s --- |
| ▼ ▲ | Timer | Alarm ↙ |

The timer in the base screen now starts with movement of the C1 joystick toward full throttle and stops if you pull the C1 joystick back over the switching point.

Example 1 of the preceding pages

If you have decided to continue with the model programming described on the previous pages in Example 1 on page 276, first switch to the menu ...

»Control switch« (page 135)

... and select the line of a control switch which has not been assigned yet with the selection keys. After activation of the control assignment with a brief tap on the center **SET** key of the right touch pad, the following window will appear:

| CONTROL SWITCH | | | | | |
|----------------|------|---------------------------|----|-----|------|
| ►C1 | fre | Move desired control adj. | | --- | C1 ↵ |
| C2 | fre | | | --- | C2 ↵ |
| C3 | free | 0% | => | --- | C3 ↵ |
| C4 | free | 0% | => | --- | C4 ↵ |
| ▼ | SEL | | | | |

Now simply move the respective proportional control, e.g. the left side proportional rotary control from its motor "OFF" position toward the motor "ON" direction.

Thereafter, change to the column above **STO** by using the appropriate selection key, move the selected control near its motor "OFF" position then

set the switch-point at the selected position with a brief tap on the center **SET** key of the right touch pad. The switch status is shown to the right of the control number:

| CONTROL SWITCH | | | | | |
|----------------|--------|------|-----|------|------|
| ►C1 | Slide2 | -85% | => | ---- | C1 |
| C2 | free | 0% | => | ---- | C2 ↓ |
| C3 | free | 0% | => | ---- | C3 ↓ |
| C4 | free | 0% | => | ---- | C4 ↓ |
| ▼ | SEL | STO | SEL | ↘ | |

Note:

Now place the switching point; but do not put it at the limit position of the control, because safe switching is not assured when doing so.

Ct1 used in the example here should be "closed" in the "full throttle" direction and "open" below the switching point.

Now switch to the menu ...

»Timers (in general)« (page 152 ... 154)

... and select the line "Top" with the selection keys. This is the standard line assigned to the stopwatch. In this line, move the marker frame over the "Timer" column to the right, to the column above the switch symbol, using the appropriate selection key of the left or right touch pad. Now tap twice on the center **SET** key of the right touch: The first tap will activate the switch assignment, the second tap will call up the list of "expanded switches":

| | | |
|---------------------------------|--------------------|------|
| Model time | 12:34h | ---- |
| Batt. time | 1:23h | ---- |
| ►Top : Control/Logic/fix switch | | ---- |
| Centr (e) | C1 C2 C3 C4 C5 C6 | ---- |
| | C7 C8 FX FXi L1 L2 | ---- |
| ▼ ▲ | Timer Alarm | ↘ |

Now select the previously programmed control switch "C1" then tap on the center **SET** key of the right touch pad.

| | | |
|-------------------|-------------|------|
| Modeltime | 12:34h | ---- |
| Batt. time | 1:23h | ---- |
| ►Top : Stop watch | 0:00 0s | C1 ↓ |
| Centr: Flight tim | 0:00 0s | ---- |
| ▼ ▲ | Timer Alarm | ↘ |

The stopwatch in the basic display now starts with movement of the proportional rotary control toward full throttle and stops if it is turned back again over the switch-point.

Examples 2 and 3 of the preceding pages

If you control your motor with a switch, on the other hand, you do not need the described control switch described above. It is completely sufficient if you assign the same switch to the timer, so that it also begins to run when you switch on the motor.

Tip:

If the motor run time for an E-model is limited by the battery capacity, you can have the stopwatch count down. Enter the maximum permissible motor run time in the "Timer" column, e.g. "5 min", and shortly before expiration of permissible time, e.g. "30 s" before, have the transmitter issue an acoustic warning signal:

| | | |
|-------------------|-------------|------|
| Model time | 12:34h | ---- |
| Batt. time | 1:23h | ---- |
| ►Top : Stop watch | 5:00 30s | 7 ↓ |
| Centr: Flight tim | 0:00 0s | ---- |
| ▼ ▲ | Timer Alarm | ↘ |

Parallel operating servos

A second servo running in parallel is often required, such as when brake flaps or spoilers installed in the wings or the left and right elevator or a double fin should be actuated by a servo or a large rudder flap should be simultaneously controlled by two servos due to high throw forces.

In principle, this task could also be solved by connecting the servos together on the model side using V-cable. However, the disadvantage here is that servos combined in this manner can no longer be adjusted individually and separately from the transmitter—thus negating the potential for finely tuning respective servos to one another with a computerized remote control system. A similar situation is given for the so-called "Channel mapping" feature of the »**Telemetry**« menu. Here too there are certain limitations involved when compared to the transmitter's adjustment possibilities.

The first example, therefore, describes the coupling of two brake or spoiler servos, the second describes the operation of two or more throttle servos and the third describes the coupling of two elevator servos.

The "two rudder servos" example on the next page describes the coupling of two rudder servos, whereas Variant 1 is preferable for applications of this type because the use of a **cross-mixer**« is quicker and easier to program. In contrast, the second variant, also described on the next page, additionally permits asymmetric and/or non-linear curves through use of the »**Free mixer**« menu.

Two brake or spoiler servos

In a situation where there is one installed servo for operation of brake flaps and/or spoilers in each wing half then the pre-set linear control characteristics for the »**Channel 1 curve**« menu should remain unchanged.

Then connect one of the two servos to Output 1, provided for this purpose by standard, and the second to an arbitrary free receiver connection 5 ... 16, such as Output "8". Subsequently switch to the menu ...

»**Control adjust**« (page 108)

... and, using the selection keys, assign "Control 1" in the Input 8 line :

| | | | | | | | | |
|-----|----|-----|-----|----|-------|-------|-----|-----|
| 15 | GL | fr | --- | 0% | +100% | +100% | 0.0 | 0.0 |
| 16 | GL | fr | --- | 0% | +100% | +100% | 0.0 | 0.0 |
| 17 | GL | fr | --- | 0% | +100% | +100% | 0.0 | 0.0 |
| ▶18 | GL | Cn1 | --- | 0% | +100% | +100% | 0.0 | 0.0 |

▼ ▲ Typ SEL / _ offset - travel + -time+

Since the spoiler on Output 1 can normally only be operated on a flight-phase dependent basis, it is strongly recommended that the "Typ" column for the input used is left at its "GL" default setting.

Also the remaining values should be left at their default settings. If necessary, carry out the required servo travel adjustments in the »**Servo adjustment**« menu. There you can also adjust the travel of servo 1 and 8 to one another, if necessary.

Multiple-motor aircraft

As described above, a model can also be operated with two or more motors.

The first throttle servo and/or the first motor control is connected as usual to (receiver) Output 1 and each additional throttle servo and/or each additional motor control is connected to a free (receiver) Output 6 ... 12. The inputs of respective assigned control channels are then each assigned to Control 1; for example :

| | | | | | | | | |
|------|----|-----|-----|----|-------|-------|-----|-----|
| I9 | GL | Cn1 | --- | 0% | +100% | +100% | 0.0 | 0.0 |
| I10 | GL | Cn1 | --- | 0% | +100% | +100% | 0.0 | 0.0 |
| I11 | GL | Cn1 | --- | 0% | +100% | +100% | 0.0 | 0.0 |
| ▶I12 | GL | Cn1 | --- | 0% | +100% | +100% | 0.0 | 0.0 |

«Normal »

▼ ▲ Typ SEL / _ offset - travel + -time+

Important notice:

Since the motor control unit should be available regardless of a currently active flight phase, make sure to leave the standard default "GL" in the "Type" column.

Two elevator servos

Two elevator servos should be switched in parallel. According to the receiver assignment plan, see page 61, the receiver output 8 is intended for the connection of the second elevator servo.

This would be taken into account on the software side in the pre-configuration of a corresponding mixer. You can find this in the ...

»**Model type**« (page 94)

In this menu, switch to the "Tail" line using the selection keys, activate the value field with a brief tap on the center **SET** key of the right key pad then select the entry "2ELSV3+8":

| MODEL TYPE | | | |
|----------------------|-------------|---------|--|
| Motor on C1 | none | | |
| ► Tail type | 2 EL Sv 3+8 | | |
| Aileron/camber flaps | 1 QR | | |
| Brake Offset | +100% | Input 1 | |
| ▼ ▲ | SEL | | |

Then do the fine-tuning for travel of the two servos "in the now familiar manner" in the »**Servo adjustment**« menu.

Two rudders

We want to switch two rudders "in parallel". The second rudder is located at the free receiver output 8.

Variant 1

In the menu ...

»Dual mixer« (page 206)

... select one of the cross-mixers and enter "8" and "RU" in its left and center value fields, as shown in the figure:

| DUAL MIXER | | | |
|------------|---------|------|----|
| ► Mixer 1 | ▲ 8 ▲▲ | RU ▼ | 0% |
| Mixer 2 | ▲ ?? ▲▲ | ?? ▼ | 0% |
| Mixer 3 | ▲ ?? ▲▲ | ?? ▼ | 0% |
| Mixer 4 | ▲ ?? ▲▲ | ?? ▼ | 0% |
| ▼ | Diff. | | |

The same deflection "▲ ▲", which would take place through "Input 8" must not have an effect here. Therefore, you should make absolutely sure in the ...

»Control adjust« (page 108)

| | | | | | | | | |
|-----------|-----|-----|-----|--------|-------|--------|-----|--------|
| 15 | GL | fr | --- | 0% | +100% | +100% | 0.0 | 0.0 |
| 16 | GL | fr | --- | 0% | +100% | +100% | 0.0 | 0.0 |
| 17 | GL | fr | --- | 0% | +100% | +100% | 0.0 | 0.0 |
| ► 18 | GL | fr | --- | 0% | +100% | +100% | 0.0 | 0.0 |
| «Normal » | | | | | | | | |
| ▼ ▲ | Typ | SEL | ↙ | offset | - | travel | + | -time+ |

... that "Input 8" "GL(oba)" is set to "free" so the control function is separate from the control channel over all flight phases.

Alternatively, Input 8 can be set to "no control" in the »**Mix only channel**« menu on a *flight-phase independent basis* by setting Channel 8 to "MIXonly".

| MIX ONLY CHANNEL | | | | | | | | | | | | | | | | |
|------------------|---|---|---|---|---|---|---|---|---|----|----|----|----|----|----|----|
| MIXonly | | | | | | | | | | | | | | | | |
| normal | | | | | | | | | | | | | | | | |
| | 1 | 2 | 3 | 4 | 5 | 6 | 7 | 8 | 9 | 10 | 11 | 12 | 13 | 14 | 15 | 16 |

Variant 2

This variant uses the ...

»Free mixers« (beginning page 193)

... menu to set a "Tr RU → 8". In the "Type" column, select the setting "Tr" so that the rudder trimming affects both rudder servos:

| | | | | |
|---------------|------|---------|----|----------|
| ► LinearMIX 1 | Tr | RU → 8 | | ⇒ |
| LinearMIX 2 | | ?? → ?? | | — |
| LinearMIX 3 | | ?? → ?? | | — |
| LinearMIX 4 | | ?? → ?? | | — |
| LinearMIX 5 | | ?? → ?? | | — |
| ▼ | type | from | to | ↙ Adjust |

Afterwards, switch to the graphic screen and set a symmetric mix of +100%.

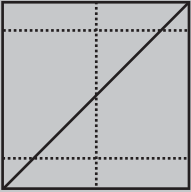
| | | |
|--------------|---------|---|
| Linear MIX 1 | RU → 8 |  |
| Mix input | Offset | |
| +100% +100% | 0% | |
| SYM ASY | STO SET | |

Here too, "Input 8" should also be programmed—if applicable, for all flight phases—to "free" by way of the »**Control adjust**« menu. However, control function "8" can be separated from control channel "8" more easily in the flight-phase independent »**Mix only channel**« menu, page 205:

| MIX ONLY CHANNEL | | | | | | | | | | | | | | | | |
|------------------|---|---|---|---|---|---|---|---|---|----|----|----|----|----|----|----|
| MIXonly | | | | | | | | | | | | | | | | |
| normal | | | | | | | | | | | | | | | | |
| | 1 | 2 | 3 | 4 | 5 | 6 | 7 | 8 | 9 | 10 | 11 | 12 | 13 | 14 | 15 | 16 |

Using flight phases

Up to 8 different flight phases (flight conditions) can be programmed with settings independent of one another within each the model memory.

Each of these flight phases can be called with a switch or a switch combination. This makes it possible to program different settings for various flight states, such as «Normal», «Thermal», «Speed», «Distance», etc., then make in-flight changeovers in a most convenient manner. However, with the flight phase programming you can also make slight modifications, e.g. of mixers, to try out by switching during the flight in order to find the optimal settings for each model more easily.

Before actual programming of flight phases can begin, consideration should be given to whether the digital trimming of transverse, altitude and side should be "GL(lobal)"—in other words, applicable to all flight phases—or per "PH(ase)"—in other words, each flight phase individually variable.

If you decide in favor of a phase-specific trimming of the elevator, for example, switch the menu ...

»Stick mode« (page 104)

... and change the standard "global" default accordingly. The same applies for the number of trimming steps in the "Tr. step" column:

| | | | | |
|-------------|--------|----------|--------|------|
| ▶ Channel 1 | global | 4 | 0.0s | 0.0s |
| Aileron | global | 4 | 0.0s | 0.0s |
| Elevator | global | 4 | 0.0s | 0.0s |
| Rudder | global | 4 | 0.0s | 0.0s |
| | Trim | Tr. step | - time | + |

Example 1 ...

... continuing with the previous programming of an electric glider with 2 aileron servos.

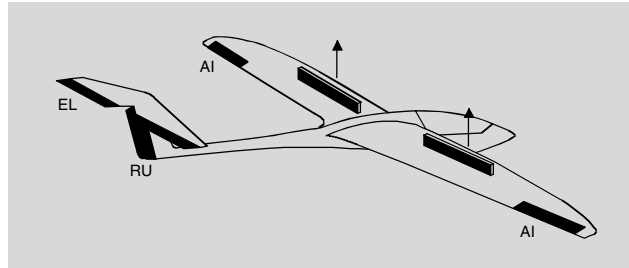

Control of the electric motor is accomplished, independent of the C1 joystick, with one of the two side proportional rotary controls or one of the two standard 3-way switches mounted into the switch panels. The motor's speed control is connected to receiver output 8 as described on page 276 and continued in Examples 1 and 2. This is why "none" was selected for the "Motor on C1" line in the »Model type« menu. This not only causes the column "Motor" in the »Phase settings« menu to be unavailable but also allows all options to be available without restriction in the "Brake settings" sub-menu of the »Wing mixers« menu.

1st Step

»Phase settings« (page 142)

| | | | | |
|-----------|---------|-------|---------|---|
| Phase 1 | Normal | | 0.1s | * |
| Phase 2 | Thermal | | 0.1s | - |
| Phase 3 | Speed | | 0.1s | - |
| ▶ Phase 4 | Launch | | 0.1s | - |
| Phase 5 | | | 0.1s | - |
| ▼ ▲ | Name | Timer | Sw.time | |

Initially, one or multiple flight phases are provided with a specific identification ("Name") for the respective flight status. This identification has no influence on the programming of the transmitter; it only serves for an improved differentiation of the individual flight phases and is shown later in all flight-phase dependent menus and in the base screen. The selection of the respective line, a name and the setting of the switchover time is done in the "usual" manner, with a tap on the appropriate key(s) of the two four-way touch pads.

Note:

With the exception of Phase 1, which should always be assigned with the name "Normal" since it is always active, if the flight phases are deactivated, it is completely irrelevant which name is assigned to which phase!

In everyday use by a model pilot, three to a maximum of four flight phases are usually completely sufficient:

- "Start" with the climb settings
- "Thermal" for "Flying high",
- "Normal" for normal conditions and
- "Speed" for high gear.

In the "Sw.time" column (switching time) ...

| | | | | |
|-----------|---------|-------|---------|---|
| ▶ Phase 1 | Normal | | 1.0s | * |
| Phase 2 | Thermal | | 0.1s | - |
| Phase 3 | Speed | | 0.1s | - |
| Phase 4 | Launch | | 0.1s | - |
| Phase 5 | | | 0.1s | - |
| ▼ ▲ | Name | Timer | Sw.time | |

... a "blend-in" time can be established for the time in which a changeover from any other flight phase into this given flight-phase is to be accomplished in order to permit a "smooth" transition for different servo

positions. Thus, an increased stress of the model under certain circumstances with a "hard" change of rudder or flap positions, for example, is prevented. The "Status" column shows you the currently active flight phase with an asterisk "*".

2nd Step

In order to actually be able to switch between the individual flight phases, the assignment of one or multiple switches is necessary. Either one of the two three-way switches is ideally suited for switching between up to three flight phases.

Each of the two switch end positions *starting from the center position* will be assigned to one of the flight phase switches A ... F. The assignment of the switch takes place in the menu ...

»Phase assignment« (page 148)

First select "C" with the marker frame. Then briefly tap on the center **SET** key of the right touch pad and move the switch from its center position to one of its end-positions, for example, downward:

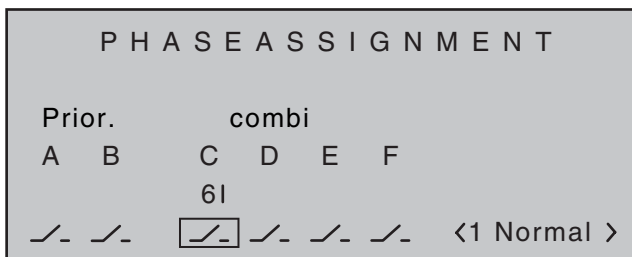

Move the switch back to the center position and then select "D", and after activation of the switch assignment, move the switch to the other limit position, for example, to the top:



Now the 3-way switch is programmed.

Now an additional switch could be assigned for the "start" flight phase, if applicable. In this case under "A", so that the "start" phase is always switched to from every other flight phase in parallel to the switching-on of the motor:



The given switch positions must then be assigned to respective flight phases (names). Although some flight phases have already been assigned to names, the phase name «1 Normal» will always initially appear at the right in the display; see the figures above.

First move the 3-way switch to one of its limit positions, for example to the top, and switch with the marker frame in the display down to the right to set the flight phase name. Briefly tap on the center **SET** key of the right touch pad to activate the entry field then select the desired flight phase for this switch position, in this example «2 Thermal», with the selection keys:



Proceed in the same manner for the other switch limit position, which is assigned the name "3 Speed".

If applicable move Switch 2 and assign this switch combination the name "4 Start".

A brief tap on the center **ESC** of the left touch pad or the center **SET** key of the right touch pad will complete the time name assignment.

The flight-phase dependent model settings made before the assignment of phase switches are now in the flight phase «1 Normal». This is the phase which is called with the open «Start» switch in the center position of the 3-way switch.

3rd Step

In order to not have to carry out all previously made settings for the model in the "new" flight phase from the ground up, we recommend first copying the already tested programming of the flight phase "Normal" to the other flight phases. This is carried out in the menu ...

»Copy / Erase« (page 72)

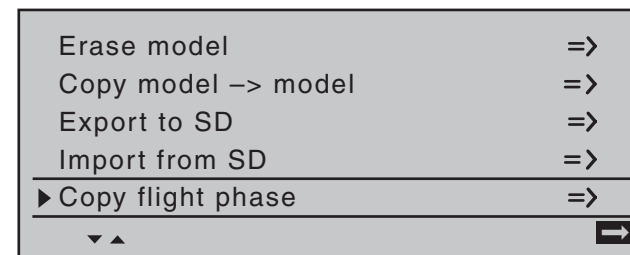

Here, select the "Copy flight phase" menu item with the selection keys then briefly tap the center **SET** key of the right touch pad.

In the window which now appears, "Copy from phase", "1 Normal" is selected ...

| | |
|----------|-------------|
| Copy | from phase: |
| 1 normal | 2 Thermal |
| 3 Speed | 4 Launch |
| 5 | 6 |
| 7 | 8 |

... and a subsequent brief tap on the center **SET** key of the right touch pad will change the display to "Copy to phase". Now the target is to be selected (initially "2 Thermal") and confirmed by another tap on the center **SET** key of the right touch pad. After confirmation of the subsequent safety query, all settings are copied according to the selection. Proceed in the same manner with the other two phases ("1 Normal" to "3 Speed" and "1 Normal" to "4 Start").

4th Step

Now three or four phases are programmed, the settings are also copied and there is even a "soft" transfer, but ... there are still no flight-phase specific settings.

Now, if applicable, in order to adapt the flap positions to the different requirements of the individual flight phases, in the menu ...

»Control adjust« (page 108)

... the standard default "GL" is first changed to "PH" for "Phase" in the type column:

| | | | | | | | | |
|---------------------------------------|----|----|-----|----|-------|-------|-----|-----|
| ►15 | PH | fr | --- | 0% | +100% | +100% | 0.0 | 0.0 |
| 16 | GL | fr | --- | 0% | +100% | +100% | 0.0 | 0.0 |
| 17 | GL | fr | --- | 0% | +100% | +100% | 0.0 | 0.0 |
| 18 | GL | fr | --- | 0% | +100% | +100% | 0.0 | 0.0 |
| «Normal» | | | | | | | | |
| ▼ Typ SEL /_ offset - travel + -time+ | | | | | | | | |

Then switch to the "Offset" column and make the settings deviating from the "Normal" flight phase for the ailerons. However, switch to the desired flight phase beforehand, whose name is shown at the bottom in the display, appropriate to the switch position. Both positive and negative throw changes are possible. These settings are to be made separately for each flight phase:

| | | | | | | | | |
|---------------------------------------|----|----|-----|-----|-------|-------|-----|-----|
| ►15 | PH | fr | --- | -7% | +100% | +100% | 0.0 | 0.0 |
| 16 | GL | fr | --- | 0% | +100% | +100% | 0.0 | 0.0 |
| 17 | GL | fr | --- | 0% | +100% | +100% | 0.0 | 0.0 |
| 18 | GL | fr | --- | 0% | +100% | +100% | 0.0 | 0.0 |
| «Thermal» | | | | | | | | |
| ▼ Typ SEL /_ offset - travel + -time+ | | | | | | | | |

5th Step

Any necessary phase-specific trimming of the elevator is made with the help of the digital trimming of the elevator joystick. This requires that you have at least set the elevator trimming to "Phase" in the »Stick mode« menu—as already shown in this programming example.

Alternatively, these settings can also be made in the »Phase trim« menu ...

| | | |
|-----------|----|----|
| Normal | 0% | 0% |
| * Thermal | 0% | 0% |
| Speed | 0% | 0% |
| Launch | 0% | 0% |
| «Thermal» | | |
| EL | AI | |

6th Step

In the menu ...

»Wing mixers« (beginning page 160)

... the flight phase name of the newly activated flight phase appears at the bottom edge of the display. If the switch position is now changed, the name of the flight phase selected with the switch appears, but with the previously copied settings of the flight phase "Normal". Here you set you values phase-specifically for the aileron differentiation, the share of the mixture of transverse to side, and if applicable, also a mixture of altitude to transverse. (The latter increases the agility over the transverse axis when "Turning".)

| | | | |
|-----------------------|----|------|-----|
| W I N G M I X E R S | | | |
| Brake settings | | | => |
| Aileron differential | | +33% | |
| Aileron 2→4 rudder | | +55% | --- |
| ►Elevator 3→5 aileron | 0% | 0% | --- |
| ▲ «Normal» ↘ | | | |

Note:

The list of displayed options depends on the number of servos entered in the "Ailerons/flaps" line in the »Model type« menu.

Now switch to the sub-menu ...

| W I N G M I X E R S | | | | |
|------------------------|---------------------------------|------|---------------------------------|-----|
| Brake settings | | | | => |
| Aileron differential | | +33% | | |
| Aileron 2→4 rudder | | +55% | | --- |
| ▶ Elevator 3→5 aileron | <input type="text" value="0%"/> | | <input type="text" value="0%"/> | --- |
| ▲ | ◀ Normal ▶ | | | ↙- |

... and enter the raised height of aileron brakes for individual flight phases in the "Crow" line.
 With "D.red" (differentiation reduction), you should enter the value previously set in the aileron differentiation line in order to suppress it again while breaking.
 In the "Elevat curve" sub-menu, enter a correction value for the elevator, see page 150.

Note:
 The "Brake settings" sub-menu of the »**Wing mixers**« menu is switched "off" when: for the "Motor at C1 front/rear" column of the »**Model type**« menu (page 94) AND for the "Motor" column of the »**Phase settings**« menu (page 142), a "yes" is entered for the currently active flight phase. Change the flight phase, if applicable.

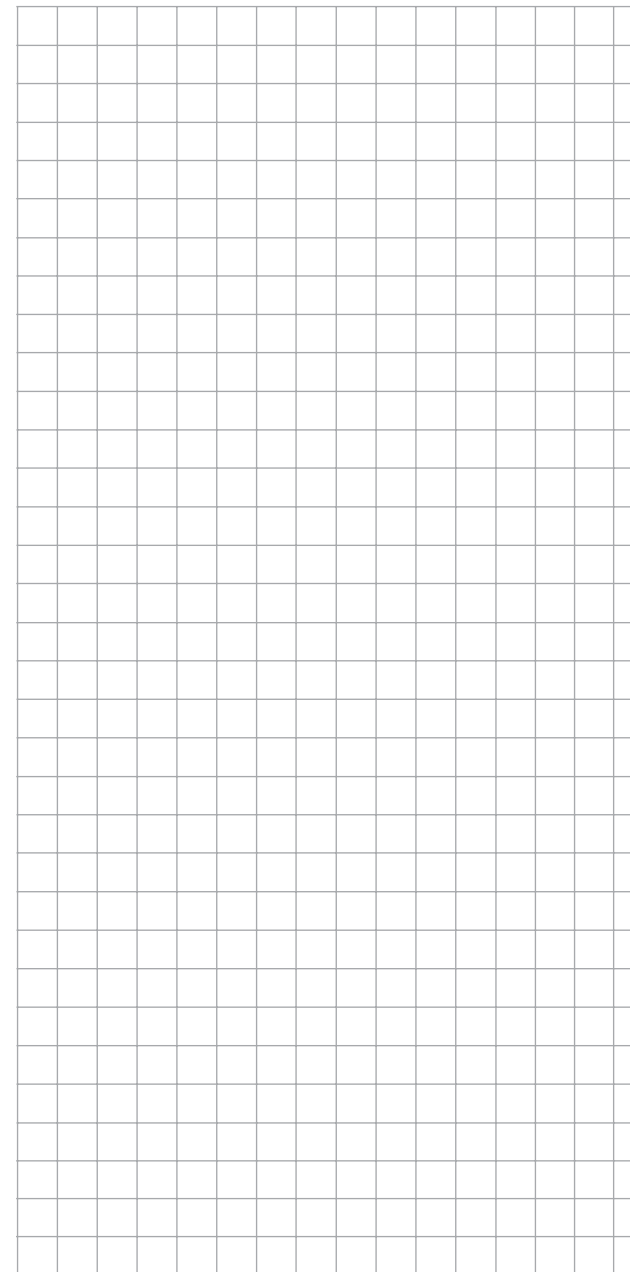
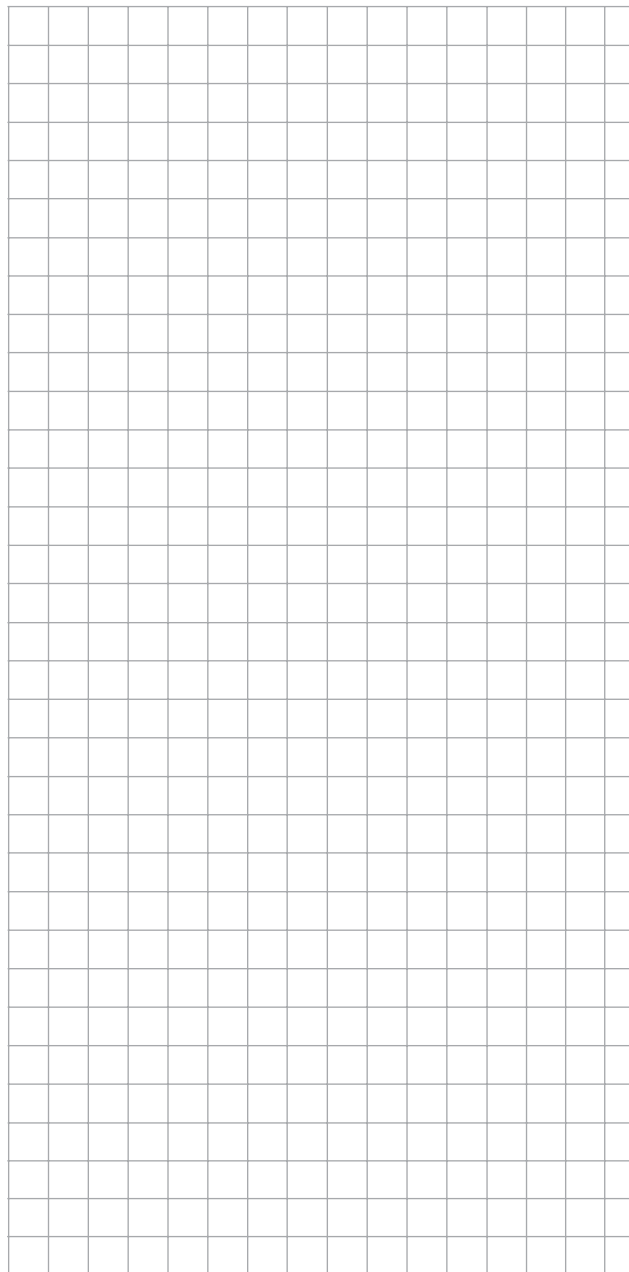

Using flight phases

Example 2 ...

Glider with four flap wings, two large flaps and tow coupling

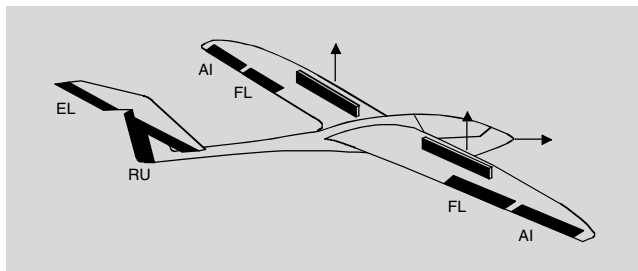

The following example is based on the assumption that you have already mechanically pre-adjusted the model and you have already ensured the correct deflection of all rudders or checked this again in the scope of this programming and made adjustments, if applicable, through servo switching at the receiver and/or through the »**Servo adjustment**« menu. This programming example is based on an assignment of the receiver connections in accordance with the following diagram:

- **SUMO / SUMI-connection**
- free or aux. function
- free or aux. function
- **Receiver power supply**
- free or aux. function
- free or aux. function
- free or aux. function
- **Receiver power supply**
- Aero-tow release or free or aux. function
- 2nd airbrake or free or aux. function
- Right flap
- **Receiver power supply**
- **Telemetry connection**
- free or aux. function
- free or aux. function
- **Receiver power supply**
- Left flap
- Right aileron
- Rudder or elevator/rudder right
- **Receiver power supply**
- Elevator or elevator/rudder left
- Left aileron
- Airbrake or 1st airbrake
- **Receiver power supply**

Begin with the new programming of the model in a free model memory location.

Essentially, the »**Basic settings, model**« menu is used to bind the receiver to the transmitter. Enter a model name and select or review the selection of appropriate stick mode. Later on this menu will also be used to activate the range test before the start of flight operations.

In the menu ...

"Model type" (page 94)

... leave "Motor to C1" at "none" and the tail type at "Normal". Set "2 AIL 2 FL" into the "Aileron/camber flaps" line.

In the "Brake" line, program or leave "In1", because the brake and spoiler flap servos connected to 1 + 8 should be activated later with the corresponding C1 joystick as the control:

| M O D E L T Y P E | | | |
|----------------------|--------|----------|---------|
| Motor on C1 | | none | |
| Tail type | | Normal | |
| Aileron/camber flaps | | 2AIL 2FL | |
| ▶ Brake | Offset | +90% | Input 1 |
| ▲ | | STO | SEL |

The setting in the "Brake Offset" value field defines the neutral position of all mixers specified by the "Brake settings" sub-menu of the »**Wing mixers**« menu. Place this neutral point at approx. +90%, insofar as the brake flaps should be retracted in the front position of the C1 joystick. The remaining path between +90% and the full throw of the joysticks, +100%, is then assigned as idle travel. This assures that the rudders or flaps addressed by the mixers of "Brake settings" remain in their "normal" positions even for slight deviations from the limit position of the C1 control. At the same time, the effective control path is automatically spread to 100%.

In the menu ...

»Control adjust« (page 108)

... assign a switch, for example Input 9, to operate the aero-tow coupling. In order for this switch to work independently of the flight phase, leave the standard default "GL" in the "Type" column of this input. With "- Travel +" you can adjust the control travel for the switching of the switch:

| | | | | | | | | |
|--|----|-----|-----|----|-------|-------|-----|-----|
| 16 | GL | fr | --- | 0% | +100% | +100% | 0.0 | 0.0 |
| 17 | GL | fr | --- | 0% | +100% | +100% | 0.0 | 0.0 |
| 18 | GL | fr | --- | 0% | +100% | +100% | 0.0 | 0.0 |
| ▶19 | GL | --- | 10▣ | 0% | +100% | +100% | 0.0 | 0.0 |
| ▼ ▲ Typ ↘_ ↗_ offset - travel + -time+ | | | | | | | | |

With a simultaneous tap on the ◀ ▶ keys of the left touch pad, the setting can be checked in the »**Servo display**«.

Since the C1 control should actuate Servo 8 simultaneously with Servo 1, establish this link by way of the »**Control adjust**« menu.

For this reason, also switch to the line before and assign "Control 1" to Input 8.

| | | | | | | | | |
|--|----|-----|-----|----|-------|-------|-----|-----|
| 16 | GL | fr | --- | 0% | +100% | +100% | 0.0 | 0.0 |
| 17 | GL | fr | --- | 0% | +100% | +100% | 0.0 | 0.0 |
| ▶18 | GL | Cn1 | --- | 0% | +100% | +100% | 0.0 | 0.0 |
| 19 | GL | --- | 10▣ | 0% | +100% | +100% | 0.0 | 0.0 |
| ▼ ▲ Typ SEL ↘_ ↗_ offset - travel + -time+ | | | | | | | | |

However, please note in this connection, that a non-linear control curve programmed in the »**Channel 1 curve**« menu has as little effect on this input as brake offset set to less than 100%, which you can check very easily in the »**Servo display**« menu. You can reach this from nearly every menu position with a simultaneous tap on the ◀ ▶ keys of the left touch pad:

The travel, and if applicable also the direction of rotation, for spoiler servo 1 as well as the second spoiler servo connected to Output 8 can be adjusted in the menu ...

Servo adjustment (page 102)

| | | | | | | | |
|-----------|----|-----|-------|----------|------|---------|---|
| ▶ Servo 1 | => | 0% | 100% | 100% | 150% | 150% | |
| Servo 2 | => | 0% | 100% | 100% | 150% | 150% | |
| Servo 3 | => | 0% | 100% | 100% | 150% | 150% | |
| Servo 4 | => | 0% | 100% | 100% | 150% | 150% | |
| Servo 5 | => | 0% | 100% | 100% | 150% | 150% | |
| ▼ | | Rev | cent. | - travel | + | - limit | + |

In the Multi-flap menu of the ...

»Wing mixers« (beginning page 160)

... you now enter the first mixer values for the four wing flaps; for example:

| | | |
|---------|---------|-----------|
| ▲ AI ▼ | +100% | +66% |
| AI-Tr. | +100% | +66% |
| ▶ Diff. | +33% | +33% |
| FL-Pos. | 0% | 0% |
| ▲ FL ▲ | 0%+100% | +100% |
| | | AI FL ▼ ▲ |

Note:

The parameter values shown here are model-dependent and must be determined by test flights.

In the ...

- ▲ AI ▼ determines the percentage share with which the two flap pairs "AI" and "FL" are to respond to *aileron steering*. Also check whether the ailerons are deflected in the right direction during the adjustment of the parameter values.
The adjustment range from -150% ... +150% enables the correct throw direction adjustment regardless of the direction of rotation of the servos.

AI-Tr. determines the percentage share with which *aileron trimming* should effect the AI and FL.

Diff. the entry to specify *aileron steering differentiation* for AI and FL flaps is made here. Refer to page 161 about the significance of differentiation.
The adjustment range from -100% ... +150% enables the correct differentiation direction adjustment regardless of the direction of rotation of the aileron and flap servos.

FL-Pos. The flight-phase specific positions for all camber flaps present on the given model are set in this line. In the process, you can determine the positions the flaps assume for each flight phase.

Note:

The values appearing in this line are based on the same data set as in the comparable position in the »**Phase trim**« menu, which is why changes always take effect in both directions.

▲ FL ▲ Since all inputs in the »**Control adjust**« menu are set to "free" by default, neither the ailerons nor the camber flaps can be operated with these default settings. In this respect, you also leave the default entry here. However, if flap positions are to be varied with a switch or proportional control by the position specified in the "FL-Pos." line, assign the desired control to Input 6 in the »**Control adjust**« menu and set the desired reaction to the movement of the control selected for this purpose by way of a percentage in this line.

HR→WK this mixer induces a partial reaction from aileron (AI) and camber flaps (FL) during elevator activation.

The mixing direction is to be selected so that all flaps are deflected downward with the elevator pulled up and deflected upward with the elevator pushed down (= hydroplane). The mix proportion is normally in the low double-digit range.

Now, within the »Wing mixers« menu, switch to the "Brake settings" ...

| BRAKE SETTINGS | | |
|-------------------|------|------|
| Crow | +22% | +66% |
| Diff. reduct. | +33% | +33% |
| ▶ Elevat. curve ⇒ | | |
| ◀◀ Normal ▶▶ | | |
| ▲ | AI | FL ▶ |

Note:

The "Brake settings" menu is switched "off" if: "Motor on C1 forward / back" in the »Model type« menu (page 94) AND the "Motor" column of the »Phase settings« menu, (page 142) are set to "yes" for the currently active flight phase. Change the flight phase, if applicable.

Crow Further above in this text section, the C1 joystick was set for brake flap steering. In this line you determine the share with which the AI and FL should be included on actuation of C1 in the manner that both ailerons are deflected "slightly" upward and both flaps are deflected as far downward as possible. Now with a simultaneous tap on the ◀▶ keys of the left touch pad, a change to the »Servo display« menu can be affected for observation of servo movements and, in particular, to ensure that no influence on the flaps takes place above the adjusted brake offset,

e.g. +90% and beyond to the throw limit of the C1 control ("Idle travel" of the C1 joystick).

Diff. reduct. The value previously entered into the aileron differentiation line should also be entered in this "Differentiation reduction" line to fade this out during braking.

Elevat. curve This line is used for the entry of any correction factor that may be required for the elevator, see page 174.

Insofar as necessary, again check all flap throws and, by way of the »Servo adjustment« menu, adjust the servo center, the servo travel and the travel limit.

It may also be time to start the initial flight testing, insofar as all global settings—that is to say, all flight-phase independent settings—are completed.

Two additional flight phases are now to be set up below, each of which requires a somewhat different flap position.

Therefore, switch to the menu ...

»Phase settings« (page 142)

... and activate the assignment of phase names in the "Name" column with a brief tap on the center **SET** key of the right touch pad:

| | | | | |
|-----------|------|------------|----------|---|
| ▶ Phase 1 | | | 0.1s | * |
| Phase 2 | | | 0.1s | - |
| Phase 3 | | | 0.1s | - |
| Phase 4 | | | 0.1s | - |
| Phase 5 | | | 0.1s | - |
| ▼ | Name | Fl.ph.Tim. | Sw. time | |

Now give Phase 1—the "Normal phase"—that is also the phase which includes the previous settings, the name "Normal", which you select from a list with the selection keys.

Phase 2 is given the name "Thermal" and Phase 3 is given the name "Speed". Now conclude the entries with a brief tap on the **ESC** key of the left touch pad or the **SET** key of the right touch pad:

| | | | | |
|-----------|---------|------------|----------|---|
| Phase 1 | Normal | | 0.1s | * |
| Phase 2 | Thermal | | 0.1s | - |
| ▶ Phase 3 | Speed | | 0.1s | - |
| Phase 4 | | | 0.1s | - |
| Phase 5 | | | 0.1s | - |
| ▼ ▲ | Name | Fl.ph.Tim. | SW. time | |

Now move the marker frame beyond the "Fl.ph.Tim" column to the right into the column "Sw. time" and set a "switching time" from any other phase into the given phase in order to avoid an abrupt phase change; in other words to avoid erratic changes of flap positions. Now try out different switching times. In this example we have specified 1 s in each case:

| | | | | |
|-----------|---------|------------|----------|---|
| Phase 1 | Normal | | 1.0s | * |
| Phase 2 | Thermal | | 1.0s | - |
| ▶ Phase 3 | Speed | | 1.0s | - |
| Phase 4 | | | 0.1s | - |
| Phase 5 | | | 0.1s | - |
| ▼ ▲ | Name | Fl.ph.tim. | Sw. time | |

Whether or not one of the phases 1 ... 8 currently has an assigned switch and the state of the switch can be seen in the "status" column at the far right.

| Symbol | Meaning |
|--------|--------------------------------------|
| - | No switch assigned |
| + | Phase can be called via switch |
| * | Indicates the currently active phase |

Since, except for phase 1, all other phases are still designated with a "-" symbol, now switch in the menu to ...

»Phase assignment« (page 148)

... and assign the previously defined flight phases to appropriate switches with which a selection from among three phases is possible.

Since there is no particular priority here, assign for example switch "C" in the display to one of the two end settings of one of the two 3-way switches. Afterward put the selected switch again into its middle position, activate the switch assignment under "D" then move the selected 3-way switch again out of its middle position and into the other end position, as shown below:



After the switch assignment is complete, use the selection keys to switch to the bottom right and activate the assignment of phase names with a brief tap on the center **SET** key of the right touch pad.

Now close switch "7" by moving the selected 3-way switch forward.

Assign the name "<2 Thermal>" to this switch position and leave the name of its "OFF" position as "<1 normal>".



Finally, move the 3-way switch to the rear toward its "6 o'clock position" and assign this switch position the name "<3 Speed>":



The phase names selected in the programming are now shown, depending on the switch status, in all flight-phase dependent menus, see the table on page 140.

Since we have already made some settings in flight-phase dependent menus, such as in the »Wing mixers« menu, we will now copy these settings to the «Thermal» flight phase. For this purpose, open the menu ...

»Copy / Erase« (page 72)

... and switch to the "Copy flight phase" line:

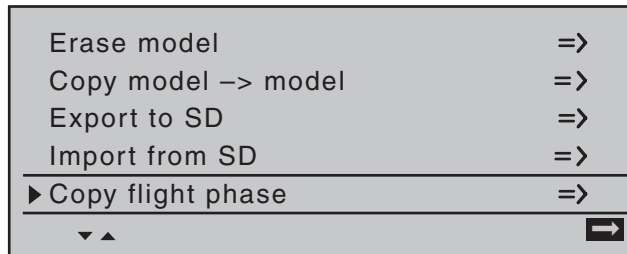

All eight possible flight phases are listed in "Copy from phase":

1. Select the flight phase to be copied, e.g. "1 Normal".

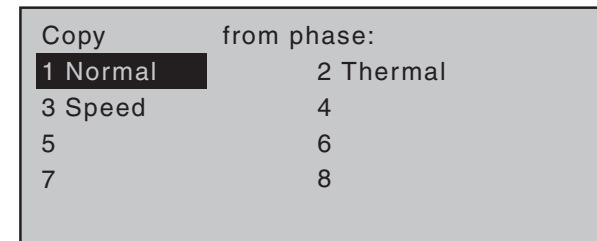

2. With a brief tap on the center **SET** key of the right touch pad, switch the window to entry of the target memory "Copy to phase".
3. Select phase "2 Thermal" as the target:

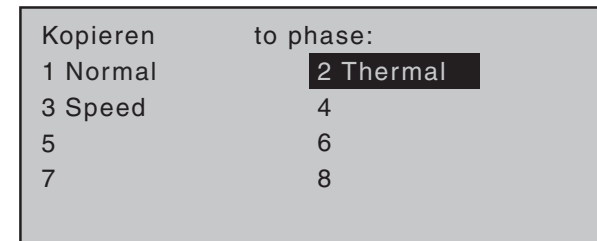

4. Confirm the selection with a brief tap on the center **SET** key of the right touch pad.
5. A security query follows, who should be confirmed with "Yes":

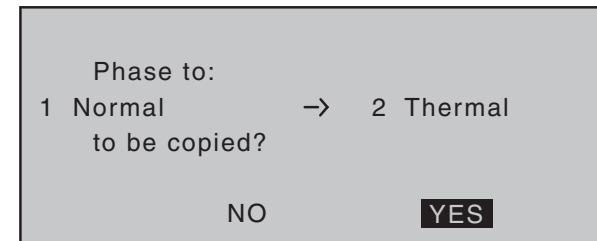

6. Then repeat the process with flight phase "3 Speed".

Now we will program the required settings in the flight phase "Thermal" as an example.

In order to vary camber flap positions in the «Thermal» phase, it is merely necessary to switch over to the menu ...

»Control adjust« (page 108)

... then change Input 6—as described beginning on page 108—from "GL(lobal)" to "PH(ase)" and finally assign it to an operating element.

To do this, first use the selection keys to switch into the "Typ" column for "I6" and change this setting from "GL" to "PH".

| | | | | | | | | |
|--|----|-----|-----|----|-------|-------|-----|-----|
| I5 | GL | fr | --- | 0% | +100% | +100% | 0.0 | 0.0 |
| ▶I6 | PH | fr | --- | 0% | +100% | +100% | 0.0 | 0.0 |
| I7 | GL | fr | --- | 0% | +100% | +100% | 0.0 | 0.0 |
| I8 | GL | Cn1 | --- | 0% | +100% | +100% | 0.0 | 0.0 |
| «Thermal» | | | | | | | | |
| ▼ ▲ Typ SEL ↘/_ offset - travel + -time+ | | | | | | | | |

Thereafter change one column to the right into the column above **SEL** ...

| | | | | | | | | |
|--|----|-----|-----|----|-------|-------|-----|-----|
| I5 | GL | fr | --- | 0% | +100% | +100% | 0.0 | 0.0 |
| ▶I6 | PH | fr | --- | 0% | +100% | +100% | 0.0 | 0.0 |
| I7 | GL | fr | --- | 0% | +100% | +100% | 0.0 | 0.0 |
| I8 | GL | Cn1 | --- | 0% | +100% | +100% | 0.0 | 0.0 |
| «Thermik» | | | | | | | | |
| ▼ ▲ Typ SEL ↘/_ offset - travel + -time+ | | | | | | | | |

... and now assign this input, as described in the section "Assigning transmitter controls, switches and control switches" on page 56, the left proportional slider in the middle console to, for example:

| | | | | | | | | |
|--|----|-----|-----|----|-------|-------|-----|-----|
| I5 | GL | fr | --- | 0% | +100% | +100% | 0.0 | 0.0 |
| ▶I6 | PH | SI1 | --- | 0% | +100% | +100% | 0.0 | 0.0 |
| I7 | GL | fr | --- | 0% | +100% | +100% | 0.0 | 0.0 |
| I8 | GL | Cn1 | --- | 0% | +100% | +100% | 0.0 | 0.0 |
| «Thermal» | | | | | | | | |
| ▼ ▲ Typ SEL ↘/_ offset - travel + -time+ | | | | | | | | |

This control will allow the ailerons (2 + 5) and camber flaps (6 + 7) to be continuously adjusted (as camber flaps) with a mixer ratio yet to be set via the **»Wing mixers«** menu.

If you assign the still free second three-stage switch to Input 6 instead, you can call three different FL positions of the ailerons (AIL) and camber changing flaps (FL) as well as three elevator positions (Elev) in the "Thermal" flight phase, see the following page. (These three switch positions correspond to the center position and the two limit positions of the previously mentioned proportional rotary control.)

Note:

The FL and AIL flap positions in the two limit switch positions or in the switch center depend on the value set in the column "- Travel +" as well as the offset value and the mixer proportion set in the "Multi-flap menu" of the »Wing mixers« menu, see further below.

Leave the (control) "- travel +" at its standard symmetric settings of + 100% and the offset value at 0%. Specifying a symmetric or asymmetric time for smooth switching between the three switch positions - in the example "1.0 s 1.0 s" - in the column "- Time +" is recommended:

| | | | | | | | | |
|--|----|-----|-----|----|-------|-------|-----|-----|
| I5 | GL | fr | --- | 0% | +100% | +100% | 0.0 | 0.0 |
| ▶I6 | PH | SI1 | --- | 0% | +100% | +100% | 1.0 | 1.0 |
| I7 | GL | fr | --- | 0% | +100% | +100% | 0.0 | 0.0 |
| I8 | GL | Cn1 | --- | 0% | +100% | +100% | 0.0 | 0.0 |
| «Thermal» | | | | | | | | |
| ▼ ▲ Typ SEL ↘/_ offset - travel + -time+ | | | | | | | | |

In the "Multi-flap menu" of the ...

»Wing mixers« (beginning page 160)

... menu, subsequently change only the values for "FL.pos" and "▲FL▲" in the «Thermal» flight phase:

FL.pos It is here that AI and FL positioning takes place during the «Thermal» flight phase in the event that the assigned control (proportional control or 3-way switch) is in its neutral or middle position.

| | | | |
|---------------------|-------|-------|-------|
| ▲AI ▼ | +100% | +66% | |
| Ail-tr. | +100% | +66% | |
| Diff. | +33% | +33% | |
| ▶FL.pos | -9% | -11% | |
| ▲FL ▲ | 0% | +100% | +100% |
| «Thermal» AI FL ▼ ▲ | | | |

▲FL▲ Enter in this line the the share of influence for aileron and camber flap servos, when used as camber flaps, is to be produced by the selected control (see above) or 3-way switch. Be sure to set these values high enough that the flaps can be controlled with appropriate sensitivity, for example:

| | | | | |
|---------------------|-------|------|------|------|
| ▲AI ▼ | +100% | +66% | | |
| Ail-tr. | +100% | +66% | | |
| Diff. | +33% | +33% | | |
| Fl.pos | -9% | -11% | | |
| ▶▲FL ▲ | +20% | +20% | +25% | +25% |
| «Thermal» AI FL ▼ ▲ | | | | |

A simultaneous tap on the ▲▼ or ◀▶ key combination of the right touch pad (**CLEAR**) will reset changed values back to their standard default values.

Note:

Due to the improved lift distribution, the degree of mix ratios should be set so that the camber flaps are slightly "lower" than the ailerons.

With a simultaneous tap on the ◀▶ keys of the left touch pad, the reaction of the AI and FL servos can be checked in the »**Servo display**« by actuation of the selected camber flap control. (Push the C1 joystick to the front position so that the "AIL" and "FL" flap positions can be better followed on actuation of the corresponding control.)

Caution:

With aileron actuation the bars of the »Servo display« move in the same manner, for camber flap actuation they will move in the opposite manner.

- In the control's middle position, the—example's—"FL-pos." setting only has a -9% effect for the AI and -11% for the FL.
- In one transmitter control end-position, AI and FL are again closer to the neutral position because the mix ratio specified in the example reduces the FL.pos setting, whereas ...
- ... in the other limit position, AIL and FL reach the maximum downward offset prescribed by the mixer percentage.

In order to set a—corrective—admix for the elevator, exit the "Multi-flap menu" and return to the base screen of the »**Wing mixers**« menu:

| W I N G M I X E R S | | | | | |
|---------------------|---------------|---------|--|------|---------|
| Multi-flap menu | | | | | => |
| Brake settings | | | | | => |
| Aileron | 2->3 | rudder | | +50% | --- |
| ▶ Flaps | 6->4 | aileron | | +5% | +5% --- |
| ▲ | ◀◀ Thermal ▶▶ | | | | ↘- |

In the two limit positions of the three-stage switch the elevator is moved symmetrically in this example with +5% (true to side). If, on the other hand, you use a proportional control, the elevator is deflected according to the degree for the control position. Then make the settings for the "Speed" flight phase in the same manner.

Notes:

- *The digital trimming of transverse, altitude and side work independently of these settings—depending on the setting selected in the »Stick mode« menu, page 104—"global" or for each "phase".*
- *All setting values are model-dependent. Carry out the settings on your finished model and/or during the flight.*

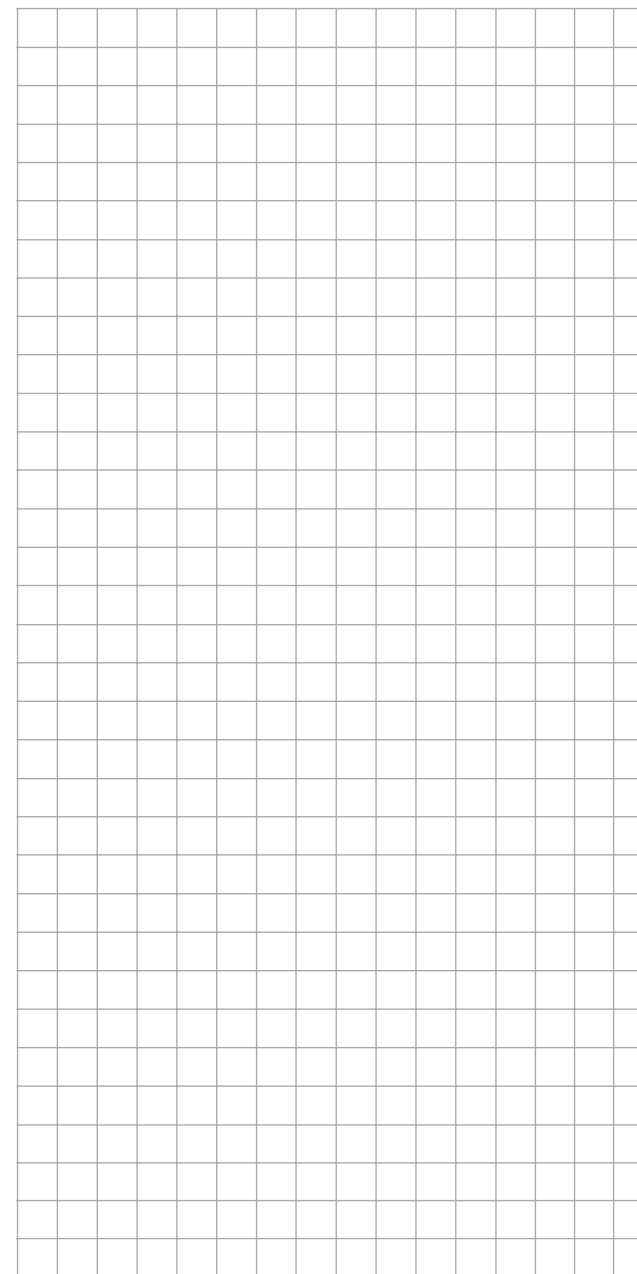

✂ Eight-flap wing

The standard features of the **MC-20** HoTT support convenient control of up to 8 servos for aileron/camber flap functions.

In the following we will consider a model without motor drive and without spoilers in the wings. The example is also based on the assumption that the model is already mechanically pre-adjusted, that the deflection of all rudders to the correct side has been verified, that these items will be checked again in the context of programming and that adaptations will be made as necessary via servo swapping at the receiver and/or in the **Servo adjustment** menu.

The servos should be connected to a suitable receiver as follows:

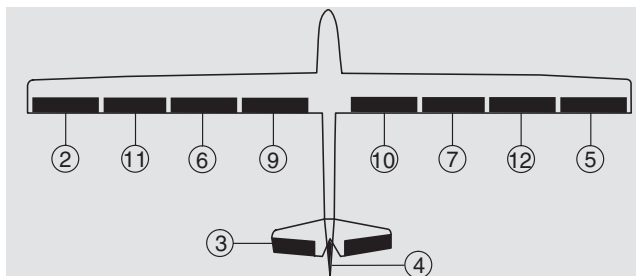

| Rudder | Receiver output |
|------------------------------------|-----------------|
| Aileron | 2 + 5 |
| Aileron 2 | 11 + 12 |
| Camber changing flaps (exterior) | 6 + 7 |
| Camber changing flaps 2 (interior) | 9 + 10 |
| Elevator | 3 |
| Rudder | 4 |

For the control of all flaps, up to two additional proportional controls are required in addition to the two joysticks or, alternatively up to two 2-way switches.

In order to be able to control all servos, first switch to the menu ...

»Model type« (page 94)

... and select "4AIL 4FL" in the "Ailerons/flaps" line.

| M O D E L T Y P E | |
|------------------------|---------------|
| Motor on C1 | none |
| Tail type | Normal |
| ► Aileron/camber flaps | 4 AIL 4 FL |
| Brake Offset | +100% Input 1 |
| ▼ ▲ | SEL |

In order to also actuate camber flap servos 6 + 7 (FL) and 9 + 10 (FL2) as ailerons, set the appropriate values in the **"Multi-flap menu"** of the ...

»Wing mixers« (beginning page 160)

... menu, whereby aileron control of the two camber flap pairs is set in the "▲AI▼" line and the "Ail-tr." line is used to adapt aileron trimming.

| | | | | |
|-----------------|-------|------|---------|----------------------|
| ▲AI ▼ | +100% | +88% | +77% | +55% |
| ► Ail-tr. | +100% | +88% | +77% | +55% |
| Diff. | 0% | 0% | 0% | 0% |
| FL.pos | 0% | 0% | 0% | 0% |
| ▲FL ▲ | 0 | 0% | 0 | 0%+100+100%+100+100% |
| EL →FL | 0 | 0% | 0 | 0%+100+100%+100+100% |
| <<Normal >>AILE | AILE2 | FLAP | FL2 ▼ ▲ | |

Any previous settings can be checked in the **»Servo display«** menu, which can be called from almost any menu position with a brief simultaneous tap on the ◀ ▶ keys of the left touch pad.

- The servos 6 + 7, 9 + 10 and 11 + 12 now move for the aileron control just like servos 2 + 5. Aileron trimming also affects all of these servos.
- The C1 joystick only actuates the servo connected to receiver output 1.

Caution:

With aileron actuation the bars of the "Servo display" move in the same manner and in the opposite manner with camber changing flap actuation.

The necessary fine-tuning of the servos is carried out in the ...

»Servo adjustment« (page 102)

| ► Servo | ⇒ | 0% | 100% | 100% | 150% | 150% |
|---------|-----|-------|----------|------|---------|------|
| Servo 1 | ⇒ | 0% | 100% | 100% | 150% | 150% |
| Servo 2 | ⇒ | 0% | 100% | 100% | 150% | 150% |
| Servo 3 | ⇒ | 0% | 100% | 100% | 150% | 150% |
| Servo 4 | ⇒ | 0% | 100% | 100% | 150% | 150% |
| Servo 5 | ⇒ | 0% | 100% | 100% | 150% | 150% |
| ▼ | Rev | cent. | - travel | + | - limit | + |

... if necessary.

In doing so, the basic programming of the eight-flap wing is completed.

Camber flap positioning and flight phases

First program two or more flight phases in the **»Phase settings«** and **»Phase assignment«** menus. Also take this opportunity to change the standard default "global" for trim in the **»Stick mode«** menu, page 104 to "phase", thus allowing modifications to meet individual preferences.

An example of flight phase programming can be found on page 288.

One camber changing flap setting per flight phase

If one camber flap position per flight phase is sufficient, then in the **"Multi-flap menu"** of the ...

»Wing mixers« (beginning page 160)

... menu, use the "FL.pos" line to adjust the camber flap position(s) of servo pairs "AILE" (2 + 5), "AIL2" (11 + 12), "FLAP" (6 + 7) and "FL2" (9 + 10) for each programmed flight phase to meet your preferences.

| | | | | |
|--------------|-------|-------|------|----------------------|
| ▲Al ▼ | +100% | +88% | +77% | +55% |
| Ail-tr. | +100% | +88% | +77% | +55% |
| Diff. | 0% | 0% | 0% | 0% |
| ▶FL.pos | -5% | -7% | -9% | -12% |
| ▲FL ▲ | 0 | 0% | 0 | 0%+100+100%+100+100% |
| EL →FL | 0 | 0% | 0 | 0%+100+100%+100+100% |
| <<Thermal >> | AILE | AILE2 | FLAP | FL2 ▼ ▲ |

Note:

Whether positive or negative values must be set in the "FL.pos" line depends on the installation of the servos, among other things.

However, if the alternative ...

variable camber flap positions per flight phase with a proportional rotary control setting is preferred,

... then the basic settings for all 8 flaps can be additionally varied on a flight-phase basis by way of a single control.

This is accomplished via the ...

»Control adjust« (page 108)

... menu, by assigning the same transmitter control in every flight phase to inputs 5, 6 and 11, for example the proportional slider, and in parallel, reducing travel to about 50% or even less so that the trimming of flaps has appropriate sensitivity. Deviating throw travel for individual flap pairs can also be matched to one another on a *flight-phase specific* basis by way of travel settings in a menu. For this purpose, you only have to switch the corresponding inputs from the standard default "GL" (global) to "PH" (phase):

| | | | | | | | | |
|-----------|-----|-----|-----|--------|-------|--------|-----|--------|
| I5 | PH | SI1 | --- | 0% | +25% | +25% | 0.0 | 0.0 |
| ▶I6 | PH | SI1 | --- | 0% | +25% | +25% | 0.0 | 0.0 |
| I7 | GL | fr | --- | 0% | +100% | +100% | 0.0 | 0.0 |
| I8 | GL | fr | --- | 0% | +100% | +100% | 0.0 | 0.0 |
| «Thermal» | | | | | | | | |
| ▼ ▲ | Typ | SEL | ↗ | offset | - | travel | + | -time+ |

| | | | | | | | | |
|-----------|-----|-----|-----|--------|-------|--------|-----|--------|
| I10 | GL | fr | --- | 0% | +100% | +100% | 0.0 | 0.0 |
| ▶I11 | PH | SI1 | --- | 0% | +25% | +25% | 0.0 | 0.0 |
| I12 | GL | fr | --- | 0% | +100% | +100% | 0.0 | 0.0 |
| I13 | GL | fr | --- | 0% | +100% | +100% | 0.0 | 0.0 |
| «Thermal» | | | | | | | | |
| ▼ ▲ | Typ | SEL | ↗ | offset | - | travel | + | -time+ |

Note:

With the use of a switch, set the respective "Deviation" of the offset point symmetrically or asymmetrically in the "- Travel +" column.

Elevator compensator with actuation of the camber changing flaps

If it should become evident in the flight that a correction of the elevator is necessary after setting the flaps, this correction can be made in the ...

»Wing mixers« (beginning page 160)

... For this purpose, select the line "FL → EL" and enter an appropriate flight-phase specific value, for example:

| | | | | |
|---------------------|-----------|---------|------|-----|
| W I N G M I X E R S | | | | |
| Multi-flap menu | | | | => |
| Brake settings | | | | => |
| Aileron | 2 → 3 | rudder | +50% | --- |
| ▶Flaps | 6 → 4 | aileron | +5% | +5% |
| ▲ | «Thermal» | | | ↗ |

If you have assigned the same control to the inputs 5, 6 and 11 – as specified above – all eight flaps move simultaneously while the elevator follows the set degree of mixture.

Camber changing flap movement on elevator actuation

Camber changing flap movement on elevator actuation – normally only used in "High gear" to increase the agility over the transverse axis – is also carried out in the "Multi-flap menu" of the ...

»Wing mixers« (beginning page 160)

... menu. Enter the desired flight-phase dependent values in the line "EL → FL":

| | | | | |
|--------------|-------|-------|------|----------------------|
| ▲Al ▼ | +100% | +88% | +77% | +55% |
| Ail-tr. | +100% | +88% | +77% | +55% |
| Diff. | 0% | 0% | 0% | 0% |
| FL.pos | -5% | -7% | -9% | -12% |
| ▲FL ▲ | 0 | 0% | 0 | 0%+100+100%+100+100% |
| ▶EL →FL | 5 | 5% | 7 | 7% +9+ 9% +11 +11% |
| <<Thermal >> | AILE | AILE2 | FLAP | FL2 ▲ |

In addition to the two camber changing flap pairs (servos 6 + 7 and 9 + 10), the two aileron pairs (servos 2 + 5 and 11 + 12) are now tracked with the degree of mixture corresponding to the camber changing flaps – normally opposite the elevator.

✂ Delta and flying wing

Of course, the general comments regarding the installation and the adjustment of the RC system to a model at the beginning of the wing model programming on page 268 also applies for delta and flying wing models! Similarly, the comments for test flying and fine-tuning the settings to the programming of flight phases also apply.

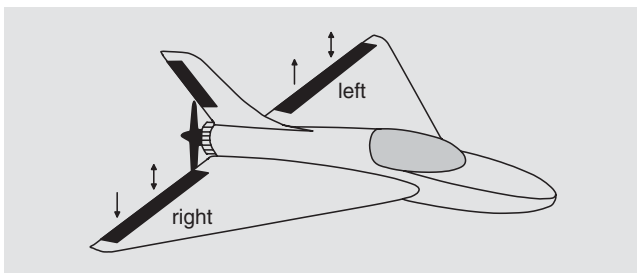

Delta and flying wing models differ significantly from a "normal" flight model due to their unique characteristic shape and geometry. The differences in the servo arrangement, on the other hand, are more subtle. For example, with "classic" delta/flying wing models, only two rudders are normally provided. They are responsible for both "transverse" and "height/depth", like the side rudder/elevator function on a V-tail unit.

With more elaborate designs, on the other hand, it may be the case that one (or two) interior rudders have only an elevator function and the exterior ailerons only support the height/depth function, under certain circumstances. Even with a 4, or indeed up to 8, flap wing the use of camber flap functions and/or even a crow system is nowadays entirely possible. In all these cases, however, the following assignment of the receiver outputs should be used, see also page 61. Unneeded outputs a simply left free:

- ⑤ + | — SUMO / SUMI-connection
- ⑥ + | — free or aux. function
- ⑦ + | — free or aux. function
- ⑧ + | — Receiver power supply
- ⑨ + | — free or aux. function or AIL2 / right EL
- ⑩ + | — free or aux. function or AIL2 / left EL
- ⑪ + | — free or aux. function or flap2 / right EL
- ⑫ + | — Receiver power supply
- ⑬ + | — free or aux. function or flap2 / left EL
- ⑭ + | — free or aux. function
- ⑮ + | — free or flap / right elevator
- ⑯ + | — Receiver power supply
- ⑰ + | — Telemetry connection
- ⑱ + | — free or aux. function
- ⑲ + | — free or aux. function
- ⑳ + | — Receiver power supply
- ㉑ + | — free or flap / left elevator
- ㉒ + | — free or aux. function
- ㉓ + | — free or rudder
- ㉔ + | — Receiver power supply
- ㉕ + | — AIL / elevator right
- ㉖ + | — AIL / elevator left
- ㉗ + | — Airbrake- or throttle servo
- ㉘ + | — Receiver power supply
- ㉙ + | — or speed controller (electric motor)

According to the assignment of the receiver outputs, in the menu ...

»Model type« (page 94)

| M O D E L T Y P E | | | |
|----------------------|--------------|-------|---------|
| Motor on C1 | none | | |
| ▶ Tail type | Delt/fl.wing | | |
| Aileron/camber flaps | 2 AIL | | |
| Brake | Offset | +100% | Input 1 |
| ▼ ▲ | SEL | | |

... the necessary settings are made:

"Motor on C1" "none" or "Throttle min front/rear"

"Tail type" "Delt/fl.wing"

"Aileron/camber flaps"

"2AIL" (appears automatically).

To the extent necessary, expand default "2 AIL" by 4 AIL or 1, 2 or 4 camber flaps ("1 FL", "2 FL" or "4 FL").

"Brake"

stays as is, only interesting for a delta wing or flying wing of type "2/4 AIL 1/2/4 FL". In this case, refer to the text under "Brake offset" on page 95.

These model type specifying settings primarily affect the functions made available in the »Wing mixers« menu. Therefore, the options are discussed separately for two-flap and multi-flap models in the following:

Delta/flying wing of the type: "2AIL"

| M O D E L T Y P E | | | |
|------------------------|--------------|-------|---------|
| Motor on C1 | none | | |
| Tail type | Delt/fl.wing | | |
| ▶ Aileron/camber flaps | 2 AIL | | |
| Brake | Offset | +100% | Input 1 |
| ▼ ▲ | SEL | | |

By retaining the standard default "2 AIL" in the "Aileron/camber flaps" line, elevator and aileron control, including the trim function, are automatically mixed by percentage on the software side. However, on the transmitter side, the percentage effect of the elevator and aileron joystick can be influenced in the »Dual Rate / Expo« menu, page 120.

Settings in the menu ...

»Wing mixers« (beginning page 160)

... are, if need be, advantageous with the "Aileron → Rudder" mixers and are 'played' with a great deal of "feel" for flying behavior with minor differentiation values.

| WING MIXERS | | | |
|----------------------|----|-----|-----|
| Brake settings | | | => |
| Aileron differential | 0% | | |
| ▶ Aileron 2→4 rudder | 0% | --- | |
| Elevator 3→5 aileron | 0% | 0% | --- |
| ▼ ▲ | | | ↙ |

Due to the specific idiosyncrasies of this model type, additional settings lead to moments which cannot be compensated.

Delta/flying wing of the type: "2 / 4 AIL 1 / 2 / 4 FL"

| MODEL TYPE | | | |
|------------------------|-------|--------------|-----|
| Motor on C1 | | none | |
| Tail type | | Delt/fl.wing | |
| ▶ Aileron/camber flaps | | 2 AIL 2 FL | |
| Brake Offset | +100% | Input 1 | |
| ▼ ▲ | | | SEL |

With delta/flying wing constructions with more than two flaps, more moments can be compensated for. For example, the "lifting" moment caused by the raising of the ailerons (= elevator effect) can be compensated for with camber changing flaps lowered correspondingly wide (= hydroplane effect).

If you decide in favor of this model type and have assigned the receiver outputs in accordance with the connection plan shown above, the aileron function of the two (exterior) aileron servos will function correctly immediately, but not the elevator function of the two aileron servos and, if applicable, the (interior) camber changing flaps.

This is only then achieved for "2/4 AIL 1/2/4 FL" when, in the "Multi-flaps menu", the ...

»Wing mixers« (beginning page 160)

... menu is set appropriately in the "HR → WK" line to "Aileron, camber flaps" or, if applicable, "Camber flap 2":

| | | | | |
|-----------|-------|----|-------|--------|
| ▲ AI ▼ | +100% | 0% | | |
| Ail-tr. | +100% | 0% | | |
| Diff. | 0% | 0% | | |
| FL.pos | 0% | 0% | | |
| ▲ FL ▲ | 0% | 0% | +100% | +100% |
| ▶ EL → FL | 0% | 0% | 0% | 0% |
| | | | AILE | FLAP ▲ |

Note:

Contrary to the separately set aileron trimming, see below, the trimming is transferred proportionally to the set mixer value with the mixer "EL → FL".

The following settings are model-specific and may not be adopted without checking that they are correct!

In the top line of this "Multi-flap menu", analogous to "normal" four, six or eight flap wings, the effect of the aileron joystick will be set to aileron, camber flap and, if applicable to FL2. One line below, in the line "Ail-tr." line, will set the influence of aileron *trimming* on ailerons and camber changing flaps.

The setting of a differentiation is rather trickier due to the model type and should only take place based on a feel for the flight behavior of the model.

The line "▲ FL ▲" should then be set to the standard default of +100% in the "FLAP" (or "FL2") column –as shown– to 0%, *just to be safe.*

| | | | | |
|----------|-------|----|------|----------|
| ▲ AI ▼ | +100% | 0% | | |
| Ail-tr. | +100% | 0% | | |
| Diff. | 0% | 0% | | |
| FL.pos | 0% | 0% | | |
| ▶ ▲ FL ▲ | 0% | 0% | 0% | 0% |
| EL → FL | 0% | 0% | 0% | 0% |
| | | | AILE | FLAP ▼ ▲ |

Even though all inputs are set to "free" by default in the »Control adjust« menu, should a control be assigned sometime by mistake ... then it will at least have no effect.

The last line, "EL → FL", was explained at the beginning of this section.

In principle, the author of this manual had programmed a delta model years ago operated with the mc-20 and a crow system as landing assistance ... entirely without tilting moments through correspondingly attuned wing mixers "Brake → Aileron" and "Brake → Camber flap", whereby "Aileron" refers to the exterior rudder pair and "Camber flap" refers to the interior rudder pair.

To achieve this now with the **MC-20** Hott also, switch to "Brake settings" in the ...

»Wing mixers« (beginning page 160)

... menu, and enter the values for the ailerons to be raised and the "flaps" to be lowered in the "Crow" line so that the occurring moments compensate one another and the altitude of the model remains stable. In the process, however, you should leave the flaps with enough "play" for the elevator function!!! Therefore, do not utilize the entire servo travel for the crow alone; for example:

| BRAKE SETTINGS | | |
|----------------|------|------|
| ►Crow | +55% | +44% |
| Diff. reduct | 0% | 0% |
| Elevat. curve | | => |
| <<Normal >> | | |
| ▼ | AILE | FLAP |

You can ignore all other settings in this menu.

Note:

The "Brake settings" menu is switched "off" if: "Motor on C1 forward / back" in the »**Model type**« menu (page 94) AND the "Motor" column of the »**Phase settings**« menu, (page 142) are set to "yes" for the currently active flight phase. Change the flight phase, if applicable.

Similarly, a modern, tapered flying wing air craft can also be operated. With some of these models there are also interior and exterior rudders: The prior is in front of the center of gravity and the latter is behind. A downward throw of the central rudder(s) increases the ascending forces and has an elevator effect. An upward throw has the opposite effect. On the exterior ailerons, on the other hand, the effect is just the opposite: A downward throw shows an elevator effect and vice versa. With appropriate adjustment of the "leading" mixer to the setting of curve mixers in order to achieve a supporting effect from the external rudder pair with only extreme joystick deflection in the height/depth direction, "everything" is possible here. The author of this manual uses a curve mixer for his model, which is defined by a total of four points:

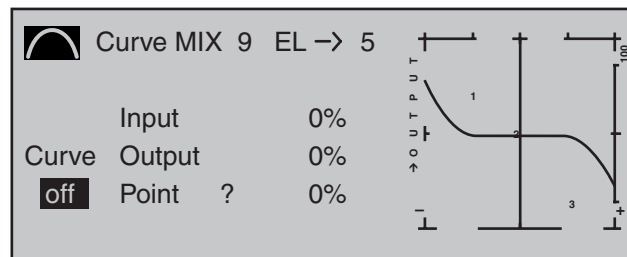

In this example the two interpolation points 1 and 2 are each at 0% as well as the left edge point at +60% and the right edge point at -65%. In conclusion, the curve was rounded.

In this case: Regardless of which type of servo arrangement was selected, any type of differentiation should be set with caution! On a tail-less model, differentiations show a single-sided height/depth elevator effect, so we urgently recommend beginning at least the initial flights with a setting of 0%! Over the course of the further flight testing, under certain circumstances it may be advantageous to experiment with differentiations deviating from zero.

With larger models, rudders in the winglets - the "ears" mounted on the wing ends - can be beneficial. If these are controlled with two separate servos, with the use of one of the mixers in the menu ...

»Dual mixer« (page 206)

... the rudder signal can be "split" very easily and even differentiated, whereby the second rudder servo is connected to one of the still free receiver outputs. For a model with a "Delt/fl.wing" tail type, receiver output "5" should still be unoccupied and it can then be used as indicated below:

| DUAL MIXER | | |
|------------|--------------|-------|
| ►Mixer 1 | ▲ 5 ▲▲RU ▼ | +66% |
| Mixer 2 | ▲ ?? ▲▲ ?? ▼ | 0% |
| Mixer 3 | ▲ ?? ▲▲ ?? ▼ | 0% |
| Mixer 4 | ▲ ?? ▲▲ ?? ▼ | 0% |
| ▼ | | Diff. |

Differentiation is necessary in *this* case because, when flying curves, the respective exterior rudders will have a greater curve radius than the interior rudders, so this is comparable to the front wheel positions on a car when driving in curves.

Note:

The rudder can only be differentiated as programmed above!

If these two rudders are also to deflect outward upon actuation of a brake system with the C1 joystick, this can be achieved, for example, by setting an additional mixer "C1 → 5" with an appropriate travel setting. Set the mixer's offset according to personal preference, "front" (+100%) or "rear" (-100%), because the winglet rudder should deflect outward only for proportional extension.

Independent of this, finish up by uncoupling the "false" control function from the control channel to which the second servo was connected – even though all inputs in the »**Control adjust**« menu are "free" by default – by way of the *flight-phase independent* menu ...

»MIX-only channel« (page 205)

... for safety's sake! In keeping with the above example, control channel 5 should therefore be set to "MIX only".

F3A model

F3A models are a part of the group of motor-driven winged models. They are powered by a combustion or electric motor. Models with electric motors can be used in both the electric acrobatic class F5A and are also competitive in the international model acrobatic class F3A.

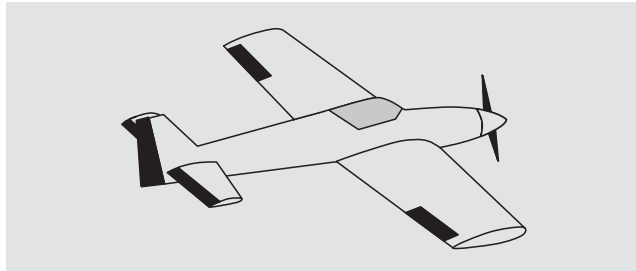

The basic comments and notices for the mechanical installation of a remote steering system, which was already referred to in the first programming example on page 268, also applies, of course, for F3A models and does not need to be mentioned here again.

Faultlessly constructed F3A models exhibit a largely neutral flying behavior. Ideally, they react with a good nature but precisely to control movements without the individual flight axes influencing one another.

F3A models are controlled with ailerons, elevator and rudders. Normally, each aileron is actuated by a separate servo. There is also the regulation of the drive output of the motor (throttle function) and a retractable landing gear in many cases. The assignment of the channels 1 to 5, therefore, do not differ from the previously described winged models.

The additional "Retractable landing gear" function is to be provided on one of the auxiliary channels 6 to 9. It is best to actuate the landing gear with a switch without center position. In addition, another mix offset for the carburetor can—if necessary—be provided. You normally use one of the two proportional controls on the transmitter, which actuates one of the unassigned auxiliary channels.

- **SUMO / SUMI-connection**
- free or aux. function
- free or aux. function
- **Receiver power supply**
- free or aux. function
- free or aux. function
- free or aux. function
- **Receiver power supply**
- free or aux. function
- free or 2nd elevator or aux. function
- free or fuel mixture or aux. function
- **Receiver power supply**
- **Telemetrieanschluss**
- free or aux. function
- free or aux. function
- **Receiver power supply**
- free or landing gear or aux. function
- Right aileron
- Rudder
- **Receiver power supply**
- Elevator or 1st elevator
- Aileron or left aileron
- Throttle servo or speed controller (electric motor)
- **Receiver power supply**

With the assignment of auxiliary channels at the transmitter, we recommend making sure that the operating elements required for this are easily within reach, because during flight—especially in competition—you have "very little time" to release the joystick.

Programming procedure

Since the basic programming of the transmitter was already described in detail on pages 268 ... 275, only F3A-specific tips are added here.

In the menu ...

»Servo adjustment« (page 102)

| Servo | ⇒ | 0% | 100% | 100% | 150% | 150% |
|---------|-----|-------|----------|------|---------|------|
| Servo 1 | ⇒ | 0% | 100% | 100% | 150% | 150% |
| Servo 2 | ⇒ | 0% | 100% | 100% | 150% | 150% |
| Servo 3 | ⇒ | 0% | 100% | 100% | 150% | 150% |
| Servo 4 | ⇒ | 0% | 100% | 100% | 150% | 150% |
| Servo 5 | ⇒ | 0% | 100% | 100% | 150% | 150% |
| ▼ | Rev | cent. | - travel | + | - limit | + |

... the settings for the servos are carried out. Experience has shown that working with at least 100% servo throw is beneficial, because the control precision is significantly better if greater servo travel is used. This should already be taken into account during the construction of the model in the design of the rudder linkages. Check the servo's direction of rotation. The servo center should be adjusted mechanically, insofar as possible.

Any corrections can be made on the software side in the third column during the initial test flights. Through the menu ...

"Model type" (page 94)

... the idle trim is activated for Channel 1 (normally "rear", because full throttle is "front"). The trimming then only works in the idle direction:

| M O D E L T Y P E | |
|----------------------|---------------|
| ► Motor on C1 | Thr. min rear |
| Tail type | Normal |
| Aileron/camber flaps | 1 AIL |
| Brake Offset | +100% Input 1 |
| ▼ | SEL |

The remaining settings are made or left as shown in the figure.

After the model is test-flown and trimmed, we recommend reducing trim travel for the elevator and ailerons. The model has significantly less of a reaction to a movement of the trim wheel. "Over-trimming" can be avoided, because with full trim travel, under certain circumstances, the movement by just one trimming step can have too strong of an effect: Therefore, the model which previously pulled slightly to the left, hangs somewhat to the right after the trimming. For this purpose, switch to the menu ...

»Stick mode« (page 104)

... and reduce the number of trim steps in the "Tr.s tep" column appropriately:

| | | | | |
|-----------|--------|----------|------|--------|
| Channel 1 | global | 4 | 0.0s | 0.0s |
| Aileron | global | 4 | 0.0s | 0.0s |
| Elevator | Phase | 4 | 0.0s | 0.0s |
| ► Rudder | global | 2 | 0.0s | 0.0s |
| | Trim | Tr.s tep | - | time + |

It may also be necessary to assign appropriate operating elements and inputs for other model features, e.g. retractable landing gear, fuel-mix, etc. Make these assignments with the ...

»Control adjust« (page 108)

... menu where a specific input can be assigned to an operating element, for example, the landing gear can be assigned to an ON/OFF switch on Input 6 and the fuel-mix can be assigned to one of the proportional sliders in the middle console, e.g. the center slider to Input 7. However, since it involves flight-phase independent settings, leave the standard default "GL" in the "Type" column:

| | | | | | | | | |
|------|----|-----|-----|----|-------|-------|-----|-----|
| I5 | GL | fr | --- | 0% | +100% | +100% | 0.0 | 0.0 |
| I6 | GL | --- | 2 | 0% | +100% | +100% | 0.0 | 0.0 |
| ► I7 | GL | SI2 | --- | 0% | +100% | +100% | 0.0 | 0.0 |
| I8 | GL | fr | --- | 0% | +100% | +100% | 0.0 | 0.0 |

▼ ▲ Typ SEL /- offset - travel + -time+

The control travel of the operating elements must be adapted and can also be reversed with a negative travel setting.

Note:
A delay time can be specified for raising and lowering the retractable landing gear, however, such a time delay is not effective for landing gear servo C 713 MG, order no. **3887**.

F3A models fly comparatively fast and thus react "harshly" to the control movements of the servos. However, since small control movements and corrections are not optically perceptible, because this results in inevitable point deductions in competition, we recommend setting an exponential control characteristic of the joystick. For this purpose, switch to the menu ...

»Dual Rate / Expo« (page 120)

Experience has shown positive results with values of approx. + 30 % on the ailerons, elevator and rudders, which you set in the right column with the selection keys. In order to be able to control the F3A model to run smoothly and cleanly:

| | | | |
|----------|------|---|------|
| Aileron | 100% | — | +33% |
| Elevator | 100% | — | +33% |
| ► Rudder | 100% | — | +33% |

DUAL EXPO

▲ /- SEL /- SEL

(Some experts even use up to a +60 % exponential ratio.)

Since (some) combustion motors do not react linearly to movements of the throttle joystick, through the menu ...

»Channel 1 curve« (page 128)

... a "bowed" or, in other words, non-linear throttle curve can be set. Four-cycle motors with Roots pumps, in particular, such as OS Max FS 120, require a steep ascension of the curve in the lower speed range. However, the corresponding values must be adapted. The C1 control curve for the motor could appear as follows:

Channel 1 C U R V E

| | |
|--------------|------|
| Input | -50% |
| Curve Output | 0% |
| Point | 1 |

on

<< Normal >>

Only three interpolation points, "L" at -100 %, "H" at +100 % and "1" at -50 % give the control travel the rounded curve above.

Basic procedure:

- Move the C1 joystick and, along with it the vertical line in the graph display, toward idle to about

-50% of control travel then briefly tap on the center **SET** key of the right touch pad.

- In order to attain the curve shape shown, raise this point with the selection keys to approx. 0% in the inverse video value field in the "Point" line.
- Finally, round the characteristic curve by moving the marker frame left, select with a brief tap on the center **SET** key of the right touch pad then change the value from "Off" to "On" with the selection keys.

If additional interpolation points between the left ("L") and right ("H") end are necessary, repeat Steps 2 and 3 analogously.

Since F3A models normally have two aileron servos, experience has shown that it is beneficial to move both ailerons upward *somewhat* when landing. In the process, the model usually approaches somewhat slower and, above all, more *steadily* for the landing. In order to do this it is necessary to program mixers through the menu ...

»Free mixers« (beginning page 193)

... accordingly.

The ailerons are extended as landing assistance depending on the position of the throttle stick, starting from approximately half throttle toward idle. The further the joystick is moved toward idle, the more the ailerons deflect upward. Just the opposite applies when "throttling"; the ailerons are retracted again in order to prevent a sudden rise of the model.

In order to prevent the model from climbing with the aileron landing flaps extended, the elevator must be mixed in somewhat.

For this purpose, set the two linear mixers shown in the following display. The activation of the mixers takes place with one and the same switch, such as "8", to which both mixers must be assigned with identical switching direction.

| | | | | |
|---------------|--|--------------|---|--------|
| LinearMIX 1 | | C1 → 5 | | => |
| ▶ LinearMIX 2 | | C1 → EL | | => |
| LinearMIX 3 | | ?? → ?? | | — |
| LinearMIX 4 | | ?? → ?? | | — |
| LinearMIX 5 | | ?? → ?? | | — |
| ▼ ▲ | | type from to | ↘ | Adjust |

Then switch to the second respective display screen in order to adjust the respective mixing degrees. In both cases the mixer neutral point is at the C1 control center.

Enter 0% above the control center after selection of the **ASY** field for both mixers and below the control center toward idle for:

- MIX 1: -60%... -80% and
- MIX 2: -5%... -10%...

Example Linear MIX 1:

With this, the base setup model of an F3A model is concluded.

Compensation of model-specific errors

Unfortunately, there are nearly always minor model-specific "errors" through the mixers of a computer remote control which must be compensated for. However, before you begin with these settings, it should be ensured that the model is faultlessly constructed, optimally balanced over the longitudinal and transverse axes and the down thrust and side thrust are correct.

Influence of longitudinal and transverse axes by the rudder

The actuation of the rudder often influences the behavior of the longitudinal and transverse axes. This is particularly disruptive in so-called knife-edge flying, in which the lift of the model with the rudder deflected should be created by the fuselage alone. In the process, the model can rotate and change directions as though it were controlled with the ailerons and elevator. Therefore, a correction over the transverse axis (elevator) and/or the longitudinal axis (ailerons) must be made, if applicable.

This can also be done easily with the »Free mixers« available in the **MC-20** HoTT system. For example, if the model drifts away to the right over the longitudinal axis with the rudder extended in knife-edge flying, the aileron can be deflected slightly to the left with the mixer. Changes in direction over the transverse axis can be performed analogously with a mixer on the elevator:

- Correction over the transverse axis (elevator)
Linear MIX 3: "Rudd → Elev"
Asymmetric setting. The appropriate values must be tested in flight.
- Correction over the longitudinal axis (aileron)
Linear MIX 4: "Rudd → AIL"
Asymmetric setting. The appropriate values must be tested in flight.

Relatively small mixer values are usually sufficient in this case, the range lies below 10%, but can vary from model to model. With the use of curve mixers, the mix ratios can be adapted even more precisely to the corresponding throw of the rudder. Again, no values are indicated for this, because this would be model-specific.

Vertical ascent and descent

Some models have a tendency to deviate from the ideal line in vertical ascents and descents.

In order to compensate for this, it is necessary to have a center position of the elevator dependent on the throttle joystick position. If, for example, the model begins to hold off on its own in the vertical descent with a throttled motor, some elevator must be mixed in at this throttle position.

For this purpose, program a free mixer "C1 → Elev". The corresponding mixer values are normally under 5% and must also be tested in flight.

Turning away over the longitudinal axis in idle

If the throttle is reduced, the model may begin to turn away over the longitudinal axis in idle. This can be counteracted with the aileron.

However, the more elegant solution is to correct this effect with a free mixer "C1 → Ail".

The input values here are usually very low (approx. 3%) and the settings should be made in calm weather. It often suffices to only use the mixer between half throttle and idle. Therefore program the mixer asymmetrically, if applicable.

Turning away with the ailerons/landing flaps extended

If you move the ailerons upward for the landing, the result is often a turning away over the longitudinal axis due to various servo paths of the aileron servos or due to design precisions. Therefore, the model begins to automatically hang the left or right wing. This is also easy to compensate for with a mixer "C1 → AIL" depending on the position of the ailerons/landing flaps.

The mixer must be switched on and off with the same switch with which you can switch the aileron/landing flap function on and off (see previous page). Therefore, it only works with the aileron/landing flap

function activated. The appropriate value must be tested in flight.

One additional comment regarding ...

"FAIL-SAFE setting"

You utilize the safety potential of this option by the safety potential by programming at least the motor throttle position for combustion models to idle and the motor function for electrically powered models to stop for a Fail-Safe case. If interference should occur, the model is then less likely to fly off on its own and cause damage to property or even personal injury. If you additionally program the fail-safe positions of the rudders to that the model flies in gently sinking circles in the event of a failure, there is a good chance that the model even lands relatively gently on its own in the event of a continuing connection failure. You also have sufficient time to re-establish the connection if the entire 2.4 GHz frequency band is temporarily disrupted.

In the receiver's condition as supplied, however, the servos maintain their last validly recognized position ("hold") in the event of a fail-safe situation. As described on page 208, you can define a "Fail-safe position" for each receiver servo output (Fail-safe mode).

Summary

The settings described on this page are especially useful for the "expert" who would like to have an entirely neutral, precisely flying F3A model acrobatic model at his or her disposal.

It should be mentioned this takes a lot of time, effort, instinct and know-how. Experts even program during the flight. To do this, however, is not suggested for an advanced beginner who ventures into an F3A acrobatic model. It would be best to turn to an experienced pilot and carry out the settings step by step until the model has the desired neutrality in its

flight behavior. Then the pilot can begin to learn the not always easy to perform acrobatic figures with a model which flies faultlessly.

Helicopter models

With this programming example, you must have already covered the description of the individual menus and you must be familiar with the use of the transmitter. In addition, the helicopter's mechanical construction should correspond exactly to the corresponding manual. The electronic capabilities of the transmitter should by no means be used to straighten out rough mechanical imprecision. As is often the case in life, there are also various ways and possibilities to achieve a specific goal when programming the **MC-20** HoTT. The following example should provide you with a clearer structure for logical programming. If there are multiple possibilities, the simplest and most clearly arranged solutions are recommended first. In order for the helicopter to function faultlessly later on, you are, of course, free to try out other solutions which may be better for you.



The programming example is based on the clockwise-rotating STARLET 50 helicopter from *Graupner* with three pivot points each offset 120° of the swashplate type "3sv(2 Roll)", beginner adjustment without increased throttle curve; without heading-lock gyro system and without transmitter-side gyro influence of the "normal operating mode" and without speed regulator.

This simple program was also consciously selected to demonstrate that a helicopter which flies really well can also be attained with relatively little (programming) effort.

However, we do not want to dispense entirely with the enhancement possibilities: Therefore, after the basic description, you will find adjustment information for the gyro effect, the speed regulators and for the flight-phase programming.

Note:

If you are not interested in the combustion helicopter described here, but a electric helicopter, please continue reading anyhow! With the exception of the omitted idle settings, you can practically adopt most of the settings described in the following unchanged.

In the scope of the initial commissioning of a new transmitter, in the selection menu ...

»General basic settings« (page 256)

| GENERAL BASIC SETTINGS | | | |
|------------------------|------|--------|-------|
| ▶ Voice volume | 7 | fr | ---- |
| Vario volume | 7 | fr | ---- |
| Touch-beeps vol. | 7 | fr | ---- |
| Owners name | < | | > |
| Pre-set stick mode | | 1 | |
| Pre-set modulation | | HoTT | |
| Pre-set DSC Output | | PPM10 | |
| Pre-set Pitch min | | rear | |
| Top LCD Contrast | | 0 | |
| Bottom LCD Contrast | | 0 | |
| Display light | | unlim. | |
| Power-on/off beep | | yes | |
| Battery type | | Li-Io | |
| Battery warning | | 3.60V | |
| Stick warning: | | unlim. | |
| Touch Sense | | 2 | |
| Region | | EURO | |
| Own phase name | 1 < | | > |
| Own phase name | 2 < | | > |
| ⋮ | ⋮ < | | > |
| Own phase name | 10 < | | > |
| ▼ | | SEL | SEL ↘ |

... some basic information should be entered. This serves various purposes:

The first three lines of this menu can be used to individually regulate, in increments between 0 and 10, the volume of voice and signal output emitted via the built-in loudspeakers or the transmitter's headset connector. The fourth line of this menu is used to record the transmitter owner's name. Select the characters for this from an extensive character list on the second display screen, which can be reached via

the  symbol with a brief tap on the center **SET** key of the right touch pad:

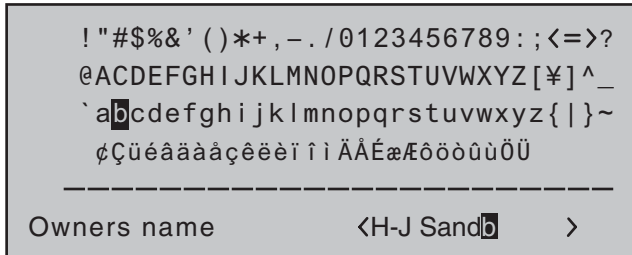

The *pre-set* for "**Stick mode**" can be selected according to the criteria described on page 258.

The same applies to the *pre-sets* for "**Modulation**" and "**DSC Output**".

The *pre-set* for "**Pitch min**" is a matter of personal control habits.

The *pre-sets* established here for "**Stick mode**", "**Modulation**", "**DSC Output**" and "**Pitch forward/back**" will be initially adopted when a new model memory is created but they can also be freely changed within a given model memory location to any other available option.

The settings in the "**Top/Bottom LCD Contrast**" lines determine the legibility of the given displays under poor light conditions and the setting in the "**Display light**" line determines how long display lighting remains illuminated after the transmitter is switched on or after the last key actuation.

The selection of "yes/no" in the "**Power-on/off beep**" line determines whether the "recognition melody" is to sound when the transmitter is switched off or on again.

The "**Battery type**" line specifies whether the transmitter is supplied with current from a "NiMH or a "Lith." battery, and the "**Battery warning**" line below it specifies the voltage at which the transmitter's low-voltage warning should trigger. Do not enter a value

that is too low here, so you have enough time to land your helicopter.

The setting made in the "**Stick warning**" line determines how long the transmitter will wait after the last actuation of an operating element before issuing visual and acoustic warning signals to indicate it is still switched on. Following the warning, you still have about one minute to actuate the transmitter so the warning will abate. Otherwise the transmitter will switch itself off when this minute expires.

The value set in the "**Touch Sense**" line is a matter of adapting the transmitter to personal preferences. And, in the event the transmitter is to be operated in France, the setting in the "**Region**" line is important: The legal regulations in France require that the "FRANCE" option is selected instead of the default setting "EURO".

Later on, the ten "**Own phase name**" lines can be used to create one's own phase names if none of the *pre-set* phase names appear appropriate.

Once these settings have been taken care of, commissioning continues with the menu ...

"Model select" (page 69)

Use the selection keys to pick a free memory location ...



... and call it up with a brief tap on the center **SET** key of the right touch pad. In the display which then appears, use the  key of the left or right touch pad ...

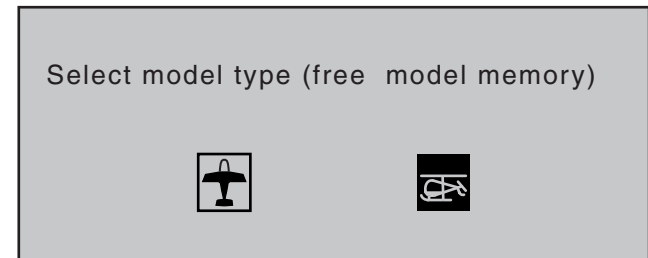

... to select the "helicopter" model type. The display immediately switches to the base screen if the selection is confirmed by a brief tap on the center **SET** key of the right touch pad.

Notes:

- If the "Select model type" option has been opened, the process cannot be canceled. Even if you switch off the transmitter, this selection must be made! In any case, you can undo this by subsequently deleting the respective model memory.
- If the "Throttle too high" warning appears, it can be erased by turning the right-side proportional rotary control to its forward limit.
- If battery voltage is too low, the model switchover cannot be made due to reasons of safety. An appropriate message will appear in the screen:

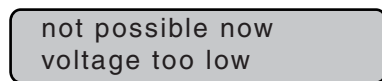

Once this first hurdle is cleared, the connection of the receiver built into the model at this model memory must be made in the menu ...

»Basic settings, model« (page 84 ... 92)

... To this end, switch to the line "Module".

| BASIC SETTINGS, MODEL | | | | | |
|-----------------------|---|-----|-----|-----|-----|
| Model name | < | | | | > |
| Info | < | | | | > |
| Stick mode | | | | 1 | |
| ▶ Module HoTT | | n/a | n/a | n/a | n/a |
| ▼ ▲ SEL | | BD1 | BD2 | BD3 | BD4 |

Note:

After confirmation of the model selection in the base screen, if you confirm the message appearing in the screen for a few seconds ...



... with a tap on the **SET** key of the right touch pad, this line will be accessed automatically.

The line "Module" initiates a binding process between model memory and receiver, as described in detail on page 88. Otherwise, you cannot address the receiver. Afterward, use the ▲ selection key of the left or right four-way pad to move up to the first line and begin with actual model programming in the "Model name" line. Now give the model memory an appropriate name, ...

| BASIC SETTINGS, MODEL | | | | | |
|-----------------------|---|-----|-----|-----|-----|
| ▶ Model name | < | | | | > |
| Info | < | | | | > |
| Stick mode | | | | 1 | |
| Module HoTT | | n/a | n/a | n/a | n/a |
| ▼ SEL | | BD1 | BD2 | BD3 | BD4 |

... which must be assembled from characters available on the second page of the "Model name" line:

| | | |
|--|-------|-----|
| ! " # \$ % & ' () * + , - . / 0 1 2 3 4 5 6 7 8 9 : ; < = > ? | | |
| @ A C D E F G H I J K L M N O P Q R S T U V W X Y Z [\] ^ _ | | |
| ` a b c d e f g h i j k l m n o p q r s t u v w x y z { } ~ | | |
| ϕ Ç ü é â ä å Æ ç è ë ì í î ï Æ Å Æ Æ ö ö ù ù Ü | | |
| ----- | | |
| Model name | <Star | e > |

After entering the "Model name", the settings adopted from »General basic settings« for "Stick mode" and "DSC Output" are to be checked and changed as necessary for the given memory location. The entry field in the "Info" line can be used if needed for a notice of up to 15 characters in length. This notice will then be helpful in the selection of models and so on.

Another option is to be activated in the "Autorotation" line. Even if you are not an advanced pilot, the autorotation switch should at least be set as an emergency shutoff switch for the motor. Do this by selecting the "Autorotation" line with a brief tap on the center **SET** key of the right touch pad, activate the switch assignment, assign a 2-way switch, e.g. "2", and put it in its "ON" position.

| BASIC SETTINGS, MODEL | |
|-----------------------|-------|
| RF transmit | on |
| RF range test | 99s |
| DSC Output | PPM10 |
| ▶ Autorotation | 2I |
| ▼ ▲ | ↙ - |

The selected switch should be in a location on the transmitter which is easily within reach—without letting loose of a joystick—e.g. above the pitch joystick.

Note:

More more information about the setting of this "emergency shutoff", see the beginning of the second following double-page.

Another tip:

Make a habit of giving all switches a common switch-on direction; then a quick glance over the transmitter prior to the flight should suffice—all switches off.

Setting options for the "Autorotation C1 position", "Motor stop", "Marking" and "Stick warning" are not yet of particular interest ...

... and the "Auto Trim" line should only be assigned to a switch if "Initial trimming" is to be performed on the helicopter in the context of a trimming flight. Following such a flight, this switch should be erased once again, for reasons of safety.

Additional settings specific to helicopters are made in the menu ...

»Helicopter type« (page 98)

In the "Swashplate type" line, select control for swashplate or pitch function. In this example: "3Sv(2rol)".

The "Linearis. swashpl." line is not yet of interest.

























In the "Rotor direction" line, it is established whether the rotor—as viewed from above—turns to the right (clockwise) or left (counter-clockwise). In other words, whether it rotates counterclockwise or clockwise. In this example "right".

Check the default for "Pitch min", which was adopted from »General basic settings«, to confirm that the entry "front" or "rear" is in keeping with personal preferences or should be changed.

| HELTYPE | |
|--------------------|---------|
| Swashplate type | 1 Servo |
| Linearis. swashpl. | no |
| Rotor direction | right |
| ► Pitch min. | rear |
| ▼ | SEL |

Both "**Expo throttle lim.**" as well as "**Thr. limit warning**", in bottom line of this display, are currently of no interest.

By now, the servos should be plugged into the receiver in the intended sequence:

-  — SUMO / SUMI-connection
-  — free or aux. function
-  — free or aux. function
-  — Receiver power supply
-  — free or aux. function
-  — free or aux. function
-  — free or aux. function
-  — Receiver power supply
-  — free or aux. function
-  — free or speed governor or aux. function
-  — Gyro gain
-  — Receiver power supply
-  — Telemetry connection
-  — free or aux. function
-  — free or aux. function
-  — Receiver power supply
-  — Throttle servo or speed controller
-  — free or aux. function
-  — Tail rotor servo (gyro system)
-  — Receiver power supply
-  — Pitch-axis 1 servo
-  — Roll 1 servo
-  — Roll 2 servo
-  — Receiver power supply

Note:

Please note that on the newer Graupner-**mc-** and **mx-** remote control systems, the first pitch servo and the throttle servo are swapped in comparison to older systems.

Mix ratios and mix directions for swashplate pitch, roll and nick servos are already pre-adjusted to +61% in the menu ...

»Swashplate mixer« (page 208)

| SWASH MIXER | |
|-------------|------|
| ► Pitch | +61% |
| Roll | +61% |
| Pitch ax. | +61% |
| ▼ | SEL |

. If the swashplate mixer should not follow joystick movements properly, first change the mixing directions from "+" to "-" before changing servo directions in the menu ...

»Servo adjustment« (page 102)

| Servo | ⇒ | 0% | 100% | 100% | 150% | 150% |
|-----------|-----|-------|----------|------|---------|------|
| ► Servo 1 | ⇒ | 0% | 100% | 100% | 150% | 150% |
| Servo 2 | ⇒ | 0% | 100% | 100% | 150% | 150% |
| Servo 3 | ⇒ | 0% | 100% | 100% | 150% | 150% |
| Servo 4 | ⇒ | 0% | 100% | 100% | 150% | 150% |
| Servo 5 | ⇒ | 0% | 100% | 100% | 150% | 150% |
| ▼ | Rev | cent. | - travel | + | - limit | + |

... This menu can also be used to adapt travel and direction for individual servos. However, one must attempt to retain 100% servo travel so as to achieve the best possible resolution and control accuracy. The direction of travel is determined with "Rev." and, in the process, make sure that the direction is correct. The tail rotor servo must run so that the nose (!) of the helicopter follows the tail joystick direction. In the menu ...

»Stick mode« (page 106)

| ► Pitch/thr | Thr trim | 4 | 0.0s | 0.0s |
|-------------|----------|----------|--------|------|
| Roll | global | 4 | 0.0s | 0.0s |
| Pitch ax | global | 4 | 0.0s | 0.0s |
| Tail rot. | global | 4 | 0.0s | 0.0s |
| ▼ | Trim | Tr. step | - time | + |

... the column "**Tr. step**" is used to set the increment size of each "click" on the digital trim keys.

The C1 trimming only affects the throttle servo for the helicopter. At this point there is no need to go into the particulars of this trimming ("cut-off trim") once again. Please read more about this on page 58. (Thanks to *digital* trimming, trim values can be saved automatically when a model change is affected. In the **mc-20** HoTT system these can even be stored automatically when a change of flight phase takes place.)

An additional setting which is specific to helicopters can also be made in this menu in which you determine which function the trim slider on the pitch joystick should have. This is accomplished by selecting the "**Throttle limit**" setting in the "Throttle" line or leaving it as it is. This roughly corresponds to trim for the familiar idle trim function. If the trim indicator marker is moved all the way forward by "turning" the trim wheel (remember: "pitch min rear" = "throttle forward") the throttle limit will later take over the throttle limit for throttle enable seamlessly in the menu ...

»Control adjust« (page 112 ... 119)

| | | | | | | | | | |
|---------------------------------------|----|-----|-----|----|-------|-------|-----|-----|-----|
| I13 | GL | fr | --- | 0% | +100% | +100% | 0.0 | 0.0 | 0.0 |
| I14 | GL | fr | --- | 0% | +100% | +100% | 0.0 | 0.0 | 0.0 |
| I15 | GL | fr | --- | 0% | +100% | +100% | 0.0 | 0.0 | 0.0 |
| ▶TI16 | GL | Lv1 | --- | 0% | +100% | +100% | 0.0 | 0.0 | 0.0 |
| ▲ Typ SET ↘_ offset - travel + -time+ | | | | | | | | | |

... where input "TI16" is assigned and all other inputs are "fr(ee)" by default.

This "TI16" input serves as the **throttle limiter**. Its effect is *exclusively* on output "6", where the throttle servo is connected. The throttle limiter is assigned by default to the right-side proportional rotary control.

Once again, as a reminder:

- With the user of the "throttle limiter" function, you do not have to program a flight phase "throttle pre-selection".
- The throttle limiter does not control the throttle servo; it only limits the travel of the throttle servo in the full throttle direction according to its position. The throttle servo is generally controlled from the pitch joystick via »Helicopter mixer« menu setting/s for throttle curve/s, which is why input 6 must absolutely remain "free". Refer to pages 180 through 182 in this manual about this.
- The C1 trimming also affects only the throttle servo for the helicopter. At this point there is no need to go into the particulars of this trimming once again. Please read more about this on page 58. (Thanks to the digital trimming, trim can be automatically saved values with a model changeover as well as with a change of the flight phase).
- A detailed description of the idle run base setup model and the adjustment of idle and throttle limit can be found beginning on page 117.

Then switch to the "travel" column with the ▶ selection key of the left or right touch pad and increase the now inversely highlighted value from +100% to +125% with a fully opened throttle limiter with a brief tap on the center **SET** key of the right touch pad:

| | | | | | | | | | |
|---------------------------------------|----|-----|-----|----|-------|--------------|-----|-----|-----|
| I13 | GL | fr | --- | 0% | +100% | +100% | 0.0 | 0.0 | 0.0 |
| I14 | GL | fr | --- | 0% | +100% | +100% | 0.0 | 0.0 | 0.0 |
| I15 | GL | fr | --- | 0% | +100% | +100% | 0.0 | 0.0 | 0.0 |
| ▶TI16 | GL | Lv1 | --- | 0% | +100% | +125% | 0.0 | 0.0 | 0.0 |
| ▲ Typ SET ↘_ offset - travel + -time+ | | | | | | | | | |

In doing so, it is assured that the throttle limiter releases the entire throttle travel with the pitch joystick later during flight.

Adjustment notice for electric helicopters:
Since electric drive systems have no need for an idle setting, the basic configuration of settings for an electrically-powered helicopter merely involves making sure that the control range of the throttle limiter is both higher and lower than the adjustment range of the speed controller (usually -100% to +100%) by a safe margin. If necessary, therefore, the adjustment of the "travel" setting of the throttle limiter described above must be modified accordingly, for example, to symmetric 110%. The further adjustment, however, can take place analogously to the combustion helicopter described here.

With this process, you have not carried out the basic settings for the transmitter as they are needed again later for further model programming.

The actual helicopter-specific settings take place primarily in the menu ...

»Helicopter mixer« (page 176 ... 191)

| | |
|---------------------|-----|
| ▶Pitch | => |
| Channel 1→Throttle | => |
| Channel 1→Tail rot. | => |
| Tail rot. →Throttle | 0% |
| Roll →Throttle | 0% |
| Roll →Tail rot. | 0% |
| Nick →Throttle | 0% |
| Nick →Tail rot. | 0% |
| Gyro suppression | 0% |
| Gyro offset | 0% |
| Swashplate rotation | 0° |
| Swashplate limiter | off |
| ▶ | |

The "Pitch" function appears right in the first line. A tap on the center **SET** key of the right touch pad will cause a switch to the corresponding sub-menu. The graphic representation of the pitch curve appears here; it is initially only defined by the points "L" and "H":

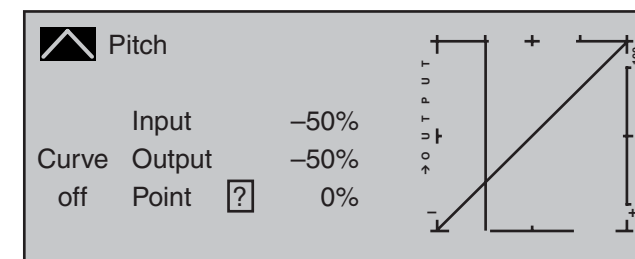

Now place point "1" in the center with a brief tap on the center **SET** key of the right touch pad:

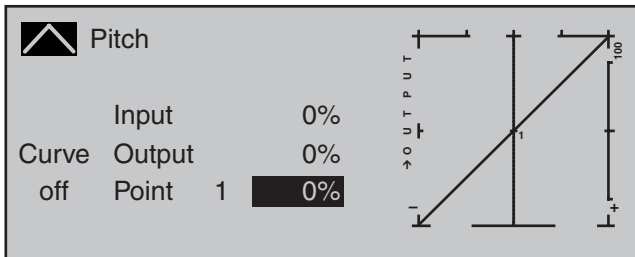

Always try to make due with these three points initially; more points can "over-complicate" the matter and are more of a burden at this point.

The reference point for the hovering should generally be the mechanical center position of the pitch joystick, because this position comes closest to the normal control feel. Although the curve adjustment enables other settings, you must know exactly what you are doing. First set the pitch joystick in the center. The servos which you had previously set according to manufacturer specifications have their levers at positioned perpendicularly to the servo housing (normally). A hovering pitch value of 4° to 5° is now mechanically set at the control rods to the rotor blades. In principle, all known helicopters fly with this setting. Then move the pitch joystick towards maximum pitch until the limit position. (The vertical line shows you the current joystick position.) Now change the pitch curve's point "H" with the selection keys of the right touch pad such that the main rotor's blades have a maximum pitch of about 9°. A value of +50% should be about right.

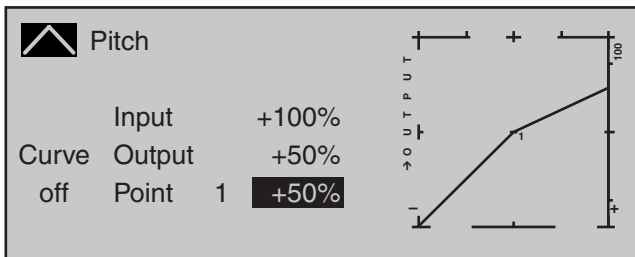

Note:

A rotor blade adjustment gage, such as the Graupner pitch gage, order no. 61, is quite useful for reading the angle.

Now move the pitch joystick toward the pitch minimum position until its limit position. Depending on the ability of the pilot, adjust the value of point "L" so that the blade angle of approach is 0 to -4°. Now a slightly pitched line arises at the hovering points, the so-called pitch curve, which can appear as follows:

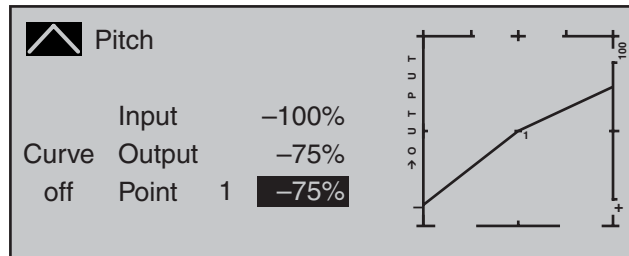

Now you can, if you like, move the marker frame upward with the selection keys to the "Curve" line and after activation of the value field with a brief tap on the center **SET** key of the right touch pad, set the curve function of the mixer to "on".

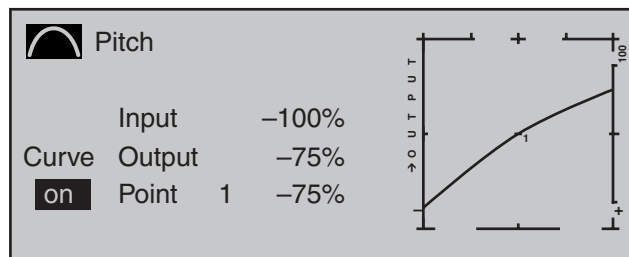

If you now switch to autorotation phase—at the bottom left of the display the flight phase name "Autorot" appears—the "old" pitch curve is again:

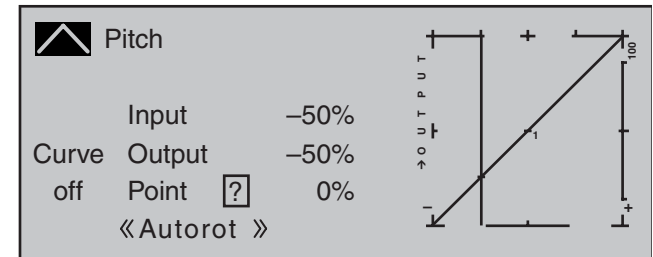

Now carry out the same setting as before in the normal phase. Only at point "H"—at maximum pitch—is it possible to increase pitch angle by about 2°. In doing so, you will have somewhat more of an angle to catch the model later on (1).

After setting pitch curve, move the autorotation switch back then return to the helicopter mixer menu selection with a brief tap on the center **ESC** key of the left touch pad. In that display, change to the "Channel 1 → Throttle" line to set the throttle curve.

The adjustment range for idle trim must first be matched to the throttle curve. Do this by putting the pitch joystick into its minimum position then set point "L" to about +15%.

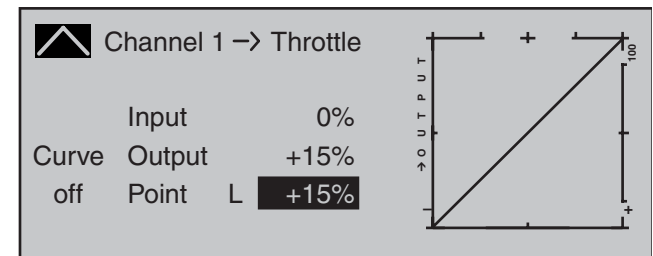

With the throttle limiter *closed* and idle trim completely open, move the pitch joystick back and forth somewhat at the minimum limit position. The throttle servo may not move with it in the process. No you have established a seamless transition from the idle trim to the throttle curve. The further settings along the throttle curve must be carried out later in flight.

If you switch from this graphic to the autorotation phase for testing purposes, the following appears instead of the accustomed representation:

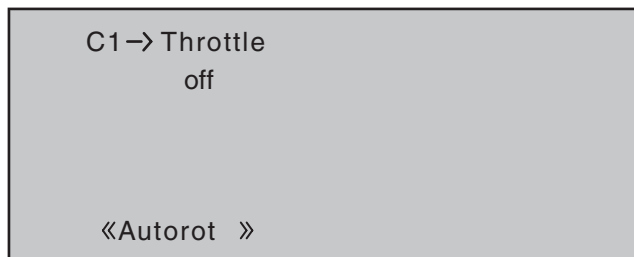

That means that this mixer is switched off and the throttle servo is switched to a fixed value, which can be adjusted as follows:

Return to the menu list with a tap on the **ESC** key. As long as you are still in the autorotation phase, new sub-menus are listed; specifically:

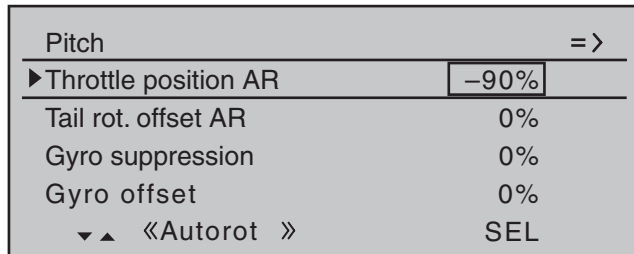

The line "Thr. setting AR" is important. Enter the value to the right, depending on servo direction, to either approximately +125% or -125%.

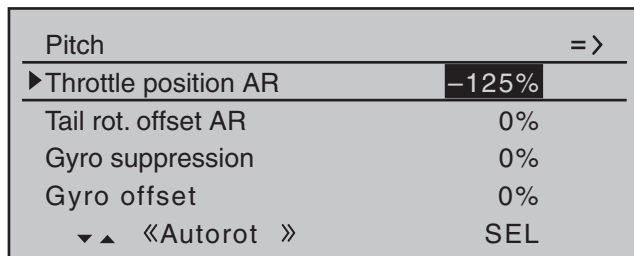

In doing so, the motor is safely switched off in the autorotation phase (in case of emergency). Later, when you have gained enough experience to practice the autorotation flight, a more stable idle can be entered here.

Adjustment notice for electric helicopters:
Since the motor must also be shut off for electrically powered helicopters in case of an emergency, this setting is adopted without change.

The further sub-menus are not important at the moment. By switching off "autorotation", it returns to the first menu list.

Select the "**Channel 1 → Tail rot.**" settings page in order to set static torque compensation for the tail rotor. In this case, also work with a maximum of three interpolation points; everything else is reserved for the experienced pilot. Do this by changing the heading-lock systems from their intended uniform pre-setting of 0% at point "L" (minimum pitch) to -30% and at the opposite end, at point "H" to +30% (maximum pitch). These values may have to be corrected in flight. It may also be necessary to set point "1" in the middle.

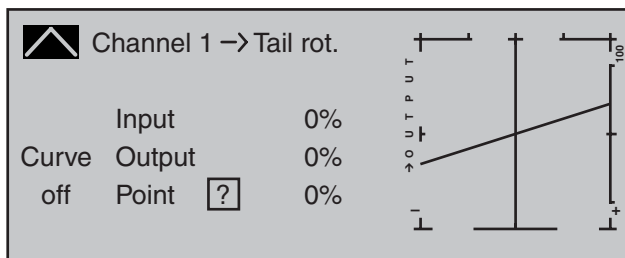

Now, for testing purposes, switch back to the autorotation phase. Here the setting is also deactivated; the tail servo no longer reacts to pitch movements (no torque usually arises when the main rotor is not powered). All additional interpolation points are not currently of importance yet.

If, contrary to the default setting, the gyro has a transmitter-side sensitivity setting, another free proportional control will be needed. This can be assigned in the ...

»Control adjust« (page 112 ... 119)

... menu to "Gyr7" input. Activate the control assignment with a brief tap on the center **SET** key of the right touch pad then move the selected control until its control number appears in the display:

| | | | | | | | |
|---|----|-----|-----|----|-------|-------|--------|
| I5 | GL | fr | --- | 0% | +111% | +88% | 0.00.0 |
| Thr6 | GL | fr | --- | 0% | +100% | +100% | 0.00.0 |
| ▶ Gyr7 | GL | SI1 | --- | 0% | +100% | +100% | 0.00.0 |
| I8 | GL | fr | --- | 0% | +100% | +100% | 0.00.0 |
| «Normal » | | | | | | | |
| ▼ ▲ Typ SET /- offset - travel + -time+ | | | | | | | |

Conclude this entry with a brief tap on the **ESC** key of the left touch pad then change to the column "- travel +" with the ▶ selection key of the left or right touch pad. After a tap on the center **SET** key of the right touch pad, the gyro's maximum sensitivity can be set in the value field displayed in inverse video, e.g. to 50%. To this end, move the selected control into its middle position or, if applicable also to the side, such that only one value field is displayed in inverse video:

| | | | | | | | |
|---|----|-----|-----|----|-------|-------|--------|
| I5 | GL | fr | --- | 0% | +111% | +88% | 0.00.0 |
| Thr6 | GL | fr | --- | 0% | +100% | +100% | 0.00.0 |
| ▶ Gyr7 | GL | SI1 | --- | 0% | +50% | +50% | 0.00.0 |
| I8 | GL | fr | --- | 0% | +100% | +100% | 0.00.0 |
| ▼ ▲ Typ SET /- offset - travel + -time+ | | | | | | | |

This produces a fixed value for as long as the control remains at the right limit position. The correct value must be adjusted in flight.

In the process, however, always observe the adjustment instructions accompanying your gyro sensor, because your helicopter will not be able to fly otherwise!

To conclude this initial programming, a few words should be mentioned about the menu ...

»Channel 1 curve« (page 131)

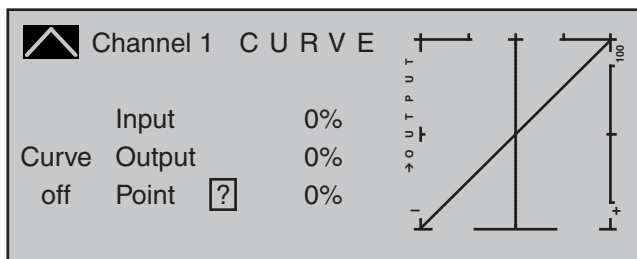

This function is a type of "convenient exponential curve" for the throttle/pitch joystick and the mixer functions connected to it.

If ever, this curve should only be applied "cautiously" at the very end, when all adjustments have been made. It should never be used for the throttle/pitch adjustment! The over-lapping result in "nasty" effects.

With this, all helicopter-specific settings which can be made on the "workbench" are now completed. The further fine-tuning must take place in flight. The flight-tested, (hopefully) minor (digital) trim settings are automatically saved.

Larger deviations should first be mechanically adjusted or adjusted according to the previously discussed settings.

Further settings

Following this programming example, you have provided a helicopter with a basic adjustment for the hovering training and simple trips. Depending on your knowledge and experience as a pilot, additional functions can, of course, also be activated.

If you want to fly at different speeds and with different trimming, you activate the so-called "flight phases", which can be called with assigned switches as an alternative to the previously described "normal phase". For this purpose, first open the menu ...

»Phase settings« (page 146)

... whereby the symbols appearing in the second column, sometimes only after a switch assignment in the »Phase assignment« menu, have the following meanings:

"-": no phase switch present

"+": phase switch present

"*": currently active phase

| ▶ Autorot | Autorot | | 0.1s -> | * |
|-----------|---------|------------|---------|---|
| Phase 1 | | | 0.1s | - |
| Phase 2 | | | 0.1s | - |
| Phase 3 | | | 0.1s | - |
| Phase 4 | | | 0.1s | - |
| ▼ ▲ | Name | Fl.ph.Tim. | Sw.time | |

However, consider in advance whether these are to be implemented with individual switches or, more reasonably, with 3-way switches because as many as 7 flight phases can be activated in addition to the autorotation phase. The latter possibility is more logical and usually more clearly laid out.

The "Autorot" line is already selected in the figure above. When activated, the autorotation phase always has precedence over any other phases you assign switches to.

However, in the "Name" column you first assign "meaningful" names to Phases 1 to 3, which are adopted from a list. These identifications serve for the better differentiation and are shown later in the base screen and for all flight-phase dependent menus, for example:

| ▼ ▲ | Name | Fl.ph.Tim | Sw. time | |
|-----------|---------|-----------|----------|---|
| Autorot | Autorot | | 0.1s -> | * |
| Phase 1 | Normal | | 0.1s | - |
| Phase 2 | Hover | | 0.1s | - |
| ▶ Phase 3 | Speed | | 0.1s | - |
| Phase 4 | | | 0.1s | - |

Then, in the fourth column from the left, enter the switching time with which the FROM phase should switch TO the next respective phase. Approximately 1 s should suffice:

| ▼ ▲ | Name | Fl.ph.Tim | Sw. time | |
|-----------|---------|-----------|----------|---|
| Autorot | Autorot | | 1.1s -> | * |
| Phase 1 | Normal | | 1.1s | - |
| Phase 2 | Hover | | 1.1s | - |
| ▶ Phase 3 | Speed | | 1.1s | - |
| Phase 4 | | | 0.1s | - |

This value can also be adjusted later according to your personal preferences. Please observe in the process that TO the autorotation phase, whose name is defined as "Autorot", is switched without a time delay. If necessary, enter the time with which a change FROM the autorotation phase to a different phase should be affected.

In order to be able to switch between the individual flight phases, the assignment of the individual switches or the three-stage switch is necessary. The assignment of the switch takes place in the menu ...

»Phase assignment« (page 148)

Under "C" and "D", for example, assign the one of the two standard 3-way switches mounted into the switch panels, e.g.:



Now the given switch position must be assigned to the respective flight phase in the »Phase settings« menu. Since these phases already have names, the name «1 Normal» will initially appear at the right in the display. If the already assigned autorotation switch was activated, the following warning message appears in the display:

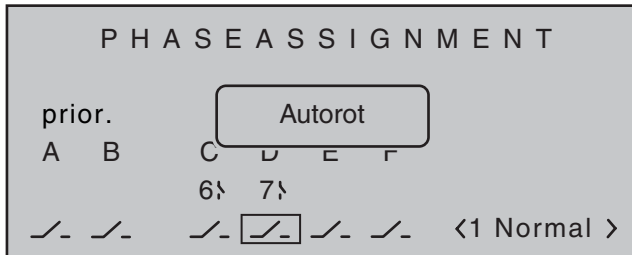

As a reminder:

The autorotation phase has absolute precedence.

Therefore, move the autorotation switch back again then put the selected switch, in the example the three-stage switch connected to switch plug-in locations 6 and 7, initially to one of its limit positions. Now use the selection keys to change to the bottom right and activate this entry field:



Now use the selection keys to select the desired flight phase for this—for example "2 Hover" ...



... and confirm this selection with a brief tap on the center **SET** key of the right touch pad or go ahead and put the switch into its other limit position and define the name for this new switch position, such as «3 Speed».



The switch's middle position then receives the name "1 Normal":



Note:

Exchanged or different name assignments for the three switch positions are, of course, also possible. Thus, for example, implementation of a programmed speed controller (as described beginning in the next column) can make a sequence like "normal / hover / acro" quite logical.

The model settings made before the assignment of a phase switch are now in the flight phase "Normal". This is the phase which is called after the above definition in the switch center position. This normal setting, which was already tested in flight, can be copied to a different flight phase so that flying can take place in the same manner in every phase at first. For this purpose, use the menu ...

»Copy / Erase«

(page 72)

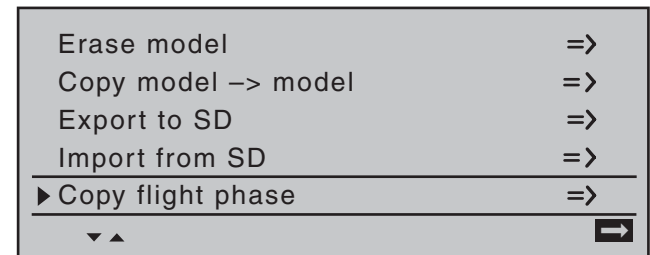

With the operation of the flight phases, it is possible to carry out changes in the phase-dependent menu for each individual phase. Since the **MC-20** HoTT system has digital trimming, in addition to the flight-phase dependent menu settings in the helicopter

program, the trim positions of roll, nick and tail rotor joystick can also be selected for storage on a flight-phase dependent basis, see »Stick mode« menu, page 106:

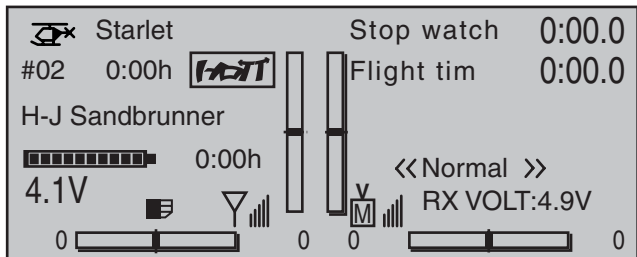

Enhancement recommendation: Rotational speed regulator

At some point in time you may want to install a rotational speed regulator in the helicopter, such as mc-Heli-Control, in order to be able to fly with speeds automatically kept at a constant. In the process, it is logical to couple the individual rotational speeds with the flight phases so that further additional adjustments are possible.

It is mandatory for the transmitter-side programming that the rotational speed regulator was installed and programmed according to the manufacturer's instructions. Of course, the **MC-20** HoTT here too offers multiple possibilities to realize various speeds in individual phases. A practical proposal which retains the throttle limiter function can be found beginning on page 181.

If you have adjusted your helicopter according to this programming principle, it is not yet a competition helicopter, but it already permits sophisticated flying. You should only activate additional functions if the model flies faultlessly so that the (desired) improvements are also easy to follow. Insofar as possible, activate individual functions on an individual basis so that you can actually recognize and attribute

the change. Bear in mind that it is not the quantity of functions used that distinguishes good pilots, but what they can do in terms of flying with relatively little.

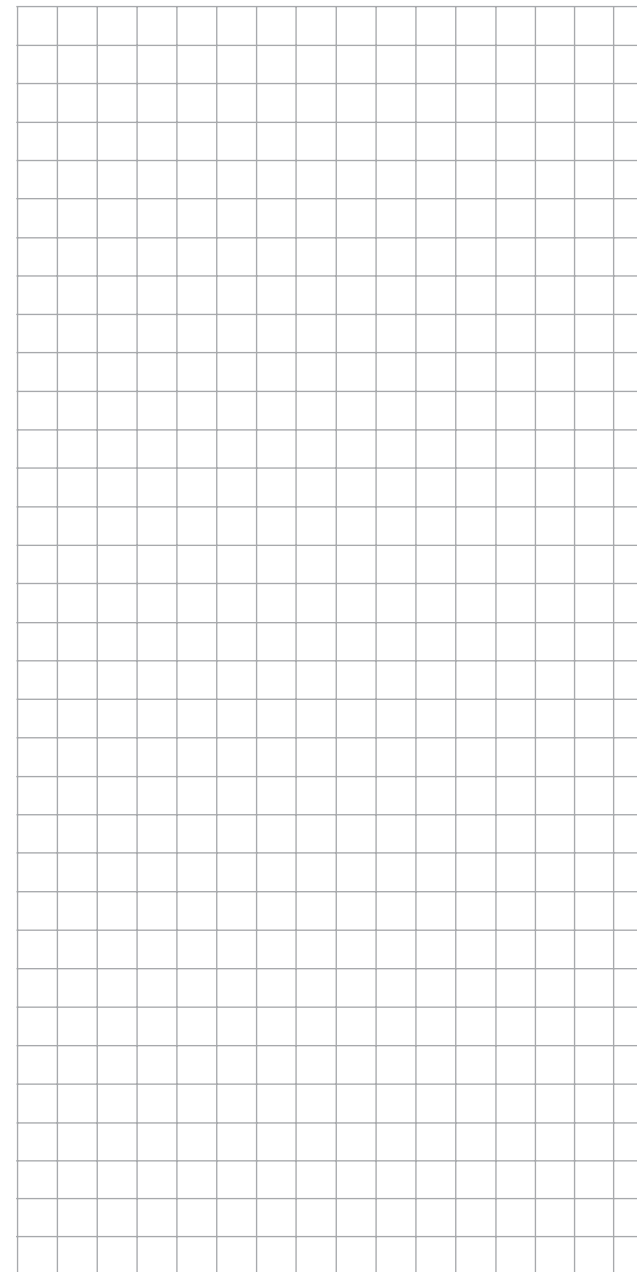

FCC Information

Graupner mc-20 HoTT #33020

FCC ID: ZKZ-MC-20

FCC Statement

1. This device complies with Part 15C of the FCC Rules. Operation is subject to the following two conditions:
 - (1) This device may not cause harmful interference.
 - (2) This device must accept any interference received, including interference that may cause an undesired operation.
2. Changes or modifications not expressly approved by the party responsible for compliance could void the user's authority to operate the equipment.

NOTE

This equipment has been tested and found to comply with the limits for a Class B digital device, pursuant to Part 15 of the FCC Rules. These limits are designed to provide reasonable protection against harmful interference in a residential installation. This equipment generates uses and can radiate radio frequency energy and, if not installed and used in accordance with the instructions, may cause harmful interference to radio communications. However, there is no guarantee that interference will not occur in a particular installation. If this equipment does cause harmful interference to radio or television reception, which can be determined by turning the equipment off and on, the user is encouraged to try to correct the interference by one or more of the following measures:

- Reorient or relocate the receiving antenna.
- Increase the separation between the equipment and receiver.
- Connect the equipment into an outlet on a circuit different from that to which the receiver is connected.

- Consult the dealer or an experienced radio/TV technician for help.

FCC Radiation Exposure Statement

This equipment complies with FCC radiation exposure limits set forth for an uncontrolled environment. This equipment should be installed and operated with a minimum distance of 20 cm between the antenna and your body.

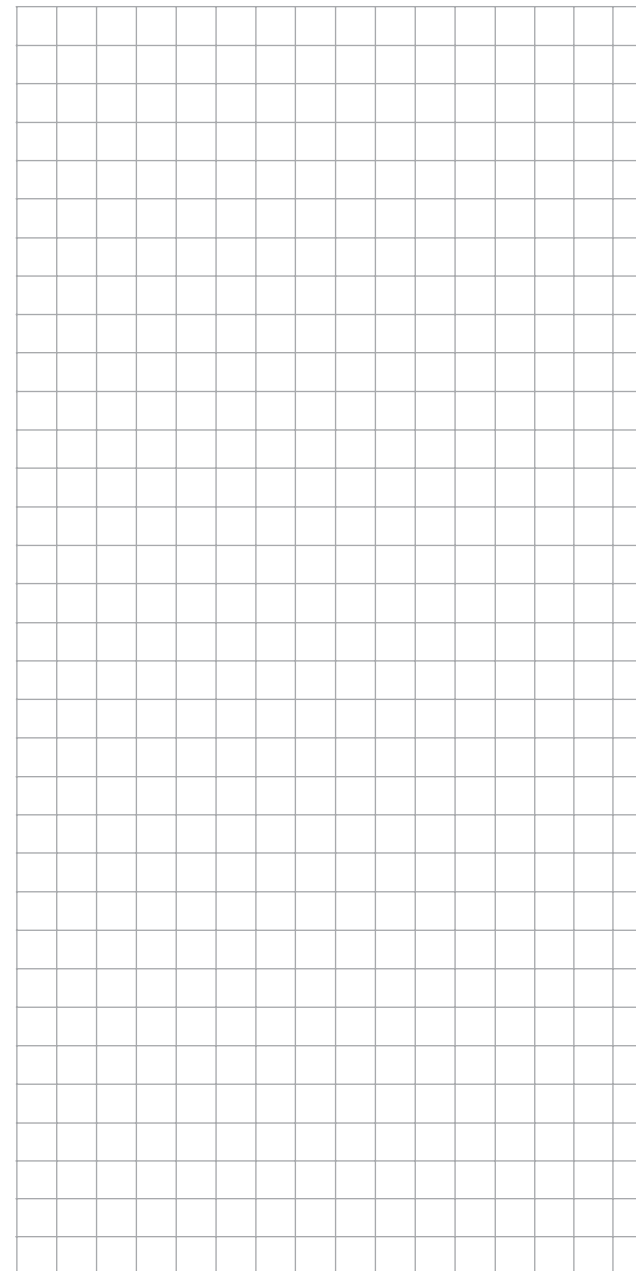

Declaration of Conformity

**Konformitätserklärung gemäß dem Gesetz über Funkanlagen und
Telekommunikationseinrichtungen (FTEG) und der Richtlinie 1999/5/EG (R&TTE)**
Declaration of Conformity in accordance with the Radio and Telecommunications Terminal Equipment
Act (FTEG) and Directive 1999/5/EG (R&TTE)

Graupner GmbH & Co. KG
Henriettenstraße 94-96
D-73230 Kirchheim/Teck

erklärt, dass das Produkt: **mc-20 HoTT - No. 33020**
declares that the product **GR-32 Dual HoTT - No. 33516**

Geräteklasse: **2**
Equipment class

den grundlegenden Anforderungen des § 3 und den übrigen einschlägigen Bestimmungen des
FTEG (Artikel 3 der R&TTE) entspricht.
complies with the essential requirements of § 3 and the other relevant provisions of the FTEG (Article 3 of the
R&TTE Directive).

Angewendete harmonisierte Normen:
Harmonised standards applied

EN 60950:2006 Gesundheit und Sicherheit gemäß § 3 (1) 1. (Artikel 3 (1)a))
Health and safety requirements pursuant to § 3 (1) 1. (Article 3 (1) a))

EN 301 489-1 V1.7.1 Schutzanforderungen in Bezug auf elektromagnetische
EN 301 489-3 V1.4.1 Verträglichkeit § 3 (1) 2, Artikel 3 (1) b))
Protection requirement concerning electromagnetic compatibility
§ 3 (1) 2, Artikel 3 (1) b))

EN 300 328 V1.7.1 Maßnahmen zur effizienten Nutzung des Frequenzspektrums
§ 3 (2) (Artikel 3 (2))
Measures for the efficient use of the radio frequency spectrum
§ 3 (2) (Article 3 (2))



Kirchheim, 14. November 2011

Stefan Graupner, Geschäftsführer
Stefan Graupner, Managing Director

Graupner GmbH & Co. KG Henriettenstraße 94-96 D-73230 Kirchheim/Teck Germany
Tel: 07021/722-0 Fax: 07021/722-188 EMail: info@graupner.de

Servicestellen / Service / Service après-vente**Graupner Zentralservice**

Graupner GmbH & Co. KG
 Henriettenstrasse 94 - 96
 D-73230 Kirchheim

Service hotline

(+49) 0 18 05 47 28 76*
 Monday ... Friday
 9:30 - 11:30 & 13:00 - 15:00

Belgie/Belgique/Nederland

Jan van Mouwerik
 Slot de Houvelaan 30
 NL 3155 Maasland VT
 (+31) 10 59 13 59 4

Luxembourg

Kit Flammang
 129, route d'Arlon
 L 8009 Strassen
 (+35) 23 12 23 2

**Ceská Republika
Slovenská Republika**

RC Service Z. Hnizdil
 Letecka 666/22
 CZ 16100 Praha 6 - Ruzyne
 (+42) 2 33 31 30 95

Schweiz

Graupner Service
 Wehntalerstrasse 37
 CH 8181 Hoeri
 (+41) 43 26 66 58 3

Espana

Anguera Hobbies
 C/Terrassa 14
 E 43206 Reus (Tarragona)
 (+34) 97 77 55 32 0
 info@anguera-hobbies.com

Sverige

Baltechno Electronics
 Box 5307
 S 40227 Göteborg
 (+46) 31 70 73 00 0

France

Graupner France
 Gérard Altmayer
 86, rue St. Antoine
 F 57601 Forbach-Oeting
 (+33) 3 87 85 62 12

United Kingdom

Graupner Service
 Brunel Drive
 GB, NEWARK, Nottinghamshire
 NG242EG
 (+44) 16 36 61 05 39

Italia

GiMax
 Via Manzoni, no. 8
 I 25064 Gussago
 (+39) 030 25 22 73 2

* 0.14 cent / minute from a
 German Telecom landline.
 Calling price variations
 possible for calls from cell
 phones or from the land-
 lines of other providers.

Graupner GmbH & Co. KG, Henriettenstrasse 94 - 96, D-73230 Kirchheim/Teck guarantees this product for a period of 24 months from date of purchase. The warranty is only valid for the material or functional defects already present at the time of the purchase of the product. Schäden, die auf Abnutzung, Überlastung, falsches Zubehör oder unsachgemäße Behandlung zurückzuführen sind, sind von der Garantie ausgeschlossen. Die gesetzlichen Rechte und Gewährleistungsansprüche des Verbrauchers werden durch diese Garantie nicht berührt. Bitte überprüfen Sie vor einer Reklamation oder Rücksendung das Produkt genau auf Mängel, da wir Ihnen bei Mängelfreiheit die entstandenen Unkosten in Rechnung stellen müssen.

Graupner GmbH & Co. KG, Henriettenstrasse 94 - 96, D-73230 Kirchheim/Teck, Germany guarantees this product for a period of 24 months from date of purchase. The guarantee applies only to such material or operational defects which are present at the time of purchase of the product. Damage due to wear, overloading, incompetent handling or the use of incorrect accessories is not covered by the guarantee. The user's legal rights and claims under guarantee are not affected by this guarantee. Please check the product carefully for defects before you are make a claim or send the item to us, since we are obliged to make a charge for our cost if the product is found to be free of faults.

La société Graupner GmbH & Co. KG, Henriettenstraße 94-96, D-73230 Kirchheim/Teck, accorde sur ce produit une garantie de 24 mois à compter de la date d'achat. La garantie ne s'applique qu'aux défauts de matériel et de fonctionnement du produit acheté. Les dommages dus à une usure, à une surcharge, à l'emploi d'accessoires non compatibles ou à une manipulation non conforme sont exclus de la garantie. Cette garantie ne remet pas en cause les droits légaux des consommateurs. Avant toute réclamation ou retour de matériel, vérifiez précisément les défauts ou vices constatés, car si le matériel est conforme et qu'aucun défaut n'a été constaté par nos services, nous nous verrions contraints de facturer le coût de cette intervention.

Garantie-Urkunde

Warranty certificate / Certificat de garantie

MC-20 HoTT Set

Order no. **33020**

Übergabedatum:

Date of purchase/delivery:

Date d'achat :

Name des Käufers:

Owner's name:

Nom de l'acheteur :

Straße, Wohnort:

Complete address:

Adresse complète :

Firmenstempel und Unterschrift des Einzelhändlers:

Stamp and signature of dealer:

Cachet et signature du détaillant :

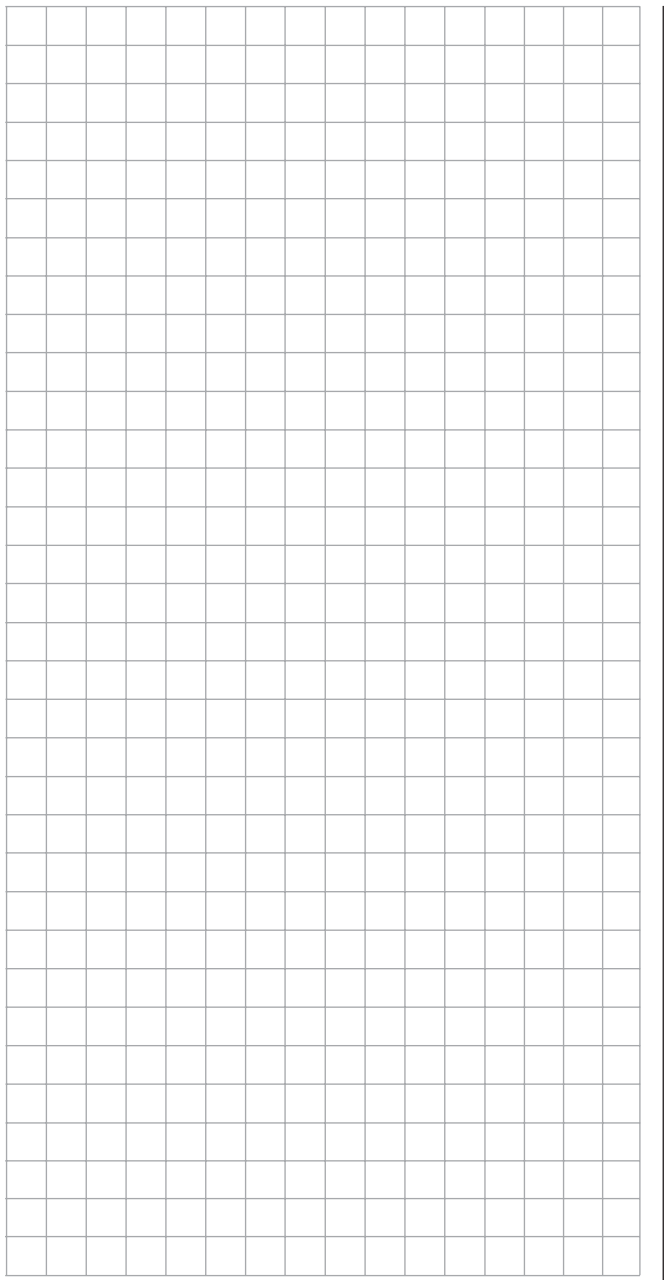
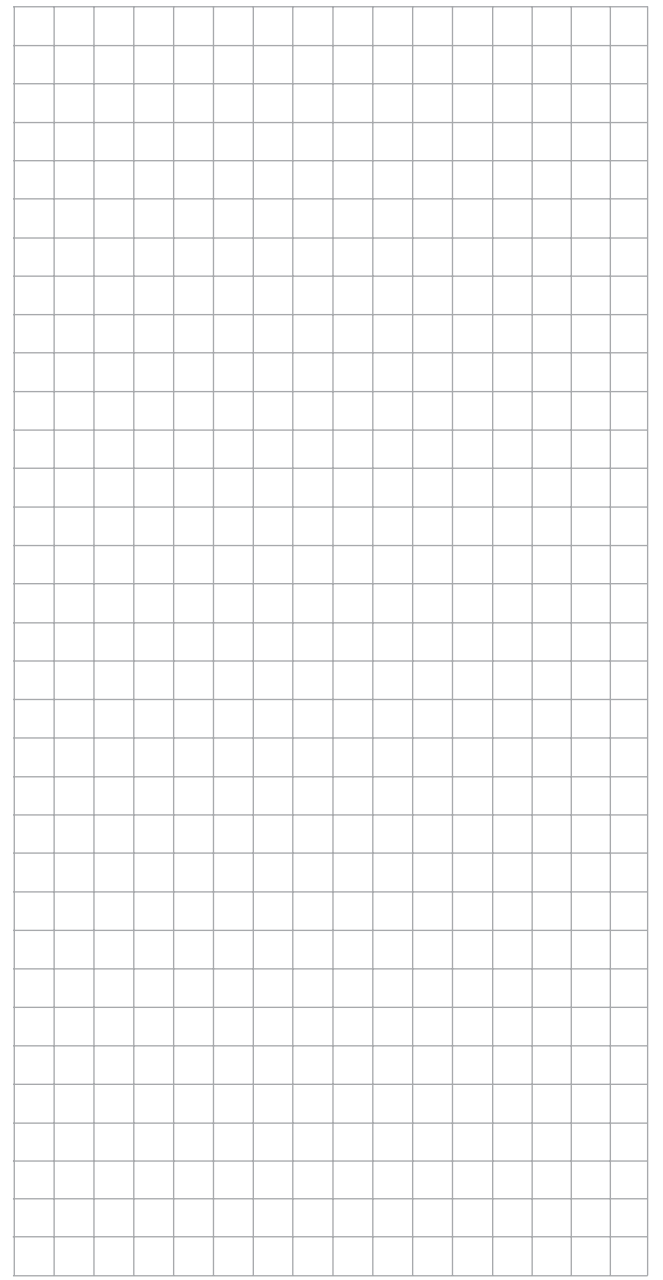
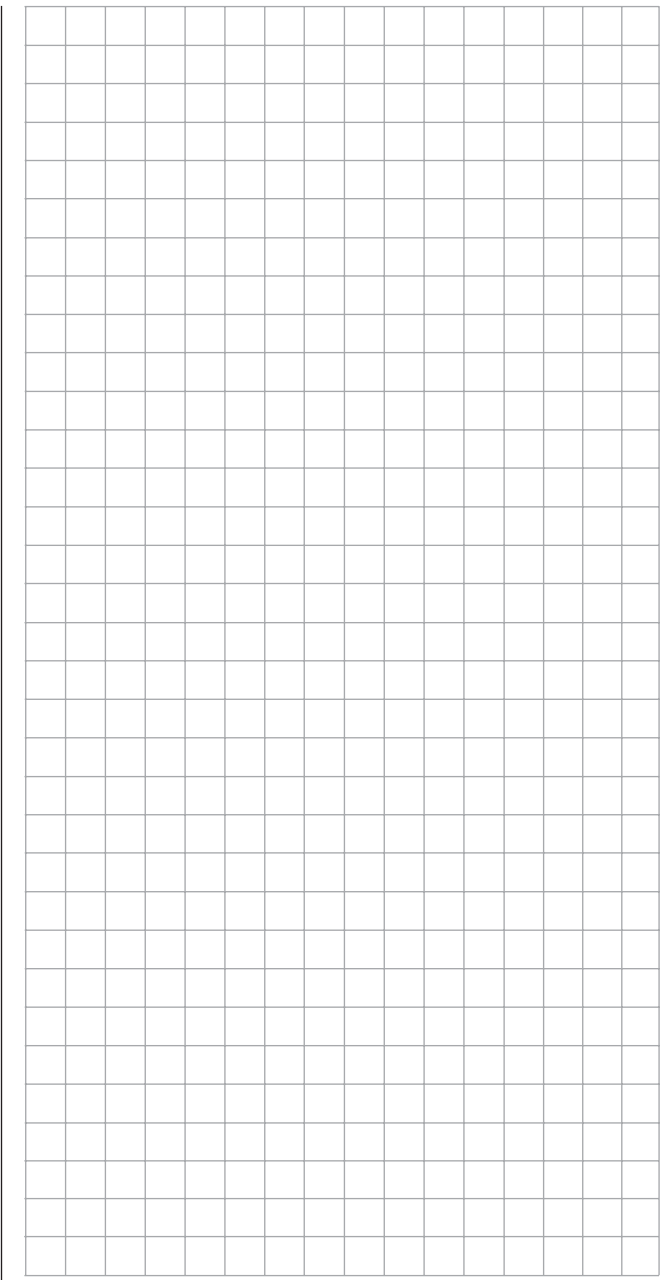

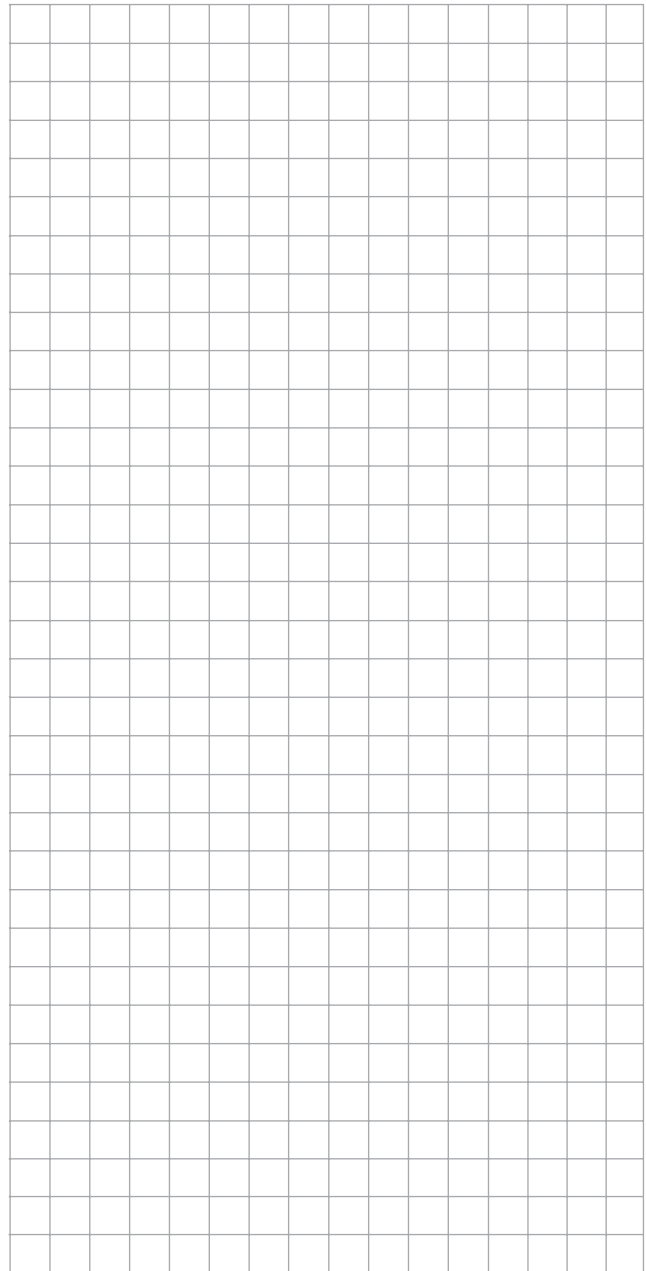
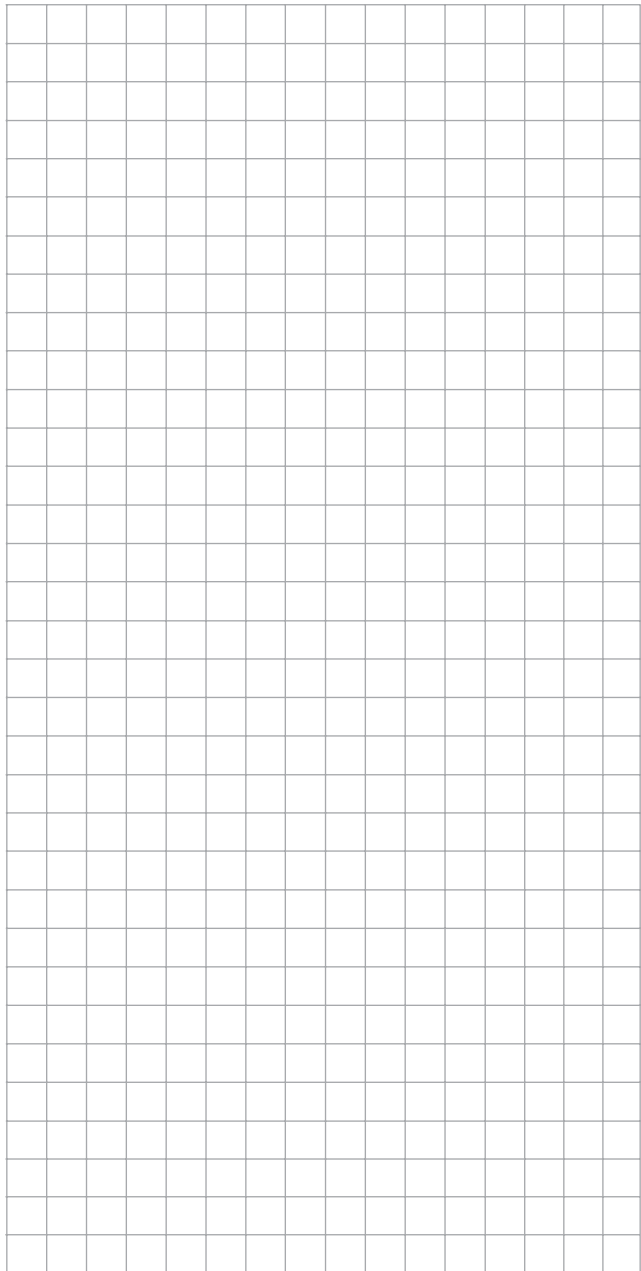
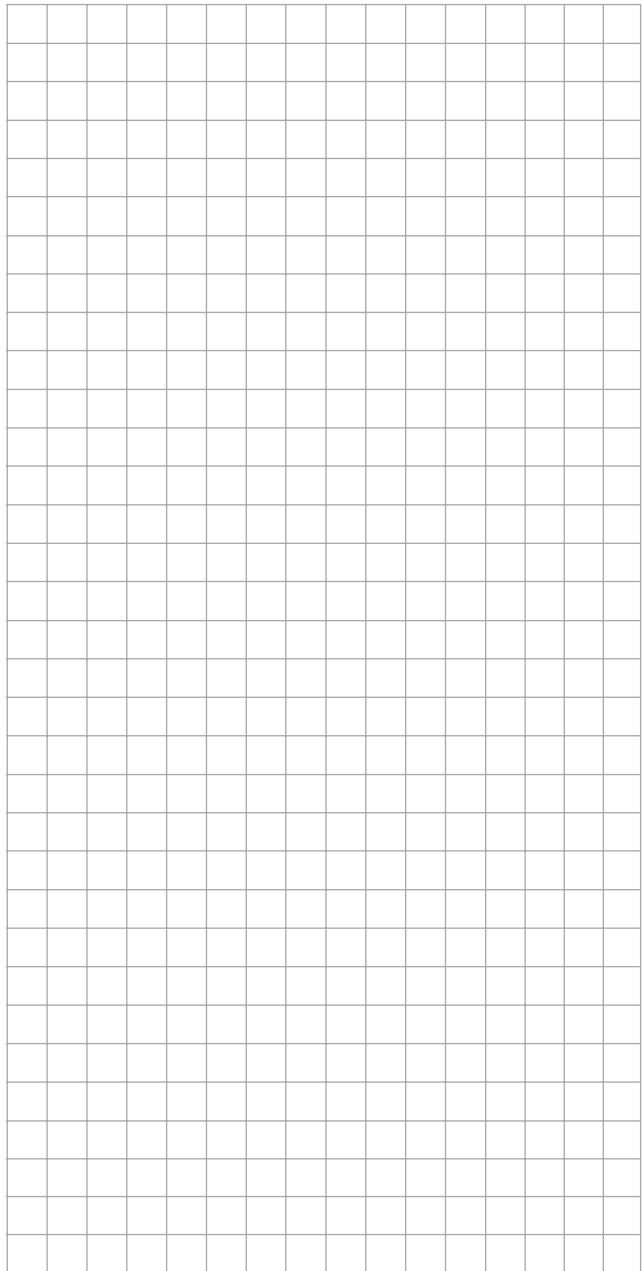

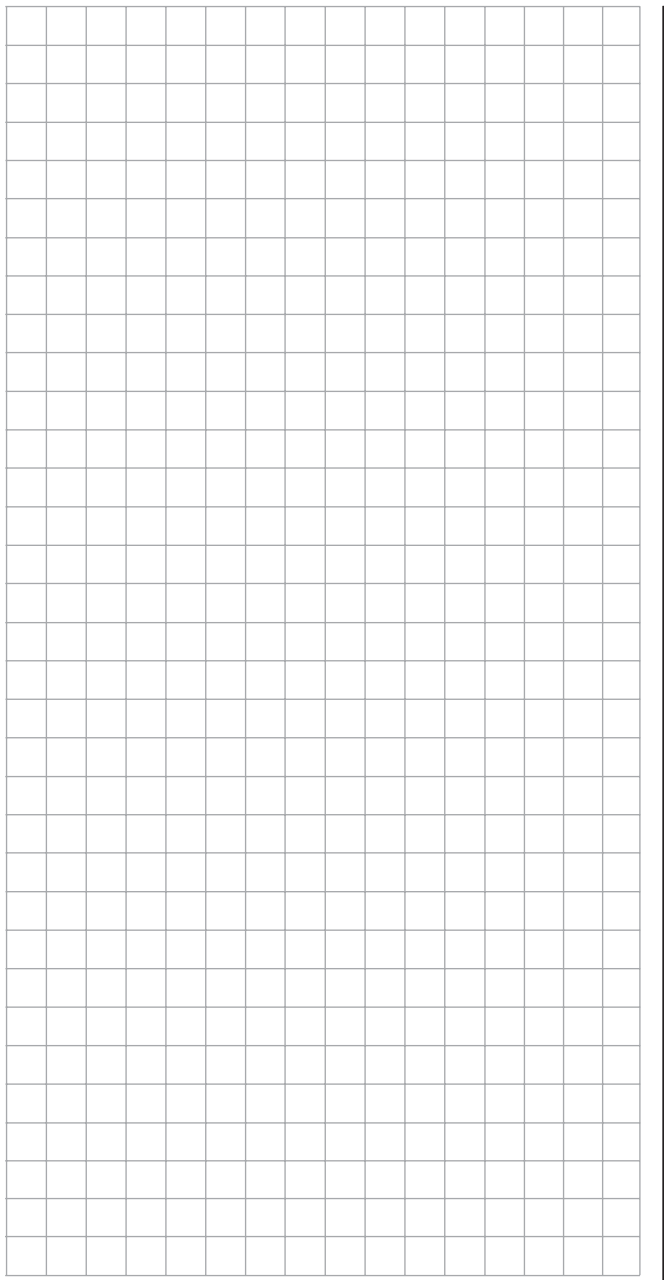
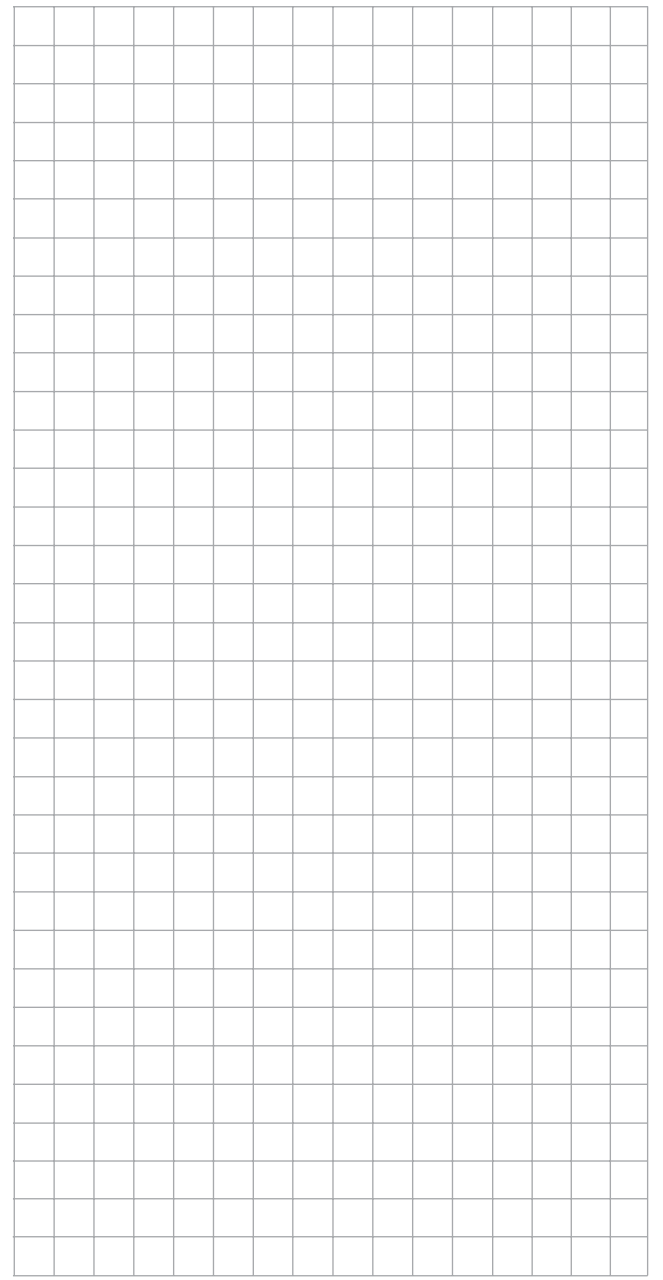
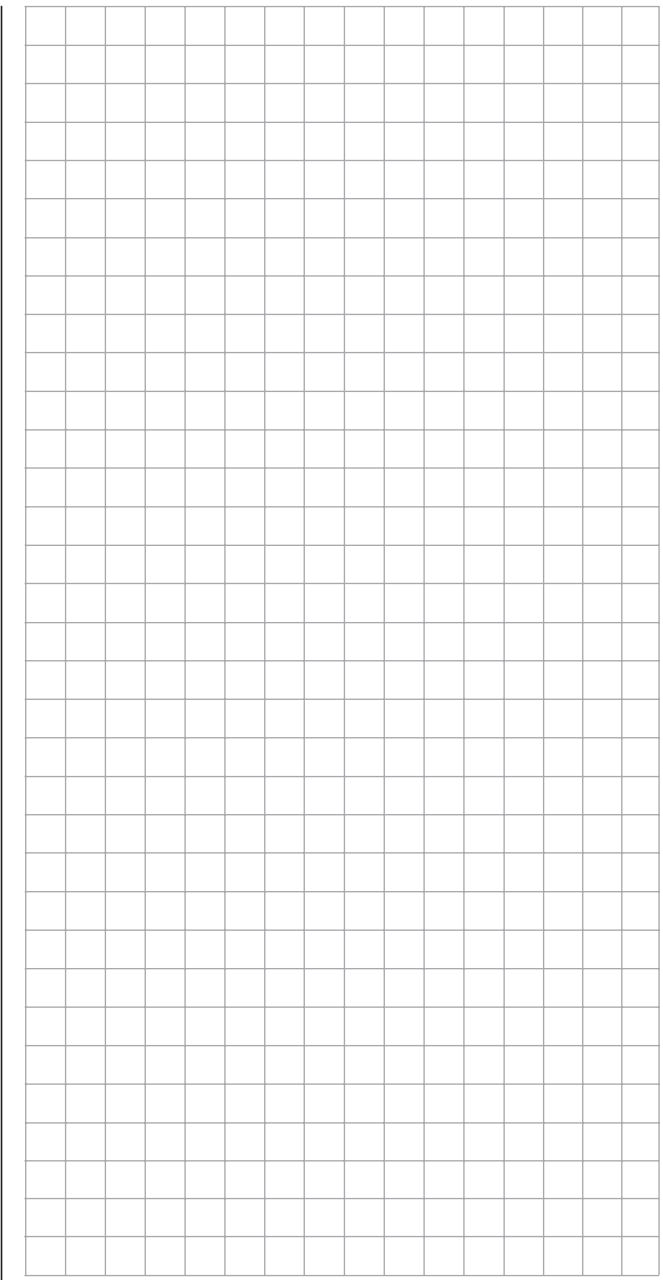

Graupner SJ **HOIT**

HOPPING . TELEMETRY . TRANSMISSION

GRAUPNER GMBH & CO. KG
POSTFACH 1242
D-73220 KIRCHHEIM/TECK
GERMANY

<http://www.graupner.de>

Changes and delivery options reserved. Available only through dealerships. A directory of suppliers will be provided. No liability is accepted for print errors.

Printed in Germany PN.QC-01

Although the information provided in these instructions has been carefully scrutinized for viability, no form of liability can be accepted for errors, omissions or print errors. *Graupner* reserves the right to change the described hardware and software features at any time without prior notification.